



Dolphin[®] 7600 Mobile Computer

with Windows Mobile[®] 6.0

User's Guide—Preliminary

Disclaimer

Honeywell International Inc. ("Honeywell") reserves the right to make changes in specifications and other information contained in this document without prior notice, and the reader should in all cases consult Honeywell to determine whether any such changes have been made. The information in this publication does not represent a commitment on the part of Honeywell.

Honeywell shall not be liable for technical or editorial errors or omissions contained herein; nor for incidental or consequential damages resulting from the furnishing, performance, or use of this material.

This document contains proprietary information that is protected by copyright. All rights are reserved. No part of this document may be photocopied, reproduced, or translated into another language without the prior written consent of Honeywell.

©2008 Honeywell International Inc. All rights reserved.

Web Address: www.honeywell.com/aidc

Trademarks

Dolphin, Dolphin RF, HomeBase, Mobile Base, and QuadCharger are trademarks or registered trademarks of Hand Held Products, Inc. or Honeywell International Inc.

Microsoft, Windows, Windows Mobile, Windows CE, Windows NT, Windows 2000, Windows ME, Windows XP, ActiveSync, Outlook, and the Windows logo are trademarks or registered trademarks of Microsoft Corporation.

Other product names mentioned in this manual may be trademarks or registered trademarks of their respective companies and are the property of their respective owners.

Patents

Please refer to the product packaging for a list of patents.

Other Trademarks

The Bluetooth trademarks are owned by Bluetooth SIG, Inc., U.S.A. and licensed to Honeywell International Inc.

microSD and microSDHC are trademarks.



Table of Contents

Chapter 1 - Agency Approvals

Label Locations	1-1
Approvals by Country	1-2
R&TTE Compliance Statement—802.11b/g and/or Bluetooth	1-2
Dolphin RF Terminal—802.11b/g, Bluetooth,	1-3

Chapter 2 - Getting Started

Out of the Box	2-1
Today Screen	2-2
Navigation Bar and Start Menu	2-2
Icons in the Navigation Bar	2-3
Command Bar	2-4
Selecting Programs	2-5
Using the Stylus	2-5

Chapter 3 - Hardware Overview

Standard Configurations	3-1
Hardware Features	3-1
Peripherals	3-2
Accessories	3-2
Front Panel Features	3-3
Touch Screen Display	3-4
Display Backlight	3-4
Using Screen Protectors	3-4
Back Panel Features	3-10
Using the Accessory Attachment	3-11
Side Panel Features	3-12
Installing Memory Cards	3-13
Bottom Panel Features	3-15
Connecting the USB Cable	3-16
ActiveSync Communication	3-18
Battery Power	3-21
Checking Battery Power	3-24
Resetting the Terminal	3-25
Soft Reset (Warm Boot)	3-25
Hard Reset (Cold Boot)	3-25
Suspend Mode	3-26

Chapter 4 - Using the Keyboards

Overview	4-1
29-Key Numeric Keyboard	4-1
38-Key Alpha Keyboard	4-1
Suspend/Resume	4-1
Function Keys	4-2
Modifier Keys	4-2
Alpha/Numeric Indicator	4-3

29-Key Numeric Keyboard	4-4
Navigation Keys.....	4-4
Hardware Application Buttons	4-5
Toggling Between Alpha and Numeric Modes.....	4-6
29-Key Blue Key Combinations (Alpha Mode)	4-7
29-Key Shift Functionality in Numeric Mode.....	4-7
29-Key Red Key Combinations.....	4-8
38-Key Alpha Keyboard.....	4-10
Toggling Between Alpha and Numeric Modes.....	4-10
38-Key Red Key Combinations.....	4-11
38-Key NUM Lock Mode	4-12

Chapter 5 - Using the Image Engine

Overview.....	5-1
Available Engines	5-1
Supported Bar Code Symbologies	5-2
Activating the Engine.....	5-3
Decoding	5-3
Capturing Images	5-5

Chapter 6 - System Settings

Overview.....	6-1
Personal Tab	6-2
Buttons.....	6-3
Input.....	6-4
Menus	6-5
System Tab	6-7
About	6-7
Backlight	6-8
Certificates.....	6-8
ClearType Tuner.....	6-8
Clock & Alarms	6-9
Encryption.....	6-9
Error Reporting	6-9
External GPS	6-10
Memory.....	6-10
Power.....	6-12
Regional Settings.....	6-12
Remove Programs.....	6-13
Screen	6-14

Chapter 7 - Connecting the Terminal

Connections Tab	7-1
Infrared Communication	7-2
IrDA Port Location	7-2
Sending Data	7-2
Receiving Data	7-3

Connections Manager	7-4
Task Tab.....	7-4
Advanced Tab.....	7-5
Dolphin Wireless Manager	7-6
Dolphin Wireless Manager Window.....	7-6
Enabling the Radios.....	7-6
Accessing Radio Configuration Utilities.....	7-7
Icons in the Navigation Bar.....	7-7
COM Port Assignment Table	7-8
Network Cards.....	7-9
USB to PC	7-10
Installing Additional Software	7-11
Adding Programs via ActiveSync.....	7-11
Adding Programs From the Internet	7-12

Chapter 8 - Working with the Bluetooth Radio

Enabling the Bluetooth Radio	8-1
Icons in the Navigation Bar.....	8-1
Connecting to Other Bluetooth Devices	8-2
Pairing and Trusted Devices	8-4
Types of Devices and Services	8-5
Connecting to Bluetooth Printers.....	8-6
Connecting to Bluetooth Headsets	8-6
Transferring Files.....	8-7
Making the Terminal Discoverable	8-8

Chapter 9 - Dolphin HomeBase Device

Overview.....	9-1
Front Panel	9-2
Back Panel	9-3
Powering the HomeBase Device.....	9-4
Charging the Main Battery.....	9-5
Mounting the Dolphin HomeBase Device.....	9-6
Bottom Panel Dimensions	9-7

Chapter 10 - Dolphin QuadCharger Device

Overview.....	10-1
Front Panel	10-1
Back Panel	10-2
Supplying Power to the QuadCharger Device.....	10-2
Battery Charging.....	10-3
Recommendations for Storing Batteries.....	10-3
Mounting the QuadCharger Device	10-4
Troubleshooting.....	10-6

Chapter 11 - Dolphin Mobile Mount

Overview.....	11-1
Inserting a Terminal.....	11-1
Mounting.....	11-3

Chapter 12 - Technical Specifications

Terminal Technical Specifications 12-1
Dolphin HomeBase Device..... 12-3
Dolphin QuadCharger Device..... 12-5

Chapter 13 - Customer Support

Product Service and Repair..... 13-1
Technical Assistance 13-2
Limited Warranty 13-3

Agency Approvals

Label Locations

Dolphin 7600 terminals meet or exceed the requirements of all applicable standards organizations for safe operation. However, as with any electrical equipment, the best way to ensure safe operation is to operate them according to the agency guidelines that follow. Please read these guidelines carefully before using your Dolphin terminal.

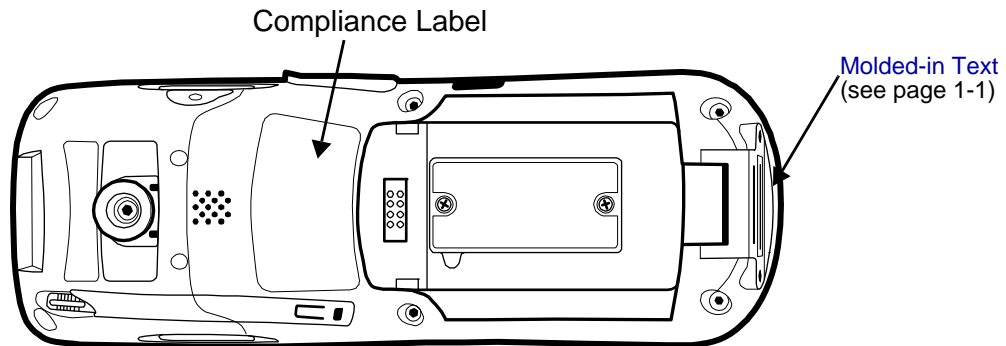

Molded-in Text



Laser Safety Label

If the following label is attached to your product, it indicates the product contains a laser engine or laser aimer:

Laser Eye Safety Statement: This device has been tested in accordance with and complies with IEC60825-1: 1993+A1+A2 and 21 CFR 1040.10 and 1040.11, except for deviations pursuant to Laser Notice No. 50, dated July 26, 2001. LASER LIGHT, DO NOT STARE INTO BEAM, CLASS 2 LASER PRODUCT, 1.0 mW MAX OUTPUT: 650nm.

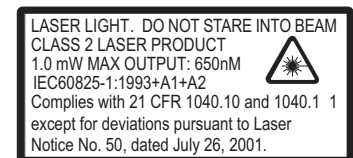

Caution - use of controls or adjustments or performance of procedures other than those specified herein may result in hazardous radiation exposure.

LED Safety Statement

The LED output on this device has been tested in accordance with IEC60825-1 LED safety and certified to be a Class 1 LED device.

FCC RF Radiation Exposure Statement

This equipment complies with FCC RF radiation exposure limits set forth for an uncontrolled environment.

Max. SAR Measurement (1g):

- 802.11b: 0.234w/kg
- 802.11g: 0.234w/kg



This device has been tested and meets the FCC RF exposure guidelines for body worn operation only. An accessory must be used for body worn operation.

Approvals by Country

Country	Safety	EMC & Radio
U.S.A.	UL60950-1 (CB Scheme)	FCC Part 15, Subpart C, 15.247 FCC Part 15, Subpart B FCC Part 22H FCC Part 24H FCC SAR OET 65 Supplement C
Canada	cUL60950	ICES-003 (Class B) RSS 132 RSS 133
European Community/CE	EN60950-1:2000 EN60825-1:1994 + A11 + A2 IEC60825-1	EN 300328-1/2 EN55022:1998+A1:2000+A2:2003 EN55024:1998+A1:2001+A2:2003 EN301 511 EN301 489-1/-7 EN301 489-17 EN61000-3-2:2000 EN61000-3-3:1995+A1-2001 EN60360 June 2001 EN50361 June 2001 EN50371 June 2001

R&TTE Compliance Statement—802.11b/g and/or Bluetooth

Dolphin RF terminals are in conformity with all essential requirements of the R&TTE Directive (1999/5/EC).

This product is marked with  [Certified Notified Body Number]  in accordance with the Class II product requirements specified in the R&TTE Directive. In addition, this product complies to 2006/95/EC Low Voltage Directive when supplied with the recommended power supply. Honeywell shall not be liable for use of our product with equipment (i.e., power supplies, personal computers, etc.) that is not CE marked and does not comply with the Low Voltage Directive.

The equipment is intended for use throughout the European Community; PAN European Frequency Range: 2.402–2.480 GHz. Restrictions for use in France are as follows:

- Indoor use: Maximum power (EIRP*) of 100 mW for the entire 2.400–2.4835 GHz
- Outdoor use: Maximum power (EIRP*) of 100 mW for the 2.400–2.454 GHz band & maximum power (EIRP*) of 10 mW for the 2.454–2.483 MGHz band.

For further information, please contact:

Hand Held Products BV, a wholly owned subsidiary of Honeywell International Inc.
Nijverheidsweg 9
5627 BT Eindhoven
The Netherlands

Dolphin RF Terminal—802.11b/g, Bluetooth,

This device complies with Part 15 of the FCC Rules. Operation is subject to the following two conditions: (1) this device may not cause harmful interference, and (2) this device must accept any interference received, including interference that may cause undesired operation.

This equipment has been tested and found to comply with the limits for a Class B digital device pursuant to Part 15 of the FCC Rules. These limits are designed to provide reasonable protection against harmful interference in a residential installation. This equipment generates, uses, and can radiate radio frequency energy and, if not installed and used in accordance with the instructions, may cause harmful interference to radio communications. However, there is no guarantee that interference will not occur in a particular installation. If this equipment does cause harmful interference to radio or television reception, which can be determined by turning the equipment off and on, the user is encouraged to try to correct the interference by one or more of the following measures:

- Reorient or relocate the receiving antenna.
- Increase the separation between the equipment and receiver.
- Connect the equipment into an outlet on a circuit different from that to which the receiver is connected.
- Consult the dealer or an experienced radio/TV technician for help.

If necessary, the user should consult the dealer or an experienced radio/television technician for additional suggestions. The user may find the following booklet helpful: "Something About Interference." This is available at FCC local regional offices. Our company is not responsible for any radio or television interference caused by unauthorized modifications of this equipment or the substitution or attachment of connecting cables and equipment other than those specified by our company. The correction is the responsibility of the user. Use only shielded data cables with this system.

In accordance with FCC 15.21, changes or modifications not expressly approved by the party responsible for compliance could void the user's authority to operate the equipment.

CAUTION! Any changes or modifications not expressly approved by the grantee of this device could void the user's authority to operate the equipment.

Canadian Compliance

This Class B digital apparatus complies with Canadian ICES-003. Operation is subject to the following two conditions: (1) this device may not cause harmful interference, and (2) this device must accept any interference received, including interference that may cause undesired operation.

To prevent radio interference to the licensed service, this device is intended to be operated indoors and away from windows to provide maximum shielding. Equipment (or its transmit antenna) installed outdoors is subject to licensing.

Cet appareil numérique de la Classe B est conforme à la norme NMB-003 du Canada.

For European Community Users

Honeywell complies with Directive 2002/96/EC OF THE EUROPEAN PARLIAMENT AND OF THE COUNCIL of 27 January 2003 on waste electrical and electronic equipment (WEEE).

Waste Electrical and Electronic Equipment Information

This product has required the extraction and use of natural resources for its production. It may contain hazardous substances that could impact health and the environment, if not properly disposed.

In order to avoid the dissemination of those substances in our environment and to diminish the pressure on the natural resources, we encourage you to use the appropriate take-back systems for product disposal. Those systems will reuse or recycle most of the materials of the product you are disposing in a sound way.



The crossed out wheeled bin symbol informs you that the product should not be disposed of along with municipal waste and invites you to use the appropriate separate take-back systems for product disposal.

If you need more information on the collection, reuse, and recycling systems, please contact your local or regional waste administration.

You may also contact your supplier for more information on the environmental performances of this product.

Pacemakers, Hearing Aids and Other Electrically Powered Devices

Most manufacturers of medical devices adhere to the IEC 601-1-2 standard. This standard requires devices to operate properly in an EM Field with a strength of 3V/m over a frequency range of 26 to 1000MHz. The maximum allowable field strength emitted by the Dolphin is 0.3V/m according to Subpart B of Part 1 of the FCC rules. Therefore, the Dolphin RF has no effect on medical devices that meet the IEC specification.

Microwaves

The radio in the Dolphin RF terminal operates on the same frequency band as a microwave oven. Therefore, if you use a microwave within range of the Dolphin RF terminal you may notice performance degradation in your wireless network. However, both your microwave and your wireless network will continue to function. The Dolphin Batch terminal does not contain a radio, and therefore, is not affected by microwave ovens.

Getting Started

Out of the Box

Verify that your carton contains the following items:

- Dolphin 7600 mobile computer (the terminal)
- Main battery pack (3.7v, Li-ion)
- AC power supply
- Localized plug adapters
- User CD

Note: Be sure to keep the original packaging in case you need to return the Dolphin terminal for service; see [Product Service and Repair](#) on page 13-1.

Step 1. Install the Main Battery

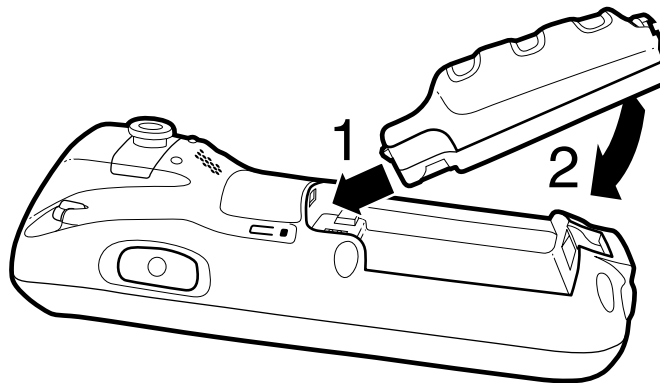

Use only the Li-ion battery packs provided by Honeywell. Use of any battery not sold/manufactured by Honeywell may result in damage not covered by the warranty.

Step 2. Charge the Batteries

Dolphin terminals ship with both the main battery pack and internal backup battery significantly discharged of power. Charge the main battery pack with the charging cable for **a minimum of four hours before initial use.**

1. Attach the appropriate plug adapter to the plug of the power cable.
2. Plug the *power cable into the **DC Power Jack** (see page 3-12) on the left side.
3. Insert the plug into the appropriate power source.

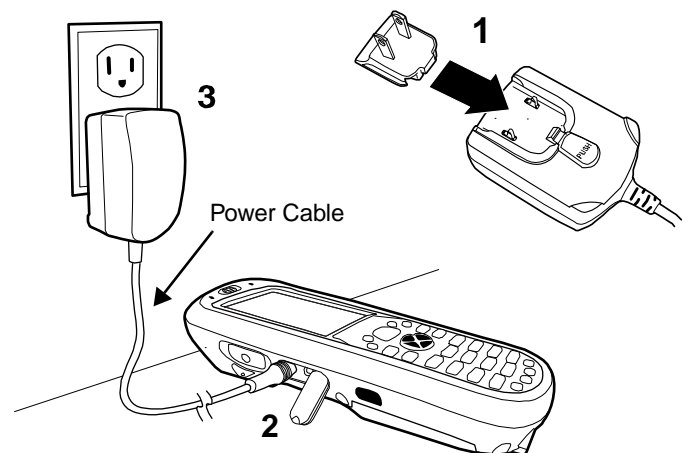

*This power cable can also be used to power the [Dolphin HomeBase Device](#) (see page 9-1).



Use only the peripherals, power cables, and power adapters from Honeywell. Use of peripherals, cables, or power adapters not sold/manufactured by Honeywell may cause damage not covered by the warranty.

Step 3. Boot the Terminal

The terminal begins booting as soon as power is applied and runs by itself. Do NOT press any keys or interrupt the boot process. Only tap the screen when prompted. When the boot process is complete, the [Today Screen](#) (see page 2-2) appears and the terminal is ready for use.

Today Screen

System resets (see [Resetting the Terminal](#) on page 3-25) complete on the Today screen.

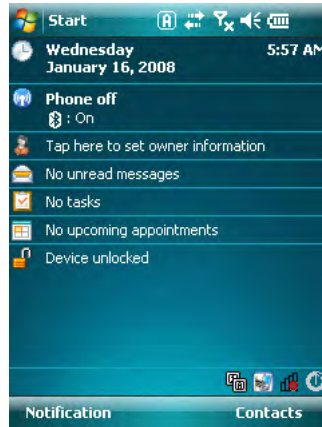

Note: You can access the Today screen any time by tapping the Start button on the Navigation bar and selecting Today in the drop-down list.





















Navigation Bar and Start Menu

Located at the top of every window, the Navigation bar displays various icons representing various system functions.













The icons in the table below may appear in the Navigation bar. Which icons appear depend on your terminal's configuration.

Icons in the Navigation Bar

Indicator	Meaning
	The terminal could not synchronize data with the workstation via ActiveSync
	New e-mail or text message (SMS)
	New voicemail
	New instant message
	Ringer off
	Voice call
	Voice call in progress
	Calls are forwarded
	Call on hold
	Missed call
	Data call in progress
	Battery levels (1–4). Tap this icon to open the Power system setting and see the charge percentage (see page 6-12).
	Critical battery. The charge percentage is at the critical battery point set in the registry (the default is 10%). For details about the critical battery point, (see page 3-22). Tap this icon to open the Power system setting and see the charge percentage (see page 6-12).
	Terminal is running on external power (If a battery pack is installed, that battery is charging.)
	The terminal is not connected to external power. A battery is installed but is defective; specifically, its charge level cannot be measured.
	No SIM card is installed
	GPRS available
	GPRS connected
	EDGE available
	EDGE connected

Icons in the Navigation Bar

Indicator	Meaning
	Roaming
	Radio is disabled
	The radio is not connected to a network
	Radio connected
	No radio signal
	The terminal is searching for a signal
	Radio signal strength
	Wi-Fi on
	Wi-Fi data call
	Pending alarm
	Bluetooth

Command Bar

Located at the bottom of the Today screen, the command bar displays running applications.



This area displays various icons that access applications running on the terminal. Use the right and left arrows to navigate through these icons.

Selecting Programs

Tapping Start opens the drop-down menu, which provides access to the most common system functions and programs. To open a program, tap **Start > Programs**. Then, tap the program icon on the menu.

Using the Stylus

The terminal comes with a stylus inserted into the [Stylus Slot](#) (see page 3-10). Use this stylus (or your finger) to select or enter information on the touch screen. The stylus functions as a mouse; generally, a tap is the same as a click.

- Tap** Tap the touch screen once to open menu items and select options.
- Drag** Hold the stylus on the screen and drag across the screen to select text and images.
- Tap & hold** Tap and hold the stylus on an item and a pop-up menu appears. On the pop-up menu, tap the action of the task you want to perform.

 Use of other objects other than the stylus, such as paper clips, pencils, or ink pens can damage the touch screen and may cause damage not covered by the warranty.

For more information about the touch screen, see [Touch Screen Display](#) on page 3-4.

Using File Explorer

Use File Explorer to navigate through the files on your terminal. Tap **Start > Programs > File Explorer**.



Move files by tapping and holding on the file, then tapping **Cut**, **Copy** or **Paste** on the pop-up menus that appear.

Pop-Up Menus

With pop-up menus, you can quickly choose an action for an item.

1. Tap and hold the stylus on the item name. The pop-up menu appears.
2. Lift the stylus, and tap the action you want to perform.

Note: The contents of pop-up menus change according to the program you're in.

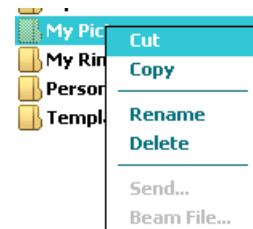



Standard Configurations

WPAN / WLAN	WPAN
<ul style="list-style-type: none"> • Windows Mobile 6.0 Classic • Samsung 2440 400 MHz • 128MB RAM X 128 MB (non-volatile) Memory • 29-key numeric keyboard or 38-key alpha keyboard • 2.8" 1/4 VGA TFT color display • Li-ion battery: 3.7V / 3240 mAh / 12.0 Wh • 5300SR image engine • Bluetooth and 802.11b/g radios • Power cable (included in each box) 	<ul style="list-style-type: none"> • Windows Mobile 6.0 Classic • Samsung 2440 400 MHz • 128MB RAM X 128 MB (non-volatile) Memory • 29-key numeric keyboard or 38-key alpha keyboard • 2.8" 1/4 VGA TFT color display • Li-ion battery: 3.7V / 3240 mAh / 12.0 Wh • 5300SR image engine • Bluetooth radio • Power cable (included in each box)

Hardware Features

See

- [Front Panel Features](#) on page 3-3
- [Back Panel Features](#) on page 3-10
- [Side Panel Features](#) on page 3-12
- [Bottom Panel Features](#) on page 3-15

Peripherals

The following items are sold separately and enhance your terminal's capabilities. For information about how to purchase these items, contact a Honeywell sales representative.

Dolphin HomeBase™ Device

The Dolphin HomeBase device is a charging and communication cradle. There are two versions of this device: one that supports USB and another that supports RS-232 communication. These two options enable your terminal to interface with the majority of PC-based enterprise systems. When a terminal is seated in a powered HomeBase device, its main battery pack charges in less than four hours.

For more information, see [Dolphin HomeBase Device](#) on page 9-1.

Dolphin QuadCharger™ Device

The Dolphin QuadCharger device is a four-slot charging station for Li-ion battery packs that can charge each battery in less than four hours.

For more information, see [Dolphin QuadCharger Device](#) on page 10-1.

Accessories

Each of the following items is sold separately to enhance your Dolphin terminal's capabilities.

Protective Enclosure

This enclosure wraps around the terminal to protect it from wear and tear.

Li-ion Battery Packs

The available Li-ion battery packs provide the main power supply for the terminal.

For more information, see [Battery Power](#) on page 3-21.

Front Panel Features

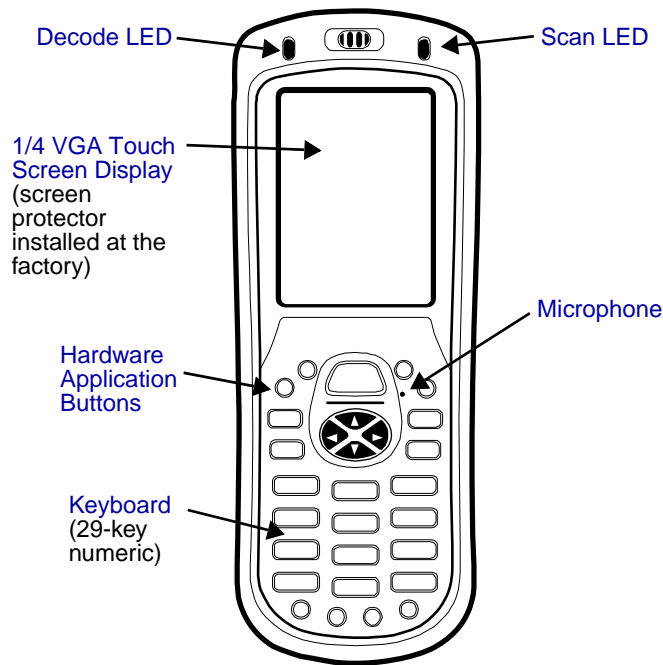

Decode and Scan LEDs

The Scan LED lights red when you press the Scan trigger in scanning applications. The Decode LED lights green when a scanned bar code is successfully decoded. Both LEDs are user-programmable.

Hardware Application Buttons

These hardware buttons appear **only** on the 29-key numeric keyboard and can be programmed to perform software functions available in the Buttons setting (see page 6-3). For more information about these buttons, see [Hardware Application Buttons](#) on page 4-5.

Keyboard

Keyboards are recessed within the housing to increase durability. There are two keyboard options available: one that defaults to numeric (shown above) and one that defaults to alpha. For information about using both keyboards, see [Using the Keyboards](#) on page 4-1.

Microphone

The integrated microphone can be used for voice recording and communication.

Touch Screen Display

The display is a 65,536-color LCD (Liquid Crystal Display) covered by a touch screen lens. The 2.8" 1/4 VGA (Video Graphic Array) is TFT (Thin Film Transistor) color, backlit, and the resolution is 240 x 320; see [Display Backlight](#) on page 3-4.



Dolphin terminals ship with a screen protector already installed over the touch screen lens to help prevent damage to the touch screen. Do NOT remove this screen protector before initial use. Honeywell recommends using screen protectors, especially for applications that require high-volume interfacing with the touch screen. For more information, see [Using Screen Protectors](#) on page 3-4.

For touch screen input, use the stylus included with the terminal or your finger. The method you choose depends on which one is most appropriate for your application. While there is a great deal of variation in different applications, for buttons or icons that are close together, you generally achieve greater accuracy with the stylus; see [Using the Stylus](#) on page 2-5.



Use of objects, such as paper clips, pencils, or ink pens on the touch screen can damage the input panel and may cause damage not covered by the warranty.

Display Backlight

The touch screen display has a backlight that is programmed to turn off after a specified period of time that the terminal is idle. For details, see [Backlight](#) on page 6-8.

Using Screen Protectors

Honeywell defines proper use of the terminal touch panel display as using a screen protector and proper stylus. Screen protectors maintain the ongoing integrity (i.e., prevent scratching) of the touch panel, which is why their use is recommended for applications that require a high to medium level of interface with the touch panel.

Honeywell continues to advocate the use of screen protectors on all Dolphin terminals. We recommend implementing a screen protector replacement program to ensure that screen protectors are replaced periodically when signs of damage/wear are noticeable. For general use, we recommend replacing the screen protector every thirty (30) days. However, replacement cycles vary according to the average level of touch panel use in your application.

Replacement screen protectors can be purchased directly from Honeywell. Please contact a Honeywell sales associate for details.

Honeywell also mandates use of a proper stylus, which is one that has a stylus tip radius of no less than 0.8mm. Use of the Honeywell stylus included with the terminal is recommended at all times.

Honeywell warranty policy covers wear on the touch panel display for the first 12 months provided that a screen protector is applied and an approved stylus is used for the 12 month duration covered by the warranty.



Removing the Screen Protector

Dolphin terminals ship with a touch screen protector already installed. To replace the screen protector, you must remove the one already installed.

-
1. You will need a strong, flat, plastic card (a credit card, for example) to wedge under the existing screen protector.



Note: If you have one, you can also use the small plastic squeegees designed for touch panels.

2. Press the **Blue**  + **Backlight**  keys to put the terminal in **Suspend Mode** (see page 3-26).
3. Carefully apply the flat edge of your plastic card to the upper right corner of the touch screen. Catch the edge of the screen protector and pull it up and away from the touch panel.

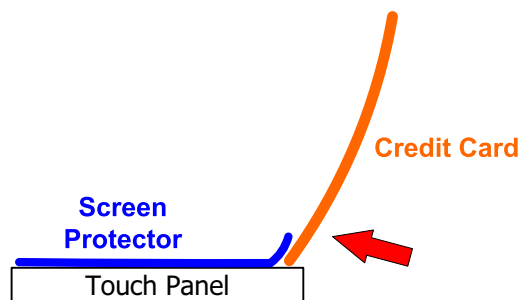

-
4. Wipe the screen with a clean, non-abrasive, lint-free cloth.





Note: Use ionized air, if available, to blow additional dirt or particles off the touch panel.

Installing Your Screen Protector

When installing a new screen protector, use a flat plastic card (such as a credit card) to apply the screen protector smoothly and remove any air bubbles.



Note: If you have one, use the small plastic squeegees designed for touch panels.

1. Press the **Blue**  + **Backlight**  keys to put the terminal in **Suspend Mode** (see page 3-26).

-
2. Clean the touch panel thoroughly with a clean, non-abrasive, lint-free cloth. Make sure nothing is attached to the top of the touch panel.
 3. Release the left edge of the releasing paper on the screen protector.
 4. Align the exposed edge of the screen protector along the left edge of the touch panel. Make sure that it lies flush with edges of the touch panel.

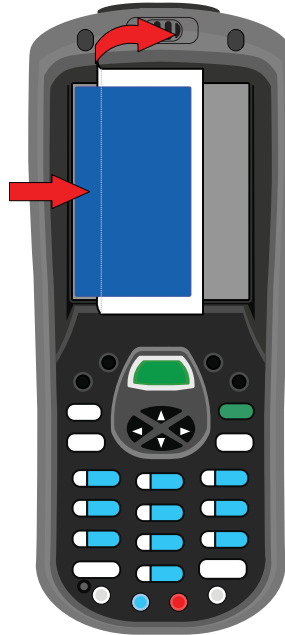

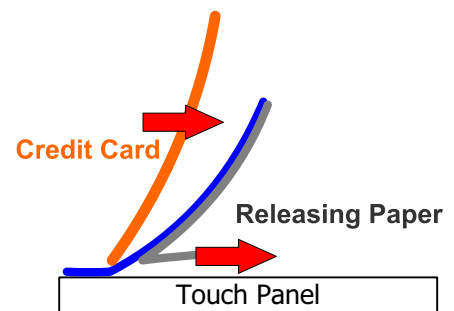
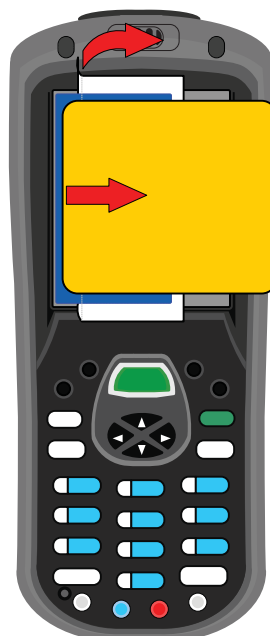

Note: To reposition the screen protector, lift up gently and reapply.

5. Use the card on top of the screen protector to smooth out as you pull on the releasing paper.



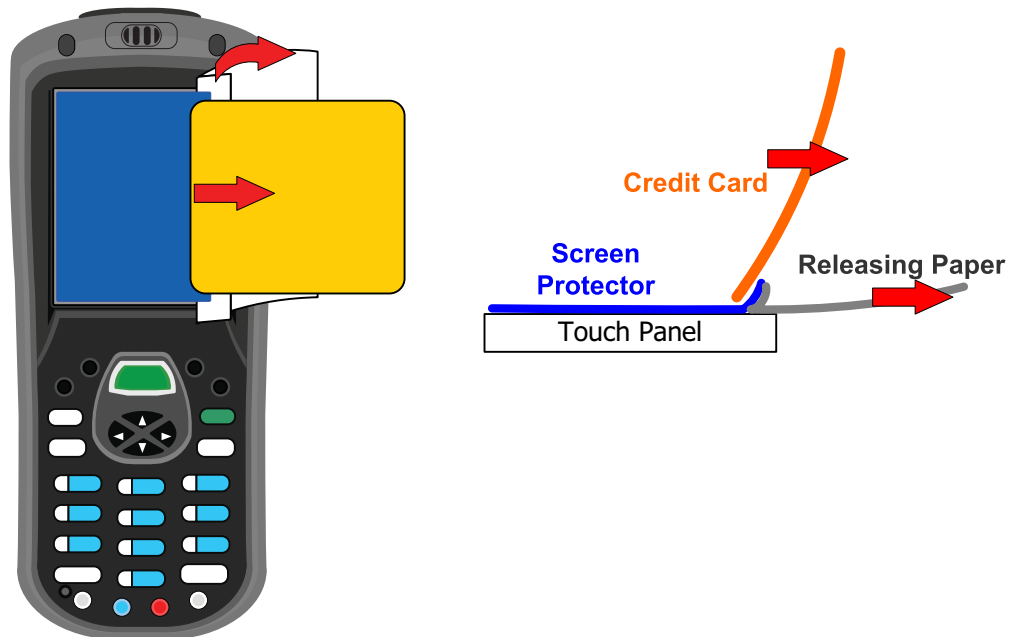

-
- Pull smoothly and evenly from left to right until the screen protector is applied. Press gently but firmly.



- Use the card as necessary to smooth out any air pockets or bumps after application. Press gently but firmly.
- Press the **Backlight**  key to wake the terminal and check the touch panel with the stylus.



- Verify that the screen accepts input from the stylus as usual. If not, re-apply the screen protector.
- Press the **Blue**  + **Backlight**  keys to put the terminal back in **Suspend Mode** (see page 3-26).

11. Clean the surface of the screen protector with a clean, non-abrasive, lint-free cloth.



12. Press the **Backlight**  key to wake the terminal.

13. For maximum performance, recalibrate the screen. Tap **Start > Settings > System tab > Screen**



Screen > Align Screen.



Tap the target firmly and accurately at each location on the screen. The target will continue to move until the screen is aligned.



14. Follow the instructions on the screen.

Back Panel Features

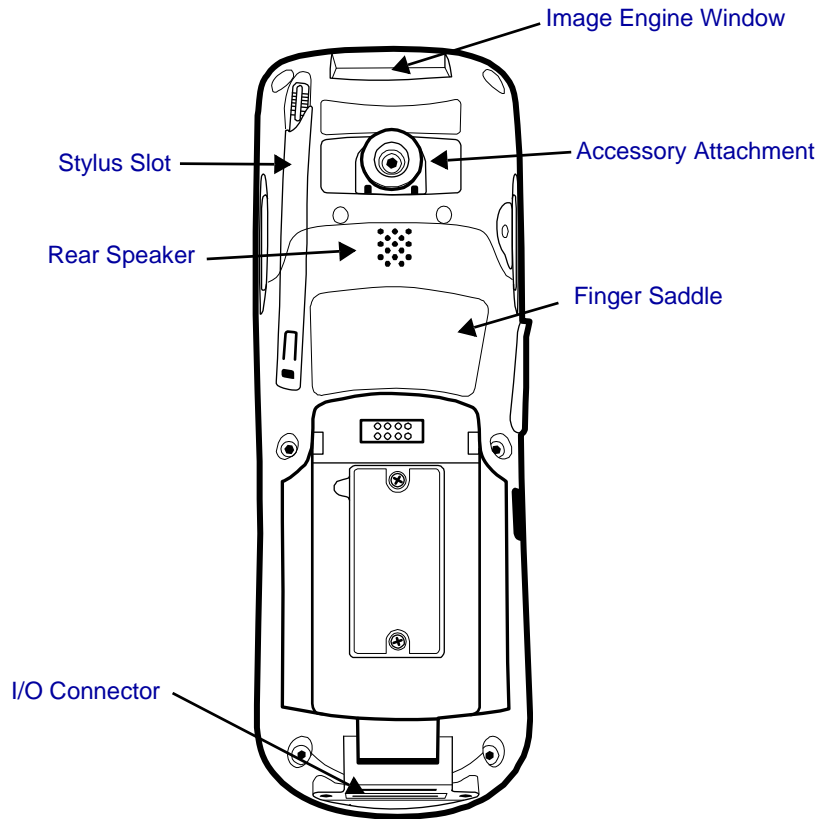

Accessory Attachment

Use this button to attach accessories; see [Using the Accessory Attachment](#) on page 3-11.

Finger Saddle

This is a slightly depressed and angled area of the back panel that is designed to cradle or “saddle” your pointer finger while holding the terminal. This unique ergonomic design makes the terminal comfortable to hold and helps prevent you from accidentally dropping the terminal.

Rear Speaker

The integrated speaker sounds audio signals as you scan bar code labels and enter data but emits no ambient noise on system activity such as processor activity, memory access, radio traffic, etc. The speaker can also be used for playing sounds (e.g., WAV or MP3 files).

Stylus Slot

Dolphin terminals ship with a stylus inserted in the back panel. Store the stylus in this slot when you’re not using it. For details, see [Using the Stylus](#) on page 2-5.

Using the Accessory Attachment

The accessory attachment is a standard tab designed to fit universal accessories available for most cell phones. An accessory must be used for body worn operation.

Attaching a Belt Clip

The accessory attachment on the back panel fits universal swivel clips designed for belts or even pedestal mounts (not available from Honeywell).

Simply insert the tab into the slot until you hear a click or follow the instructions that came with the clip or accessory.

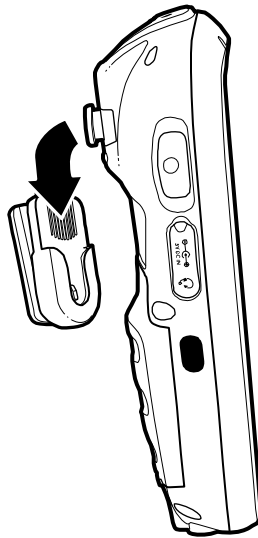

Attaching the Hand Strap

The accessory attachment is also how you attach the hand strap available from Honeywell.

1. Remove the accessory attachment with a Phillips head screwdriver.
2. Thread the hand strap hook underneath.
3. Fasten the accessory attachment to the back panel.

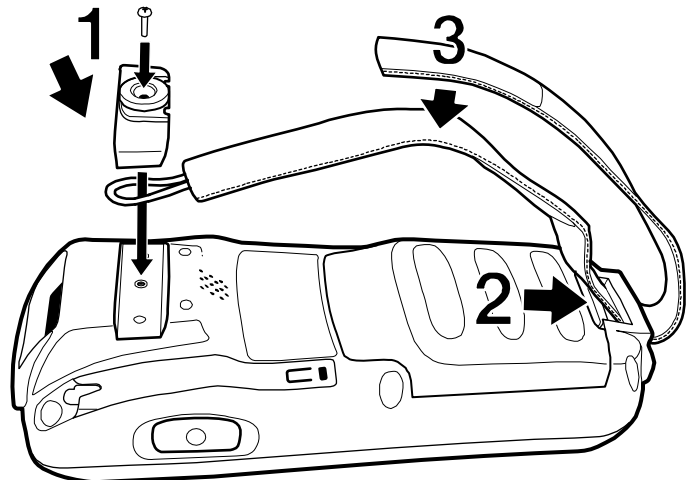

Keep in mind that the hand strap covers the battery. When you want to replace the battery, you will need to adjust the hand strap accordingly.

Side Panel Features

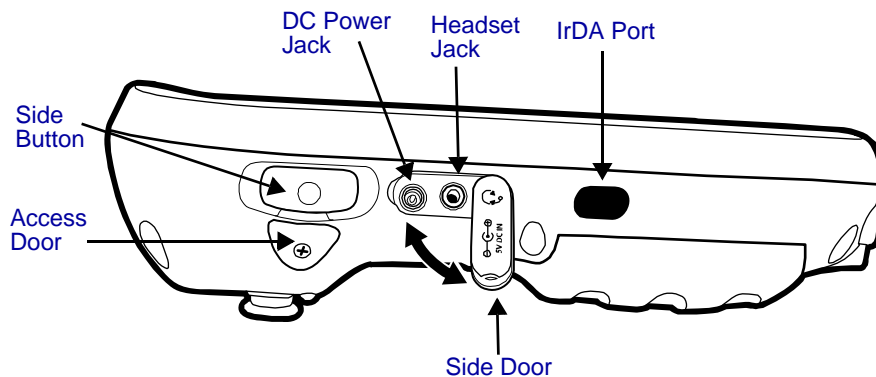

Note: This graphic shows the left side of the terminal.

Access Door

This door covers the memory card slot. To increase memory, install a memory card in this slot. This terminal supports microSD™ and microSDHC™ memory cards. For details, see [Installing Memory Cards](#) on page 3-13.

When closed, the access door seals the memory interface from moisture and particle intrusion thus preserving the terminal's environmental rating.

DC Power Jack

The DC power jack receives external power from the power cable that comes in the box with the terminal. When connected to the power cable, the terminal is powered and the main battery pack is charging.

For more information, about the power cable, see [Connecting the Power Cable](#) on page 3-17.

Headset Jack

This 2.5mm audio jack supports a headset with a mono speaker and microphone.

IrDA Port

The IrDA (Infrared Data Association) port communicates with IrDA-enabled devices such as PCs, printers, modems, or other Dolphin terminals. Maximum data transfer speed is 115 Kbps. For more information, see [Infrared Communication](#) on page 7-2.

Side Button

There is a button like this on both side panels. By default, these buttons wake the terminal from suspend mode unless you are in a scanning application, in which case, these buttons activate the image/scan engine. Scanning with the side buttons can be a more comfortable and therefore a more ergonomic alternative to pressing the SCAN key on the keyboard.

These buttons can be programmed to launch applications from the Today screen. For more information about programming these buttons, see [Customizing a Hardware Button](#) on page 4-5.



Side Door

The rubber door on the left side panel provides access to the Headset and DC power jacks. When closed, the side door seals the terminal from moisture and particle intrusion thus preserving the terminal's environmental rating.

Installing Memory Cards

This terminal supports microSD and microSDHC memory cards up to 4GB.

To install an SD card, you must open the access door on the side panel ([Side Panel Features](#), page 3-12). Access door removal **requires** a Torx 5 (T5).

1. Press the **Blue**  + **Backlight**  keys to put the terminal in **Suspend Mode** (see page 3-26).
2. Place the terminal on a flat, secure surface with the keyboard face-down.
3. Use a T5 screwdriver to remove the screw on the micro-SD door.

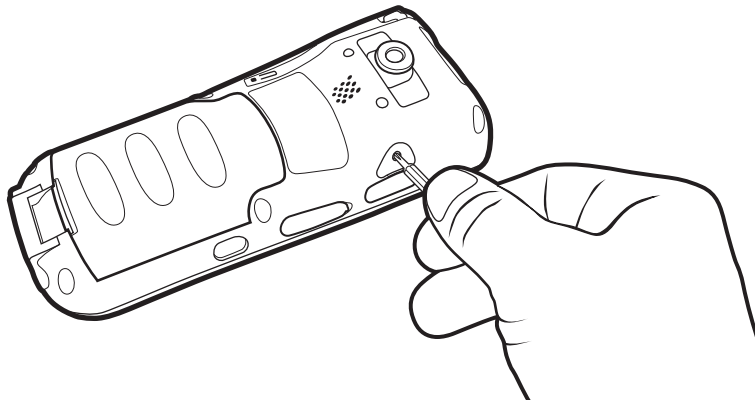

4. Remove the access door.
5. Slide the micro-SD card in with the contacts facing up (away from the keyboard) and the flat, straight edge parallel to the top panel (with the imager).

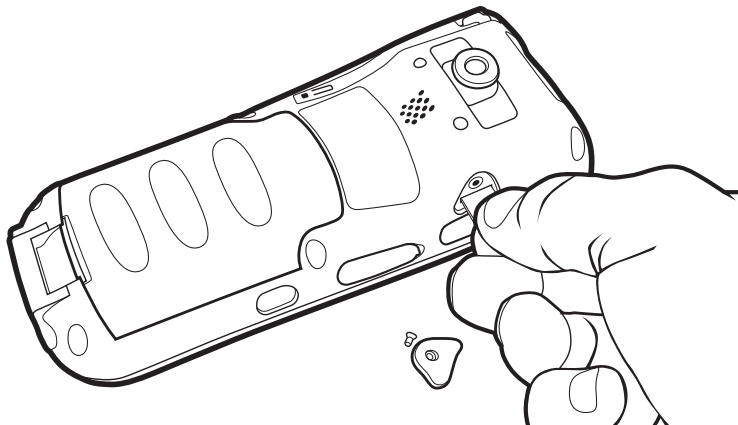

Note: To remove an installed SD card while the access door is open, tap on the edge lightly to unlock the card; the card will pop out just enough for you to grab its edge and pull it out.



Do NOT resume terminal operation while the access door is open! Operating the terminal while the access door is open may cause damage not covered by the warranty.

-
6. Replace the access door and tighten the screw. The access door must be properly sealed before resuming terminal operation. Failure to seal the access door may cause damage not covered by the warranty.
 7. Press the **Backlight**  key to resume operation.
 8. To verify that the operating system recognizes the new memory card, Tap **Start > Programs > File Explorer** and navigate to the **My Device\Storage Card** folder. You should see the contents of the memory card displayed on the screen.

Bottom Panel Features

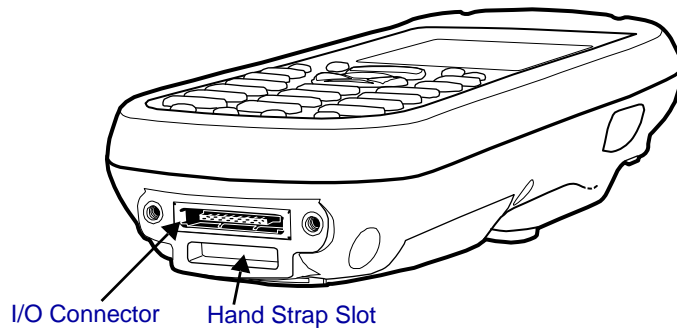

Hand Strap Slot

There is an adjustable, elastic hand strap available for purchase with the terminal. When installing the hand strap, you loop the elastic strip through this slot. For instructions, see [Attaching the Hand Strap](#) on page 3-11.

I/O Connector

The I/O mechanical connector is designed to work exclusively with peripherals and cables designed for the Dolphin 7600 terminal. This connector powers the terminal, charges the main battery, and facilitates communication.

This connector supports full speed USB 1.1 communication (up to 12 Mbps) and RS-232 communications with a maximum speed of 115Kbps and seven baud rate settings.

Through this connector, you can communicate with a host workstation via Microsoft ActiveSync; see [ActiveSync Communication](#) on page 3-18.

The I/O connector supports the following signals:

- Data Carrier Detect
- Received Data
- Transmitted Data
- Data Terminal Ready
- Signal GND
- Data Set Ready
- Request To Send
- Clear To Send
- Ring Indicator
- USB GND
- USB +5V
- USB D+
- USB D-

Note: Signals referenced are for a DTE device.

Connecting the USB Cable

Connect the USB cable to the I/O connector to facilitate USB communication between the terminal and host workstation.

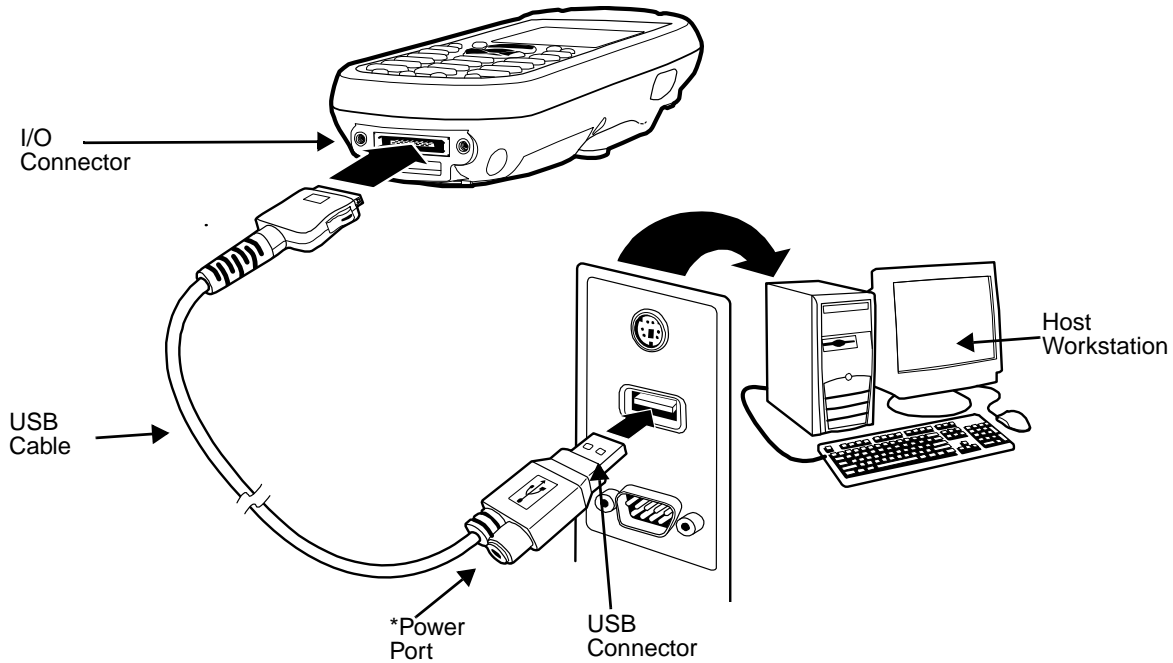

*This is a communication-only cable until you plug the power cable into the power port.

Connecting the Power Cable

The power port on the back end of the USB connector fits the power cable that comes with each terminal. To charge the terminal while communicating, connect the power cable to the power port.

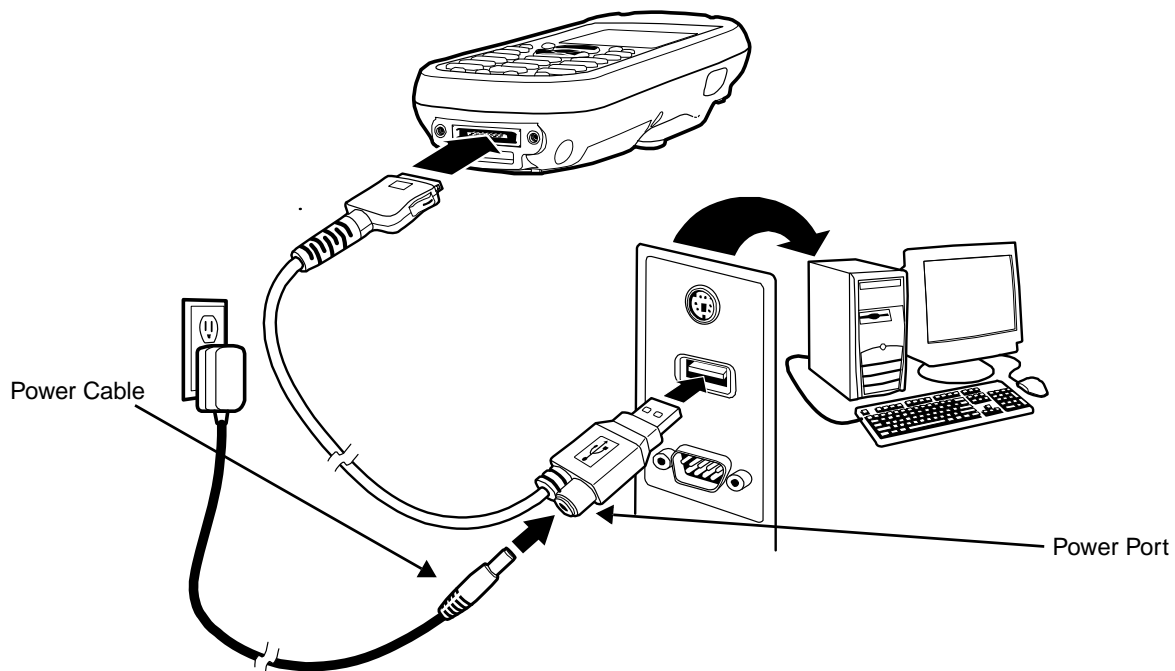

ActiveSync Communication

To synchronize, ActiveSync 4.5 or higher must be installed and configured for the appropriate communication type on the host workstation and the Dolphin terminal. Dolphin terminals ship with ActiveSync already installed. Therefore, if ActiveSync is already installed on the host workstation, you just need to connect the Dolphin terminal to the host workstation (via Dolphin peripheral) to initiate communication.

If ActiveSync 4.5 or higher is not installed on the host workstation, install it from the Getting Started CD that came with the Dolphin terminal. Insert the CD into the CD-ROM drive of the host workstation and follow the directions on your screen. You can also download the most current version of ActiveSync from www.microsoft.com and install.



When communicating via ActiveSync, your terminal is designed to be connected to the host workstation with a communication peripheral sold/manufactured by Honeywell, such as the charge/communication cable. Use of any peripheral not sold/manufactured by Honeywell may cause damage not covered by the warranty.

Communication Types

The terminal supports the following types of communication via ActiveSync through its [I/O Connector](#) (see page 3-15) on the bottom panel:

- | | |
|---------------|--|
| USB | The USB cable and hardware peripherals allow the terminal to communicate with a workstation or to networked through a USB hub. The terminal supports full-speed USB communication (USB 1.1); maximum data transfer rate is 12 Mbps. The terminal defaults to USB communication out of the box. |
| RS-232 | The RS-232 cable allows the terminal to communicate with a workstation, modem, or any RS-232 device. Maximum data transfer rate is 115 Kbps. |

Hardware Requirements for Setup

- Dolphin HomeBase device
- Communication cable from Honeywell
- Power cable from Honeywell; see [Connecting the Power Cable](#) on page 3-17.
- USB cable (for USB communication) from Honeywell
- Serial cable (for RS-232 communication) from Honeywell

Software Requirements for Communication

On the workstation:

- Windows 98 Second Edition, Windows Me, Windows 2000, Windows NT (4.0, SP6 or higher), Windows XP, or Windows Vista operating systems.
- ActiveSync must be setup on the workstation *before* you initiate synchronization from the terminal for the first time.

On the terminal and the workstation:

- ActiveSync 4.5 or higher. ActiveSync must be configured for same communication type (USB or RS-232) on both the host workstation and the Dolphin terminal.

Note: ActiveSync software is available on the Getting Started CD that comes in the box with the Dolphin terminal.

Setting Up the Host Workstation

Verify that ActiveSync is configured to use the appropriate communication type by clicking **File > Connection Settings**.

For USB communication, check **Allow USB connections**.

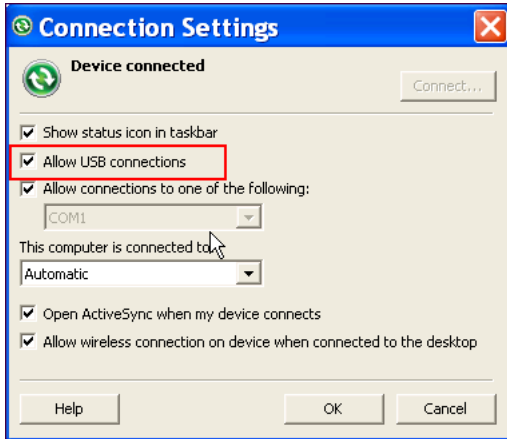

For RS-232 communication, connect to **COM1**.

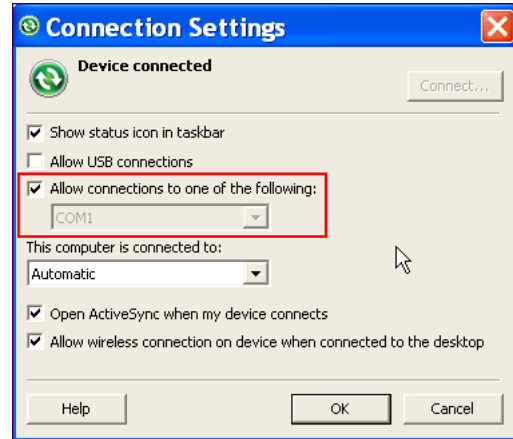

Note: You can have both USB and RS-232 selected in the software without impacting processing. However, your hardware setup should use only RS-232 or USB, not both.

Communicating with the Dolphin Terminal

After setting up both the workstation and the terminal, ActiveSync connection should be automatic.

1. Connect the Dolphin terminal to the a communication peripheral, such as the Dolphin HomeBase.
2. The Dolphin terminal automatically opens ActiveSync to establish a connection.

Synchronizing with the Host Workstation

After setup, synchronization begins automatically whenever the terminal's mechanical connector connects to a Dolphin peripheral that is connected to a host workstation with ActiveSync installed.

Exploring the Terminal from the Workstation

When the terminal and workstation are connected, open the main ActiveSync window (on the desktop), and click **Explore**.



The Mobile Device folder opens in Windows Explorer.

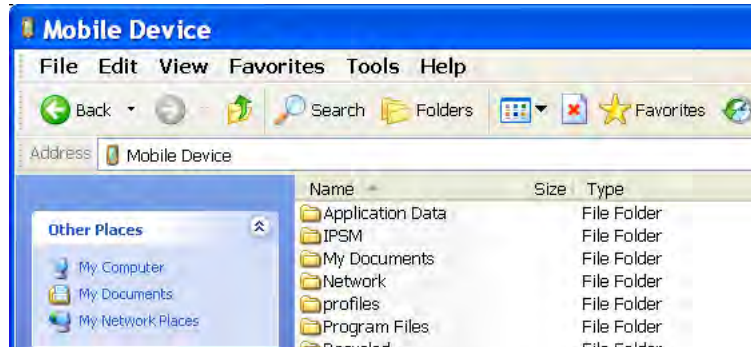

The terminal is now treated as a mass storage device, and transferring files is as simple as dragging and dropping or copying and pasting as you would for moving files between folders on your hard drive.

Battery Power

Dolphin terminals feature intelligent battery technology with two types of battery power:

- The main battery pack on the back panel (see [Main Battery Pack](#) on page 3-21)
- The backup battery located inside the terminal (see [Internal Backup Battery](#) on page 3-24)

Both batteries work together to prevent data loss when the terminal is used over long periods of time.

Both batteries must be charged to full capacity before using the terminal for the first time!

Main Battery Pack



Use only the Li-ion battery packs provided by Honeywell. Use of any battery not sold/manufactured by Honeywell may result in damage not covered by the warranty.

The Li-ion battery pack is 3.7V/3240mAh/12.0Wh and the primary power source for both the Dolphin terminal and the internal backup battery.

Changing the Main Battery Pack

Before installing a battery pack, press the Blue + Backlight keys to put the terminal in [Suspend Mode](#) (see page 3-26) so that operations are suspended before removing the main power source. Always put the terminal in suspend mode prior to changing the battery.

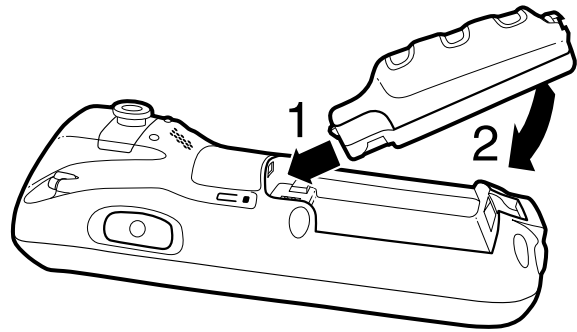

Charging Options

When the battery is installed in the terminal, you can insert the terminal into any one of the following peripherals:

- [Power Cable](#) (see page 2-1)
- [Dolphin HomeBase Device](#) (see page 9-1)
- [Charge/Comm Cable](#) (see page 3-17)

To fully charge the Li-ion battery before installing in the terminal, use the

- [Dolphin QuadCharger Device](#) (see page 10-1)

Charging Time

The Li-ion battery pack requires four hours to charge to full capacity.

Battery Pack Storage Guidelines

To maintain optimal battery performance, follow these storage guidelines:

- Avoid storing batteries outside the specified range of -4 to 122° F (-20 to 50°C) or in extremely high humidity.
- For prolonged storage, do not keep batteries stored in a charger that is connected to a power source.

Guidelines for Battery Pack Use and Disposal

The following are general guidelines for the safe use and disposal of batteries:

- Use only the Li-ion battery packs provided by Honeywell. Use of any battery not sold/manufactured by Honeywell may pose a personal hazard to the user.

-
- Replace defective batteries immediately; using a defective battery could damage the Dolphin terminal.
 - Never throw a used battery in the trash. It contains heavy metals and should be recycled according to local guidelines.
 - Don't use a battery in any other manner outside its intended use in Dolphin terminals and peripherals.
 - Don't short-circuit a battery or throw it into a fire; it can explode and cause severe personal injury.
 - Excessive discharge damages a battery. Recharge the battery when your terminal indicates low battery power.
 - If you observe that the battery is physically damaged in some way, please send it to Honeywell or an authorized Honeywell service center for inspection.
 - Although your battery can be recharged many times, it will eventually be depleted. Replace it after the battery is unable to hold an adequate charge.
 - If you are not sure the battery or charger is working properly, please send it to Honeywell or an authorized Honeywell service center for inspection.

Managing Main Battery Power

Data and files saved on the Dolphin terminal may be stored in RAM memory; therefore, maintain a continuous power supply to the terminal to help prevent data loss. When you remove a battery pack, insert another charged battery pack in the Dolphin. If the main battery pack is low, insert the terminal into a charging peripheral to power the terminal and begin recharging the battery.

Note: If the main battery is low and the terminal is in suspend mode, pressing the SCAN button does **not** wake the Dolphin terminal; you must replace the discharged battery with a fully charged battery.

Default Critical and Low Battery Points

Dolphin terminals are programmed to display warnings when the battery reaches critical and low battery points. The following registry entry sets both warning points:

[HKEY_LOCAL_MACHINE\System\CurrentControlSet\Control\Power]

There are two DWORD values in this registry entry: LowBatt and CriticalBatt. The default values for these entries are as follows:

LowBatt=19 (25%)

This sets the Low Battery point to 25% (19 hex=25 decimal). When the battery hits the percentage charge specified here, the user is notified by this icon in the Navigation bar . 

If the main battery is low and the terminal is in suspend mode, pressing the SCAN or Power button won't wake the Dolphin terminal; you **must** replace the discharged battery with a battery charged over 25% mark before you can resume terminal operation.

CriticalBatt=a (10%)

This sets the Critical Battery point to 10% (a hex= 0 decimal). When the battery hits the percentage charge specified here, the user is notified by this icon in the Navigation bar . 

Note: Warnings do not appear when the terminal is on external power.

Setting Critical and Low Battery Points

Developers can re-reset the default battery points in the RegEdit Power Tool.

1. Tap **Start > Power Tools > RegEdit**.

-
2. Drill-down to **HKEY_LOCAL_MACHINE > System > CurrentControlSet > Control > Power.**

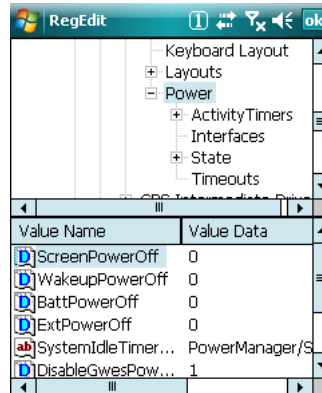

3. Change the **Value Data** of the **BattPowerOff** and **ExtPowerOff** entries.
4. Tap **OK** to save changes.

Note: These changes will not persist through a cold boot. To ensure that these settings persist through cold boots, you need to use the RegBackup Power Tool.

For more information about Registry Power Tools, refer to the Dolphin Power Tools User's Guide available for download at www.honeywell.com/aidc.

Internal Backup Battery

Located inside the terminal, the backup battery is a 2.4V nickel metal hydride (NiMH) battery.

The internal backup battery prevents the terminal from being reset when you remove the main battery pack. This battery retains RAM data and allows the real-time clock to remain operational for up to 30 minutes. If the terminal is left without the main battery pack for more than 30 minutes, the internal backup battery discharges and needs to be recharged to function according to specifications.

Note: Even if the internal backup battery fails, data and programs stored in Flash memory (IPSM) or an optional SD card are not lost. However, the terminal automatically cold boots when you install a fully charged battery pack and you need to reset the real-time clock.

Charging

The internal backup battery charges off the main battery pack and requires eight hours charge time to backup RAM data for 30 minutes. You can begin using the Dolphin terminal after charging the main battery for four hours; however, the internal backup battery will continue to charge off the main battery.

To ensure that the internal backup battery functions properly, maintain a consistent power supply for the first eight hours of terminal operation. This power supply can be external power (using a charging peripheral) or an installed, charged battery pack or a combination of both.

Guidelines

Follow these guidelines to maximize the life of the Dolphin's internal backup battery:

- Keep a charged Li-ion battery pack in the Dolphin terminal.
- Keep the Dolphin terminal connected to a power source when the terminal is not in use.

Checking Battery Power

Tap **Start** > **Settings** > **System** tab > **Power**.

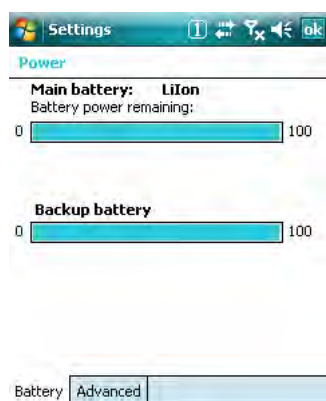

Resetting the Terminal

There are two ways to reset the Dolphin terminal: a soft reset and a hard reset.

Soft Reset (Warm Boot)

A soft reset re-boots the terminal without losing RAM data. You would perform a soft reset 1) after installing software applications that require a reboot, 2) after making changes to certain system settings, or 3) when the terminal fails to respond.

1. Press and hold Red ● + ESC **ESC** for approximately 5 seconds. The screen turns white and the decode and scan LEDs flash for approximately three seconds.
2. When the reset is complete, the [Today Screen](#) (see page 2-2) appears.

Hard Reset (Cold Boot)



A hard reset erases all of the data and applications stored in RAM memory and launches AutoInstall, which re-initializes the terminal.

Hard resets automatically launch a soft reset as part of the boot process.

1. Press and hold Red ● + TAB **TAB** for approximately 5 seconds. The screen turns white and the decode and scan LEDs light for approximately three seconds.
2. The terminal re-initializes, which re-installs all programs stored in the **IPSMVAutoinstall** folder.



Note: Set the time and date after each hard reset to ensure that the system clock is accurate. Tap the date on the [Today Screen](#) (see page 2-2) to open the Clock setting and set the time and date.



Suspend Mode

Suspend mode suspends terminal operation. The terminal appears to be “off” when in suspend mode. The terminal is programmed to go into suspend mode automatically when inactive for a specified period of time. You can set this time period in the Power setting.



To Put the Terminal in Suspend Mode

Press the **Blue**  + **Backlight**  keys.

Note: You should always put the terminal in suspend mode when you change the battery pack; see [Changing the Main Battery Pack](#) on page 3-21.

To Resume Terminal Operation

To resume terminal operation (or “wake” the terminal from suspend mode),

- Press the **Blue**  + **Backlight**  keys.
- Press the **Scan** key .
- If not in a scanning or imaging application, press one of the side buttons (see page 3-12).

Troubleshooting Suspend/Resume

If the terminal does not wake when you press the Scan key, the main battery might be too low to resume operation. To check, remove the battery and install a fully charged battery or connect the terminal to a Dolphin charging peripheral.

Care and Cleaning of the Dolphin Terminal

When needed, clean the image engine window and the LCD display with a clean, non-abrasive, lint-free cloth. The terminal can be cleaned with a damp cloth.

Using the Keyboards

Overview

There are two keyboard options: a 29-key keyboard and the 38-key keyboard.

29-Key Numeric Keyboard







38-Key Alpha Keyboard



The buttons are recessed under the overlay for maximum durability and the panel is backlit for maximum visibility in various lighting conditions.









Suspend/Resume

Both keyboards provide multiple ways to suspend/resume terminal operation.

Suspend	 	Blue + Backlight
Resume		Backlight
		Scan

Function Keys

Function keys appear on both keyboards and perform specific functions.

Name	Key	Function
Backlight		Toggles the keyboard backlight on and off.
Backspace		Backspace moves the cursor back one space. If you are typing text, a character is deleted each time you press the backspace key.
Escape		Cancels an action.
Enter		Performs the same function as the Enter key on a PC or workstation.
Scan		<ul style="list-style-type: none">• Activates the image engine to scan a bar code or take an image.• Wakes the terminal from suspend mode.
Tab		Moves the cursor to the next tab stop or field (on a form or application window).
The following keys appear only on the 29-key keyboard:		
Shift		Provides functions as a shift key in application windows and a Caps Lock key when the 29-key keyboard is in alpha mode. On the 38-key keyboard, the Blue modifier key functions as a shift key in both alpha and numeric modes.
Space		Moves the cursor one space forward. If you are typing text, it moves the text one space forward as well. On the 38-key keyboard, you can perform the same function as the SP key by: <ul style="list-style-type: none">• Pressing NUM + E in alpha mode• Pressing E in numeric mode

Modifier Keys

Modifier keys modify the next key pressed to perform functions or type special characters.

Name	Key	Function
Blue and Red		Modifies the next key pressed. The overlay of each keyboard is color-coded to indicate the character typed or function performed when the keyboard buttons are pressed in combination with these keys.

For modifier key combinations on the 29-key keyboard:

- See [29-Key Blue Key Combinations \(Alpha Mode\)](#) on page 4-7.
- See [29-Key Red Key Combinations](#) on page 4-8.

For modifier key combinations on the 38-key keyboard:



- See [38-Key Red Key Combinations](#) on page 4-11.
- See [38-Key NUM Lock Mode](#) on page 4-12.

Alpha/Numeric Indicator

The Navigation bar features an icon that indicates the alpha/numeric status of the keyboard.



This icon changes when the keyboard status changes.





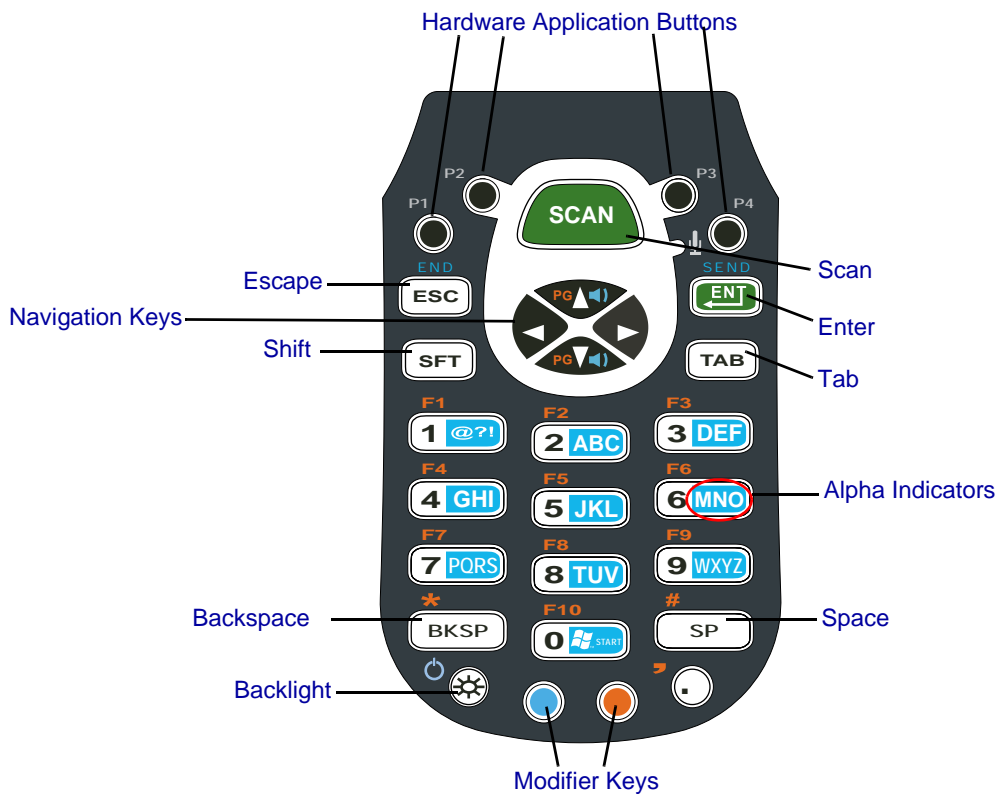

Icon	Keyboard Status
	The keyboard is in lowercase alpha mode.
	The keyboard is in shifted (uppercase) alpha mode.
	The keyboard is in numeric mode.

29-Key Numeric Keyboard



Navigation Keys

Located in the center of each keyboard for easy access with either hand, the navigation keys enable you to move the cursor through application screens.

Key	Description		
	Move the cursor up one row or line.	Volume up	Page up
	Move the cursor down one row or line.	Volume down	Page down
	Move the cursor one character to the right.		+
	Move the cursor one character to the left.		-

Hardware Application Buttons

These four buttons are programmed to launch software applications when the [Today Screen](#) (see page 2-2) is on the screen.

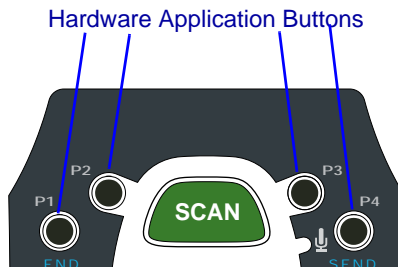

To customize these settings, tap **Start > Settings > Personal tab > Buttons**  **Buttons**.

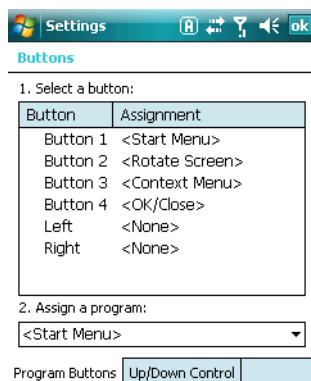

Buttons Column

Matching Hardware Button

Buttons 1–4

Buttons P1—P4 on the 29-key keyboard.

Left

Left side button; see [Side Button](#) on page 3-12.

Right

Right side button; see [Side Button](#) on page 3-12.

Customizing a Hardware Button

1. Select the button you want to modify.
2. Select a program from the **Assign a program** list.
3. Tap **OK** to save all changes and the change is applied immediately.
4. To verify the change, navigate to the Today screen, press the hardware button and verify that the selected application launches.

Toggling Between Alpha and Numeric Modes

The 29-key keyboard defaults to numeric mode, which means that the keyboard boots up to numeric mode after each hard reset.

Numeric mode is when you type numbers with the number keys. Alpha mode is when you type letters or characters with the number keys. The keyboard switches between alpha and numeric modes easily.

The command bar displays an icon that indicates the status of the keyboard so that you can see which mode you're in when toggling; see [Alpha/Numeric Indicator](#) on page 4-3.

Switching to Alpha Mode

To switch modes, tap the Blue modifier key  as follows:

- Single-tap to switch only the next character pressed to alpha mode.
The keyboard automatically switches back to numeric mode for the next key pressed.
- Double-tap to switch to alpha mode permanently.
Double-tap again to switch back to numeric mode permanently.

Alpha Indicators

Each number key has a blue section with white characters inside it that indicate which letter or symbol is typed when you press that key in alpha mode.

Please note that when typing in alpha mode, you must use the same multi-press method you would use when typing letters on a phone keypad. Each key press types the next letter in the sequence as displayed by the alpha indicator.

Note: You can still use regular Blue key combinations in alpha mode by pressing and holding the Blue modifier key with the next key in the combination. For combinations, see [29-Key Blue Key Combinations \(Alpha Mode\)](#) on page 4-7.

Shift Functionality

In Alpha Mode

When you switch the keyboard to alpha mode, letters type in lowercase by default.

To capitalize letters, tap the SFT key  as follows:

- Single-tap to capitalize only to the next letter pressed.
- Double-tap to turn CAPS LOCK on and off.

In Numeric Mode

Numeric mode is the default keyboard mode. When the keyboard is in numeric mode, tap the SFT key once to produce special characters; see [29-Key Shift Functionality in Numeric Mode](#) on page 4-7.

29-Key Blue Key Combinations (Alpha Mode)

Tap the Blue modifier key to switch to alpha mode for the next key pressed.
Double-tap the Blue modifier key to switch to alpha mode permanently.

Key	Character	Uppercase: Double-tap SFT
1	@ ? ! :	@ ? ! :
2	abc	ABC
3	def	DEF
4	ghi	GHI
5	jkl	JKL
6	mno	MNO
7	pqrs	PQRS
8	tuv	TUV
9	wxyz	WXYZ

Functions

If the keyboard is in numeric mode, tap the Blue key once to achieve the following:

Key Combination	Function
Blue + Up Arrow	Volume up
Blue + Down Arrow	Volume down

29-Key Shift Functionality in Numeric Mode

When the keyboard is in numeric mode (the default state), tap the SFT key once to produce several common characters.

Key	Character
1	!
2	@
3	#
4	\$
5	%
6	^
7	&
8	*

Key	Character
9	(
0)

29-Key Red Key Combinations

Special Characters

Key Combination	Character
Red + Left Arrow	-
Red + Right Arrow	+
Red + BKSP	*
Red + SP	#
Red + .	,
Red + P1	/
Red + P2	=
Red + P3	;
Red + P4	\

Functions

Key Combination	Function
Red + ESC (hold)	Soft reset (warm boot)
Red + TAB (hold)	Hard reset (cold boot)
Red + Up Arrow	Page up
Red + Down Arrow	Page down
Red + 1	F1
Red + 2	F2
Red + 3	F3
Red + 4	F4
Red + 5	F5
Red + 6	F6
Red + 7	F7
Red + 8	F8

Key Combination	Function
Red + 9	F9
Red + 0	F10

38-Key Alpha Keyboard

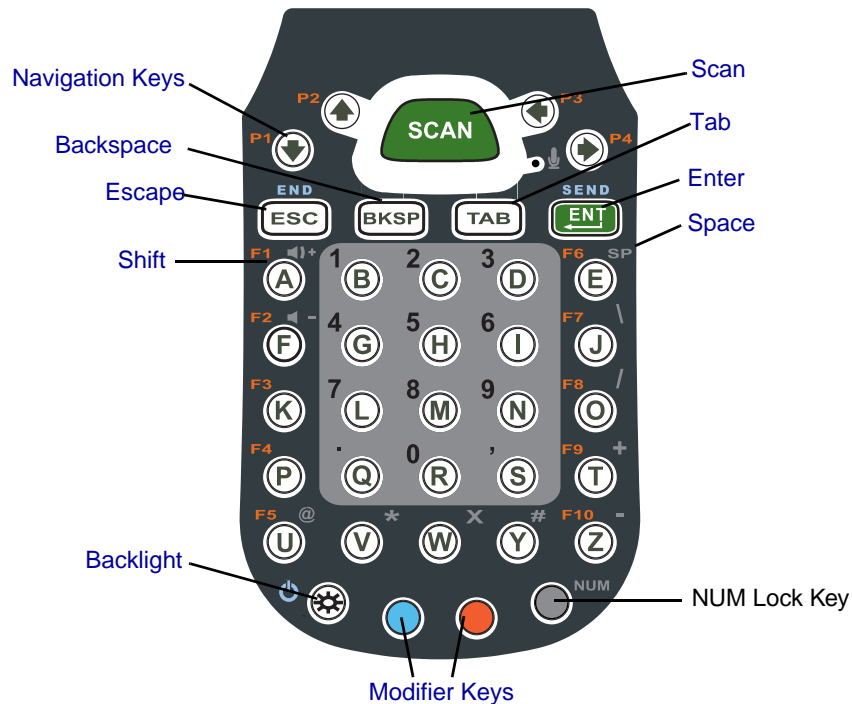

Toggling Between Alpha and Numeric Modes

The 38-key keyboard defaults to lowercase alpha mode, which means that the keyboard boots up to lowercase alpha mode after each hard reset.

Numeric mode is when you type numbers with the number keys. Alpha mode is when you type letters or characters with the number keys. The keyboard switches between alpha and numeric modes easily.

The command bar displays an icon that indicates the status of the keyboard so that you can see which mode you're in when toggling; see [Alpha/Numeric Indicator](#) on page 4-3.

Shift Functionality in Alpha Mode

- To apply Shift functionality to the next character pressed while in lowercase alpha mode, tap the Blue modifier key once. Shift functionality is removed from the next key pressed automatically
- To switch into CAPS LOCK mode, tap the Blue modifier key twice.
To switch out of CAPS LOCK mode, tap the Blue modifier key twice again.

Switching to Numeric Mode



- To switch to numeric mode for the next key pressed, tap the NUM key once.
- To lock into numeric mode, double-tap the NUM key.
- If locked in numeric mode, double-tap NUM key again to switch back to alpha mode.

For more information about NUM Lock functionality, see [38-Key NUM Lock Mode](#) on page 4-12.

38-Key Red Key Combinations

Key Combination	Function
Red + ESC (hold)	Soft reset (warm boot)
Red + TAB (hold)	Hard reset (cold boot)
Red + Down Arrow	P1
Red + Up Arrow	P2
Red + Left Arrow	P3
Red + Right Arrow	P4
Red + Left Side Button	P5
Red + Right Side Button	P6
Red + A	F1
Red + F	F2
Red + K	F3
Red + P	F4
Red + U	F5
Red + E	F6
Red + J	F7
Red + O	F8
Red + T	F9
Red + Z	F10

38-Key NUM Lock Mode



- To switch to numeric mode for the next key pressed, tap the NUM key once.
- To lock into numeric mode, double-tap the NUM key.
- If locked in numeric mode, double-tap NUM key again to switch back to alpha mode.

Numbers

Key	Character
B	1
C	2
D	3
G	4
H	5
I	6
L	7
M	8
N	9
R	0

Special Characters

Key	Character
J	\
Q	.
S	,
O	/
T	+
U	@
V	*
W	X
Y	#
Z	-

Special Functions

Key	Character
A	Volume up
F	Volume down
E	SP



Using the Image Engine

Overview

The Dolphin terminal houses a compact image engine using Adaptus™ Imaging Technology that instantly reads all popular 1D and 2D bar codes and supports omni-directional aiming and decoding. The image engine can also capture digital images.

*Pull the plastic tab to remove the plastic film cover over the image engine window before activating the image engine.

Available Engines

5300 Standard Range (5300SR)

	8.3 mil Linear	10 mil PDF417	13 mil UPC	15 mil Data Matrix	15 mil QR	35 mil MaxiCode
*Working Range:	(.020cm)	(.025cm)	(.033cm)	(.038cm)	(.038cm)	(.089cm)
Near	3.5 in. (8.9cm)	3.1 in. (7.9cm)	2.1 in. (5.3cm)	2.3 in. (5.8cm)	3.1 in. (7.9cm)	2.0 in. (5.1cm)
Far	7.6 in. (19.3cm)	9 in. (22.9cm)	13.2 in. (33.5cm)	10.2 in. (25.9cm)	8.8 in. (22.4cm)	13.0 in. (33cm)

*Data characterized at 23°C and 0 lux ambient light.

Supported Bar Code Symbolologies

Symbology Type	Symbology Name
1D Symbolologies	Codabar Code 3 of 9 Code 11 Code 32 Pharmaceutical (PARAF) Code 93 Code 128 EAN with Add-On EAN with Extended Coupon Code EAN-8 EAN-13 GS1-128 GS1 Databar Interleaved 2 or 5 ISBT 128 Matrix 2 of 5 MSI Plessey PosiCode Straight 2 of 5 IATA Straight 2 of 5 Industrial Telepen Trioptic Code UPC UPC-A UPC-E
2D Symbolologies	Aztec Codablock Code 16K Code 49 Composite Data Matrix GS1 Databar MaxiCode Micro PDF OCR PDF417 QR Code
Composite Codes	Aztec Mesa Codablock F EAN-UCC GS1 Databar-14
OCR	OCR US Money Font MICR (E 13 B) and SEMI Font OCR-A OCR-B
Postal Codes	Postnet and most international 4-state codes Australian Post British Post Canadian Post China Post Japanese Post KIX (Netherlands) Post Korea Post Planet Code

Activating the Engine

When a scanning application is open, press the SCAN key  to activate the image engine. You can also press one of the side buttons (see page 3-12), which are programmed to activate the image engine in a scanning application by default.

Using Demos

Demos are software utilities loaded on all Dolphin terminals that demonstrate the advanced features of the terminal. There are two Demos feature the image engine: Image Demo and Scan Demo.

To access these demos, tap **Start > Demos**,

- Select **Scan Demo** to verify decoding, or
- Select **Image Demo** to verify imaging.

For more information about Demos, refer to the Dolphin Demos User's Guide, which is available for download from www.honeywell.com/aidc.

LEDs

The LEDs in the center of both keyboards (for location, see [LEDs](#) on page 4-1) light when using the image engine.

Scan LED The LED on the right lights red when you press the scan trigger in scanning applications.

Decode LED The LED on the left lights green when a scanned bar code is successfully decoded.

Decoding

The Dolphin terminal supports two types of image decoding: full-area imaging and Advanced Linear Decoding (ALD).

Full-area Imaging

Full-area imaging means that the Dolphin terminal support omni-directional aiming, which means that a positive read can be obtained from many positions. For details, see [Omni-Directional Scanning Positions](#) on page 5-4.

ALD

ALD provides fast reading of linear (1D) and stacked linear bar codes (PDF417). For the best read, the aiming pattern should be centered horizontally across the bar code. When ALD is enabled, the reader does not read matrix or postal codes.

To Decode a Bar Code

1. Tap **Start > Demos > Scan Demo**.
2. Position the Dolphin terminal over one of the sample bar codes on page 5-4. A range of 4–10 inches (10–25 cm) from the bar code is recommended.
3. Project the aiming brackets by pressing and holding the SCAN key. The Scan LED lights red.
4. Center the aimer crosshair over the bar code. The aiming beam should be oriented in line with the bar code to achieve optimal decoding; [Omni-Directional Scanning Positions](#), page 5-4

5. When the bar code is successfully decoded, the decode LED lights green and the terminal beeps.

Sample Bar Codes

You can use the following bar codes to verify decoding:

Sample 128



Code 128

Sample PDF417



PDF417 Test Message

Omni-Directional Scanning Positions

The high-vis aiming pattern frames the bar code to provide you with the best scanning performance.

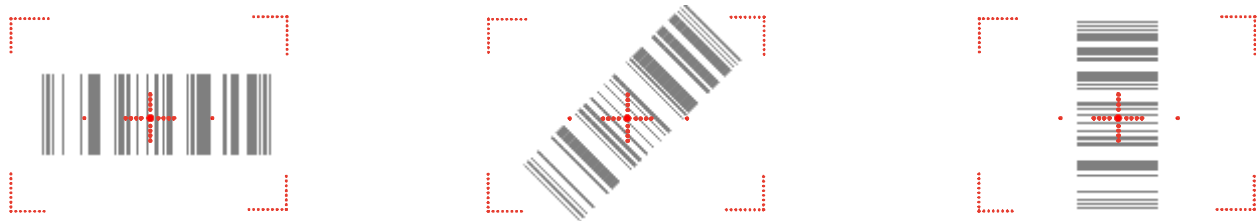

Note: To achieve the best read, the aiming beam should be centered horizontally across the bar code.

The aiming pattern is smaller when the terminal is held closer to the code and larger when the terminal is held farther from the code. Symbologies with smaller bars or elements (mil size) should be read closer to the unit whereas larger bars or elements (mil size) should be read farther from the unit.

Capturing Images

The image-capture process is an intuitive, split-second operation for experienced users. By following basic guidelines, however, new users can easily develop their own technique and, with practice, quickly learn to adapt to different application environments.

Image Preview

When the imaging process is initiated, the touch screen displays a preview of the object. This is a live video image of what the imager is currently viewing and has a slightly degraded appearance compared to the captured image. This is normal; the captured image has a higher resolution.

File Formats

The Dolphin terminal is capable of saving images in a number of industry-standard file formats such as BMP, JPG and PNG. The default file format for images is a grayscale JPG.

File Size

Digital images have a maximum image size of 640 x 480 pixels and may have up to a 256 grayscale image definition. The image quality and related file size are determined by the data compression method used by the software application used to take the image.

The average size of the image file is approximately 4–8K. However, the size of the image depends on image content, the more complex the content, the larger the file size.

Taking an Image

1. Tap **Start > Demos > Image Demo**.
2. Point the terminal at the object.
3. Press the SCAN key to activate the engine. The touch screen displays a preview of the object.
4. Adjust the terminal's position as necessary. Use the preview on the screen as a guide.
5. Hold the terminal still and release the SCAN key.
The touch screen flashes, and the captured image appears on the screen.
6. By default, the image is saved to the My Device folder.
To save the image to another location, tap **File > Save As**.

High-Vis Aiming Pattern

If your terminal is configured with the 5300SR imager, you can enable the aiming pattern for imaging in the Image Demo application.

1. Tap **Start > Demos > Imaging Demo > Options** menu > **Aimer**.
2. The aiming pattern is now enabled for imaging.

Uploading Images

Image files can be transmitted to a host workstation via

- Microsoft ActiveSync and a Dolphin communication peripheral
- Wireless radio: 802.11b/g and/or Bluetooth



System Settings

Overview

Customized settings are available on the Start menu. Tap **Start > Settings** and settings screen opens displaying the Personal tab. Settings consists of three tabs: Personal, System, and Connections.

Personal Tab



System Tab



Connections Tab



Tab	Description	See Page
Personal	Customizes buttons, set SIP options, and adjust headset settings.	6-2
System	Adjusts system settings.	6-7
Connections	Establishes network connections settings.	7-1

Personal Tab

To access the Personal tab, go to **Start > Settings**. The screen opens displaying the Personal tab.



Icon	Description	For more information...
Buttons	Program the side buttons to perform specific tasks.	See Buttons on page 6-3.
Input	Customizes the SIP.	See Input on page 6-4.
Lock	Password protect the terminal to limit access to the terminal.	
Menus	Customizes what appears on the Start menu.	See Menus on page 6-5.
Owner Information	Enter your contact information. This information will appear on the Today screen.	
Sounds & Notifications	Set the sound volume, enables and disables sounds for specific actions, and sets sound parameters for system notifications.	
Today	Customize the look and the information displayed on the Today screen.	

Note: Personal settings are stored in RAM memory. They are replaced by system defaults after each hard reset. For more information about resets, see [Soft Reset \(Warm Boot\)](#) on page 3-25.

Buttons

Buttons programs both keyboard buttons and the side buttons to launch applications or execute commands. The default button assignments that appear on the Buttons window are inactive until you enable the HotKeys Power Tool.

To Enable HotKeys

1. Tap **Start > Power Tools** and tap the HotKeys icon  **once**. HotKeys is enabled and the button assignments in the Buttons setting are active.
2. Verify the assignment by tapping the button on the keyboard.

For more information about the HotKeys Power Tool, refer to the Dolphin Power Tools User's Guide, which is available for download from the web at www.honeywell.com/aidc.

Button Assignments

By default, the side buttons (for locations, see page 3-12) activate the image engine but can be programmed to launch applications or execute commands in the Buttons setting.

1. After HotKeys is enabled, tap **Start > Settings > Personal tab > Buttons** .

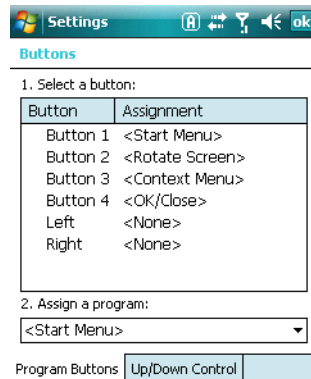

Note: The buttons that appear on this window are the only buttons that can be programmed via the Buttons setting. You cannot add buttons to this window.

2. To change button assignment, tap on the name of the application in the **Assignment** column and select a program or command in the **Assign a program** drop down list.
3. Tap **OK** to save.

Available Applications

The **Assign a program** list contains the applications installed on the terminal. If there is a program installed that you would like to see in this list, paste a Shortcut to the program in the `\\Windows\Start Menu\Programs` folder. For instructions about creating shortcuts, see [Using File Explorer](#) on page 6-5.

Additional Functions

The **Assign a program** list also contains the following commands:

Command	Description
<Input Panel>	Opens the soft input panel.
<None>	Nothing happens when the button is pressed. This is the default setting for the LSide and RSide buttons and means that pressing either button activates the image engine.
<OK/Close>	Performs the same function as tapping OK on the screen.
<Scroll Down>	Scrolls down in the open application.
<Scroll Left>	Scrolls left in the open application.
<Scroll Right>	Scrolls right in the open application.
<Scroll Up>	Scrolls up in the open application.
<Start Menu>	Opens the Start menu.
<Today>	Opens the Today screen.

Input

The Input settings enables you to customize input from the SIP, adjust word completion settings in Microsoft applications, and set defaults for voice recording.

Input Method



Word Completion

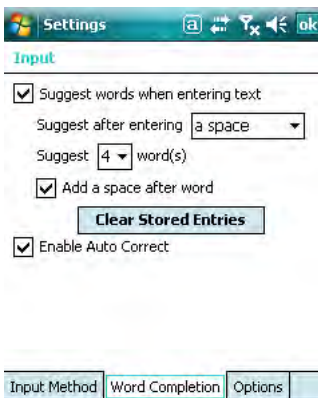

Options

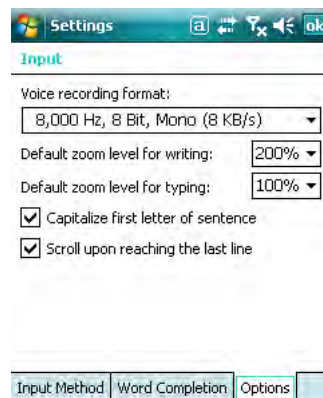

Menus

You can add existing programs you use often, such as File Explorer, to the Start menu for faster access. You are not installing the program, just allowing access to it from the Start menu.

To add programs to the Start menu, you can use

- The Menus setting on the Personal tab (see page 6-5),
- File Explorer (see page 6-5), or
- ActiveSync (see page 6-6).

Note: The Start menu can hold only seven applications at a time.

Using System Settings

1. Tap **Start > Settings > Personal tab > Menus** 

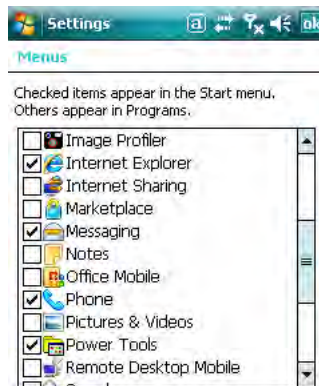

2. Tap the check box for the program you want to add and tap **OK** to save.

Note: If you try to go over seven applications, a warning message appears and you will have to delete applications as necessary.

3. Tap the **Start** menu to verify that the program appears on it.

Using File Explorer

If you do not see the program listed, you can either use File Explorer to move the program or ActiveSync on the workstation to create a shortcut to the program and place the shortcut in the Start Menu folder.

Note: We recommend that you Copy and Paste Shortcut so that you do not alter your program configurations by accident. Using Copy and Paste Shortcut (as opposed to Cut and Paste) ensures that the program files remain where they need to be for the system to find them to perform system functions.

1. Tap **Start > Programs > File Explorer**, and navigate to the program. File Explorer opens to My Documents by default; to see a list of all folders, tap the folder name and then **My Device**.

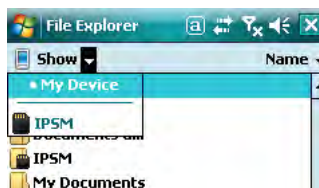

-
2. Tap and hold on the program, then tap **Copy** on the pop-up menu.
 3. Navigate to the Windows folder and open the Start Menu (My Device > Windows > Start Menu), tap and hold a blank area of the window, and tap **Paste Shortcut** on the pop-up menu.



4. Tap the **Start** menu to verify that the program now appears on it.

Using ActiveSync on the Workstation

Here, you are performing the same basic process as on the terminal, except that you are using the Explore utility (Windows Explorer) to copy and paste the shortcut.

1. Open **ActiveSync > Explore** and navigate to the program.
2. Right-click on the program and select **Create Shortcut**.
3. Select the shortcut, right-click, and select **Cut**.
4. Navigate to the **Start Menu** folder (Windows > Start Menu).
5. Right-click on an empty area and select **Paste Shortcut**.
6. On the terminal, tap the **Start** menu.
7. Verify that program appears.

System Tab

The System tab enables you to verify and sometimes alter system parameters. To access the System tab, go to **Start > Settings > System** tab. Tap the appropriate icon to open that system setting.



For details,

- See [About](#) on page 6-7.
- See [Backlight](#) on page 6-8.
- See [Certificates](#) on page 6-8.
- See [ClearType Tuner](#) on page 6-8.
- See [Clock & Alarms](#) on page 6-9.
- See [Encryption](#) on page 6-9.
- See [Error Reporting](#) on page 6-9.
- See [External GPS](#) on page 6-10.
- See [Memory](#) on page 6-10.
- See [Power](#) on page 6-12.
- See [Regional Settings](#) on page 6-12.
- See [Remove Programs](#) on page 6-13.
- See [Screen](#) on page 6-14.

About

The About system setting displays specific information about what is loaded on the terminal. It contains three tabs:

Version Tab	Displays the information about the software, operating system, and processor of the terminal.
Device ID Tab	Displays the information the terminal uses to identify itself to other devices. It can be important to know this information if the Dolphin terminal is going to be part of a networked system of devices. Device name: Displays the system's default name. (This is the name used by ActiveSync.) Description: Displays the description of the device ID.
Copyrights Tab	Displays important copyright information.

Backlight

The Backlight system setting enables you to customize backlight functionality for the display. The backlight for the color display is user-defined. Tap **Start > Settings > System tab > Backlight**.

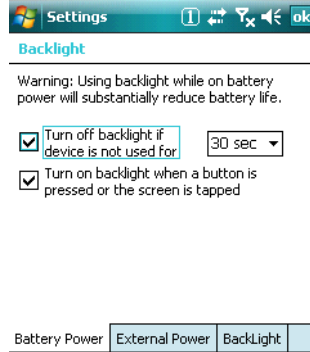

There are two tabs:

The Battery tab determines display backlight settings when the terminal is running on battery power.

The External tab determines display backlight settings when the terminal is running on external power.

The options on each tab are the same.

Turn off backlight: Select how many minutes you want to elapse before the backlight automatically turns off.

Turn on backlight: Select this option if you want the backlight to turn on when the a button is pressed or the touch screen is tapped.

Tap **OK** to save settings.

Backlight Intensity

Tap the Backlight tab and move the slider to set the intensity of the backlight. The default is 8.

Certificates

Certificates shows you which certificates are recognized by the operating system.



If the certificate does not appear on one of these tabs, then the operating system does not recognize it and you will not be able to use that certificate.

ClearType Tuner

This system setting enables you to adjust the level ClearType font rendering by moving a slider. The sample text displays the setting results immediately. Of course, you must first enable ClearType font rendering to change the appearance of fonts on the screen; see [ClearType Tab](#) on page 6-14.

Clock & Alarms

This setting sets the system clock, which means that all scheduled items run according to this setting. The time and date need to be reset after every hard reset of the terminal so that the system clock is accurate. On the Today screen, tap the line that displays the time and date,

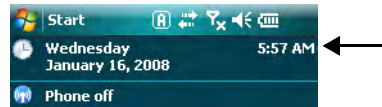

The Clock Settings screen appears. The selected time sets the system clock.



Encryption

Encryption gives you the option of encrypting files placed on storage cards so that those files cannot be read by any other device.



Error Reporting

Error Reporting gives you the option of enabling or disabling the error reporting function of Windows Mobile 6.

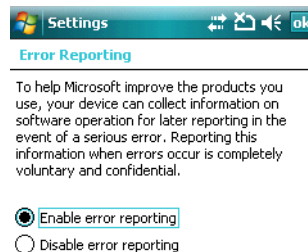

External GPS

If a Windows Mobile 6.0-based device is equipped with a GPS module, External GPS is a Microsoft tool that determines which port an external GPS software application can use.

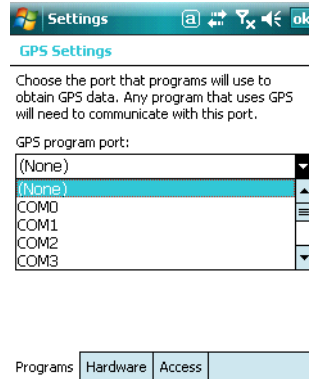

The Dolphin 7600 terminal is not equipped with a GPS module.

Memory

The Memory system setting displays capacity and usage statistics for both RAM (volatile) and IPSM/ Storage Card (non-volatile) memory. Access this setting whenever you receive system messages about memory.

You cannot change the terminal's memory allocation in the Memory system setting. To change the memory allocation, you need to use the SetRAM Power Tool (Start > Power Tools > SetRAM). For more details, please refer to the Honeywell Power Tools User's Guide, which is available for download from www.honeywell.com/aidc.

There are three tabs: Main, Storage Card, and Running Programs.

Main Tab

Settings
Memory

Storage	Program
Total: 13.58 MB	Total: 104.75 MB
In use: 6.36 MB	In use: 22.41 MB
Free: 7.22 MB	Free: 82.34 MB

Main Storage Card Running Programs

This tab displays the usage statistics of the on-board, volatile RAM memory.

Columns:

Storage=RAM memory used for storing programs and program data.

Program=RAM memory used to run programs.

Rows:

Total= Displays the current MB of memory allocated for use.

In use=Displays the total MB of that allocated memory in use.

Free=Displays the total MB of memory available.

Storage Card Tab

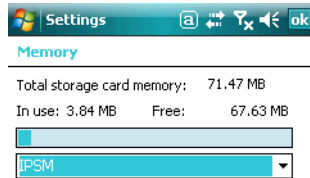

This tab displays the current capacity and usage statistics of the selected memory type; IPSM or Storage Card.

Select the memory type from the drop-down list. IPSM is selected by default.

Total storage card memory=The total MB of memory capacity of IPSM or Storage Card.

In use=The MB currently being used.

Free=The MB that is still available for use.

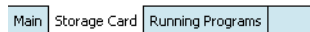

IPSM—Short for Internal Persistent Storage Manager, this is the on-board Flash memory that is non-volatile. Because this memory is non-volatile, data or programs stored in IPSM are not affected when power is removed. Autoinstall programs, for example, are stored in IPSM so that they are always installed at cold-boot startup.

Storage Card—You can install one memory card in Dolphin terminals (see [Access Door](#) on page 3-12). If a storage card is installed in the terminal, you can select it in the drop-down list and see capacity and usage statistics for the card.

Running Programs Tab

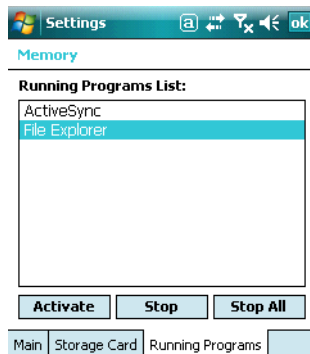

Displays the software programs currently using Storage memory.

Check this tab when you are receiving out of memory errors or when the mobile computer is running slowly.

You can

- Select a program in the list and tap **Stop** to stop it from running (and therefore from using memory), or
- Tap **Stop All** to automatically stop all running programs.



Anytime you stop a running program, it frees up RAM memory. Be advised that, when you stop a program here, any unsaved data in that program is lost. To free up memory without risking data loss, return to the running program, save your data, and close the application.

Power

Power system settings contains three tabs: Battery and Advanced.

Battery Tab

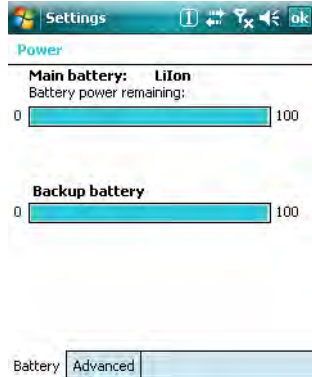

Displays the remaining charge of batteries.

For more information about the terminal's batteries, see [Battery Power](#) on page 3-21.

Advanced Tab



Determines power time-outs.

For **On battery power**, select from the drop-down list, the number of minutes of inactivity you want to pass before the terminal powers off when running on battery power.

For **On external power**, select from the drop-down list, the number of minutes of inactivity you want to pass before the terminal powers off when running on external power.

Note: You can also set automatic turn-off times for the terminal to conserve power. When the terminal is “turned off,” that means it’s in suspend mode; see [Suspend Mode](#) on page 3-26.

Regional Settings

Regional Settings enables you to customize the appearance and formatting to your geographic region. Specifically, you can customize numbers (i.e., number of decimal places allowed), currency (i.e., using the \$ or € symbol), time, and date. These specifications apply to all screens, including the Today screen. The Region tab displays an overview of the region selected in the drop-down list at the top.

The terminal is loaded with a number of pre-programmed regional settings. Select one from the list and the results appear on the screen.

To see specific settings or change a specific setting, tap on one of the tabs, make the change and tap **OK** to save it.

Remove Programs

Remove Programs enables you to remove programs installed on the terminal. Use this setting to troubleshoot when you receive messages that the terminal is out of memory. The programs removed are removed from RAM memory.

Any program (usually CAB or DLL files) stored in the Autoinstall folder (My Device > IPSM > Autoinstall) will re-install after the next hard reset. For information about the hard reset process, see [Hard Reset \(Cold Boot\)](#) on page 3-25.

1. Tap **Remove Programs**. In the list, select the program you want to remove.



2. Tap **Remove**. The following message appears:



3. Tap **Yes**. Wait while the program is removed.
4. Verify that the program no longer appears in the list.

Screen

The Screen system setting contains three tabs: Alignment, Clear Type, and Text Size.

Alignment Tab

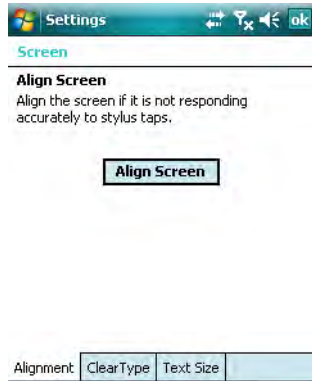

Orientation—The default orientation for the screen is Portrait. Select one of the Landscape options to change the screen orientation.

Align Screen—You need to re-align the screen if tapping buttons or icons with the stylus no longer seems to work appropriately. Tapping Align Screen brings up the align screen window where you are guided to tap a target several times. This re-calibrates how the touch screen receives input.

ClearType Tab



The display supports ClearType font rendering, which is a Microsoft technology that dramatically increases the readability of text on LCD displays.

To enable ClearType font rendering, select **Enable ClearType** and tap **OK**. To adjust the level of ClearType font rendering, use the ClearType Tuner; see [ClearType Tuner](#) on page 6-8.

For more information about ClearType font rendering, visit: www.microsoft.com/typography/cleartype/what.htm?fname=%20&fsize=

Text Size Tab

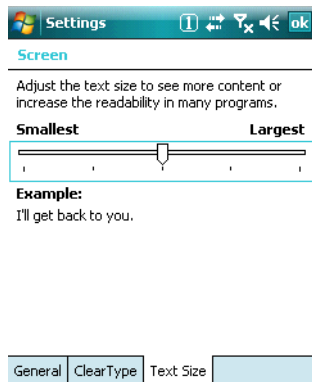

The Text Size tab enables you to perform font scaling within certain views of the Today screen, Contacts, Calendar, Messaging, and Tasks. This means that you can increase or decrease the point size of the font on application windows.

This is the default font size setting. To change the font size, move the slider toward **Smallest** or **Largest**. The Example text changes to reflect the font change. Tap **OK** to save the new font size setting.

Connecting the Terminal

Connections Tab

The Connections system setting provides access to the terminal's various communication options.



Icon	Description	See Page
Beam	Controls whether or not the terminal can receive data via IrDA.	7-3
Bluetooth	Configures the Bluetooth connection. This icon appears only if a Bluetooth radio and driver is installed on the terminal.	8-1
Connections	Opens Microsoft's connections manager.	7-4
Dolphin Wireless Manager	Manages the wireless radios installed in the terminal.	7-6
Network Cards	Manages the network drivers installed in the terminal.	7-9
USB to PC	Offers additional USB options.	7-10

Infrared Communication

Using the IrDA port, you can send and receive data between the terminal and other devices equipped with infrared. This can include, but is not limited to, Windows Mobile information such as Contacts and Tasks, as well as software upgrades.

The maximum data transfer speed is 115 Kbps.

IrDA Port Location

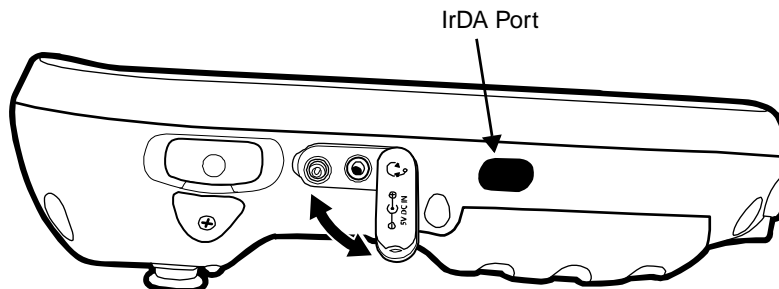

To send or receive, the IrDA ports of both devices - whether it's two terminals, or a terminal and a host device - must be aligned with each other and within a close range. The maximum data-transfer speed is 115 Kbps.

Sending Data

1. Align the IrDA ports.
2. Open the program where you created the item you want to send and locate the item in the list. You can also beam files, but not folders, from File Explorer.
3. Tap and hold the item and select **Beam File**.

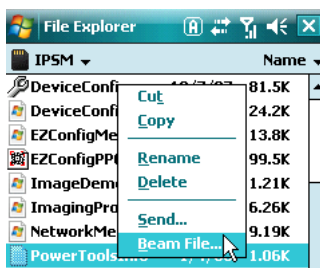

4. The IrDA port searching for a receiving IrDA port in the vicinity. The selected device reads "Pending."

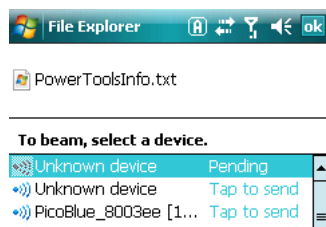

-
- When the IrDA port finds the IrDA port of the other device, it immediately starts sending the selected file. The selected device reads “Sending.”

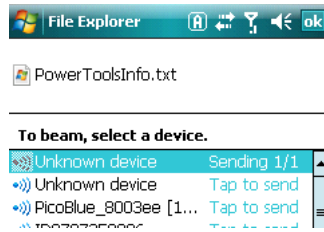

- When the file transfer is complete, the selected device reads “Done.”

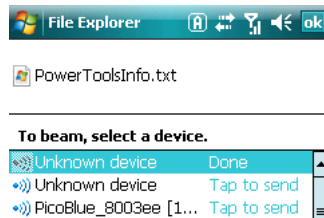

Receiving Data

The Beam Setting must be set to receive for the terminal to receive data from other infrared devices.

- Verify that beam settings are set to receive. Tap **Start > Settings > Connections** tab > **Beam**. The Beam Settings window should appear as follows:

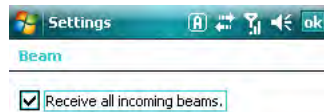

- Align the IrDA ports.
- Have the owner of the other device send the information to you.
- Your terminal automatically begins receiving it.
- A popup message appears asking if you want to receive the incoming file.

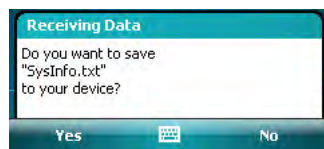

- Tap **Yes** to receive the file.

Connections Manager

The connections manager sets up various network connections to Internet Service Providers (ISPs) via external modem.

To open the connections manager, tap **Start > Settings > Connections** tab > **Connections** icon  Connections -



Server-Assigned IP Addresses

All server-assigned IP addresses use Dynamic Host Configuration Protocol (DHCP).

Zero-Config Wi-Fi

The zero-config Wi-Fi feature of Windows Mobile is **disabled** on Dolphin 7600 terminals. If you are using one of the on-board wireless radios to connect to a network, do **not** enter network parameters in the connections manager. The Dolphin terminal uses the radio's settings to connect to the network.

Task Tab

The Task tab enables you to initially configure, then manage network settings when using a modem. Select an item in this list and then complete the setup screens that follow with the appropriate information for your network.

My ISP

The links under this heading enables you to add and manage modem connections to an ISP. To complete the setup screens, obtain the following information from your ISP:

- ISP dial-up access telephone number
- Username
- Password
- TCP/IP settings

My Work Network

These links enable you to establish the following connections types:

- Modem
- Virtual Private Network (VPN)
- Proxy server connection

To complete the setup screens, obtain the network parameters from your system administrator.

Proxy Server Connections

If you are connected to your ISP or private network during synchronization, the terminal should download the proper proxy settings during synchronization with the PC. If these settings are not on your PC or need to be changed, ask your ISP or network administrator for the proxy sever name, server type, port, type of Socks protocol used, and your user name and password.

Modify an Existing Connection

Manage Existing Connections appears on the Connections tab after at least one network connection has been established. Tap Manage Existing Connections on this tab and follow the setup screens. You



will usually be walked through the same setup screens used to establish the connection.

Advanced Tab

The Advanced tab enables you to select the default network, dialing rules, and IP address exceptions for modem connections.

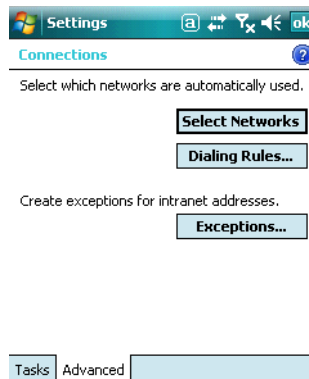

Note: You should not need to change Advanced settings because most ISPs now use DHCP addresses.

Online Help

For more information about modem connection setup, consult the online help on the setup screens by tapping the Help icon .

Dolphin Wireless Manager

The Dolphin Wireless Manager provides a centralized interface that enables and disables all the on-board radios. Each radio has its own configuration program and the Dolphin Wireless Manager also provides shortcuts to the configuration utilities for each radio.

There are two radio options: 802.11b/g and Bluetooth.

- 1. 802.11b/g** The WLAN radio is configured in the Honeywell WLAN Secure Wireless Client (SWC). Refer to the Honeywell WLAN SWC User's Guide, which is available for download from the 7600 product page at www.honeywell.com/aidc.
- 2. Bluetooth** See [Working with the Bluetooth Radio](#) on page 8-1.

Dolphin Wireless Manager Window

Tap **Start > Settings > Connections tab > Dolphin Wireless Manager**  .
Each rectangle represents a radio.

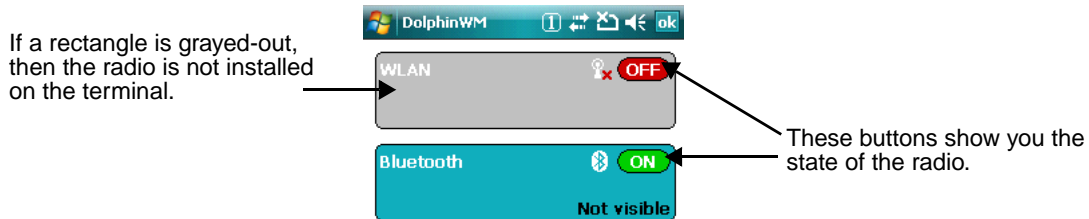

Enabling the Radios

1. Tap **Start > Settings > Connections tab > Dolphin Wireless Manager**  .

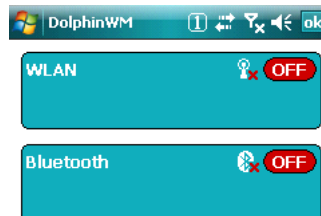

2. Tap anywhere inside the rectangle or the **OFF** button inside the rectangle. The radio begins activating.



3. When the radio is activated (i.e., transmitting a signal), the **OFF** button changes to **ON**.



Note: If applicable, information about the radio appears in the rectangle.

Accessing Radio Configuration Utilities

Each of the three radios have their own configuration utilities that you can access through the **Menu**.

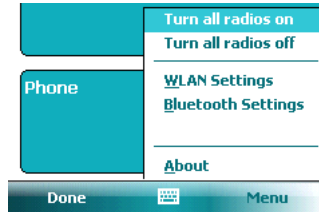

For **802.11b/g**

Tap **WLAN Settings** to open the SWC and configure the radio. Refer to the Honeywell WLAN SWC User's Guide, which is available for download from the 7600 product page at www.honeywell.com/aidc.

For **Bluetooth**

Tap **Bluetooth Settings** to open the Bluetooth Manager and configure the radio (see page 8-1).

Icons in the Navigation Bar

Icons that indicate radio functionality appear in the Navigation bar. For a complete listing, see [Icons in the Navigation Bar](#) on page 2-3.

COM Port Assignment Table

COM Port	Description
COM0	Unused
COM1	Serial Port: RS-232 Connector on the bottom panel
COM2	Not accessible
COM3	IrDA: Serial Infrared (SIR) up to 115 Kbps
COM4	Not accessible
COM5	Bluetooth DUN
COM6	IrCOMM
COM7	Unused
COM8	USB Serial: Virtual USB Serial port for ActiveSync
COM9	Bluetooth BTHATCI server

Network Cards

The Network Cards setting displays the network cards installed in the terminal.

1. Tap **Start > Settings > Connections > Network Cards**.

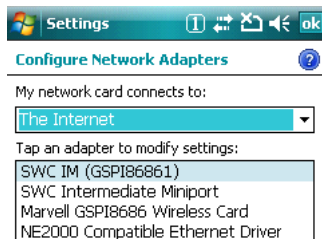

2. Tap on an adapter in the list to review its settings. (Server-assigned IP addresses use DHCP.)



3. If you make a change on one of these tabs, tap **OK** to confirm the changes.
4. You must perform a soft reset to update the registry entries; see [Soft Reset \(Warm Boot\)](#) on page 3-25. During the soft reset, the new registry entries are created and can be read by the applications that need them.

 Do NOT perform a *Hard Reset (Cold Boot)* (see page 3-25) after modifying an adapter here. Hard resets return the terminal to factory defaults, which erases network adapter modifications made here.

USB to PC

The USB to PC applet enables you to switch between RNDIS (Remote Network Driver Interface Specification) USB and Serial USB communication.

Dolphin 7600 terminals default to Serial USB. Honeywell recommends using Serial USB.

To change this setting, tap **Start > Settings > Connections** tab > **USB to PC** . The enable option is not selected, which indicates Serial USB.

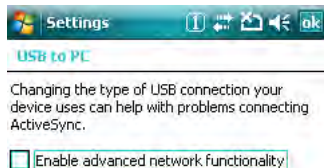

To switch to RNDIS USB, select **Enable advanced network functionality** and tap **OK** to save. (Wait as the terminal makes the change.)

Installing Additional Software

Dolphin terminals ship with the operating system, radio drivers, and custom Honeywell software already installed. These default programs install when your terminal first boots up. You can install additional software programs to the terminal provided that the following parameters are met:

- The software program was created for the Windows Mobile platform.
- The terminal has enough memory to store and run the program.
- The program has an EXE, CAB, or DLL extension.

When selecting programs, verify that the program and version of the program are designed for the Windows Mobile 6 and the terminal's processor.

You can verify your processor by tapping **Start > Settings > System tab > About > Version** tab. Make a note of the information in the **Processor** field.

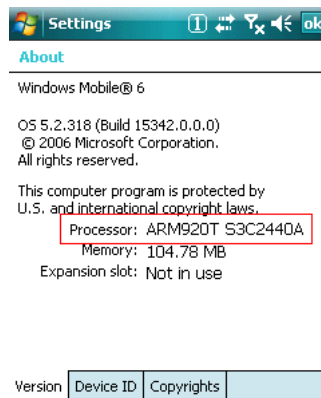

To install additional software, you can use the communication options described in this chapter.

- [Adding Programs via ActiveSync](#), page 7-11.
- [Infrared Communication](#), page 7-2.

Adding Programs via ActiveSync



When selecting programs, verify that the program and version of the program are designed for the Windows Mobile 6 and the terminal's processor. You can verify your processor by tapping Start > Settings > System tab > About > Version tab. Make a note of the information in the Processor field.

Generally, software for Windows Mobile-based devices must be installed to the host workstation first, then transferred to the terminal.

1. Download the program to the workstation from either the Internet or the install CD. You may see a single EXE or setup.exe file, a CAB file, or DLL. (There may also be several versions of files for different device types and processors.)
2. Read any installation instructions, Read Me files, or documentation that comes with the program. Many programs provide special installation instructions.
3. Connect the terminal to the workstation via Honeywell communication peripheral.

If the File is an Installer

An installer program is one that installs to the workstation and the terminal simultaneously when the workstation and the terminal are connected via ActiveSync; one process installs to both devices.

1. On the workstation, double-click the EXE or setup.exe file. The installation wizard begins.
2. Follow the directions on the workstation screen.
The installation process includes transferring the software to the terminal via ActiveSync.

If the File is Not an Installer

Some programs cannot be installed on workstations because they are designed exclusively for Windows Mobile-based devices. In these cases, the appropriate files must be stored on the host workstation and transferred to the terminal via ActiveSync Explore.

Note: You know that the program is not an installer because an error message stating that the program is valid but designed for a different type of computer appears when you try to install the program on the workstation.

1. If you cannot find any installation instructions for the program in the Read Me file or documentation, open **ActiveSync** on the workstation and click **Explore**.
2. On the workstation, navigate to the workstation folder containing the program file(s) and copy them to the **Program Files** folder on the terminal.
If you want the program to persist through hard resets, past the program to the **Autoinstall** folder (`\IPSM\AutoInstall`).
3. On the terminal, tap **Start > Programs > File Explorer** and navigate to the folder where the program is located.
4. Double-tap on the program file to install it.
If you copied the file to the **Autoinstall** folder, you can choose to install the program by performing a hard reset. The program installs as part of initialization.
5. After installation is complete, access the program by tapping **Start > Programs** and the program appears on the Programs screen.
6. Tap the icon to open the program.

Adding Programs From the Internet

When you have established a network connection (whether via modem or wireless radio), you can access the Internet and download additional software programs.



*When selecting programs, verify that the program and version of the program are designed for Windows Mobile 6 and the terminal's processor. You can verify your processor by tapping **Start > Settings > System tab > About > Version tab**. Make a note of the information in the Processor field.*

1. Open Internet Explorer and navigate to the program's location. You may see a single EXE or setup.exe file, or several versions of files for different device types and processors.
2. Select the program version that matches your Dolphin terminal and processor.
3. Read any installation instructions, Read Me files, or documentation that comes with the program. Many programs provide special installation instructions.
4. Download the program to the terminal straight from the Internet.
You would normally store the program in the **\Program Files** folder unless another location is required by the program.
5. On the terminal, double-tap the installer file; e.g., the EXE file.
6. The installation wizard for the program begins.
7. Follow the directions on the screen to complete installation.

Working with the Bluetooth Radio

Enabling the Bluetooth Radio

You enable the Bluetooth radio in the [Dolphin Wireless Manager](#) (see page 7-6).

1. Tap **Start > Settings > Connections tab > Dolphin Wireless Manager** 

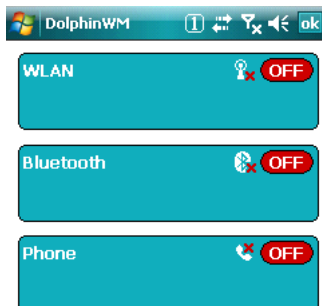

2. Tap anywhere inside the Bluetooth rectangle and Bluetooth begins activating.



3. When the radio is activated (i.e., transmitting a signal), the **OFF** button changes to **ON**.



Now, the Bluetooth radio is transmitting a signal. Additional text in the Bluetooth section tells information about the Bluetooth radio. "Visible" and "Not visible" indicates whether the Bluetooth radio is discoverable or not discoverable by other Bluetooth devices.

Now, you can connect to other transmitting and discoverable Bluetooth devices (see page 8-2).

To make the terminal discoverable for other Bluetooth devices to find, you need to make the Bluetooth radio discoverable (see page 8-8).

Icons in the Navigation Bar

Icons that indicate radio functionality appear in the Navigation bar. For a complete listing, see [Icons in the Navigation Bar](#) on page 2-3.

Connecting to Other Bluetooth Devices

You need to perform a device discovery and then select a discovered device and connect to it. Pairing happens as part of the connection process.

1. In the Dolphin Wireless Manager, tap **Menu > Bluetooth Settings**.

OR

Tap **Start > Settings > Connections tab > Bluetooth**  **Bluetooth**.

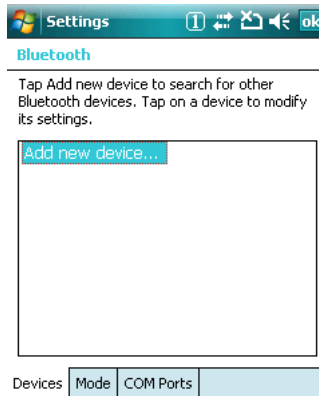

2. Tap **Add new device**. The terminal begins searching for discoverable Bluetooth devices.



3. Select a device in the list and tap **Next**.



4. You are prompted to enter a passcode.



If the device has a specific passcode, enter it in the **Passcode** field and tap **Next**.
If the device does not have a specific passcode, enter one in the **Passcode** field and tap **Next**.

The Bluetooth radio tries to connect with the device.



5. If you created a passcode, you will be prompted by the other device to enter the same passcode. Enter the created passcode to establish a paired connection. (If you entered a the passcode from the device, you shouldn't have to do anything on the other device.)
6. When the connection is complete, a list of matching and supported services on the device appears.

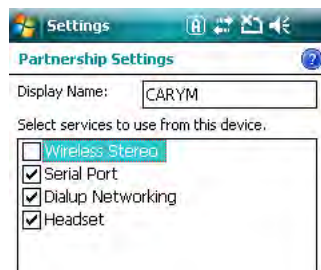

7. Select the services you want to use and tap **Finish**.
The services on the new devices have to be selected or else the pairing won't include those services, even though the devices are paired. If services are not selected, you will be continually re-prompted for the passcode from the device.

-
8. The device appears in the list on the main window.



9. After the passcodes have been accepted on both sides, you have a trusted (“paired”) connection.

Pairing and Trusted Devices

The terminal does support pairing. Pairing happens during general connection setup. Paired devices are "trusted" devices. This means that there is unrestricted access to all services (including services that require authorization and authentication).

A connection can exclude pairing. A device that is connected to the terminal but not paired with it is considered an untrusted device. Content can still be passed to untrusted devices by requiring authorization with each attempt (for example, with the initialization of a file exchange). The Beam File method of file transfer on the can be used to pass a file as an untrusted device; see [Transferring Files](#) on page 8-7.

Types of Devices and Services

When you tap **Add new device** on the Devices tab, the Bluetooth radio scans for discoverable Bluetooth devices in range, which are Bluetooth devices that have been made discoverable.

Device Types

The types of devices in the vicinity of the radio appear in the list of discovered devices.

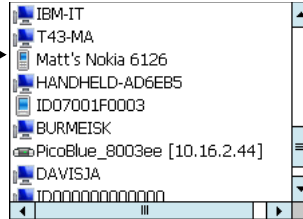

Supported Services

Only the services that are mutually supported on both devices appear on the Partnership Settings window.



Connecting to Bluetooth Printers

1. Make sure the Bluetooth printer is in range and set to be discoverable by other Bluetooth devices.
2. Look up the Bluetooth printer's broadcasted ID.
3. Perform a device discovery (Tap **Settings** > **Connections** > **Bluetooth** > **Add new device.**)
4. Look for the Bluetooth printer's broadcasted ID in the list of discovered devices.
5. Click on the Bluetooth printer's ID and wait for the prompt to enter a **Passcode**.
6. If required, enter the **Passcode** and tap **Next**.
The passcode may default to either "1111" or "0000." If there is no default, consult the printer literature for the number.
7. Select a printing-related service in the list of services.
8. Tap **Finish** to establish the connection on the terminal.
9. Complete any additional steps required by the printer.

Connecting to Bluetooth Headsets

1. Make sure the Bluetooth headset is in range and set to be discoverable by other Bluetooth devices.
2. Look up the headset's broadcasted ID.
3. Perform a device discovery (Tap **Settings** > **Connections** > **Bluetooth** > **Add new device.**)
4. Look for the headset's broadcasted ID in the list of discovered devices.
5. Click on the headset's ID and wait for prompt to enter a passcode.
6. If required, enter the **Passcode** and tap **Next**.
The passcode may default to either "1111" or "0000." If there is no default, consult the printer literature for the number.
7. Select **Headset** in the list of services.
8. Tap **Finish** to establish the connection on the terminal.
9. Complete any additional steps required by the headset.

Transferring Files

1. Tap **Start > Programs > File Explorer**.
2. Navigate to the file you want to transfer.
3. Tap and hold on the file and select **Beam File** on the popup menu.

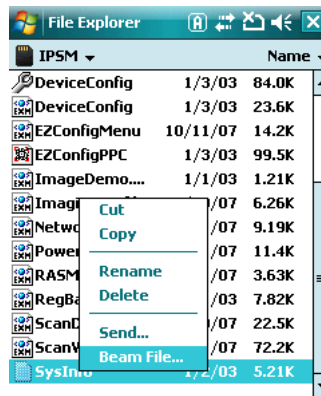

4. The Bluetooth radio begins searching for devices.

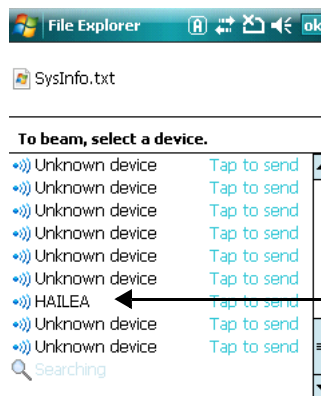

When a Bluetooth device is first found, it appears as an Unknown device; the  icon indicates that the device is a Bluetooth device.

As data is retrieved, the device IDs appear in the list.

5. Tap the device to begin sending the selected file.

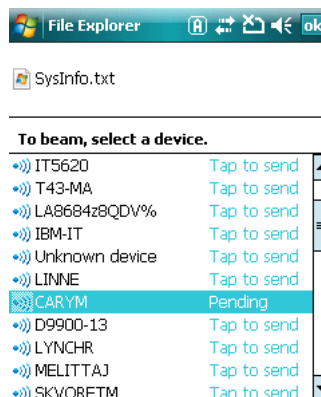

6. While trying to connect, the selected device reads "Pending."
7. When the file is being transferred, the selected device reads "Sending."

Making the Terminal Discoverable

By default, the Dolphin terminal is not discoverable, which means that the terminal will not be found by other Bluetooth devices.

To make the terminal discoverable, tap the **Mode** tab on the Bluetooth Settings window.



Select **Make this device visible to other devices** and tap **OK**.

Dolphin HomeBase Device

Overview

The Dolphin HomeBase device is a charging and communication cradle that supports full-speed USB 1.1 communication with a workstation. You can also purchase a serial RS-232 HomeBase device.

Battery Charging

The HomeBase device completes a full charge of the main battery pack in less than four hours.

In addition to charging, the HomeBase device powers the intelligent battery charging system in the terminal that protects the battery from being damaged by overcharging. The terminal senses when a battery pack is fully charged and automatically switches to a trickle charge that maintains the battery at full capacity.

As a result, terminals may be stored in the HomeBase device indefinitely without damage to the terminals, battery packs, or peripherals.

Communication

The HomeBase device can communicate via USB or serial RS-232. Data transmission for USB is up to 12 Mbps. Data transmission for serial RS-232 is up to 115 Kbps.

HomeBase devices cannot be physically connected to each other—sometimes referred to as “daisy-chaining”—but can be networked together via serial or USB hubs.

Convenient Storage

The battery charging system makes the HomeBase device a safe and convenient storage receptacle for your terminal.

Capacity

The HomeBase device holds one terminal and charges its battery pack.

Power Supply

The power cable that ships with each unit also powers the HomeBase device.



Use only the peripherals, power cables, and power adapters from Honeywell. Use of peripherals, cables, or power adapters not sold/manufactured by Honeywell may cause damage not covered by the warranty.



Use only the Li-ion battery packs provided by Honeywell. Use of any battery not sold/manufactured by Honeywell may result in damage not covered by the warranty.

Front Panel

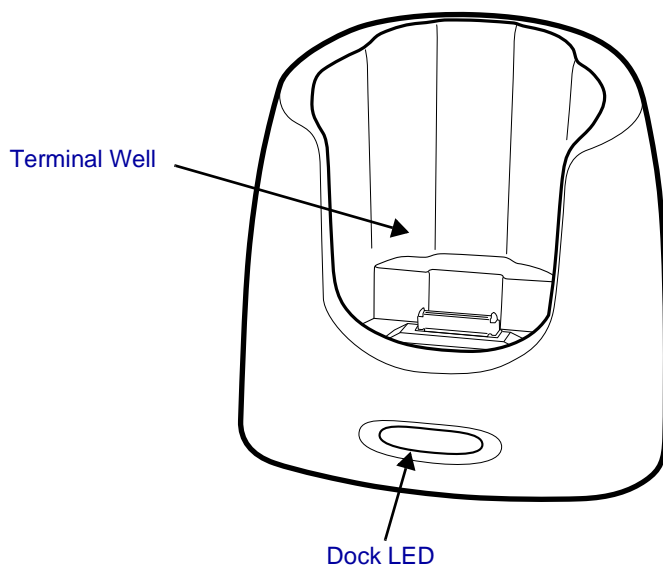

Terminal Well

Place the terminal in this well to communicate with a host device, power the terminal, and charge its battery.

Dock LED

Turns solid green when the terminal is properly seated in a powered HomeBase device. When this light is on, the terminal is connected to the HomeBase device.

Rubber Feet

The bottom panel has four rubber feet—one at each corner—to stabilize the unit on a flat surface. You can set the HomeBase device on a dry, stable surface, such as a desktop or workbench near an electrical outlet.

Back Panel

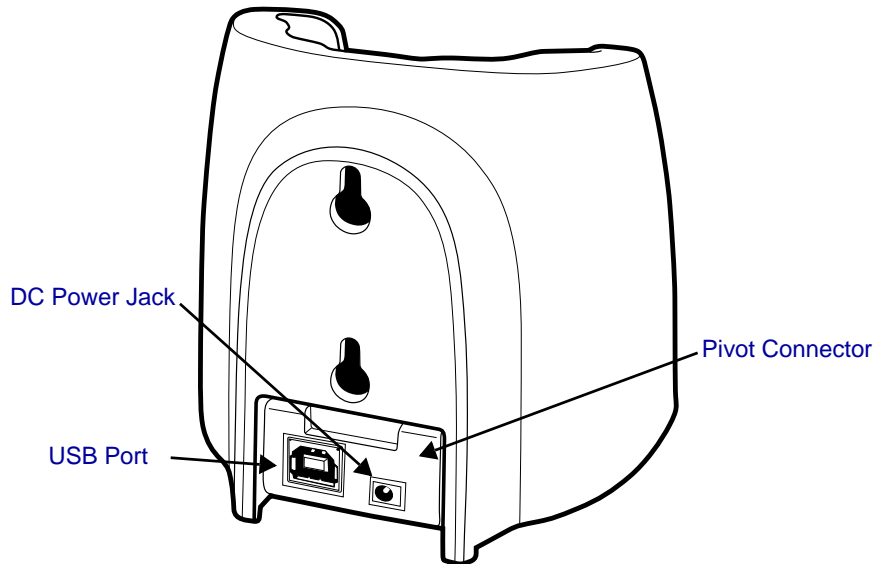

Pivot Connector

This pivoting connector swivels 90 degrees. The default position is horizontal, with the connectors facing straight out the back panel. The pivot connector stops in both the horizontal and vertical positions, with the connectors facing out the bottom panel.

DC Power Jack

Connect the power cable to this power jack; see [Powering the HomeBase Device](#) on page 9-4.

USB Port

This USB port is full-speed (v1.1). Using the USB cable, you can connect the HomeBase device to a USB-compliant device to facilitate USB communication to and from the terminal. USB communication occurs through Microsoft ActiveSync (v.4.5 or higher). For more information about ActiveSync setup, see [ActiveSync Communication](#) on page 3-18.

Note: You can also purchase a serial HomeBase with a standard DB9 connector for RS-232 communication.

Powering the HomeBase Device

The terminal requires 5 volts DC input for communication and battery charging; the power adapter on the power cable converts the voltage from the power source to 5 volts DC. Only power adapter cables from Honeywell convert the voltage appropriately.

The same power cable that ships with each terminal can be used to power the HomeBase. This cable contains a plug adapter for each geography (US, UK, EU, etc.).

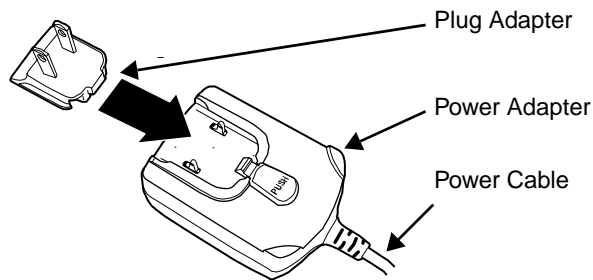

1. Attach the appropriate plug adapter to the power adapter.
2. Plug the power cable into the power source.
3. Plug the connector into the DC power jack on the back panel. The HomeBase is now powered.

When a terminal is properly seated in the terminal well, the HomeBase powers the terminal, charges the terminal's main battery pack, and launches ActiveSync (see [ActiveSync Communication](#) on page 3-18).

Honeywell recommends that you leave the HomeBase connected to its power source at all times, so that it is always ready to use.

Charging the Main Battery

The HomeBase powers the terminal and fully charges its main battery pack in less than four hours.

As battery packs charge, the charging circuitry follows the two-step charging process (CC-CV) that is recommended for Li-Ion batteries. The process monitors changes in temperature, current, and voltage.

Inserting a Terminal

1. Install the battery pack in the terminal; see [Install the Main Battery](#) on page 2-1.
2. Power the Dolphin HomeBase device; see [Powering the HomeBase Device](#) on page 9-4.
3. Slide the terminal into the terminal well until the Dock LED lights green to indicate that the terminal is properly seated.
4. The battery pack begins charging.

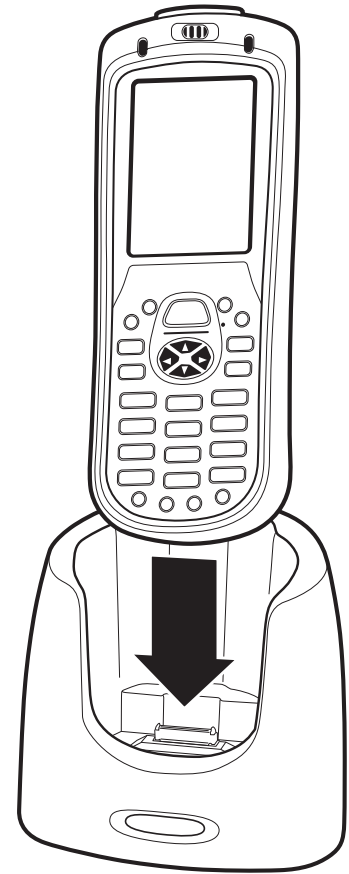

Checking Battery Power

To check battery power while the terminal is operating,

tap **Start** > **Settings** > **System** tab > **Power**  **Power**.

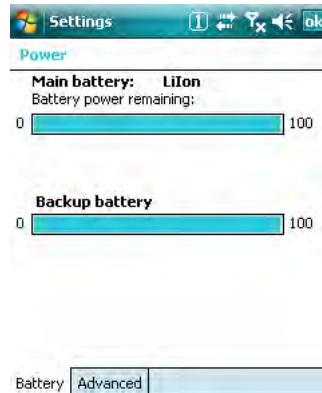

Mounting the Dolphin HomeBase Device

If you want to mount the HomeBase to a vertical surface, be sure to provide enough workspace with good lighting for the user to view and operate the Dolphin terminal while it is seated in the HomeBase.

Back Panel Dimensions

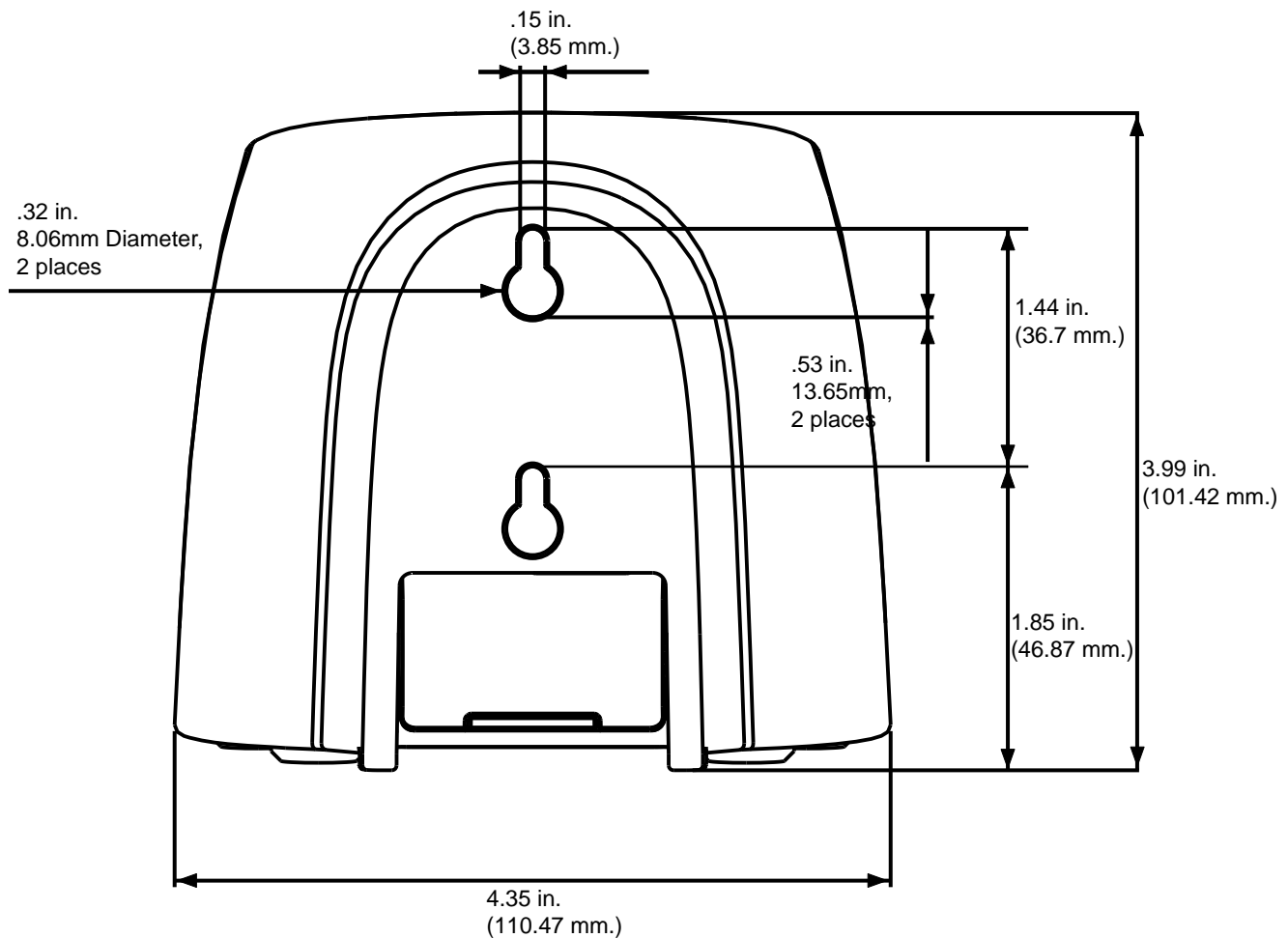

Mounting Guidelines

1. Before you begin, make sure you have two screws that are size #4—diameter measurement of 0.112 in. (2.845 mm).
2. Drill two holes into the wall. The holes should be located approximately 1.44 in. (36.7 mm) apart.
3. Insert a screw into each hole, leaving 0.2 in. (5 mm) of its head exposed.

Bottom Panel Dimensions

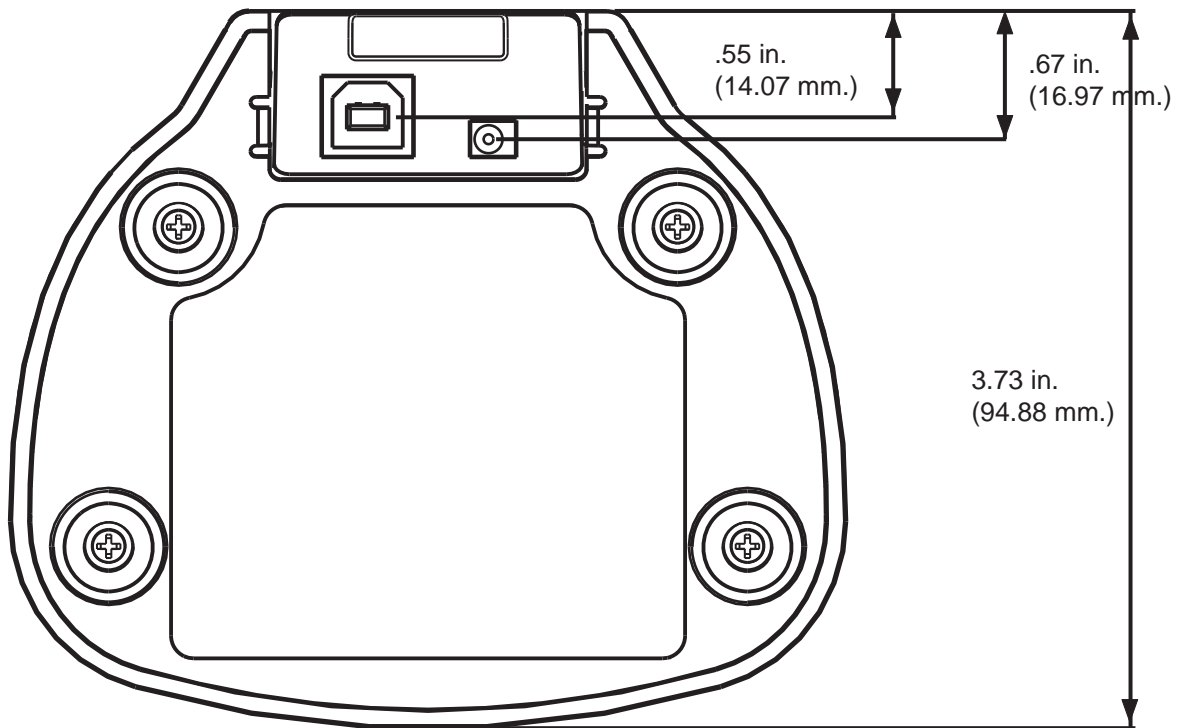

Note: The pivot connector should be facing straight out the bottom panel (as shown) when mounting the HomeBase to a vertical surface.



Dolphin QuadCharger Device

Overview

The Dolphin QuadCharger device is a four-slot charging station that charges up to four Li-ion battery packs in four hours. For more details about charging, see [Battery Charging](#) on page 10-3.

 Use only the peripherals, power cables, and power adapters from Honeywell. Use of peripherals, cables, or power adapters not sold/manufactured by Honeywell may result in damage not covered by the warranty.

 Use only the Li-ion battery packs provided by Honeywell. Use of any battery not sold/manufactured by Honeywell may result in damage not covered by the warranty.

Front Panel

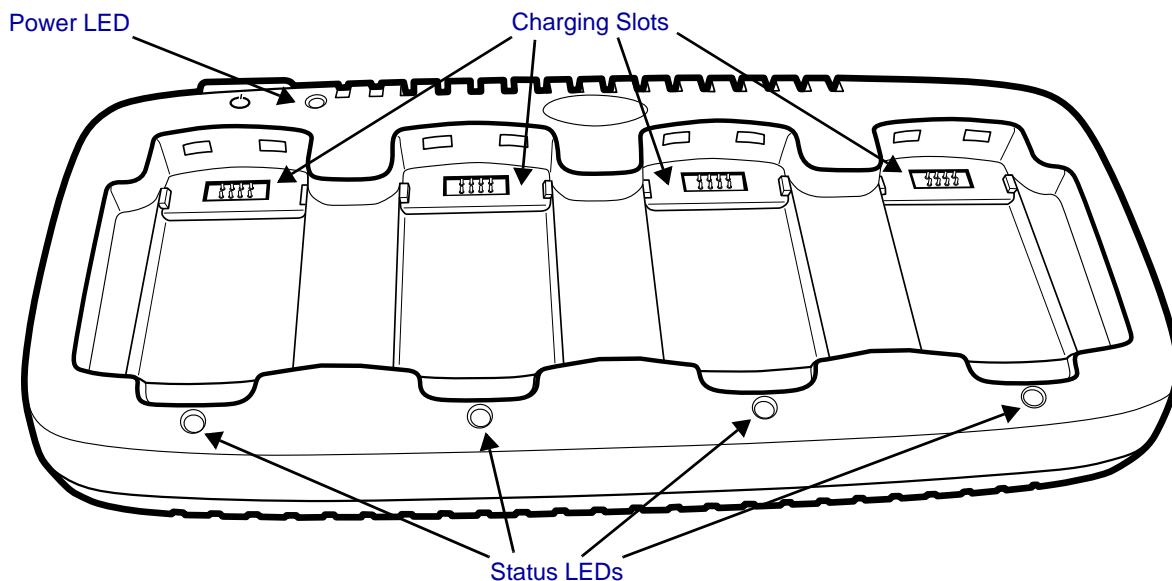

Charging Slots

The QuadCharger device contains four charging slots. Each slot holds one battery. When a battery is placed in a slot, it immediately begins charging and its Status LED lights.

Power LED

This LED lights green after power has been applied and the QuadCharger device has completed initialization.

Status LEDs

A status LED is located above each of the four battery slots. The color of the LED indicates the charge status of the batteries in the slot.

Green (solid)	The battery has completed its charge cycle and is ready for use.
Orange (solid)	The battery is properly seated and charging.
Red (flashing)	An error occurred during the most recent charge cycle.

Back Panel

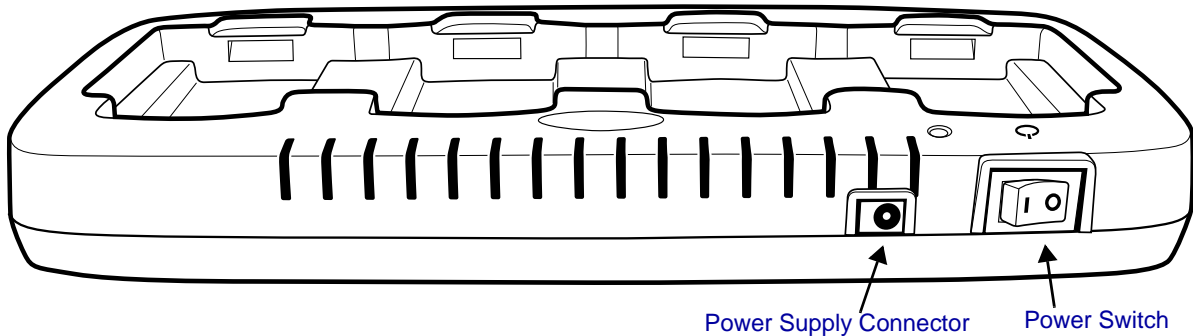

Power Supply Connector

Use this connector to attach the power supply to the QuadCharger device. The universal power supply accepts input voltages between 90-265 volts.

Power Switch

Toggle the power switch to turn the QuadCharger device on and off.

Supplying Power to the QuadCharger Device

Use the power adapter cable that comes with the QuadCharger device so that the input voltage is adjusted appropriately.

1. Locate the AC power adapter cable and plug it into the power source.
2. Connect the power cable to the power adapter.
3. Connect the power cable to the power supply connector on the back of the QuadCharger device.
4. Press the power switch to the ON position.
5. The device performs the following power-up diagnostic routine for each slot indicated by the Status LEDs:
 - All ON Orange
 - delay (500ms)
 - All ON Red
 - delay (500ms)
 - All ON Green
 - delay (500ms)
 - All OFF

Battery Charging

Inserting and Removing Battery Packs

To insert a battery pack, place the end of the battery without the locking tab into the bottom of the charging pocket and snap the battery into place with a hinging motion.

To remove a battery pack, push the locking tab down and pull the battery away from the charging slot with a hinging motion.

Charging Process

The QuadCharger device charges Li-ion battery packs in four hours. Each charging slot works independently of the other three. As battery packs charge, the charging circuitry follows the two-step charging process (CC-CV) that is recommended for Li-Ion batteries. The process monitors changes in temperature, current, and voltage.

Temperature

The QuadCharger device charges Li-ion battery packs in four hours when charged within the recommended temperature range of 50° to 95° F (10° to 35°C). Temperature has a significant effect on charging. For best results, battery packs should be at room temperature before inserting in the QuadCharger device.



When the battery temperature exceeds 40°C, the QuadCharger device may exceed the stated four-hour charge time. The QuadCharger device stops charging if the battery temperature is greater than 40°C but will begin charging again when the battery temperature is less than 40°C.

To Charge Batteries

1. Supply the QuadCharger device with power and turn the power switch on.
2. Insert batteries into the appropriate slots.
The Status LED for each slot turns orange to indicate that the battery is properly seated and has begun a charge cycle.
3. When the Status LED turns green, the battery in the slot has completed charging.

Recommendations for Storing Batteries

To maintain top performance from batteries, follow these storage guidelines:

- Avoid storing batteries outside of the specified temperature range of -4 to 122° F (-20 to 50°C) or in extremely high humidity.
- For prolonged storage, do not keep batteries stored in a charger that is connected to a power source.

Mounting the QuadCharger Device

The QuadCharger device should be mounted on a dry, stable surface such as a desktop or workbench, or a flat, vertical surface such as a wall.

Mounting Location

When choosing a location for the QuadCharger device:

- Keep in mind that the mounting location must allow users easy access to power switch and power connector.
- Do NOT place the QuadCharger device in an enclosed space because restricted air flow can cause the temperature to elevate, which can effect charging. For more information, see [Battery Charging](#) on page 10-3.

Mounting Process

To mount the QuadCharger device, slide the DIN Rail into the slot on the bottom panel. Then, using the appropriate nuts and bolts, secure the DIN rail to the desk or wall.

Bottom Panel Mounting Dimensions

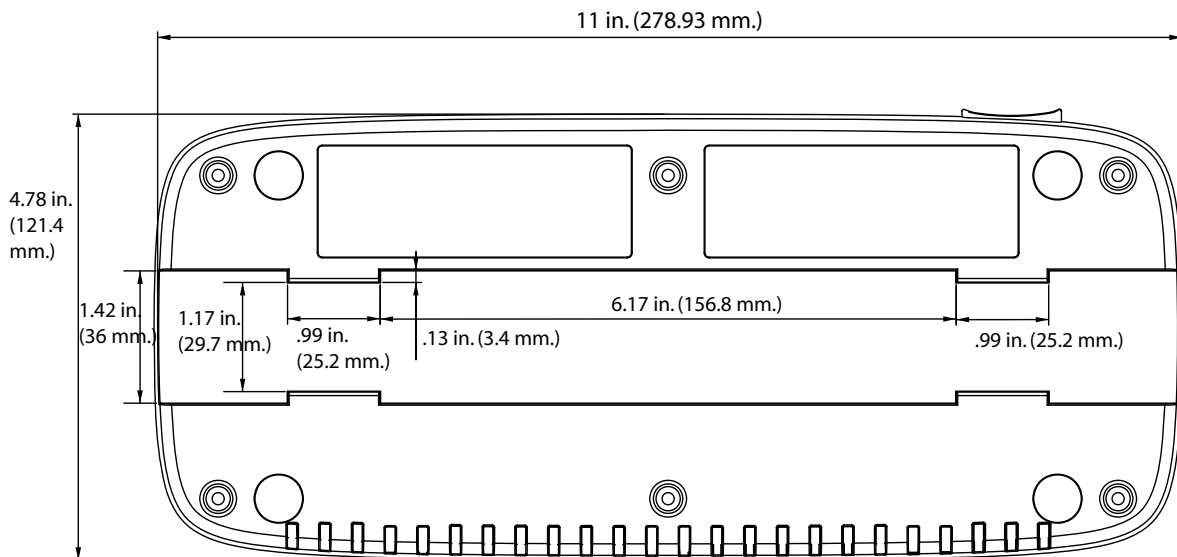

DIN Rail Dimensions

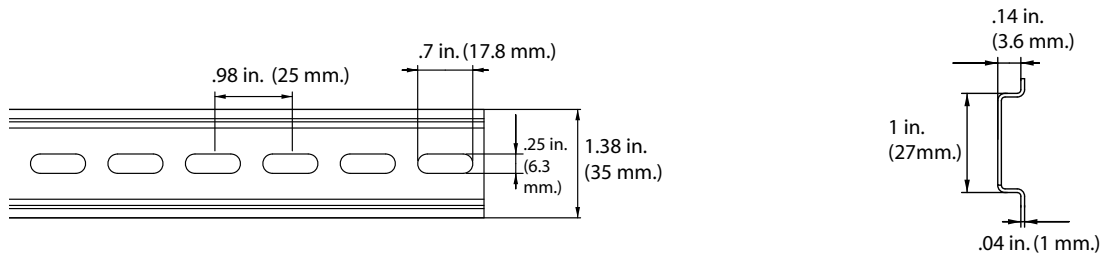

Mounting Guidelines

1. Before you begin, make sure you have two screws that are size #5—diameter measurement of 0.125 in. (3.18 mm).
2. Drill two holes into the wall, using the slots of the DIN Rail to locate. To ensure stability, holes should be located at least 4 inches (101.6mm) apart.
3. Insert a screw into each hole. The screw heads should be flush with the surface of the DIN rail,

Troubleshooting

If you encounter problems with the QuadCharger device, refer to chart below for possible solutions. If problems persist, please contact [Technical Assistance](#) (see page 13-2).

Problem	Issue
The Status LED does not come on when I insert a battery pack into a slot.	Check the power connections on the QuadCharger device; make sure the POWER switch is ON and the battery pack is properly seated.
The Status LED lights red during charging.	Try to charge the battery in one of the other charging slots. If the red Status LED comes on again, then the problem is associated with the battery pack. If the red status stays with the charging slot, the problem is associated with the charging circuitry.
The Status LED lights red and stays on without a battery in the charging slot.	An error occurred during the self-diagnostic test for that particular charging pocket. Call Honeywell Product Service and Repair (see page 13-1) to request an RMA.

Dolphin Mobile Mount

Overview

The Dolphin Mobile Mount provides easy and secure access to the Dolphin terminal in mobile environments.



Use only the peripherals, power cables, and power adapters from Honeywell. Use of peripherals, cables, or power adapters not sold/manufactured by Honeywell may result in damage not covered by the warranty.

Out of the Box

The Dolphin Mobile Mount ships with

- The plastic mount, which holds one Dolphin 7600 terminal
- A standard, RAM (101-B) mounting bracket with two universal ball joints.
- The nuts and bolts required for installation.

Note: The Dolphin Mobile Mount is not intended for use the imaging/scanning applications.

Inserting a Terminal

Note: It is recommended that you install one of the ball mounts on the back panel before inserting a terminal; see [Mounting](#) on page 11-3.

1. Insert the back panel of a Dolphin 7600 terminal and gently place the lip of the top of the latch in place at the bottom of the image engine window.

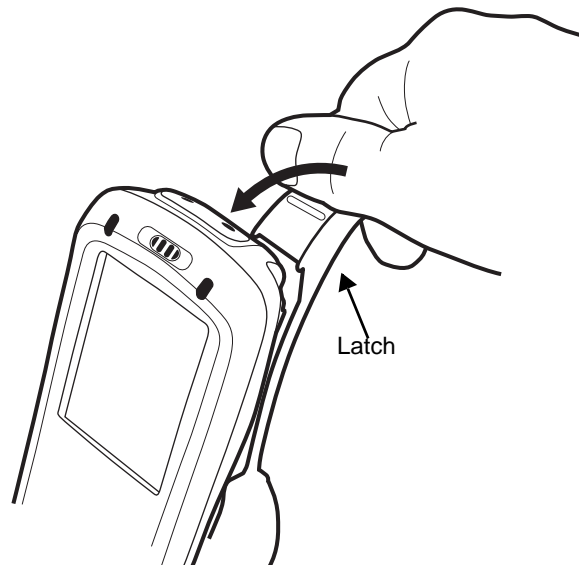

Do NOT pull back on the latch and snap in place! Make sure that the Dolphin terminal is securely fastened inside the mount but do not use excessive force.

-
2. The latch at the top should grip the back of the image engine window slot.

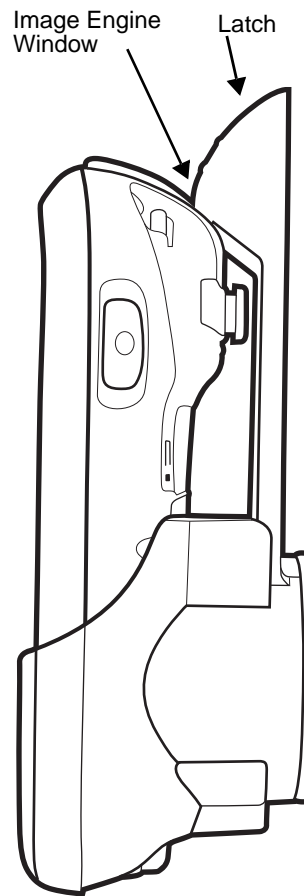

Mounting

The Dolphin Mobile Mount ships with a standard RAM mount (101B). You attach one ball joint that you attach to the back panel of the mount (with the fasteners provided).

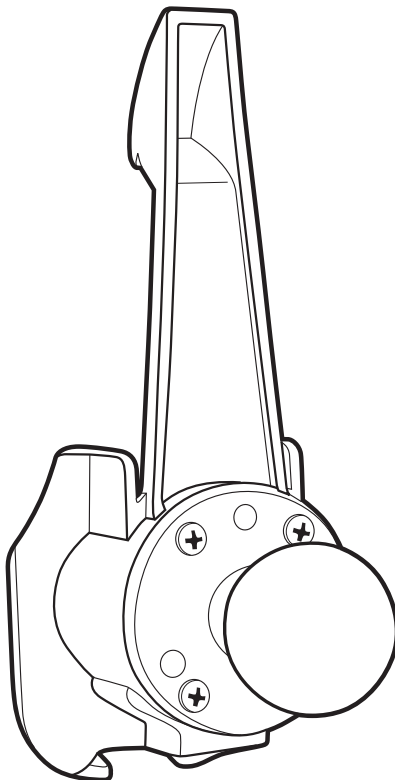

Then, you attach the rest of the RAM mount.

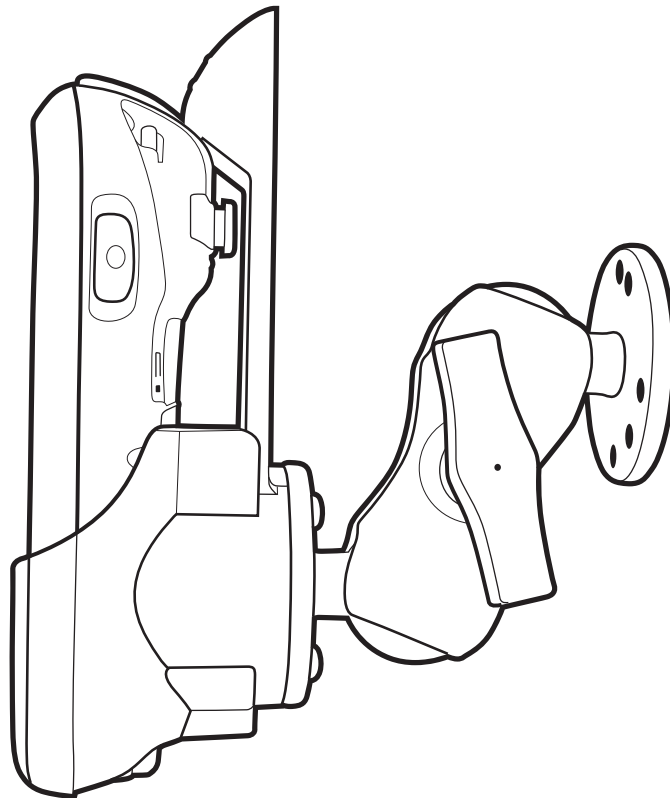
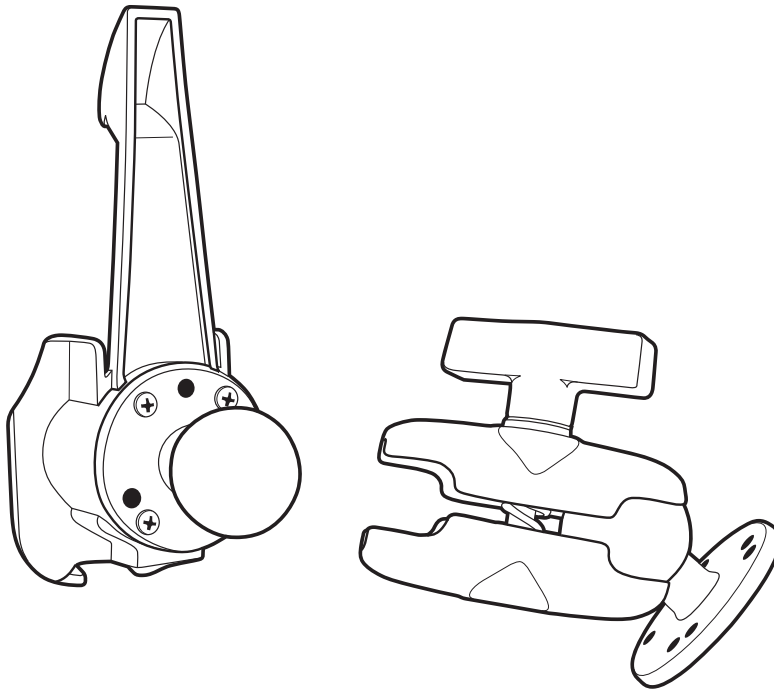

Then, fasten the RAM mount to a stable surface.

Terminal Technical Specifications

Basic Features	
Operating System:	Windows Mobile 6.0
Development Environment:	Honeywell SDK for Windows Mobile 6.0
Supported Software:	SOTI MobiControl (remote device management) PowerNet™ Terminal Emulation (TNVT, 3270, 5250) ITScriptNet™
Installed Applications:	Honeywell Power Tools and Demos and ITScriptNet Ready-To-Go applications
CPU:	Samsung 2440 400 MHz
Memory:	128MB RAM X 128MB Flash
Mass Storage:	User-accessible microSD™/microSDHC™
Display:	2.8 in. 1/4 VGA, 240 X 320, TFT color display with touch screen
Keyboards:	29-key numeric keyboard with shifted alpha and six(6) programmable keys 38-key alpha keyboard with shifted numeric and two(2) programmable keys Backlit
Sound/ Voice:	On-board speaker, microphone, and standard 2.5mm headset jack
Communications:	RS-232/USB connector, IrDA port
Power:	Li-ion battery 3.7V / 3240 mAh / 12.0 Wh
Charging:	5.0V DC input through side access or USB/Serial connector
Charging Peripherals:	AC wall adapter Charge/Communication Cable HomeBase: Single-bay terminal charger QuadCharger: Four-bay battery charger
Imager Scanner Engines	
Available Engines:	5300SR VGA Area Imager with High-Vis bracket aimer Caution - use of controls or adjustments or performance of procedures other than those specified herein may result in hazardous radiation exposure.
1D Symbologies:	Codabar, Code 3 of 9, Code 11, Code 32, Pharmaceutical (PARAF), Code 93, Code 128, EAN with Add-On, EAN with Extended Coupon Code, EAN-8, EAN-13, GS1-128, GS1 Databar, Interleaved 2 of 5, ISBT 128, Matrix 2 of 5, MSI, Plessey, PosiCode, Straight 2 of 5 IATA, Straight 2 of 5 Industrial, Telepen, Trioptic Code, UPC, UPC-A, and UPC-E
2D Symbologies:	Aztec, Codablock, Code 16K, Code 49, Composite, Data Matrix, GS1 Databar, MaxiCode, Micro PDF, OCR, PDF417, and QR Code

Terminal Technical Specifications

Composite Codes:	Aztec Mesa, Codablock F, EAN-UCC, GS1 Databar-14
OCR:	OCR-A, OCR-B, OCR-US Money Font
Postal Codes:	Postnet and most international 4 state codes, Australian Post, British Post, Canadian Post, China Post, Japanese Post, KIX (Netherlands) Post, Korea Post, Planet Code
Wireless	
WLAN (optional):	802.11b/g
WLAN Security:	WEP, WPA Personal/Enterprise, WPA2 Personal/Enterprise, EAP-TLS, TTLS, LEAP, PEAP, WiFi (WPA2), Cisco CCX v4 (pending)
WPAN (standard):	Bluetooth Class 2, version 1.2
Physical	
Operating Temperature:	14° to 122°F (-10° to 50°C)
Charging Temperature:	32° to 104°F (0° to 40°C)
Relative Humidity:	95% humidity (non-condensing)
Construction:	High-impact, resistant PC/ABS housings Magnesium alloy internal chassis with component shock mounts
Structural:	5 ft.(1.5m) multiple drops to concrete, all axis, across operating temperature range
ESD:	Air: +/- 12k Vdc Direct: +/- 8k Vdc
Environmental:	IP54 rating rated for blown dust and water intrusion
Dimensions: (Long x Wide x Deep)	7.1 in. X 2.7 in. X 1.9 in. (18 cm. X 6.9 cm. X 4.7 cm.)
Weight:	Approximately 14.3 oz./406g
Regulatory & Compliance:	Safety: cUL 60950, NOM, EN60950, BSMI CN14336, CCC GB4943, PSB, SIRIM EMC: FCC Part 15 Class B, ICES-003, EN301 489-1, EN301 489-17, EN55022, EN55024, BSMI CNS13438, CCC GB9254, MIC, AS/NZS 3548, FCC Parts 22H & 24H, FCC SAR OET 65, EN301511, RSS-132/133 Radio: FCC 15.247, RSS-210, COFETEL, EN300 328-1, EN300 328-2, SRRC ETS 300 328, IDA, SIRIM, MIC, ARIB STD-T33 & T66, AS/NZS 4771

Dolphin HomeBase Device

Structural	
Dimensions	4 in. high X 4.4 in. wide X 3.7 in. deep (10.2 cm. X 11.2 cm. X 9.4 cm.)
Weight	11.2 oz. (318g)
Material	Polycarbonate ABS blend
Color	Gray
Mounting	Two keyholes on the back panel for wall-mounting
Capacity	One Dolphin terminal
Environmental	
Operating Temperature Charging Temperature	32° to 104°F (0° to 40°C)
Storage Temperature	-4° to 140°F (-20° to +60°C)
Electrical Static Discharge	8 KVA immunity on all surfaces
Humidity	90% relative humidity (non-condensing)
Power Supply	
Input (Universal) (from the power source)	100–240 Volts, 0.5 A 50–60Hz
Output (to the HomeBase)	5 Volts DC, 3.0 A
Charging	
Standard Charge	Four hours or less
Max Charging Current	2A Max
Standby Current	<100mA
Status LED	Green: Dolphin terminal is properly seated in the HomeBase.
Communication	
Interface	USB B Male connector supports data transmission of up to 12 Mbps OR Standard DB9 serial connector supports data transmission up to 115 Kbps
Agency Approvals	
Power Supply:	UL listed TUV licensed Power Supply compliant to FCC part 15, Class B
Charging:	CE Marking (EMC)

Dolphin HomeBase Device

Fire Retardant:	UL 94-VO
------------------------	----------

Dolphin QuadCharger Device

Structural	
Dimensions	11 in. long X 4.8 in. wide X 1.5 in. high (27.9 cm. long X 12.2 cm. wide X 3.8 cm. high)
Weight	15.1 oz. (428g)
Material	Case: Polycarbonate ABS blend Color: Gray
Mounting	Use DIN rail slide to mount to a desktop or wall; see DIN Rail Dimensions on page 10-5.
Capacity	Supports up to four Li-ion battery packs
Environmental	
Operating Temperature Charging Temperature	32° to 104°F (0° to 40°C)
Storage Temperature	-4° to +140°F (-20° to +60°C)
Electrical Static Discharge	8 KVA immunity on all surfaces
Humidity	90% relative humidity (non-condensing)
Power Supply	
Input (Universal)	100V-240V, 0.8 A 50-60Hz
Output	12Volts DC, 2.5 A
Charging	
Standard Charge	Four hours or less
Status LEDs	See Status LEDs on page 10-1.
Agency Approvals	
Power Supply	UL listed TUV licensed Power Supply compliant to FCC part 15, Class B
Charging	CE Marking CISPR Pub 22
Fire Retardant	UL94 V-0



Product Service and Repair

Honeywell provides service for all its products through service centers throughout the world. To obtain warranty or non-warranty service, contact the appropriate location below to obtain a Return Material Authorization number (RMA #) before returning the product.

North America

Telephone: (800) 782-4263
Fax: (803) 835-8012
E-mail: naservice@handheld.com

Latin America

Telephone: (803) 835-8000
Telephone: (800) 782-4263
Fax: (239) 263-9689
E-mail: laservice@handheld.com

Brazil

Telephone: +55 (21) 3535-9100
Fax: +55 (21) 3535-9105
E-mail: brservice@handheld.com

Mexico

Telephone: +52 (55) 5203-2100
Fax: +52 (55) 5531-3672
E-mail: mxservice@handheld.com

Europe, Middle East, and Africa

Telephone: +31 (0) 40 2901 633
Fax: +31 (0) 40 2901 631
E-mail: euservice@handheld.com

Asia Pacific

Telephone: +852-2511-3050
Fax: +852-2511-3557
E-mail: apservice@handheld.com

Japan

Telephone: +813-5770-6312
Fax: +813-5770-6313
E-mail: apservice@handheld.com

Online Product Service and Repair Assistance

You can also access product service and repair assistance online at www.honeywell.com/aidc.

Technical Assistance

If you need assistance installing or troubleshooting your device, please call your distributor or the nearest technical support office:

North America/Canada

Telephone: (800) 782-4263
(8 a.m. to 6 p.m. EST)
Fax number: (315) 554-6705
E-mail: natechsupport@handheld.com

Latin America

Telephone: (803) 835-8000
Telephone: (800) 782-4263
E-mail: latachsupport@handheld.com

Brazil

Telephone: +55 (21) 3535-9100
Fax: +55 (21) 3535-9105
E-mail: brsuporte@handheld.com

Mexico

Telephone: (803) 835-8000
E-mail: latachsupport@handheld.com

Europe, Middle East, and Africa

Telephone: +31 (0) 40 7999 393
Fax: +31 (0) 40 2425 672
E-mail: euro.support@handheld.com

Asia Pacific

Telephone - Hong Kong: +852-3188-3485 or 2511-3050
Telephone - China: +86 21 6361 3818
E-mail: aptechsupport@handheld.com

Japan

Telephone: +813 5770-6312
E-mail: aptechsupport@handheld.com

Malaysia

Telephone: +603-6201-7020
E-mail: aptechsupport@handheld.com

Online Technical Assistance

You can also access technical assistance online at www.honeywell.com/aidc.

Limited Warranty

Honeywell International Inc. ("Honeywell") warrants its products to be free from defects in materials and workmanship and to conform to Honeywell's published specifications applicable to the products purchased at the time of shipment. This warranty does not cover any Honeywell product which is (i) improperly installed or used; (ii) damaged by accident or negligence, including failure to follow the proper maintenance, service, and cleaning schedule; or (iii) damaged as a result of (A) modification or alteration by the purchaser or other party, (B) excessive voltage or current supplied to or drawn from the interface connections, (C) static electricity or electro-static discharge, (D) operation under conditions beyond the specified operating parameters, or (E) repair or service of the product by anyone other than Honeywell or its authorized representatives.

This warranty shall extend from the time of shipment for the duration published by Honeywell for the product at the time of purchase ("Warranty Period"). Any defective product must be returned (at purchaser's expense) during the Warranty Period to Honeywell's factory or authorized service center for inspection. No product will be accepted by Honeywell without a Return Materials Authorization, which may be obtained by contacting Honeywell. In the event that the product is returned to Honeywell or its authorized service center within the Warranty Period and Honeywell determines to its satisfaction that the product is defective due to defects in materials or workmanship, Honeywell, at its sole option, will either repair or replace the product without charge, except for return shipping to Honeywell.

EXCEPT AS MAY BE OTHERWISE PROVIDED BY APPLICABLE LAW, THE FOREGOING WARRANTY IS IN LIEU OF ALL OTHER COVENANTS OR WARRANTIES, EITHER EXPRESSED OR IMPLIED, ORAL OR WRITTEN, INCLUDING, WITHOUT LIMITATION, ANY IMPLIED WARRANTIES OF MERCHANTABILITY OR FITNESS FOR A PARTICULAR PURPOSE.

HONEYWELL'S RESPONSIBILITY AND PURCHASER'S EXCLUSIVE REMEDY UNDER THIS WARRANTY IS LIMITED TO THE REPAIR OR REPLACEMENT OF THE DEFECTIVE PRODUCT WITH NEW OR REFURBISHED PARTS. IN NO EVENT SHALL HONEYWELL BE LIABLE FOR INDIRECT, INCIDENTAL, OR CONSEQUENTIAL DAMAGES, AND, IN NO EVENT, SHALL ANY LIABILITY OF HONEYWELL ARISING IN CONNECTION WITH ANY PRODUCT SOLD HEREUNDER (WHETHER SUCH LIABILITY ARISES FROM A CLAIM BASED ON CONTRACT, WARRANTY, TORT, OR OTHERWISE) EXCEED THE ACTUAL AMOUNT PAID TO HONEYWELL FOR THE PRODUCT. THESE LIMITATIONS ON LIABILITY SHALL REMAIN IN FULL FORCE AND EFFECT EVEN WHEN HONEYWELL MAY HAVE BEEN ADVISED OF THE POSSIBILITY OF SUCH INJURIES, LOSSES, OR DAMAGES. SOME STATES, PROVINCES, OR COUNTRIES DO NOT ALLOW THE EXCLUSION OR LIMITATIONS OF INCIDENTAL OR CONSEQUENTIAL DAMAGES, SO THE ABOVE LIMITATION OR EXCLUSION MAY NOT APPLY TO YOU.

All provisions of this Limited Warranty are separate and severable, which means that if any provision is held invalid and unenforceable, such determination shall not affect the validity of enforceability of the other provisions hereof.

Use of any peripherals not manufactured/sold by Honeywell may result in damage not covered by this warranty. This includes but is not limited to: cables, power supplies, power adapters, cradles, and docking stations.

Honeywell extends these warranties only to users of the products. These warranties are non-transferable.

The limited duration of the warranty for the Dolphin 7600 series of products is as follows:

- The duration of the limited warranty for terminals with an integrated imager is one year.
- The duration of the limited warranty for touch screens is one year provided that a screen protector is applied and an approved stylus is used for the 12-month duration covered by the warranty.
- The duration of the limited warranty for the Dolphin HomeBase device and Dolphin QuadCharger device is one year.
- The duration of the limited warranty for batteries is one year.

Use of any battery not sold/manufactured by Honeywell may result in damage not covered by the warranty. Batteries returned to Honeywell in a reduced state may or may not be replaced under this warranty. Battery life will be greatly increased when following the battery instructions in the Dolphin 7600 Mobile Computer User's Guide.

How to Extend Your Warranty

Honeywell offers a variety of service plans on our hardware products. These agreements offer continued coverage for your equipment after the initial warranty expires. For more information, contact your Sales Representative, Customer Account Representative, or Product Service Marketing Manager from Honeywell, or your Authorized Reseller.



Honeywell

700 Visions Drive

P.O. Box 208

Skaneateles Falls, NY 13153-0208