

DRAFT COPY 11/11/11

Honeywell

Dolphin™ 7800

with Windows® Embedded Handheld 6.5

User's Guide

DRAFT COPY 11/11/11

Disclaimer

Honeywell International Inc. ("HII") reserves the right to make changes in specifications and other information contained in this document without prior notice, and the reader should in all cases consult HII to determine whether any such changes have been made. The information in this publication does not represent a commitment on the part of HII.

HII shall not be liable for technical or editorial errors or omissions contained herein; nor for incidental or consequential damages resulting from the furnishing, performance, or use of this material.

This document contains proprietary information that is protected by copyright. All rights are reserved. No part of this document may be photocopied, reproduced, or translated into another language without the prior written consent of HII.

Web Address: www.honeywellaidc.com

Trademarks

Dolphin, Dolphin RF, HomeBase, Mobile Base, ChargeBase, Net Base and QuadCharger are trademarks or registered trademarks of Hand Held Products, Inc. or Honeywell International Inc.

Microsoft, Windows, Windows Mobile, Windows Phone, Windows Embedded Handheld, Windows CE, Windows 98 Second Edition, Windows NT, Windows 2000, Windows ME, Windows XP, Windows 7, Windows Vista, ActiveSync, Outlook, and the Windows logo are trademarks or registered trademarks of Microsoft Corporation.

The Bluetooth trademarks are owned by Bluetooth SIG, Inc., U.S.A. and licensed to Honeywell.

Other product names mentioned in this manual may be trademarks or registered trademarks of their respective companies and are the property of their respective owners.

Patents

For patent information, please refer to www.honeywellaidc.com/patents.

©2011 Honeywell International Inc. All rights reserved.

Table of Contents

Chapter 1 - Dolphin 7800 Terminal Agency Information

Laser Safety	1-1
Label Locations	1-1
Model Number, Serial Number and IMEI Labels.....	1-1
Laser Safety Label	1-1
Laser Safety Statement.....	1-1
LED Safety	1-2
LED Safety Statement.....	1-2
UL and C-UL Statement.....	1-2
Approvals by Country.....	1-2
R&TTE Compliance Statement—802.11 a/b/g/n, Bluetooth, and/or GSM.....	1-3
Dolphin RF Terminal—802.11 a/b/g/n, Bluetooth, and/or GSM.....	1-3
Canadian Compliance.....	1-4
Conformité à la réglementation canadienne	1-4
RF Exposure Information (SAR)	1-4
For European Community Users	1-5
Waste Electrical and Electronic Equipment Information	1-5
China RoHS	1-6
Pacemakers, Hearing Aids and Other Electrically Powered Devices	1-6
Hearing Aid Compatibility (HAC).....	1-6
Microwaves.....	1-7

Chapter 2 - Getting Started

Out of the Box	2-1
Initial Setup for Dolphin 7800 Terminals	2-1
Replacing the Main Battery Pack.....	2-4
Home Screen	2-5
Title Bar.....	2-5
Icons in the Title Bar	2-5
Horizontal Scroll.....	2-8
Tile Bar.....	2-8
Pop-Up Menus.....	2-8
Selecting Programs.....	2-8
File Explorer	2-9
File Provisioning on the 7800.....	2-10
Search.....	2-10
Resetting the Terminal.....	2-11
Soft Reset (Warm Boot).....	2-11
Hard Reset (Cold Boot).....	2-11
Factory Reset.....	2-11
Suspend Mode.....	2-11

Chapter 3 - Hardware Overview

Standard Configurations for the 7800	3-1
Peripherals for the 7800.....	3-3

Accessories for the 7800	3-4
Front Panel: 7800	3-5
Front Panel Features for the 7800	3-6
Back Panel: 7800	3-8
Back Panel Features for the 7800	3-9
Bottom Panel: 7800	3-10
I/O Connector	3-10
Using the Touch Panel	3-11
Installing a Screen Protector	3-11
Healthcare Housing	3-11
Batteries	3-12
Main Battery Pack	3-12
Internal Backup Battery	3-14
Managing Battery Power	3-14
Checking Battery Power	3-15
System Resets	3-15
Installing a SIM Card and/or Memory Card	3-16
Installation	3-16

Chapter 4 - Using the Scan Image Engine

Overview	4-1
Laser Safety	4-1
N5603 Beam Divergence Angle	4-1
LED Safety	4-1
Image Engine Specifications	4-1
Depth of Field	4-1
Supported Bar Code Symbolologies	4-3
Decoding	4-4
To Decode a Bar Code	4-4
Aiming Beam Options	4-5
Capturing Images	4-6
Taking an Image	4-6
Uploading Images	4-7

Chapter 5 - Using the Color Camera

Overview	5-1
Taking a picture using the Camera Demo tool	5-1
Taking a picture using the Windows Embedded Handheld 6.5 Camera tool	5-2
Recording Video	5-3
Uploading Pictures and Videos	5-4

Chapter 6 - Using the Keyboards

Available Keyboards	6-1
Keyboard Combinations	6-2
Common Buttons	6-2
Using the Function Keys	6-2
Using the Modifier Keys	6-3

Using the Navigation Keys	6-3
30-Key Numeric Keyboard	6-4
30-Key Numeric Keyboard Combinations.....	6-4
30-Key Numeric (Calculator) Keyboard.....	6-6
30-Key Numeric (Calculator) Keyboard Combinations.....	6-6
46-Key QWERTY Keyboard.....	6-8
46-Key QWERTY Keyboard Combinations	6-8
46-Key AZERTY Keyboard.....	6-11
46-Key AZERTY Keyboard Combinations.....	6-11
46-Key QWERTZ Keyboard	6-14
46-Key QWERTZ Keyboard Combinations	6-14

Chapter 7 - System Settings

Overview.....	7-1
Clock & Alarms	7-2
Personal Menu	7-3
Buttons.....	7-3
System Menu.....	7-7
About	7-8
Backlight	7-9
Battery	7-10
Certificates.....	7-10
Encryption.....	7-11
Error Reporting	7-11
External GPS.....	7-11
Five Volt Control	7-12
Smart Sensor.....	7-12
Managed Programs	7-13
Memory.....	7-14
RIL.....	7-15
Power.....	7-15
Regional Settings.....	7-15
Remove Programs.....	7-16
Screen	7-17
Task Manager.....	7-18

Chapter 8 - Communication

Connections Menu.....	8-1
Connections Manager	8-2
To Access the Connections Manager.....	8-2
Tasks	8-2
Advanced.....	8-3
Dolphin Wireless Manager	8-4
Dolphin Wireless Manager Window.....	8-4
Enabling the Radios.....	8-4
Accessing Radio Configuration Utilities	8-5
Network Cards.....	8-6
Connecting and Synchronizing the Terminal and Workstation.....	8-6

Installing Additional Software	8-8
Adding Programs Using ActiveSync or Windows Mobile Device Center	8-8
Connecting the Terminal to a Wireless Network.....	8-10
Adding Programs Using the Internet.....	8-10
Software Upgrades.....	8-10
7800 COM Port Assignment Table.....	8-11

Chapter 9 - Working with Wireless Wide Area Networking (WWAN)

Overview.....	9-1
Antenna Band.....	9-1
Enabling the WWAN Radio	9-3
GSM/HSPA+ Global Radio Dolphin Models	9-3
Voice Communication.....	9-3
Audio Modes.....	9-3
Volume Control.....	9-4
Accessing the Dialer Window	9-4
Dialing.....	9-4
Sending Calls.....	9-5
Ending Calls.....	9-5
Accessing Voice Mail.....	9-5
View Options.....	9-5
Setup Options.....	9-5
Data Communication (GSM/HSPA+ Global Radio Dolphin Models).....	9-7
System Requirements	9-7
Information Requirements	9-7
Establishing Data Communication.....	9-7
Manual Network Selection	9-10
Data Communication GSM/CDMA Dolphin Models	9-11
Gobi Manager.....	9-11
Establishing Data Communication.....	9-12

Chapter 10 - Working with the Bluetooth Radio

Enabling the Bluetooth Radio.....	10-1
Pairing and Trusted Devices	10-2
Connecting to Other Bluetooth Devices	10-2
Transferring Files.....	10-5
Making the Terminal Discoverable	10-6
Enabling the Terminal to Receive Incoming Beams	10-6
Selecting COM Ports.....	10-7

Chapter 11 - Working with GPS

Overview.....	11-1
Assisted GPS Support.....	11-1
Powering the GPS Module	11-1

Communication Ports	11-1
Selecting the Port	11-1
COM7	11-1
GPS Intermediate Driver.....	11-2
GPS Demo	11-2

Chapter 12 - Dolphin 7800 HomeBase Device (Model 7800-HB)

Overview.....	12-1
Parts and Functions.....	12-2
Back Panel	12-3
Bottom Panel	12-4
Power	12-4
Connecting Power to the HomeBase.....	12-4
Charging the Main Battery	12-5
To Power a Terminal and Charge its Main Battery.....	12-5
Charging a Spare Battery in the Auxiliary Battery Well	12-5
Communication.....	12-6
Connecting the Communication Cables	12-6
Establishing Communication	12-6
Communicating with the Dolphin Terminal	12-6
Mounting the HomeBase	12-7

Chapter 13 - Dolphin 7800 eBase Device (Model 7800-EHB)

Overview.....	13-1
Unpacking the eBase.....	13-1
Parts and Functions.....	13-2
Front Panel	13-2
Back Panel	13-3
Bottom Panel	13-4
Power	13-4
Connecting Power to the eBase	13-5
Charging the Main Battery	13-5
To Power a Terminal and Charge its Main Battery.....	13-5
Charging a Spare Battery in the Auxiliary Battery Well	13-5
Communication.....	13-6
Software Requirements	13-6
Establishing Ethernet Communication.....	13-6
Establishing USB Communication	13-7
Mounting the eBase.....	13-7
Optional Hardware Mount.....	13-8

Chapter 14 - Dolphin 7800 Mobile Base Device (Model 7800-MB)

Overview.....	14-1
Mobile Base Components	14-2
Back Panel and Mounting Brackets.....	14-3

Mounting.....	14-3
Safety Precautions.....	14-3
Installation.....	14-4
Charging the Main Battery.....	14-4
To Power a Terminal and Charge its Main Battery.....	14-4

Chapter 15 - Dolphin 7800 ChargeBase Device (Model 7800-CB)

Overview.....	15-1
Unpacking the ChargeBase.....	15-1
Parts and Functions.....	15-2
Front Panel.....	15-2
Back Panel.....	15-3
Power.....	15-3
Connecting Power to the ChargeBase.....	15-3
Charging the Main Battery.....	15-4
To Power a Terminal and Charge its Main Battery.....	15-4
Mounting the ChargeBase.....	15-4

Chapter 16 - Dolphin 7800 Net Base Device (Model 7800-NB)

Overview.....	16-1
Parts and Functions.....	16-2
Front Panel.....	16-2
Back Panel.....	16-3
Bottom Panel.....	16-4
Power.....	16-4
Connecting Power to the Net Base.....	16-4
Charging the Main Battery.....	16-5
To Power a Terminal and Charge its Main Battery.....	16-5
Communication.....	16-5
Software Requirements.....	16-5
Connecting the Dolphin Terminal to the Net Base.....	16-6
Mounting the Net Base.....	16-6

Chapter 17 - Dolphin 7800 QuadCharger Device (Model 7800-QC)

Overview.....	17-1
Parts and Functions.....	17-2
Power.....	17-3
Inserting and Charging Batteries.....	17-3
Mounting the QuadCharger.....	17-4
Troubleshooting.....	17-5

Chapter 18 - Customer Support

Product Service and Repair.....	18-1
Online Product Service and Repair Assistance.....	18-1
Technical Assistance.....	18-2
Online Technical Assistance.....	18-2

DRAFT COPY 11/11/11

Limited Warranty	18-3
How to Extend Your Warranty	18-4

DRAFT COPY 11/11/11

Dolphin 7800 Terminal Agency Information

Dolphin 7800 mobile computers meet or exceed the requirements of all applicable standards organizations for safe operation. However, as with any electrical equipment, the best way to ensure safe operation is to operate them according to the agency guidelines that follow. Read these guidelines carefully before using your Dolphin terminal.

This documentation is relevant for the following Dolphin models: 7800L0, 7800LW, 7800LG, 7800LC.

Laser Safety

Label Locations

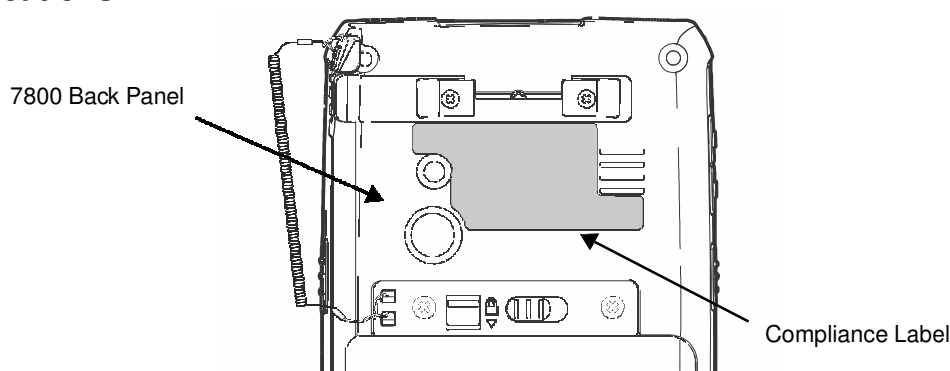

Model Number, Serial Number and IMEI Labels

The model (item) number, serial number, and international mobile equipment identity (IMEI) number for the terminal are located on labels affixed to the walls of the battery well.

Laser Safety Label

If the following label is attached to your product, it indicates the product contains an engine with a laser aimer:

Image Engines with Integrated Laser Aimers

LASER LIGHT. Do not stare into beam.
Class2 Laser Product. 1.0mW MAX
OUTPUT. IEC60825-1 Ed. 2 (2007) pulse
duration of 15.5mSec. Complies with 21
CFR 1040.10 and 1040.11 except for
deviations pursuant to Laser Notice No. 50,
dated June 24, 2007.



Laser Safety Statement

This device has been tested in accordance with and complies with IEC60825-1 (Ed. 2.0), EN60825-1:2007. Complies with 21 CFR 1040.10 and 1040.11, except for deviations pursuant to Laser Notice No. 50, dated June 24, 2007. **LASER LIGHT, DO NOT STARE INTO BEAM. CLASS 2 LASER PRODUCT, 1.0 mW MAX OUTPUT: 650nm.**



WARNING - Use of controls or adjustments or performance of procedures other than those specified herein may result in hazardous radiation exposure.

LED Safety

LED Safety Statement

LEDs have been tested and classified as “EXEMPT RISK GROUP” to the Standard: IEC 62471:2006.



CAUTION! Do not view directly with optical instruments.

UL and C-UL Statement

UL and C-UL listed: UL60950-1 2nd Edition, and CSA C22.2 No. 60950-1-07 2nd Edition.

Approvals by Country

Country	EMC, Radio, & SAR	Safety
U.S.A.	FCC Part 15, Subpart B FCC Part 15, Subpart C, 15.247 FCC Part 15, Subpart E FCC Part 22H FCC Part 24E FCC SAR OET 65 Supplement C	UL60950-1 2nd Edition
Canada	ICES-003 (Class B) RSS 132 RSS 133 RSS 210	CSA C22.2 No. 60950-1-07, 2nd Edition
European Community/CE	EN300328, EN301893, EN55022, EN55024, EN301489-1, EN301489-7/24, EN301489-17, 3GPPTS 51.010-1, EN301511, EN301908, EN50360, EN50361, EN50371, EN50392, IEC6220-1, IEC6220-2, EN300440, 301 389-25 (CDMA 2000)	EN60950-1 2nd Edition EN60825-1 2nd Edition
International		IEC 60950-1 2nd Edition IEC 60825-1 2nd Edition IEC 62471

R&TTE Compliance Statement—802.11a/b/g/n, Bluetooth, and/or GSM

Dolphin RF terminals are in conformity with all essential requirements of the R&TTE Directive (1999/5/EC).

This product is marked with **CE 0678**  according to article 12 of the R&TTE Directive. In addition, this product complies to 2006/95/EC Low Voltage Directive when supplied with the recommended power supply. Honeywell shall not be liable for use of our product with equipment (i.e., power supplies, personal computers, etc.) that is not CE marked and does not comply with the Low Voltage Directive.

DRAFT COPY 11/11/11

The equipment is intended for use throughout the European Community; PAN European Frequency Range: 2.402–2.480 GHz. Restrictions for use in France are as follows:

- Indoor use: Maximum power (EIRP*) of 100 mW for the entire 2.400–2.4835 GHz
- Outdoor use: Maximum power (EIRP*) of 100 mW for the 2.400–2.454 GHz band & maximum power (EIRP*) of 10 mW for the 2.454–2.483 MHz band.
- 5GHz band: UNII (Unlicensed National Information Infrastructure) or band1 (5.150 to 5.250 GHz) is restricted to indoor use only. Any other use will make the operation of the device illegal.

For further information, please contact:

Honeywell Imaging & Mobility Europe BV
Nijverheidsweg 9
5627 BT Eindhoven
The Netherlands

FCC Requirements

Dolphin RF Terminal—802.11a/b/g/n, Bluetooth, and/or GSM

This device complies with Part 15 of the FCC Rules. Operation is subject to the following two conditions: (1) this device may not cause harmful interference, and (2) this device must accept any interference received, including interference that may cause undesired operation.

This equipment has been tested and found to comply with the limits for a Class B digital device pursuant to Part 15 of the FCC Rules. These limits are designed to provide reasonable protection against harmful interference in a residential installation. This equipment generates, uses, and can radiate radio frequency energy and, if not installed and used in accordance with the instructions, may cause harmful interference to radio communications. However, there is no guarantee that interference will not occur in a particular installation. If this equipment does cause harmful interference to radio or television reception, which can be determined by turning the equipment off and on, the user is encouraged to try to correct the interference by one or more of the following measures:

- Reorient or relocate the receiving antenna.
- Increase the separation between the equipment and receiver.
- Connect the equipment into an outlet on a circuit different from that to which the receiver is connected.
- Consult the dealer or an experienced radio/TV technician for help.

If necessary, the user should consult the dealer or an experienced radio/television technician for additional suggestions. The user may find the following booklet helpful: "Something About Interference." This is available at FCC local regional offices. Our company is not responsible for any radio or television interference caused by unauthorized modifications of this equipment or the substitution or attachment of connecting cables and equipment other than those specified by our company. The correction is the responsibility of the user. Use only shielded data cables with this system.

In accordance with FCC 15.21, changes or modifications not expressly approved by the party responsible for compliance could void the user's authority to operate the equipment.

The antenna(s) used for this transmitter must not be co-located or operating in conjunction with any other antenna or transmitter.

CAUTION! - Any changes or modifications not expressly approved by the grantee of this device could void the user's authority to operate the equipment.

Canadian Compliance

This device complies with Industry Canada license-exempt RSS standard(s). Operation is subject to the following two conditions:

- (1) this device may not cause interference, and
- (2) this device must accept any interference, including interference that may cause undesired operation of the device.

This Class B digital apparatus complies with Canadian ICES-003.

This Category II radiocommunication device complies with Industry Canada Standard RSS-310.

Conformité à la réglementation canadienne

Le présent appareil est conforme aux CNR d'Industrie Canada applicables aux appareils radio exempts de licence. L'exploitation est autorisée aux deux conditions suivantes:

- (1) l'appareil ne doit pas produire de brouillage, et
- (2) l'utilisateur de l'appareil doit accepter tout brouillage radioélectrique subi, même si le brouillage est susceptible d'en compromettre le fonctionnement."

Cet appareil numérique de la classe B est conforme à la norme NMB-003 du Canada.

Ce dispositif de radiocommunication de catégorie II respecte la norme CNR-310 d'Industrie Canada.

RF Exposure Information (SAR)

This mobile phone meets the government's requirements for exposure to radio waves. This phone is designed and manufactured not to exceed the emission limits for exposure to radio frequency (RF) energy set by the Federal Communications Commission of the U.S. Government.

The exposure standard for wireless mobile phones employs a unit of measurement known as the Specific Absorption Rate, or SAR. The SAR limit set by the FCC is 1.6W/kg. Tests for SAR are conducted using standard operating positions accepted by the FCC with the phone transmitting at its highest certified power level in all tested frequency bands. Although the SAR is determined at the highest certified power level, the actual SAR level of the phone while operating can be well below the maximum value. This is because the phone is designed to operate at multiple power levels so as to use only the power required to reach the network. In general, the closer you are to a wireless base station antenna, the lower the power output.

The highest SAR value for the model phone as reported to the FCC when tested for use at the ear is 0.512 W/kg Max. and when worn on the body, as described in this user guide, is 0.559 W/kg Max. (Body-worn measurements differ among phone models, depending upon available accessories and FCC requirements.)

While there may be differences between the SAR levels of various phones and at various positions, they all meet the government requirement.

The FCC has granted an Equipment Authorization for this model phone with all reported SAR levels evaluated as in compliance with the FCC RF exposure guidelines. SAR information on this model phone is on file with the FCC and can be found under the Display Grant section of www.fcc.gov/oet/ea/fccid after searching on FCC ID: HD57800LC .

For body worn operation, this phone has been tested and meets the FCC RF exposure guidelines for use with an accessory that contains no metal and positions the handset a minimum of 1.5 cm from the body. Use of other accessories may not ensure compliance with FCC RF exposure guidelines. If you do not use a body-worn accessory and are not holding the phone at the ear, position the handset a minimum of 1.5 cm from your body when the phone is switched on.

For European Community Users

Honeywell complies with Directive 2002/96/EC OF THE EUROPEAN PARLIAMENT AND OF THE COUNCIL of 27 January 2003 on waste electrical and electronic equipment (WEEE); European REACH Regulation 1907/2006 of 1 June, 2007, and Restriction of Hazardous Substances Directive (RoHS) 2002/95/EC of 1 July 2006.

Waste Electrical and Electronic Equipment Information

This product has required the extraction and use of natural resources for its production. It may contain hazardous substances that could impact health and the environment, if not properly disposed.

In order to avoid the dissemination of those substances in our environment and to diminish the pressure on the natural resources, we encourage you to use the appropriate take-back systems for product disposal. Those systems will reuse or recycle most of the materials of the product you are disposing in a sound way.



The crossed out wheeled bin symbol informs you that the product should not be disposed of along with municipal waste and invites you to use the appropriate separate take-back systems for product disposal. If you need more information on the collection, reuse, and recycling systems, please contact your local or regional waste administration. You may also contact your supplier for more information on the environmental performances of this product.

China RoHS

有毒有害物质名称及含量 (Names and Content of Hazardous Substances or Elements)						
部件名称 (Parts Name)	有毒有害物质或元素 (Toxic and Hazardous Substances or Elements)					
	铅 (Pb)	汞 (Hg)	镉 (Cd)	六价铬 (Cr ⁶⁺)	多溴联苯 (PBB)	多溴二苯醚 (PBDE)
成像式条码阅读器 (Imager)	x	o	o	o	o	o
印刷电路板 (PCBA)	x	o	o	o	o	o
主机及基座外壳 (Housing)	x	o	o	o	o	o
连线 (Cables)	o	o	o	o	o	o
液晶显示器 (LCD)	o	o	o	o	o	o
液晶显示器框架 (LCD Frame)	o	o	o	o	o	o
相机模组 (Camera)	x	o	o	o	o	o
键盘 (Keypad)	o					
电池 (Battery)	o	o	o	o	o	o
电源供应器 (Power Adapter)	x	o	o	o	o	o

o: 表示该有毒有害物质在该部件所有均质材料中的含量均在SJ/T11363-2006标准规定的限量要求以下 (Indicates that this toxic or hazardous substance contained in all of the homogeneous materials for this part is below the limit requirement in China's SJ/T11363-2006.)
 x: 表示该有毒有害物质至少在该部件的某一均质材料中的含量超出 SJ/T11363-2006 标准规定的限量要求 (Indicates that this toxic or hazardous substance contained in at least one of the homogeneous materials for this part is above the limit requirement in China's SJ/T11363-2006.)

Pacemakers, Hearing Aids and Other Electrically Powered Devices

Most manufacturers of medical devices adhere to the IEC 601-1-2 standard. This standard requires devices to operate properly in an EM Field with a strength of 3V/m over a frequency range of 26 to 1000MHz. The maximum allowable field strength emitted by the Dolphin terminal is 0.3V/m according to Subpart B of Part 1 of the FCC rules. Therefore, the RF from the Dolphin terminal has no effect on medical devices that meet the IEC specification.

Hearing Aid Compatibility (HAC)

The Dolphin 7800 has been tested for hearing aid compatibility. This device has an M3 and T3 rating. For additional HAC information, including the HAC rating for this product, please refer to www.honeywellaidc.com.

When some wireless devices are used near some hearing devices such as hearing aids and implants, users may detect a buzzing or humming noise. Some hearing devices are more immune than others to this interference noise. Wireless devices may also vary in the amount of interference they generate.

The ratings for compatibility of digital wireless devices with hearing aids are described in the American National Standards Institute (ANSI) C63.19 standard:

M-Rating: Phones rated M3 or M4 meet FCC requirements and are likely to generate less interference with hearing devices than phones that are not labeled. M4 is the superior/higher of the two ratings.

T-Rating: Phones rated T3 or T4 meet FCC requirements and are likely to be more usable with hearing devices' telecoil than unrated phones. T4 is the superior/higher of the two ratings.

The more immune the hearing aid device is, the less likely one is to experience interference noise from the wireless phone. Hearing aid devices may also be rated. Adding the ratings of the hearing aid and the phone would determine probable usability:

- Any combined rating equal to or greater than six offers the best use.
- Any combined rating equal to five is considered normal use.

The ratings are not guarantees. Results will vary depending on the user's hearing device and hearing loss. If your hearing device happens to be vulnerable to interference, you may not be able to use this device successfully. Trying out this device with your hearing device is the best way to evaluate it for your personal needs.

This device has been tested and rated for use with hearing aids for some of the wireless technologies that it utilizes. However, there may be some newer wireless technologies used in this phone that have not been tested yet for use with hearing aids. It is important to try the different features of this phone thoroughly and in different locations, using your hearing aid or cochlear implant, to determine if you hear any interfering noise. Consult your service provider or the manufacturer of this phone for information on hearing aid compatibility.

Microwaves

The radio in the Dolphin RF terminal operates on the same frequency band as a microwave oven. Therefore, if you use a microwave within range of the Dolphin RF terminal you may notice performance degradation in your wireless network. However, both your microwave and your wireless network will continue to function.

Getting Started

Out of the Box

Verify that the carton contains the following items:

- Dolphin mobile computer (the terminal)
- Main battery pack
- Quick Start Guide

If you ordered accessories for your terminals, verify that they are also included with the order. Be sure to keep the original packaging in the event that the Dolphin terminal should need to be returned for service. For details, see [Product Service and Repair](#) on page 18-1.

Initial Setup for Dolphin 7800 Terminals

Step 1. Release the Hand Strap

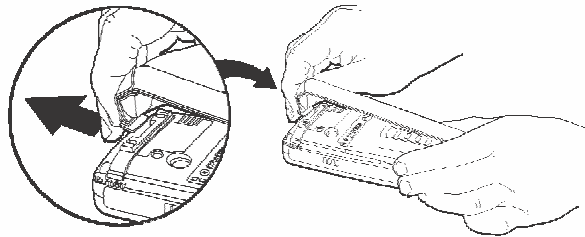



Step 2. Install the Main Battery Pack

Note: Before installing the main battery pack, read the [Guidelines for Battery Pack Use and Disposal](#) on page 3-13.

Dolphin 7800 model terminals are designed for use with standard battery pack model 7800-BTSC (Li-ion 3.7 V, 8.9 watt hour) and extended battery pack models 7800-BTXC and 7800-BTXCW (Li-ion 3.7 V, 14.8 watt hour) manufactured for Honeywell International Inc.

The terminal is shipped with the battery packaged separate from the unit. Perform the steps illustrated below to install the main battery. For information on how to remove the battery, see [Replacing the Main Battery Pack](#) on page 2-4.

Note: The terminal does not power ON unless the battery is locked .

 Ensure all components are dry prior to placing the battery in the terminal. Mating wet components may cause damage not covered by the warranty.

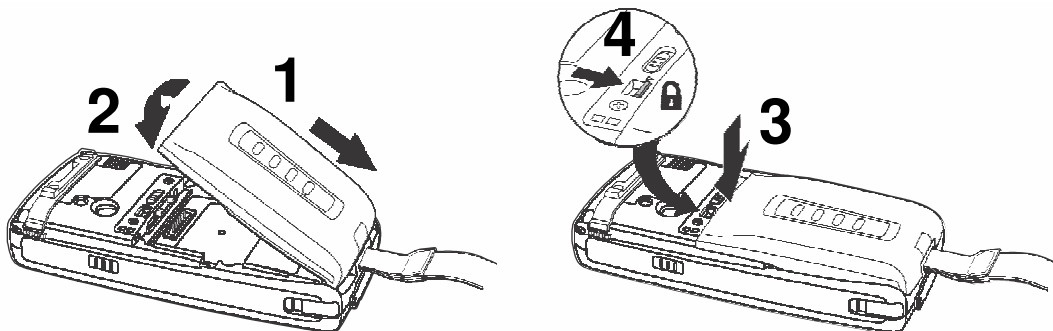

Step 3. Charge the Main and Backup Batteries

The power supply for Dolphin terminals consists of two types of battery power: the main battery pack that is accessible from the back panel, and the backup battery that resides inside the terminal. The main battery powers the terminal. The internal backup battery charges off the main battery and maintains the application data stored in RAM memory for up to 5 minutes when the terminal's main battery pack is completely discharged or removed.

Dolphin 7800 terminals are designed for use with the following 7800 charging devices and cables: 7800-HB, 7800-EHB, 7800-NB, 7800-CB, 7800-DEX, 7800-MC, 7800-MB, 7800-USB, and 7800-USBH. See Chapters 12-17 for additional information on the individual device requirements.

Before Initial Use

Terminals are shipped with both batteries discharged of all power. The initial charging time for the main battery pack is 4 hours for the standard battery pack or 6 hours for the extended battery pack. Connect the terminal to one of the 7800 series charging peripherals to charge; see [Peripherals for the 7800](#) on page 3-3.

Note: Honeywell recommends charging the Dolphin terminal for at least 24 hours prior to initial use to ensure the internal backup battery is fully charged.

 We recommend use of Honeywell peripherals, power cables, and power adapters. Use of any non-Honeywell peripherals, cables, or power adapters may cause damage not covered by the warranty.

Charging Using the Communication Cable

 Ensure all components are dry prior to mating terminals/batteries with peripheral devices. Mating wet components may cause damage not covered by the warranty.

Client Device Communication Cable (7800-USB)

Use only a UL Listed power supply, which has been qualified by Honeywell with an output rated at 5VDC and 3A with the device.

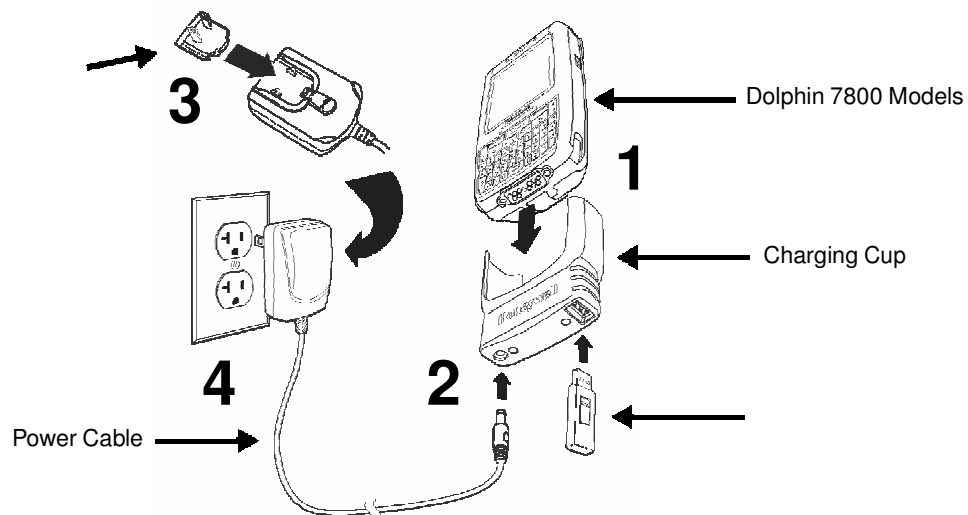

Host Device Communication Cable (7800-USBH, 7800-DEX)

Use only a UL Listed power supply, which has been qualified by Honeywell with an output rated at 5VDC and 3A with the device.

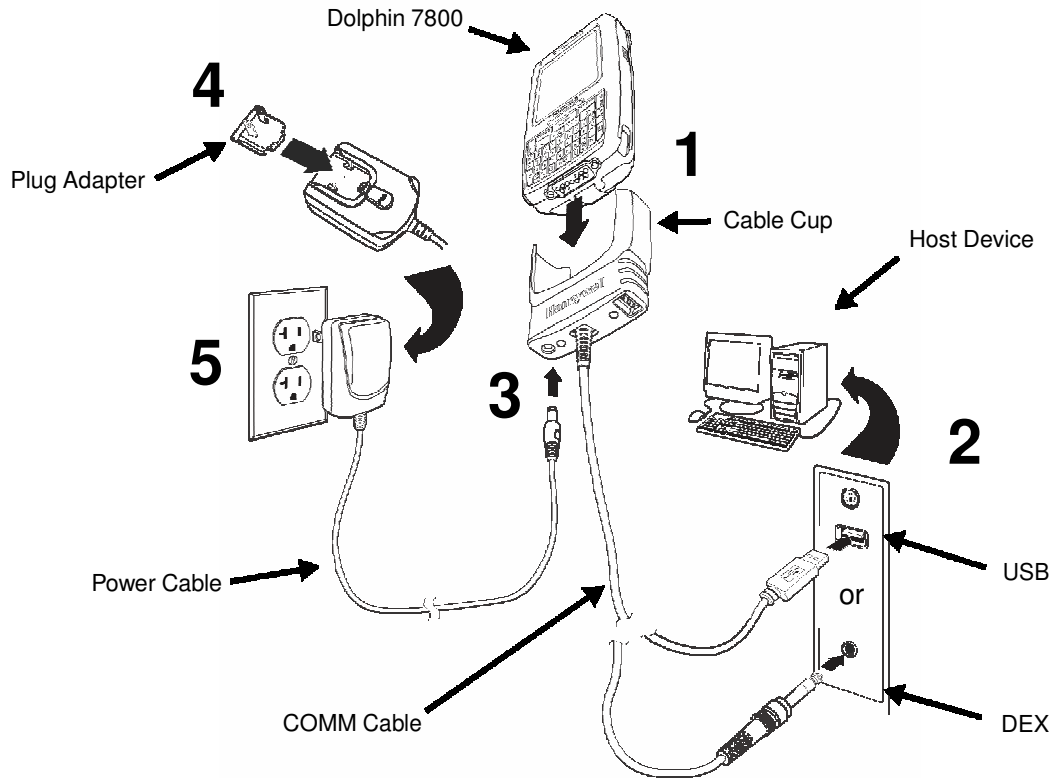

Battery Error Notification

If your terminal displays the following indicators, replace the main battery pack with a Honeywell battery pack. For information on how to remove the main battery pack from the terminal, see [Replacing the Main Battery Pack](#) on page 2-4.

- An “Authentication Error” pop up window appears during startup.
-  appears in the Title bar at the top of the touch screen.
- The General Notification LED flashes red.
- A Notification appears on the Tile bar at the bottom of the touch screen.

Step 4. Boot the Terminal

The terminal begins booting as soon as power is applied. Do NOT press any keys or interrupt the boot process. When the boot process is complete, the Home screen appears, and the terminal is ready for use.

Step 5. Set the Time Zone, Time, and Date

On the Home screen, tap the line that displays the time and date. When the Clock & Alarms screen appears, tap the arrow to the right of the time zone to open the drop down menu. Select the appropriate time zone from the menu. Set the correct time and date in the remaining fields and tap **OK** to save.

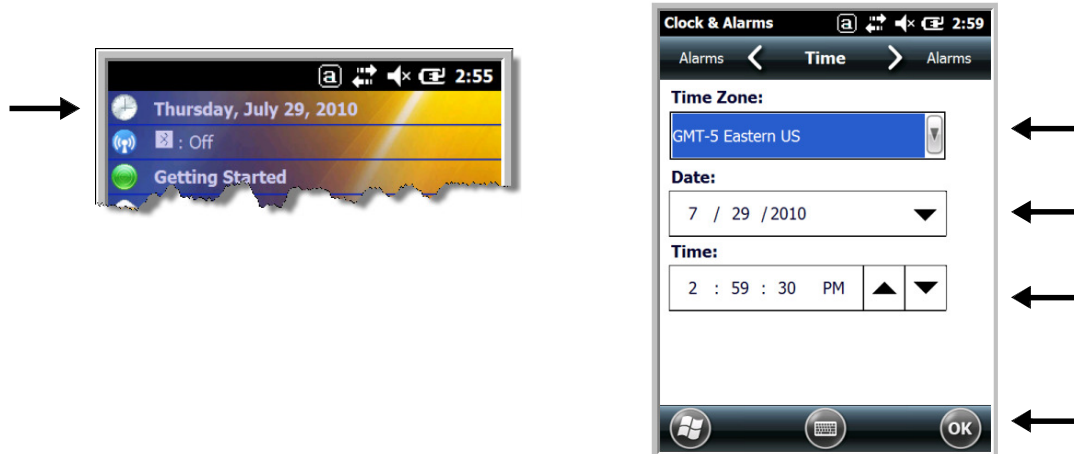

Replacing the Main Battery Pack

Note: Before replacing the main battery pack, read the [Guidelines for Battery Pack Use and Disposal](#) on page 3-13.

 Ensure all components are dry prior to mating terminals/batteries with peripheral devices. Mating wet components may cause damage not covered by the warranty.

1. Press and hold the Power key  for approximately 5 seconds to put the terminal in [Suspend Mode](#) (see page 2-11).
2. Release the hand strap near the speaker on the back panel of the terminal.
3. Unlock the battery by sliding the latch away from the battery.
4. **Wait at least 3 seconds**, then slide the battery release button away from the stylus slot.
5. Remove the battery.

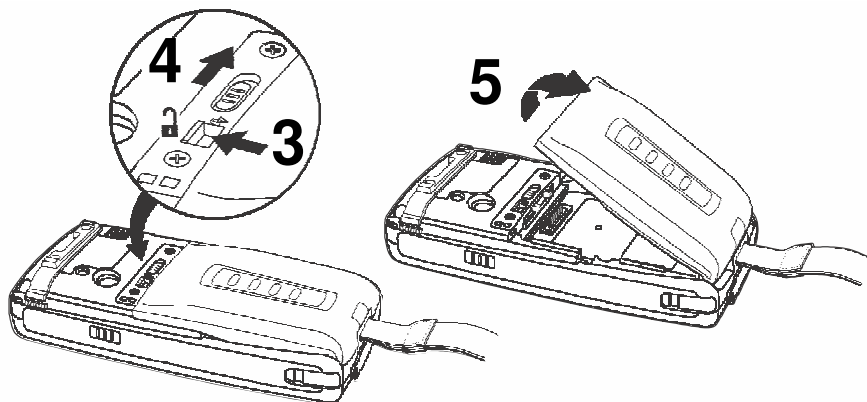

6. Insert the new battery and apply gentle pressure to engage the latch.

Note: Make sure the stylus tether is not caught under the battery during installation.

7. Lock the battery by sliding the latch toward the battery pack.

Note: The terminal does not power ON unless the battery is locked.

8. Reattach the hand strap.

9. Press the Power key or the SCAN key to wake the terminal from [Suspend Mode](#) (see page 2-11).



We recommend use of Honeywell Li-ion battery packs. Use of any non-Honeywell battery may result in damage not covered by the warranty.

Home Screen

After the Dolphin terminal initializes the first time, you see the Home screen.

Tap  to reach the Start screen from the Home screen. Tap

 to access the [Dolphin Wireless Manager](#) (see page 8-4) from the home screen.

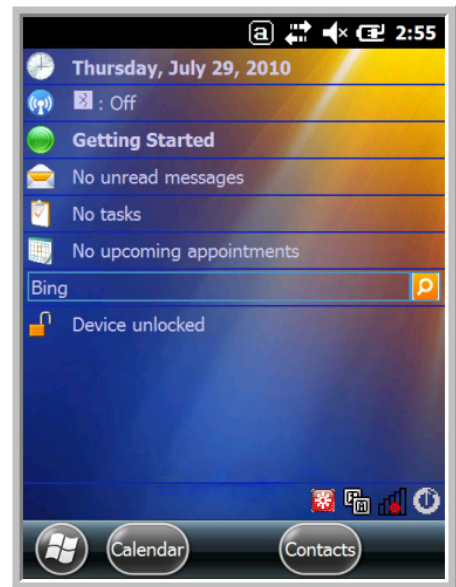

Title Bar





The Title bar, located at the top of the screen, displays the active program, the status of various system functions, and the current time. Tapping on the title bar provides access to the Horizontal Scroll. The scroll provides access to additional programs and application screens. For additional information, see [Horizontal Scroll](#) on page 2-8.

Text here indicates the active program.























Icons here indicate the status of various system functions.

Icons in the Title Bar

Indicator	Meaning
	Synchronizing data
	The terminal could not synchronize data with the workstation via ActiveSync.
	New e-mail
	New text message





















DRAFT COPY 11/11/11

Icons in the Title Bar

Indicator	Meaning
	New voicemail
	New instant message
	Vibrate on
	Ringer off
	Speakerphone on
	Voice call in progress
	Calls are forwarded
	Call on hold
	Missed call
	Data call in progress
	A battery error has occurred. Replace the main battery pack with a Honeywell Li-ion battery pack.
	Battery is has a full charge
	Battery has a high charge
	Battery has a medium charge
	Battery has a low charge
	Battery has a very low charge and requires charging
	Terminal is running on external power. If a battery pack is installed, the battery is charging in the background.
	The terminal is not connected to external power. A battery is installed, but is defective; specifically, its charge level cannot be measured.
	No SIM card is installed
	Active network connection
	No active network connection

DRAFT COPY 11/11/11

Icons in the Title Bar

Indicator	Meaning
	GPRS available
	GPRS connecting
	GPRS in use
	HSDPA available
	HSDPA connecting
	HSDPA in use
	EDGE available
	EDGE connecting
	EDGE in use
	UMTS available
	UMTS connecting
	UMTS in use
	Radio is off
	The radio is not connected to a network.
	The radio is connected. The bars indicate the signal strength.
	No radio signal
	The terminal is searching for a signal.
	Wi-Fi is on, but device is not connected
	Wi-Fi data call
	Pending alarm
	Bluetooth

Horizontal Scroll

The Horizontal Scroll, located at the top of most application windows, provides access to additional application screens. You can flick left or right on the scroll or tap each label on the scroll, until you get to the desired screen. Tapping a label to the left or right of the center item brings new labels into view.

Note: Tap the Title bar to access the horizontal scroll if it is not visible on the screen.

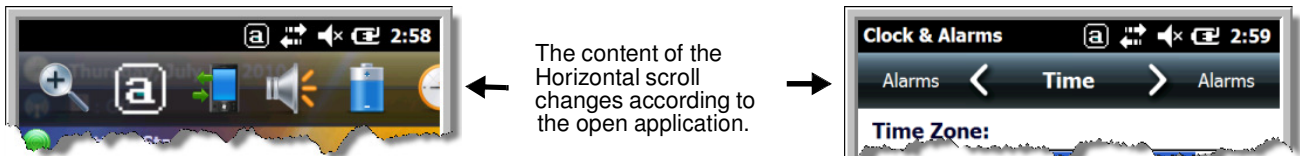

Tile Bar

The Tile bar is located at the bottom of application windows.

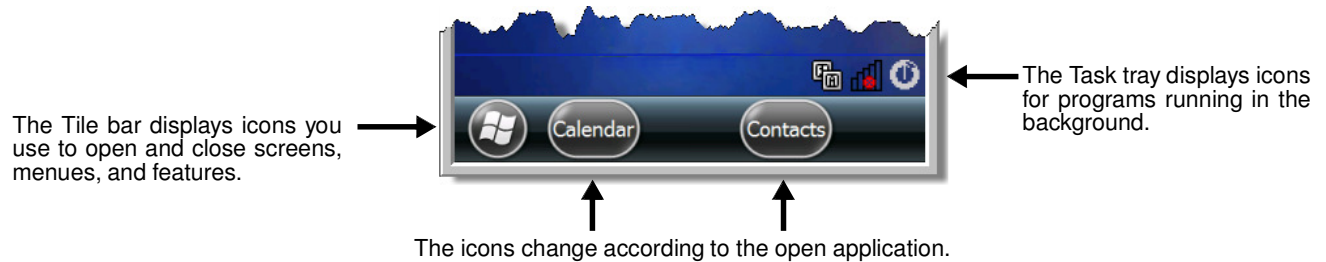

Pop-Up Menus

With pop-up menus, you can quickly choose an action for a selected item. To access a pop-up menu, tap and hold the stylus on the item name of the action you want to perform. When the menu appears, lift the stylus, and tap the action you want to perform.

Tap anywhere outside the menu to close the menu without performing an action.

Selecting Programs

To see the programs loaded on your terminal, tap  to access the Start Menu. To open a program, tap once on the program icon. To reposition an icon on the Start Menu, tap and hold the stylus on the icon, then drag the icon to the desired position.

File Explorer

You can also use the File Explorer to find files and organize these files into folders.

1. Tap  > File Explorer .

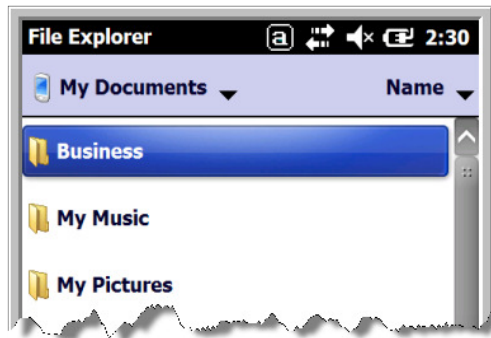

2. Tap the **Up** button at the bottom of the screen to move up one level in the directory.



3. You can move files in File Explorer by tapping and holding on the item you want to move, then tapping **Cut** or **Copy** on popup menu.
4. Navigate to the folder you want to move the file to, then tap and hold a blank area of the window.
5. Tap **Paste** on the pop-up menu.

Note: If there is no blank space available in the window, tap **Menu** on the command bar, navigate to the end of the menu using the down arrow, then tap **Edit > Paste**.

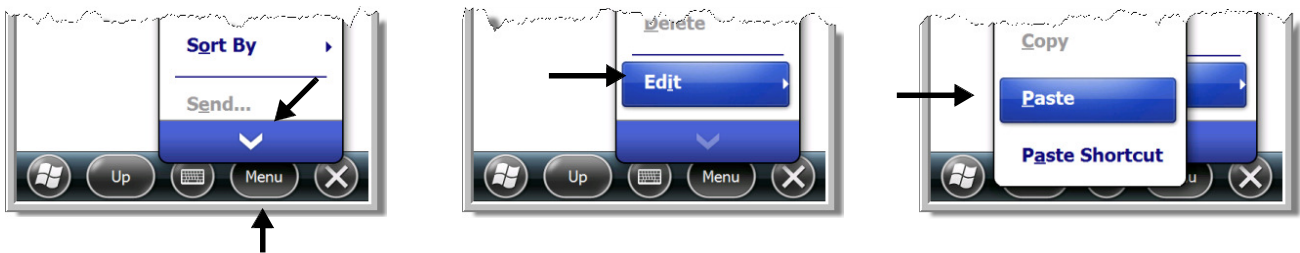

File Provisioning on the 7800

`\IPSM\Honeywell`

The IPSM folder is the only partition on the 7800 that persists across a kernel upgrade (*.UPG file extension). During a kernel upgrade, files are automatically copied from the `\IPSM\Honeywell\Autoinstall` folder and then installed in the `\Honeywell` (root file system) folder as part of the upgrade process.

`\IPSM\Honeywell\AutoInstall`

The files in the `IPSM\Honeywell\AutoInstall` folder are only installed when a factory reset or kernel upgrade occurs. Once the files are installed, they persist through hard and soft resets. If a file is added to the folder and a hard or soft reset is performed, it will have no effect. If a program is manually removed using the Remove Programs application (see page 7-16), then the program is not automatically re-installed on a hard or soft reset.

`\Honeywell`

The Honeywell partition or root file system partition is persistent over a Hard Reset, Soft Reset, and the removal of the battery pack or the removal of AC power. However, during a kernel upgrade the root file system is reformatted so all data in the folder is deleted and replaced by any files in the `\IPSM\Honeywell\AutoInstall` folder as part of the upgrade process.

 To prevent data loss, back up all user data to an SD card or external memory device before performing an upgrade.

`\Honeywell\AutoInstall`



If you run a CAB file from within the `\Honeywell\AutoInstall` (user store) folder, after the program has been installed, the CAB file will be deleted from the User Store. The program remains installed through all successive Hard and Soft resets.

If you want the program to be part of the Autoinstall that occurs after a factory reset or software upgrade, paste the program file(s) in both the `\IPSM\Honeywell\Autoinstall` folder and the `\Honeywell\Autoinstall`.

Contact a Honeywell technical support representative for information on how to perform a factory reset or for information on available software upgrades for your Dolphin terminal. For contact information, see [Customer Support](#) on page 18-1. or go to www.honeywellaidc.com.

 To prevent data loss, back up all user data to an SD card or external memory device before performing an upgrade.

Search

The Search feature helps you quickly locate information. Tap  > **Search Phone** .



Enter the text you want to find, select a data type, and then tap **Search**. Select **Larger than 64 KB** in the **Type** drop-down field to quickly find information that is taking up storage space.

Resetting the Terminal

There are three types of system resets: a soft reset, a hard reset, or a factory reset. The soft and hard resets preserve all data stored in the file system. Contact a Honeywell technical support representative for more information on how to perform a factory reset.



Soft Reset (Warm Boot)

A soft reset re-boots the device and preserves any objects created in RAM. You would perform a soft reset when: the terminal fails to respond, after installing some software applications, or after making changes to certain system settings, such as network cards.

1. Press and hold the BLUE  + END  keys for approximately 5 seconds.
2. The general notification LED flashes orange then green for approximately 3 seconds as the terminal resets.
3. When the reset is complete, the Home screen displays.

Hard Reset (Cold Boot)

A hard reset re-boots the device and closes any open applications running in RAM at the time of the reset.

1. Press and hold the BLUE  + SEND  keys for approximately 5 seconds.
2. The general notification LED flashes orange then green for approximately 3 seconds as the terminal resets.
3. The terminal re-initializes.

Factory Reset

Contact a Honeywell technical support representative for information on how to perform a factory reset. For contact information, see [Customer Support](#) on page 18-1.

Suspend Mode

The terminal goes into Suspend Mode automatically when the terminal is inactive for a programmed period of time. You can program this time on the Advance tab of the Power System Setting; see [Power](#) on page 7-15.

To put the terminal into Suspend Mode manually, press and hold the POWER key  for approximately 5 seconds until the touch screen turns off.

To wake the terminal from Suspend Mode, press the POWER key  or SCAN key.

Note: You should always put the terminal in suspend mode before removing the battery. For information on removing the battery, see [Replacing the Main Battery Pack](#) on page 2-4.

DRAFT COPY 11/11/11

Hardware Overview

Standard Configurations for the 7800

WLAN & WPAN

- Microsoft Windows Embedded Handheld 6.5 Classic
- 800MHz TI OMAP Processor
- 256MB RAM X 512MB Flash
- Six keyboard options
- 3.7V Li-ion standard battery pack or extended rechargeable battery pack
- Adaptus Imaging Technology: N5603ER/SR/HD or N5600ER/SR/HD image engines
- 802.11a/b/g/n and Bluetooth

WLAN, WPAN, with GPS

- Microsoft Windows Embedded Handheld 6.5 Classic
- 800MHz TI OMAP Processor
- 256MB RAM X 512MB Flash
- Six keyboard options
- 3.7V Li-ion standard battery pack or extended rechargeable battery pack
- Adaptus Imaging Technology: N5603ER/SR/HD or N5600ER/SR/HD image engines
- 802.11a/b/g/n and Bluetooth
- GPS

WLAN, WPAN, & WWAN

- Microsoft Windows Embedded Handheld 6.5 Professional
- 800MHz TI OMAP Processor
- 256MB RAM X 512MB Flash
- Six keyboard options
- 3.7V Li-ion extended rechargeable battery pack
- Adaptus Imaging Technology: N5603ER/SR/HD or N5600ER/SR/HD image engines
- 802.11a/b/g/n, Bluetooth, and GSM/HSPA+

WLAN, WPAN & Camera

- Microsoft Windows Embedded Handheld 6.5 Classic
- 800MHz TI OMAP Processor
- 256MB RAM X 512MB Flash
- Six keyboard options
- 3.7V Li-ion standard battery pack or extended rechargeable battery pack
- Adaptus Imaging Technology: N5603ER/SR/HD or N5600ER/SR/HD image engines
- 802.11a/b/g/n and Bluetooth
- 3.0 megapixel auto control color camera

WLAN, WPAN, with GPS & Camera

- Microsoft Windows Embedded Handheld 6.5 Classic
- 800MHz TI OMAP Processor
- 256MB RAM X 512MB Flash
- Six keyboard options
- 3.7V Li-ion standard battery pack or extended rechargeable battery pack
- Adaptus Imaging Technology: N5603ER/SR/HD or N5600ER/SR/HD image engines
- 802.11a/b/g/n and Bluetooth
- GPS
- 3.0 megapixel auto control color camera

WLAN, WPAN, & WWAN with GPS

- Microsoft Windows Embedded Handheld 6.5 Professional
- 800MHz TI OMAP Processor
- 256MB RAM X 512MB Flash
- Six keyboard options
- 3.7V Li-ion extended rechargeable battery pack
- Adaptus Imaging Technology: N5603ER/SR/HD or N5600ER/SR/HD image engines
- 802.11a/b/g/n, Bluetooth, and GSM/HSPA+
- GPS

WLAN, WPAN, WWAN with GPS & Camera

- Microsoft Windows Embedded Handheld 6.5 Professional
- 800MHz TI OMAP Processor
- 256MB RAM X 512MB Flash
- Six keyboard options
- 3.7V Li-ion extended rechargeable battery pack
- Adaptus Imaging Technology: N5603ER/SR/HD or N5600ER/SR/HD image engines
- 802.11a/b/g/n, Bluetooth, and GSM/HSPA+
- GPS
- 3.0 megapixel auto control color camera

WLAN, WPAN, & WWAN

- Microsoft Windows Embedded Handheld 6.5 Professional
- 800MHz TI OMAP Processor
- 256MB RAM X 512MB Flash
- Six keyboard options
- 3.7V Li-ion extended rechargeable battery pack
- Adaptus Imaging Technology: N5603ER/SR/HD or N5600ER/SR/HD image engines
- 802.11a/b/g/n, Bluetooth, and GSM/CDMA

WLAN, WPAN, & WWAN with GPS

- Microsoft Windows Embedded Handheld 6.5 Classic
- 800MHz TI OMAP Processor
- 256MB RAM X 512MB Flash
- Six keyboard options
- 3.7V Li-ion extended rechargeable battery pack
- Adaptus Imaging Technology: N5603ER/SR/HD or N5600ER/SR/HD image engines
- 802.11a/b/g/n, Bluetooth, and GSM/CDMA
- GPS

WLAN, WPAN, WWAN with GPS & Camera

- Microsoft Windows Embedded Handheld 6.5 Classic
- 800MHz TI OMAP Processor
- 256MB RAM X 512MB Flash
- Six keyboard options
- 3.7V Li-ion extended rechargeable battery pack
- Adaptus Imaging Technology: N5603ER/SR/HD or N5600ER/SR/HD image engines
- 802.11a/b/g/n, Bluetooth, and GSM/HSPA+ or GSM/CDMA
- GPS
- 3.0 megapixel auto control color camera

Some configurations of the 7800 terminal are available with an external housing made of plastic that is specifically designed for the healthcare industry. For more information, see [Healthcare Housing](#) on page 3-11.

Peripherals for the 7800

Each of the following items is sold separately to enhance the capabilities of your Dolphin terminal.

Dolphin 7800 HomeBase™ Device

The Dolphin 7800 HomeBase device is a charging and communication cradle equipped with a USB host port that is Hi-Speed 2.0v compliant, which enables the terminal to interface with the majority of PC-based enterprise systems. This device also contains an auxiliary battery well that charges a spare Honeywell standard or extended battery pack.

For more information, see [Dolphin 7800 HomeBase Device \(Model 7800-HB\)](#) on page 12-1.

Dolphin 7800 Mobile Base™ Device

The Dolphin 7800 Mobile Base device is a charging and communication cradle designed specifically for in-premise and in-transit data collection applications. It features a flexible mounting bracket and a cigarette lighter adapter to adapt it to your environment.

For more information, see [Dolphin 7800 Mobile Base Device \(Model 7800-MB\)](#) on page 14-1.

Dolphin 7800 eBase™ Device

The Dolphin 7800 Ethernet (eBase) device enables a single 7800 mobile computer to communicate with a host device over an Ethernet network. In addition, the ebase is equipped with a USB host port that is Hi-Speed 2.0v compliant, which enables the terminal to interface with the majority of PC-based enterprise systems. This device also contains an auxiliary battery well that charges a spare Honeywell standard or extended battery pack.

For more information, see [Dolphin 7800 eBase Device \(Model 7800-EHB\)](#) on page 13-1.

Dolphin 7800 Net Base™ Device

The Dolphin 7800 Net Base device enables up to four 7800 mobile computers to communicate with a host device over an Ethernet network. In addition, the Net Base provides a second RJ45 Ethernet port for connection to an additional device such as a printer, workstation, eBase, or another Net Base.

For more information, see [Dolphin 7800 Net Base Device \(Model 7800-NB\)](#) on page 16-1.

Dolphin 7800 ChargeBase

The Dolphin 7800 ChargeBase is a 4-slot charging cradle that holds, powers, and charges terminals.

For more information, see [Dolphin 7800 ChargeBase Device \(Model 7800-CB\)](#) on page 15-1.

Dolphin 7800 QuadCharger™ Device

The Dolphin 7800 QuadCharger device is a 4-slot charging station for Dolphin 7800 standard or extended battery packs.

For more information, see [Dolphin 7800 QuadCharger Device \(Model 7800-QC\)](#) on page 17-1.

Accessories for the 7800

Each of the following items is sold separately to enhance your terminal's capabilities.

Note: When using accessories where the terminal is worn on the body, the terminal's touch panel must face away from the body.

Dolphin 7800 Mobile Charger

The Dolphin 7800 Mobile Charger is a charging cable that connects the terminal directly to a 12 Volt DC power source, such as a cigarette lighter port inside a vehicle, eliminating the need for a cradle. Intelligent battery technology on-board the terminal ensures proper charging. The Dolphin 7800 Mobile Charger is an ideal low-cost charging solution for in-transit mobile applications.

Communication/Charging Cables

Dolphin communication/charging cable kits are an all-in-one solution for mobile applications. Each cable kit powers the terminal, charges its main battery, and communicates with host or peripheral devices without the need for a cradle. Cable kits can support USB client or USB host communications.

Storage Holster

The storage holster provides convenient storage for the Dolphin terminal in mobile environments. The holsters feature a belt loop to secure the holster to a belt.

Stylus Kits

Each Dolphin is shipped with a stylus and a stylus tether used to secure the stylus to the terminal to prevent loss. Kits containing three styli and three tethers are available for purchase.



Battery Pack

The rechargeable battery pack provides the main power for the terminal. For more information, see [Batteries](#) on page 3-12.

Front Panel: 7800

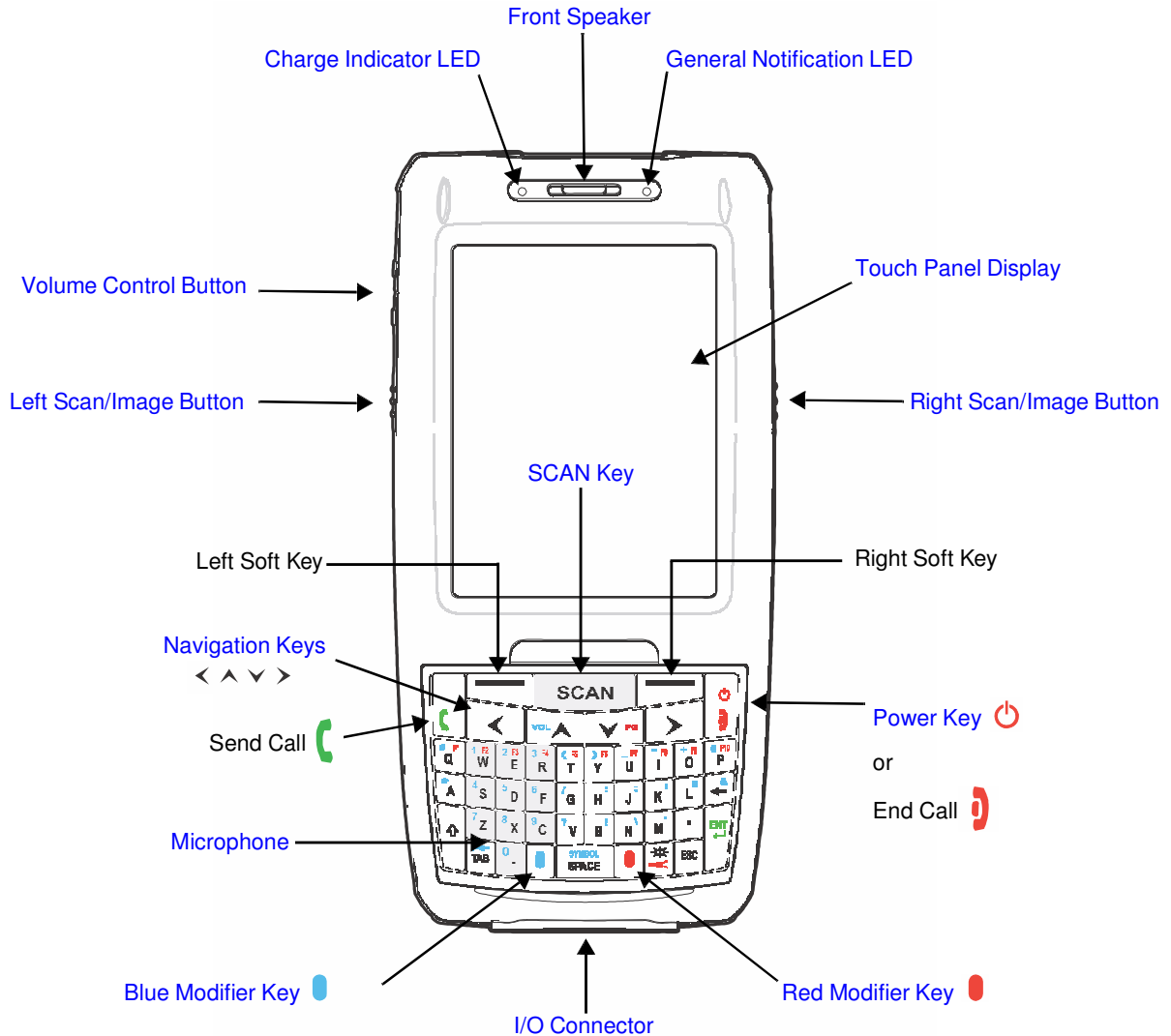

Note: Your Dolphin model may differ from the model illustrated; however, the features noted are standard for all 7800 models unless otherwise indicated. For a complete overview of the optional keyboards available for the 7800, see [Using the Keyboards](#) on page 6-1.

For a description of each callout, see [Front Panel Features for the 7800](#) on page 3-6.

Front Panel Features for the 7800

Blue Modifier Key

See [Using the Modifier Keys](#) on page 6-3.

Charge Indicator LED

The light emitting diode (LED) located above the top left corner of the LCD display illuminates when the Power Tools **BattMon** application is enabled and the device is on AC charge. For more information, consult the Dolphin Power Tools User's Guide for Windows Embedded Handheld 6.5.

Front Speaker

The front speaker is the receiver for handset voice calls. See [GSM/HSPA+ Global Radio Dolphin Models](#) on page 9-3.

General Notification LED

The light emitting diode (LED) located above the top right corner of the LCD display flashes and illuminates during resets, scanning/imaging, and taking a picture. This LED can be programmed by various software applications.

Left Scan/Image Button

By default, the Left Button triggers the scanner/imager. You can reassign the button to launch applications or execute commands. For additional information, see [Changing Button Assignments](#) on page 7-4.

Microphone

The integrated microphone that provides audio input for handset and speakerphone voice calls. See [Voice Communication](#) on page 9-3.

Navigation Keys

The centrally located navigation keys enable you to move and position the cursor through software programs. The up and down arrows are programmed to perform specific functions when pressed in combination with the Blue and Red modifier keys. For more details, see [Using the Navigation Keys](#) on page 6-3.

Power Key

The Power key, located in the upper right corner of the keypad, puts the terminal in Suspend Mode or wakes the terminal from Suspend Mode. See [Suspend Mode](#) on page 2-11. The key is also used to end/disconnect a phone calls.

There are multiple keyboard options available for the 7800. For a complete overview of each keyboard, see [Using the Keyboards](#) on page 6-1.

Red Modifier Key

See [Using the Modifier Keys](#) on page 6-3.

Right Scan/Image Button

By default, the Right Button triggers the scanner/imager. You can reassign the button to launch applications or execute commands. For additional information, see [Changing Button Assignments](#) on page 7-4.

SCAN Key

The SCAN key is centrally located for easy access with the right or left hand. When pressed, the SCAN key activates the scanner/imager. The SCAN key also functions as a system wake-up control for the terminal.

Touch Panel Display

The color 3.7 inch 64k color liquid crystal display (LCD) touch panel is covered with an industrial, protective lens for greater durability. The video graphic array (VGA) display resolution is 480 X 640.

The touch panel backlight illuminates when the screen is touched, but not when the Backlight key is pressed. For more information, see [Backlight](#) on page 7-9.

The touch panel can be activated by the stylus (included with the terminal). For more information, see [Using the Touch Panel](#) on page 3-11.

Volume Control Button

Press the top or bottom of the volume button to raise or lower the volume of the active speaker.

Back Panel: 7800

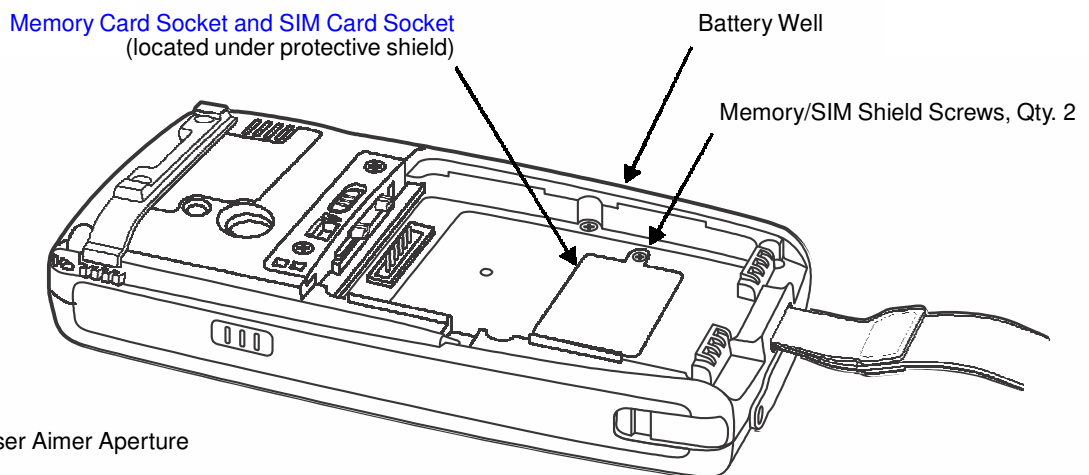
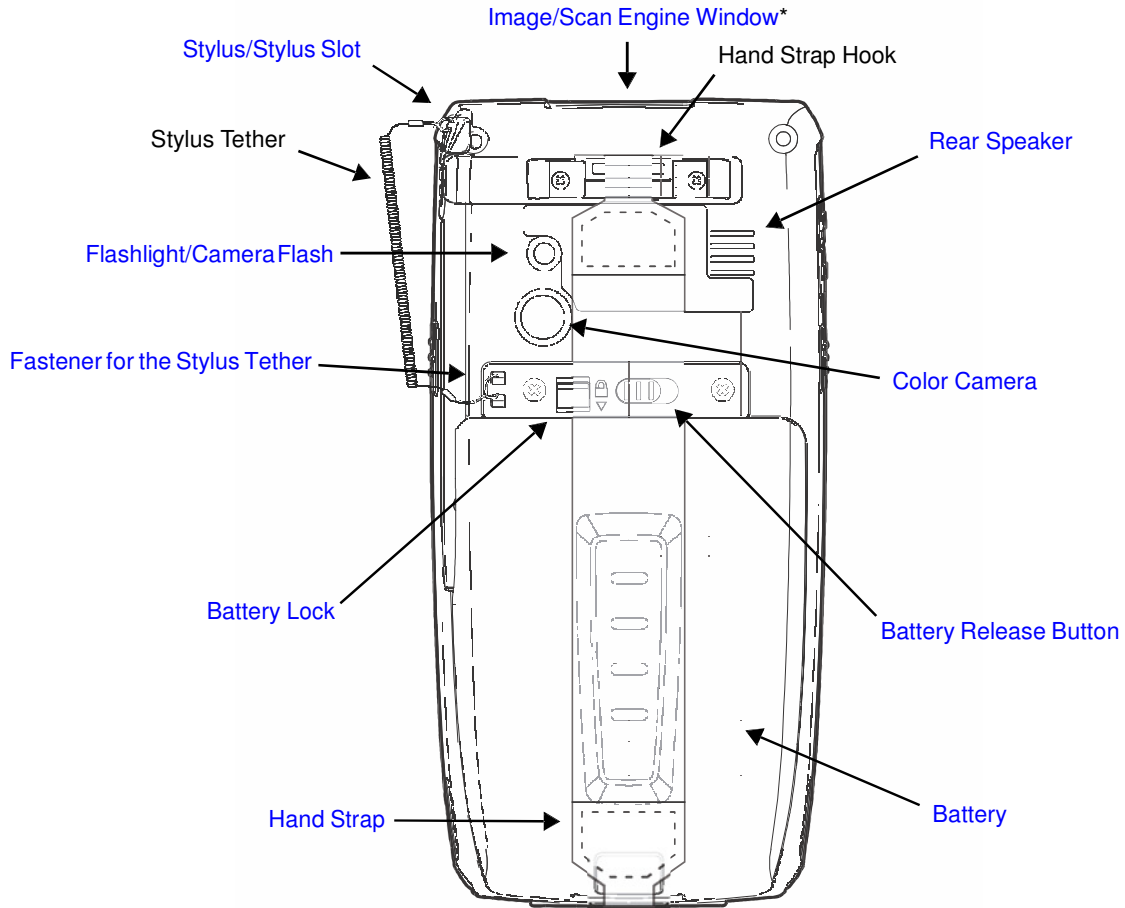

* LED and Laser Aimer Aperture

Note: Your Dolphin model may differ from the model illustrated; however, the features noted are standard for all 7800 models unless otherwise indicated.

For a description of each callout, see [Back Panel Features for the 7800](#) on page 3-9.

Back Panel Features for the 7800

Battery

Dolphin 7800 model terminals are designed for use with standard battery pack model 7800-BTSC (Li-ion 3.7 V, 8.9 watt hour) and extended battery pack models 7800-BTXC and 7800-BTXCW (Li-ion 3.7 V, 14.8 watt hour) manufactured for Honeywell International Inc. For information on how to remove the battery, see [Replacing the Main Battery Pack](#) on page 2-4.

Battery Lock

The Battery Lock allows the user to lock the battery pack in place preventing battery loss due to accidental activation of the battery release. The battery release button has no effect if the Battery lock is engaged. The terminal does not power ON unless the Battery Lock is engaged.

Battery Release Button

The Battery Release Button ejects one end the battery from the terminal for easy battery removal. The battery release button has no effect if the Battery lock is engaged. For information on how to remove the battery, see [Replacing the Main Battery Pack](#) on page 2-4.

Color Camera

The 3.0-Megapixels Resolution color camera provides easy picture capture with Automated Camera Control (ACC). Additional features include automated picture profiles and an Application Programming Interface (API).

Fastener for the Stylus Tether

The Stylus Tether helps prevent accidental loss when the stylus is not stored in the stylus slot. A stylus tether is a coiled, elastic cord that tethers the stylus to the terminal. Secure one end of the cord to the back panel of the terminal and the other end to the stylus.

Flashlight/Camera Flash

The flashlight/camera flash is located on the back panel of the terminal. When used as a Flashlight, press the Red key +  key to turn the flashlight ON or OFF. When used as a Camera Flash with the terminal's color camera, the flash is controlled by the camera application.

Hand Strap

The 7800 comes with an elastic hand strap. One end of the hand strap can be released to provide easy access to the battery pack. The hand strap release hook is located near the speaker on the back panel of the terminal.

Image/Scan Engine Window

The available image engines read and decode linear, stacked linear (e.g., PDF417), and 2D matrix bar code symbologies. Some of the available engine models contain a laser aimer for greater accuracy. The laser apertures for the imaging engines' laser aimers are contained behind this window. For more details, see [Using the Scan Image Engine](#) on page 4-1.

Memory Card Socket and SIM Card Socket

The memory card socket provides the user with the option to expand the terminal's memory capacity using industry-standard microSD or microSDHC memory interfaces. The expansion socket is located under the main battery in the battery well. The card socket for the Subscriber Identity Module (SIM) is also located under the main battery in the battery well.

When the protective SIM/memory card cover and battery pack are properly installed, the cards are sealed against moisture and particle intrusion, read/write data is stored securely, and the terminal's environmental rating is preserved; see [Installing a SIM Card and/or Memory Card](#) on page 3-16.

Rear Speaker

The integrated rear speaker sounds audio signals as you scan bar code labels and enter data. The integrated speaker also supports playback of wave and MP3 files, software mixer, and Speakerphone for WWAN/GSM audio. The operating frequency range is 600-3000Hz at >90dB.

Stylus/Stylus Slot

The stylus is used to operate the touch panel. The back panel of the terminal features a storage slot to hold the stylus when not in use. The stylus features a special tip for added accuracy and ease of use.

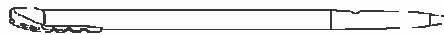

Bottom Panel: 7800

Pin	Description
1	PWR
2	PWR
3	USB1 HOST D-
4	USB1 HOST 5V OUT
5	USB1 HOST D+
6	A_GND
7	USB Client D+
8	USB Client VBUS
9	USB Client D-
10	GND
11	GND

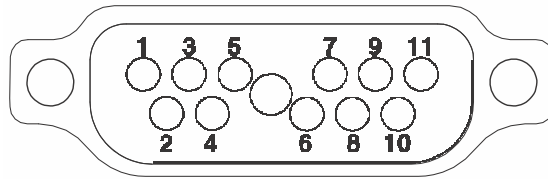

Note: Signals referenced are for a DTE device.

I/O Connector

The I/O connector powers the terminal, charges the main battery, and facilitates communication. All Dolphin peripherals are designed to work exclusively with this connector. The I/O connector supports high speed USB v2.0 communication with a maximum rate of 480 Mbps.

I/O Power Out

The I/O connector also provides power out (to peripheral devices) +5V at 500mA. This means that, with the proper cable, the terminal can power another device. By default, power out is disabled, but the 5V output may be enabled, see [Five Volt Control](#) on page 7-12.

Using the Touch Panel

Honeywell defines proper use of the terminal touch panel as using a screen protector and proper stylus. Screen protectors maintain the ongoing integrity (i.e., prevent scratching) of the touch panel, which is why their use is recommended for applications that require a high to medium level of interface with the touch panel, such as signature capture for proof of delivery.

Honeywell advocates the use of screen protectors on all Dolphin devices. We recommend implementing a screen protector replacement program to ensure that screen protectors are replaced periodically when signs of damage/wear are noticeable.

Replacement screen protectors can be purchased directly from Honeywell. Please contact a Honeywell sales associate for details.

Honeywell also mandates use of a proper stylus, which is one that has a stylus tip radius of no less than 0.8 mm. Use of the Honeywell stylus included with the terminal is recommended at all times.

Honeywell warranty policy covers wear on the touch panel for the first twelve (12) months if a screen protector is applied and an approved stylus is used for the 12 month duration covered by the warranty.

Installing a Screen Protector

Dolphin terminals ship with a screen protector already installed. You will need to replace the screen protector at regular intervals.

1. After the current screen protector has been removed from the touch panel, clean the touch panel thoroughly with a clean, non-abrasive, lint-free cloth. Make sure there is no debris on the touch panel.
2. Align the exposed section of the protector with the edge of the touch panel. Make sure that the screen protector is flush with edges of the touch panel. To reposition, lift up gently and reapply.
3. Press the screen protector firmly and carefully across the surface of the touch panel as you peel away the backing.
4. If necessary, smooth out any air pockets or bumps.

Healthcare Housing

Some configurations of the 7800 terminal are available with an external plastic housing that is designed to resist the effects of harsh chemicals in a healthcare environment. The plastic is crystalline in nature, which helps prevent chemicals from seeping through the housing.

Important! The following cleaning solutions have been tested to assure safe cleaning of your terminal's disinfectant-ready housing. They are the only solutions approved for use with these terminals. Damage caused by the use of cleaners other than those listed below may not be covered by the warranty.

- Sani-Cloth[®] Plus wipes
- Gentle dish soap and water

Batteries

There are two types of battery power: the main battery pack installed in the back panel and the backup battery located inside the terminal. They are designed to work together to prevent data loss when the terminal is in use over long periods.

Both batteries must be completely charged before using a Dolphin terminal for the first time!

Main Battery Pack



We recommend use of Honeywell Li-ion battery packs. Use of any non-Honeywell battery may result in damage not covered by the warranty.

Dolphin 7800 model terminals are designed for use with standard battery pack model 7800-BTSC (Li-ion 3.7 V, 8.9 watt hour) and extended battery pack models 7800-BTXC and 7800-BTXCW (Li-ion 3.7 V, 14.8 watt hour) manufactured for Honeywell International Inc.

Charging Options

When the main battery pack is installed in the terminal, use one of the following peripherals:

- [Dolphin 7800 HomeBase Device \(Model 7800-HB\)](#) (see page 12-1)
- [Dolphin 7800 eBase Device \(Model 7800-EHB\)](#) (see page 13-1)
- [Dolphin 7800 Mobile Base Device \(Model 7800-MB\)](#) (see page 14-1)
- [Dolphin 7800 ChargeBase Device \(Model 7800-CB\)](#) (see page 15-1)
- [Dolphin 7800 Net Base Device \(Model 7800-NB\)](#) (see page 16-1)

When the main battery pack is not installed in the terminal:

- Place the battery pack in the [Dolphin 7800 QuadCharger Device \(Model 7800-QC\)](#) (see page 17-1)
- Place the battery pack in the [Auxiliary Battery Well](#) of the [Dolphin 7800 HomeBase Device \(Model 7800-HB\)](#) (see page 12-1) or [Dolphin 7800 eBase Device \(Model 7800-EHB\)](#) (see page 13-1).

For information on how to remove the main battery pack from the terminal, see [Replacing the Main Battery Pack](#) on page 2-4.

Charging Time

The standard battery pack requires 4 hours to charge completely before initial and the extended battery pack requires 6 hours to charge completely before initial use.

Honeywell recommends charging the Dolphin terminal for at least 24 hours prior to initial use to ensure the internal backup battery is fully charged.

Battery Error Notification

If your terminal displays the following indicators, replace the main battery pack with a Honeywell Li-ion 7800 standard or extended battery pack. For information on how to remove the main battery pack from the terminal, see [Replacing the Main Battery Pack](#) on page 2-4.

-  appears in the Title bar at the top of the touch screen.
- The General Notification LED flashes red.
- A Notification appears on the Tile bar at the bottom of the touch screen.

Storing Batteries

To maintain top performance from batteries, avoid storing batteries outside of the following temperature ranges:

- 14°F to 113°F (-10°C to +45°C) for short term storage of less than one month
- 32°F to 86°F (-0°C to +30°C) for long term storage

Do not store batteries in extremely high humidity. For prolonged storage, do not keep batteries stored in a charger that is connected to a power source.

Guidelines for Battery Pack Use and Disposal

The following are general guidelines for the safe use and disposal of batteries:

- Do not disassemble or open crush, bend or deform, puncture or shred.
- Do not modify or remanufacture, attempt to insert foreign objects into the battery, immerse or expose to water or other liquids, expose to fire, explosion or other hazard.
- Improper battery use may result in a fire, explosion or other hazard.
- We recommend use of Honeywell Li-ion battery packs. Use of any non-Honeywell battery may pose a personal hazard to the user.
- Only use the battery for the system for which it is specified. Do not use a battery in any other manner outside its intended use in Dolphin terminals and peripherals.
- Only use the battery with a charging system that has been qualified with the system per standard IEEE-Std-1725-2006. Use of an unqualified battery or charger may present a risk of fire, explosion, leakage, or other hazard.
- Replace the battery only with another battery that has been qualified with the system per this standard, IEEE-Std-1725-2006. Use of an unqualified battery may present a risk of fire, explosion, leakage or other hazard.
- Replace defective batteries immediately; using a defective battery could damage the Dolphin terminal.
- Never throw a used battery in the trash. Promptly dispose of used batteries in accordance with local regulations.
- Do not short-circuit a battery or throw it into a fire; it can explode and cause severe personal injury. Do not allow metallic conductive objects to contact battery terminals.
- If you observe that the Honeywell battery supplied is physically damaged, please send it to Honeywell International Inc. or an authorized service center for inspection, see [Product Service and Repair](#) on page 18-1.
- Avoid dropping the terminal or battery. If the terminal or battery is dropped, especially on a hard surface, and the user suspects damage, send it to a Honeywell International Inc. or an authorized service center for inspection.
- If you are not sure the battery or charger is working properly, send it to Honeywell International Inc. or an authorized service center for inspection, see [Product Service and Repair](#) on page 18-1.
- Excessive discharge can degrade battery performance. Recharge the battery when your terminal indicates low battery power.
- Although your battery can be recharged many times, the battery life is limited. Replace it after the battery is unable to hold an adequate charge.

Internal Backup Battery

Located inside the terminal is a 3.6 Volt nickel metal hydride (NiMH) backup battery. The backup battery prevents the terminal from being reset if you need to replace the main battery pack. It retains RAM data during the battery pack exchange. A fully charged backup battery provides 5 minutes of data backup time.

Note: A fully charged backup battery preserves RTC content for approximately 168 hours when the terminal is in suspend mode and the main battery is not installed or completely depleted of charge.

If at any time the backup battery becomes fully discharged of power (e.g., the terminal is left without the main battery pack for more than 5 minutes), the terminal resets when power is supplied. All files are retained, but you may need to restart any running applications. In addition, a fully discharged backup battery requires a minimum of 24 hours of charging time to reach a full charge.

Note: Data and programs stored in Flash memory are not lost even if the internal backup battery fails.

Charging

The internal backup battery is powered by the main battery pack. Therefore, charging the internal battery requires a charged main battery pack be installed in the terminal and the terminal be connected to a charging device.

The internal backup battery must be fully charged before using the terminal for the first time. Honeywell recommends charging the Dolphin terminal for at least 24 hours prior to initial use to ensure the internal backup battery is fully charged. After that, if the internal backup battery becomes fully discharged of power, it requires a minimum of 24 hours of charging time to function normally.

Guidelines for Use

Follow these guidelines to maximize the life of the internal backup battery:

- Keep a charged battery pack in the terminal; the backup battery prematurely discharges if there is not at least a partially charged battery in the terminal.
- Keep the terminal connected to power when the terminal is not in use.

Managing Battery Power

Letting the backup battery become fully discharged causes the terminal to lose all data in RAM. Honeywell recommends, you keep a charged battery pack in the terminal at all times to help prevent data loss. The internal battery discharges prematurely if there is not at least a partially charged battery in the terminal. When you remove a battery pack, insert another charged battery pack in the terminal immediately.

Default Critical and Low Battery Points

When the terminal is running on battery power (as opposed to external power), warnings are displayed when the battery reaches critical and low battery points. The warning points are determined by the following registry entry:

[HKEY_LOCAL_MACHINE\ControlPanel\Power]

There are two DWORD values in this registry entry: **MedState** and **LowState**.

The default values for these entries are as follows:

MedState=25%

This sets the Low Battery point to 25%. When the battery hits the percentage charge specified here, the user is notified.

LowState=10%

This sets the Critical Battery point to 10%. When the battery hits the percentage charge specified here, the user is notified.

Note: Warnings do not appear when the terminal is on external power.

Setting Critical and Low Battery Points

Developers can reset the battery parameters in the registry from 0 (no warning) to 99 (would nearly always warn). You can review and set these battery points in the RegEdit Power Tool.

1. Tap  > **Power Tools** > **RegEdit**.
2. Drill down to **HKEY_LOCAL_MACHINE** > **ControlPanel** > **Power**.
3. Tap the **Value Name** to change the Value Data.
You can reset the Value Data from 0 (no warning) to 99 (would nearly always warn).
4. Tap **OK** to save changes.

For more information about the RegEdit Power Tool, refer to the Dolphin Power Tools User's Guide available for download at www.honeywellaidc.com.

Checking Battery Power

1. Tap  > **Settings** > **System**
2. Tap **Power** to view the power status of the main battery and backup battery.

Note: The Backup Battery gauge registers either 0% or 100%. The percentage is not an indication of the level of charge remaining on the backup battery. An installed and functional battery registers 100%. A total discharge or a battery error registers 0%.

Or

Tap **Battery** to view detailed information on the installed battery pack.

For additional information on Advanced Power Settings, [see page 7-15](#).

For additional information on the Battery Log Configuration, [see page 7-10](#).

System Resets

See [Resetting the Terminal](#) on page 2-11.

Hardware Maintenance

When needed, clean the image engine window and the LCD display with a clean, non-abrasive, lint-free cloth. The terminal can be cleaned with a damp cloth. For additional information on hardware maintenance specific to the Dolphin Healthcare Housings, [see page 3-11](#).

Installing a SIM Card and/or Memory Card

SIM Card

Short for Subscriber Information Module, a SIM card stores the subscriber's personal information, GSM/GPRS radio settings, security keys, contacts, etc. SIM cards can be installed in compatible mobile devices, enabling you to switch devices without losing personal and setup information.

Before installing the SIM card:

- The service provider **must** activate the SIM card.
- The terminal **must** be powered down.

Note: If no SIM card is installed, you can still make emergency phone calls (e.g., 9-1-1).

Memory Card

You can expand the terminal's memory capacity by installing an industry-standard microSD or microSDHC memory card. Contact a Honeywell sales representative for details on purchasing optional memory cards for your Dolphin terminal. Format all microSD/SDHC cards before initial use.

Installation

1. Press and hold the Power key  for approximately 5 seconds to put the terminal in [Suspend Mode](#) (see page 2-11).
2. Release the hand strap and slide battery latch away from the battery into the unlock position.
3. **Wait at least 3 seconds.** Slide the battery release button away from the stylus slot, then remove the battery.
4. Remove the screws and the protective shield covering the SIM/memory card socket.
5. Unlock the SIM card latch by sliding the latch toward the stylus slot.
6. Lift the latch to reveal the SIM socket and the memory card latch.

Note: If a SIM card is installed, remove the card to reveal the memory card latch.

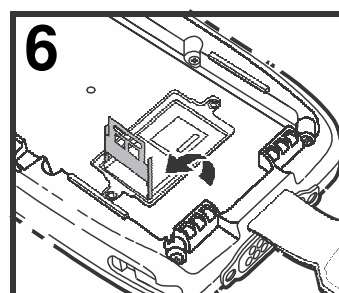
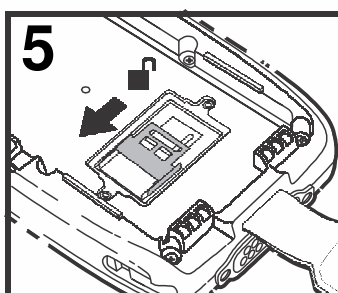
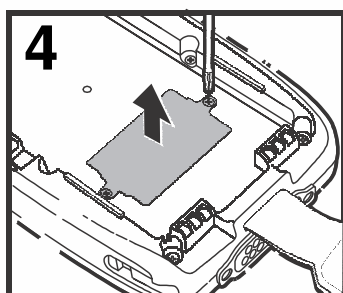

If you are not installing a memory card (i.e., microSD or MicroSDHC card), proceed to step 11.

7. Unlock the memory card latch by sliding the latch toward the top of the terminal.
8. Lift the latch to expose the memory socket.
9. Insert the MicroSD or MicroSDHC card.

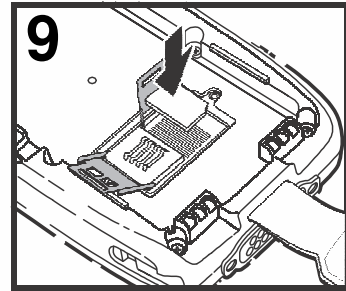
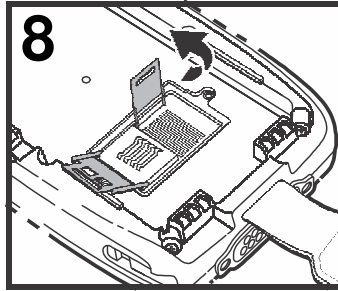
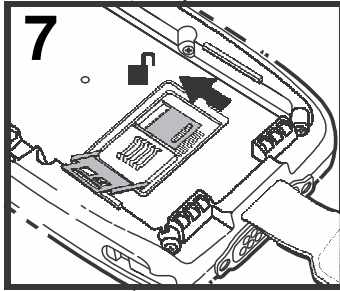

10. Close and lock the memory card latch.

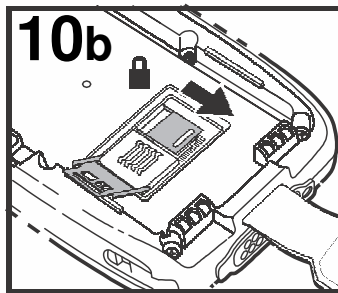
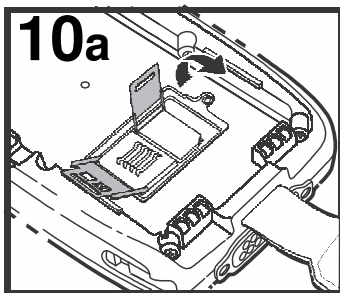

11. Insert the SIM card. Align the chamfered corner of the card with the chamfered corner of the socket.
12. Close and lock the SIM card latch.

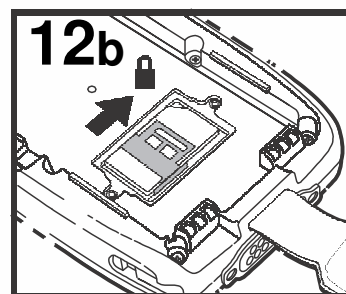
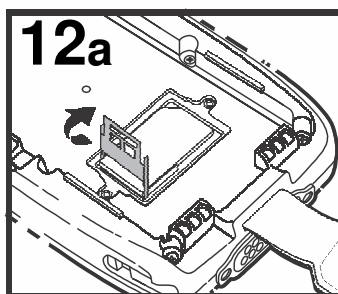
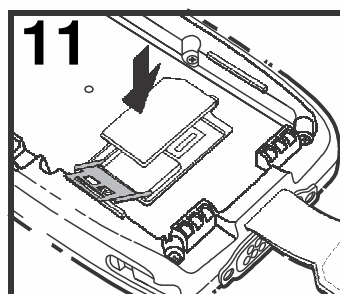

13. Reinstall the shield and screws to protect the sockets.

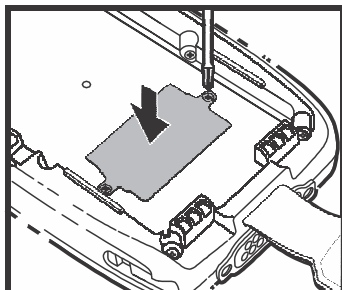

14. Install and lock the battery. The terminal automatically starts the power up sequence.

Note: The terminal does not power ON unless the battery lock is engaged.

Using the ScanImage Engine

Overview

The Dolphin terminal houses a compact image engine that instantly reads popular 1D and 2D bar codes and supports omni-directional aiming and decoding for greater flexibility in real-world settings. The image engine can also capture black and white digital images, such as signatures and pictures of damaged inventory.

With the latest CMOS-based technology, the engine works like a digital camera and enables black and white digital image capture, signature capture, and reading of OCR characters.

Laser Safety

See [Laser Safety](#) on page 1-1.

N5603 Beam Divergence Angle

Engines	Horizontal Beam Divergence Angle (degrees)	Vertical Beam Divergence Angle (degrees)
N5603SR/HD	18.1	14.3
N5603ER	13.1	9.9

LED Safety

See [LED Safety](#) on page 1-2.

Image Engine Specifications

Engines	1D	2D	Image Capture	Aiming Pattern	Omni-Directional Aiming
N5603SR/ER/HD	Y	Y	Y	N5603 Red High-Vis Aiming Pattern (page 4-5)	Y
N5600SR/ER/HD	Y	Y	Y	N5600 Green Aiming Beam (page 4-5)	Y

Depth of Field

The depth of field measurements used the following parameters:

- Distances are measured from the front of the engine.
- +23°C (+73°F), 0 lux
- Photographic quality codes

DRAFT COPY 11/11/11

Focus	N5603/N5600 High Density (HD)			N5603/N5600 Standard Range (SR)			N5603/N5600 Extended Range (ER)		
	Distance (in/cm)		Delta (in/cm)	Distance (in/cm)		Delta (in/cm)	Distance (in/cm)		Delta (in/cm)
	Near	Far		Near	Far		Near	Far	
3 mil C39/128	2.0 (5.1)	3.4 (8.6)	1.4 (3.6)	-	-	-	-	-	-
5 mil C39/128	1.4 (3.6)	4.8 (12.2)	3.4 (8.6)	2.7 (6.9)	6.3 (16.0)	3.6 (9.1)	5.4 (13.7)	9.0 (22.9)	3.6 (9.1)
7.5 mil C39/128	1.4 (3.6)	5.6 (14.2)	4.2 (10.7)	2.5 (6.4)	9.2 (23.4)	6.7 (17)	4.2 (10.7)	12.6 (32.0)	8.4 (21.3)
10 mil C39/128	1.4 (3.6)	5.5 (14.0)	4.1 (10.4)	1.6 (4.1)	13.2 (33.5)	11.6 (29.5)	3.1 (7.9)	17.2 (43.7)	14.1 (35.8)
15 mil C39/128	1.3 (3.3)	7.8 (19.8)	6.5 (16.5)	1.8 (4.6)	19.0 (48.3)	17.2 (43.7)	2.4 (6.1)	20.9 (53.1)	18.5 (47.0)
20 mil C39/128	2.3 (5.8)	9.2 (23.4)	6.9 (17.5)	2.2 (5.6)	20.1 (51.1)	17.9 (45.5)	2.9 (7.4)	24.0 (61.0)	21.1 (53.6)
100% UPC	1.9 (4.8)	7.1 (18)	5.2 (13.2)	1.8 (4.6)	16.5 (41.9)	14.7 (37.3)	2.7 (6.9)	19 (43.3)	16.3 (41.4)
5 mil PDF417	1.4 (3.6)	4.8 (12.2)	3.4 (8.6)	2.6 (6.6)	5.2 (13.2)	2.6 (6.6)	6.1 (15.5)	7.4 (18.8)	1.3 (3.3)
6.7 mil PDF417	1.4 (3.6)	4.8 (12.2)	3.4 (8.6)	2.0 (5.1)	6.5 (16.5)	4.5 (11.4)	4.7 (11.9)	9.8 (24.9)	5.1 (13.0)
10 mil PDF417	1.7 (4.3)	6.2 (15.7)	4.5 (11.4)	1.5 (3.8)	11.0 (27.9)	9.5 (24.1)	2.4 (6.1)	15.0 (38.1)	12.6 (32.0)
5 mil MicroPDF	1.8 (4.6)	3.4 (8.6)	1.6 (4.1)	-	-	-	-	-	-
5 mil Data Matrix	1.9 (4.8)	3.1 (7.9)	1.2 (3.0)	-	-	-	-	-	-
10 mil Data Matrix/Aztec	1.7 (4.3)	5.3 (13.5)	3.6 (9.1)	2.2 (5.6)	7.9 (20.1)	5.7 (14.5)	5.1 (13.0)	10.5 (26.7)	5.4 (13.7)
20 mil Data Matrix	2.1 (5.3)	7.8 (19.8)	5.7 (14.5)	2.0 (5.1)	15.3 (38.9)	13.3 (33.8)	3.6 (9.1)	18 (45.7)	14.4 (36.6)
10 mil QR	3.3 (8.4)	5.0 (12.7)	1.7 (4.3)	2.2 (5.6)	7.1 (18.0)	4.9 (12.4)	4.3 (10.9)	10.6 (26.9)	6.5 (16.5)
20 mil QR	2.2 (5.6)	7.9 (20.1)	5.7 (14.5)	2.2 (5.6)	15.5 (39.4)	13.3 (33.8)	2.4 (6.1)	19.6 (49.8)	17.6 (44.7)
32 mil Maxicode	2.4 (6.1)	8.6 (21.8)	6.2 (15.7)	2.5 (6.4)	17.0 (43.2)	14.5 (36.8)	3.9 (9.9)	23.2 (58.9)	19.5 (49.5)

DRAFT COPY 11/11/11

Supported Bar Code Symbologies

Symbology Type	Symbology Name
1D Symbologies	Codabar Codablock F Code 3 of 9 Code 11 Code 32 Pharmaceutical (PARAF) Code 93 Code 128 EAN with Add-On EAN with Extended Coupon Code EAN-8 EAN-13 GS1-128 GS1 Databar Interleaved 2 or 5 ISBT 128 Matrix 2 of 5 MSI Plessey Straight 2 of 5 IATA Straight 2 of 5 Industrial Telepen Trioptic Code UPC with Add On UPC-A UPC-E
2D Symbologies	Aztec Codablock A Codablock F Data Matrix GS1 Databar MaxiCode Micro PDF PDF417 QR Code
Composite Codes	UPC/EAN UCC/EAN GS1 Databar
OCR	OCR US Money Font MICR (E 13 B) and SEMI Font OCR-A OCR-B
Postal Codes	Postnet and most international 4-state codes Australian Post British Post Canadian Post China Post Japanese Post KIX (Netherlands) Post Korea Post Planet Code

Decoding

The terminal supports two types of image decoding for use in various bar code reading and imaging applications: full-area imaging and Advanced Linear Decoding (ALD).

Full-Area Imaging



Full-area imaging provides omni-directional reading of linear and non-linear 1D and 2D bar codes, OCR, signature capture, and picture taking. When reading all bar code types using full-area imaging, a positive read can be obtained from many positions; see [Aiming Beam Options](#) on page 4-5. To achieve the best read, the aiming beam should be centered horizontally across the bar code.

ALD

ALD provides fast reading of linear and stacked linear bar codes. To achieve a positive read when reading linear 1D and PDF417 bar codes, the aiming beam should be centered horizontally across the bar code. When ALD is enabled, the reader does not read matrix or postal codes.

To Decode a Bar Code

The aiming beam should be oriented in line with the bar code to achieve optimal decoding. A range of 4-10 inches (10-25 cm) from the bar code is recommended.

1. Tap  > **Demos**  > **Scan Demo** .
2. Point the Dolphin terminal at the bar code.
3. Press and hold the SCAN key. The aiming beam or pattern appears and the general notification LED illuminates red.

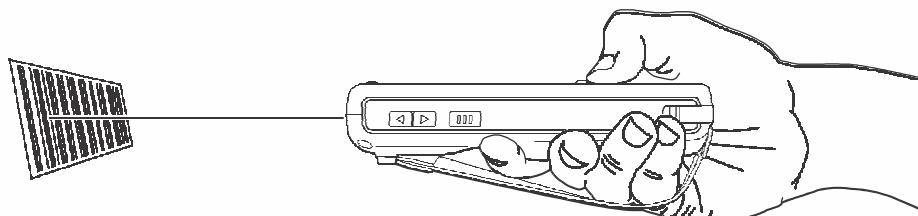

4. Center the aiming beam over the bar code; see [Aiming Beam Options](#) on page 4-5.
Note: For optimum performance, avoid reflections by scanning the bar code at a slight angle.
5. When the bar code is successfully decoded, the general notification LED flashes green and the terminal beeps.
6. The bar code information is entered into the application in use.

Aiming Beam Options

The aiming beams are smaller when the terminal is held closer to the code and larger when it is farther from the code. Symbologies with smaller bars or elements (mil size) should be read closer to the unit whereas symbologies with larger bars or elements (mil size) should be read farther from the unit.

N5603 Red High-Vis Aiming Pattern

If your Dolphin terminal is configured with a N5603 imager, high-vis aimers frame the bar code for more intuitive aiming. See [Laser Safety](#) on page 1-1.

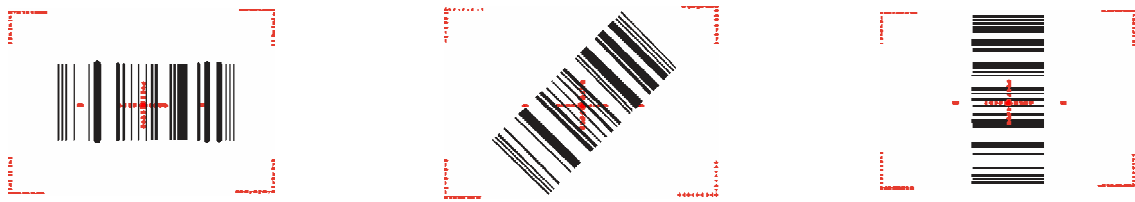

N5600 Green Aiming Beam

Linear Bar Code



2D Matrix Symbol



Capturing Images

The image-capture process is an intuitive, split-second operation for experienced users. By following the basic guidelines, new users can easily develop their own technique and, with practice, quickly learn to adapt it to different application environments.

Image Preview

When the imaging process is initiated, the touch screen displays a preview of the object. This is a live video image of what the imager is currently viewing. The live video image has a slightly degraded appearance compared to the captured image. This is normal.

Scan Key

On all 7800 terminals, the SCAN key captures images.

File Formats

File formats supported for image storage include Bitmap (BMP), JPEG (JPG) and Portable Network Graphics (PNG). The default file format for images is a grayscale JPG.



Compression

Digital images have a maximum image size of 640 x 480 pixels and may have up to a 256 grayscale image definition.

The image quality and related file size are determined by the data compression method used by the software application used to take images. The average size of the image file is approximately 4–8K. However, the size of the image depends on the content of the image - the more complex the content, the larger the file size.

Taking an Image

The following steps are basic guidelines for taking images:

1. Tap  > **Demos** > **Imaging Demo** .
2. Point the Dolphin terminal at the object.
3. To preview the image, press and hold the SCAN key. The general notification LED illuminates red.
4. Adjust the terminal's position until the object appears on the touch screen the way you want it to appear in the image.
5. Hold the terminal still and release the SCAN key. The LED flashes green, the screen briefly flashes, and then the captured image appears on the screen.
6. Tap file Save or Save As.

Note: Unless otherwise specified by the application in use, the image is saved to the **\My Device\My Documents** folder.

Enabling the Aimer

You can enable the aiming pattern for imaging in the Imaging Demo. For details about the aimer, see [Aiming Beam Options](#) on page 4-5.

1. Tap  > **Demos** > **Imaging Demo** > **Setup** menu > **Aimer**.

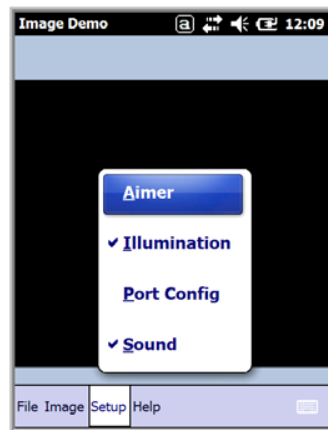

2. The aiming pattern is now enabled for imaging.

Uploading Images

Image files can be uploaded to a host workstation using Microsoft ActiveSync or Windows Mobile Device Center and a Dolphin communication peripheral. For additional information see [Connecting and Synchronizing the Terminal and Workstation](#) on page 8-6.



DRAFT COPY 11/11/11

Using the Color Camera

Overview

Dolphin 7800 terminals equipped with a 3.0-Megapixels Resolution color camera with Automated Camera Control (ACC), and an Application Programming Interface (API) provide easy integration of color picture and video capture into business applications. The camera lens and camera flash are located on the back panel of the terminal.

Taking a picture using the Camera Demo tool

1. Tap  > **Demos**  > **Camera Demo** .
2. Adjust the camera settings using the icon menu at the top of the display screen.



3. Point the terminal's camera lens at the object you want to capture. The camera lens is located on the back panel of the terminal.
4. Center the object in the touch screen display.
5. Press the **ENT** key or tap **Snap** on the touch screen. The general notification LED illuminates red during picture capture.

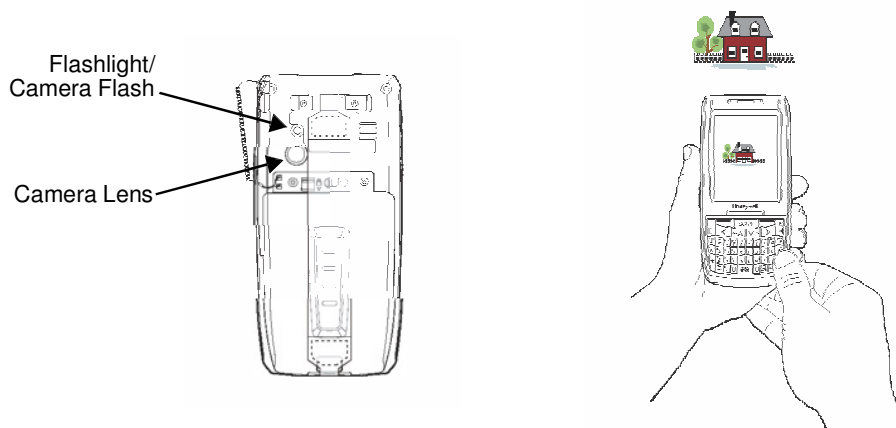

Note: Tap the green arrow  to review or edit your pictures.

Tap the green box  to exit the picture review/edit screen.

Options

Tap **Options** > **Camera**.



The Camera Options menu appears. There are five tabs of configurable options accessible from the Camera Options menu.

Profile Tab

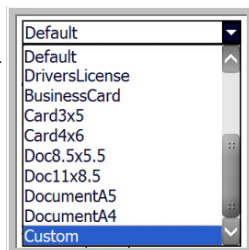
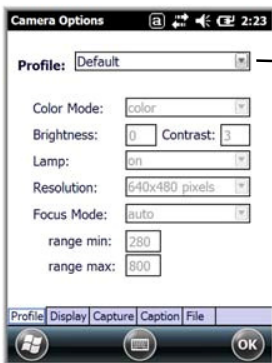

The profile tab allows you to customize your camera settings, or choose from several predefined profiles designed to provide the best picture quality for common tasks.

Display Tab

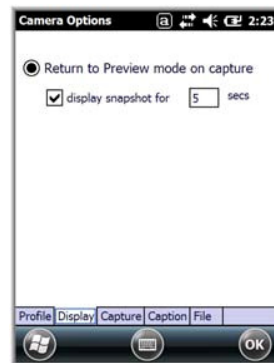

Capture Tab

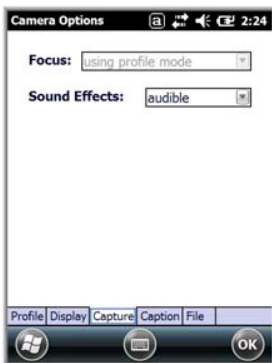

Caption Tab



File Tab



Taking a picture using the Windows Embedded Handheld 6.5 Camera tool

1. Tap  > **Pictures & Videos** > **Camera**
2. Point the terminal's camera lens at the object you want to capture. The camera lens is located on the back panel of the terminal.
3. Center the object in the touch screen display.
4. Press the ENT key.
5. The touch screen displays the captured photo.

6. Tap OK on the Tile Bar to return to the active viewfinder screen.

Menu

Tap **Menu** on the Tile Bar at the bottom of the touch screen to adjust the camera settings, switch to video mode, and access additional camera options.

Item	Descriptions
Video	Activate Video Mode
Mode	Set Mode (i.e., Normal, Burst, or Timer)
Resolution	Set Picture Resolution (i.e., QVGA, VGA, SVGA, XGA, UXGA, or QXGA)
Zoom	Set Zoom (i.e., x1, x2, or x3)
Flash	Set Camera Flash On or Camera Flash Off
Focus	Set Focus Off, Focus On, Focus on Trigger, or Fixed-Focus
Brightness	Set the brightness setting from +2.0 EV to -2.0 EV in .5 EV increments
Full Screen	Switch to full screen mode
Options	Set Camera Options, Video Options, Slide Show Options or General Options

Options

Tap **Menu > Options**. The Options menu contains four screens:

General Tab



Slide Show Tab



Camera Tab

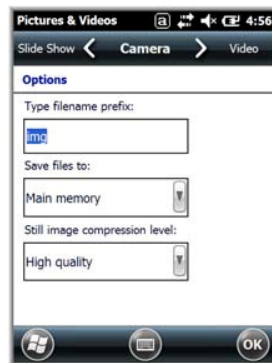

Video Tab



Recording Video

1. Tap  > **Pictures & Videos > Camera > Menu > Video**
2. Point the terminal's camera lens at the object you want to capture.
3. Press the **ENT** key to start recording.
4. Tap **Stop** on the touch screen or press **ENT** to stop recording.

Uploading Pictures and Videos

Picture and Video files can be uploaded to a host workstation using Microsoft ActiveSync or Windows Mobile Device Center and a Dolphin communication peripheral. For additional information see [Connecting and Synchronizing the Terminal and Workstation](#) on page 8-6.

Using the Keyboards

Available Keyboards

Note: Contact a sales representative for information on additional keyboard options.

30-Key Numeric Keyboard

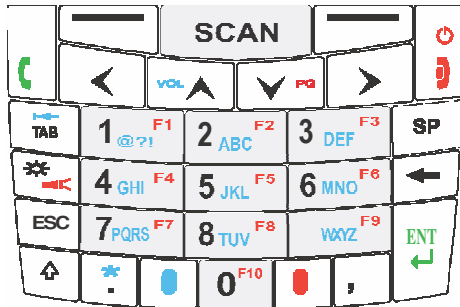

46-Key QWERTY Keyboard

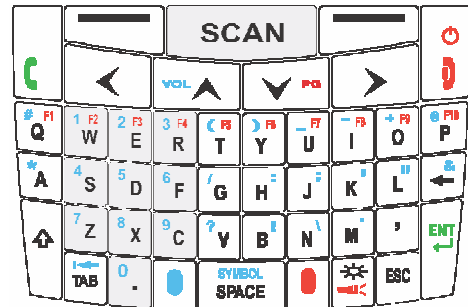

30-Key Numeric (Calculator) Keyboard

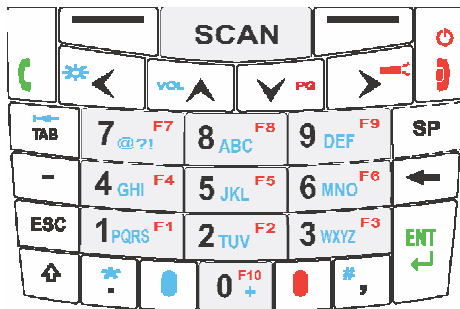

46-Key AZERTY Keyboard

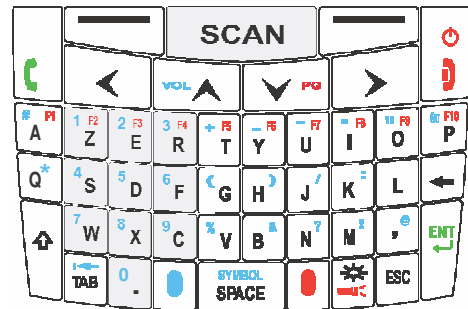

46-Key QWERTZ Keyboard

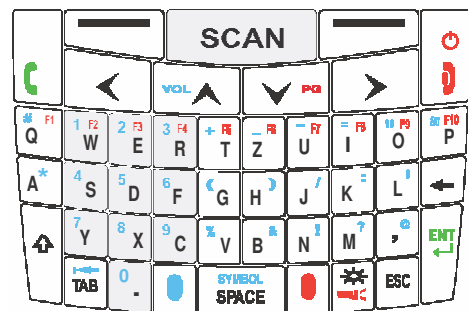

All Keyboards Contain the Following:

- Backlit for easy viewing in various lighting conditions.
- Centrally located Scan key for both right- and left-hand operation.
- Color-coding so you can clearly see the most common keyboard combinations.
- Function, navigation, and modifier keys.

Keyboard Combinations

See [30-Key Numeric Keyboard](#) on page 6-4.

See [30-Key Numeric \(Calculator\) Keyboard](#) on page 6-6.

See [46-Key QWERTY Keyboard](#) on page 6-8.

See [46-Key AZERTY Keyboard](#) on page 6-11.

See [46-Key QWERTZ Keyboard](#) on page 6-14.











Common Buttons

See [Using the Function Keys](#) on page 6-2.



See [Using the Modifier Keys](#) on page 6-3.

See [Using the Navigation Keys](#) on page 6-3.

Using the Function Keys





Name	Key Symbol	Function
Backlight	 or  &  Blue	Turns the keyboard backlight on or off. Note: On terminals with the 30-Key Numeric (Calculator) Keyboard the backlight feature requires the blue modifier key.
Flashlight	 &  Red	Turns the flashlight on or off. The flashlight is located on the back panel of the terminal.
Backspace		Moves the cursor back one space each time the key is pressed. If you are typing text, it deletes the previous character each time it is pressed.
Enter		Confirms data entry.
Escape	ESC	Cancels the current action.
Power/End Call Key	 	The Power key, located in the upper right corner of the keypad, puts the terminal in Suspend Mode or wakes the terminal from Suspend Mode, see Suspend Mode on page 2-11. This key is also used to end/disconnect a phone calls.
SCAN Key	SCAN	Activates the scan and wakes the terminal from Suspend Mode. The key location allows convenient one-handed image-taking and/or bar code decoding.
Space	SYMBOL SPACE or SP	Moves the cursor one space.
Tab	 T B	Moves the cursor to the next tab stop or the next control (on a form).

Using the Modifier Keys





Name	Key	Function
Blue & Red	 <p style="text-align: center;">Blue Red</p>	<p>The blue and red keys are used in combination with other keys to type special characters and perform system functions. Each keyboard is color-coded to indicate the character typed or function performed when specific keys are pressed immediately after the blue or red modifier key.</p> <p>Normal Press the blue or red key once to modify only the next key pressed.</p> <p>Locked Press the blue or red key twice to toggle the modifier lock on or off. If a modifier key is locked on, the next keys pressed are modified until the lock is turned off. This prevents having to press the modifier key each time a key is pressed.</p> <p>Note: Press the locked modifier key once to temporarily unlock the modifier key for a single key stroke.</p>
Shift		<p>The shift key modifies only the next key pressed; it must be pressed before each key you wish to modify. Shift toggles the keyboard between uppercase alphabet mode and lowercase alphabet mode.</p> <p>Press the shift key twice to toggle Caps Lock ON or OFF.</p>

Using the Navigation Keys

Located in the center of each keyboard for easy access with either hand, the navigation keys navigate the cursor through application screens.

Key	Function
	Moves the cursor up one row or line.
	Moves the cursor down one row or line.
 <p>Blue</p>	Raises the volume.
 <p>Blue</p>	Lowers the volume.
 <p>Red</p>	Moves the cursor down one page.

DRAFT COPY 11/11/11

Key	Function
 &  Red	Moves the cursor up one page.
	Moves the cursor one character to the right.
	Moves the cursor one character to the left.

Note: Additional functionality varies according to the application in use.

30-Key Numeric Keyboard

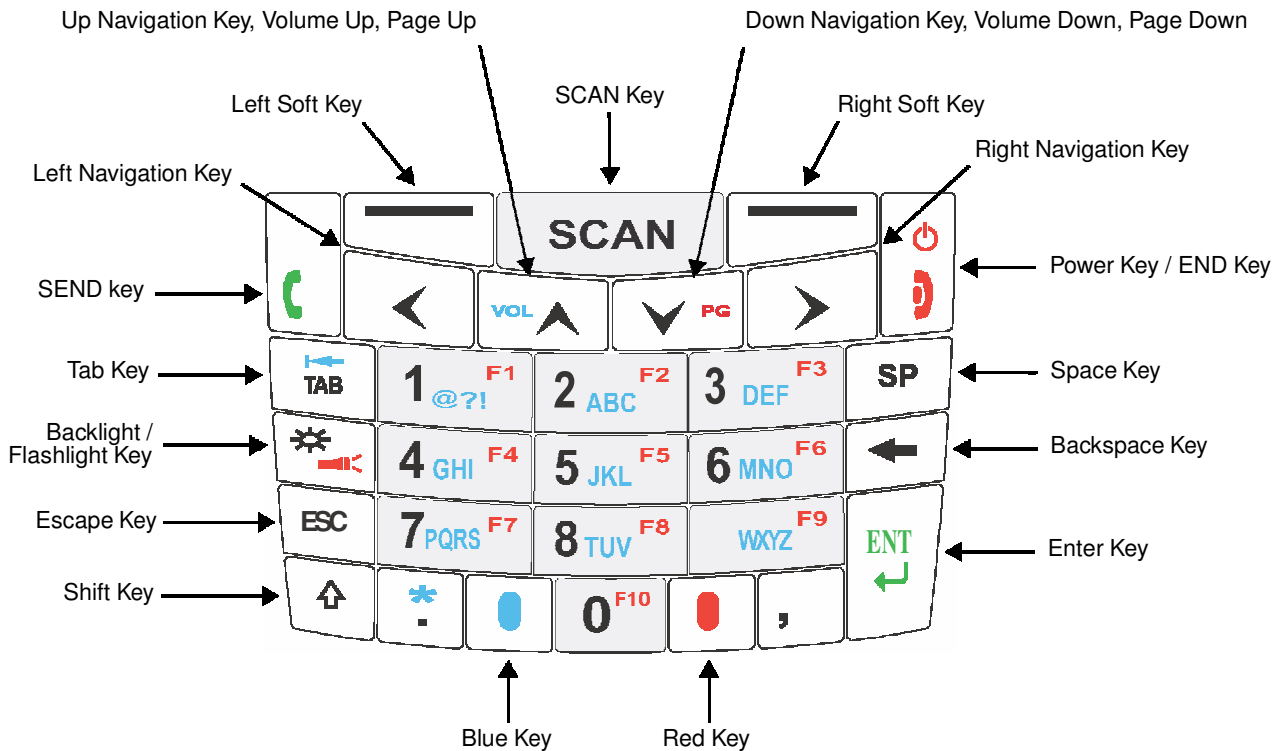

30-Key Numeric Keyboard Combinations

Key	Normal	Blue + Normal	Blue + Normal + Shift	Red + Normal
Left Soft Key	Left Soft Key performs the left function.			
SCAN	SCAN			

DRAFT COPY 11/11/11

Key	Normal	Blue + Normal	Blue + Normal + Shift	Red + Normal
Right Soft Key	Right Soft Key performs right function.			
SEND	SEND	Cold Boot	Cold Boot	SEND
Left Navigation	Left			
Up Navigation	Volume Up	Volume Up	Volume Up	Page Up
Down Navigation	Volume Down	Volume Down	Volume Down	Page Down
Right Navigation	Right			
Power/END	Power On/Off or END Call	Warm Boot	Warm Boot	Power On/Off or END Call
TAB	TAB	back TAB	TAB	TAB
1	1	@ ? !	@ or ? or !	F1
2	2	abc	ABC	F2
3	3	def	DEF	F3
Space	Space			
Backlight	Backlight	Backlight	Backlight	flashlight
4	4	ghi	GHI	F4
5	5	jkl	JKL	F5
6	6	mno	MNO	F6
Backspace	backspace			
ESC	Escape			
7	7	pqrs	PQRS	F7
8	8	tuv	TUV	F8
9	9	wxyz	WXYZ	F9
ENTER	Enter			
Shift	Shift			

Key	Normal	Blue + Normal	Blue + Normal + Shift	Red + Normal
Period	period	asterisk	asterisk	period
Blue	Blue			
0	0	0	0	F10
Red	Red			

30-Key Numeric (Calculator) Keyboard

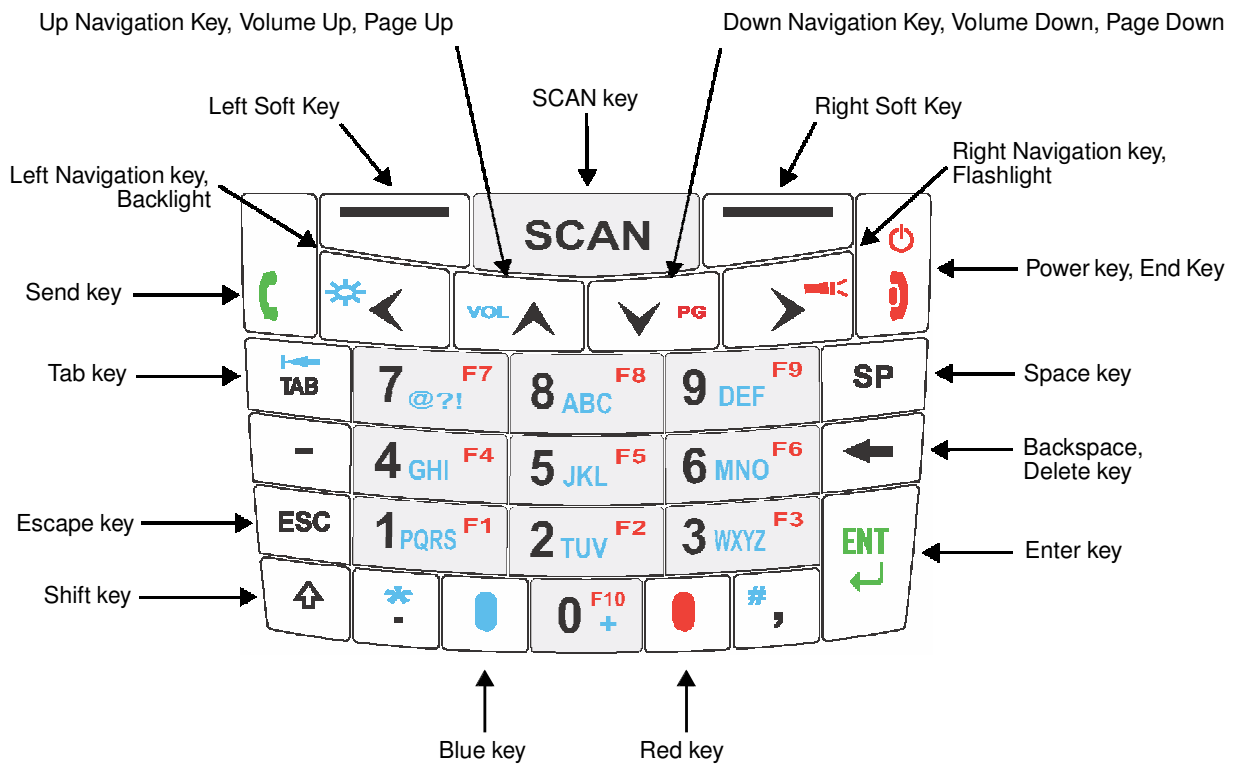

30-Key Numeric (Calculator) Keyboard Combinations

Key	Normal	Blue + Normal	Blue + Normal + Shift	Red + Normal
Left Soft Key	Left Soft Key			
SCAN	SCAN			

DRAFT COPY 11/11/11

Key	Normal	Blue + Normal	Blue + Normal + Shift	Red + Normal
Right Soft Key	Right Soft Key			
SEND	SEND	Cold Boot	Cold Boot	SEND
Left	Left	Backlight	Left	Left
Up	Volume Up	Volume Up	Volume Up	Page Up
Down	Volume Down	Volume Down	Volume Down	Page Down
Right	Right	Right	Right	Flashlight
POWER\END	Power\End	Warm Boot	Warm Boot	Power\End
TAB	TAB	back TAB	TAB	TAB
7	7	@ or ? or !	@ or ? or !	F7
8	8	abc	ABC	F8
9	9	def	DEF	F9
Space	Space			
Dash/Minus	-	-	-	-
4	4	ghi	GHI	F4
5	5	jkl	JKL	F5
6	6	mno	MNO	F6
Backspace	backspace			
ESC	Escape			
1	1	pqrs	PQRS	F1
2	2	tuv	TUV	F2
3	3	wxyz	WXYZ	F3
ENTER	Enter			
Shift	Shift			

DRAFT COPY 11/11/11

Key	Normal	Blue + Normal	Blue + Normal + Shift	Red + Normal
Period	period	asterisk	asterisk	period
Blue	Blue			
0	0	plus +	0	F10
Red	Red			

46-Key QWERTY Keyboard

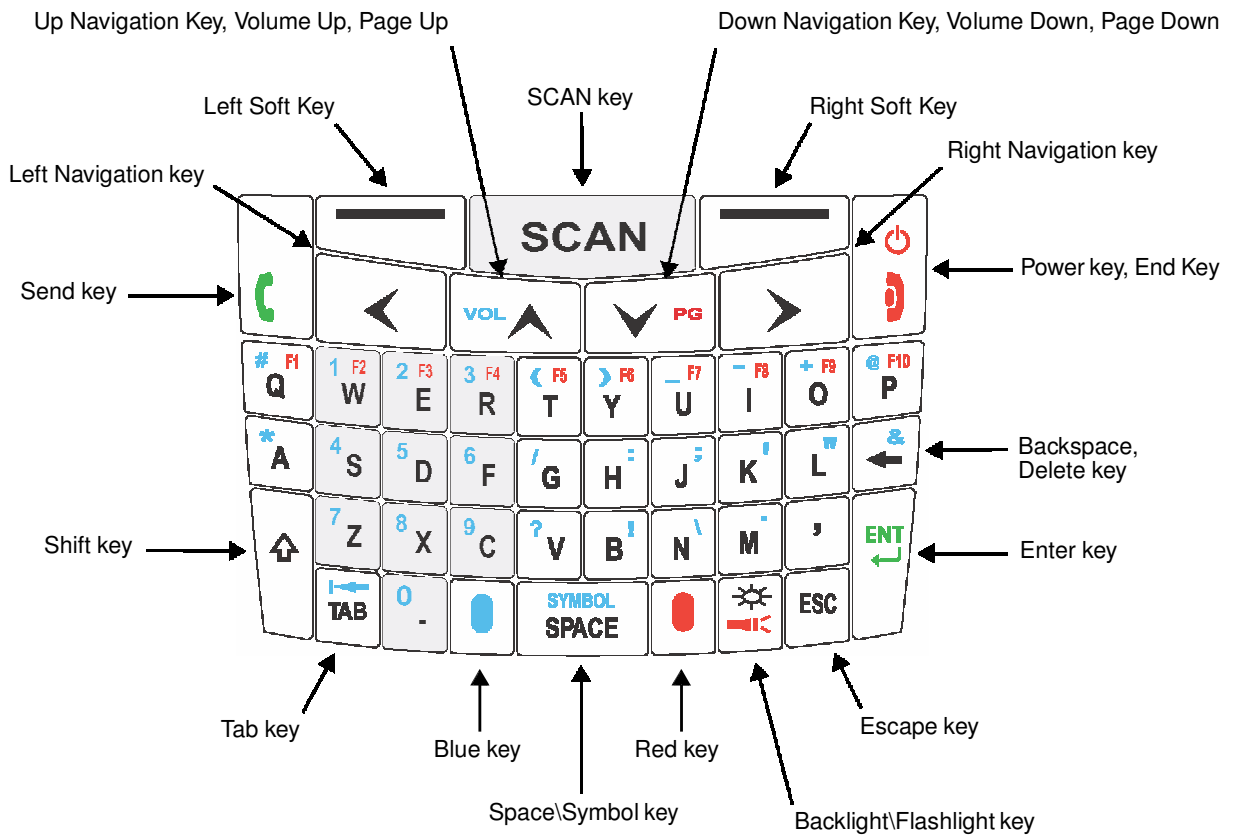

46-Key QWERTY Keyboard Combinations

Key	Normal	Shift + Normal	Blue + Normal	Red + Normal
Send	Send	Send	Cold Boot	Send

DRAFT COPY 11/11/11

Key	Normal	Shift + Normal	Blue + Normal	Red + Normal
Left Soft Key	Left Soft Key			
SCAN	Scan			
Right Soft Key	Right Soft Key			
Power/End	Power/End	Power/End	Warm Boot	Power/End
Left Navigation Key	Left			
Up Navigation	Up	Up	Volume Up	Page Up
Down Navigation	Down	Down	Volume Down	Page Down
Right Navigation	Right			
Q	q	Q	# (pound/group)	F1
W	w	W	1	F2
E	e	E	2	F3
R	r	R	3	F4
T	t	T	(F5
Y	y	Y)	F6
U	u	U	_ (underscore)	F7
I	i	I	- (minus)	F8
O	o	O	+ (plus)	F9
P	p	P	@	F10
A	a	A	* (asterisk)	
S	s	S	4	
D	d	D	5	
F	f	F	6	
G	g	G	/	

DRAFT COPY 11/11/11

Key	Normal	Shift + Normal	Blue + Normal	Red + Normal
H	h	H	: (colon)	
J	j	J	; (semi-colon)	
K	k	K	' (single quote)	
L	l	L	" (double quote)	
Backspace	Backspace	Backspace	& (ampersand)	
Shift	Shift			
Z	z	Z	7	
X	x	X	8	
C	c	C	9	
V	v	V	? (question mark)	
B	b	B	! (exclamation point)	
N	n	N	\ (back slash)	
M	m	M	. (period)	
Comma	, (comma)	<	, (comma)	, (comma)
ENT	Enter			
TAB	Tab	Back Tab	Back Tab	Tab
Period	. (period)	>	0	. (period)
Blue	Blue			
SYMBOL/ SPACE	Space	Space	SYMBOL	Space
Red	Red			
Backlight	Backlight	Backlight	Backlight	Flashlight
ESC	Escape			

46-Key AZERTY Keyboard

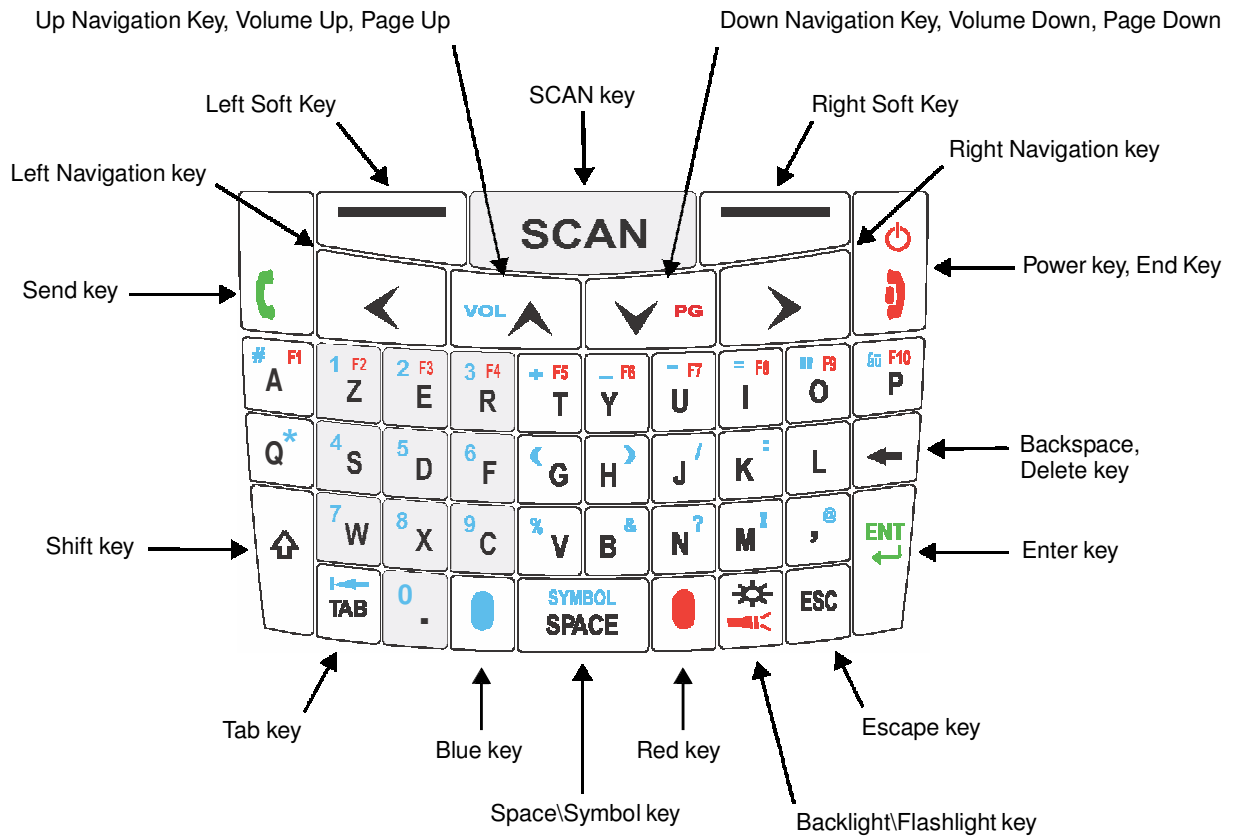

46-Key AZERTY Keyboard Combinations

Key	Normal	Shift + Normal	Blue + Normal	Red + Normal
Send	Send	Send	Cold Boot	Send
Left Soft Key	Left Soft Key			
SCAN	Scan			
Right Soft Key	Right Soft Key			
Power/End	Power/End	Power/End	Warm Boot	Power/End

DRAFT COPY 11/11/11

Key	Normal	Shift + Normal	Blue + Normal	Red + Normal
Left Navigation Key	Left			
Up Navigation	Up	Up	Volume Up	Page Up
Down Navigation	Down	Down	Volume Down	Page Down
Right Navigation	Right			
A	a	A	# (number sign)	F1
Z	z	Z	1	F2
E	e	E	2	F3
R	r	R	3	F4
T	t	T	+ (plus)	F5
Y	y	Y	_ (underscore)	F6
U	u	U	- (minus)	F7
I	i	I	= (equal)	F8
O	o	O	" (double quote)	F9
P	p	P	áü	F10
Q	q	Q	* (asterik)	
S	s	S	4	
D	d	D	5	
F	f	F	6	
G	g	G	(
H	h	H)	
J	j	J	/ (forward slash)	
K	k	K	: (colon)	
L	l	L		

DRAFT COPY 11/11/11

Key	Normal	Shift + Normal	Blue + Normal	Red + Normal
Backspace	Backspace	Backspace		
Shift	Shift			
W	w	W	7	
X	x	X	8	
C	c	C	9	
V	v	V	% (percent)	
B	b	B	& (ampersand)	
N	n	N	? (question mark)	
M	m	M	! (exclamation mark)	
Comma	, (comma)	<	@	, (comma)
ENT	Enter			
TAB	Tab	Back Tab	Back Tab	Tab
Period	. (period)	>	0	. (period)
Blue	Blue			
SYMBOL/ SPACE	Space	Space	SYMBOL	Space
Red	Red			
Backlight	Backlight	Backlight	Backlight	Flashlight
ESC	Escape			

46-Key QWERTZ Keyboard

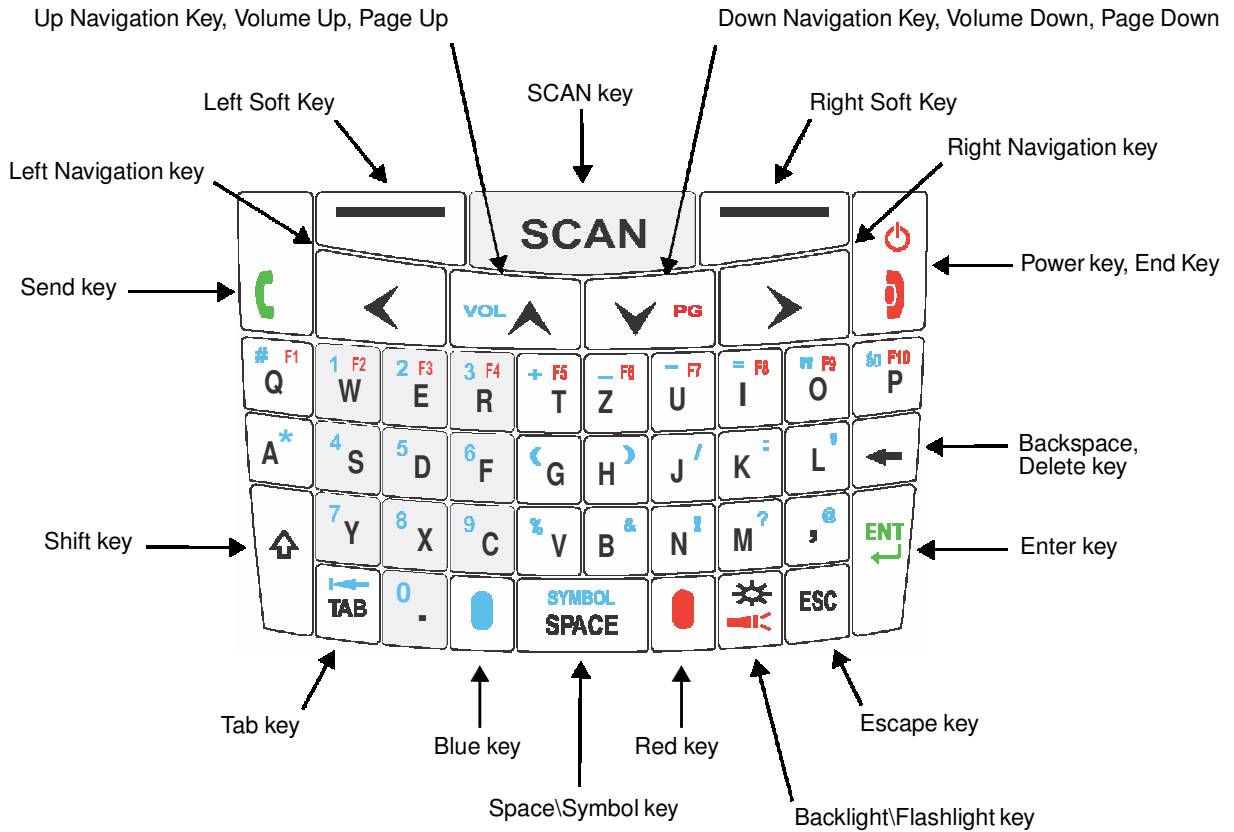

46-Key QWERTZ Keyboard Combinations

Key	Normal	Shift + Normal	Blue + Normal	Red + Normal
Send	Send	Send	Cold Boot	Send
Left Soft Key	Left Soft Key			
SCAN	Scan			
Right Soft Key	Right Soft Key			
Power/End	Power/End	Power/End	Warm Boot	Power/End
Left Navigation	Left			
Up Navigation	Up	Up	Volume Up	Page Up

DRAFT COPY 11/11/11



Key	Normal	Shift + Normal	Blue + Normal	Red + Normal
Down Navigation	Down	Down	Volume Down	Page Down
Right Navigation	Right			
Q	q	Q	# (number sign)	F1
W	w	W	1	F2
E	e	E	2	F3
R	r	R	3	F4
T	t	T	+ (plus)	F5
Y	y	Y	_ (underscore)	F6
U	u	U	- (minus)	F7
I	i	I	= (equal)	F8
O	o	O	" (double quote)	F9
P	p	P	áU	F10
A	a	A	* (asterisk)	
S	s	S	4	
D	d	D	5	
F	f	F	6	
G	g	G	(
H	h	H)	
J	j	J	/ (forward slash)	
K	k	K	: (colon)	
L	l	L	' (single quote)	
Backspace	Backspace	Backspace		
Shift	Shift			
Y	y	Y	7	

DRAFT COPY 11/11/11







Key	Normal	Shift + Normal	Blue + Normal	Red + Normal
X	x	X	8	
C	c	C	9	
V	v	V	% (percent)	
B	b	B	& (ampersand)	
N	n	N	! (exclamation mark)	
M	m	M	? (question mark)	
Comma	, (comma)	<	@	, (comma)
ENT	Enter			
TAB	Tab	Back Tab	Back Tab	Tab
Period	. (period)	>	0	. (period)
Blue	Blue			
SYMBOL/ SPACE	Space	Space	SYMBOL	Space
Red	Red			
Backlight/ Flashlight	Backlight	Backlight	Backlight	Flashlight
ESC	Escape			



System Settings

Overview

Customized settings are available on the System Settings menu. Tap  > **Settings**  and the settings screen opens.



Icon		Description
Bluetooth		Configures the Bluetooth radio. See Working with the Bluetooth Radio on page 10-1.
Clock & Alarms		Set the system clock, date, time and schedule alarms. See Clock & Alarms on page 7-2.
Lock		Password protect the terminal to limit access to the terminal.
Sounds & Notifications		Set the sound volume, enable or disable sounds for specific actions, set sound parameters for system notifications and enable or disable vibrator notification.
Home		Customize the look and the information displayed on the Home screen.
Connections		Establishes network connections settings. See Connections Menu on page 8-1.
Personal		Customizes buttons, and set SIP options. See Personal Menu on page 7-3.

Icon	Description
	Adjusts system settings. See System Menu on page 7-7.
	This icon is present on Dolphin models equipped with WWAN radio (GSM/UMTS/GPRS/EDGE) capabilities. Microsoft My Phone synchronizes your phone's contacts, calendar, tasks, text messages, music, photos, videos, and other documents with your My Phone account at http://myphone.microsoft.com .

Clock & Alarms

The Clock & Alarms settings can be accessed from the Home screen or the Settings Menu.

1. On the Home screen, tap the line that displays the time and date

OR

Tap  > **Settings** > **Clock & Alarms**,

2. The Clock Settings screen appears. This setting sets the system clock. All scheduled items run according to this setting.

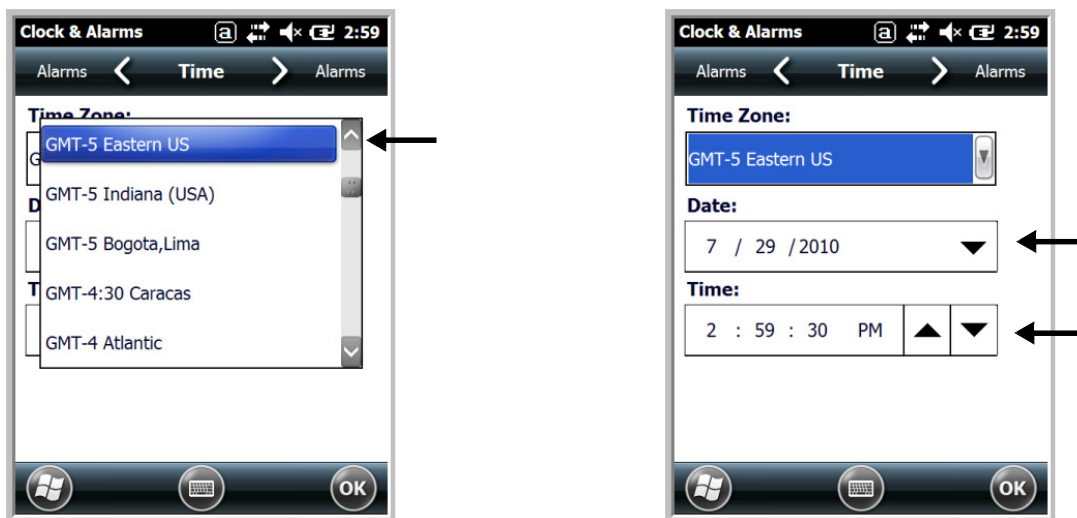



Tap the arrow to the right of the time zone to open the drop down menu. Select the appropriate time zone from the menu. Set the correct time and date in the remaining fields and tap **OK** to save.

Personal Menu

To access the Personal Menu, tap  > **Settings**  > **Personal** . The screen opens displaying the Personal Menu.





Icon		Description
Buttons		Program the side buttons to perform specific tasks. See Buttons on page 7-3.
Owner Information		Enter your contact information (e.g., name, company, address, telephone number and E-mail address).
Phone		This Phone icon is present on Dolphin models equipped with WWAN radio (GSM/UMTS/GPRS/EDGE) capabilities. Tap this icon to set up user parameters. See Setup Options on page 9-5.

Buttons

The Buttons setting programs certain keyboard buttons to launch applications or execute commands.

Enable HotKeys

Default Buttons setting assignments are inactive until you enable the HotKeys Power Tool.

Tap  > **Power Tools** and tap the HotKeys icon  **once**. HotKeys is enabled, and the button assignments in the Buttons setting are active.

For more information about the HotKeys Power Tool, refer to the Dolphin Power Tools User's Guide, <http://www.honeywellaidc.com/> is available for download from the web at www.honeywellaidc.com.

Changing Button Assignments

1. After HotKeys is enabled, tap  > **Settings** > **Personal**  > **Buttons** .

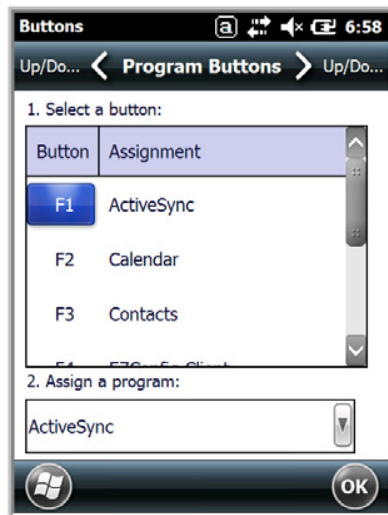

Note: The buttons that appear on this window are the only buttons that can be programmed via the Buttons setting. You cannot add buttons to this window.

2. To change button assignment, tap on the name of the button in the **Button** column, and then select a program or command in the **Assign a program** drop down list.
3. Tap **OK** to save.
4. Press the button to verify that the program is launched or action performed.

Available Applications

The **Assign a program** list contains the applications installed on the terminal. If there is a program installed that you would like to see in this list, paste a Shortcut to the program in the `\\Windows\Start Menu\Programs` folder. For instructions about creating shortcuts, see [Using File Explorer](#) on page 7-5.

Additional Functions

The **Assign a program** list also contains the following commands:

Command	Description
<Context Menu>	Performs the same function as tap-and-hold to open the context menu for the control.
<Home>	Returns to the Home screen.
<Input Panel>	Opens the soft input panel.
<Left Softkey>	Opens the menu or performs the action displayed on the left side of the Command bar.
<None>	Nothing happens when the button is pressed.
<OK/Close>	Performs the same function as tapping OK on the screen.

Command	Description
<Right Softkey>	Opens the menu or performs the action displayed on the right side of the Command bar.
<Rotate Screen>	Changes the screen orientation from portrait to landscape.
<Scan1>	Activates the scanner/imager.
<Scan2>	Activates the scanner/imager.
<Scroll Down>	Scrolls down in the open application.
<Scroll Left>	Scrolls left in the open application.
<Scroll Right>	Scrolls right in the open application.
<Scroll Up>	Scrolls up in the open application.
<Start Menu>	Opens the Start menu.

Using File Explorer

If you do not see the program listed, you can either use File Explorer to move the program or ActiveSync on the workstation to create a shortcut to the program and place the shortcut in the Start Menu folder.

Note: We recommend that you Copy and Paste Shortcut so that you do not alter your program configurations by accident. Using Copy and Paste Shortcut (as opposed to Cut and Paste) ensures that the program files remain where they need to be for the system to find them to perform system functions.

1. Tap  > **File Explorer** , and navigate to the program (**My Device > Program Files**).



2. Tap and hold on the program, then tap **Copy** on the pop-up menu.

DRAFT COPY 11/11/11

3. Navigate to the Windows folder and open the Start Menu (**My Device > Windows > Start Menu > Programs**), tap and hold a blank area of the window, and tap **Paste Shortcut** on the pop-up menu.

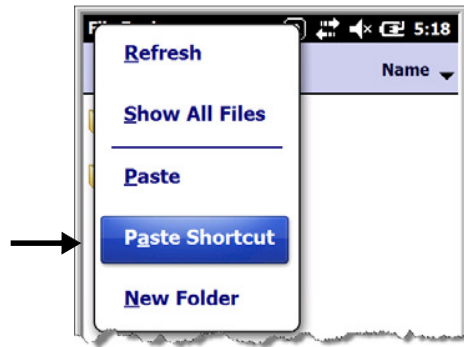

Note: If there is no blank space available in the window, tap on **Menu > Edit > Paste Shortcut**.

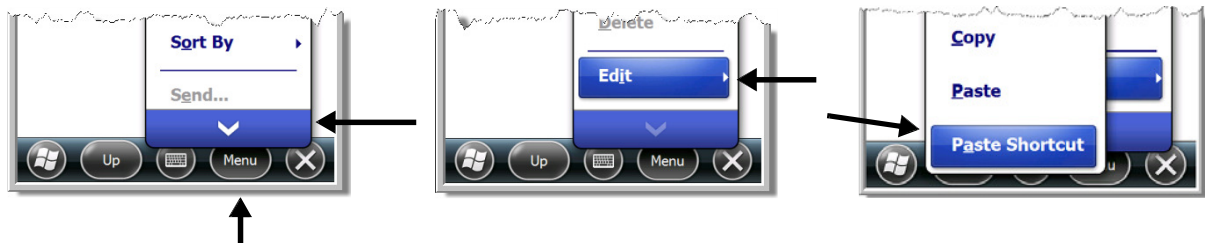

4. Tap  to verify that the program now appears on the Start menu.

Using ActiveSync on the Workstation







Here, you are performing the same basic process as on the terminal, except that you are using the Explore utility (Windows Explorer) to copy and paste the shortcut.











1. Open **ActiveSync > Explore** and navigate to the program.
2. Right-click on the program and select **Create Shortcut**.
3. Select the shortcut, right-click, and select **Cut**.
4. Navigate to the **Start Menu** folder (**Windows > Start Menu > Programs**).
5. Right-click on an empty area and select **Paste Shortcut**.
6. On the terminal, tap the **Start** menu.
7. Verify that program appears.

System Menu

The System menu enables you to verify and sometimes alter system parameters. To access the System menu, go to **Start > Settings > System**. Tap the appropriate icon to open that system setting.



Icon		See Page
About		See About on page 7-8.
Backlight		See Backlight on page 7-9.
Battery		See Battery on page 7-10.
Certificates		See Certificates on page 7-10.
Encryption		See Encryption on page 7-11.
Error Reporting		See Error Reporting on page 7-11.
External GPS		See External GPS on page 7-11.

Icon		See Page
Five Volt Control		See Five Volt Control on page 7-12.
Managed Programs		See Managed Programs on page 7-13.
Memory		See Memory on page 7-14.
Power		See Power on page 7-15.
RIL		See RIL on page 7-15.
Regional Settings		See Regional Settings on page 7-15.
Remove Programs		See Remove Programs on page 7-16.
Screen		See Screen on page 7-17.
Smart Sensors		See Smart Sensor on page 7-12.
Task Manager		See Task Manager on page 7-18.

About

The About system setting displays specific information about the terminal. It contains three screens:

- Version Screen** Displays the information about the software, operating system, and processor.
- Device ID Screen** Displays the information the terminal uses to identify itself to other devices. It can be important to know this information if the Dolphin terminal is going to be part of a networked system of devices.
 - Device name:** Displays the system's default name. This is the name used by ActiveSync.
 - Description:** Displays the description of the device ID.
 - Copyrights Screen:** Displays important copyright information.

Backlight

The Backlight system setting enables you to customize backlight functionality for the display. The backlight for the color display is user-defined. The Backlight system setting screen contains three tabs: Battery Power, External Power, and Brightness.

Tap  > **Settings** > **System** > **Backlight**.

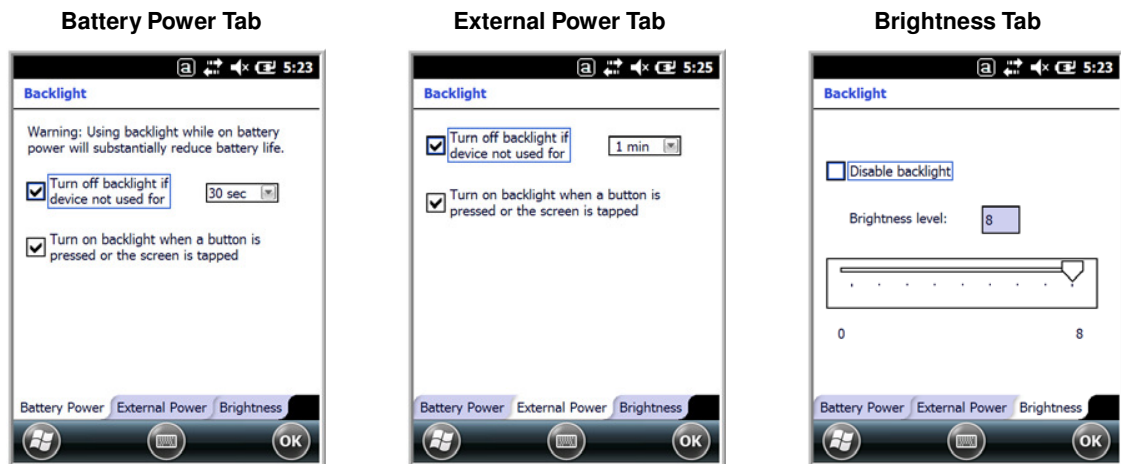

The **Battery Power** tab determines the backlight timeout when the terminal is running on battery power.

The **External Power** tab determines the backlight timeout when the terminal is running on external power.

The options on the power tabs are the same.

Turn off backlight: Select how many minutes you want to elapse before the backlight automatically turns off.

Turn on backlight: Select this option if you want the backlight to turn on when the button is pressed or the touch screen is tapped.

The **Brightness** tab determines the backlight intensity. Move the slider to set the intensity of the backlight. The default is 8.

Battery

The Battery system settings menu contains two tabs: Battery Status and Log Config. The **Battery Status** tab provides the status of the main battery pack (e.g., Battery Time to Full or Battery Time to Empty, Voltage, Current, Temperature, Chemistry, and Serial Number). The **Log Config** Tab allows you to configure the BatteryLogFile.

Tap  > **Settings** > **System** > **Battery**

Battery Status Tab

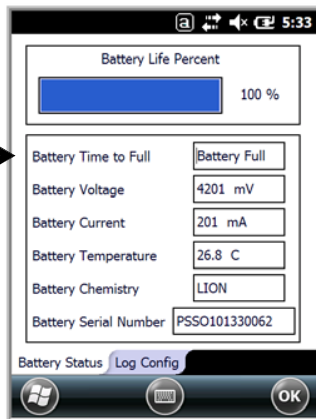

When external power is supplied to the terminal, "Battery Time to Full" is listed. When power is supplied by the battery pack, "Battery Time to Empty" is listed.

Log Config Tab

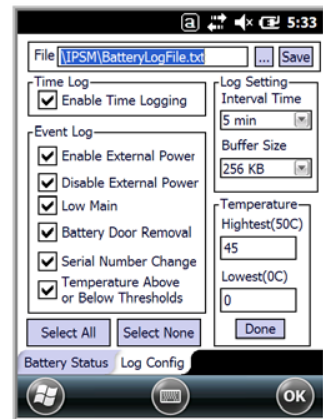

Certificates

Certificates shows you the certificates that are recognized by the operating system. It contains three screens.

Intermediate Screen

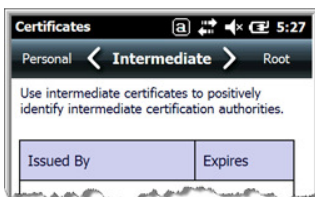

Personal Screen

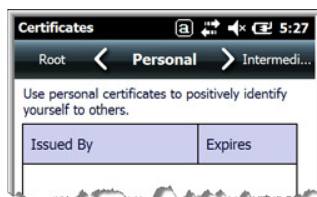

Root Screen

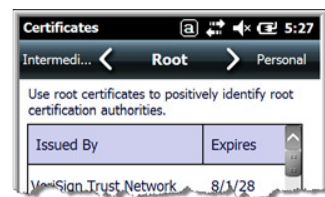

Encryption

Encryption gives you the option of encrypting files placed on storage cards so that those files cannot be read by any other device.



Error Reporting

Error Reporting gives you the option of enabling or disabling the error reporting function of Windows Embedded Handheld 6.5.

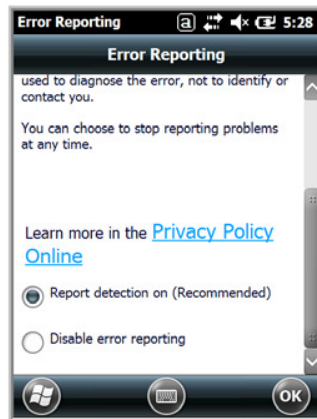

External GPS

External GPS determines which port a third-party GPS software application can use to access the GPS receiver.



Note: You need the installation parameters from the GPS manufacturer to configure the connection.

Five Volt Control

Five Volt Control gives you the option to manually enable 5V output to supply power to an external device. By default, 5-Volt Output automatically turns on when AC power is applied to the terminal. If you want to use a USB memory stick without AC power, then you must manually turn on the 5-Volt Output. Do not leave 5-Volt output enabled when you are not using it to supply power to an external device.

Smart Sensor

The Smart Sensor configuration utility enables you to configure the Dolphin's integrated accelerometer, and motion settings.

Tap  > **Settings** > **System** > **Smart Sensor**.

Motion Settings

Motion Settings enable you to customize how the terminal responds to motion and object orientation for advanced power management.

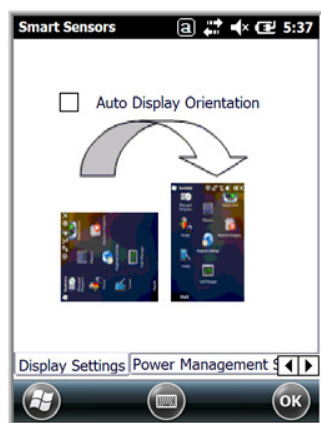

Display Settings enables or disables **Auto Display Orientation**. When enabled, the Dolphin's display automatically switches between portrait and landscape depending on how you hold the terminal.

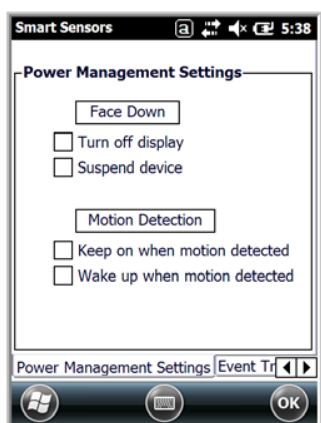

Power Management Settings customize how the terminal responds to object orientation and motion.

- Save power by turning off the display or suspending the terminal when it is placed face down.
- Modify the Motion Detection settings to wake the terminal from suspend mode or prevent the terminal from entering suspend mode when motion is detected.



Event Track displays an event log summary of detected free fall events exceeding 2 ft. over 250 ms. The summary includes the time, date, and duration of the most recent 50 events. Several options are provided for audible notification of free fall events.

Accelerometer Calibration

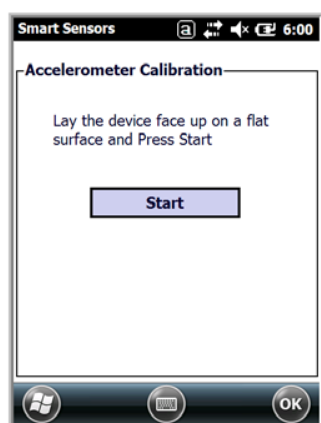

Tap **Start** to calibrate the integrated accelerometer sensor used for motion detection. When calibration is complete, the "Accelerometer Calibration Finished!" message window appears.

Managed Programs

Managed Programs are a list of programs that are managed if enrolled to enterprise domain. Managed Programs is the client-side that works with the server product System Center Mobile Device Manager (MDM). MDM consists of MDM Gateway Server and one or more computers that run MDM Device Management Server; MDM Enrollment Server; and Microsoft SQL Server® 2005 databases.

It lets system administrators:

- provide an authenticated connection to Line of Business (LOB) applications, managed Group Policy, and application packages.
- use Group Policy and software packages to manage the enrolled Windows phones (enforce policy, wipe devices, etc.).
- manage the requests for and retrieving of certificates for devices and for creating the Active Directory® Domain Service objects that represent these devices. By using these objects, you can manage the devices as if they were members of a domain.

Memory

The Memory applet shows the capacity and usage of the Storage and Program portions of the Flash file system. The Storage portion includes the IPSM folder, which can be detailed under the Storage Card tab. When the Program portion becomes too full, you can use the Task Manager to remove any unnecessary tasks.

Main Screen

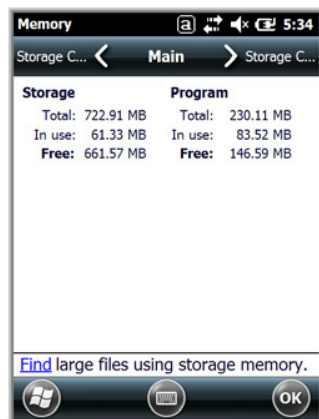

This screen displays the usage statistics of the flash memory.

Storage Card Screen

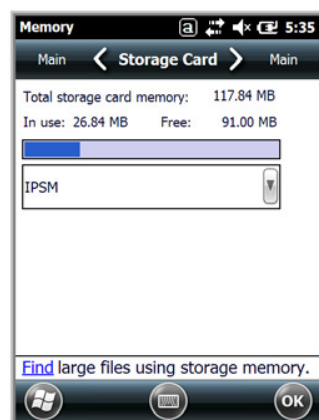

This screen displays the current capacity and usage statistics of the selected memory type: IPSM, RAMDISK or Storage Card.

Select the memory type from the drop-down list. IPSM is selected by default.

Total storage card memory = The total MB of memory capacity of the IPSM, RAMDISK or Storage Card.

In use = The MB currently being used.

Free = The MB that is still available for use.

IPSM—Short for Internal Persistent Storage Manager. Data or programs stored in the IPSM are not affected when the operating system is upgraded. Autoinstall programs, for example, are stored in \\IPSM\Honeywell\Autoinstall so that they are always installed after an operating system upgrade or factory reset. Contact a Honeywell technical support representative for more information on how to perform a factory reset. For contact information, see [Technical Assistance](#) on page 18-2.

RAMDISK—Is a disk image that resides in RAM and therefore is faster than IPSM or any other system named folder. RAMDISK is cleared when a hard reset or a factory reset is performed.

Storage Card—You can install one memory card in Dolphin terminals (see [Installing a SIM Card and/or Memory Card](#) on page 3-16). If a storage card is installed in the terminal, you can select it in the drop-down list and see capacity and usage statistics for the card.

RIL

The RIL Information screen displays useful statistics for the GSM WAN Voice module (PH8). To verify whether or not the GSM radio is enabled, check the [Dolphin Wireless Manager](#) (see page 8-4).

Power

Power system settings contains two tabs: Battery and Advanced

Tap  > **Settings** > **System** > **Power**

Battery Tab

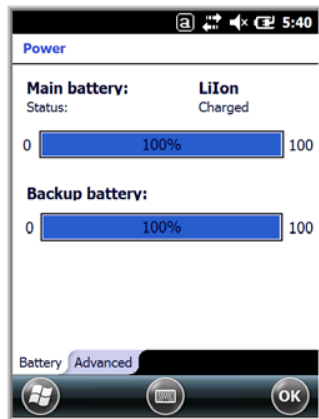

The battery tab displays the power level status of the main battery and the status of the backup battery.

Note: The Backup Battery gauge registers either 0% or 100%. The percentage is not an indication of the level of charge remaining on the backup battery. An installed and functional battery registers 100%. A total discharge or a battery error registers 0%.

For detailed information on the main battery pack, see [Battery](#) on page 7-10.

Advanced Tab

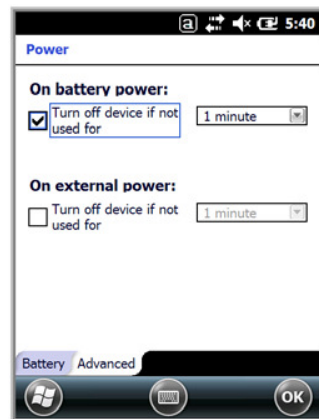

Determines power time-outs.

For **On battery power**, select from the drop-down list, the number of minutes of inactivity you want to pass before the terminal powers off when running on battery power.

For **On external power**, select from the drop-down list, the number of minutes of inactivity you want to pass before the terminal powers off when running on external power.

Note: When the terminal “powers off”, it enters [Suspend Mode](#), see page 2-11 for additional information.

Regional Settings

Regional Settings enables you to customize the appearance and formatting to your geographic region. Specifically, you can customize numbers (i.e., number of decimal places allowed), currency (i.e., using the \$ or € symbol), time, and date. These specifications apply to all screens, including the Home screen. The Region tab displays an overview of the region selected in the drop-down list at the top.

The terminal is loaded with a number of pre-programmed regional settings. Select one from the list and the results appear on the screen. To see specific settings or to change a specific setting, tap on one of the items on the horizontal scroll bar (i.e., Region, Number, Date), make the change, and tap **OK** to save.

Remove Programs

Remove Programs enables you to remove programs installed on the terminal. Any program (usually CAB or DLL files) stored in the \\IPSM\Honeywell\Autoinstall folder re-installs after a software upgrade or a factory reset. If a program is manually removed using the **Remove Programs** application, the program does not re-install on a hard or soft reset.

Note: A program (file) does not automatically install if it is added to the \\IPSM\Honeywell\Autoinstall folder and a hard or soft reset is performed. For information on program installation, see [Installing Additional Software](#) on page 8-8.

For information about the system resets, see [Resetting the Terminal](#) on page 2-11. See Honeywell support for more information on how to perform a factory reset.

1. Tap **Remove Programs**. In the list, select the program you want to remove.

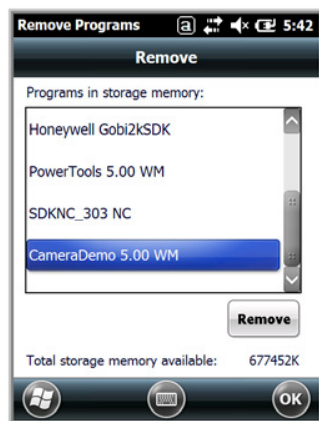

2. Tap **Remove**. The following message appears:



3. Tap **Yes**. Wait while the program is removed.
4. Verify that the program no longer appears in the list.