



Dolphin® 7850 Series

Microsoft® Windows Mobile® 5.0



User's Guide— Preliminary

Disclaimer

Hand Held Products, Inc. ("Hand Held Products") reserves the right to make changes in specifications and other information contained in this document without prior notice, and the reader should in all cases consult Hand Held Products to determine whether any such changes have been made. The information in this publication does not represent a commitment on the part of Hand Held Products.

Hand Held Products shall not be liable for technical or editorial errors or omissions contained herein; nor for incidental or consequential damages resulting from the furnishing, performance, or use of this material.

This document contains proprietary information that is protected by copyright. All rights are reserved. No part of this document may be photocopied, reproduced, or translated into another language without the prior written consent of Hand Held Products.

© 2007 Hand Held Products, Inc. All rights reserved.

Web Address: www.handheld.com

Trademarks

Dolphin, Dolphin RF, HomeBase, Mobile Base, and QuadCharger are trademarks or registered trademarks of Hand Held Products, Inc.

Microsoft, Windows, Windows Mobile, Windows CE, Windows NT, Windows 2000, Windows ME, Windows XP, ActiveSync, Outlook, and the Windows logo are trademarks or registered trademarks of Microsoft Corporation.

Other product names mentioned in this manual may be trademarks or registered trademarks of their respective companies and are the property of their respective owners.

Chapter 8 contains copyrighted information from Meetinghouse Corporation. Meetinghouse, the Meetinghouse logo, and all other Meetinghouse trademarks/service marks contained herein are trademarks or registered trademarks of Meetinghouse.



Table of Contents

Chapter 1 - Agency Information

Label Locations	1-1
Regulatory and Safety Approvals for all Dolphin Terminals	1-2
FCC Compliance	1-3

Chapter 2 - Getting Started

Today Screen	2-2
Navigation Bar.....	2-2
Using the Stylus.....	2-3
Pop-Up Menus.....	2-3

Chapter 3 - Hardware Overview

Standard Terminal Configurations	3-1
Dolphin 7850 Series Peripherals	3-2
Dolphin 7850 Series Accessories	3-2
Front Panel Features	3-3
Back Panel Features.....	3-4
Side Panel Features.....	3-5
Bottom Panel Features.....	3-8
Mechanical Connector	3-8
Battery Power	3-9
Main Battery Pack.....	3-9
Internal Backup Battery	3-10
Resetting the Terminal.....	3-13
Soft Reset (Warm Boot).....	3-13
Hard Reset (Cold Boot).....	3-13
Suspend Mode	3-13
Dolphin 7850 Technical Specifications.....	3-14

Chapter 4 - Using the Keyboards

Overview	4-1
Using the Function Keys	4-2
Using the Navigation Keys.....	4-3
Using the Modifier Keys	4-3
24-Key Keyboard	4-4
Toggling Between Alpha and Numeric Modes.....	4-4
24-Key Blue Key Combinations	4-6
24-Key Red Key Combinations	4-7
38-Key Keyboard	4-8
Toggling Between Numeric and Alpha Modes.....	4-8
Alpha Mode Keys	4-10
38-Key Blue Key Combinations	4-11
38-Key Red Key Combinations	4-11

Chapter 5 - Using the Image Engine

Overview	5-1
Available Image Engines.....	5-1

Available Laser Engines	5-1
Supported Bar Code Symbologies.....	5-2
Activating the Engine	5-3
Decoding.....	5-3
Capturing Images.....	5-5

Chapter 6 - Settings

Overview	6-1
Personal Settings.....	6-2
Buttons	6-3
Menus - Modifying the Start Menu.....	6-4
System Settings.....	6-7
About.....	6-7
Backlight	6-7
Memory.....	6-9
Power	6-11
Remove Programs	6-12
Screen.....	6-13

Chapter 7 - Communication

Communication Options.....	7-1
Default Com Port Assignments	7-2
Installing Additional Software.....	7-2
Using ActiveSync	7-3
Connections Tab	7-6
Connecting the Terminal to a Wireless Network	7-7
Connecting the Terminal to an ISP.....	7-7
Adding Programs From the Internet.....	7-7
Using Infrared Communication	7-8
Connections Manager	7-10
Network Cards	7-12
Radio Manager	7-13
USB to PC	7-14

Chapter 8 - Wireless LAN Communication with 802.11g

Overview	8-1
Enabling the 802.11g Radio.....	8-1
Configuring the 802.11g Radio	8-1
Opening the Client.....	8-2
Main Window	8-3
Setup Windows.....	8-6
Configuring Client Authentication	8-6
Configuring a Port	8-10
Configuring a Network Profile.....	8-13
WEP Encryption Without Authentication	8-17
Associating With Open APs.....	8-17
Certificates.....	8-18
Installing Certificates with CertAdd	8-18
Installing a Root Certificate	8-19

Advice and Workarounds	8-20
------------------------------	------

Chapter 9 - Wireless PAN Communication with Bluetooth

Bluetooth Radio	9-1
BTE Explorer	9-1
Enabling the Bluetooth Radio.....	9-1
Accessing BTE Explorer.....	9-1
Using BTE Explorer.....	9-2
Connection Types	9-3
Device Types	9-4
View Options	9-4
Menu Options	9-5
Refreshing Discovered Devices.....	9-6
Pairing.....	9-6

Chapter 10 - Dolphin HomeBase

Overview	10-1
Front Panel	10-2
Back Panel	10-3
Bottom Panel Dimensions	10-4
Powering the HomeBase	10-5
Charging the Main Battery	10-6
ActiveSync Communication.....	10-7
RS-232 Cables	10-8
Mounting the Dolphin HomeBase	10-9

Chapter 11 - Dolphin QuadCharger

Overview	11-1
Front Panel	11-1
Back Panel	11-2
Inserting and Removing Battery Packs	11-2
Supplying Power to the QuadCharger	11-3
Charging Batteries in the QuadCharger.....	11-3
Recommendations for Storing Batteries.....	11-3
Using the Battery Analyzer	11-4
Bottom Panel	11-5
Mounting the QuadCharger	11-5
Troubleshooting.....	11-6
Dolphin QuadCharger Technical Specifications	11-7

Chapter 12 - Dolphin Cables

Cable Features	12-1
Using the Dolphin Power Cable	12-2
Using the Dolphin Mobile Charger	12-3
Using the Dolphin Charge/Comm Cable.....	12-4

Chapter 13 - Customer Support and Warranty

Technical Assistance	13-1
Online Technical Assistance	13-1
For Further Information	13-1
Product Service and Repair	13-2
Online Product Service and Repair Assistance.....	13-2
Limited Warranty	13-3

Label Locations

Dolphin 7850 mobile computers meet or exceed the requirements of all applicable standards organizations for safe operation. However, as with any electrical equipment, the best way to ensure safe operation is to operate them according to the agency guidelines that follow. Please read these guidelines carefully before using your Dolphin mobile computer.

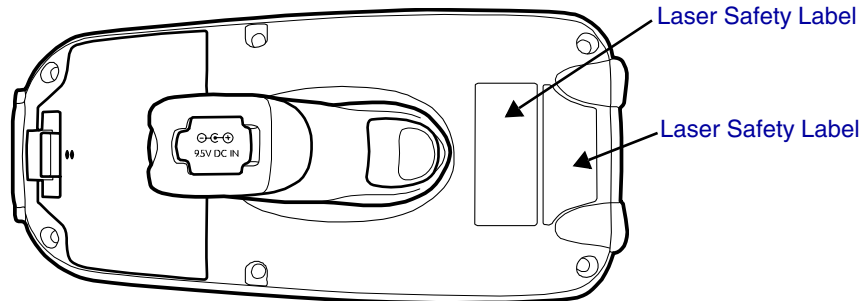

Dolphin 7850 Series 802.11g (WLAN) & Bluetooth

Dolphin 7850 RF terminals are designed to comply with the most current applicable standards on safe levels of RF energy developed by the Institute of Electrical and Electronics Engineers (IEEE) and the American National Standards Institute (ANSI) and has been recommended for adoption by the Federal Communications Commission (FCC).

Laser Safety Label

If the following label is attached to your product, it indicates the product contains a laser engine or laser aimer:

Laser Eye Safety Statement: This device has been tested in accordance with and complies with EN60825-1: 1993+A1+A2 and 21 CFR 1040.10 and 1040.11, except for deviations pursuant to Laser Notice No. 50, dated July 26, 2001. **LASER LIGHT, DO NOT STARE INTO BEAM, CLASS 2 LASER PRODUCT, 1.0 mW MAX OUTPUT: 650nm.**

Caution - use of controls or adjustments or performance of procedures other than those specified herein may result in hazardous radiation exposure.

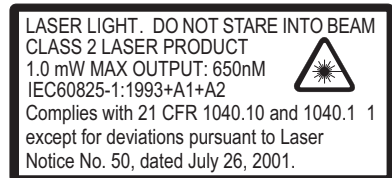

LED Safety Statement

This device has been tested in accordance with IEC60825-1 LED safety, and has been certified to be under the limits of a Class 1 LED device.

The maximum power outputs for each diode are as follows:

- Illumination LED: 194.0 uW
- Aimer laser (5300 engine): 360.1 uW
- Aimer LED (5100 engine): 81.6 uW

Infrared LED Safety Statement

Caution - Class 1M LED radiation when open. Do not view directly with optical instruments.

The maximum power outputs for the IR LED is 145.1 uW.

UL and cUL Statement

UL and cUL listed: UL60950-1 and CSA C22.2 No. 60950-1-03.

Regulatory and Safety Approvals for all Dolphin Terminals

Parameter	Specification
U.S.A	FCC Part 15, Class B
Canada	ICES-003
European Community	EN 55022 (CISPR 22) Class B EN60950:2000 EN60825-1:1994 + A11 + A2 EN55024:1998

 The CE Mark on the product indicates that the system has been tested to and conforms with the provisions noted within the 89/336/EEC Electromagnetic Compatibility Directive and the 73/23/EEC and 93/68/EEC Low Voltage Directive.

For further information, please contact:

Hand Held Products, Inc.
Nijverheidsweg 9
5627 BT Eindhoven
The Netherlands

Hand Held Products shall not be liable for use of our product with equipment (i.e., power supplies, personal computers, etc.) that is not CE marked and does not comply with the Low Voltage Directive.

FCC Compliance

Dolphin terminals comply with part 15 of the FCC rules. Operation is subject to the following two conditions: (1) this device may not cause harmful interference, and (2) this device must accept any interference received, including interference that may cause undesired operation.

Dolphin RF Terminal—802.11g and/or Bluetooth

This device complies with Part 15 of the FCC Rules. Operation is subject to the following two conditions: (1) this device may not cause harmful interference, and (2) this device must accept any interference received, including interference that may cause undesired operation.

This equipment has been tested and found to comply with the limits for a Class B digital device pursuant to Part 15 of the FCC Rules. These limits are designed to provide reasonable protection against harmful interference in a residential installation. This equipment generates, uses, and can radiate radio frequency energy and, if not installed and used in accordance with the instructions, may cause harmful interference to radio communications. However, there is no guarantee that interference will not occur in a particular installation. If this equipment does cause harmful interference to radio or television reception, which can be determined by turning the equipment off and on, the user is encouraged to try to correct the interference by one or more of the following measures:

- Reorient or relocate the receiving antenna.
- Increase the separation between the equipment and receiver.
- Connect the equipment into an outlet on a circuit different from that to which the receiver is connected.
- Consult the dealer or an experienced radio/TV technician for help.

If necessary, the user should consult the dealer or an experienced radio/television technician for additional suggestions. The user may find the following booklet helpful: "Something About Interference." This is available at FCC local regional offices. Our company is not responsible for any radio or television interference caused by unauthorized modifications of this equipment or the substitution or attachment of connecting cables and equipment other than those specified by our company. The correction is the responsibility of the user. Use only shielded data cables with this system.

In accordance with FCC 15.21, changes or modifications not expressly approved by Hand Held Products, Inc. may void the FCC authorization to operate the equipment.

CAUTION! Any changes or modifications not expressly approved by the grantee of this device could void the user's authority to operate the equipment.

For body worn operation, this device has been tested and meets the FCC RF exposure guidelines when used with the Hand Held Products Dolphin accessories supplied or designated for this product. Use of other accessories may not ensure compliance with FCC RF exposure guidelines.

RF, Regulatory, and Safety Agency Approvals—802.11g and/or Bluetooth

Parameter	Specification
RF Approvals	
U.S.A	FCC Part 15.247
Canada	RSS 210

R&TTE Compliance Statement—802.11g and/or Bluetooth

Dolphin RF terminals are in conformity with all essential requirements of the R&TTE Directive (1999/5/EC). This equipment has been assessed to the following standards as applicable:

Parameter	Specification
R&TTE	EN 300 328-2:2000 EN 301 489-1 (2002-08) EN 301 489-17 (2002-08) EN 60950:2000 EN 50361:2001

This product is marked with **CE 0682** ⓘ in accordance with the Class II product requirements specified in the R&TTE Directive, 1999/5/EC.

The equipment is intended for use throughout the European Community. PAN European Frequency Range: 2.402—2.480 GHz.

Restrictions in France are as follows:

- Indoor use: Maximum power (EIRP*) of 100 mW for the entire 2.400—2.4835 GHz
- Outdoor use: Maximum power (EIRP*) of 100 mW for the 2.400—2.454 GHz band and maximum power (EIRP*) of 10 mW for the 2.454—2.483 GHz band

Canadian Compliance

This Class B digital apparatus complies with Canadian ICES-003. Operation is subject to the following two conditions: (1) this device may not cause harmful interference, and (2) this device must accept any interference received, including interference that may cause undesired operation.

To prevent radio interference to the licensed service, this device is intended to be operated indoors and away from windows to provide maximum shielding. Equipment (or its transmit antenna) installed outdoors is subject to licensing.

Cet appareil numérique de la Classe B est conforme à la norme NMB-003 du Canada.

For European Community Users

Hand Held Products complies with Directive 2002/69/EC OF THE EUROPEAN PARLIAMENT AND OF THE COUNCIL of 27 January 2003 on waste electrical and electronic equipment (WEEE).

Waste Electrical and Electronic Equipment Information

This product has required the extraction and use of natural resources for its production. It may contain hazardous substances that could impact health and the environment, if not properly disposed.

In order to avoid the dissemination of those substances in our environment and to diminish the pressure on the natural resources, we encourage you to use the appropriate take-back systems for product disposal. Those systems will reuse or recycle most of the materials of the product you are disposing in a sound way.



The crossed out wheeled bin symbol informs you that the product should not be disposed of along with municipal waste and invites you to use the appropriate separate take-back systems for product disposal.

■ If you need more information on the collection, reuse, and recycling systems, please contact your local or regional waste administration.

You may also contact your supplier for more information on the environmental performances of this product.

Pacemakers, Hearing Aids and Other Electrically Powered Devices

Most manufacturers of medical devices adhere to the IEC 601-1-2 standard. This standard requires devices to operate properly in an EM Field with a strength of 3V/m over a frequency range of 26 to 1000MHz. The maximum allowable field strength emitted by the Dolphin is 0.3V/m according to Subpart B of Part 1 of the FCC rules. Therefore, the Dolphin RF has no effect on medical devices that meet the IEC specification.

Microwaves

The radio in the Dolphin RF terminal operates on the same frequency band as a microwave oven. Therefore, if you use a microwave within range of the Dolphin RF terminal you may notice performance degradation in your wireless network. However, both your microwave and your wireless network will continue to function. The Dolphin Batch terminal does not contain a radio, and therefore, is not affected by microwave ovens.

This chapter describes what to do with your Dolphin device when you first receive it.

Step 1. Unpack the Carton

Verify that the carton contains the following items:

- Dolphin 7850 mobile computer (the terminal)
- Main battery pack (7.4v, Li-ion)
- Getting Started CD-ROM
- Dolphin 7850 Quick Start Guide

Be sure to keep the original packaging in the event that the Dolphin terminal should need to be returned for service. For details, see [Limited Warranty](#) on page 13-3.

If you ordered additional peripherals, accessories, verify that they are included with the order.

Step 2: Install the Main Battery Pack



Use only the Li-ion battery packs provided by Hand Held Products. The use of any battery pack not sold/manufactured by Hand Held Products in a Dolphin terminal will void your warranty and may result in damage to the Dolphin terminal or battery.

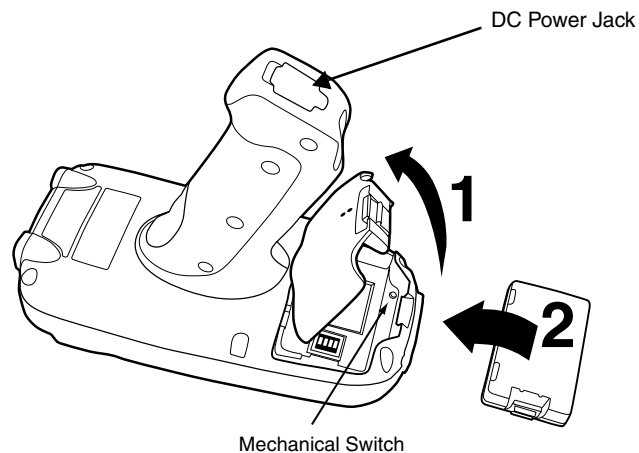

You must re-attach the battery door! The Dolphin 7850 contains a mechanical switch under the battery door that prevents the terminal from initializing unless the battery door is closed.

Step 3. Charge the Batteries

There are two types of battery power: the main battery pack and the backup battery located inside the terminal. The main battery pack powers the terminal and charges the internal backup battery.

Dolphin terminals ship with both batteries discharged of power. **Charge the main battery pack for a minimum of four hours before initial use!**

You can use one of the following charging peripherals:

- Dolphin HomeBase
- Dolphin QuadCharger
- Dolphin Charge/Comm Cable
- Dolphin AC Adapter Cable



Use Dolphin 7850 peripherals with the power cables provided by Hand Held Products. Use of peripherals or cables not sold/manufactured by Hand Held Products will void the warranty and may damage the terminal.

Step 4. Boot the Terminal

The terminal begins booting as soon as power is applied and runs by itself. Do NOT press any keys or interrupt the boot process. When the boot process is complete, the Today screen appears and the terminal is ready for use.

Today Screen

Initial boot and system resets end on the Today screen; see [Resetting the Terminal](#) on page 3-13.

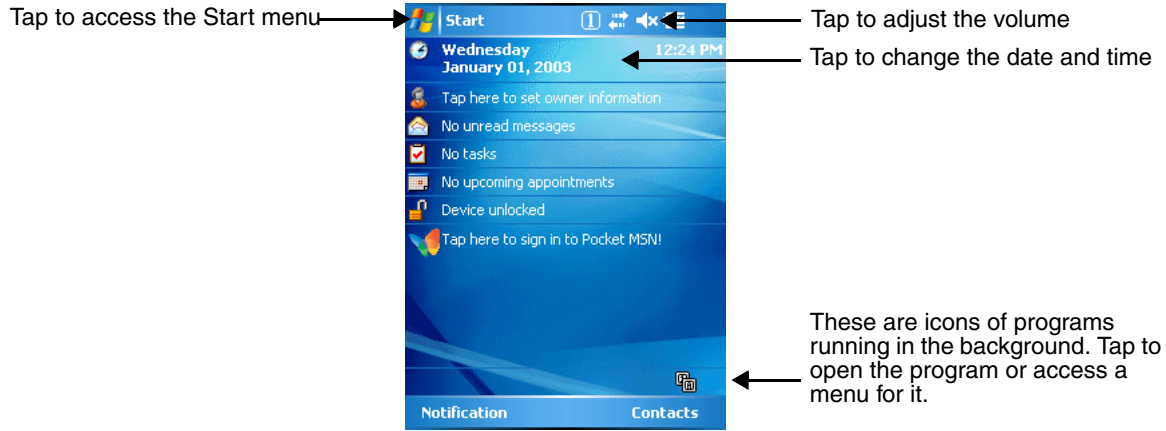

Note: You can also open the Today screen at any time by tapping Start > Today.

Navigation Bar

Located at the top of every screen, the Navigation bar provides access to the Start menu, shows the current time (from the system clock), and displays both status and keyboard status icons.

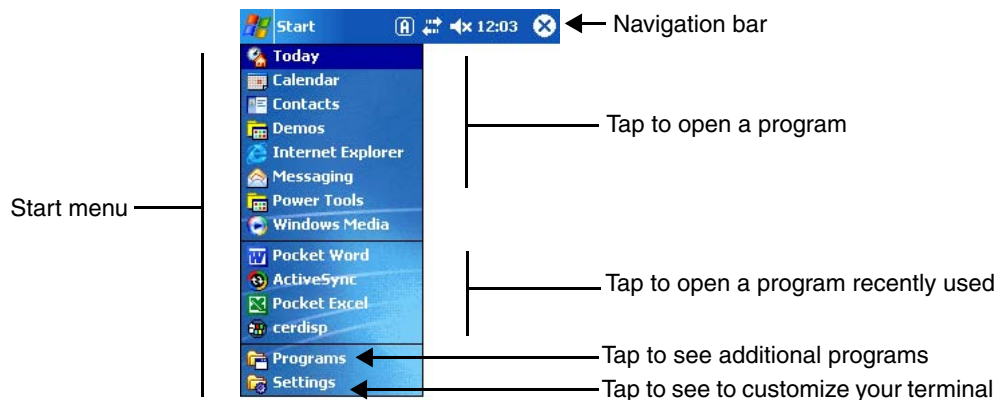

Command Bar

Located at the bottom of application screens, the Command bar includes application menus, buttons, and provides access to the Soft Input Panel (SIP).



The contents of the Command bar changes according to the open application.

Using the Stylus

Use the stylus or your finger to select or enter information on the touch panel. The stylus functions as a mouse; generally, a tap is the same as a click.

- Tap** Tap the touch panel once to open menu items and select options.
- Drag** Hold the stylus on the screen and drag across the screen to select text and images.
- Tap & hold** Tap and hold the stylus on an item and a pop-up menu appears. On the pop-up menu, tap the action of the task you want to perform.



Use of other objects, such as paper clips, pencils, or ink pens can damage the touch panel and will void the warranty. For more information about the touch panel, see [Touch Panel Display](#) on page 3-3.

Selecting Programs

The Start menu does not fit all installed programs. To see additional programs, tap **Start > Programs**. To open a program, tap once on the icon.

Pop-Up Menus

With pop-up menus, you can quickly choose an action for an item.

1. Tap and hold the stylus on the item name. The pop-up menu appears.
2. Lift the stylus, and tap the action you want to perform.

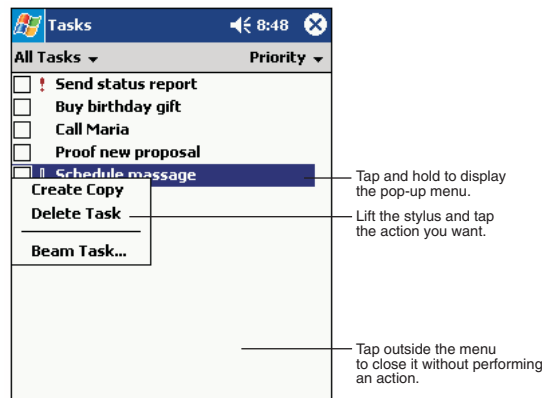

Note: To close the menu without performing an action, tap the screen anywhere outside the menu.

The contents of pop-up menus depend change according to the program you're in.

Searching for Information

You can use the Search feature or File Explorer to find and organize information. Tap **Start > Programs > Search**. Enter the text you want to find and tap **Search**.

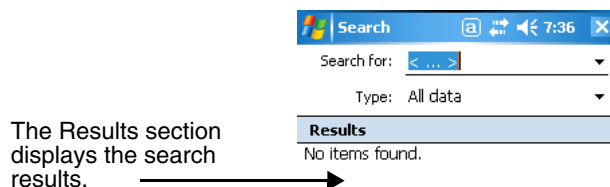



The Dolphin 7850 Series includes a number of standard terminal configurations as well as charging and communication peripherals and accessories to maximize the efficiency of your application setting.

Standard Terminal Configurations

The standard Dolphin 7850 terminal configuration is as follows:

- Microsoft Windows Mobile 5.0
- PXA270 520MHz processor
- 64MB RAM X 64MB Synchronous Flash
- 24-key calculator-style numeric with scrolling alpha or 38-key calculator-style numeric with full alpha
- 3.5 in. 1/4 VGA 240 x 320 TFT color display with hard-coat industrial touch panel
- 5300 or 5100 Standard Range (SR) image engine
- 802.11g radio (WLAN)
- Bluetooth radio

Configuration Options

The Dolphin 7850 Series offers you a number of configuration options to customize the Dolphin 7850 terminal to your business needs.

Memory Expansion	Additional 64MB of RAM (for a total of 128MB RAM); see Memory on page 6-9.
Mass Storage	Factory-installed 256MB or 512MB Secure Digital (SD) storage card.
Image Engines	HP (High Performance) Laser scanner LR (Long Range) Laser scanner ALR (Advanced Long Range) Laser scanner

Dolphin 7850 Series Peripherals

The following items are sold separately to complete your Dolphin 7850 installation.

Dolphin HomeBase™

The Dolphin HomeBase charging and communication cradle supports both RS-232 and USB communication, enabling your terminal to interface with the majority of PC-based enterprise systems. When a terminal is seated in the HomeBase, its main battery pack charges in less than four hours.

For more information, see [Dolphin HomeBase](#) on page 10-1.

Dolphin QuadCharger™

The Dolphin QuadCharger is a four-slot charging station for Li-ion battery packs. It can charge each battery in less than four hours. The fourth slot features a battery analyzer that completely resets and re-calibrates a battery, then displays remaining capacity.

For more information, see [Dolphin QuadCharger](#) on page 11-1.

Dolphin Cables

The Dolphin 7850 Series includes a number of cable kits that enable you to charge and communicate with other devices.

For more information, see [Dolphin Cables](#) on page 12-1.

Dolphin 7850 Series Accessories

Each of the following items is sold separately to enhance your Dolphin 7850.

Protective Enclosure

This enclosure wraps around the terminal to protect it from wear and tear.

Holsters

This enclosure holds one Dolphin 7850 terminal and can be worn around the waist for easy access.

Li-ion Battery Pack

The 7.4Vdc, 14.8 watt hour Li-ion rechargeable battery pack provides the main power supply for Dolphin terminals.

Front Panel Features

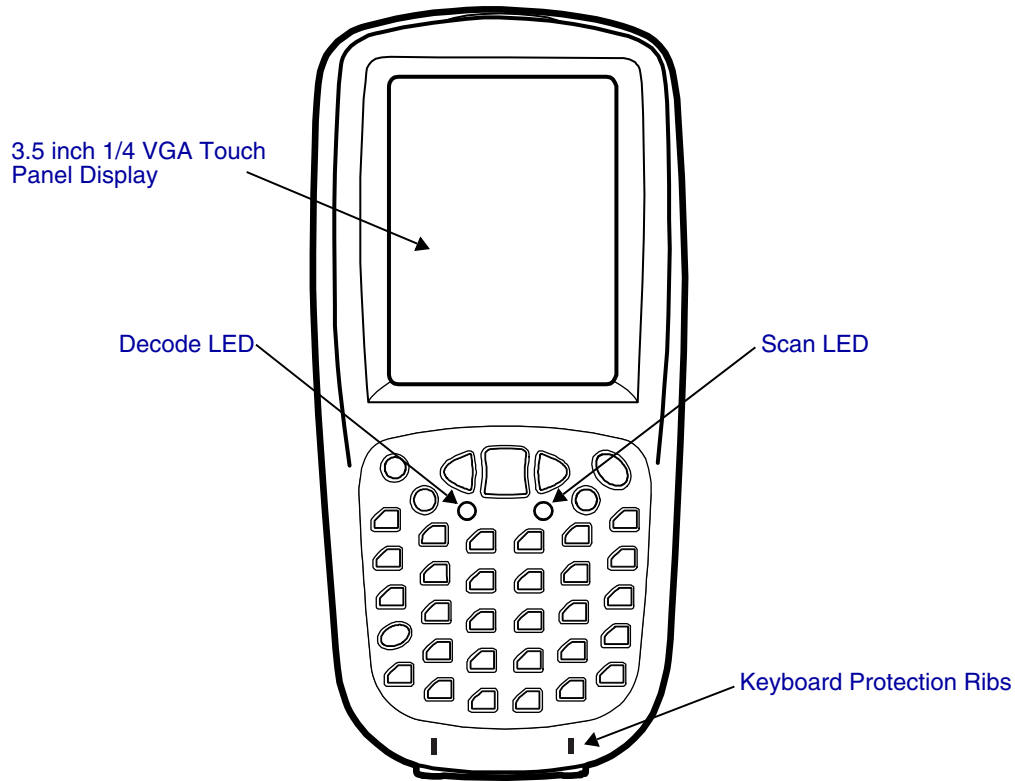

Decode and Scan LEDs

The Scan LED lights red when you press the Scan trigger in scanning applications. The Decode LED lights green when a scanned bar code is successfully decoded.

For more information, see [LEDs](#) on page 4-1.

Keyboard Protection Ribs

These ribs protect the keyboard and prevent keys from being pressed accidentally when the terminal is placed facedown on a flat surface. For a complete overview of each keyboard, see [Using the Keyboards](#) on page 4-1.

Touch Panel Display

The 3.5 inch 1/4 VGA (Video Graphic Array) display is a 262-, 144-color, transfective LCD (Liquid Crystal Display) in TFT (Thin Film Transistor) color with a 240 x 320 resolution. The LCD is covered by an industrial touch screen lens for maximum durability and backlit for maximum viewability; see [Backlight](#) on page 6-7.

Hand Held Products recommends using a screen protector with the touch panel. Screen protectors help prevent wear and damage and also protect the touch panel; especially when used with applications that require high-volume interfacing with the touch panel. We expect users to replace the screen protector at regular intervals when the screen protector is becoming worn or punctured.

For touch panel input, use the stylus included with the terminal or your finger. The method you choose depends on which one is most appropriate for your application. While there is a great deal of variation in different applications, use of the supplied stylus provides greater touch screen accuracy; see [Using the Stylus](#) on page 2-3.



Use of objects, such as paper clips, pencils, or ink pens on the touch screen can damage the touch panel and will void the warranty.

Back Panel Features

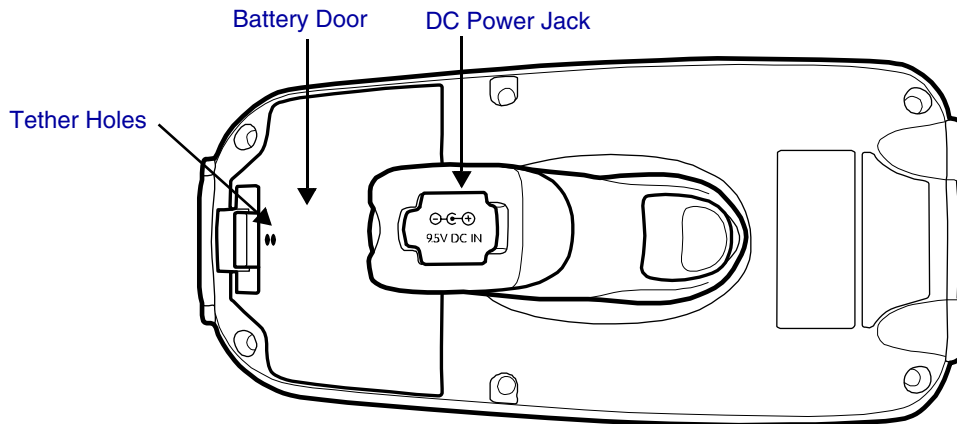

Battery Door

The battery door covers and secures the main battery pack in the battery well. There is a mechanical switch on the terminal under this door that puts the terminal in suspend mode (see page 3-13) while the battery door is open. This door must be closed for the terminal to resume operation. For more information, see [Installing the Main Battery Pack](#) on page 3-9.

DC Power Jack

Located on the bottom of the pistol-grip handle, the 9.5V DC power jack receives external power from the Dolphin Power Cable. When connected to the Dolphin Power Cable, the terminal is powered and the main battery pack is charging. For more information, see [Using the Dolphin Power Cable](#) on page 12-2.

Tether Holes

Loop one end of the optional battery door tether through these holes. For for information, see [Battery Door Tether](#) on page 3-6.

Side Panel Features

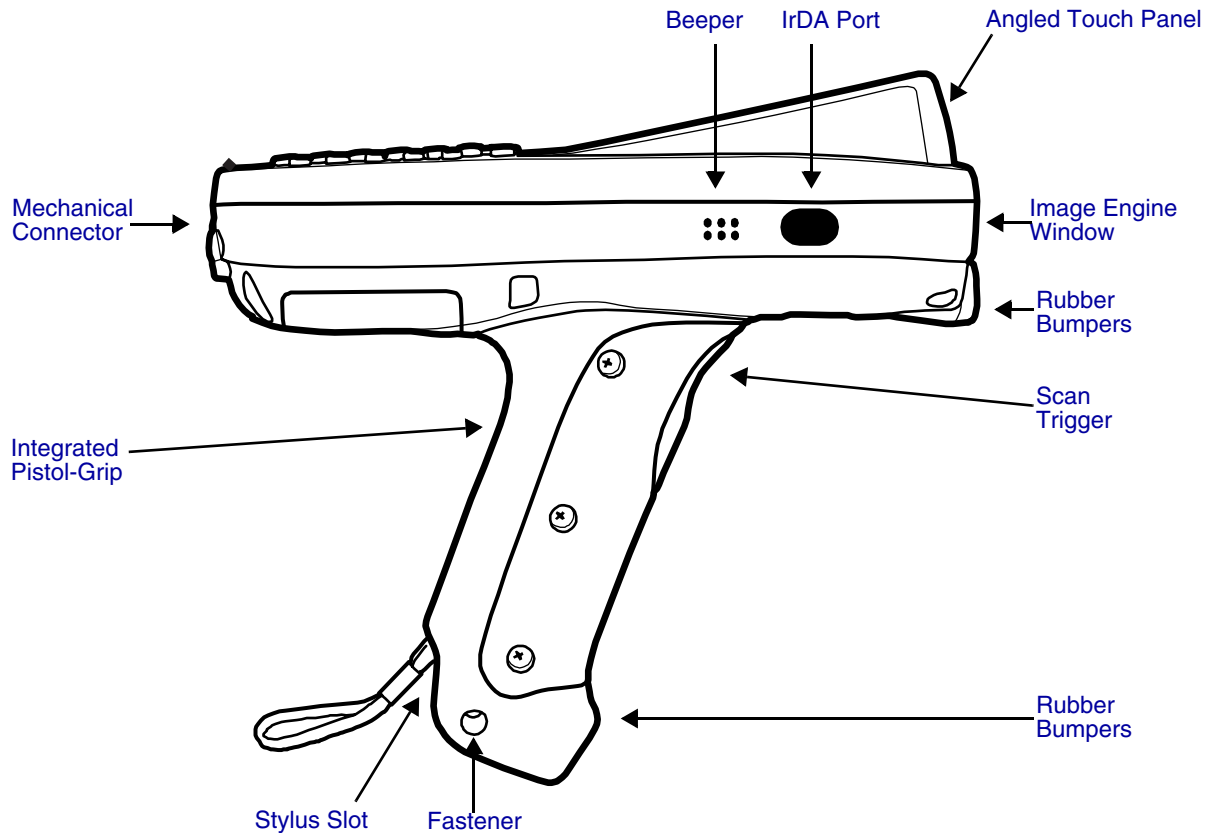

Note: This graphic shows the right side of the Dolphin 7850 terminal.

Angled Touch Panel

The touch panel display (see page 3-3) tilts up toward the user, which helps prevent glare and increases visibility in low-light conditions. Most important, the tilted display helps you read decoded data without having to tilt your wrist up repeatedly.

Beeper

The beeper sounds during decoding to indicate a good or bad scan.

Image Engine Window

The image engine reads and decodes most popular bar code symbologies; see [Supported Bar Code Symbologies](#) on page 5-2. In addition, the engine captures images like a digital camera.

The image engine points straight out the image engine window; simply point and scan. There are several image engine configurations available; for details on each, see [Available Image Engines](#) on page 5-1.

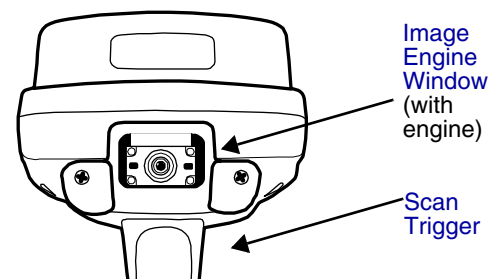

Integrated Pistol-Grip

The pistol-grip handle is integrated into the terminal and is not removable, which makes the unit more durable in the field. The handle is also positioned so that the terminal is balanced in your hand for added comfort when using the unit over long periods of time.

IrDA Port

The infrared port is IrDA-enabled (Infrared Data Association) and communicates with other IrDA-enabled devices such as PCs, printers, modems, or other Dolphin 7850 terminals. The maximum data transfer speed is 115 Kbps with a duty cycle of 18.75%. For more information, see [Using Infrared Communication](#) on page 7-8.

Scan Trigger

The front of the pistol-grip handle contains a scan trigger that activates the image engine. The scan trigger also wakes the terminal from [Suspend Mode](#) (see page 3-13).

Stylus Slot

Dolphin 7850 terminals ship with a stylus inserted into the pistol-grip handle. Stores the stylus in this slot when you're not using it. For more information about the stylus, see [Using the Stylus](#) on page 2-3.

Fastener

This hole through the bottom of the pistol-grip handle is used as a fastener to attach certain hardware accessories to the terminal.

Stylus Tether

The optional stylus tether is a coiled elastic cord with two ends: one end hooks onto the end of the stylus and the other end loops through this fastener hole. This attaches the stylus to the terminal, which keeps you from losing the stylus if you accidentally drop it.

Battery Door Tether

The battery door tether loops through the stylus fastener hole on one end and loops through the two holes on the back of the battery door on the other end. The tether keeps the battery door attached to the terminal when the battery door is opened or removed from the back panel.

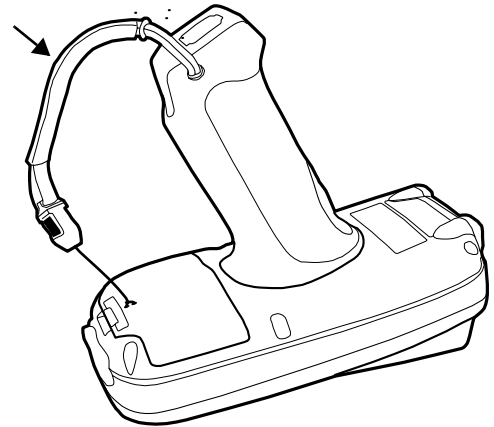

Rubber Bumpers

There are two sets of rubber bumpers: one set below the image engine window and the other set on the bottom front of the pistol-grip handle. Rubber bumpers enable you to set the terminal down on a flat surface with easy access to the handle, so you can pick up and put down the terminal with ease.

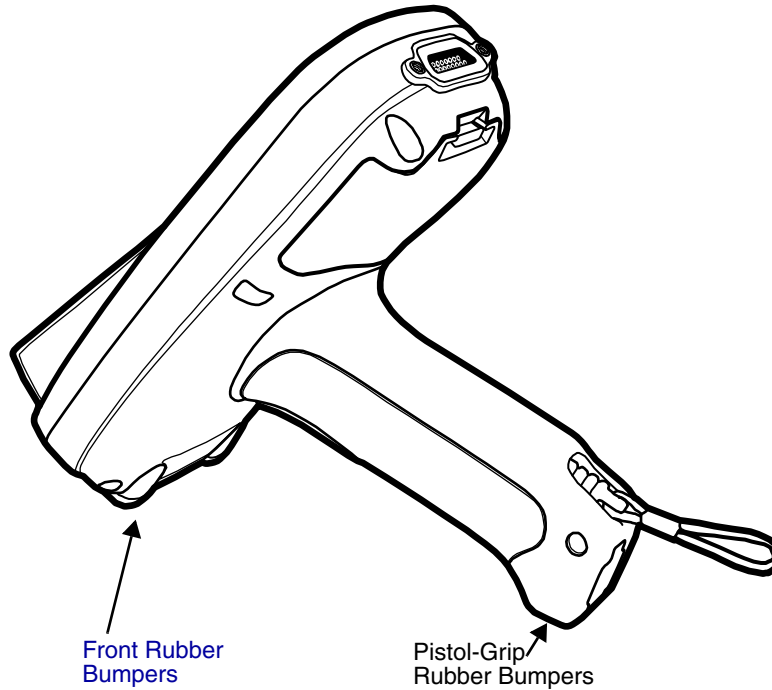

Front Rubber Bumpers

The front rubber bumpers enable you to rest the terminal on a flat surface without damaging the image engine window.

Bottom Panel Features

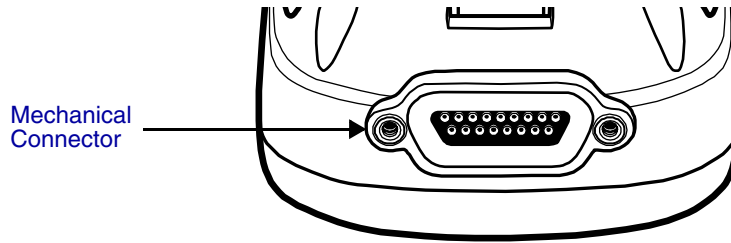

Mechanical Connector

The custom, industrial-grade, mechanical connector has 17 pins that are designed to work exclusively with Dolphin 7850 Series peripherals and cables. This connector powers the terminal, charges the main battery, and facilitates communication with a host workstation via Microsoft ActiveSync. The mechanical connector supports RS-232 (up to 115 Kbps) and USB (up to 12 Mbps).

For more information about ActiveSync communication, see [Using ActiveSync](#) on page 7-3.

The pins on the mechanical connector are as follows:

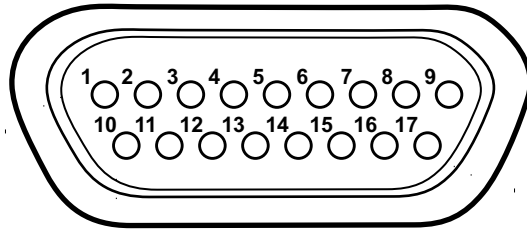

Pin #	Description
1	+USB
2	PWR
3	N/C
4	N/C
5	N/C
6	N/C
7	GND
8	5V OUT
9	DTR
10	-USB
11	USB DET
12	RI
13	DSR
14	RXD
15	RTS
16	TXD
17	CTS

Note: Signals referenced are for a DTE device.

Battery Power

The Dolphin 7850 features intelligent battery technology with two types of battery power:

- The main battery pack installed under the battery door on the back panel.
- The backup battery located inside the terminal.

Both batteries work together to prevent data loss when the terminal is used over long periods of time.

Main Battery Pack



Use only the Li-ion battery packs provided by Hand Held Products. The use of any battery pack not sold/manufactured by Hand Held Products in a Dolphin terminal will void your warranty and may result in damage to the Dolphin terminal or battery.

The 7.4V, 14.8 watt hour Li-ion battery pack is the primary power source for the Dolphin terminal and the internal backup battery. The Li-ion battery is designed to operate in a temperature range of -10 to 50°C (14 to 122°F).

Installing the Main Battery Pack

Put the terminal in [Suspend Mode](#) (see page 3-13) before installing a new battery. Press Blue + Backlight keys.



The battery door contains a mechanical switch under the battery door that automatically suspends terminal operation while open. Because of this switch, the terminal will not resume normal operations until the battery door is closed.

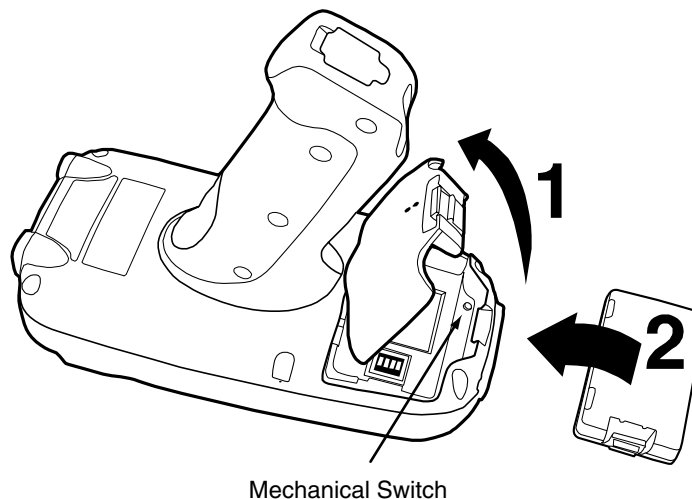

Charging Options

When the battery is installed in the terminal, you can insert the terminal into any one of the following peripherals to charge the main battery pack:

- [Dolphin HomeBase](#) (see page 10-1)
- [Dolphin ChargeBase](#) (see page 15-1)
- One of the Dolphin charging cables (see page 12-1)

To fully charge the Li-ion battery before installing it in the terminal, use the

- [Dolphin QuadCharger](#) (see page 11-1)
- [Auxiliary Battery Well](#) of the Dolphin HomeBase (see page 10-3)

Charge Time

The Li-ion battery pack requires four hours to charge to full capacity.

Internal Backup Battery

Located inside the terminal, the backup battery is a 3.6V nickel metal hydride (NiMH) battery.

The internal backup battery prevents the terminal from being reset when you remove the main battery pack. The backup battery retains RAM data and allows the real-time clock to remain operational for up to 30 minutes. If the terminal is left without the main battery pack for more than 30 minutes, the internal backup battery discharges and needs to be recharged to function according to specifications.

Note: Even if the internal backup battery fails, data and programs stored in Flash memory are not totally lost, but the terminal does automatically cold boot when you install a fully charged battery pack and you need to reset the real-time clock.

Charging

The internal backup battery charges off the main battery pack and requires eight hours charge time to backup RAM data for 30 minutes. You can begin using the Dolphin terminal after charging the main battery for four hours; however, the internal backup battery will continue to charge off the main battery.

To ensure that the internal backup battery functions properly, maintain a consistent power supply for the first eight hours of terminal operation. This power supply can be external power (using a charging peripheral) or an installed, charged battery pack or a combination of both.

Guidelines

Follow these guidelines to maximize the life of the Dolphin's internal backup battery:

- Keep a charged Li-ion battery pack in the Dolphin terminal.
- Keep the Dolphin terminal connected to a power source when the terminal is not in use.

Managing Battery Power

Data and files saved on the Dolphin terminal may be stored in RAM memory; therefore, maintain a continuous power supply to the terminal to help prevent data loss. When you remove a battery pack, insert another charged battery pack in the Dolphin. If the main battery pack is low, insert the terminal into a charging peripheral to power the terminal and begin recharging the battery.

*Note: If the main battery is low and the terminal is in suspend mode, pressing the SCAN trigger does **not** wake the Dolphin terminal; you must replace the discharged battery with a fully charged battery.*



Default Low and Critical Battery Points

The Dolphin terminal ships with default low and critical battery points programmed in the following registry parameters:

[HKEY_LOCAL_MACHINE\System\CurrentControlSet\Control\Power\LowBatt=19]

[HKEY_LOCAL_MACHINE\System\CurrentControlSet\Control\Power\CriticalBatt=a]

The Navigation bar at the top of the each screen displays battery warning icons when the main battery reaches the low, then critical battery points.

Registry Parameter	Description
LowBatt 	Sets the Low Battery point. The default is 25% (Hexadecimal=19). This is the point at which you are warned by an icon in the Navigation bar that the battery is low. You are notified only once for a low battery.
CriticalBatt 	Sets the Critical Battery point. The default is 10% (Hexadecimal=a). This is the point at which the you are warned by an icon in the Navigation bar that the battery is very low. This warning is posted every three minutes until the situation is corrected.

Note: Battery power warnings do not appear when the terminal is running on external power.

Setting Critical and Low Battery Points

Developers can re-reset the default battery points in the RegEdit Power Tool.

1. Tap **Start > Power Tools > RegEdit**.
2. Drill-down to **HKEY_LOCAL_MACHINE > System > CurrentControlSet > Control > Power**. The CriticalBatt and LowBatt values appear in the list.

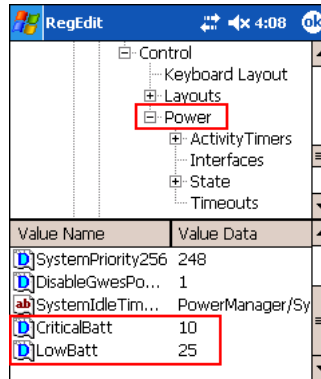

3. Tap the **Value Name** to change the Value Data. You can reset the Value Data from 0 (no warning) to 99 (would warn whenever the charge drops below 99%).
4. Tap **OK** to save changes.

Note: For more information about the RegEdit Power Tool, refer to the Dolphin Power Tools User's Guide, which is available for download at www.handheld.com.

Checking Battery Power

Tap **Start > Settings > System tab > Power**. The Battery tab opens displaying the charge status of the main battery pack.

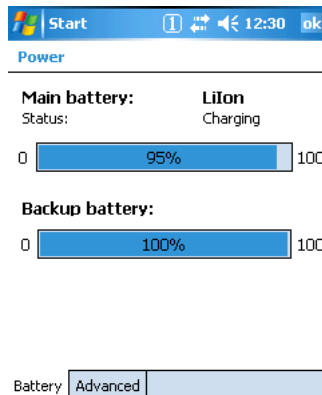

For more information, see [Power](#) on page 6-11.

Storage Guidelines

To maintain optimal battery performance, follow these storage guidelines:

- Avoid storing batteries outside the specified range of -4° to 104° F (-20° to 40°C) or in extremely high humidity.
- For prolonged storage, do not keep batteries stored in a charger that is connected to a power source.

Guidelines for Battery Use and Disposal

The following are general guidelines for the safe use and disposal of batteries:

- Use only the battery supplied, recommended, or approved by Hand Held Products.
- Replace defective batteries immediately; using a defective battery could damage the Dolphin terminal.



-
- Never throw a used battery in the trash. It contains heavy metals and should be recycled according to local guidelines.
 - Don't short-circuit a battery or throw it into a fire. It can explode and cause severe personal injury.
 - Excessive discharge damages a battery. Recharge the battery when your terminal indicates low battery power.
 - Although your battery can be recharged many times, it will eventually be depleted. Replace it after the battery is unable to hold an adequate charge.
 - If you are not sure the battery or charger is working properly, please send it to Hand Held Products or an authorized Hand Held Products service center for inspection.

Resetting the Terminal

There are two ways to reset the Dolphin terminal: a soft reset and a hard reset.

Soft Reset (Warm Boot)



A soft reset re-boots the device without losing RAM data. You would perform a soft reset 1) when the terminal fails to respond, 2) after installing software applications that require a reboot, or 3) after making changes to certain system settings.

1. Press and hold the Red  + ESC  keys for approximately five seconds. The screen turns white and the decode and scan LEDs flash for approximately three seconds.
2. When the reset is complete, the Today screen appears.

Hard Reset (Cold Boot)



A hard reset erases all of the data and applications stored in RAM memory and launches Autoinstall, which re-initializes the terminal.

1. Press and hold the Red  + Tab  keys for approximately five seconds. The screen turns white and the decode and scan LEDs light for approximately three seconds.
2. The terminal re-initializes; see [Boot the Terminal](#) on page 2-1.

Note: Hard resets automatically launch a soft reset before ending on the Today screen.

Set the time and date after each hard reset to ensure that the system clock is real-time. Tap the date on the Today screen to open the Clock and set the time and date.

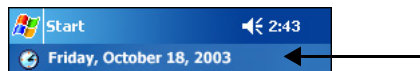



Suspend Mode

Suspend mode suspends terminal operation. The terminal appears to be “off” when in suspend mode.

The terminal is programmed to go into suspend mode automatically when inactive for a specific period of time. You can set this time period in the Power setting. For details, see the **Advanced Tab** section of the [Power](#) (see page 6-11) setting.

To Put the Terminal in Suspend Mode

Press the Blue  + Backlight  keys. You should put the terminal in suspend mode when you change the battery pack; see [Installing the Main Battery Pack](#) on page 3-9.

To Resume Terminal Operation

To resume terminal operation (or “wake” the terminal),

- Press the Backlight key .
- Press the [Scan Trigger](#) (see page 3-5).

Troubleshooting

If the terminal does not wake when you press the scan trigger,

- The battery door may not be fully closed. The mechanical switch under the battery door prevents the terminal from resuming operation until the door is closed.
- The main battery might be too low to resume operation. Remove the battery and install a fully charged battery or connect the terminal to a Dolphin charging peripheral.

Dolphin 7850 Technical Specifications

Feature	Description
Form Factor	Compact handle-style mobile computer
Operating System	Microsoft Windows Mobile 5.0
Development Environment	Hand Held Products Dolphin SDK for Visual Studio 2005—supports C/C++, C# and Visual Basic development on Visual Studio 2005
CPU	Intel PXA 270 520 MHz
Memory	64MB X 64MB & 128 MB RAM X 128 MB Flash memory options available
Display	3.5 in. 1/4 VGA 240x320 TFT color display w/ polycarbonate industrial-grade touch panel
Imager/Scanner	5100SR/SF VGA Area Imagers with bright green LED aimer 5300SR/SF VGA Area Imagers with High-Vis aiming pattern 5300HD VGA Area Imagers with High-Vis aiming pattern HP (High Performance) Laser scanner (future option) LR (Long Range) Laser scanner (future option) ALR (Advanced Long Range) Laser scanner (future option)
Keyboards	24-key calculator-style numeric with scrolling alpha 38-key calculator-style numeric with full alpha
Communications	100K duty-cycle plugable/dockable RS232/USB connector, IrDA, Audio beeper
Power	
Battery Type	Lithium-ion 7.4V, 14.1 Watt-hour, hot-swappable battery pack
Capacity	14.1 Watt-hours
Run Time	WLAN: 11 hours at 1 scan/6 sec, 1 data package logged every scan, 802.11b/g continuous connection, display backlight on full device suspend mode: 8 days minimum
Charging	9.5V AC input through handle charge port or USB/Serial connector, four hours recharge
Charging Peripherals	AC wall adapter, Charge/Communication Cable, single bay Home Base, 4 bay Charge Base, battery Quad Charger
Wireless Radios	
WLAN Standard	802.11b/g
WLAN Security	WEP, 802.1x, LEAP, WPA 1.0 & 2.0, TKIP, MD5, TLS, TTLS, PSK, PEAP, Cisco CCX compliant
WPAN (optional)	Bluetooth class 2, version 1.2 (optional feature)
Co-Located/Operational	Two radios: WLAN/WPAN

Dolphin 7850 Technical Specifications

Feature	Description
Physical	
Operating Temperature	Standard configuration is 14°—122°F / -10°—50°C nominal; -4° (-20°C) with reduced runtime Optional Bluetooth configuration is 32°—104°F / 0°—40°C
Construction	Magnesium alloy internal chassis with component shock mounts Engineering-grade polycarbonate outer housing with integrated rubber over-molded handle
Structural	5 ft. (1.5m) multiple drops to concrete, all surfaces, across operating temperature range Exceeds 2,000 3 ft. (1m) tumbles
Environmental	IP64 rated for blown dust/water intrusion
Dimensions	Main housing: 7.1 in. Long X 3.3 in. Wide X 1.4 in. Deep (18 cm Long X 8.4 cm Wide X 3.6 cm Deep) Handle: 4.6 in. Long X 1.6 in. Wide X 1 in. Deep (12 cm Long X 4.1 cm Wide x 2.5 cm Deep)
Weight	Approximately 20 oz./567 g
Warranty	Standard: 2 years on terminal; 1 year on battery.



Using the Keyboards

Overview

The keyboard buttons are recessed under the overlay for maximum durability. The keyboard panel is backlit for maximum visibility in various lighting conditions.

The Dolphin 7850 has two keyboard options:

24-Key Keyboard (see page 4-4)

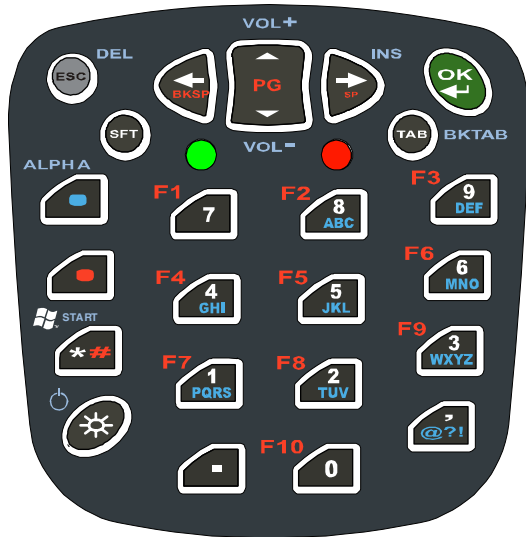

38-Key Keyboard (see page 4-8)



Calculator Style Numbering

Both Dolphin 7850 keyboards default to numeric mode and feature calculator-style numbering for ease-of-use in the field.

LEDs

The LEDs are in the center of the keyboard.

Scan LED The LED on the right lights red when you press the Scan trigger in scanning applications.

Decode LED The LED on the left lights green when a scanned bar code is successfully decoded.

Note: Both LEDs are user-programmable.



For more information, see [Using the Image Engine](#) on page 5-1.

Color-Coding

Keyboard overlays are color-coded to indicate the functions performed or characters typed when the color-coded key is pressed with the red or blue modifier key.

Keyboard Mode Indicator

Dolphin terminals have a Keyboard Status Power Tool (**Start > Power Tools > Keyboard Status**) that displays an icon in the Navigation bar to indicate if the keyboard is in alpha or number mode. Keyboard Status is active by default.

-  Indicates that the keyboard is in numeric mode.
-  Indicates that the keyboard is in alpha mode, uppercase.
-  Indicates that the keyboard is in alpha mode, lowercase.









Key Types

In addition to the standard number and letter keys, both keyboards contain three types of keys:

1. Function Keys: [Using the Function Keys](#) (see page 4-2)
2. Navigation Keys: [Using the Navigation Keys](#) (see page 4-3)
3. Modifier Keys: [Using the Modifier Keys](#) (see page 4-3)

Using the Function Keys



Function keys perform specific functions and usually have the name of the function they perform.

Name	Key	Function
Backlight		Toggles the keyboard backlight on and off.
Backspace (BKSP)		To backspace, press Red + left arrow. Backspace moves the cursor back one space and deletes each time the key combination is pressed. If you are typing text, a character is deleted each time you backspace.
Backtab (BKTAB)		To backtab, press the Blue + TAB. Backtab moves the cursor back to the previous tab stop or field (on a form or application window).
Delete (DEL)		To delete, press Blue + ESC. Deletes the next character forward. One character is deleted each time the key combination is pressed.
Escape		Cancels an action.
OK		Functions as an Enter key.
Resume		Resume the terminal by pressing Blue + Backlight. <i>Note: You can also press the Scan trigger on the handle.</i>
Space (SP)		To space, press Red + right arrow. Space moves the cursor one space forward. If you are typing text, it moves the text one space forward as well.
Tab		Moves the cursor to the next tab stop or field (on a form or application window).

Note: There is no SCAN key on the Dolphin 7850 keyboard; scanning is initiated with the [Scan Trigger](#) (page 3-5).

Using the Navigation Keys

Located in the center of each keyboard for easy access with either hand, the navigation keys enable you to navigate the cursor through an application screen.



Press	To ...
	Move the cursor up one row or line. Move the cursor down one row or line.
	Move the cursor one character to the right.
	Move the cursor one character to the left.

The navigation keys perform additional system functions when pressed in combination with the Blue and Red modifier keys. For details, see the key combination tables for the [24-Key Keyboard](#) (page 4-4) and the [38-Key Keyboard](#) (page 4-8).

Additional functionality of the navigation keys varies according to the application in use.

Using the Modifier Keys

Modifier keys modify the next key pressed to perform functions or type special characters. The Dolphin 7850 has Blue and Red modifier keys with a color-coded overlay so you can see what the key combination does.

Name	Key	Function
Shift		Provides shift functionality for application windows. Tap once to modify the next letter pressed. Tap twice for caps lock.
Blue and Red		Modifies the next key pressed. The overlay of each keyboard is color-coded to indicate the character typed or function performed with both keys.
Alpha		On the 38-key keyboard, the Alpha key toggles the keyboard between alpha and numeric modes.

24-Key Keyboard

The following graphic displays the 24-key numeric keyboard.

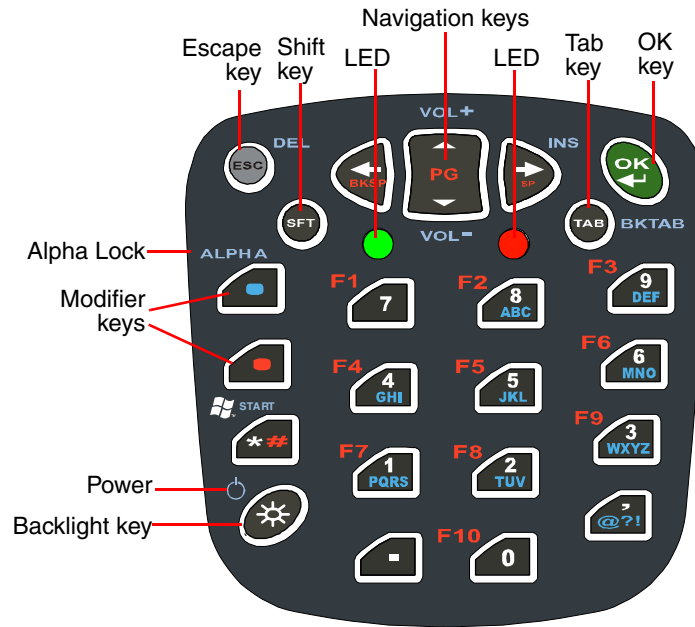

toggling Between Alpha and Numeric Modes

The 24-key keyboard defaults to numeric mode. Numeric mode is when you type numbers with the number keys.

- Double-tap the Blue modifier key to toggle between alpha and numeric modes.
- Single-tap the Blue modifier key to toggle to alpha or numeric mode only for the next key pressed. The keyboard returns to the previous state before the next key is pressed.
- Press and hold the Blue modifier key to toggle to alpha or numeric mode for all keys pressed until the Blue modifier key is released.

Alpha Mode

Alpha mode is when you type the letters or characters indicated in blue on the number keys.

Please note that when typing in alpha mode, you must use the same multi-press method you would use when typing letters on a phone keypad. Each key press types the next letter in the sequence as displayed by the alpha indicator.

You can still use the Blue modifier key for regular Blue key combinations in alpha mode; just press the Blue modifier key and the next key. For combinations, see [24-Key Blue Key Combinations](#) on page 4-6.

Shift Functionality in Alpha Mode

The SFT key performs all the normal windows shift key functions alpha mode, including capitalizing one letter. On the 24-key keyboard, the SFT key also toggles caps lock on and off.

- Single-tap the SFT key to modify the next key pressed; if this is a letter, that letter is capitalized.
- Double-tap the SFT key to toggle caps lock on and off in alpha mode.

Note: Check the mode indicator (see [Keyboard Mode Indicator](#) on page 4-1) in the Navigation bar to see what mode the keyboard is in.

24-Key Keyboard

Key	Num Mode	Alpha Upper	Alpha Lower	Red Mode	Blue Mode
ESC	ESC	ESC	ESC	Soft Reset	Delete
SFT	upper/lowercase*	alpha lower***	alpha upper***	upper/lowercase*	upper/lowercase*
	Blue Mode	Blue Mode	Blue Mode		toggle Num/Alpha***
	Red Mode	Red Mode	Red Mode		
Asterisk (*)	asterisk	asterisk	asterisk	#	Start
Backlight	Keyboard Light	Keyboard Light	Keyboard Light	Keyboard Light	Suspend
Left	Left	Left	Left	Backspace	
Up	Up	Up	Up	Page Up	Vol+
Down					Vol-
OK	Right	Right	Right	Space	Insert
Tab	OK	OK	OK	OK	OK
Period (.)	Tab	Tab	Tab	Hard Reset	Backtab
Comma (,)		@ ?!	@ ?!		@ ?!
0	0			F10	
1	1	PQRS	pqrs	F7	pqrs or PQRS
2	2	TUV	tuv	F8	tuv or TUV
3	3	WXYZ	wxyz	F9	wxyz or WXYZ
4	4	GHI	ghi	F4	ghi or GHI
5	5	JKL	jkl	F5	jkl or JKL
6	6	MNO	mno	F6	mno or MNO
7					
8					
9					

** Single-tap SFT toggles upper/lowercase for the next character; double-tap toggles upper/lowercase permanently
 *** Toggles numeric/alpha only on a double-tap

24-Key Blue Key Combinations

Alpha Mode

Key	Character Lower case	Character Upper case: SFT once for the next key SFT twice for caps lock
8	abc	ABC
9	def	DEF
4	ghi	GHI
5	jkl	JKL
6	mno	MNO
1	pqrs	PQRS
2	tuv	TUV
3	wxyz	WXYZ
*	*	*
,	@ ? !	@ ? !

Functions

Key Combination	Function
Blue + Backlight	Suspend
Blue + ESC	Delete
Blue + Tab	Backtab
Blue + Up Arrow	Volume up
Blue + Down Arrow	Volume down
Blue + Right Arrow	Insert

24-Key Red Key Combinations

Key Combination	Function/Special Character
Red + Left Arrow	Backspace
Red + Right Arrow	Space
Red + Up Arrow	Page up
Red + Down Arrow	Page down
Red + ESC (hold)	Soft reset (warm boot)
Red + TAB (hold)	Hard reset (cold boot)
Red + 1	F7
Red + 2	F8
Red + 3	F9
Red + 4	F4
Red + 5	F5
Red + 6	F6
Red + 7	F1
Red + 8	F2
Red + 9	F3
Red + 0	F10
Red + *	#

38-Key Keyboard

The following graphic displays the 38-key alpha keyboard.

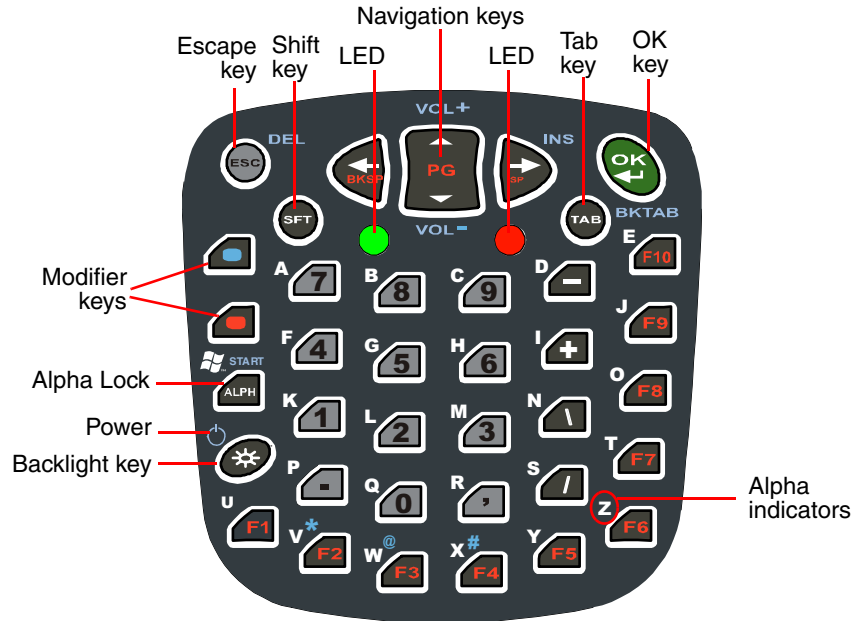

Toggling Between Numeric and Alpha Modes

The 38-key keyboard defaults to numeric mode. Numeric mode is when you type numbers with the number keys. Alpha mode is when you type the letter indicated on the overlay when you press the number key.

Alpha Mode

Single-tap the ALPH key  to toggle to alpha or numeric mode only for the next key pressed.

Shift Functionality in Alpha Mode

The SFT key performs all the normal windows shift key functions in alpha mode, including capitalizing one letter. On the 38-key keyboard, the SFT key also toggles caps lock on and off.

- Single-tap the SFT key to modify the next key pressed; if this is a letter, that letter is capitalized.
- Double-tap the SFT key to toggle caps lock on and off in alpha mode.

Note: Check the mode indicator (see [Keyboard Mode Indicator](#) on page 4-1) in the Navigation bar to see what mode the keyboard is in.

38-Key Keyboard

Key	Num Mode	Alpha Upper	Alpha Lower	Red Mode	Blue Mode
ESC	ESC	ESC	ESC	Soft Reset	Delete
SFT	upper/lowercase*	alpha lower**	alpha upper**	upper/lowercase*	upper/lowercase*
	Blue Mode	Blue Mode	Blue Mode		
	Red Mode	Red Mode	Red Mode		
ALPH	Alpha Mode	Num Mode	Num Mode	Alpha Mode	Start
Backlight	Keyboard Light	Keyboard Light	Keyboard Light	Keyboard Light	Suspend
Left	Left	Left	Left	Back space	
	Up	Up	Up	Page Up	Vol+
Down					Vol-
	Right	Right	Right	Space	Insert
OK	OK	OK	OK	OK	OK
Tab	Tab	Tab	Tab	Hard Reset	Backtab
Period (.)					
Comma (,)					
0	0	Q	q	0	0
1	1	K	k	1	1
2	2	L	l	2	2
3	3	M	m	3	3
4	4	F	f	4	4
5	5	G	g	5	5
6	6	H	h	6	6
7	7	A	a	7	7
8	8	B	b	8	8
9	9	C	c	9	9
-					
+					
\	\	N	n	\	\
/					
F1					
F2			v	F2	asterisk
	F3	w	w	F3	@
	F4	x	x	F4	#
	F5	y	y	F5	F5
	F6	z	z	F6	F6
	F7	t	t	F7	F7
	F8	o	o	F8	F8
	F9	j	j	F9	F9
	F10	e	e	F10	F10

* Toggles upper/lowercase only on a double-tap

** Single-tap SFT toggles upper/lowercase for the next character; double-tap toggles upper/lowercase permanently

Alpha Mode Keys

Key	Character Lower case	Character Upper case: SFT once for the next key SFT twice for caps lock
7	a	A
8	b	B
9	c	C
-	d	D
F10	e	E
4	f	F
5	g	G
6	h	H
+	i	I
F9	j	J
1	k	K
2	l	L
3	m	M
\	n	N
F8	o	O
.	p	P
0	q	Q
,	r	R
/	s	S
F7	t	T
F1	u	U
F2	v	V
F3	w	W
F4	x	X
F5	y	Y
F6	z	Z

38-Key Blue Key Combinations

Key Combination	Function
Blue + Backlight	Suspend/Resume
Blue + ESC	Delete
Blue + Right Arrow	Insert
Blue + Up Arrow	Volume up
Blue + Down Arrow	Volume down
Blue + ALPH	Start menu
Blue + Tab	Backtab
Blue + F2	*
Blue + F3	@
Blue + F4	#

38-Key Red Key Combinations

Key Combination	Function
Red + Left Arrow	Backspace
Red + Right Arrow	Space
Red + ESC (hold)	Soft reset (warm boot)
Red + TAB (hold)	Hard reset (cold boot)



Overview

The Dolphin 7850 terminal houses a compact image engine using Adaptus Imaging Technology 5.0™ that instantly reads all popular 1D and 2D bar codes and supports omni-directional aiming and decoding. The image engine can also capture digital images, such as signatures and pictures of damaged inventory.

Available Image Engines

Dolphin 7850 terminals may be equipped with one of the following image engines:

5100 Standard Range (5100SR)

5300 Standard Range (5300SR)

	8.3 mil Linear	10 mil PDF417	13 mil UPC	15 mil Data Matrix	15 mil QR	35 mil MaxiCode
*Working Range:	(.020cm)	(.025cm)	(.033cm)	(.038cm)	(.038cm)	(.089cm)
Near	3.5 in. (8.9cm)	3.1 in. (7.9cm)	2.1 in. (5.3cm)	2.3 in. (5.8cm)	3.1 in. (7.9cm)	2.0 in. (5.1cm)
Far	7.6 in. (19.3cm)	9 in. (22.9cm)	13.2 in. (33.5cm)	10.2 in. (25.9cm)	8.8 in. (22.4cm)	13.0 in. (33cm)

Available Laser Engines

Dolphin 7850 terminals can be equipped with one of the following laser engines:

High Performance (HP)

Code	5 mil	55 mil reflective
Working Range		
Near	2.75 in (0.07 m)	5 in (0.13 m)
Far	7 in (0.17 m)	50 in (1.27 m)

Long Range (LR)

Code	10 mil	100 mil reflective
Working Range		
Near	10 in (0.25 m)	66 in (1.67 m)
Far	24 in (0.6 m)	232 in (5.9 m)

Advanced Long Range (ALR)

Code	13 mil	100 mil reflective
Working Range		
Near	18 in (0.45 m)	102 in (2.6 m)
Far	39 in (1 m)	363 in (9.2 m)

Supported Bar Code Symbologies

The Dolphin 7850 image engines support the following bar code symbologies:

Symbology Type	Symbology Name
1D Symbologies	Codabar Code 3 of 9 Code 11 Code 32 Pharmaceutical (PARAF) Code 93 Code 128 EAN with Add-On EAN with Extended Coupon Code EAN-13 GS1 Databar Interleaved 2 or 5 Matrix 2 of 5 Plessey PosiCode Straight 2 of 5 IATA Straight 2 of 5 Industrial Telepen Trioptic Code UCC/EAN-128 UPC and UPC-A
2D Symbologies	Aztec Code 16K Composite Data Matrix GS1 Databar MaxiCode OCR PDF417 QR Code
Composite Codes	Aztec Mesa Codablock F EAN-UCC GS1 Databar-14
OCR	OCR US Money Font, MICR (E 13 B) and SEMI Font OCR-A OCR-B
Postal Codes	Postnet and most international 4 state codes Australian Post British Post Canadian Post China Post Japanese Post KIX (Netherlands) Post Korea Post Planet Code

Activating the Engine

The Dolphin 7850 features a scan trigger on the front of the integrated pistol-grip handle that activates the image engine.

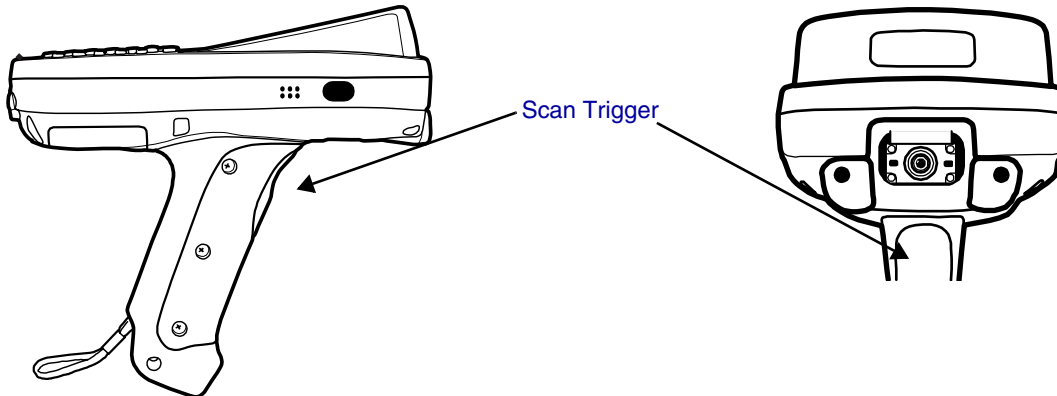

Using Demos

Dolphin Demos are software utilities loaded on all Dolphin terminals that demonstrate the advanced features of the terminal. There are two Demos feature the image engine: Image Demo and Scan Demo.

To access these demos, tap **Start > Demos**,

- Select **Image Demo** to verify imaging, or
- Select **Scan Demo** to verify decoding.

For more information about Demos, refer to the Dolphin Demos User's Guide, which is available for download from www.handheld.com.

LEDs

The LEDs in the center of both keyboards (for location, see [LEDs](#) on page 4-1) light when using the image engine.

- Scan LED** The LED on the right lights red when you press the scan trigger in scanning applications.
- Decode LED** The LED on the left lights green when a scanned bar code is successfully decoded.

Decoding

The Dolphin terminal supports two types of image decoding: full-area imaging and Advanced Linear Decoding (ALD).

Full-area Imaging

Full-area imaging means that the Dolphin terminal support omni-directional aiming, which means that a positive read can be obtained from many positions. For details, see [Omni-Directional Scanning Positions](#) on page 5-4.

ALD

ALD provides fast reading of linear (1D) and stacked linear bar codes (e.g., PDF417). For the best read, the aiming pattern should be centered horizontally across the bar code. When ALD is enabled, the reader does not read matrix or postal codes.

To Decode a Bar Code

1. Tap **Start > Demos > Scan Demo**.
2. Position the Dolphin terminal over one of the sample bar codes on page 5-4. A range of 4–10 inches (10–25 cm) from the bar code is recommended.
3. Project the aiming pattern by pressing and holding the Scan trigger. The Scan LED lights red.
4. Center the aiming beam over the bar code. The aiming beam should be oriented in line with the bar code to achieve optimal decoding; see [Omni-Directional Scanning Positions](#) on page 5-4.
5. Release the Scan trigger.
6. When the bar code is successfully decoded, the decode LED lights green and the terminal beeps.

Sample Bar Codes

You can use the following bar codes to verify decoding:

Sample 128

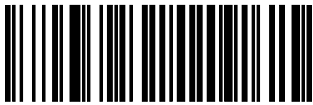

Code 128

Sample PDF417



PDF417 Test Message

Omni-Directional Scanning Positions

The high-vis aiming pattern frames the bar code to provide you with the best scanning performance.

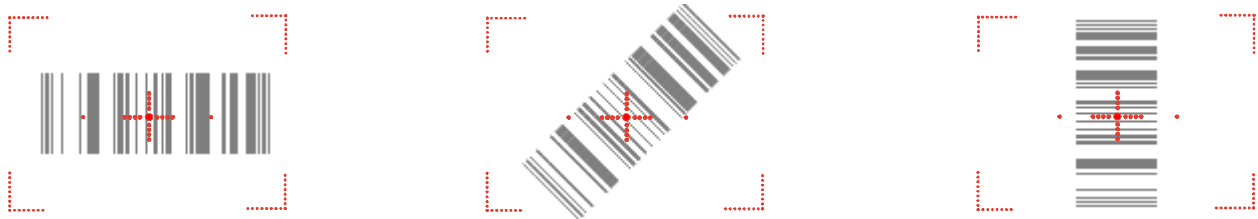

Note: To achieve the best read, the aiming beam should be centered horizontally across the bar code.

The aiming pattern is smaller when the terminal is held closer to the code and larger when the terminal is held farther from the code. Symbologies with smaller bars or elements (mil size) should be read closer to the unit whereas larger bars or elements (mil size) should be read farther from the unit.

Laser Engines

Laser engines do **not** support omni-directional scanning. To achieve an optimal scan, center the red aiming beam across the bar code horizontally as shown.



Capturing Images

The image-capture process is an intuitive, split-second operation for experienced users. By following basic guidelines, however, new users can easily develop their own technique and, with practice, quickly learn to adapt to different application environments.

Image Preview

When the imaging process is initiated, the screen displays a preview of the object. This is a live video image of what the imager is currently viewing and has a slightly degraded appearance compared to the captured image. This slight degradation is normal; the captured image has a higher resolution.

File Formats

The Dolphin terminal is capable of saving images in a number of industry-standard file formats such as *.bmp, *.jpg and *.png. The default file format for images is a grayscale *.jpg. To obtain the highest quality images, take grayscale images.

File Size

Digital images have a maximum image size of 640 x 480 pixels and an image definition up to a 256 grayscale. The image quality and related file size are determined by the data compression method used by the software application used to take the image. The average size of the image file is approximately 4–8K. However, the size of the image depends on image content; the more complex the content, the larger the file size.

Taking an Image

1. Tap **Start > Demos > Image Demo**.
2. Point the Dolphin 7850 terminal at the object.
3. Press the scan trigger to activate the engine. The screen displays a preview of the object.
4. Adjust the terminal's position until the preview on the screen appears as you want it to appear in the image.
5. Hold the terminal still and release the Scan trigger. The screen flashes and the captured image appears on the screen.
6. By default, the image is saved to the My Device folder (**Start > Programs > File Explorer > My Device**). To save the image to another location, tap **File > Save As**.

High-Vis Aiming Pattern

If your Dolphin terminal is configured with an 5300 imager, you can enable the aiming pattern for imaging in the Image Demo application. For details about the aiming pattern, see [Omni-Directional Scanning Positions](#) on page 5-4.

1. Tap **Start > Demos > Imaging Demo > Options** menu > **Aimer**.
2. The aiming pattern is now enabled for imaging.

Uploading Images

Image files can be transmitted to a host workstation via

- Microsoft ActiveSync and a Dolphin communication peripheral, or
- Over your wireless radio network.



Overview

Customizable settings are available from the Start menu. Tap **Start > Settings** and the Settings screen opens displaying the Personal tab. Settings consists of three tabs: Personal, System, and Connections.

Personal Tab

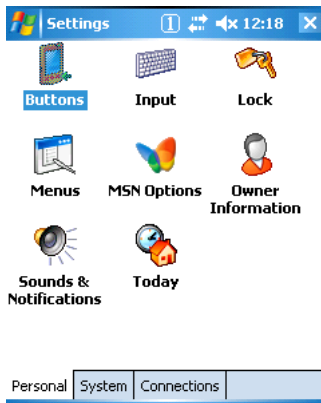

System Tab

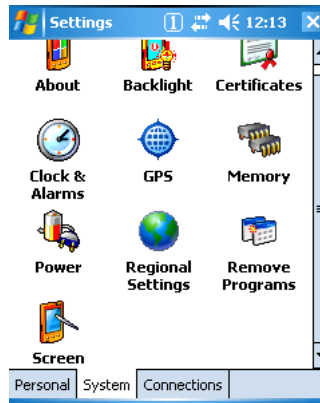

Connections Tab

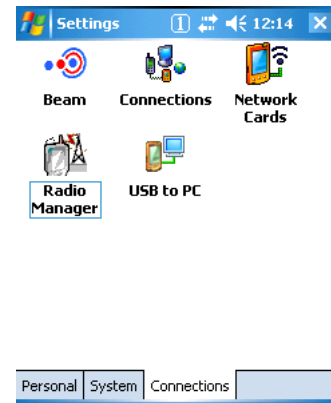

Tab	Description
Personal	The Personal tab provides access to personal configuration programs. For details, see Personal Settings on page 6-2.
System	The Systems tab provides action to programs that monitor and adjust major system functions. For details, see System Settings on page 6-7.
Connections	The Connections tab provides access to most of the terminal's communication options. For details, see the Connections Tab (see page 7-6) in the Communication chapter.

Personal Settings

To access the Personal tab, go to **Start > Settings**. The screen opens displaying the Personal tab.



Icon	Description
Buttons	Programs hardware buttons to launch applications or execute commands; see Buttons on page 6-3.
Input	Customizes the SIP. For details, see Input Panel Options on page 6-4.
Lock	Provides password protection for certain programs on the terminal.
Menus	Customizes what appears on the Start and New menus; see Menus - Modifying the Start Menu on page 6-4.
Owner Information	Stores your contact information. This information will appear on the Today screen.
Sounds & Notifications	Sets the sound volume, enables and disables sounds for specific actions, and sets sound parameters for system notifications.
Today	Customizes the look and the information that is displayed on the Today screen.

Note: Personal settings are stored in RAM memory and are replaced by system defaults after each hard reset. For more information about resets, see [Resetting the Terminal](#) on page 3-13.

Buttons

The Buttons setting programs keyboard buttons to launch applications or execute commands. The default button assignments that appear on the Buttons window are inactive until you enable the HotKeys Power Tool.

You must enable the HotKeys Power Tool to activate the button assignments in the Buttons setting.

1. Tap **Start > Power Tools**.



2. Tap the **HotKeys** icon **once** HotKeys.
3. HotKeys is enabled and the button assignments in the Buttons setting are active.
4. Verify the button assignment by tapping the button on the keyboard.

For more information about HotKeys, refer to the Dolphin Power Tools User's Guide, which is available for download from www.handheld.com.

Changing Button Assignments

1. After HotKeys is enabled, tap **Start > Settings > Personal tab > Buttons**.

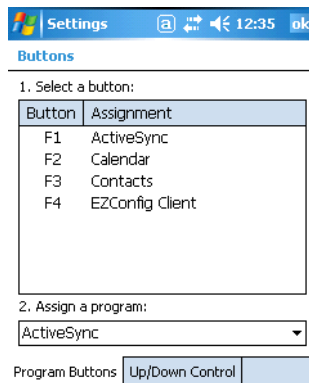

Note: The buttons that appear on this window are the only buttons that can be programmed via the Buttons setting. You cannot add hardware buttons to this window.

2. Tap on the name of the application in the **Assignment** column and select a program or command in the **Assign a program** drop down list.
3. Tap **OK** to save.

Available Programs

The **Assign a program** list contains the applications installed on the terminal. If there is a program installed that you would like to see in this list, paste a Shortcut to the program in the `\\Windows\Start Menu\Programs` folder.

For instructions about creating shortcuts, see [Using File Explorer](#) on page 6-5.

Commands

The **Assign a program** list also contains the following commands:

Command	Description
<Input Panel>	Opens the soft input panel.
<None>	Nothing happens when the button is pressed.
<OK/Close>	Performs the same function as tapping OK on the screen.

Command	Description
<Scroll Down>	Scrolls down in the open application.
<Scroll Left>	Scrolls left in the open application.
<Scroll Right>	Scrolls right in the open application.
<Scroll Up>	Scrolls up in the open application.
<Start Menu>	Opens the Start menu.
<Today>	Opens the Today screen.

Input Panel Options

You can set input options by going to **Start > Settings > Personal tab > Input**. The following graphics are the tab windows where you can customize the SIP (soft input panel) to your preferences:

Input tab

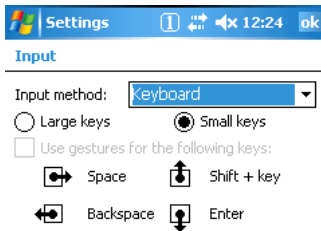

Word Completion tab

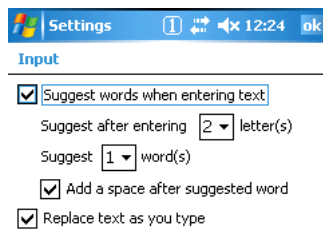

Options tab

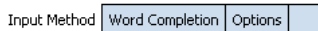
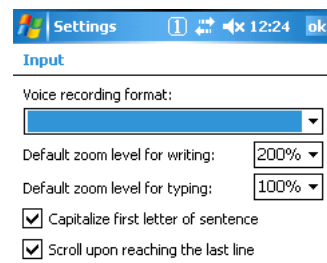

Menus - Modifying the Start Menu

You can add existing programs you use often, such as File Explorer, to the Start menu for faster access. You are not installing the program, just enabling the user to access the program from the Start menu.

You can add a program to the Start Menu three ways: directly by using the Menus setting, or creating and pasting shortcuts in File Explorer on the terminal or the workstation (and using ActiveSync to transfer to the shortcut to the terminal).

Note: Only seven applications total are allowed on the Start menu.

Using the Menu System Setting

1. Tap **Start > Settings > Personal tab > Menus > Start Menu** tab.



2. Tap the check box for the program you want to add and tap **OK** to save.

3. Tap the **Start** menu to verify that the program appears on it.

Using File Explorer

If you do not see the program listed, you can either use File Explorer to move the program or ActiveSync on the desktop computer to create a shortcut to the program and place the shortcut in the Start Menu folder.

Note: We recommend that you Copy and Paste Shortcut so that you do not alter your program configurations by accident. Using Copy and Paste Shortcut (as opposed to Cut/Copy and Paste) ensures that the program files remain where they need to be for the system to find them to perform system functions.

1. Tap **Start > Programs > File Explorer**, and navigate to the program.
File Explorer opens to My Documents by default; to see a list of all folders, tap the folder name and then **My Device**.

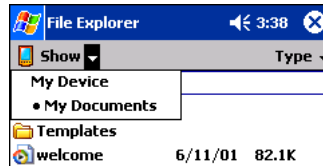

2. In File Explorer, navigate to the \Program Files folder. Tap and hold on a program, then select **Copy** on the pop-up menu.

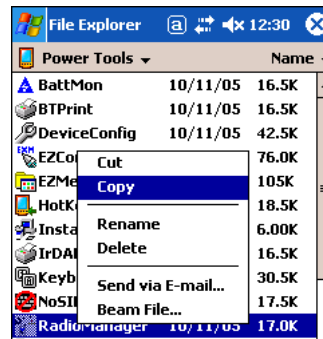

3. Navigate to the Windows folder and open the Start Menu folder (My Device > Windows > Start Menu), tap and hold a blank area of the window, and tap **Paste Shortcut** on the pop-up menu.

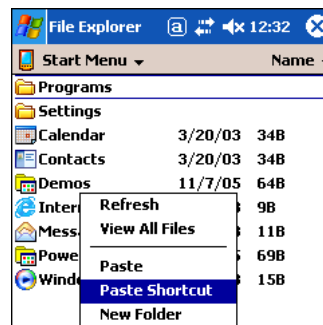

-
4. The shortcut is now in the folder.

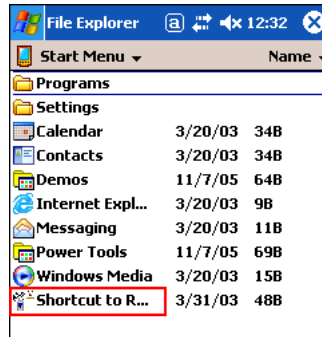

5. Tap the **Start** menu to verify that the program now appears on it.

Using Windows Explorer

Here, you are performing the same basic process as on the terminal, except that you are using the Explore utility in ActiveSync (Windows Explorer) to copy and paste the shortcut from the workstation to the terminal. For more details using Explore in ActiveSync, see [Exploring the Terminal from the Workstation](#) on page 7-4.

1. Using a Dolphin peripheral, connect the terminal to the workstation via ActiveSync.
2. On the workstation, when ActiveSync opens after connecting, tap **Explore**. Windows Explorer opens to the files on the terminal.
3. Navigate to the program.
4. Right-click on the program and select **Create Shortcut**.
5. Select the shortcut, right-click, and select **Cut**.
6. Navigate to the **Start Menu** folder (Windows > Start Menu).
7. Right-click on an empty area and select **Paste Shortcut**.
8. On the terminal, tap the **Start** menu and verify that program appears.

System Settings

The System tab enables you to verify and sometimes alter system parameters. To access the System tab, go to **Start > Settings > System** tab.

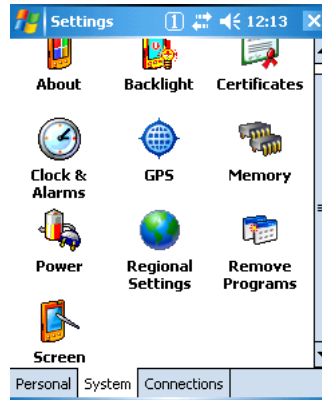

About

The About system setting displays specific information about what is loaded on the terminal on three tab windows:

Tab	Description
Version Tab	Displays the information about the software, operating system, and processor of the terminal. The processor for the Dolphin 7850 is an Intel XScale PXA 270 520MHz processor.
Device ID Tab	Displays the information the terminal uses to identify itself to other devices. It is important to know this information to identify the terminal when connecting to the network. Device name: Displays the system's default name. This is the name used by ActiveSync. Description: Displays the description of the device ID.
Copyrights Tab	Displays important copyright information.

Backlight

The backlight for the color display is user-defined.

Tap **Start > Settings > System** tab > **Backlight**. There are two tabs: **Battery** and **External**; the options on each tab are the same.

The Battery tab determines display backlight settings when the terminal is running on battery power.

The External tab determines display backlight settings when the terminal is powered by an external source, such as a Hand Held Products cable.

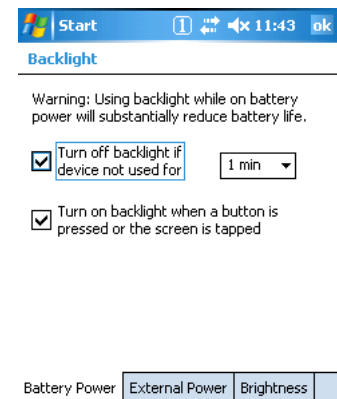

Brightness Tab

The Brightness tab determines the brightness of the display backlight when it's on.

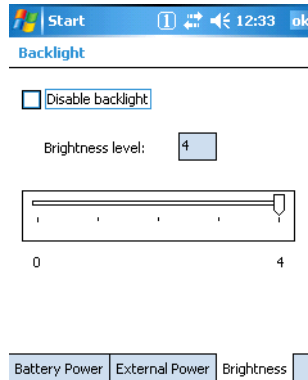

To disable the backlight, check **Disable backlight**. Tap **OK** to save all changes.

Certificates

Certificates shows you the network certificates recognized by the operating system. There are personal and root certificates; each has its own tab.

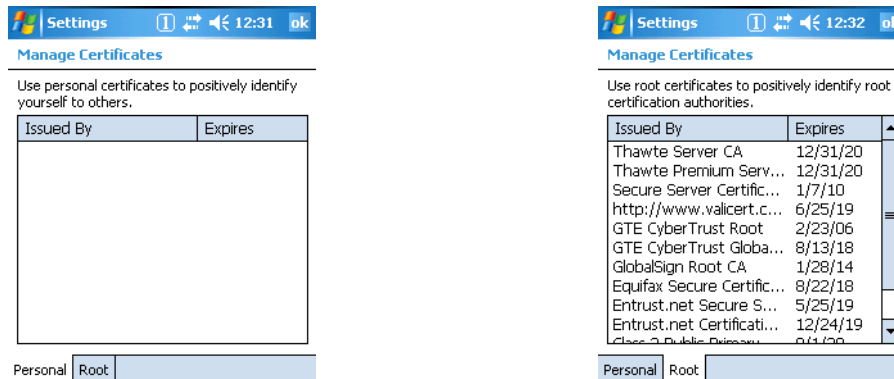

It is important to verify that the operating system acknowledges your certificate. If the certificate does not appear on one of these tabs, the operating system does not see it, and it will not function properly during the network authentication process.

For more information, see [Certificates](#) on page 8-12.

Clock & Alarms

Clock & Alarms sets the system clock. Appointments, scheduled events, and any function on a schedule runs off this setting. You need to set the time and date after each hard reset. You can also access this setting by tapping the date on the Today screen.



GPS Settings

GPS Settings is a Microsoft GPS tool.

Memory

Dolphin terminals have two types of memory: volatile and non-volatile. Data stored in volatile memory does not persist through cold boots (see [Hard Reset \(Cold Boot\)](#) on page 3-13) whereas data stored in non-volatile memory does persist through cold boots. Each type of memory has its own options.

Volatile

Data stored in volatile memory does not persist through cold boots. The Dolphin 7850 terminal has 64MB of volatile memory by default. Volatile memory is used for running and storing programs as well as storing program data and is also known as RAM memory.

Non-Volatile

Data stored in non-volatile Flash memory does persist through cold boots. The Dolphin 7850 terminal can have 64MB or 128MB of non-volatile memory.

IPSM

Short for Internal Persistent Storage Manager, IPSM is the on-board Flash memory. Because this memory is non-volatile, data and programs stored in IPSM are not affected when power is removed or a cold boot launched. For this reason, default programs and files for Dolphin terminals such as Autoinstall are stored in IPSM.

Secure Digital (SD) Card Hand Held Products offers 64MB, 128MB, and 256MB SD cards that can be installed at the factory. The SD memory interface is not user-accessible or field-replaceable.

Use the Memory system setting to check memory usage after you receive warning messages about memory. There are three tabs: Main, Storage Card, and Running Programs.

Main Tab

This tab displays current capacity and usage of the 64MB or 128MB of on-board, volatile memory.

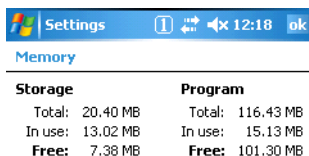

The screenshot shows the 'Memory' settings screen. At the top, there is a status bar with 'Settings', a help icon, a back arrow, a speaker icon, the time '12:18', and an 'ok' button. Below the status bar, the title 'Memory' is displayed. The screen is divided into two columns: 'Storage' and 'Program'. Under 'Storage', the values are: Total: 20.40 MB, In use: 13.02 MB, and Free: 7.38 MB. Under 'Program', the values are: Total: 116.43 MB, In use: 15.13 MB, and Free: 101.30 MB.

Storage	Program
Total: 20.40 MB	Total: 116.43 MB
In use: 13.02 MB	In use: 15.13 MB
Free: 7.38 MB	Free: 101.30 MB

Main Storage Card Running Programs

Field	Description
Columns	Storage: The part of RAM memory used for storing programs and program data. Program: The part of RAM memory used to run programs.
Total	Displays the current MB of memory allocated for Storage and Program use.
In use	Displays the total MB of that allocated memory being used in Storage and Program memory functions.
Free	Displays the total MB of memory available for Storage and Programs use.

Storage Card Tab

This tab displays the current capacity and usage statistics of the selected memory type: IPSM or Storage Card. Select the memory type from the drop-down list. **IPSM** is selected by default.

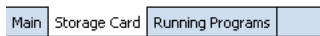
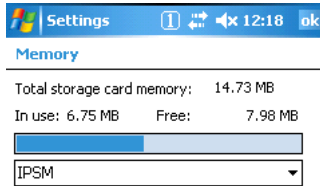

Field	Description
Total storage card...	The total MB of memory capacity of the selected memory.
In use	The MB currently being used.
Free	The MB that is still available for use.
Drop-down list	<p>IPSM—When IPSM is selected in the drop-down list, the Storage Card tab displays the IPSM memory capacity and usage statistics.</p> <p>Storage Card—If a storage card is installed in the terminal, a Storage Card entry appears in the drop-down list. Select it to see the current capacity and usage statistics of the installed storage card.</p>

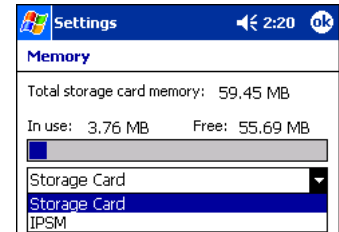

Running Programs Tab

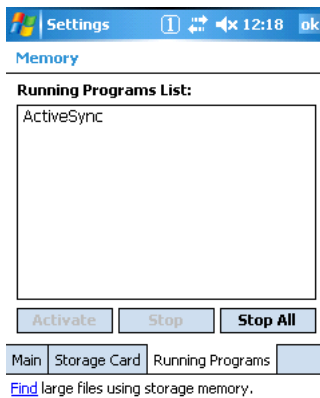

This tab displays the running software programs using storage memory. Check this tab when you are receiving out of memory errors or when the mobile computer is running slowly. Select a program in the list and tap **Stop** to stop it from running (and therefore from using memory). Tap **Stop All** to automatically stop all running programs.



Anytime you stop a running program, it frees up volatile memory. Be advised that, when you stop a program here, any unsaved data in that program is lost. To free up memory without risking data loss, return to the running program, save your data, and close the application.

Find Link

Find searches for large files using storage memory. Clicking Find opens the Search program with **Larger than 64KB** already selected in the **Type** field. Enter the search criteria and tap **Search**.

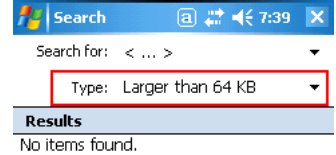

Power

Battery Tab

Displays battery charging information.

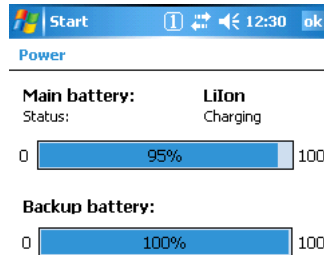

For more information about the terminal's batteries, see [Battery Power](#) on page 3-9.

Advanced Tab

Determines the amount of time that elapses before the terminal automatically goes into suspend mode; see [Suspend Mode](#) on page 3-13. You have the option of selecting time periods for both battery and external power.

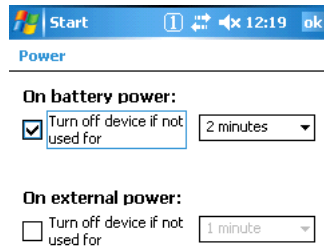

Field	Description
On battery power	Select the number of minutes of inactivity you want to pass before the terminal goes into suspend mode when running on battery power.
On external power	Select the number of minutes of inactivity you want to pass before the terminal goes into suspend mode when running on external power.

Regional Settings

Regional Settings enables you to customize the appearance and formatting to your geographic region. Specifically, you can customize numbers (i.e., number of decimal places allowed), currency (i.e., using the \$ or € symbol), time, and date. These specifications apply to all screens, including the Today screen. The Region tab displays an overview of the region selected in the drop-down list at the top. The terminal is loaded with a number of pre-programmed regional settings. Select one from the list. The results appear on the screen.

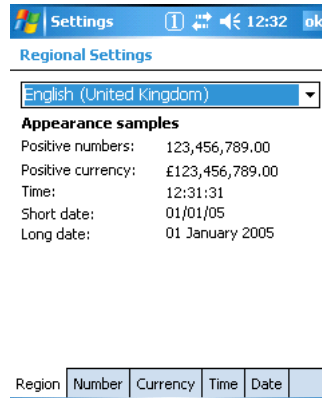

To see specific settings or change a specific setting, tap on one of the tabs, make the change and tap **OK** to save it. You need to show reboot the terminal for the changes take effect.

Remove Programs

The Remove Programs settings enables you to remove programs installed on the terminal. Use this setting to troubleshoot when you receive messages that the device is out of memory. The programs removed in the Remove Programs setting are removed from volatile memory.

1. Tap **Remove Programs**. In the list, select the program you want to remove.

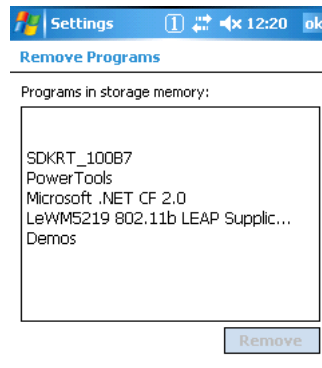

2. Tap **Remove**. The following message appears:

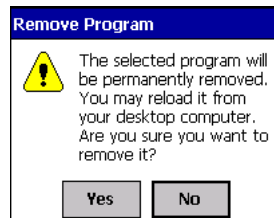

3. Tap **Yes**. Wait while the program is removed.
4. Verify that the program no longer appears in the list and the total storage memory adjusts.

Total storage memory available—The available memory adjusts automatically when a program is removed; see [Memory](#) on page 6-9.

Screen

Note: By default, dynamic screen rotation (i.e., the ability to switch between landscape and portrait orientation) is disabled on Dolphin 7850 terminals.

Alignment Tab

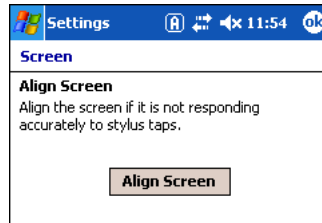

Tap **Align Screen** to re-align the screen. Remember, you first align the screen at bootup. You would need to re-align the screen again if tapping buttons or icons with the stylus no longer seems to work appropriately.

ClearType Tab

Dolphin terminals support ClearType font rendering. ClearType is a Microsoft technology that dramatically increases the readability of text on LCD displays.

To enable ClearType font rendering, select **Enable ClearType** and tap **OK**.

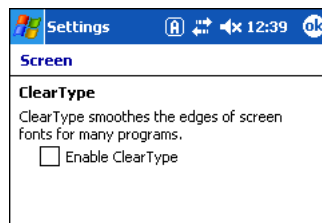

For more information about ClearType font rendering, visit: www.microsoft.com/typography/cleartype/what.htm?fname=%20&fsize=

Text Size Tab

Adjusts font scaling within certain views of the Today screen, Contacts, Calendar, Messaging, and Tasks. This means that you can increase or decrease the point size of the font on application windows.

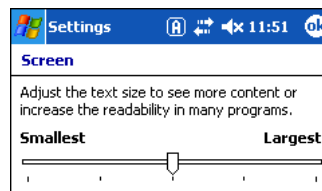

This is the default font size setting. To change the font size, move the slider toward **Smallest** or **Largest**. The Example text changes to reflect the font change. Tap **OK** to save the new font size setting.

Default Font Size

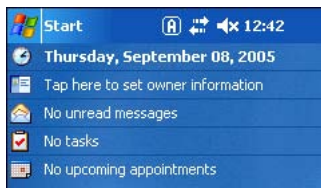

Largest Font Size

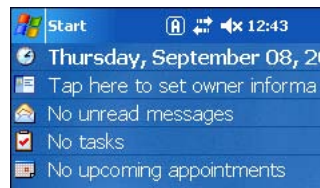

Communication Options

Dolphin terminals offer several communication options including Microsoft ActiveSync, infrared, and wireless radios.

Mechanical Connector

The mechanical connector on the bottom panel (for the exact location, see [Mechanical Connector](#) on page 3-8) connects the terminal to a series of Dolphin peripherals, which connect to a host workstation via USB (1.1 or higher). When the terminal is connected to a host workstation in this way, you can use ActiveSync to communicate between the host and the terminal.

For more information about communicating with ActiveSync, see [Using ActiveSync](#) on page 7-3.

IrDA Port

The IrDA port enables the Dolphin 7850 to transmit data via pulses of infrared light to and from other IrDA-compliant devices, such as printers, PCs, and even other Dolphin terminals.

For more information about communicating via the IrDA port, see [Using Infrared Communication](#) on page 7-8.

Wireless Radios

Dolphin 7850 terminals can be equipped with an 802.11g and/or Bluetooth radio. When the terminal's radios are enabled, you can connect the terminal to a wireless network for communication.

For more information about enabling the radios, see [Radio Manager](#) on page 7-13.

Software Communication Programs

Dolphin terminals are shipped with the following communication software programs installed.

Microsoft ActiveSync v4.1 or Higher

Microsoft ActiveSync is a tool that enables mobile computing devices to exchange and synchronize application data with a desktop computer. For more information, see [Using ActiveSync](#) on page 7-3.

Remote Access Services (RAS)

RAS is a feature built into Windows NT that enables users to log into an NT-based LAN using a modem, X.25 connection or WAN link. RAS is fully supported and allows the use of Point-to-Point Protocol (PPP) or Serial Line IP (SLIP) connections for network connectivity.

To establish a RAS connection, enable the terminal's radio(s) in the [Radio Manager](#) (see page 7-13), set the terminal up on a wireless network, then activate the RASMan Power Tool by tapping **Start > Power Tools > RASMan**.

For more information about Power Tools, refer to the Dolphin Power Tools User's Guide, which is available for download from www.handheld.com.

Default Com Port Assignments

The Dolphin terminal ships with the com ports assigned as follows:

Com Port	Assignment
1	Serial port; this is the 17-pin mechanical connector on the bottom panel. See Mechanical Connector on page 3-8.
2	Bluetooth Module If there is no Bluetooth hardware installed on the terminal, this com port is unassigned.
3	Raw Infrared
4	Unassigned
5	USB virtual serial port
6	IrDA, if IrDA is enabled. If IrDA is disabled, this com port becomes available.
7, 8, & 9	Unassigned These are virtual com ports that are available for selection only when connecting to devices that use virtual com ports, such as Bluetooth.

Installing Additional Software

Dolphin terminals ship with the operating system, radio drivers, and custom Hand Held Products software loaded onto the device. These are the default programs that install when your terminal first boots up. You can install additional software programs to the terminal provided that the following parameters are met:

- The software program was created for a Windows Mobile device.
- The terminal has enough memory to store and run the program.
- The program has an *.exe, *.cab, or *.dll extension.

The most popular place to find software on the Windows Mobile website: www.microsoft.com/windowsmobile/products/pocketpc/



When selecting programs, verify that the program and version of the program are designed for the Windows Mobile 5.0 and the terminal's processor. You can verify your processor by tapping Start > Settings > System tab > About > Version tab. Make a note of the information in the Processor field.

To install additional software, you can use the communication options described in this chapter.

See,

- [Adding Programs via ActiveSync](#), page 7-4.
- [Adding Programs From the Internet](#), page 7-7.
- [Adding Programs via Infrared](#), page 7-9.

Using ActiveSync

ActiveSync communication happens through the mechanical connector on the bottom panel (see [Mechanical Connector](#) on page 3-8) when the terminal is connected to a Dolphin communication peripheral such as the Dolphin HomeBase or a Dolphin Charge/Communication cable.

Hardware Requirements

- Dolphin HomeBase or Dolphin communication cable: USB or RS-232
- Power Adapter Cable from Hand Held Products

Software Requirements

To synchronize, ActiveSync 4.1 or higher must be installed and configured for the appropriate communication type on the host workstation and the Dolphin terminal. Dolphin terminals ship with ActiveSync already installed. Therefore, if ActiveSync is already installed on the host workstation, you just need to connect the Dolphin terminal to the host workstation (via Dolphin peripheral) to initiate communication.

If ActiveSync 4.1 or higher is not installed on the host workstation, install it from the Microsoft Companion CD that came with the Dolphin terminal. Insert the CD into the CD-ROM drive of the host workstation and click the **yellow arrow**, then **Start Here**, and follow the directions on your screen. You can also download the most current version of ActiveSync from www.microsoft.com and install.

The host workstation must have Windows 98 Second Edition*, Windows Me, Windows 2000, or Windows XP installed.

*Note: The HomeBase does not support Windows NT when using a USB connection because Windows NT does not support USB.
Windows 98 Second Edition provides full USB support.

Setting Up the Host Workstation

To sync successfully, ActiveSync must be configured for same communication type on the host workstation and the Dolphin terminal. ActiveSync must be setup on your desktop computer *before* you initiate synchronization from the terminal for the first time.

Verify that ActiveSync on the host workstation has selected the appropriate communication type by opening ActiveSync and clicking **File > Connection Settings**.

For USB communication, check **Allow USB connections**.

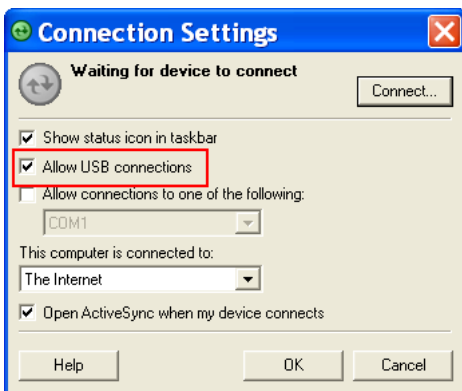

For RS-232 communication, connect to **COM1**.



Note: You can have both USB and RS-232 selected in the software without affecting processing. However, your hardware setup should use only RS-232 or USB, not both.

Setting Up the Terminal

 *When communicating via ActiveSync, your terminal must be connected to the host workstation with a communication peripheral sold/manufactured by Hand Held Products, such as the Dolphin HomeBase or Dolphin Charge/Communication cable. Use of any peripheral not sold/manufactured by Hand Held Products may damage your terminal and will void the warranty.*

You need to connect the Dolphin peripheral to the host workstation, then connect the Dolphin terminal to the peripheral. ActiveSync should attempt to connect automatically and self-configure to RS-232 or USB. Dolphin terminals default to USB communication.

Verify the connection setting on the Dolphin terminal by tapping **Start > Programs > ActiveSync > Menu > Connections**.

USB The default workstation synchronization value for USB communication is **'USB Connection.**
RS-232 The default workstation synchronization value for RS-232 communication **'115200 Default.**

Synchronizing with the Host Workstation

After setup, synchronization begins automatically whenever the terminal's mechanical connector connects to a Dolphin peripheral that is connected to a host workstation with ActiveSync installed.

Note: If you have a wireless LAN card, you can also synchronize remotely.

Exploring the Terminal from the Workstation

When the terminal and desktop computer are connected, open the main ActiveSync window (on the desktop), and click **Explore**.

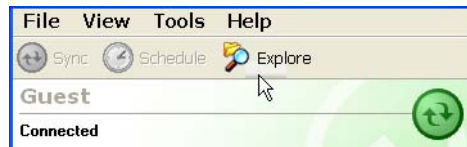

The Mobile Device folder opens in Windows Explorer.

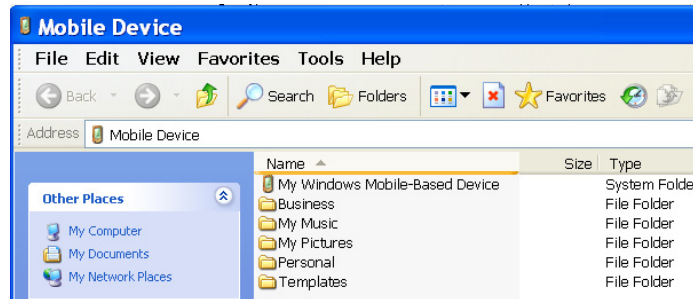

The Dolphin terminal is now treated as a mass storage device, and transferring files is as simple as dragging and dropping or copying and pasting as you would for moving files between folders on your hard drive.

Adding Programs via ActiveSync



When selecting programs, verify that the program and version of the program are designed for Windows Mobile 5.0 and your processor. You can verify your processor by tapping Start > Settings > System tab > About > Version tab. Make a note of the information in the Processor field.

Generally, software for Windows Mobile devices must be installed to the host workstation first, then transferred to the Dolphin terminal.

1. Download the program to the workstation from either the Internet or the installation CD. You may see a single *.exe or setup.exe file, a *.cab file, or *.dll. (There may also be several versions of files for different device types and processors.)
2. Read any installation instructions provided by the program, such as Read Me files or other documentation. Many programs provide special installation instructions.
3. Connect the terminal to the workstation via Hand Held Products communication peripheral.
4. Confirm that ActiveSync activates.

If the Program File is Self-Extracting

This type of program installs to the workstation and the terminal simultaneously; one process installs to both devices.

1. On the workstation, double-click the *.exe or *.setup.exe file. The installation wizard begins.
2. Follow the directions on the workstation screen. The installation process includes transferring the software to the terminal via ActiveSync.

If the Program File is Not Self-Extracting

Some programs cannot be installed on workstations because they are designed exclusively for Windows Mobile devices. In these cases, the appropriate files must be stored on the host workstation and transferred to the terminal via ActiveSync Explore.

Note: You know that the program is not an installer because an error message stating that the program is valid but designed for a different type of computer appears when you try to install the program on the workstation.

1. If you cannot find any installation instructions for the program in the Read Me file or documentation, open **ActiveSync** and click **Explore**.
2. Navigate to the **My Windows Mobile-Based Device** folder and copy the program file or files to the **Program Files** folder on the terminal. If you want the program to be part of the Autoinstall that occurs after every hard reset, place the program file in the **Autoinstall** folder (`\\IPSM\AutoInstall`).
3. On the terminal, tap **Start > Programs > File Explorer** and navigate to the folder where the program is located.
4. Tap on the program file to install it.
If you copied the file to the **Autoinstall** folder, you can also choose to install the program by performing a hard reset. The program installs as part of initialization.
5. After installation is complete, access the program by tapping **Start > Programs** and the program appears on the Programs screen. Tap the icon to open the program.

For Additional Help

You can find more information on the host workstation by clicking **Help > Microsoft ActiveSync Help**.

You can find more information on the terminal by tapping **Start > Programs > Help > ActiveSync**.



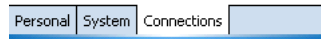
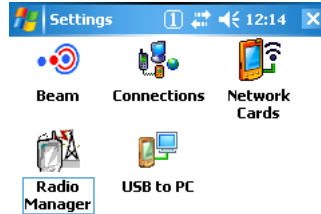

For more information, go to the Windows Mobile software website at: www.microsoft.com/windowsmobile/products/pocketpc/

Connections Tab

The Connections Tab of Windows Mobile Settings provides access to the configuration settings for many of the terminal's communication options. Tap **Start > Settings > Connections** tab.



Note: The programs that appear on the Connections tab depend on the terminal's radio configuration.

Program	Icon	Description
Beam	 Beam	Controls infrared communication. See Using Infrared Communication on page 7-8.
Connections	 Connections	Accesses Microsoft's connection manager to set up modem connections. See Connections Manager on page 7-10.
Network Cards	 Network Cards	Opens Microsoft's Network Adapters tool. See Network Cards on page 7-12.
Radio Manager	 Radio Manager	Enables and disables installed radio drivers. See Radio Manager on page 7-13.
USB to PC	 USB to PC	Toggles the terminal between RNDIS USB and Serial USB communication. Dolphin terminals default to Serial USB. see USB to PC on page 7-14.

Connecting the Terminal to a Wireless Network

Establishing the terminal on a wireless network depends heavily on your network infrastructure. You will need specific information from your network administrator.

Whatever your network specifics, some general steps apply:

1. The on-board radio drivers must be enabled for the terminal to transmit a signal. Verify the radio's status in the [Radio Manager](#) (see page 7-13).
2. Enter the appropriate configuration settings for each radio installed. Each radio has its own configuration program.
 - For details about the 802.11g radio, see [Wireless LAN Communication with 802.11g](#) on page 8-1.
 - For details about Bluetooth radio, see [Wireless PAN Communication with Bluetooth](#) on page 9-1.

Connecting the Terminal to an ISP

This method uses an external modem rather than a wireless radio. For instructions, see [Proxy Server Connections](#) on page 7-10.

Adding Programs From the Internet

When you have established a network connection (via modem or wireless radio), you can access the Internet and download additional software programs.



When selecting programs, verify that the program and version of the program are designed for the Windows Mobile 5.0 and the terminal's processor.

1. Verify the terminal's processor by tapping **Start > Settings > System** tab > **About > Version** tab. Make a note of the information in the **Processor** field.
2. Open Pocket Internet Explorer and navigate to the program's location. You may see a single *.exe or setup.exe file, or several versions of files for different device types and processors.
3. Select the program version that matches the terminal and processor.
4. Read any installation instructions provided by the program, such as Read Me files or other documentation. Many programs provide special installation instructions.
5. Download the program to the terminal straight from the Internet.
You would normally store the program in the **\Program Files** folder unless another location is required by the program.
6. On the terminal, tap the installer file, often an *.exe file.
7. The installation wizard for the program begins.
8. Follow the directions on the screen to complete installation.

Using Infrared Communication

The IrDA port sends and receives data between the terminal and other devices equipped with infrared. The maximum data transfer speed is 115 Kbps with a duty cycle of 18.75%.

IrDA Port Location

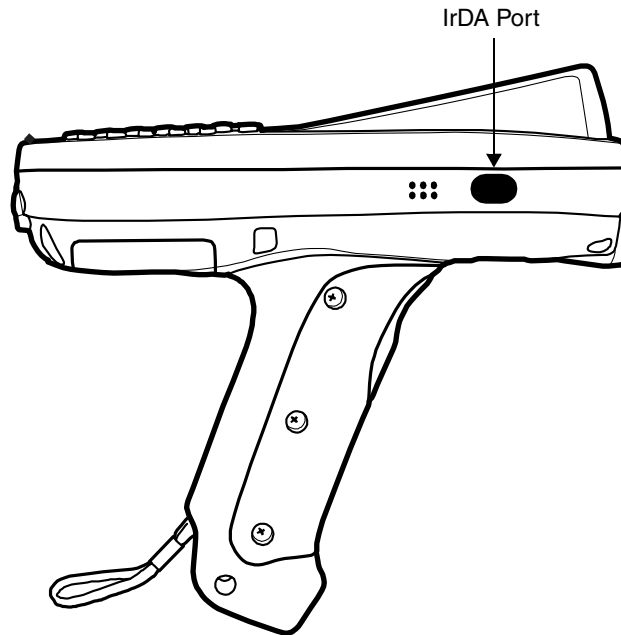

Verify Beam Settings

By default, the IrDA port is enabled after each hard reset. This means that the IrDA port is ready to send and receive data via infrared. Tap **Start > Settings > Connections** tab > **Beam**.

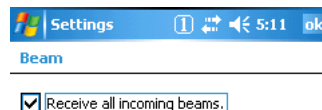

Receive all incoming beams... must be checked for the terminal to receive infrared data from another device.

Sending Data

You can send and receive information via infrared, including software programs (.exe files).

To send or receive, the IrDA ports of both devices must be aligned with each other and within a close range. The maximum data-transfer speed is 115 Kbps.

1. Align the IrDA ports of both devices. (When sending data from one Dolphin terminal to another, position both terminals so that the IrDA ports are facing each other directly.)
2. Open the program where you created the item you want to send and locate the item in the list. You can beam files, but not folders, from File Explorer.

-
3. Tap and hold the item and select **Beam File**.

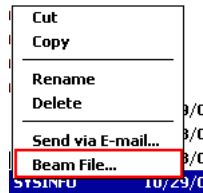

4. The information begins transmitting to the other infrared device.

Receiving Data

1. Verify that the terminal is set to receive all incoming beams; see [Verify Beam Settings](#) on page 7-8.
2. Align the IrDA ports.
3. Have the owner of the other device send the information to you via infrared.
4. Your terminal automatically begins receiving it.

Adding Programs via Infrared

Select a program on one terminal and beam it to another to load additional software programs to Dolphin terminals.

Troubleshooting

If the Beam Settings are not set to receive or you've aligned two IrDA ports and the terminal is still not receiving, tap **Start > Programs > Infrared Receive**. The terminal searches for the sending device.

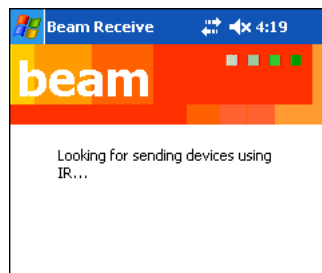

If the terminal cannot find the sending device, the following message appears:

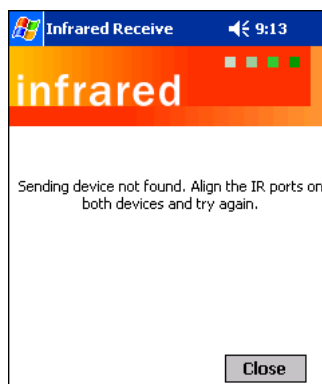

Connections Manager

Microsoft's connection manager sets up various network connections to Internet Service Providers (ISPs) via an external modem. If you are using one of the on-board wireless radios to connect to a network, do **not** enter network parameters in the connections manager. The Dolphin terminal uses the radio's settings to connect to the network.

*Note: All server-assigned IP addresses use Dynamic Host Configuration Protocol (DHCP). The zero-config Wi-Fi feature of Windows Mobile is **disabled** on Dolphin terminals.*

To open the connections manager, tap **Start > Settings > Connections tab > Connections** icon . The connection manager opens displaying the Tasks tab.

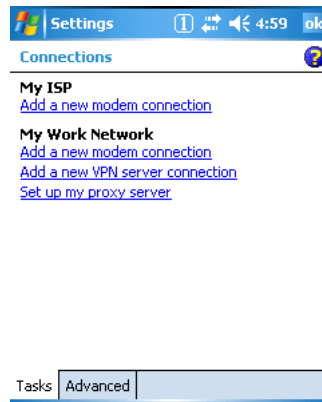

Task Tab

The Task tab enables you to initially configure, then manage network settings when using a modem. Select an item in this list and then complete the setup screens that follow with the appropriate information for your network.

My ISP

The links under this heading enables you to add and manage modem connections to an ISP. To complete the setup screens, obtain the following information from your ISP:

- ISP dial-up access telephone number
- Username
- Password
- TCP/IP settings

My Work Network

These links enable you to establish the following connections types:

- Modem
- Virtual Private Network (VPN)
- Proxy server connection

To complete the setup screens, obtain the network parameters from your system administrator.

Proxy Server Connections

If you are connected to your ISP or private network during synchronization, the terminal should download the proper proxy settings during synchronization with the workstation. If these settings are not on your workstation or need to be changed, ask your ISP or network administrator for the proxy sever name, server type, port, type of Socks protocol used, and your user name and password.

Modify an Existing Connection

Manage Existing Connections appears on the Connections tab after at least one network connection has been established. Tap Manage Existing Connections on this tab and follow the setup screens. You will usually be walked through the same setup screens used to establish the connection.

Advanced Tab

The Advanced tab enables you to select the default network, dialing rules, and IP address exceptions for modem connections.

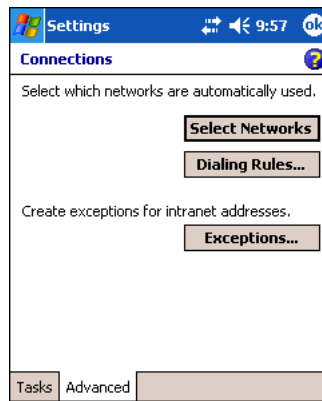

Note: You should not need to change Advanced settings because most ISPs now use DHCP addresses.

Online Help

For more information about modem connection setup, consult the online help on the setup screens by tapping the Help icon .

Network Cards



Network
Cards

The Connections tab (see [Connections Tab](#) on page 7-6) contains a Network Cards icon that displays the network cards installed in the terminal.

1. Tap **Start > Settings > Connections > Network Cards**

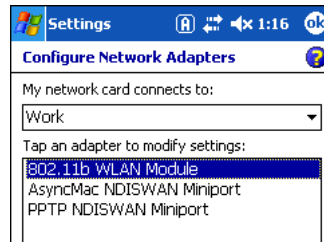

2. Tap on an adapter in the list to review its settings. (Server-assigned IP addresses use DHCP.)

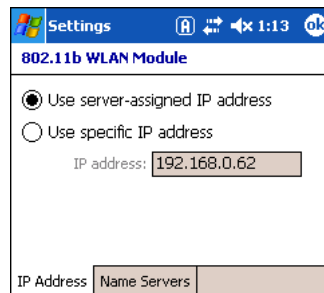

3. If you make a change on one of these tabs, tap **OK** to confirm the changes. The following message appears:

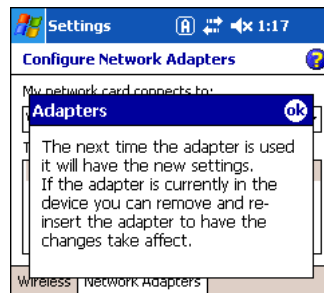

4. You must perform a soft reset to update the registry entries; see [Soft Reset \(Warm Boot\)](#) on page 3-13. During the soft reset, the new registry entries are created and can be read by the applications that need them.



Do NOT perform a *Hard Reset (Cold Boot)* (see page 3-13) after modifying an adapter here. Hard resets return the terminal to factory defaults, which erases network adapter modifications made here.

Radio Manager

The Radio Manager enables and disables the radio drivers installed in the terminal. When a radio is enabled, the radio is transmitting a signal. When disabled, the radio is not transmitting a signal.

At least one radio **must** be enabled before you can set the terminal up on a wireless network. After the radio is enabled, you can enter the appropriate network parameters for your network. If the radio is disabled, the terminal doesn't connect.

Dolphin 7850 terminals are configured with an 802.11g and/or Bluetooth radio.

Radio Driver Installation

For a radio to show up in the Radio Manager, both the hardware module and the software driver for each radio must be installed in the terminal. The radio will appear in the Radio Manager if the module is present but cannot be enabled if the associated driver is not installed as well. All radios and radio drivers are co-located inside the terminal.

Radio drivers (.cab files) are stored in the Autoinstall folder and install during the Autoinstall process after each hard reset (see page 3-13). Only the appropriate drivers for the terminal's radio configuration install. For more information about Autoinstall, refer to the Dolphin Power Tools User's Guide, which is available for download at www.handheld.com.

Enabling the Radios

The terminal enables the 802.11g radio after each hard reset by default. Verify the status of the radio before attempting to establish or change network connection settings.

1. Tap **Start > Settings > Connections tab > Radio Manager**.
The Radio Manager appears identifying that radios and radio combinations that can be enabled.

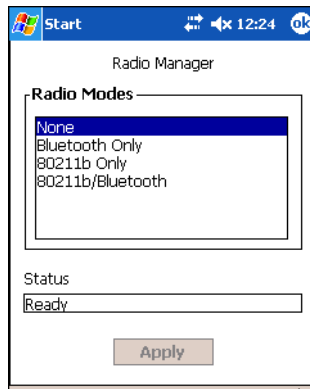

2. Select the radio or radio combination in the list and tap **Apply**. The Radio Manager attempts to enable the radio.
3. When the radio is enabled, the **Status** field reads "Success." If an error occurs during a radio mode change, an error message appears in the Status field and the change is abandoned; see [Radio Manager Window](#) on page 7-13.

Radio Manager Window

Field	Description
Radio Modes	Displays the radio hardware modules currently installed on the terminal.
Status Field	Provides feedback on the state of the radio. The Status field reads "Ready" when the selected radio is enabled and the Radio Manager is ready to receive a command. Otherwise, the Status field displays the following messages when enabling a radio: <ul style="list-style-type: none">• Success=The radio or radio combination has been successfully enabled.• 802.11g error messages=Indicate that the radio could not be enabled.

To Disable a Radio

To power down all radios, select **None** and tap **Apply**. All radios are disabled.

USB to PC

The USB to PC applet enables you to switch between RNDIS (Remote Network Driver Interface Specification) USB and Serial USB communication.

Dolphin 7850 terminals default to Serial USB. Hand Held Products recommends using Serial USB.

To change this setting, tap **Start > Settings > Connections** tab > **USB to PC** . The enable option is not selected, which indicates Serial USB.

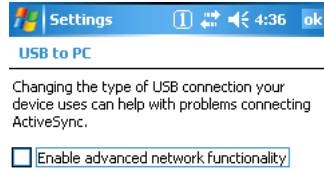

To switch to RNDIS USB, select **Enable advanced network functionality** and tap **OK** to save. (Wait as the terminal makes the change.)

Overview

The Dolphin 7850 has an on-board 2.4 GHz 802.11g WLAN (Wireless Local Area Network) radio that uses Direct Sequence Spread Spectrum (DSSS) technology. The signal is spread continuously over a wide frequency band at a data rate of up to 11 Mbps. The radio is interoperable with other 802.11g Wi-Fi-compliant products including Access Points (APs), PCs via PC card adapters and other wireless portable devices.

Server-Assigned IP Addresses

Please note that all server-assigned IP addresses use Dynamic Host Configuration Protocol (DHCP).

Zero-Config Wi-Fi

Zero-config Wi-Fi feature of Windows Mobile is **disabled** on Dolphin terminals.

Enabling the 802.11g Radio

By default, the 802.11g radio is enabled after each hard reset. To verify that the 802.11g radio is transmitting or to disable the 802.11g, access the [Radio Manager](#) (see page 7-13).

Configuring the 802.11g Radio

The Dolphin 7850 contains the Meetinghouse AEGIS Client[®], a comprehensive IEEE 802.1X tool to set up the on-board 802.11g radio. The Client is a standards-based implementation of IEEE 802.1X and can be configured to work with almost any network equipment—wired or wireless—that supports the 802.1X authentication standard. The Client is interoperable with 802.1X-capable wireless APs and authentication servers including Microsoft's IAS and Cisco's ACS.

The Client uses public key authentication and encryption between Wireless APs (WAP) and roaming stations to exchange dynamic Wired Equivalent Privacy (WEP) keys. In addition, network managers can control 802.1X user profiles from a centralized RADIUS server or, in the case of TTLS, from a RADIUS Diameter or other AAA servers. The Client supports both wireless (802.11a/b/g) and ethernet interfaces.

Supported Protocols

Authentication

The Client supports the following authentication methods according to the 802.1X protocols:

- MD5
- EAP TLS
- EAP TTLS
- Cisco LEAP and PEAP
- Microsoft PEAP

Encryption

The Client supports the following encryptions methods:

- WEP (64-bit and 128-bit)
- TKIP

The Client can also configure the 802.11g radio with no authentication and no encryption; see [Associating With Open APs](#) on page 8-17.

Required Network Configuration Information

Because the Client accesses a network that is protected by the IEEE 802.1X protocol, you must configure EAP data communication to match your network server parameters. If the EAP configuration doesn't match your network configuration, you can't access the network. Therefore, make sure you have the correct network server parameters on hand when you configure the client.





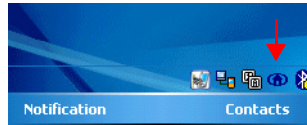

Opening the Client

Tap the icon in the command bar.



Color Indicators

The color of the icon indicates the status of the controlled ports.

Icon	Color	Status
	Green	Authentication succeeded.
	Yellow	Authentication is in process.
	Red	Authentication failed.
If the icon is not yellow, red or green, then either the ports are not being controlled by 802.1x, or there is no authentication activity on the controlled ports. The absence of yellow, red or green may also indicate that the network access server is not an 802.1x aware device.		
	Gray	The port is not in use or is disabled. Either the Client isn't running, or the port is not bound to the 802.1x protocol.
	Orange	The port is associated, but there is no response to 802.11g packets. If using WEP without 802.1x authentication, this will be the final state when the connection is complete. If using 802.1x authentication, it is either a transient condition or can indicate that attempts to authenticate have timed out as there was no response to 802.1x packets.
	Empty	There is no 802.11g activity. The port may not be connected to an 802.1X-aware entity. If you are setting up the 802.11g radio to run without authentication and without encryption, this icon does not change from the standard blue; see Associating With Open APs on page 8-17.

Main Window

Double-tap the icon in the command bar to open the Client . The main window opens displaying a list of ports.

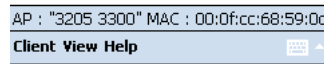
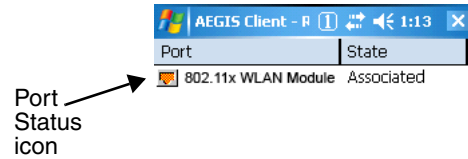

Port Status Icon

The main window contains a port status icon to the left of each port. As the network interface starts or stops, the color of the port icon and the status field updates to reflect the current state of the interface. The colors of the port status icon are the same as the color of the icon in the command bar. For details about what each color means, see [Color Indicators](#) on page 8-2.

Client Menu

On the main window, tap the **Client** menu.

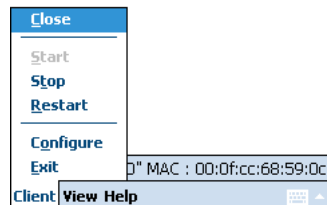

Menu Item	Description
Close	Closes the Client's interface, while leaving the client running.
Start/Stop	Starts or stops 802.1X authentication. After you finish the initial configuration, tap the network interface and tap Start . If the port is already active, tap Stop first, then Start to force the program to read the new configuration file.
Restart	Same as a Stop followed by Start. Select this menu item when you receive a message that a restart is necessary.
Configure	Opens the client authentication windows; see Configuring Client Authentication on page 8-6.
Exit	Selecting Exit is not recommended. It closes the client and stops the 802.1X protocol. A soft reset is required to gain access to the Client again.

View Menu

To access the View menu, tap **View**.

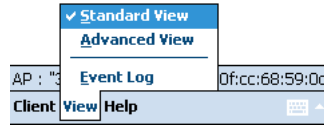

Menu Item	Description
The Standard and Advanced Views control the number of columns displayed in the main menu.	
Standard View	Displays the Port (adapter name) and State columns. This is the default view.
Advanced View	Displays the Port (adapter name), State, Primary Wireless Network, Wireless Network, and MAC Address of AP columns. Scroll right to see all columns.
Event Log	Displays the event log in a custom viewer. The Event Log is a text file that contains system information; each entry is listed sequentially with a time/date stamp and text message. Tap Refresh to query the system again and update the log file while you are reading it. If the file gets too large, old entries are automatically deleted. Logging parameters are set on the System Tab (see page 8-8).

Port Menu

The Port menu enables you to configure the port. On the main window, tapping once on a port opens a popup menu.

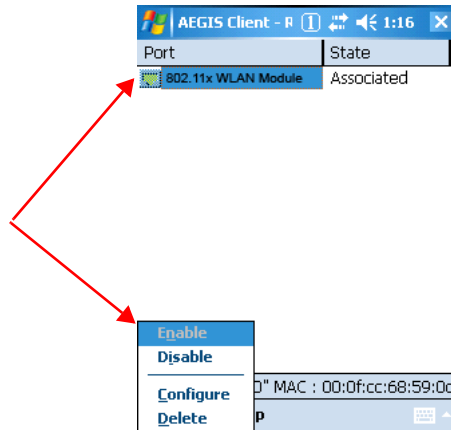

Menu Item	Description
Enable Disable	These commands enable or disable 802.1X authentication on the port. The port should be enabled before the protocol is started. Enabling a port is not the same as starting it (see Start/Stop on page 8-3); however, both actions are required for the Client to work.
Configure	Opens the port configuration window; see Configuring a Port on page 8-10.
Delete	Selecting Delete has no effect on the Dolphin 7850; you cannot remove the radio driver from the device.

Status Bar

The status bar indicates the connection status between the network card and the AP.



Depending on the status of connectivity, the status bar displays one of the following:

- Not Associated
- AP : [AP's SSID] MAC : [AP's BSSID].

Setup Windows

Use the following navigation aid to examine the configuration options for each set of configuration windows:

Configuring Client Authentication (see page 8-6)

- [User Tab](#) (see page 8-6)
- [System Tab](#) (see page 8-8)
- [Server Tab](#) (see page 8-9)

Configuring a Port (see page 8-10)

- [Wireless Networks Tab](#) (see page 8-10)
- [Protocol Tab](#) (see page 8-11)

Configuring a Network Profile (see page 8-13)

- [Profile Info Tab](#) (see page 8-13)
- [WEP Mgmt Tab](#) (see page 8-15)
- [WPA Settings Tab](#) (see page 8-16)

Configuring Client Authentication

Each user account needs to define the protocol and the credentials used to authenticate a user. When you start and stop on a port, you are enabling and disabling the authentication established here.

Note: Fields will be grayed out if not relevant to the selected protocol.

On the main window, tap **Client** menu > **Configure**. Complete the following tabs:

- [User Tab](#) (see page 8-6) to establish user authentication parameters
- [System Tab](#) (see page 8-8) to set logging parameters
- [Server Tab](#) (see page 8-9) to determine certificate and server parameters

User Tab

Enter the credentials used to authenticate a user.

Field	Description
Profile	<p>Multiple user credential profiles can be created for use when the user roams from one network to another. The drop-down list contains existing authentication credential profiles. Select a profile from the list to edit it in the fields that follow.</p> <ul style="list-style-type: none"> • Tap Add to create a new profile on the Profile Info Tab (see page 8-13). • Enter a Profile name and tap OK. The name entered appears in the this drop-down list. Tapping Delete deletes the profile selected in the drop-down list. To be deleted, a profile cannot be assigned to a configured network.

Field	Description
Identity	<p>This is the 802.1X identity supplied to the authenticator. The identity value can be up to 63 ASCII characters and is case-sensitive.</p> <p>For tunneled authentication protocols such as TTLS and PEAP, this identity (called the Phase 1 identity) is sent outside the protection of the encrypted tunnel. Therefore, it is recommended that this field not contain a true identity, but instead the identity “anonymous” and any desired realm (e.g. anonymous@myrealm.com). For TTLS and PEAP, true user credentials (Phase 2 identity) are entered in the Tunneled authentication section.</p> <p>When used with PEAP and the .NET Enterprise Server Version 5.2, this field must contain the identity used in both Phase I and Phase II. The Phase II identity field is ignored.</p>
Password	<p>This is the password used for MD5-Challenge or LEAP authentication. It may contain up to 63 ASCII characters and is case-sensitive. Asterisks appear instead of characters for enhanced security.</p>
Authentication type	<p>This is the authentication method to be used - MD5-Challenge, LEAP, PEAP, TLS, or TTLS.</p> <p>Your network administrator should let you know the protocols supported by the RADIUS server. The RADIUS server sits on the network and acts as a central credential repository for Access Servers that receive the radio signals and ultimately block or allow users to attach to the network.</p>
Use certificate	<p>This is the certificate to be used during authentication. A certificate is required for TLS, optional for TTLS and PEAP, and unused by MD5 and LEAP. Therefore, this option becomes active only when TLS, TTLS, or PEAP is selected as the Authentication type.</p> <p>If Use certificate is enabled, the client certificate displayed in the field is the one that is passed to the server for verification. To select a client certificate, tap Change and select the certificate from the list that appears. To appear in this list, certificates must be installed in the system; see Certificates on page 8-18.</p> <p>The Issued to column should match the Identity field and the user ID on the authentication server used by the authenticator.</p> <p>Your certificate must be valid with respect to the authentication server. This generally means that the authentication server must accept the issuer of your certificate as a Certificate Authority.</p> <p>When obtaining a client certificate, do not enable strong private key protection. If you enable strong private key protection for a certificate, you will need to enter an access password for the certificate each time this certificate is used.</p>
Tunneled authentication area	
<p>Tunneled authentication parameters are used by only by TLS, TTLS and PEAP protocols, in Phase 2 of authentication, and after the secure tunnel has been established. The fields in this section are active only if the TLS, TTLS, or PEAP is selected as the Authentication type.</p>	
Identity	<p>The user identity used in Phase 2 authentication. The identity specified may contain up to 63 ASCII characters, is case-sensitive and takes the form of a Network Access Identifier, consisting of <name of the user>@<user’s home realm>. The user’s home realm is optional and indicates the domain to which the tunneled transaction is to be routed.</p> <p>Because Microsoft .NET Enterprise Server Version 5.2 does not use this parameter for PEAP, This field will have no effect for PEAP at this time. Phase 1 identity is used instead.</p>
Password	<p>The password used for the tunneled authentication protocol specified. It may contain up to 63 ASCII characters and is case-sensitive. Asterisks appear instead of characters for enhanced security.</p>

Field	Description
Protocol	<p>This parameter specifies the authentication protocol operating within the secure tunnel.</p> <p>The following protocols are currently supported for TTLS:</p> <ul style="list-style-type: none"> • EAP-MD5 • CHAP • PAP • MS-CHAP • MS-CHAP-V2 <p>The following protocols are currently supported for PEAP:</p> <ul style="list-style-type: none"> • EAP-MS-CHAP-V2 • TLS/SmartCard • Generic Token Card (EAP-GTC)

System Tab

Define logging settings and the port manager timeout period.

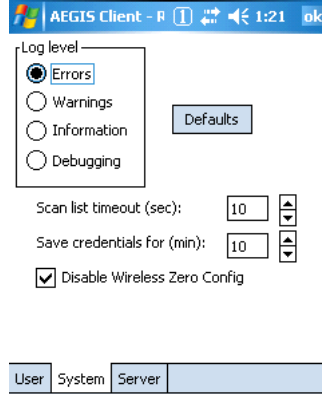

Field	Description
Log Level	<p>These settings control the detail of the log messages generated by the Client. Each level is cumulative. By default, all errors, warnings, and information events are logged. Each entry records a severity code (of one [debug message] to four [error] asterisks), a time stamp, and a message.</p> <ul style="list-style-type: none"> • Errors=Only the most severe conditions are logged. • Warnings=Less severe conditions are logged. • Information=All errors, warnings, and information events are logged. This is the default setting. • Debugging=Creates a log message each time the Client detects or reacts to an event. Be advised that log entries fill memory quickly if the Debugging level is chosen. Do not use the Debugging option for a significant length of time because most internal operations generate messages. <p>For more information, see Logging on page 8-9.</p>
Defaults button	Tap this button to return log settings to the default settings.
Scan List Timeout	The time interval at which the Client polls the ports. This value should not be changed from the 10-second default unless technical support advises you to do so.
Save Credentials for (min)	The amount of time the Client saves credentials.
Disable Wireless Zero Config	This option is selected by default and disables other wireless utilities. Use this option only as directed by technical support.

Logging

The event log is an ASCII text file named “LOG8021X.TXT” located in the directory defined by the WINDIR environment variable (usually the Windows directory).

In the text file, the format of the entries is:

Time Stamp Message Text

Note: To see an event log on the window, tap View > [Event Log](#) (see page 8-4).

If you wish to start with a blank file or clear the event log, close the Client (so that the icon no longer appears in the command bar) and delete the log file (log8021x) in Windows Explorer. When you restart the Client, a new log file is created.

Server Tab

The Server tab controls how the Client authenticates the server that handles the 802.1X protocol on the network side. This applies only to the TLS, TTLS, and PEAP authentication methods and is used to tell the Client what server credentials to accept from the authentication server to verify the server. The Client uses this information to verify that the Client is communicating with a trusted server.



Field	Description
Do not validate server certificate chain	If this option is selected, the server certificate received during the TLS/TTLS/PEAP message exchange is not validated.
*Certificate issuer must be	This is the certificate authority used during TLS/TTLS/PEAP message exchange. Any Trusted CA is the default selection and means that any certificate authority can be used during authentication. Both trusted intermediate certificate authorities and root authorities whose certificates exist in the system store are available for selection in the drop-down list.
*Allow intermediate certificates	This option is selected by default and enables unspecified certificates to be in the server certificate chain between the server certificate and the certificate authority selected in the Certificate issuer must be field. When selected, this option allows the server certificate received during negotiation to be issued directly by the certificate authority or by one of its intermediate certificate authorities. If disabled, then the selected Certificate issuer must have directly issued the server certificate.
Server name must be	This is either the server name or the domain the server belongs to, depending on which option is selected below the text field. During authentication, this name will be compared to the server certificate’s Subject: CN field.
Must match exactly	The server name entered must match the server name found on the certificate exactly.
Must contain domain name	The server name field identifies a domain and the certificate must have a server name belonging to this domain or to one of its sub-domains (e.g., zeelans.com, where the server is blueberry.zeelans.com).

Field	Description
*In order to function properly, certificates must be recognized by both the Client and the operating system. For more information, see Certificates on page 8-18.	

Configuring a Port

On the main window, tap on a port and tap **Configure**. Complete the [Wireless Networks Tab](#) (see page 8-10) and the [Protocol Tab](#) (see page 8-11).

Wireless Networks Tab

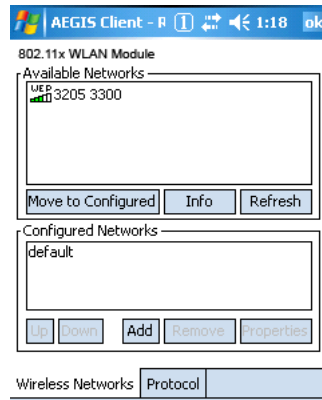

Field	Description
Available Networks	Displays the networks the device recognizes as available to connect to.
Move to Configured	Activates after the available networks have been retrieved. Select the network you wish to connect to, and tap Move to Configured. This selects the network and moves it to the Configured Networks list.
Refresh	Displays a list of networks broadcasting their availability. You can also attach to networks that are not broadcasting.
Configured Networks	Displays the configured network profiles saved in the device. The order of the network profiles in this list is the same order (from the top down) that the device uses to connect to a network.
default	<p>This is the default network configuration that installs when the Client installs. This network profile associates with any network and is already configured with standard settings. You can modify this setting to match your desired connection.</p> <p>If you are in a location with only one AP (or more than one AP that attaches to the same network), the default profile may be sufficient without requiring the selection of a specific network or networks.</p> <p>If default is last in the list, it can act as a wildcard if the device is out of range of the primary networks (listed first).</p> <p>Do NOT place default at the top or middle of the list if you are connecting to other networks! If default is any place other than last, connection to the other list entries is never attempted.</p> <p><i>Note: Note that there is nothing special about the name "default". You could configure any other record similarly and it would behave the same way.</i></p>
Up & Down	Moves a selected network up or down one place in the list. The order of the networks in this list is the exact order that connections will be attempted. The network listed first will be attempted first and so on. Place your primary networks first.

Field	Description
Add	Manually adds a network to the Configured Networks list. Manually add a network if the AP does not broadcast its SSID or you are pre-configuring the client for an AP that is not currently in range. For details, see Configuring a Network Profile on page 8-13.
Remove	Removes a selected network from the Configured Networks list.
Properties	Displays the properties of the network selected in the list. Tap this button to edit existing wireless network configurations. For details, see Configuring a Network Profile on page 8-13.

Protocol Tab

The Protocol tab configures parameters that apply to all the networks the selected port connects to.

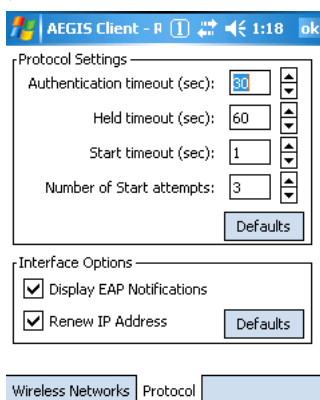

Field	Description
Protocol Settings	These are the timer intervals and retry settings defined in the 802.1x standard. They determine how long the supplicant state machine will wait in a given state. These parameters shouldn't be modified without an understanding of the supplicant state machine. For more information about the supplicant state machine, obtain its 802.11x protocol specification. The parameters are: <ul style="list-style-type: none"> • Authentication Timeout—The period of time the Client remains in the authenticating or acquired state without receiving a response from the AP or switch. 30 seconds is the default. • Held Timeout—The period of time the Client remains in the held state after failing authentication. 60 seconds is the default. • Start Timeout—The period of time the Client remains in the connecting state before restarting when there is no response. One second is the default. • Number of Start Attempts—The number of times the Client restarts before giving up. At that point, the Client then defaults to the authenticated state, but there will be no network connectivity because the protocol exchange was never completed. Three is the default.
Display EAP notifications	Specifies that the EAPOL notification message will be displayed to the user. An authenticator may use such notification to inform you, for example, about a near password expiration. However, some authenticators send chatty and annoying notifications that may, for the convenience of the user, be suppressed. Note that all notifications are written to the event log even if they are not displayed.

Field	Description
Renew IP address	<p>Initiates a DHCP request to obtain a dynamic IP address after a successful authentication, but only if the client detects that the connected network (the SSID) has changed. The result is that renewal should not occur upon re-authentication, but does occur at boot or when connecting to a different network.</p> <p>If you have a slow authenticator, you may wish to enable this option when configuring the service because a slow authenticator may prevent you from getting a DHCP-assigned IP address upon boot-up. This option is ignored if the given adapter has a static IP address.</p>

Configuring a Network Profile

You can configure a network based on an AP in range, create a new network, or modify the [default](#) (see page 8-10) network. The default network comes pre-configured with the Client.

To configure a network to an AP in range, tap one of the networks in the Configured Networks list. Select the network and tap **Properties**.

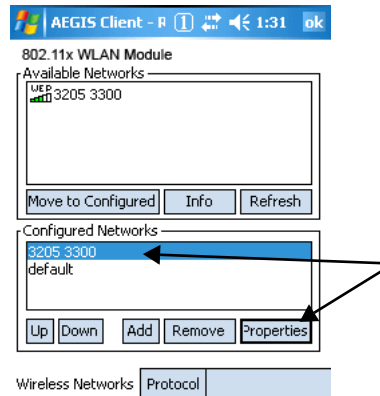

The Profile Setup tab windows open.

Note: If the AP you want is not in the Configured Networks list, select it in the Available Networks list and tap Move to Configured. To create a new network, tap Add.

There are three tabs to complete:

- [Profile Info Tab](#) on page 8-13
- [WEP Mgmt Tab](#) on page 8-15
- [WPA Settings Tab](#) on page 8-16

Information from the AP autofills some fields on these tabs.

Note: The settings on these tab windows are interrelated. This means that selecting one may disable access to others.

Profile Info Tab

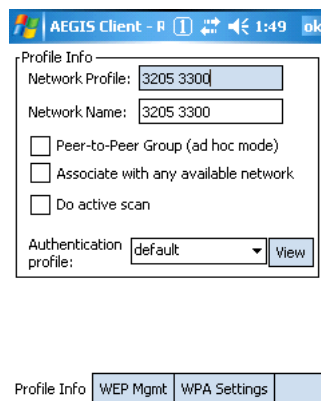

Field	Description
Network Profile	If you are configuring a network from the list, the name that appears in this field is the same as the name in the Configured Networks list and, by default, is the same as the broadcast SSID. This name cannot be changed. If you are adding a new network, this field is configurable.
Network Name	This is the SSID of the AP. If the AP broadcasts its SSID, then this value is retrieved from the Available Networks list and this field is completed automatically. If the SSID does not broadcast, then the field will be active and you must manually enter the value here. <i>Note: You cannot enter a Network Name if Associate with any available network is enabled.</i>

Field	Description
Peer-to-Peer Group	Select this option to have two or more client workstations communicate with each other without the benefit of an AP, otherwise known as ad hoc mode. You should also select Do Active Scan and, on the WEP Mgmt tab, select Use key for data encryption while entering a common key for both sides. WPA is not supported in this mode.
Associate with any available network	Select to associate with any available network.
Do active scan	Select this option whenever the AP (or client, for ad hoc mode) is not broadcasting its SSID. <i>Note: This option is not available when Associate with any available network is selected.</i>
Authentication Profile	Select the authentication profile associated with this network and tap View . The drop-down list contains client profile names created in the User tab of the client configuration area; see User Tab on page 8-6. default is the default authentication profile.

WEP Mgmt Tab

Enter the appropriate WEP parameters for the network.

Field	Description
Provide encryption key dynamically	This option is selected by default. The other WEP settings on this page are disabled to enable dynamic encryption. Selecting this option also enables WPA; the WPA Settings tab appears. To enter a custom WEP, de-select this option. The other fields become active and the WPA Settings tab no longer appears.
Use key for data encryption	Select this option to manually enter a WEP key (in the Key field) to encrypt your data to the AP.
Use key to authenticate with AP	Selecting this option toggles the WEP authentication mode between Open and Shared (Not checked = Open, checked = Shared). <ul style="list-style-type: none"> • Open means the only authentication performed is to check that a client's SSID setting matches the SSID of the AP. • Shared means that the Client authenticates with the AP via a challenge/response mechanism.
Key	In this field, enter the WEP key to use for data encryption or authentication to the AP. ASCII: 5 or 13 characters Hexadecimal: 10 or 26 characters. When the key entered is in the correct format, the window changes to display the type—ASCII or Hexadecimal.
Key Index/Transmit Key	This list contains the available keys. You may enter up to four keys for reception; the Client will try all four to find one that works with the AP. Select the key to be used for transmission as well. If the key selected is the transmit key, the Transmit key box is checked. To change the transmit key, select another key and check the Transmit key box. The check box of the original transmit key will be automatically de-selected.

WPA Settings Tab

This tab controls the WPA settings. This tab window is available only if **Provide encryption key dynamically** is selected on the WEP Mgmt tab is selected.

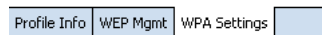
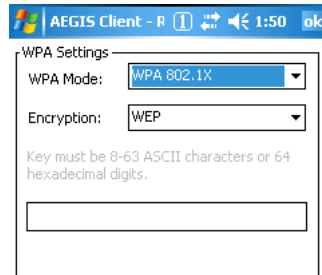

Field	Description
WPA Mode	<p>This drop-down list contains the following options:</p> <ul style="list-style-type: none"> • Disabled: Do not enable WPA mode. This is the default selection. • WPA 802.1x: Enable WPA and obtain key information through the 802.1x protocol. • WPA PSK: Enable WPA with Pre-Shared Key (PSK) information entered in the field below. This mode is used if the 802.1x protocol is not being used for authentication.
Encryption	<p>Select the desired encryption.</p> <ul style="list-style-type: none"> • WEP: The least secure of the encryption methods. WEP uses a single encryption key of either 40 or 104 bits. WPA uses a 256 bit Pre-shared key. • TKIP: Uses the standard WEP format, but changes the key with every frame for improved security and includes a message integrity capability for determining unauthorized packet insertion. <p><i>Note: The current Dolphin 7850 hardware does not support AES.</i></p>
PSK pass-phrase	<p>This field activates if you select WPA PSK as the mode. This must be 8–63 ASCII characters or 64 hexadecimal digits.</p>

WEP Encryption Without Authentication

1. On the [Main Window](#) (see page 8-3), tap the port and select **Configure** on the popup menu.
2. On the [Wireless Networks Tab](#) (see page 8-10), select the SSID and tap **Properties**.
3. On the [Profile Info Tab](#) (see page 8-13), select **Do active scan**.
4. On the [WEP Mgmt Tab](#) (see page 8-15), select **Use key for data encryption**.
5. Enter the WEP **Key**; see [Key](#) on page 8-15. Tap **OK**.
6. On the main window, tap **Client > Restart** to restart the Client.
7. Wait as the Client connects.
8. When the connection is complete, the [Port Status Icon](#) (see page 8-3) on the main window reads **Associated** instead of **Authenticated**. However, the log file (see [Logging](#) on page 8-9) will read "Entered AUTHENTICATED state" when recording this event.

Associating With Open APs

To associate with open APs means to set up the 802.11g radio without authentication or encryption.

1. Double-tap the Client icon on the command bar .
2. On the [Main Window](#) (see page 8-3), tap on the port and select **Configure** on the popup menu.
3. On the [Wireless Networks Tab](#) (see page 8-10), tap **Add** in the Configured Networks section.
4. On the [Profile Info Tab](#) (see page 8-13), enter your AP's SSID in the **Network Profile** field.
5. Select **default** in the Authentication profile drop-down list.
6. On the [WEP Mgmt Tab](#) (see page 8-15), make sure none of the options are selected.
7. Tap **OK** on the Wireless Networks tab.
8. On the [Main Window](#) (see page 8-3), tap **Client > Restart** to restart the client.
9. Wait as the Client connects.
10. When connection is complete, the [Port Status Icon](#) (see page 8-3) turns yellow and the [Status Bar](#) (see page 8-5) reads "Associated".

Note: If your AP is strictly an AP and not a DHCP server, then you must statically assign an IP address and subnet mask.

Certificates

On the [Server Tab](#) (see page 8-9), you can specify one or two certificates to use during the authentication process.

Certificate Requirements

The specified identity should match the **Issued to** field in the certificate and should be registered on the authentication server (i.e., a RADIUS server) that is used by the authenticator. In addition, your certificate must be valid on the authentication server. This requirement depends on the authentication server and generally means that the authentication server must know the issuer of your certificate as a trusted Certificate Authority (CA).

If the selected certificate does require a password or pass phrase to decode the private key, enter this value in the **Certificate Pass Phrase** field. This value will be encrypted when the configuration is saved. However, on some systems, there may not be a certificate.

*Note: Client or CA certificates can be imported from *.cer (same as *.der), *.p7b, or *.pfx files.*

Installing Certificates with CertAdd

CertAdd is a separate utility that allows certificates to be selected and installed on the device for the Meetinghouse Client.

1. Download the certificate file to the device.
The location isn't critical, but you may want to create a standard folder for consistency.
2. Tap **Start > Programs > Meetinghouse Certificate Installer**.

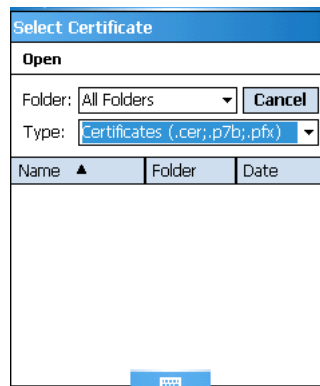

3. Navigate to the certificate location.
4. Tap and hold on the certificate. A popup appears asking if you want to install the certificate.
5. Tap **OK**. The certificate is loaded into the correct certificate store.
6. Verify that the operating system recognizes the certificate. Tap **Start > Settings > System tab > Certificates**  **Certificates > Root tab** and find the certificate in the list.

Installing a Root Certificate

Save the certificate to the device. If no error appears when you save the certificate, it was most likely saved to the device. To make sure that the certificate persists through cold boots, install the certificate to the \IPSM folder.

1. To verify that the certificate is recognized by the operating system, tap **Start > Settings > System tab > Certificates**

 **Certificates > Root** tab. This opens the Certificates window, which displays all the certificates the operating system recognizes.

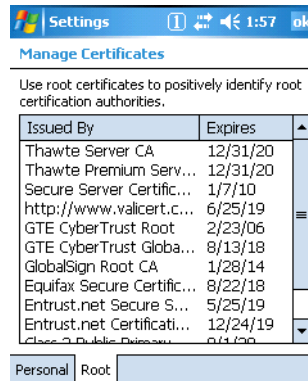

1. Scroll through this list until you see the certificate you installed.
2. After you have identified your certificate in the list, tap **OK** to close.
3. To use the certificate in a network profile, single-tap the **Client** icon in the command bar .
4. Tap on a port on the main window and select **Configure**.
5. Tap the **Server** tab and select the certificate from the **Certificate issuer must be** drop-down list.
6. Tap **OK** to save the setting and close the port configuration.

Advice and Workarounds

Issue	Possible Causes and Solutions
The Client will not start on the device with an error message about missing files.	Perform a soft reset.
The wireless network interface (port) does not appear in the main AEGIS window.	<ul style="list-style-type: none"> • The license is not valid. • Restart the client: on the main window tap Client > Restart. • Perform a soft reset. • If problem continues to persist through all of the above, there may be a hardware failure.
The Client is not attaching to the correct AP.	<p>The default network profile instructs the client to attach to the first available AP. You must select a network, move it to the Configured Networks list, and then move it above default in the list using the up arrow buttons.</p> <p>For more information, see Wireless Networks Tab on page 8-10.</p>
The Client is failing authentication even though all my information was entered correctly.	<ol style="list-style-type: none"> 1. Verify that the network profile for the AP corresponds to the authentication profile you created for it: <ul style="list-style-type: none"> • Select the network profile in the Configured Networks list. • Tap Properties. The Profile Info tab opens - see page 8-13. • In the Authentication profiles drop-down list, select the profile you want to review. • Tap View. The User tab appears displaying the profile's information. 2. Verify that you have configured the identity and password into the correct fields on the User tab (page 8-13) in the authentication profile. If you are using PEAP or TTLS, the username and password are entered in the Tunneled authentication section.
My AP does not broadcast its SSID. Even though I have manually configured an AP with that name, the Client won't associate with it.	<ul style="list-style-type: none"> • Make sure that the Network Name field contains the AP's SSID. • Verify that Do Active Scan is selected on the Profile Info tab; see Do active scan on page 8-14. Otherwise, the Client will not attempt to find the AP.
I am authenticated, but I don't get an IP address through DHCP.	<ul style="list-style-type: none"> • On the main window, tap on the port, tap Configure on the popup menu, and select the Protocol tab. Verify that Renew IP Address is selected; see page 8-12. • Make sure that the 802.11g radio is configured for DHCP and not assigned a static IP address.
I cannot attach to my old network that does not support 802.1x authentication, but is using WEP encryption.	<ul style="list-style-type: none"> • On the Wireless Networks Tab (see page 8-10), verify that the desired SSID is at the top of the Configured Networks list so that it's accessed first. • See WEP Encryption Without Authentication on page 8-17.
I made changes, but they do not appear to have taken effect.	<p>Always tap OK before exiting a window you have changed.</p> <p>Then, on the main window, tap Client > Restart to restart the Client.</p>
How do I enable peer-to-peer (ad-hoc) mode to have two clients communicate without an AP?	<ul style="list-style-type: none"> • On the Wireless Networks window, move a network to the Configured Network list. • On the Profile Info tab, give each side the same network name (SSID). • Select Peer-to-Peer Group (ad hoc mode) and Do active scan. • On the WEP management section, select Use key for data encryption and enter an identical key for both clients. • Verify that this network profile is the first (or only) one in the Configured Network list and try to restart both clients at roughly the same time.

Bluetooth Radio

The on-board Bluetooth radio is enabled by default at startup and operates within the 2.4 GHz–2.48 GHz band. Bluetooth transmissions hop between 79 separate frequencies 1,600 times every second, and with a communication range of about 10 meters (class II).

BTExplorer

BTExplorer discovers Bluetooth devices in the vicinity and presents them in an easy-to-understand format similar to Windows Explorer. BTExplorer visually separates trusted (paired) and untrusted remote devices and identifies friendly names and services of remote devices. Custom icons indicate the device class (type) as well as available services.

The services supported by the local device include

- OBEX
- File transfer
- OBEX object push
- Dial-up networking
- FAX
- LAN access
- Serial port communication

Pairing, security, and encryption settings can be configured for the local device. In addition to the configuration options available, any of the supported services may be added to or removed from the local device.

Enabling the Bluetooth Radio

The Bluetooth radio must be enabled in order to connect to other devices.

By default, the 802.11b radio is enabled after each hard reset. Therefore, you must enable the Bluetooth radio in the [Radio Manager](#) (see page 7-13). Tap **Start > Settings > Connections** tab > **Radio Manager** and select **Bluetooth Only** or **802.11b/Bluetooth** and **OK**.

Accessing BTExplorer

When the radio is enabled, the Bluetooth icon appear in the command bar of the Today screen . Tap this icon to access the popup menu and select **Show BTExplorer**.

Using BTE Explorer

BTE Explorer has a New Connection Wizard for each type of Bluetooth connection you want to make; see [Connection Types](#) on page 9-3. You open BTE Explorer, select the connection type, BTE Explorer scans for matching devices and services, and the connection wizard walks you through the connection process.

Different connection types will require different information. Make sure you have all the necessary information (PIN numbers, passkeys, MAC addresses, etc.) from the devices you want to connect to.

1. On the Today screen, tap the Bluetooth icon  and select **Show BTE Explorer**. The Connection Wizard opens.

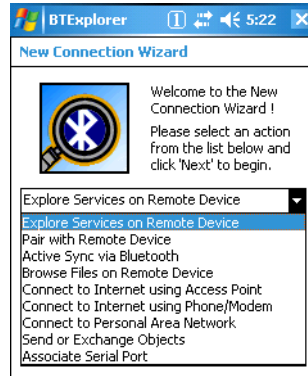

2. Select the action you would like to perform in the drop down list and click **Next**. BTE Explorer scans for other Bluetooth devices in range and displays the search results.

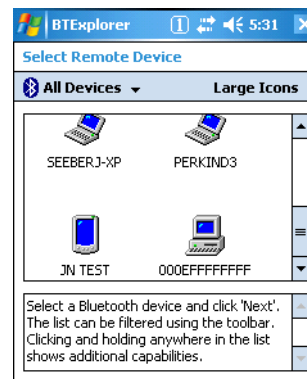
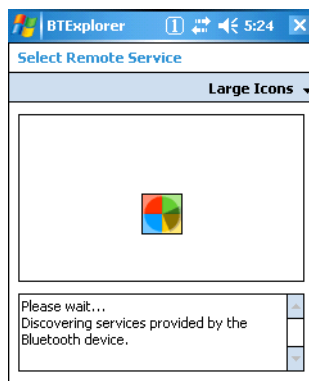

3. Select a device and click **Next**.
4. Depending on the item selected on the New Connection window, you'll be asked to enter specific information in the setup wizard.
5. Complete the wizard to setup the connection type selected; see [Connection Types](#) on page 9-3.

Navigation Buttons

Bluetooth Explorer contains the following navigation buttons at the bottom of every wizard screen:

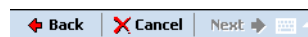

- | | |
|---------------|---|
| Back | Move back on screen in the wizard. |
| Cancel | Cancel the setup and return to the New Connection window. |

Next

Save the information on the current setup screen and move to the next.

Connection Types

Bluetooth Explorer performs the following connections:

Connection Type	Allows the Dolphin terminal to...	Requirements
Explore Services on Remote Devices	Discover available services.	
Pair with Remote Device	Pair with remote devices	The correct PIN number of the device you're attempting to pair with.
ActiveSync via Bluetooth	Synchronize files and data with a remote workstation via Bluetooth ActiveSync.	Matching Bluetooth ActiveSync settings.
Browse Files on Remote Device	See files on a remote device	A working Bluetooth connection with the remote device.
Connect to Internet using Access Point	Connect to the Internet using LAN or a network gateway.	A Bluetooth-compatible access point.
Connect to Internet using Phone/Modem	Connect to the Internet using a mobile phone or mobile phone modem using dial-up networking.	Dial-up account information.
Connect to Personal Area Network (PAN)	Connect to another Bluetooth device that allows participation in a PAN.	Another device that is set up as part of an existing PAN.
Send or Exchange Objects	Send or exchange business cards, contacts, pictures, appointments, and tasks with another Bluetooth device.	A working Bluetooth connection to a remote device.
Associate Serial Port	Make a favorite to a Bluetooth serial port device.	

Device Types

BTE Explorer supports the following device types:

- Audio Devices
- Network Devices
- Phones
- Printers
- Computers
- OBEX Devices

By default, BTE Explorer scans for **Network Devices**.

To change the, device type, tap on the arrow to the right of the heading on the left. The name of this heading changes depending on what device type is selected; it can say “Filter” or “Bluetooth Devices.”



Select another device type in the list.

View Options

Discovered Devices appear with an icon indicating what type of device it is and the Device ID.

By default, the discovered devices screen appears in the Large icon view. The Details menu offers you alternate view options. (When you select the Details menu, its name changes to “View.”)

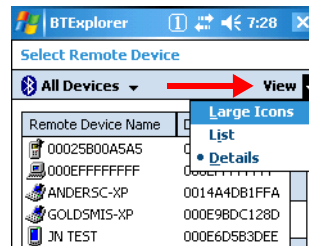

Large Icons

Displays large icons in the viewing area.

List

Displays small icons in a one-column list.

Details

Displays small icons in a list with two columns

Remote Device NameThe Device ID

Device AddressThe MAC address

TrustedThe status of this device; False means the device is not trusted.

Menu Options

The discovered devices window has a popup menu that enables you to perform several tasks. You can select a device and tap and hold or just tap and hold on an empty space; the same menu appears. Certain menu items are enabled or disabled depending on which method you use.

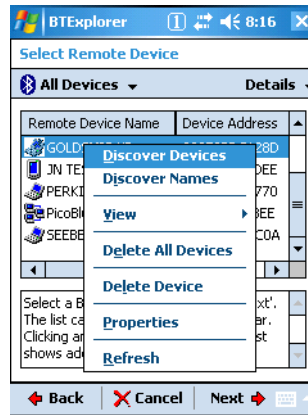

Menu Item	Description
Discover Devices	Scans for Bluetooth devices.
Discover Names	Scans for device names.
View	<p>Opens a side menu that offers you sorting options for the discovered devices list.</p> <ul style="list-style-type: none"> • All Devices—Shows all devices in the vicinity. • Trusted Devices Only—Removes untrusted devices from the display. • Untrusted Devices Only—Removes trusted devices from the display. <p><i>Note: These options affect only what appears on the display, not what devices the Dolphin terminal has discovered.</i></p>
Delete All Devices	Deletes all the discovered devices.
*Delete Device	Deletes a selected device.

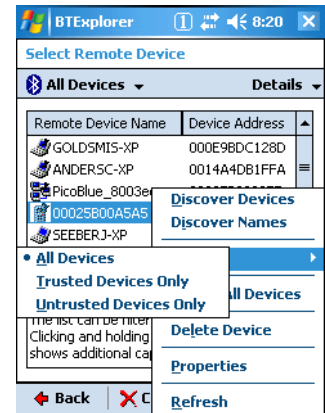

Menu Item	Description
*Properties	Displays the properties of a selected device. Tap OK (either one) to return to the discovered devices window.
Refresh	Scans for Bluetooth devices.



*These items are active only when a device is selected when the pop-up menu appears.

Refreshing Discovered Devices

If your Bluetooth device doesn't show up in the list, scan again by tapping and holding on the window and selecting Refresh on the pop-up menu.

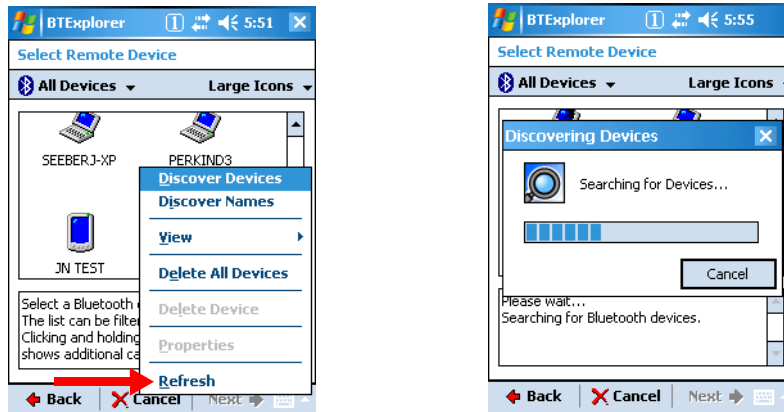

Note: BTExplorer displays the devices found on the first search but does not refresh automatically.

Pairing

Pairing associates Bluetooth devices with each other so that you don't have to enter access information every time a connection is requested. Bluetooth devices need to be paired with each other before attempting a connection the first time.

Paired devices remain paired, even if:

- One of the devices is not powered.
- A service connection is interrupted or stopped.
- One or both devices are rebooted.

Passkey Paired devices share a unique passkey both devices use to authenticate when connecting. The passkey can be alphanumeric, numbers, or letters, and must consist of one or up to 16 characters.

Overview

As the hub of your Dolphin 7850 system, the Dolphin HomeBase charging and communication cradle supports both RS-232 and USB communication, enabling your terminal to interface with the majority of PC-based enterprise systems.

Communication

RS-232 transmits data at speeds of up to 115 Kbps. With USB port, the data transmission rate goes up to 12 Mbps.

HomeBases cannot be physically connected to each other—sometimes referred to as “daisy-chaining”—but can be networked together through serial or USB hubs.

Convenient Storage

Intelligent battery charging makes the HomeBase a safe and convenient storage receptacle for your terminal.

Capacity

The HomeBase can charge two battery packs: the one that's installed in the terminal and the other in the auxiliary battery well on the back panel. While charging the battery pack in the terminal, the HomeBase also powers the Dolphin terminal. The auxiliary battery well charges a battery pack independently of the terminal well.

Intelligent Battery Charging

The HomeBase completes a full charge of the main battery pack in less than four hours.

In addition to charging, the HomeBase powers the intelligent battery charging system in the terminal that protects the battery from being damaged by overcharging. The terminal senses when a battery pack is fully charged and automatically switches to a trickle charge that maintains the battery at full capacity.

As a result, terminals may be stored in the HomeBase without damage to the terminals, battery packs, or peripherals.

Power Supply

The HomeBase is available with US, UK, and European power supplies. Each version is designed to convert the voltage from the power sources in each geography to the 7.4 volts DC required by the terminal.



Use only the peripherals, power cables, and power adapters from Hand Held Products. Use of peripherals, cables, or power adapters not sold/manufactured by Hand Held Products will void the warranty and may damage the terminal.



Use only the Li-ion battery packs provided by Hand Held Products. The use of any battery pack not sold/manufactured by Hand Held Products in a Dolphin terminal will void your warranty and may result in damage to the Dolphin terminal or battery.

Front Panel

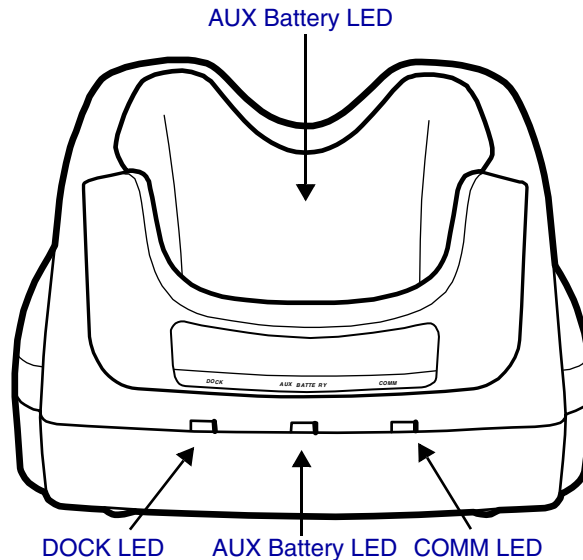

AUX Battery LED

Indicates status of the battery charging in the auxiliary battery well; see page 10-3.

Orange The auxiliary battery is charging.
Green The auxiliary battery has completed charging and is ready for use.

COMM LED

The COMM LED indicates the status of data transfer between the Dolphin terminal and the host workstation. The color of this LED differs if the HomeBase is using the serial or USB port connection.

If using a serial port connection

Red Serial data is being sent from the host device to the HomeBase.
Green Serial data is being sent from the HomeBase to the host device.
Orange Serial data is being sent at high data rates.

If using a USB port connection

Green A USB connection is established with the host workstation.

DOCK LED

Turns solid green when the terminal is properly seated in the HomeBase. When this light is on, the terminal is connected to the HomeBase.

Terminal Well

Place the terminal in this well to communicate with a host device, power the terminal, and charge its battery pack. The back of the terminal well features a saddle to accommodate the integrated pistol-grip handle.

Back Panel

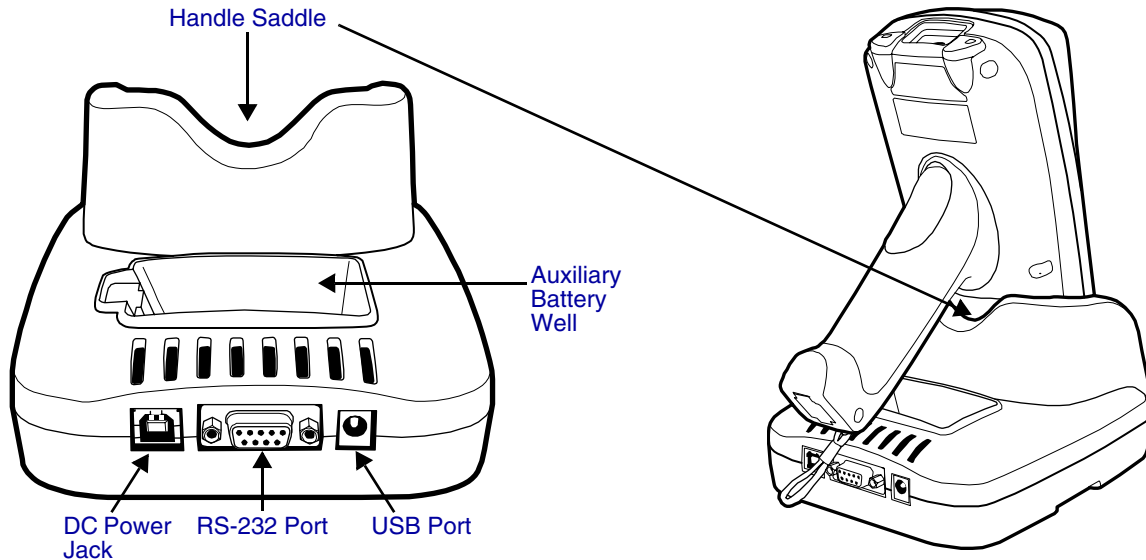

Auxiliary Battery Well

The auxiliary battery well charges an additional Li-ion battery pack independently of the terminal well. This feature ensures that you can always have a fully-charged battery for your terminal; see [Charging a Spare Battery Pack](#) on page 10-3.

DC Power Jack

Connect the power cable to this power jack; see [Powering the HomeBase](#) on page 10-5.

Handle Saddle

The curve on the back wall of the terminal well accommodates the pistol-grip handle when the terminal is seated in the well.

RS-232 Port

For RS-232 data communication, use the 9-pin, RS-232 cable from Hand Held Products to connect this port to a peripheral device. For more information, see [RS-232 Serial Connector](#) on page 10-5.

USB Port

This USB Port is full-speed, 2.0 compliant, and requires ActiveSync 4.1 or higher. Using a USB cable, you can connect the HomeBase to a USB-compliant device. When the HomeBase is connected to that device, the terminal is connected to the device when seated in the terminal well. The HomeBase acts as a USB device by interfacing the USB signals of the terminal to the USB signals of the host workstation; see [ActiveSync Communication](#) on page 10-7.

Charging a Spare Battery Pack

The auxiliary battery well located on the back panel ([Auxiliary Battery Well](#), page 10-3) charges a spare battery. The [AUX Battery LED](#) (page 10-2) on the front panel indicates the charge status of the battery in this well. Charge time is less than four hours and the charge process is independent of the terminal well.

1. Insert the end of the battery without the locking tab into the bottom of the auxiliary well opening.
2. Snap the battery into place with a hinging motion. The Aux Battery LED lights orange.
3. The AUX Battery LED monitors the charge progress.

Bottom Panel Dimensions

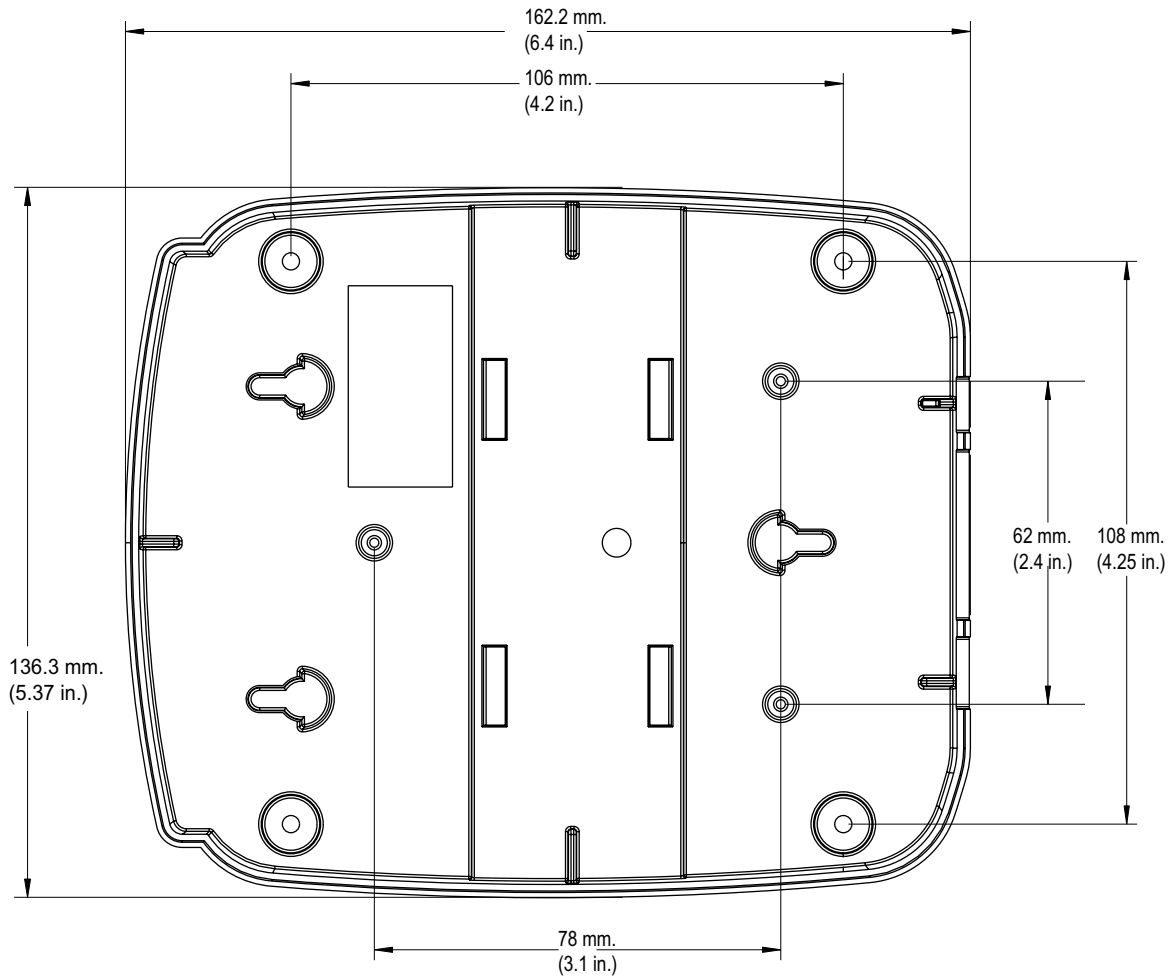

Powering the HomeBase

The terminal requires 9.5 volts DC input for communication and battery charging; the power adapter on the power cable converts the voltage from the power source to 9.5 volts DC. Only power adapter cables from Hand Held Products convert the voltage appropriately.

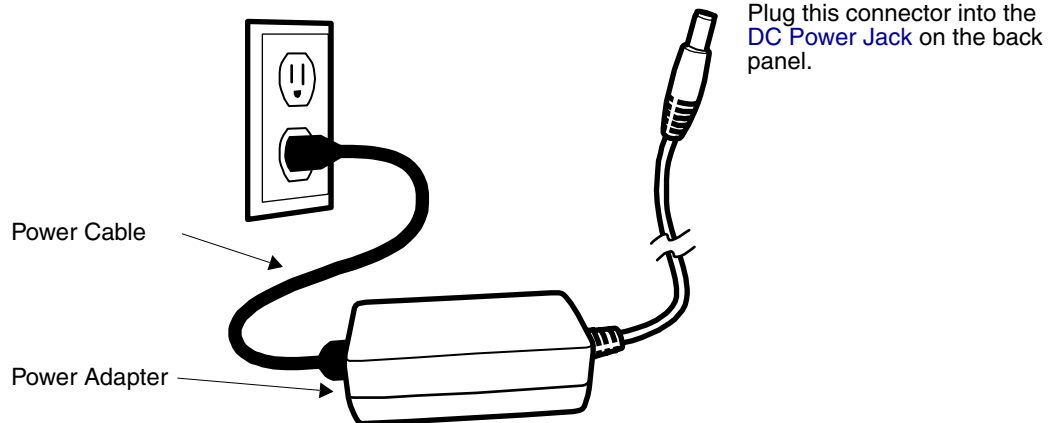

1. Plug the power cable into the power adapter.
2. Plug the power cable into the power source.
3. Plug the connector cable into the DC power jack on the back panel. The HomeBase is now powered.

When a terminal is properly seated in the terminal well, the HomeBase powers the terminal, charges the terminal's main battery pack, and launches ActiveSync communication (see [ActiveSync Communication](#) on page 10-7).

Hand Held Products recommends that you leave the HomeBase connected to its power source at all times, so that it is always ready to use.

RS-232 Serial Connector

The following diagram displays the pins of the RS-232 serial connector of the [Back Panel](#) (see page 10-3):

Note: Signals referenced are for a DTE device. The HomeBase is at a right-angle to the printed circuit board (PCB). The ninth pin has a ring indicator (RI).

Charging the Main Battery

The HomeBase powers the terminal and fully charges its main battery pack in less than four hours. To check battery power, see [Power](#) on page 6-11.

As battery packs charge, the charging circuitry follows the two-step charging process (CC-CV) that is recommended for Li-Ion batteries. The process monitors changes in temperature, current, and voltage.

Inserting a Terminal

1. Install the battery pack in the terminal; see [Install the Main Battery Pack](#) on page 2-1.
2. Power the HomeBase; see [Powering the HomeBase](#) on page 10-5.
3. Slide the terminal into the terminal well until the Dock LED lights green to indicate that the terminal is properly seated.
4. The battery pack begins charging.

The intelligent battery charging system in the terminal monitors battery power and senses when a full charge has been obtained. When charging is complete, the terminal switches to a trickle charge that keeps the battery at full charge while resting in the HomeBase.

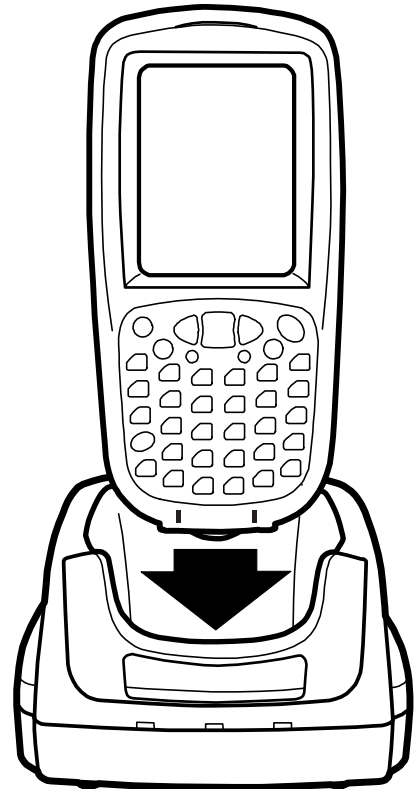

ActiveSync Communication

The Dolphin terminal ships with ActiveSync already installed and defaulted to USB communication. If ActiveSync is not installed on your workstation, you must install it. For details, see [Using ActiveSync](#) on page 7-3.

Communication Types

The HomeBase can communicate via USB or RS-232 using ActiveSync 4.1 or higher. However, the HomeBase should have only one type of interface cable connected at a time, either USB or RS-232.

USB The [USB Port](#) (see page 10-3) on the back panel allows the terminal to communicate with a workstation or be networked through a USB hub. The HomeBase acts as a USB device by interfacing the USB signals of the terminal to the USB signals of the host workstation.

Maximum data transfer rate is 12 Mbps.

RS-232 The [RS-232 Port](#) (see page 10-3) on the back panel allows the terminal to communicate with a workstation, modem, or any RS-232 device using a standard serial cable and communication software.

Maximum data transfer rate is 115 Kbps.

Communicating with the Dolphin Terminal

1. Insert the terminal into the terminal well of the HomeBase.
 - The DOCK LED lights green.
If not, make sure that the terminal is properly seated. You may need to remove and re-insert the terminal.
 - The terminal activates.
If not, verify that the Hand Held Products power supply is properly connected to the [DC Power Jack](#) (see page 10-3) on the back panel and plugged into a functioning outlet.
2. The terminal and the workstation automatically open ActiveSync to establish a connection.
3. The HomeBase can now transfer data between the terminal and the host workstation. If communication does not occur, check the port connections to ensure that the cradle is correctly configured.

Verify Communication

You can verify that the USB driver is functioning by watching the COMM LED on the USB HomeBase. When the COMM LED lights solid green, the Dolphin HomeBase is communicating with the workstation.

Verify Data Transfer

The COMM LED flashes when data is being transferred via the Dolphin HomeBase. For an RS-232 connection, the COMM LED flashes red and green. For a USB connection, the COMM LED flashes green.

RS-232 Cables

Connect the HomeBase to the host workstation or other device by plugging an RS-232 serial cable into the [RS-232 Port](#) (see page 10-3) on the back panel. The wiring of your cable depends on whether the other device is set up as a Data Communication Equipment (DCE) or Data Terminal Equipment (DTE) device.

The HomeBase is configured as a DCE device. To communicate with another DCE device, use either a null modem adapter in line with a standard RS-232 cable, or a null-modem serial cable. To communicate with a DTE device such as a computer, use a standard (or straight-through) RS-232 cable.

You can make your own cables by following the pin configuration in the chart below. To do so, you must determine if your host RS-232 device is 9-pin or 25-pin, and whether it is configured as a DCE or DTE device.

RS-232 Pin Configuration

HomeBase /Host Port (DCE)	IBM AT DB9 (DTE)	IBM XT DB25 (DTE)	Modem DB25 (DCE)
Pin / Input Signal			
2 / (RD)	2	3	2
3 / (TD)	3	2	3
5 / (SG)	5	7	7
4 / (DTR)	4	20	6
6 / (DSR)	6	6	20
7 / (RTS)	7	4	5
8 / (CTS)	8	5	4

Note: The HomeBase cannot be daisy-chained.

Mounting the Dolphin HomeBase

Set the HomeBase on a dry, stable surface, such as a desktop or workbench near an electrical outlet. Be sure to provide enough workspace with good lighting for the user to view and operate the terminal while it is seated in the HomeBase.

When choosing a location, bear in mind that:

- the mounting location must allow users easy access to the auxiliary battery well, and
- the serial and USB ports as well as the power jack face straight out of the rear panel, and you will most likely want easy access to them in the future.

Desk Mounting

Dolphin charging/communication cradles have a DIN rail (7.5 mm high X 35 mm wide) slot on the bottom to allow for secure desk attachment of the unit if desired.

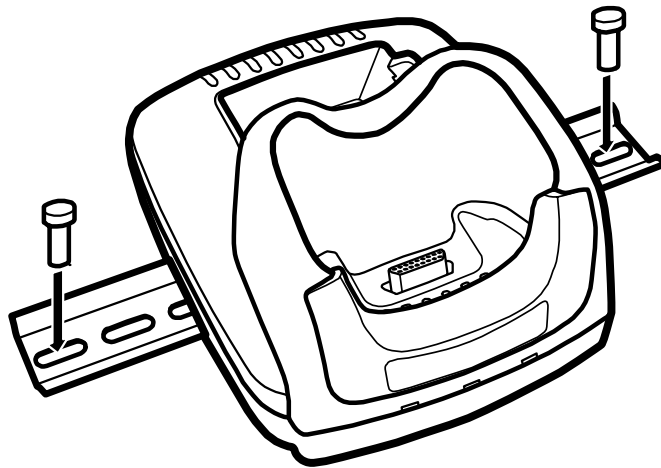

1. Slide the DIN rail slot along the bottom panel.
2. Using the appropriate nuts and bolts, secure the DIN rail to the desk or flat surface.

Note: Use screws that are appropriate for the type of surface (wood or metal, for instance) you are mounting to.

Wall Mounting

A wall mount kit that contains a screws and a mounting bracket can be purchased separately. The bottom panel of the HomeBase contains four rubber feet—one at each corner—that help keep it stable and secure when resting on a flat surface. Those rubber feet should be removed with pliers before wall mounting the HomeBase.

1. Secure screws to the bottom panel by sliding them into the available slots.
2. Attach the bottom panel to the mounting bracket matching the holes to the secured screws.
3. Fasten the screws to secure the HomeBase to the mounting bracket.

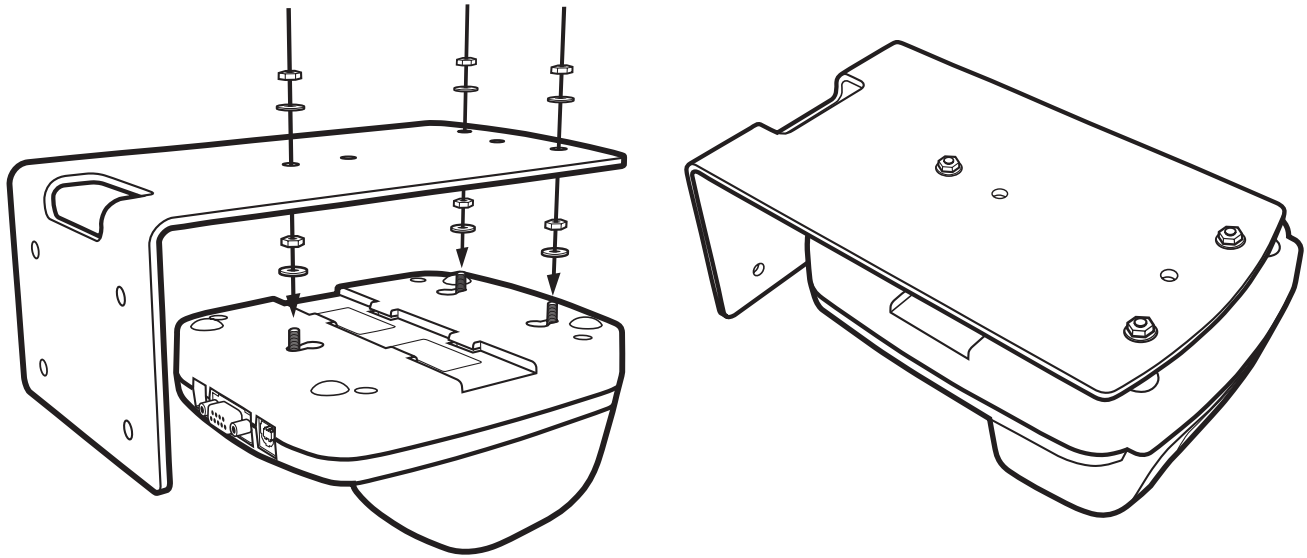

4. Turn the secured HomeBase right side up.
5. Using the appropriate screws, secure the mounting bracket to the wall or vertical surface as shown.

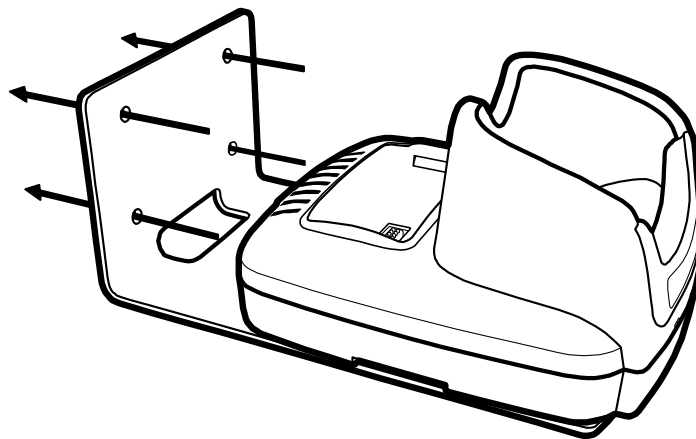

Dolphin QuadCharger

Overview

The Dolphin QuadCharger is a four-slot charging station that can charge a Li-ion battery in less than four hours. The fourth slot features a battery analyzer that completely resets and re-calibrates a battery and displays its resulting capacity.

The QuadCharger is compatible with the Li-ion batteries that power Dolphin 7850 terminals.

Intelligent Battery Charging

Each charging slot works independently of the other three.

As battery packs charge, the charging circuitry follows the two-step charging process (CC-CV) that is recommended for Li-ion batteries. The process monitors changes in temperature, current, and voltage. The charger also resets and calibrates battery pack data to accurately show battery status on the Dolphin display.



Use only the peripherals, power cables, and power adapters from Hand Held Products. Use of peripherals, cables, or power adapters not sold/manufactured by Hand Held Products will void the warranty and may damage the terminal.



Use only the Li-ion battery packs provided by Hand Held Products. The use of any battery pack not sold/manufactured by Hand Held Products in a Dolphin terminal will void your warranty and may result in damage to the Dolphin terminal or battery.

Front Panel

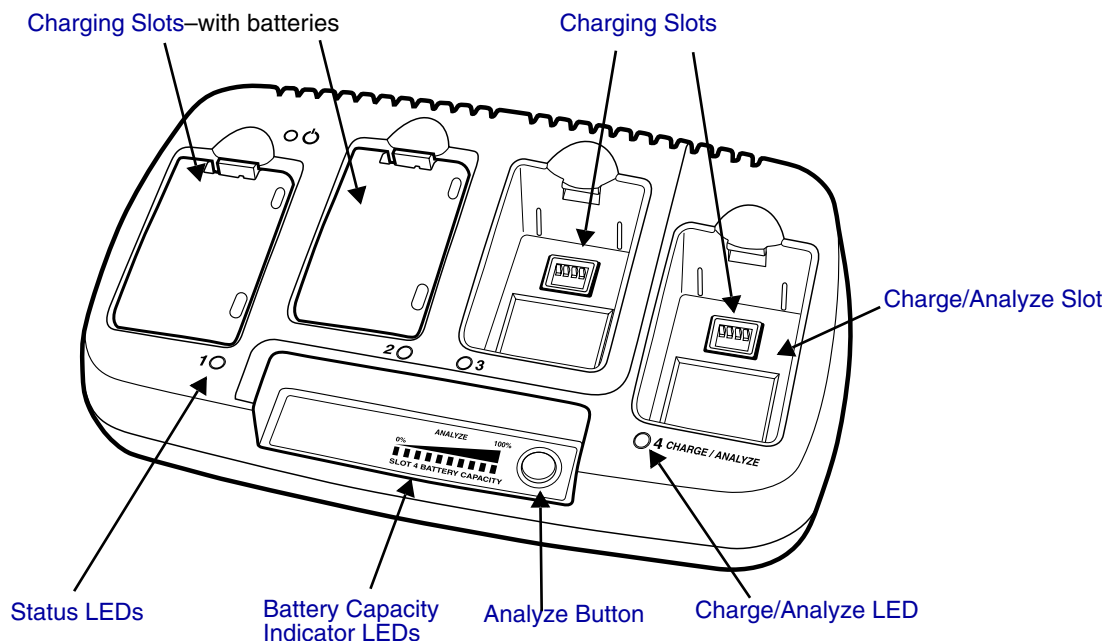

Charging Slots

The QuadCharger contains four charging slots. Each slot holds one battery. When a battery is placed in a slot, it immediately begins charging.

Charge/Analyze Slot

This is the fourth slot and the only one that can be used to analyze a battery. When a battery is placed in this slot, it begins charging just as it does in the other three slots. However, if you press the ANALYZE button, it runs the battery in this slot through the complete Analyze cycle. For more information, see [Using the Battery Analyzer](#) on page 11-4.

Battery Capacity Indicator LEDs

These LEDs give a readout of the remaining battery capacity after it has run through a complete analyze cycle. For more information, see [Battery Capacity Indicator LEDs](#) on page 11-1.

Analyze Button

Press this button to start a battery analyze cycle; see [Using the Battery Analyzer](#) on page 11-4.

Status LEDs

A status LED is located above each of the four battery slots. The color of the LED indicates the charge status of the batteries in its slot.

Green	The battery in the slot has completed its charge cycle and is ready to use.
Orange	The battery in the slot is being charged at a maximum charge rate.
Red	The battery in the slot encountered an error during the most recent charge cycle.

Back Panel

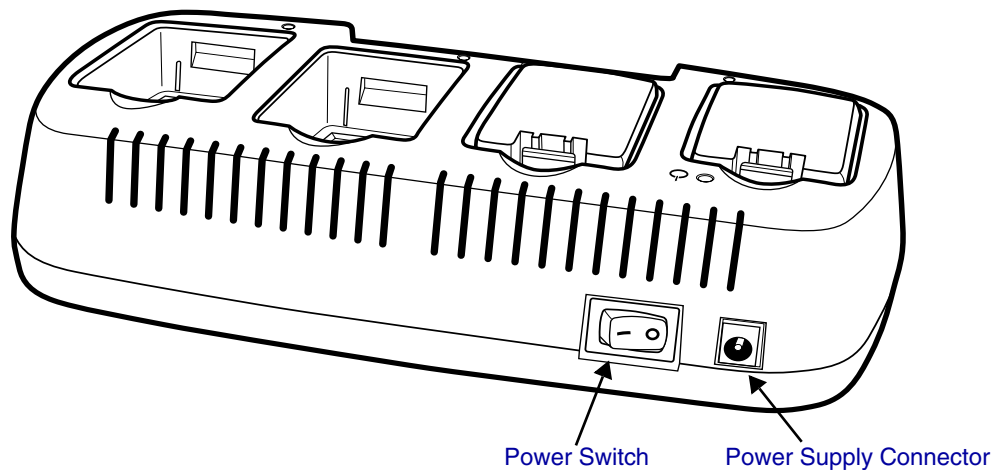

Power Supply Connector

Use this connector to attach the power supply to the QuadCharger. The universal power supply accepts input voltages between 90-265 volts.

Power Switch

Toggle the power switch to turn the QuadCharger on and off.

Inserting and Removing Battery Packs

To insert a battery pack, place the end of the battery without the locking tab into the bottom of the charging pocket and snap the battery into place with a hinging motion. The Status LED for that particular slot lights orange when the battery has been properly inserted. To remove a battery pack, push the locking tab down and pull the battery out from the charging slot with a hinging motion.

Supplying Power to the QuadCharger

Use the power adapter cable that comes with the QuadCharger so that the input voltage is adjusted appropriately.

1. Locate the AC power adapter cable and plug it into the power source.
2. Connect the power cable to the power adapter.
3. Connect the power cable to the supply connector on the back of the QuadCharger.
4. Press the power switch to the ON position.
The power LED lights green, and the charger performs a self-diagnostic test that lasts approximately five seconds.

Charging Batteries in the QuadCharger

For best results, battery packs should be at room temperature before recharging them because temperature impacts charging. The recommended temperature range is 50° to 95° F (10° to 35° C).

1. Supply the QuadCharger with power and turn the power switch on.
2. Insert batteries into the appropriate slots. The Status LED for each slot turns orange to indicate that the battery has begun a charge cycle.
3. When the Status LED turns green, the battery in the slot has completed charging.

Recommendations for Storing Batteries

To maintain top performance from batteries, follow these storage guidelines:

- Avoid storing batteries outside of the specified temperature range of -4° to 104° F (-20° to 40°C) or in extremely high humidity.
- For prolonged storage, do not keep batteries stored in a charger that is connected to a power source.

Using the Battery Analyzer

The battery analyzer is the fourth slot of the ChargeBase, labeled CHARGE/ANALYZE. This slot runs an Analyze cycle on the battery placed in it, which helps you monitor battery capacity over time.

Analyze Button

The Analyze cycle is initiated when a battery is placed in the Charge/Analyze slot and the **Analyze** button is pressed. In an Analyze cycle, batteries are completely discharged, then recharged to capacity. The battery is completely reset and re-calibrated. The amount of time required for a battery to complete the Analyze cycle depends on initial state of the battery's charge. Minimum time is **8 hours**, maximum time is **12 hours**.

Battery Capacity Indicator LEDs

These LEDs display the charge capacity of the battery at the end of the Analyze cycle. Battery capacity is displayed as a percentage of measured capacity/rated capacity where each LED equals 10% battery capacity. At the end of the Analyze cycle, these LEDs display the maximum charge level the battery can now hold.

Status LED

The Charge/Analyze slot also contains a standard status LED in the upper, left corner of the slot. When this slot is used for regular charging, this LED operates in the usual manner; see [Status LEDs](#) on page 11-2.

When this slot is being used to analyze a battery, its status LED functions as follows:

Solid Green	The battery has completed the Analyze cycle.
Flashing Orange	The battery is currently being analyzed.
Solid Red	The QuadCharger encountered an error during the Analyze cycle.

To Analyze a Battery

1. Insert the battery into the Charge/Analyze slot (the fourth).
2. Press the [Analyze Button](#) (page 11-1). The Status LED flashes orange to indicate that the analyzing cycle has begun.
3. Upon completion of the Analyze cycle, the Status LED lights solid green, and the Battery Capacity Indicator LEDs display the battery's capacity.



The QuadCharger is accumulating battery pack information during the entire Analyze cycle. Do NOT remove the battery until the cycle has been completed.

Bottom Panel

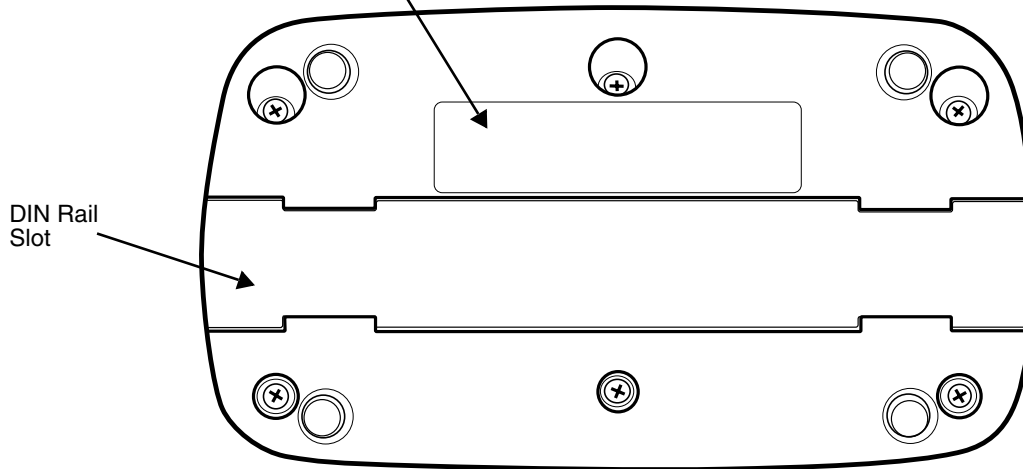
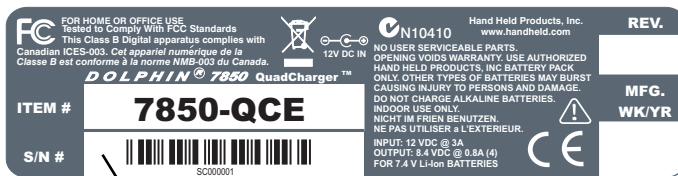

Mounting the QuadCharger

The QuadCharger should be on a dry, stable surface. To easily adapt the QuadCharger to your environment, it can be mounted on a flat, horizontal surface such as a desktop or workbench, or a flat, vertical surface such as a wall.

When choosing a location, always bear in mind that

- the mounting location must allow users easy access to power switch and power connector.
- the QuadCharger should be oriented so that users can easily insert and remove battery packs and read the labels, especially for the Battery Analyzer.

Using the DIN Rail

Most Dolphin peripherals have a DIN Rail (7.5 high X 35 wide mm) slot on the bottom panel to enable secure mounting.

To mount the QuadCharger, you slide the DIN Rail into the slot on the bottom panel. Then, using the appropriate nuts and bolts, secure the DIN rail to the desk or wall.

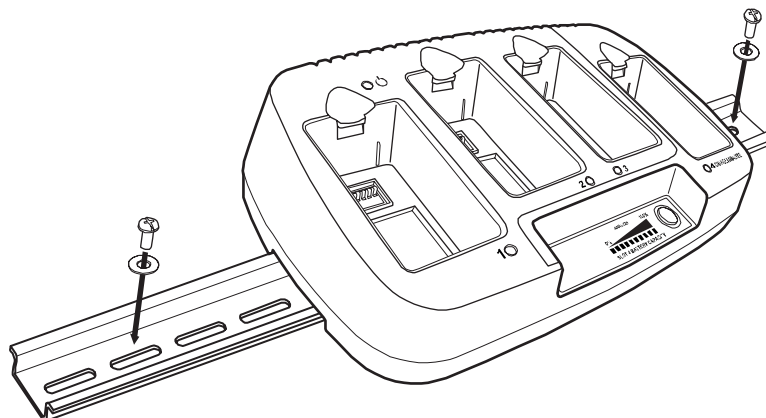

Troubleshooting

If you encounter problems with your QuadCharger, refer to chart below for possible solutions. If problems persist, please contact [Limited Warranty](#) (see page 13-3).

Problem	Issue
The Status LED does not come on when I insert a battery pack into the QuadCharger.	Check the power connections on the QuadCharger; make sure the POWER switch is ON and the battery pack is properly seated.
The Status LED lights red during charging.	Try to charge the battery in one of the other charging slots. If the Status LED lights red again, then the problem is associated with the battery pack.
The Status LED lights red and stays on without a battery in the charging slot.	An error occurred during the self-diagnostic test for that particular charging pocket. Call Hand Held Products Product Service and request an RMA. For additional warranty and return information, see Customer Support and Warranty on page 13-1.

Dolphin QuadCharger Technical Specifications

Structural	
Dimensions	11.7 in. long X 5.2 in. wide X 1.5 in. high (29.7 X 13.2 X 3.8 cm.)
Weight	18 oz. (510g)
Material	Case: Polycarbonate ABS blend
Color	Blue/Gray
Mounting	Use DIN rail slide to mount to a desktop or wall
Capacity	Supports 1 to 4 batteries
Environmental	
Operating Temperature	14° to 122°F (-10° to 50°C)
Storage Temperature	-4° to 158°F (-20° to 70°C)
Charge	32° to 113°F (0° to 45°C)
Electrical Static Discharge	8 KVA immunity on all surfaces
Humidity	90% relative humidity (non-condensing)
Power Supply	
Input (Universal)	90-265V, 47-63Hz
Output	12 Volts DC, 3 A
Input Connection	2 Position IEC 320-C8
Charging	
Standard Charge	Completes 100% charge in four hours
Status LED	See Status LEDs on page 11-2.
Battery Analyzer	See Using the Battery Analyzer on page 11-4.
Agency Approvals	
Power Supply	UL listed (UL 1950), TUV licensed (EN60 950STD) Power Supply compliant to FCC part 15 Class B
Charging	CE Marking (EMC); CISPR Pub 22, FCC Part 15 Class B
Fire Retardant	UL 94-VO

Cable Features

In addition to the hardware peripherals, the Dolphin 7850 Series offers several cables you can use with the terminal depending on what the needs of your work environment.

Intelligent Battery Charging

Dolphin terminals, peripherals, and cables are designed with an intelligent battery charging system that protects the battery from being damaged by overcharging. When a battery pack is fully charged, the charge process automatically switches to a trickle charge that maintains the battery at full capacity. As a result, Dolphin terminals may be connected to Dolphin cables indefinitely.

Voltage

All Dolphin power cables contain a power adapter that converts the voltage from the power source to 9.5 volts DC, which is the maximum voltage the terminal can receive.

Cables

There are several cables in the Dolphin 7850 Series.

Cable	Description	For more information, see...
Dolphin Power Cable	Charge-only cable that plugs into the DC Power Jack (see page 3-4) on the bottom of the pistol-grip handle.	Using the Dolphin Power Cable on page 12-2
Dolphin Mobile Charger	Charge-only cable that connects the terminal to a vehicle power outlet.	Using the Dolphin Mobile Charger on page 12-3
Dolphin Charge/Comm Cable	Charge/Communication cable that connects the terminal to an external power source and a host workstation, enabling you to power the terminal, charge the batteries, and transfer data at the same time.	Using the Dolphin Charge/Comm Cable on page 12-4



Use only the peripherals, power cables, and power adapters from Hand Held Products. Use of peripherals, cables, or power adapters not sold/manufactured by Hand Held Products will void the warranty and may damage the terminal.

Using the Dolphin Power Cable

The Dolphin Power Cable connects the terminal to an external power source via the DC jack on the bottom panel of the pistol-grip handle.

DC Power Jack

(Pull back the rubber flap to gain access to the power jack.)

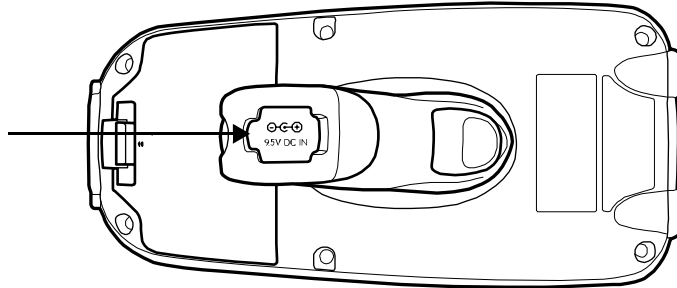

The Dolphin Power Cable contains a power adapter that converts the voltage from the power source to 9.5 volts DC, which is the maximum voltage the terminal can receive.

Using the Dolphin Power Cable

1. Set the terminal down on its rubber bumpers; see [Rubber Bumpers](#) on page 3-7.

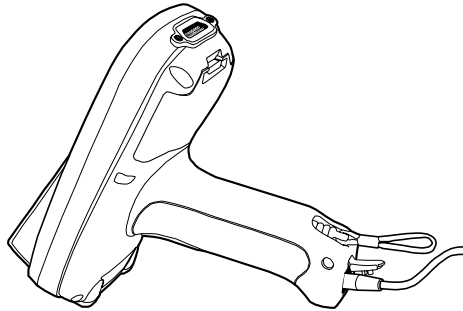

2. Pull back the flap of the DC power jack and plug the power cable into the jack.
3. Plug the power adapter into a standard power outlet.

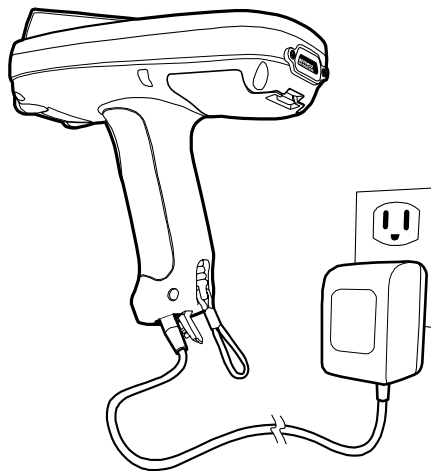

4. The terminal switches to external power and the main battery begins charging. The terminal is ready for use.

Using the Dolphin Mobile Charger

The Dolphin Mobile Charger connects the terminal to a vehicle power source. This cable powers the terminal and charges the main battery pack.

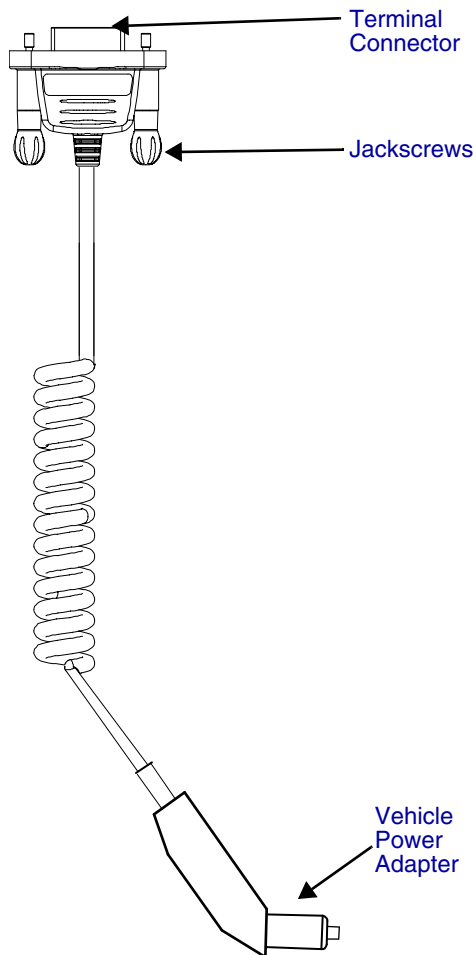

Terminal Connector

The terminal connector connects the communication cable to the mechanical connector (see [Mechanical Connector](#) on page 3-8) on the terminal. The pins in this connector work only with the mechanical connector on the terminal.

Jackscrews

The jackscrews secure the terminal connector to the mechanical connector on the terminal. Once the terminal connector is plugged into the mechanical connector on the bottom panel of the terminal, turn both jackscrews to the right to secure the connection.

Vehicle Power Adapter

The vehicle power adapter plugs into a standard vehicle power source and converts voltage to the 9.5 volts DC required by the terminal.

Using the Dolphin Mobile Charger Inside a Vehicle

Using the Dolphin Mobile Charger in combination with the Dolphin Mobile Mount powers and secures the terminal inside a vehicle.

1. Insert the terminal into the Mobile Mount.
2. Install the Mobile Mount inside the vehicle.
3. Plug the [Terminal Connector](#) (see page 12-3) of the Dolphin Mobile Charger into the mechanical connector on the bottom panel of the terminal.
4. Tighten the [Jackscrews](#) (see page 12-3).
5. Plug the [Vehicle Power Adapter](#) (see page 12-3) into the vehicle power outlet.

Note: Dolphin terminals contain an intelligent battery charging system that monitors the charging of the battery pack to protect the battery from damage by overcharging if left connected to a charging peripheral indefinitely.

Using the Dolphin Charge/Comm Cable

The Dolphin Charge/Comm cable charges the Dolphin terminal and communicates with a host workstation. There are three connectors: one connects the terminal to an external power source, another to the host workstation, and another to the terminal itself.

The charge/comm cable is actually two cables: a power cable and a communication cable. The communication cable is shown below.

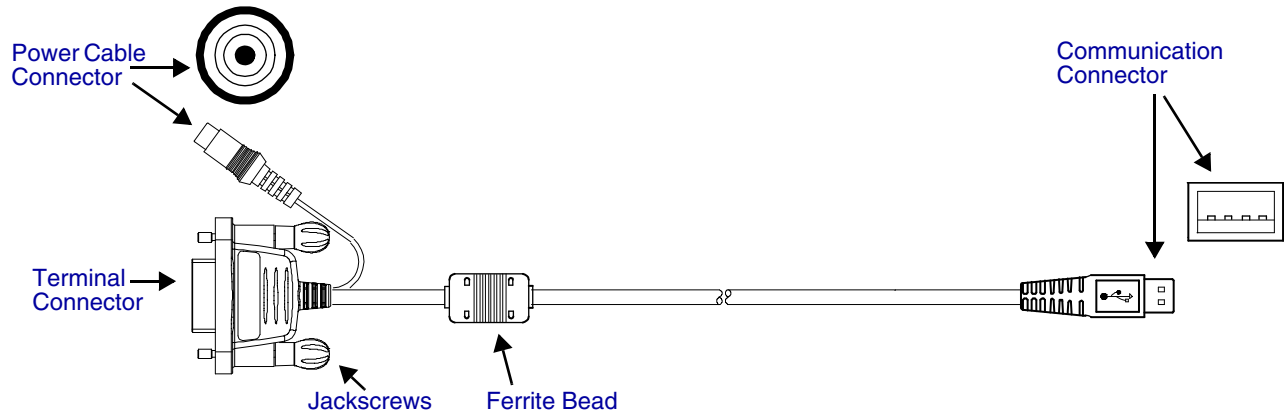

Communication Connector

The communication connector connects the terminal to a host device via USB (v1.1 or higher) or RS-232; USB is shown above. Plug this connector directly into a host workstation, then establish [ActiveSync Communication](#) (see page 12-5).

The USB plug has four pins and fits into standard desktop computers and laptops.

Ferrite Bead

This is a Urite ferrite bead.

Jackscrews

The jackscrews secure the terminal connector to the mechanical connector on the terminal. Once the terminal connector is plugged into the mechanical connector on the bottom panel of the terminal, turn both jackscrews to the right to secure the connection.

Power Cable Connector

The power cable connector connects the charge cable to the power cable. The power cable powers the terminal and charges the main battery pack.

The power adapter on the power cable is available in US, UK, and EMEA versions. All version convert the voltage from the power source to 9.5 volts DC, which is the maximum voltage the terminal can receive.

Terminal Connector

The terminal connector connects the communication cable to the [Mechanical Connector](#) (see page 3-8) on the bottom panel of the terminal. The pins in the terminal connector work only with the mechanical connector on the terminal.

After connecting the pins, secure the cable to the terminal by turning both jackscrews to the right.

Using the Dolphin Charge/Comm Cable

1. Plug the cable's terminal connector into the mechanical connector on the bottom panel of the terminal.
2. Tighten the jackscrews.
3. Plug the power cable connector into the power cable.
4. Plug the power adapter on the power cable into a standard power outlet.
5. Plug the communication connector into the host workstation.
6. Establish the [ActiveSync Communication](#) (see page 12-5).

ActiveSync Communication

After the terminal is connected to a power source and the host workstation, you need to set up both the terminal and the host workstation for ActiveSync communication.

Setting up ActiveSync for the charge/comm cable is the same as for the HomeBase, which also has a USB and an RS-232 version. For details, see [Using ActiveSync](#) on page 7-3.

Default ActiveSync Communication Values

The default workstation synchronization value for USB communication is '**USB Connection**'.

The default workstation synchronization value for RS-232 communication is '**115200 Default**'.



Technical Assistance

If you need assistance installing or troubleshooting, please call your Distributor or the nearest Hand Held Products technical support office:

North America/Canada

Telephone: (800) 782-4263
Fax number: (315) 554-6705
E-mail: natechsupport@handheld.com

Latin America

Telephone: (803) 835-8000
Telephone: (800) 782-4263
E-mail: latechsupport@handheld.com

Brazil

Telephone: +55 (21) 2178-0500
Fax: +55 (21) 2178-0505
E-mail: brsuporte@handheld.com

Mexico

Telephone: (803) 835-8000
E-mail: latechsupport@handheld.com

Europe, Middle East, and Africa

Telephone: +31 (0) 40 7999 393
Fax: +31 (0) 40 2425 672
E-mail: eurosupport@handheld.com

Asia Pacific

Telephone - Hong Kong: +852-3188-3485 or 2511-3050
Telephone - China: +86 21 6361 3818
E-mail: aptechsupport@handheld.com

Japan

Telephone: +813 5770-6312
E-mail: aptechsupport@handheld.com

Online Technical Assistance

You can also access technical assistance online at www.handheld.com.

For Further Information

To download the full User's Guide for these products, visit our website at www.handheld.com.

Product Service and Repair

Hand Held Products provides service for all its products through service centers throughout the world. To obtain warranty or non-warranty service, return the unit to Hand Held Products (postage paid) with a copy of the dated purchase record attached. Contact the appropriate location below to obtain a Return Material Authorization number (RMA #) before returning the product.

North America

Telephone: (800) 782-4263
Fax: (803) 835-8012
E-mail: naservice@handheld.com

Latin America

Telephone: (803) 835-8000
Telephone: (800) 782-4263
Fax: (239) 263-9689
E-mail: laservice@handheld.com

Brazil

Telephone: +55 (21) 2178-0500
Fax: +55 (21) 2178-0505
E-mail: brservice@handheld.com

Mexico

Telephone: +52 (55) 5203-2100
Fax: +52 (55) 5531-3672
E-mail: mxservice@handheld.com

Europe, Middle East, and Africa

Telephone: +31 (0) 40 2901 633
Fax: +31 (0) 40 2901 631
E-mail: euservice@handheld.com

Asia Pacific

Telephone: +852-2511-3050
Fax: +852-2511-3557
E-mail: apservice@handheld.com

Japan

Telephone: +813-5770-6312
Fax: +813-5770-6313
E-mail: apservice@handheld.com

Online Product Service and Repair Assistance

You can also access product service and repair assistance online at www.handheld.com.

Limited Warranty

Hand Held Products, Inc. ("Hand Held Products") warrants its products to be free from defects in materials and workmanship and to conform to Hand Held Products' published specifications applicable to the products purchased at the time of shipment. This warranty does not cover any Hand Held Products product which is (i) improperly installed or used; (ii) damaged by accident or negligence, including failure to follow the proper maintenance, service, and cleaning schedule; or (iii) damaged as a result of (A) modification or alteration by the purchaser or other party, (B) excessive voltage or current supplied to or drawn from the interface connections, (C) static electricity or electro-static discharge, (D) operation under conditions beyond the specified operating parameters, or (E) repair or service of the product by anyone other than Hand Held Products or its authorized representatives.

This warranty shall extend from the time of shipment for the duration published by Hand Held Products for the product at the time of purchase ("Warranty Period"). Any defective product must be returned (at purchaser's expense) during the Warranty Period to Hand Held Products' factory or authorized service center for inspection. No product will be accepted by Hand Held Products without a Return Materials Authorization, which may be obtained by contacting Hand Held Products. In the event that the product is returned to Hand Held Products or its authorized service center within the Warranty Period and Hand Held Products determines to its satisfaction that the product is defective due to defects in materials or workmanship, Hand Held Products, at its sole option, will either repair or replace the product without charge, except for return shipping to Hand Held Products.

EXCEPT AS MAY BE OTHERWISE PROVIDED BY APPLICABLE LAW, THE FOREGOING WARRANTY IS IN LIEU OF ALL OTHER COVENANTS OR WARRANTIES, EITHER EXPRESSED OR IMPLIED, ORAL OR WRITTEN, INCLUDING, WITHOUT LIMITATION, ANY IMPLIED WARRANTIES OF MERCHANTABILITY OR FITNESS FOR A PARTICULAR PURPOSE.

HAND HELD PRODUCTS' RESPONSIBILITY AND PURCHASER'S EXCLUSIVE REMEDY UNDER THIS WARRANTY IS LIMITED TO THE REPAIR OR REPLACEMENT OF THE DEFECTIVE PRODUCT. IN NO EVENT SHALL HAND HELD PRODUCTS BE LIABLE FOR INDIRECT, INCIDENTAL, OR CONSEQUENTIAL DAMAGES, AND, IN NO EVENT, SHALL ANY LIABILITY OF HAND HELD PRODUCTS ARISING IN CONNECTION WITH ANY PRODUCT SOLD HEREUNDER (WHETHER SUCH LIABILITY ARISES FROM A CLAIM BASED ON CONTRACT, WARRANTY, TORT, OR OTHERWISE) EXCEED THE ACTUAL AMOUNT PAID TO HAND HELD PRODUCTS FOR THE PRODUCT. THESE LIMITATIONS ON LIABILITY SHALL REMAIN IN FULL FORCE AND EFFECT EVEN WHEN HAND HELD PRODUCTS MAY HAVE BEEN ADVISED OF THE POSSIBILITY OF SUCH INJURIES, LOSSES, OR DAMAGES. SOME STATES, PROVINCES, OR COUNTRIES DO NOT ALLOW THE EXCLUSION OR LIMITATIONS OF INCIDENTAL OR CONSEQUENTIAL DAMAGES, SO THE ABOVE LIMITATION OR EXCLUSION MAY NOT APPLY TO YOU.

All provisions of this Limited Warranty are separate and severable, which means that if any provision is held invalid and unenforceable, such determination shall not affect the validity of enforceability of the other provisions hereof.

Hand Held Products extends these warranties only to the first end-users of the products. These warranties are non-transferable.

The limited duration of the warranty for the Dolphin 7850 Series is as follows:

- Terminals with an integrated imager are covered by a two-year limited warranty.
- Batteries are covered by a one-year limited warranty.
- Dolphin HomeBase, Dolphin QuadCharger, and Dolphin Mobile Charger are covered by a one-year limited warranty.

Use of any battery not sold/manufactured by Hand Held Products may damage the terminal and/or the battery and will void the warranty. Batteries returned to Hand Held Products in a reduced state may or may not be replaced under this warranty. Battery life will be greatly increased when following the battery instructions in the Dolphin 7850 Series User's Guide.

Use of any peripheral not manufactured/sold by Hand Held Products will void the warranty. This includes but is not limited to: cables, power supplies, cradles, and docking stations.

Use only power adapters approved for use by Hand Held Products. Failure to do so may result in improper operation or damage to the unit and will void the warranty.

How to Extend Your Warranty

Hand Held Products offers a variety of service plans on our hardware products. These agreements offer continued coverage for your equipment after the initial warranty expires. For more information, contact your Sales Representative, Customer Account Representative, or Product Service Marketing Manager from Hand Held Products, or your Authorized Reseller.



Hand Held Products, Inc.

700 Visions Drive

P.O. Box 208

Skaneateles Falls, NY 13153-0208