

**PLEASE GO TO THE PAGE 34 FOR FCC/IC AGENCY STATEMENTS**

**Lyric™** Gateway

Installation and Reference Guide



Ref: LCP300-L/LCP300-LC

800-21666 10/16 Rev. A

**Honeywell**

## RECOMMENDATIONS FOR PROPER PROTECTION

The Following Recommendations for the location of fire and burglary detection devices help provide proper coverage for the protected premises.

### Recommendations for Smoke and Heat Detectors

With regard to the number and placement of smoke/heat detectors, we subscribe to the recommendations contained in the National Fire Protection Association's (NFPA) Standard #72 noted below.

- Early warning fire detection is best achieved by the installation of fire detection equipment in all rooms and areas of the household as follows: For minimum protection a smoke detector should be installed outside of each separate sleeping area, and on each additional floor of a multi-floor family living unit, including basements. The installation of smoke detectors in kitchens, attics (finished or unfinished), or in garages is not normally recommended.
- For additional protection the NFPA recommends that you install heat or smoke detectors in the living room, dining room, bedroom(s), kitchen, hallway(s), attic, furnace room, utility and storage rooms, basements and attached garages.

In addition, we recommend the following:

- Install a smoke detector inside every bedroom where a smoker sleeps.
- Install a smoke detector inside every bedroom where someone sleeps with the door partly or completely closed. Smoke could be blocked by the closed door. Also, an alarm in the hallway outside may not wake up the sleeper if the door is closed.
- Install a smoke detector inside bedrooms where electrical appliances (such as portable heaters, air conditioners or humidifiers) are used.
- Install a smoke detector at both ends of a hallway if the hallway is more than 40 feet (12 meters) long.
- Install smoke detectors in any room where an alarm control is located, or in any room where alarm control connections to an AC source or phone lines are made. If detectors are not so located, a fire within the room could prevent the control from reporting a fire or an intrusion.

THIS CONTROL COMPLIES WITH NFPA REQUIREMENTS FOR TEMPORAL PULSE SOUNDING OF FIRE NOTIFICATION APPLIANCES.

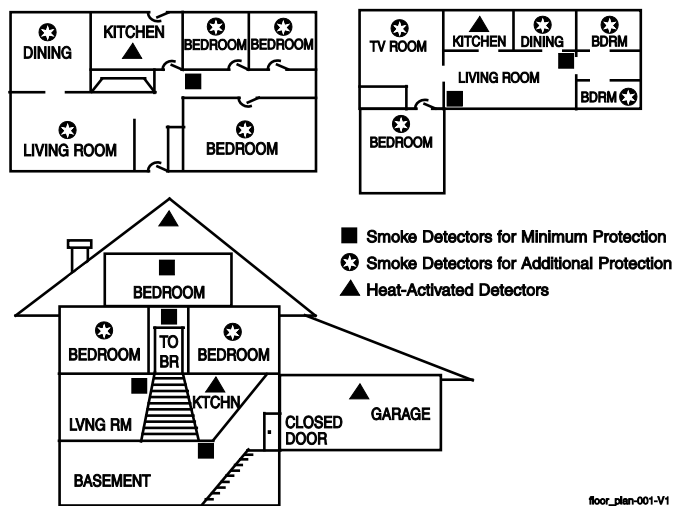

### Recommendations for Proper Intrusion Protection

- For proper intrusion coverage, sensors should be located at every possible point of entry to a home or premises. This would include any skylights that may be present, and the upper windows in a multi-level building.
- In addition, we recommend that radio backup be used in a security system. This will ensure that alarm signals can be sent to the alarm monitoring station in the event that the communications are out of order (if connected to an alarm monitoring station).

This Honeywell security system is designed for use with devices manufactured or approved by Honeywell for use with the system. The security system is not designed for use with any device that may be attached to the system's control or other communicating bus if Honeywell has not approved such device for use with the system. Use of any such unauthorized device may cause damage or compromise the performance of the security system and affect the validity of the end user's Honeywell limited warranty. When you install devices that have been manufactured or approved by Honeywell, you give the end user the assurance that these devices have been thoroughly tested to ensure optimum performance when used with this Honeywell security system.

## Table of Contents

<b>System Features</b> .....	5
<b>Installing the Control</b> .....	7
Battery Installation.....	7
Battery Selection.....	7
Installing the Rechargeable Backup Battery.....	7
Replacing the Rechargeable Backup Battery.....	7
Wall Mounting.....	8
Desktop Mounting.....	9
Replace the Back Plate.....	9
Install the Desk Stand.....	9
AC Power.....	10
Wiring Overview.....	10
Make Electrical Connections.....	10
Communications Modules.....	11
Communications Module 24-Hour Standby power.....	11
Install and Configure Communications Module.....	11
Installing the Cellular Module.....	11
Checking Signal Strength.....	12
<b>Wireless Zones</b> .....	13
General Information.....	13
Zones.....	13
Range.....	13
Transmitters.....	13
House Identification.....	13
Transmitter Supervision.....	13
Transmitter Input Types.....	13
Transmitter Battery Life.....	13
RF Transmitter Loop Numbers.....	14
<b>Mechanics of Programming</b> .....	15
Navigating Menus.....	15
Touch-screen Display.....	15
Navigation Keys.....	16
Home Screen.....	16
Security Screen.....	17
Master User Tools Screen.....	17
Programming.....	18
Enter Installer Programming Mode.....	18
Loading Factory Defaults.....	19
Select a Default Configuration.....	19
Exit Programming Mode.....	19
<b>Zone Response Type Definitions</b> .....	20
General Information.....	20
<b>System Operation</b> .....	22
Key/Touchscreen Operation.....	22
Panic Key/Icons.....	22
Security Codes.....	22
Installer Code.....	22
Master Code.....	22
Enter/Change the Master Code by Installer.....	22
Secondary User Codes.....	22
Reset Master Code.....	23
Security Code Notes.....	23
System Displays.....	24
Zone Status Displays.....	24
Audio Alarm Verification (Two-Way Voice Feature).....	25
Activation.....	25
Operator Commands.....	25
Event Log.....	26
Contact ID Event Log Codes.....	26
Central Station Messages.....	27
<b>Testing the System</b> .....	28

## **Table of Contents (Continued)**

Test Modes .....	28
Testing the System.....	28
Armed System Test .....	28
Zone Discovery Mode .....	29
Rebooting the System .....	29
<b>Programming Default Values</b> .....	30
Zone Assignment/Alarm Response Type for Configuration 1.....	32
Zone Assignment/Alarm Response Type for Configuration 2 .....	33
Zone Assignment/Alarm Response Type for Configuration 3 and 4 .....	34
<b>Zone Response Type Matrix</b> .....	35
<b>Regulatory Agency Statements</b> .....	36
<b>Limitations of this System Statement</b> .....	37
<b>Agency Notices</b> .....	38
<b>SIA Quick Reference Guide</b> .....	39
<b>Specifications</b> .....	39
<b>Glossary</b> .....	40
<b>Contacting Technical Support</b> .....	41
<b>Index</b> .....	42
<b>Summary of Connections Diagram</b> .....	43
<b>Warranty Information</b> .....	Rear Cover

### **Lyric™ Lock**

This system supports Lyric Lock, an advanced feature designed to keep it functioning optimally. Lyric Lock capabilities include: the ability to interact with Honeywell and your company's network for the setup and programming of system features, support for remote software updates and the ability (when enabled) to enhance the end user's security by preventing unauthorized takeover of the system by another monitoring company.

In the event that the end user wishes to authorize another company to take over the system, the end user may request that Honeywell remotely disable Lyric Lock. Honeywell will require documentation that the end user has attempted to contact your company three times and that your company has failed to respond, or failed to agree to the end user's request.

## System Features

The Lyric Gateway is a self-contained, rechargeable wireless control/communicator that features easy installation and usage. A built-in speaker provides voice annunciation of system status along with voice descriptors of each zone. An internal module allows the controller to communicate with the Central Station via the Internet or (if installed) Cellular Wireless.

**ETL** Lyric Gateway is not intended for UL985 Household Fire applications unless a 24-hour backup battery (p/n 300-03866-AIO) is installed.

### System Features

- Message Center (for user recorded messages)
- Voice Announcement of System and Zone Status
- Ten User-selectable Chime Sounds
- Automatic Stay Arming
- Night Stay Arming
- 49 User Codes (Installer, Master, Guest, Duress)
- Panic Functions (Police, Fire, Medical)
- Programmable Reminders
- Video Camera Control (requires WiFi connection)
- Supports Mobile Devices (Tablet, iPad, etc.) that duplicate functions of the Lyric Gateway (i.e.; Security, Web Content Home Automation and Video Control)

### Home Automation

- Integrated Z-Wave Support
- Control up to 72 Z-Wave Home Automation Devices including:
  - Thermostats (up to 8)
  - Door Locks (up to 6)
  - Devices (outlets, switches, lamps/appliances) (up to 60)
  - Garage Doors (up to 4)
  - Water Valves (up to 4)
- Supports Z-Wave Network Wide Inclusion (NWI) Mode
- 100 programmable Smart Actions
- Up to 150 scheduled events

### Zones and Devices

- 4 Panel Panic Zones
- 64 Wireless Zones (5800 and SiX™ Series transmitters)
- Four Garage Door Zones
- 32 Wireless Buttons (Wireless Key) Zones (5800 and SiX™ Series transmitters)
- Eight (SiX™ Series) Wireless Keypad Zones
- 12 Temperature Zones
- Resident Monitor Zone Types
- Built-in Case Tamper

### Communication

- ADEMCO Contact ID
- Integrated WiFi Support
- Cellular (GSM or CDMA) Central Station communication
- WiFi Central Station communication
- Ethernet Central Station communication
- Two-way Voice Communication
- Supports AlarmNet 360™ Remote Services

## System Features (Continued)

### System Power

- Primary Power: Plug-in Power Supply, 110VAC to 9VDC, 2.5A output p/n 300-04705V1 (300-4063V1 in Canada)
- Backup Battery: Rechargeable Nickel-metal Hydride Battery Pack rated at 7.2Vdc. (p/n 300-03864-AIO or 300-03866-AIO)

### Alarm Output

- Built-in Sounder
- Steady Output for burglary/panic
- Temporal (3) Pulse Output for fire alarms
- Temporal (4) Pulse Output for carbon monoxide alarms
- Audio Alarm Verification (AAV)

### Programming

- Options stored in EEROM
- Can be uploaded, downloaded or controlled via AlarmNet 360™ using capable Cellular or WiFi Communications Module
- **Flash Downloading**

### Other Features

- Exit Error feature (detects difference between an actual alarm and exit alarm caused by leaving a door open after the exit delay expires)
- **Event Log Storage (total 6,000 events)**
- RF Jam Detection
- Advanced Protection Logic™ (APL) (Minimizes the likelihood of the system being disabled before notification can be sent to the Central Station indicating that the premises have been compromised.)
- **Lyric™ Lock (Customer Retention Logic) Dealer selectable Lockout (anti-takeover) feature**
- Dealer/Central Station Messages (requires Total Connect Service)

## Installing the Gateway

### Battery Installation

The Lyric Gateway is equipped with an integral, replaceable, rechargeable battery pack rated at 7.2Vdc. In the event of an AC power loss, the system is supported by the long life backup battery that is supervised for connection and for low voltage conditions. If the battery is missing, or a low battery condition is detected, a “low battery” message is displayed on the smart device and “Alert” will flash red on the Gateway. In addition, a System Low Battery report is sent to the Central Station. In addition, the system will beep once every 45 seconds to audibly indicate a low battery condition (press any key to stop the beeping). Select the appropriate battery pack, based on the installation’s requirement, and install the battery pack. Follow the steps and refer to the figure below to install and connect the battery.

### Battery Selection

Select the appropriate battery pack, based on the installation’s requirement, and install the battery pack.

Battery Part Number	Battery StandbyTime	Low Battery Notification
300-03864-AIO	4-hours (minimum)	Approximately 1-hour before battery depletion
300-03866-AIO	24-hours (minimum)	At least 1-hour before battery depletion

### Replacing the Rechargeable Backup Battery

1. Insert the battery pack into gateway.
2. Close the hinged battery retainer.
3. Connect the battery pack connector to the receptacle on the gateway.
4. Align the slots on the back of the controller with the hooks on the rear cover/wall mount as shown below.
5. Once attached, insert the screw to secure the rear cover/wall mount.
6. Plug the power supply into a 24-hour, 110VAC unswitched outlet. Upon power-up, the LEDs will flash alternately.
7. When the power-up sequence is complete, the green Disarmed LED and the green shield will be lit.

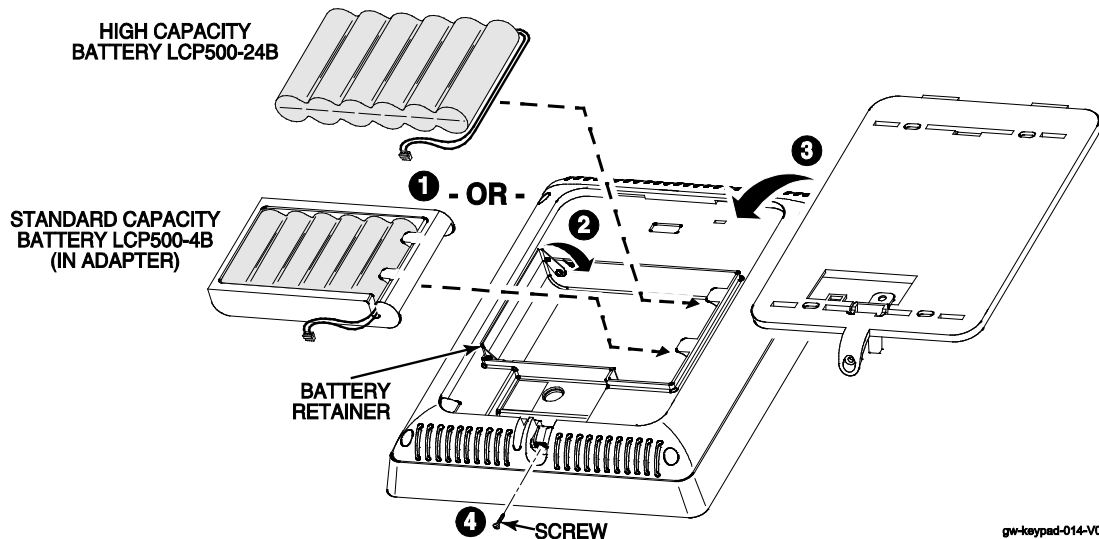

Rechargeable batteries may take up to 48-hours to fully charge. The “Low Battery” message should clear within four hours or by entering Test Mode.

### Replacing the Rechargeable Backup Battery

1. When battery replacement is required, at the Master User Tools Menu screen select the “Advanced” icon.
2. Select “Install Backup Battery” and follow the displayed steps to replace the battery or follow the steps below.

#### Remove the battery

1. Remove the screw securing the gateway to the rear cover/wall mount (if used).
2. Remove the back case or remove the gateway from the rear cover/wall mount.

## Installing the Gateway (Continued)

3. Disconnect the battery pack connector from the receptacle on the back of the gateway.
4. Open the hinged battery retainer.
5. Remove the battery pack from the Gateway.

### Install the replacement battery

1. Install a replacement battery pack (LCP500-4B [p/n 300-03864-AIO] OR LCP500-24B [p/n 300-03866-AIO]) into the gateway.
2. Close the hinged battery retainer.
3. Connect the battery pack connector to the receptacle on the gateway.
4. Align the slots on the back of the controller with the hooks on the rear cover/wall mount as shown below.
5. Once attached, insert the screw to secure the rear cover/wall mount.
6. Plug the power supply into a 24-hour, 110VAC unswitched outlet. Upon power-up, the LEDs will flash alternately.
7. When the power-up sequence is complete, the green Disarmed LED and the green shield will be lit.

**NOTE:** If a Cellular Communication Module is being installed, verify the module's signal strength before selecting a final mounting location. Refer to *Checking the Signal Strength* in the Communications Module section.

## Wall Mounting

**NOTE:** When selecting a location for the Lyric Controller, be sure to provide a separation of at least 10 feet between 2.4GHz devices such as Wi-Fi Routers/Access Points.

For wall mounting follow the steps and refer to the figure below.

1. Feed the field wiring through the appropriate openings in the wall mount.
2. Attach the wall mount to a sturdy wall using the four provided screws.
3. If required, install an additional mounting screw in the case tamper.
4. Align the slots on the back of the controller with the hooks on the wall mount as shown below.
5. Once attached, insert the screw to secure the Lyric to the wall mount.

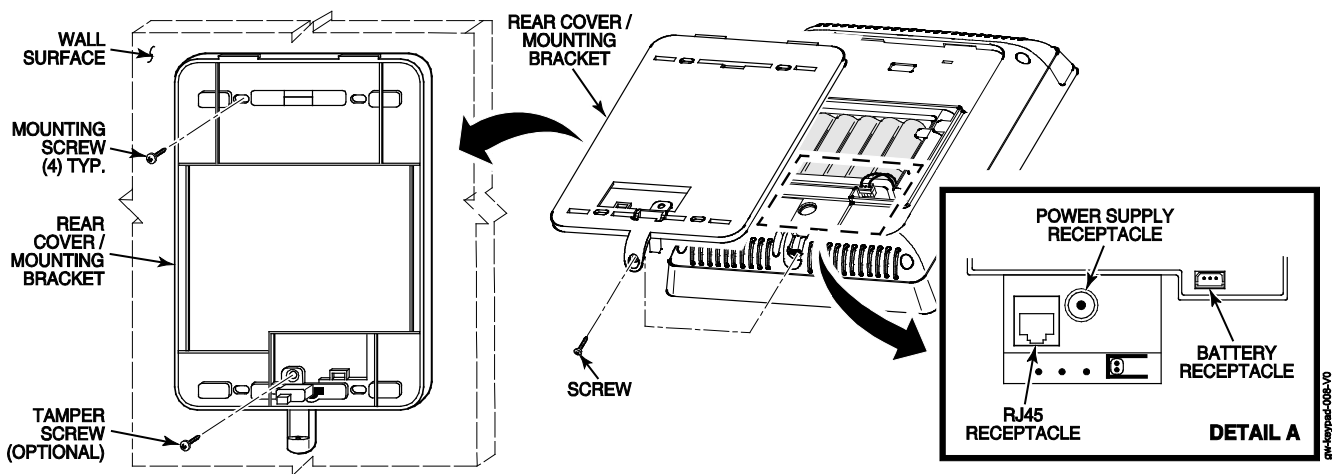



## Installing the Gateway (Continued)

### Desktop Mounting

**NOTE:** When selecting a location for the Lyric Gateway, be sure to provide a separation of at least 10 feet between 2.4GHz devices such as Wi-Fi Routers/Access Points.

The desk Stand can be installed in two positions that provide a viewing angle of 30 degrees or 60 degrees. Follow the steps and refer to the figures below.

#### Install Desk Stand

1. Align the slots on the back of the gateway with the hooks on the desk stand as shown below.
2. Insert the stand into the slots on the rear case to provide the desired viewing angle and slide up to lock in place.

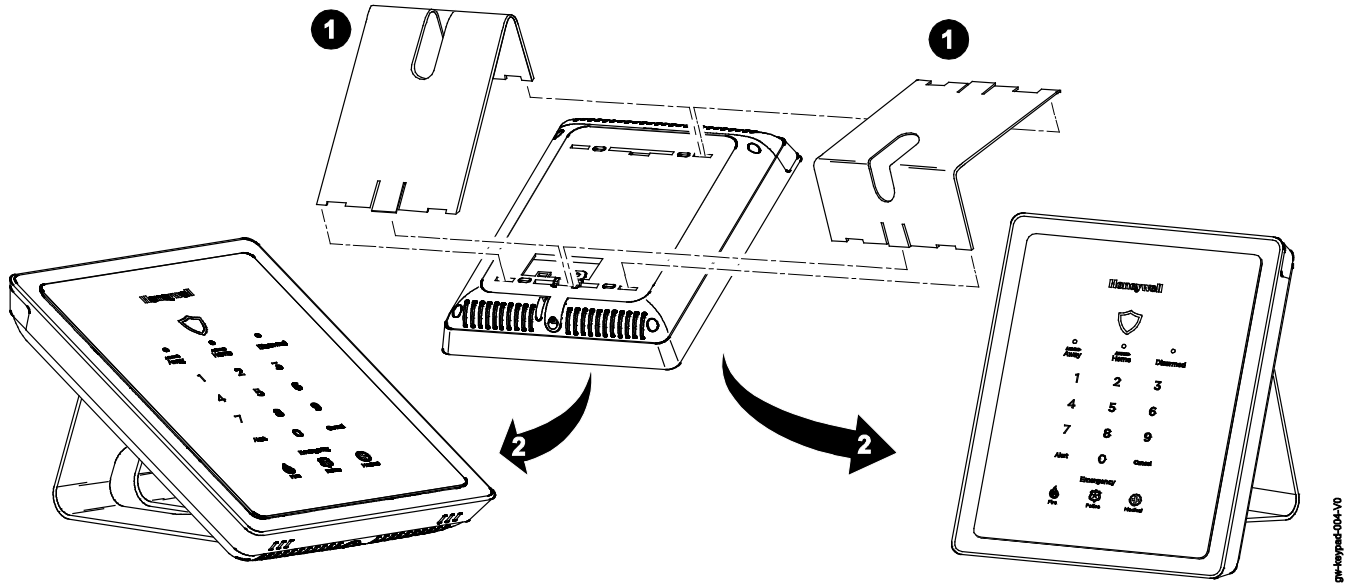

## Installing the Control (Continued)

### AC Power

The Lyric Gateway is powered by a 110VAC, 60 Hz/9 Volt DC, 2.5 Amp Plug-in Power Supply, 300-04705V1 (300-04063V1 in Canada). Refer to the wiring table below for wire gauge and length.



**Use only the 300-04705V1 (300-04063V1 Canada) Power Supply. Do not plug the power supply into the AC outlet until after all wiring connections have been made.**

### Wiring Overview

The following summarizes the electrical connections associated with the Lyric Gateway. Follow the steps and refer to the figure below when making connections. Refer to the Summary of Connections diagram for additional information.

#### Make Electrical Connections

1. Temporarily hang the controller from the hook on the wall mount.
2. Connect the male end of the receptacle on the Gateway.
3. Align the slots on the back of the Gateway with the hooks on the rear cover/mounting bracket.
4. Once attached, insert the screw to secure the Gateway to the rear cover/mounting bracket .
5. Connect the flying leads of the provided power supply cable to the + and - terminals on the power supply (p/n 300-04705V1 or 300-04063V1).
6. Plug the power supply into a 24-hour, 110VAC unswitched outlet. Upon power-up, the "System Standby!" screen will be displayed.

**WIRING TABLE**

Maximum Distance Between Power Supply and Controller	Wire Gauge
Up to 8 feet (2.44 m)	# 22
Up to 13 feet (3.96 m)	# 20
Up to 20 feet (6.1 m)	# 18

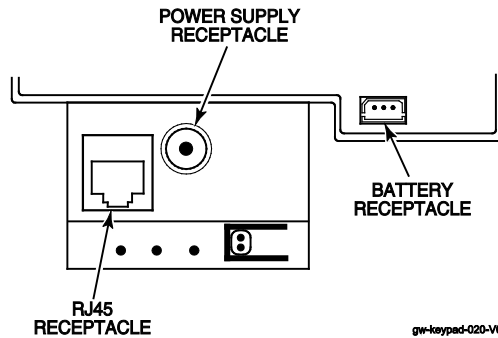

## Installing the Gateway (Continued)



The LYRIC-CDMA Communications Module is only available in the continental United States, Alaska and Hawaii.

### Communication Modules

The Lyric Gateway supports Central Station reporting using wireless/cellular and WiFi communications devices. They also support upload/download programming capability via the Internet. This allows site maintenance independent of Central Station monitoring, and modification to sites globally via the Internet. Refer to the Quick Installation Guide (p/n 800-21668) for information regarding programming and registration. Additionally, an internal Z-Wave module allows the Lyric Gateway to support Home Automation functions. (refer to the Gateway Guide (p/n 800-16078 for additional information.) The controllers are compatible with the following AlarmNet Communication Modules:

Model	Description
LYRIC-3G	GSM Cellular Communications Module
LYRIC-CDMA	CDMA Cellular Communications Module

### Communications Module 24-Hour Standby Power

If 24-hour standby is required, the Super High Capacity battery (p/n 300-03866-AIO) must be installed.



#### RF Exposure

**WARNING:** The Lyric Gateway must be installed to provide a separation distance of at least 7.8 in (20 cm) from all persons and not co-located or operated in conjunction with any other transmitter except in accordance with FCC multi-transmitter product procedures.

### Install and Configure Communication Module

Follow the steps and refer to the figure below to install the Communications Module.

#### Installing the Cellular Communications Module

1. At the Master User Tools Menu Programming screen select "Advanced".
2. Select "Install Cellular Module" and follow the prompts displayed on the smart device or follow the steps below.
3. Remove Gateway upper cover (bezel).
4. Remove the screw securing the module to the Gateway (if installed).
5. Remove the existing Cellular Communications Module (if installed).
6. Install the Cellular Communications Module into the Gateway.
7. Ensure that the Communications Module is properly seated into the Gateway and secure the module with the provided screw (if required).
8. Insert the cover (bezel) into the Gateway
9. Slide the side cover (bezel) down to lock it in place and secure the Communications Module.
10. Select OK to complete the installation.

**NOTE:** The Communication Path will be dynamically adjusted when a Cellular Communication Module is installed or removed.

11. Enable the Communications Module, configure alarm reporting and module supervision and register the device. Refer to the "Program Communicator" and "Communications Diagnostics" sections in the Programming Guide (p/n 800-18077). OR Log on to the AlarmNet 360™ website (<http://alarmnet360.com>).



**The Communications Module must be registered with AlarmNet 360™ before downloading or alarm reporting can take place.**

## Installing the Gateway (Continued)

### Communication Modules

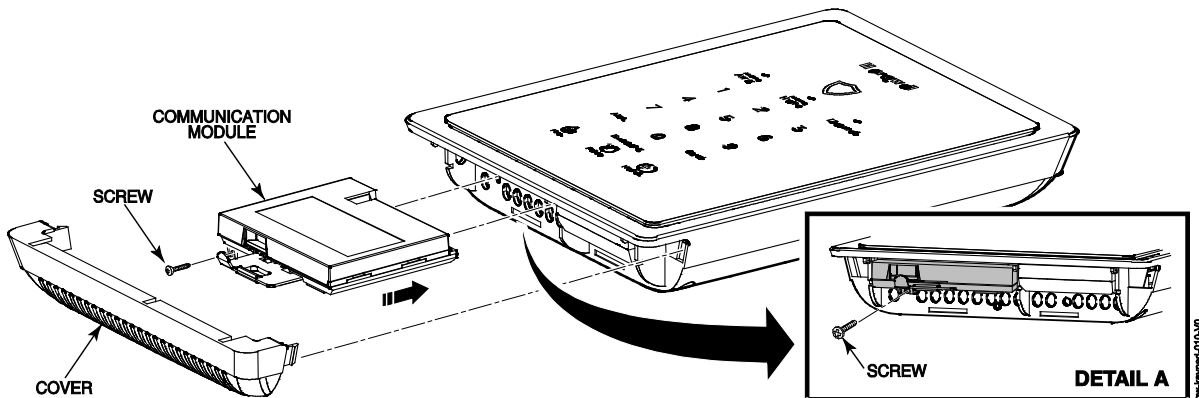

### Checking Signal Strength

When choosing a suitable mounting location, check the communications module's signal strength to ensure proper operation. For most installations, using the module's internal antenna, mounting the Lyric Gateway as high as practical, and avoiding large metal components provides adequate signal strength for proper operation. To check signal strength, perform the following test.

#### Check Signal Strength

1. With the System in the Installer Programming mode, select the "Comm. Diagnostics" button and then select the "Cellular Information" button. The Cellular Information will be displayed. The signal strength is displayed (in dBm) as RSCP if the Lyric-3G module is operating on the 3G Network or RSSI if the module Lyric-3G module is operating on the 2G Network and for the Lyric-CDMA module.
2. Compare the displayed RSCP or RSSI number to the correct Signal Strength Guide at right to ensure adequate signal strength. If necessary, relocate the Controller to obtain better signal strength (select "Cellular Information" again to refresh the reading).
3. If adequate signal strength cannot be achieved, External Antenna Kit model Cell-ANTST should be used.

Lyric -3G Signal Strength	
<b>RSCP (3G)</b>	
Good.....	-20 to -90 dBm
OK.....	-91 to -100 dBm
Marginal.....	-101 to -106 dBm
Bad.....	-107 to -120 dBm
<b>RSSI (2G)</b>	
Good.....	-20 to -89 dBm
OK.....	-90 to -98 dBm
Marginal.....	-99 to -104 dBm
Bad.....	-105 to -120 dBm
<b>Lyric -CDMA Signal Strength</b>	
<b>RSSI</b>	
Good.....	-20 to -90 dBm
OK.....	-91 to -100 dBm
Marginal.....	-101 to -106 dBm
Bad.....	-107 to -120 dBm

## Wireless Zones

### General Information

#### Zones

The Lyric Gateway supports up to 64 total wireless zones using 5800 and SiX™ Series transmitters, and wireless keys.

#### Range

The built-in RF receiver can detect signals from wireless transmitters within a nominal range of 200 feet.

#### Transmitters

5800 and SiX™ Series transmitters have built-in serial numbers that must be entered into the system via AlarmNet 360™. Each transmitter's zone number is also programmed into the system in the "Zones" programming section. Some transmitters, such as the 5816 can support more than one "zone" (referred to as loops or inputs). On the 5816, for example, the wire connection terminal block is loop 1; the reed contact is loop 2. Each loop must be assigned a different zone number.

For 5800 Series wireless keys such as the 5804E, 5834-4 and 5878, you must assign a unique zone number to each individual button used on the transmitter. Each button on the transmitter also has a pre-designated loop or input number, which is automatically displayed.

---

**The 5816 Transmitters do not have EOL supervision of their loop wiring, which must not exceed 3 feet.**

**ETL** The 5800PIR-OD, 5800SS1, 5804E, 5814, 5821, 5877 and 5878 wireless transmitters have not been evaluated by ETL.

---

#### House Identification

If a RF House ID (RF House Code) is required to establish proper communication, the same two-digit code (01-31) must be programmed in the Lyric, and the device. Refer to the "System Type" programming section in the Lyric Gateway Programming Guide (p/n 800-18077). An RF House ID is not necessary for 5800 Series transmitters and the entry should be left at "0" (default) in those cases.

#### Transmitter Supervision

With the exception of some transmitters/keypads that may be carried off-premises (5804E, 5834-4 and SiXFOB), each transmitter is supervised by a check-in signal that is sent to the receiver at 70-90 minute intervals. If at least one check-in is not received from each supervised transmitter within a 12-hour period, the "missing" transmitter zone number(s) and "Supervision" will be displayed. The supervision for a particular transmitter in the system that may also be carried off the premises may be turned off by entering it as an "Unsupervised" type. For additional information, refer to the "Zones" programming section in the Lyric Gateway Quick Installation Guide (p/n 800-21668). 5800 and SiX™ Series transmitters have built-in tamper protection and will announce as a fault condition if covers are removed. In Canada the RF supervision period is 3-hours for Fire zones and 12 hours for all other zone types.

#### Transmitter Input Types

Each transmitter has one or more unique factory-assigned input (loop/5800 Series or service/SiX™ Series) ID codes. Each of the inputs requires a programming zone (e.g., a 5804E's four inputs require four button zones). Transmitters can be entered as one of the following types (see transmitter's instructions for appropriate Supervision type):

Type	Description
Supervised	Sends periodic check-in signals, as well as fault, restore, and low battery signals. The transmitter must remain within the receiver's range.
Unsupervised	Sends all the signals that the Supervised type does, but the controller does not supervise the check-in signals. The transmitter may therefore be carried off-premises.
Button	Sends only fault signals. Do not send low battery signals until being activated. The transmitter is unsupervised and may be carried off-premises.

#### Transmitter Battery Life

- Batteries in the wireless transmitters may last from 4-7 years, depending on the environment, usage, and the specific wireless device being used. Factors such as humidity, high or low temperatures, as well as large swings in temperature may all reduce the actual battery life in a given installation. The wireless system can identify a true low battery situation, thus allowing the dealer or user of the system time to arrange a change of battery and maintain protection for that point within the system.
- Button-type transmitters should be periodically tested for battery life. The 5804E, 5834-4, 5878 and SiXFOB button transmitters have replaceable batteries.

## Wireless Zones (Continued)

### RF Transmitter Loop Numbers

(Refer to this information when programming 5800 Series transmitters)

The following illustration shows the compatible transmitters, their associated input types and loop designations.

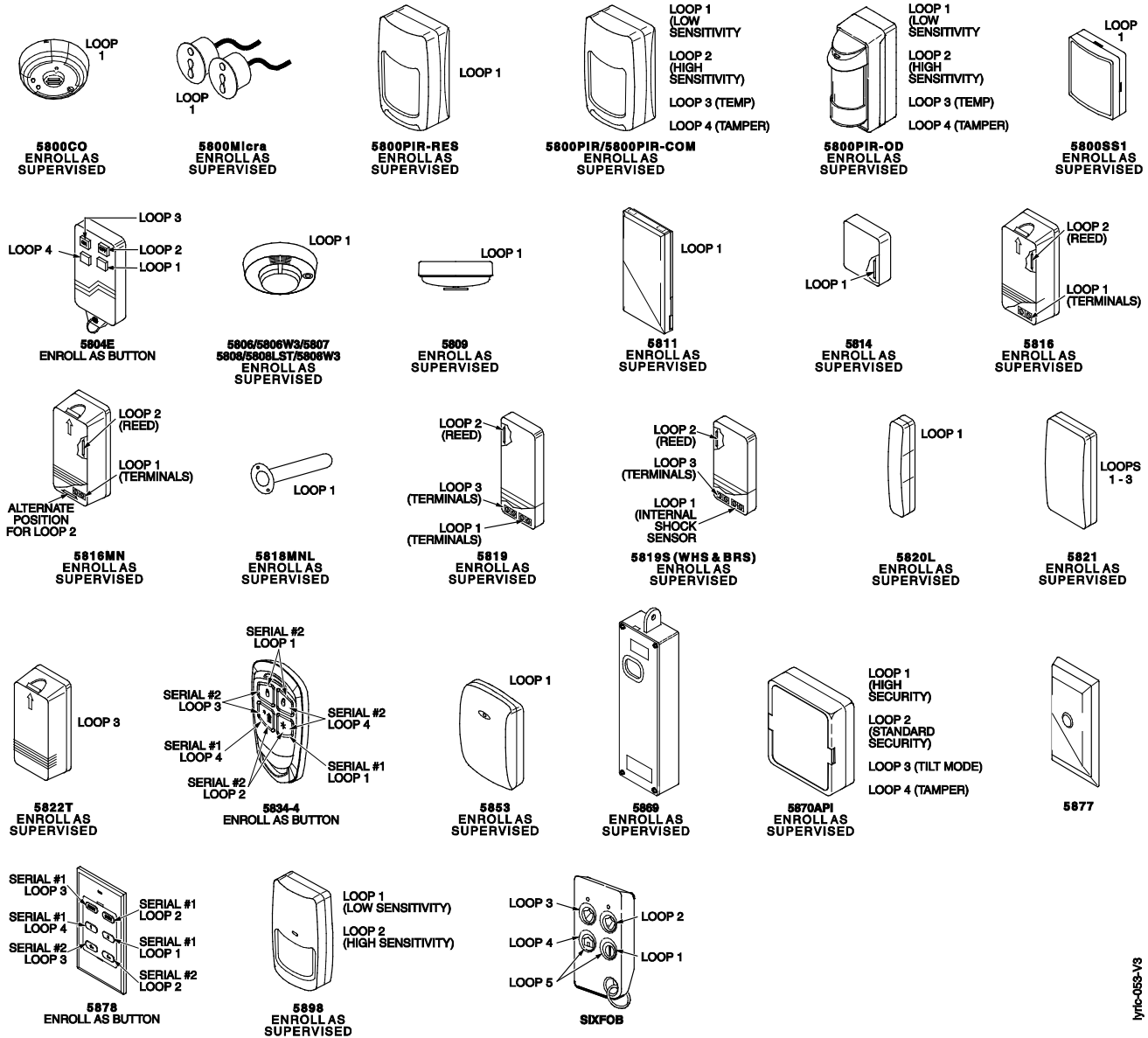

lyric-058-1/3

- Notes:**
- (1) The 5806W3 smoke detector must be used in SIA applications.
  - (2) Button type devices send only fault and low battery signals; no restore or check-in signals. Supervised RF devices send periodic check-in signals, faults, restore and low battery signals.
  - (3) The 5804E and 5834-4 encrypted (High-Security) devices must be activated while the system is in Go/No-Go Test Mode. Refer to the transmitter's Installation Instructions for complete details. The system will confirm the enrollment of the encrypted device by beeping two times.
  - (4) The 5800PIR-OD, 5800SS1, 5804E, 5814, 5821, 5877, and 5878 wireless transmitters have not been evaluated by ETL.

## Mechanics of Programming

### Navigating

#### Gateway Keypad

Gateway's keypad can be used for Basic Security Functions. The keypad provides a number of functions and indicators. The System Status Shield is lit Green when the system is ready or flashes Red when it is not. When the system is armed the System Status Shield is lit Red. Refer to the table below for additional indications and functions. Additional functions are available via the My Home or Total Connect App or the associated websites.

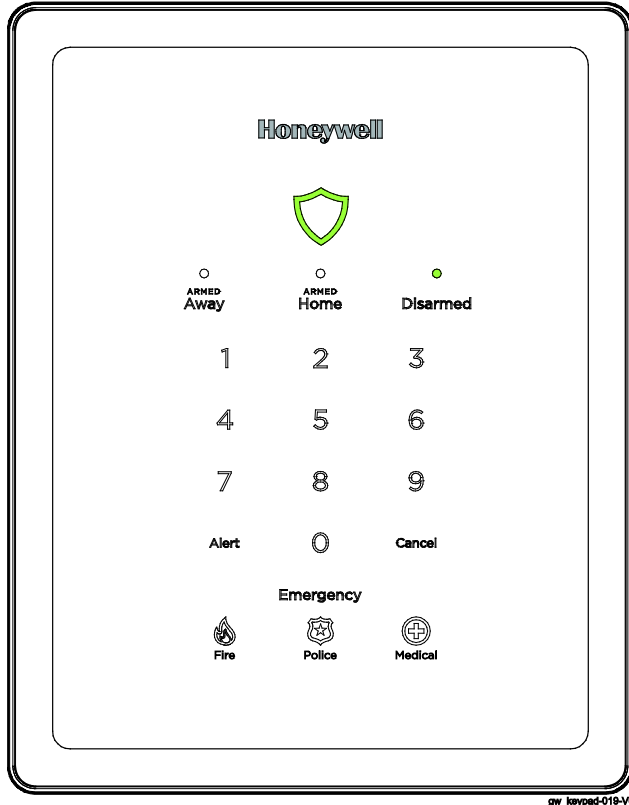

Key	Description
	<b>System Status Shield</b> - System status is displayed when the shield is lit as follows: Green (steady) - Ready to Arm Red (steady) - System is Armed Red (slow flash) - Entry/Exit delay countdown Red (rapid flash) - System is in Alarm White (steady) - Waiting for User Code entry
ARMED Away	Arm gateway in Away mode (LED steady red when selected)
ARMED Home	Arm gateway in Home mode (LED steady red when selected)
Disarmed	Disarm Gateway (LED flashes green until code is entered, then turns steady green)
Alert	Flashes red when an alert condition exists. Select to hear condition
Cancel	Cancel User Code entry or Emergency (Flashes white during an emergency)
Emergency	Activates Emergency keys
	<b>Fire key</b> - Initiates panic fire alarm within 5 seconds of activation.
	<b>Police key</b> - Initiates panic police alarm within 5 seconds of activation
	<b>Medical key</b> - Initiates panic medical alarm within 5 seconds of activation

LYRIC™ Gateway

#### Gateway Menu Mode

Entering the Master User Code or Installer Code on the Gateway keypad will provide access to Menu Mode.

**Enter Menu Mode:** Enter Master User or Installer Code + 11. The system will announce the menu options based on the code that was entered.

Code Entered	Menu Option (System Announcement)
Master User (1234)	Press 20 to delete all enrolled MyHome apps
	Press 21 to enter MyMome app Enroll Mode
	Press 31 to enter Access Aoint mode
Installer (4112)	Press 31 to enter Access Point mode
	Press 51 to enter Go/No-Go Test mode

## Mechanics of Programming (Continued)

### Touch-screen Display

The MyHome Gateway App is used to display screens on the smart device touch-screen. Variable icons and text are displayed on “screens”. The screen displays status icons and associated text, the current time and date, system status information and menu choices. The Menu area includes a list of commands, or choices that apply to the current selection. The status area provides information about various system events and colored text also provides an indication of system status. A “Home Screen” is displayed whenever the App is opened.

### Navigation Keys

Navigating through the screens is accomplished by lightly touching the icons or menu items on the smart device touch-screen. Once activated, the Gateway advances to the next screen. Selecting the “⏪” key or the “Home” (cancel) key will return you to the previous screen or the home screen (as applicable) at any time. By touching (selecting) an icon or key the system, depending on the function, advances to another screen, toggles between options or scrolls through multiple options that can be selected. The system provides a prompt when a specific input is required.

**Note:** You may find it convenient to adjust the volume setting before entering the Program Mode. This will allow you to clearly hear the feedback announcements or system beeps from the system’s built-in speaker. To adjust the volume, select “Settings” icon on the Home screen. Adjust the volume using the slide displayed on the Settings screen and then select “Save” to accept.

### Home Screen

System Status is displayed at the top of screen. In addition to the system status, the Home Screen displays the current date and time and Security, Automation, TC Video, Smart Scenes and Settings icons. When Total Connect Services are connected and web content is enabled the current weather forecast and a 5-Day Forecast button.

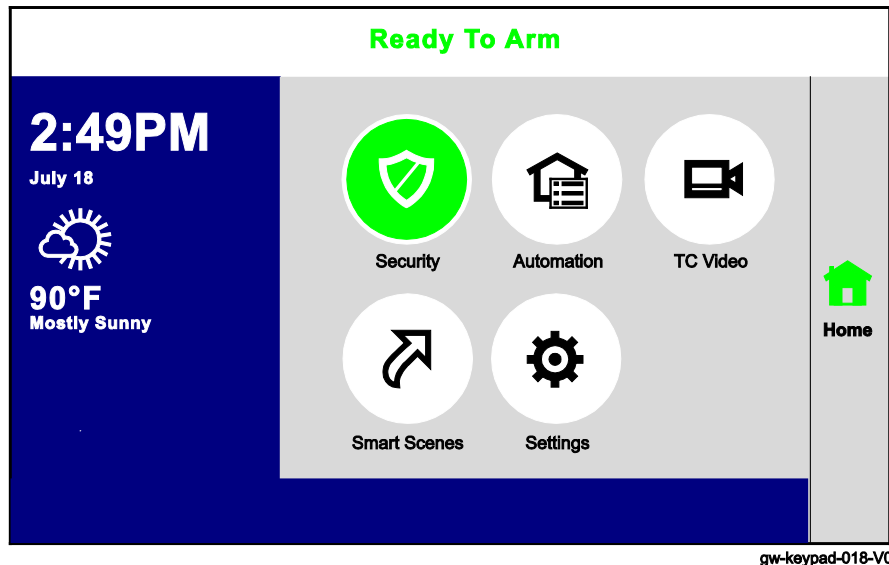

Gateway Home Screen with Total Connect Services

Icon	Function
Security	Provides access to Security Screen
Automation	Provides access to Automation Screen
TC Video	Provides access to Video Screen
Smart Scenes	Provides access to Smart Scenes Programming Screen
Settings	Provides access to System Settings Screen
5-Day Forecast	Provides access to local 5-Day Weather Forecast Screen
Weather	Provides local forecast and severe weather alerts



## Mechanics of Programming (Continued)

### Navigating Menus

#### Security Screen

System Status is displayed at the top of each screen and the time and date are displayed at the top left side of the Security Screen. The Security Screen displays the system status and selection "icons". The displayed pages and options may vary slightly depending upon the devices and services that are installed in or connected to the system.

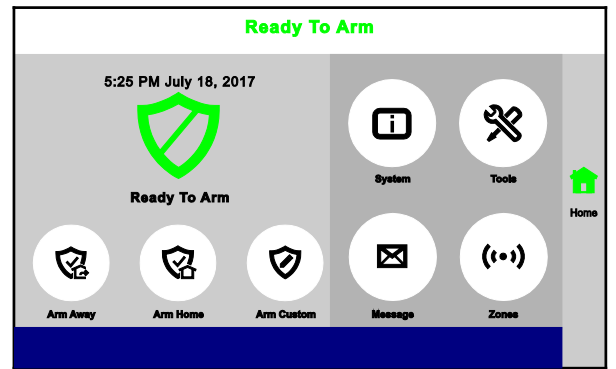

Security Screen

Selection	Function
Arm Away	Used to Arm the system in Away mode.
Arm Home	Used to Arm the system in Home mode.
Arm Custom	Used to Arm the system in Custom mode.
System	Provides information about system status.
Tools	Provides access to Installer and User Programming Menus (Master User Code required for access).
Message	Provides access to Message Center.
Zones	Provides access to Zone information and options.

#### Master User Menu Screen

The Master User Menu screen provides access to the User configurable features. Entering the Master User Code is required to access the User Tools Menu.

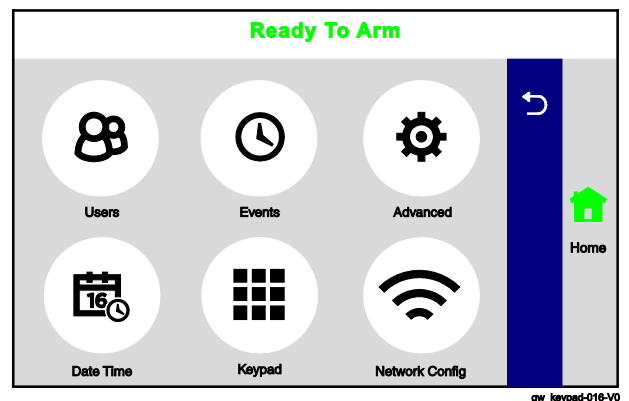

Master User Menu Screen

## Mechanics of Programming (Continued)

### Programming



If the system is Armed or in Alarm, the Tools icon will not be functional. The system must first be disarmed.

### Master User Features

SCREEN	ACTION																
<div style="border: 1px solid black; padding: 5px;"> <p style="text-align: center; color: green; font-weight: bold;">Ready To Arm</p> <table border="1" style="width: 100%; border-collapse: collapse;"> <tr> <td style="width: 50%; padding: 5px;">System Information</td> <td style="width: 50%; padding: 5px;">Walk Test</td> </tr> <tr> <td style="padding: 5px;">Install Cellular Module</td> <td style="padding: 5px;">Comm. Test</td> </tr> <tr> <td style="padding: 5px;">Install Backup Battery</td> <td style="padding: 5px;">Reboot</td> </tr> <tr> <td style="padding: 5px;">Update Sensor Firmware</td> <td style="padding: 5px;">Update Keypad Firmware</td> </tr> </table> <div style="text-align: right; margin-top: 5px;">  Home                 </div> <p style="text-align: right; font-size: small; margin-top: 5px;">gw_keypad-017-V0</p> </div> <p style="text-align: center; color: green; font-weight: bold; margin-top: 10px;">Master User Menu Screen</p>	System Information	Walk Test	Install Cellular Module	Comm. Test	Install Backup Battery	Reboot	Update Sensor Firmware	Update Keypad Firmware	<ol style="list-style-type: none"> <li>1. Select the “Security” icon.</li> <li>2. Select “Tools” icon.</li> <li>3. Enter the Master User Code 1234 on the displayed keypad.</li> <li>4. Select one of the following options:                             <table style="margin-left: 20px; border-collapse: collapse;"> <tr> <td style="border-right: 1px solid black; padding: 2px 5px;">System Information</td> <td style="padding: 2px 5px;">Walk Test</td> </tr> <tr> <td style="border-right: 1px solid black; padding: 2px 5px;">Install Cellular Module</td> <td style="padding: 2px 5px;">Comm. Test</td> </tr> <tr> <td style="border-right: 1px solid black; padding: 2px 5px;">Install Backup Battery</td> <td style="padding: 2px 5px;">Reboot</td> </tr> <tr> <td style="border-right: 1px solid black; padding: 2px 5px;">Update Sensor Firmware</td> <td style="padding: 2px 5px;">Update Keypad Firmware</td> </tr> </table> </li> <li>5. The system advances to the screen for the selected option.</li> </ol>	System Information	Walk Test	Install Cellular Module	Comm. Test	Install Backup Battery	Reboot	Update Sensor Firmware	Update Keypad Firmware
System Information	Walk Test																
Install Cellular Module	Comm. Test																
Install Backup Battery	Reboot																
Update Sensor Firmware	Update Keypad Firmware																
System Information	Walk Test																
Install Cellular Module	Comm. Test																
Install Backup Battery	Reboot																
Update Sensor Firmware	Update Keypad Firmware																

### Exit Programming Mode

1. Select the “⏪” key to exit the current screen OR select the Home key to return to the Home Screen.

## Zone Response Type Definitions

### General Information

During programming, you must assign a zone type to each zone, which defines the way in which the system responds to faults in that zone. Zone types are defined below.

Type	Function	Characteristics
Not Used	Used to program a zone that is not used.	<ul style="list-style-type: none"> <li>None</li> </ul>
Entry/Exit 1 (Burglary)	Usually assigned to sensors or contacts on primary entry and exit doors.	<ul style="list-style-type: none"> <li>Entry delay #1 is programmable.</li> <li>Exit delay is independently programmable.</li> <li>Exit and entry delays when armed in Away, Stay or Night Stay mode.</li> <li>No entry delay when armed in Stay or Away Instant modes.</li> <li>Exit delay regardless of the arming mode selected.</li> </ul>
Entry/Exit 2 (Burglary)	Usually assigned to sensors or contacts on secondary entry and exit doors that might be further from the keypad (typically used for a garage, loading dock, or basement door).	<ul style="list-style-type: none"> <li>Entry delay #2 is programmable.</li> <li>Exit delay is independently programmable.</li> <li>Secondary entry delay, if armed in the Away or Stay mode.</li> <li>No entry delay when armed in the Stay Instant or Away Instant mode.</li> <li>Exit delay begins regardless of the arming mode selected.</li> </ul>
Perimeter (Burglary)	Usually assigned to all sensors or contacts on exterior doors and windows	<ul style="list-style-type: none"> <li>Instant alarm, when armed in Away, Stay, Stay No Delay, Night Stay or Away Instant mode.</li> </ul>
Interior, Follower	Usually assigned to a zone covering an area (i.e.: foyer, lobby, or hallway) that must be passed upon entry (after faulting the entry/exit zone) to reach the keypad. Provides an instant alarm if the entry/exit zone is not violated first, and protects an area in the event an intruder has hidden on the premises before the system is armed, or gains access through an unprotected area.	<ul style="list-style-type: none"> <li>Delayed alarm (using the programmed entry/exit time) if entry/exit or interior-with-delay zone is faulted first.</li> <li>Instant alarm in all other situations.</li> <li>Active when armed in Away or Away Instant mode.</li> <li>Bypassed automatically when armed in Stay, Night Stay or Stay Instant mode.</li> </ul>
Trouble by Day/ Alarm by Night	Usually assigned to a zone that covers a sensitive area (i.e.: stock room, drug supply room, etc.) It can also be used on a sensor or contact in an area where immediate notification of an entry is desired.	<ul style="list-style-type: none"> <li>Instant alarm, when armed in Away, Stay, Night Stay, Stay Instant, or Away Instant (night) mode.</li> <li>Provides a latched trouble sounding from the keypad and, if desired, a Central Station report when disarmed (day).</li> </ul>
24-hour Silent Alarm	Usually assigned to a zone containing an Emergency button (silent emergency).	<ul style="list-style-type: none"> <li>Sends a report to the Central Station but provides no keypad display or sounding.</li> <li>In disarmed state sends a report to the Central Station displays "Not Ready to Arm" on the keypad and "Away", "Stay" and "Tools" buttons are disabled.</li> </ul>
24-hour Audible Alarm	Usually assigned to a zone containing an Emergency button (audible emergency).	<ul style="list-style-type: none"> <li>Follows sounder timeout</li> <li>Sends a report to the Central Station, and provides alarm sounds at the keypad.</li> </ul>
24-hour Auxiliary Alarm	Usually assigned to a zone containing a button for use in personal emergencies or to a zone containing monitoring devices (i.e.: water or temperature sensors, etc.).	<ul style="list-style-type: none"> <li>Sends a report to the Central Station and provides an alarm sound at the keypad. (There is no keypad timeout.)</li> </ul>
Silent Burglary	Usually assigned to sensors or contacts on exterior doors and windows where sirens are NOT desired.	<ul style="list-style-type: none"> <li>Instant alarm, with No audible indication when armed in the Away, Stay, Stay No Delay, Night Stay, or Away Instant mode.</li> <li>Report sent to the Central Station.</li> </ul>
Local Alarm	Usually assigned to a zone containing an Emergency button (audible emergency).	<ul style="list-style-type: none"> <li>Follows sounder timeout.</li> <li>Provides alarm sounds at the keypad.</li> <li>No reports to the Central Station.</li> </ul>
Interior with Delay	Provides entry delay (using the programmed entry time), if tripped when the controller is armed in the Away mode. Bypassed when the controller is armed in the Stay or Stay Instant mode.	<ul style="list-style-type: none"> <li>Entry delay #1 (with programmed entry time) when armed in the Away mode.</li> <li>Entry delay begins whenever sensors in this zone are violated, regardless of whether an entry/exit delay zone was tripped first.</li> <li>No entry delay when armed in the Away Instant mode.</li> <li>Exit delay regardless of the arming mode selected.</li> </ul>
24-hour Carbon Monoxide Monitor	Can be assigned to any wireless zone with a carbon monoxide detector. This zone type is always active and cannot be bypassed.	<ul style="list-style-type: none"> <li>Local keypad and detector will sound when this zone type is alarmed. (Pulse Temporal 4).</li> </ul>
Trouble	Used with Other response type.	<ul style="list-style-type: none"> <li>The system will provide a trouble sounding from the keypad (and a Central Station report, if desired).</li> </ul>
Fire No Verification	Can be assigned to any wireless zone used as a fire zone. This zone type is always active and cannot be bypassed.	<ul style="list-style-type: none"> <li>Alarm sound will pulse (Temporal Fire) when this zone type is alarmed.</li> </ul>

## Zone Response Type Definitions (Continued)

Type	Function	Characteristics
Fire with Verification	Can be assigned to any wireless zone used as a fire zone. Fire with verification is available with smoke detector device type. It cannot be used with heat detectors, combination heat/smoke detectors or fire pull stations. This zone type is always active and cannot be bypassed.	<ul style="list-style-type: none"> <li>Alarm sound will pulse (Temporal Fire) when this zone type is alarmed and the alarm has been verified.</li> <li>System verifies alarm by delaying reporting and alarm sounding for 30 seconds after alarm is detected. If the zone remains faulted after 30 seconds a fire alarm is provided. If any other fire zone is faulted during the 30 second delay window a fire alarm is immediately provided for that zone. An alarm for original fire zone will also be provided, if that zone is still faulted. If there are no fire alarms after the 30 second delay expires, the system will open a 60 second window. If any fire zone is faulted during that window a fire alarm will immediately be provided for that zone.</li> </ul>
Arm-Stay	Special-purpose zone type used with 5800 and SiX™ Series wireless keys.	<ul style="list-style-type: none"> <li>Exit delay regardless of the arming mode selected.</li> <li>System is armed in the Stay mode when the zone is activated.</li> </ul>
Arm-Away	Special-purpose zone type used with 5800 and SiX™ Series wireless keys.	<ul style="list-style-type: none"> <li>System is armed in the Away mode when the zone is activated.</li> </ul>
Disarm	Special-purpose zone type used with 5800 and SiX™ Series wireless keys.	<ul style="list-style-type: none"> <li>Disarms the system when the zone is activated.</li> </ul>
No Alarm Response	Assigned when no-alarm response is required.	<ul style="list-style-type: none"> <li>No reports to the Central Station.</li> <li>No keypad sounding or chime and no display on screen.</li> <li>System can still be armed.</li> </ul>
Monitor	Can be assigned to any wireless zone used for asset protection. Works as a dynamic monitor of a zone fault/trouble (not alarm).	<ul style="list-style-type: none"> <li>Reports to the Central Station, if enabled.</li> <li>Fault/restore events are logged by the system.</li> <li>Activity Zone No. and Zone Descriptor displayed on LCD.</li> <li>Restore will be stored in event log.</li> <li>No keypad sounding or chime.</li> <li>System can still be armed.</li> </ul>
General Monitor	Assigned sensors or contacts on doors and windows or asset protection within the premises. Used to track activity of the occupant and alert occupant of the activity of others.	<ul style="list-style-type: none"> <li>No reports to the Central Station.</li> <li>Fault/restore events are logged by the system.</li> <li>Monitors entry into a monitored area. Activates a one-time announcement when faulted.</li> <li>Activity Zone No. and Zone Descriptor displayed on LCD.</li> </ul>
General Response	Assigned sensors or contacts on doors and windows or asset protection within the premises. Used to track activity of the occupant and alert occupant of the activity of others.	<ul style="list-style-type: none"> <li>No reports to the Central Station.</li> <li>Fault/restore events are logged by the system.</li> <li>Monitors entry into a monitored area. Activates a zone announcement when faulted.</li> <li>Activity Zone No. and Zone Descriptor displayed on LCD.</li> <li>System re-triggers audible sounding every ten seconds until acknowledged.</li> </ul>
Resident Monitor	Used to monitor a resident in an area deemed to be dangerous by a caregiver.	<ul style="list-style-type: none"> <li>No reports to the Central Station.</li> <li>Monitors entry into a monitored area. Activates a zone announcement when faulted.</li> <li>Activity Zone No. and Zone Descriptor displayed on LCD.</li> <li>Fault/Restore events are not logged by the system.</li> </ul>
Resident Response	Used to monitor a resident in an area deemed to be dangerous by a caregiver. Requires acknowledgement by caregiver.	<ul style="list-style-type: none"> <li>No reports to the Central Station.</li> <li>Monitors entry into a monitored area. Activates a zone announcement when faulted.</li> <li>Activity Zone No. and Zone Descriptor displayed on LCD.</li> <li>System re-triggers audible sounding every ten seconds until acknowledged (Off sequence or wireless key).</li> <li>Fault/Restore events are not logged by the system.</li> </ul>
Garage (Burglary)	Assigned to Automatic Garage Door applications. Provides a status of the garage door close/open real time state.	<ul style="list-style-type: none"> <li>Associated With Entry Delay #2 Programmed Time.</li> <li>Exit delays when armed in Away, Stay or Night Stay mode.</li> <li>No Entry Delay when armed in Away or Stay Instant modes.</li> <li>System can be armed with zone in the faulted state. When the zone is closed it will automatically be inclusive within protection points. If the point is subsequently violated, it will initiate an alarm.</li> </ul>
Garage Monitor	Assigned to Automatic Garage Door applications. Provides a status of the garage door close/open real time state.	<ul style="list-style-type: none"> <li>Can be assigned to any wireless zone used for automatic "Garage Door" Open/Close status.</li> <li>Will not initiate an alarm condition on the controller.</li> <li>When zone is in the open state will display "FAULT."</li> <li>Does not report alarms to Central Station.</li> <li>Zone will chime if enabled.</li> <li>System can be armed if this zone type is in fault.</li> </ul>

## System Operation

### Key/Touchscreen Operation

Touchscreen icons displayed on the Smart Device allow the user to arm and disarm the system, and perform other system functions, such as bypassing zones. Zone and system conditions (alarm, trouble, bypass) are displayed on the LCD. When an alarm occurs, the Gateway and Smart Device (if installed) will sound, and the zone(s) in alarm will be displayed. Pressing any key will silence the keypad sounder for 10 seconds (only once). Disarming the system will silence both console and external sounders. When the system is disarmed, any zones that were in an alarm condition during the armed period will be displayed (memory of alarm). To clear this display, simply repeat the disarm sequence by selecting "Disarmed" and entering the Security Code. The console also features chime annunciation, and three panic key icons for silent, audible, Fire or Medical emergency alarms. These keys can notify the Central Station of an alarm condition, if that service is connected.

### Panic Key/Icons

There are three panic keys that are active (if programmed) when the "Emergency" or any of the keys is selected for approximately five seconds. The panic key screen will timeout if a selection is not made within ten seconds. The keys can be used to manually initiate alarms and send a report to the Central Station. Each can be individually programmed for 24-hour silent, audible, personal or fire emergency responses. The panic function is activated when the respective keys is pressed. The panic functions are identified by the system as follows:

Zone	Function
995	Fire Emergency
996	Medical Emergency
998	Local Alarm
999	Police Emergency

**Important:** For the silent panic functions to be of practical value, the system must be connected to a Central Station.

### Security Codes

#### Installer Code

The installer programs the 4-digit Installer Code initially as part of the programming procedure. The factory default Installer Code is 4-1-1-2, but may be changed in the Installer Code programming field. The Installer Code is the only code that allows entry into Installer Programming mode.

#### Master Code

In normal operation mode, the Master (Security) Code is used to enter the 4-digit User Security Codes and enter the Master User Tools Menu mode.

#### Enter/Change the Master Code by Installer.

The factory default Master Code for the Lyric Gateway is set to 1-2-3-4. The Master Code is used to enter the 4-digit User Security Codes.

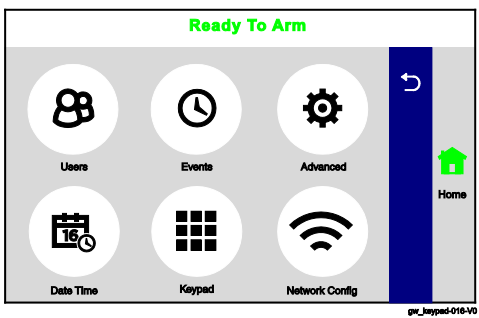
SCREEN	ACTION
	<ol style="list-style-type: none"> <li>1. After entering the Master User Menu screen, select the "Users" icon. The system displays the User Code Programming screen.</li> <li>2. Select "Master", then select "Edit".</li> <li>3. Enter a new 4-digit Master (Security) Code on the displayed keypad. The system displays the new code on the left side of the screen.</li> <li>4. Select "Done" when you are finished.</li> <li>5. The system returns to the Master Code Programming screen.</li> </ol>

### Secondary User Codes

In normal operation mode, the Master (Security) Code can be used to assign up to 46 secondary 4-digit security codes, including a Guest Code and a Duress Code. The Master Code can also be used to individually remove secondary codes from the system. Refer to the Lyric Gateway User Manual for additional information.

**Reset Master Code**

1. After Entering the Programming Mode, select “Users” from the Master User screen menu.
2. Select “Master” followed by “Edits” to reset the Master User Code.
3. Select “User Code”.
4. Enter a new Master Code on the displayed keypad, then select “Done”. The system returns to the previous screen.
5. Select “Save”
6. If confirmed, the Master Code will be reset back to “1-2-3-4”. This will be logged in the System Event Log as “User: 1 Reset Master Code, E655”. The system returns to the second page of the Installer Programming Tools menu.

OR

If the reset failed, the system will display: “Command Failed. Unable to Reset Master Code”. This will only occur if the code 1-2-3-4 has been assigned to another User in the panel.

**Security Code Notes**

- The Master and Secondary security codes permit access to the system for arming, disarming, etc.
- The Installer Code can disarm the system only if it was used to arm it. In addition, the Installer Code cannot disarm the system if it was armed by pressing and holding a Quick-Arm button.
- The Guest Code can disarm the system only if it was used to arm it. In addition, the Guest Code cannot disarm the system if it was armed by pressing and holding a Quick-Arm button.
- Duress code sends a special code to the Central Station when used to perform any system operation. Instruct users to be careful not to use this code for normal usage.
- Opening/closing reports are sent for the Installer Code, with the appropriate subscriber number. Master Code and secondary user codes are sent as User No. 2 and 3-48 respectively, in Contact ID® format (with the appropriate user number).

**Important Security Notice**

Please inform the User about the security importance of their wireless key (key fob), and what to do if it is lost.

Explain that the wireless key is similar to their keys or access card. If lost or stolen, another person can compromise their security system. They should immediately notify the Dealer/Installer of a lost or stolen wireless key. The Dealer/Installer will then remove the wireless key programming from the security system.

## System Operation

### System Displays

The following icons will be displayed on the Home screen along with specific zone status information (if applicable) to indicate system status.

DISPLAY	DEFINITION
	AC Loss
	Alarm (Intrusion)
	Ready To Arm
	Armed Away
	Armed Stay
	Armed Night Stay
	Armed Custom
	Restart Timer
	Battery Low
	Bypassed Zones
	CO Alarm
	Reporter Failure
	Low Batt 850 Keypad
	900 Cover Tamper

DISPLAY	DEFINITION
	901 Expansion Module Tamper
	950 Comm. Trouble
	988 RF Jam (5800 Series Wireless Device)
	990 RF Jam (SiX Series Wireless Device)
	998 Local Alarm
	Door Open
	Window Open
	Fire OR Heat Sensor
	Environmental
	Flood
	Glass Break
	Medical Alarm
	Keypad
	Motion

DISPLAY	DEFINITION
	Temperature
	Other
	Automation Icon (Z-Wave Node Failure OR Z-Wave Controller Not Ready)
	Garage Door Open
	WiFi source present and signal strength
	No WiFi source

### Zone Status Displays

The icons associated with the programmed zones are displayed on the Zones screen. The icon's color indicates the zone status (i.e.; yellow icon indicates the zone is faulted and a red icon indicate the zone is in alarm). In addition a bypass icon is displayed alongside the icon for a bypassed zone.

## System Operation (Continued)

**ETL** Audio alarm verification has not been evaluated by ETL.

### Audio Alarm Verification (Two-Way Voice Feature)

This feature allows the Central Station operator to listen, talk to or conduct a two-way conversation with an individual(s) at the premises. It also assists the operator in gathering information about the nature and location of the alarm that may be helpful in responding to police and fire departments. All Lyric Controllers are capable of supporting the Two-Way Voice feature. The Lyric Gateway does not make system announcements when the Two-Way Voice feature is active.

If a WiFi connection is being used for Two-Way Voice (AAV), sufficient bandwidth must be available.

- AAV requires a continuous WiFi upload/download bandwidth of 90kbps for proper operation.
- WiFi bandwidth less than 90kbps may result in degraded performance.

### Activation



**Fire and CO alarms will prevent the Lyric Gateway from starting an AAV session. A new Fire or CO alarm will end an AAV session that is in progress.**

The controller sends the “alarm message” followed by a “Listen-in-to-Follow message” (Contact ID® code 606) to the Central Station. The Listen-in-to-Follow message causes the Central Station’s digital receiver to temporarily hold the phone line for approximately 1 minute. When the controller receives the “kiss-off” from the Central Station, indicating that the alarm message has been received, the Two-Way Voice (AAV) feature is activated in the (default) “Listen Mode” and sirens and keypad sounds are discontinued. The controller transmits a beep acknowledgment to the Central Station, once per second. The beep alternates between two tones and indicates that the controller is waiting for a session command from the Central Station operator. Once a command is issued the beep acknowledgement is discontinued, however, if a command is not issued within two minutes the system will “time out” and the call will be terminated.

### Operator Commands

The Central Station operator begins the session, which last 5 minutes, by entering one of the valid AAV commands shown in the table below. The session may be extended 5 minutes, without changing the operating mode, by pressing the [7] key on the touch-tone phone. Selecting another operating mode also resets the session an additional 5 minutes. During the last minute of the 5 minute, session, the controller generates two beeps every 30 seconds to alert the Central Station operator that the session is about to time out. The Central Station operator may then extend the session by pressing the [7] key on the touch-tone phone. If the session is not extended, the phone line is disconnected and the session is ended. Sessions may be ended at any time by pressing the [9] key on the touch-tone phone. The AAV modes are described as follows:

**Note:** When entering AAV commands make sure the Central Station receiver has been disconnected from the phone line, otherwise AAV commands may not go through.

Key	Function
1	Talk Mode: Pressing the [1] key on the touch tone phone, enables one-way voice communication from the Central Station to the violated premises, and allows the operator to communicate through the controller’s built-in speaker. In this mode the controller’s Panic and Home buttons blink alternately.
2	VOX (Voice) Mode: Pressing the [2] key on the touch-tone phone, enables two-way voice communications between the Central Station and the violated premises via the controller’s built-in speaker and microphone. In this mode the controller’s Panic button is lit Red and the Home button is alternately lit Red and Green.
3	Listen Mode: Pressing the [3] key on the touch-tone phone, Enables one-way audio from the violated premises to the Central Station. The Listen Mode is the start up default mode of the voice feature and allows the operator to listen through the controller microphone. This mode does not affect the existing LED pattern.
7	Extends the session 5 minutes without changing its operating mode.
9	Ends the session and disconnects the phone line.



## System Operation

### Event Log

The Lyric Gateway Series event log is capable of recording and displaying up to 6,000 system events. These events are stored locally in the Gateway, in chronological order, and transmitted to the Central Station. When the maximum number of events is reached in the Event Log, the system will overwrite the oldest event first. The type of events that can be recorded is selectable and is programmed in the System Type programming field. The event log can be reviewed by entering the Installer Programming or Master User Programming mode and selecting "Events". Refer to the Lyric Gateway User Manual for additional information. The Events and CID Codes displayed vary according to the options that are programmed. The tables below provide definitions of the events/codes that may be transmitted to the Central Station and/or displayed by the controller.

**Note:** In the unlikely condition that the backup battery becomes fully discharged when AC power is lost, any system activity performed after the low battery notification will not be saved in the event log. Additionally, the controller will revert to the status condition as before the low battery notification.

### Contact ID® Event Log Codes

CID Code	Definition	Event Log Display
110	Alarm, Fire	Fire
121	Alarm, Duress	Duress
122	Alarm, Silent	Silent
123	Alarm, Audible	Audible
131	Alarm, Perimeter	Perimeter
132	Alarm, Interior	Interior
134	Alarm, Entry/Exit	Entry/Exit
135	Alarm, Day/Night	Day Night
137	Alarm, Tamper	Tamper
145	Expansion Module Tamper	Expansion Module Tamper
146	Silent Burglary	Silent Burglary
150	24-Hour Non-Burglary	24 Hour Non-Burglary
162	Carbon Monoxide Detected	Carbon Monoxide Detected
301	Trouble, AC Loss	AC Loss
302	Trouble, Low System Battery	Low system battery
305	Trouble, System Reset	System Reset
308	System shutdown	System shutdown
316	System Tamper*	System Tamper
341	Trouble, Case Tamper	Cover Tamper
344	Trouble, RF Receiver Jam Detect	RF Jam Detect
350	Long Range Radio Reset	Long Range Radio Reset
353	Trouble, Long Range Radio Transmitter Fault	Comm. Trouble
354	Failure to Communicate Event	Failure to Communicate Event
373	Trouble, Fire Trouble	Fire trouble
374	Trouble, Exit Error Alarm	Exit error alarm
380	Trouble, Sensor	Sensor trouble
381	Trouble, Loss of Supervision RF	Superv Loss-RF
383	Trouble, Sensor Tamper	Sensor Tamper
384	RF Low Battery	RF Low Battery
401	Open/Close by User	Arm Away/Disarmed
403	Open/Close Automatic	Automatic O/C (or Scheduled Arming)
406	Cancel	Cancel
407	Remote Arm/Disarm	Remote Arm/Disarm
408	Quick Arm	Quick arm
441	Armed Stay	Arm Stay/Disarmed
455	Auto-Arm Failed	Auto-arm Failed
459	Recent Close	Recent Closing
461	Wrong Code Entry	Wrong Code Entry
570	Zone/Sensor Bypass	Zone Bypass
601	Manual Trigger Test Report	Manual Trigger Test Report
602	Periodic Test Report	Periodic test report
606	Listen-in to follow	Listen-in to follow
607	Walk Test	Walk Test Mode
623	Event 90% Full	Event Log 90% Full
627	Program Mode Entry	Program mode entry
628	Program Mode Exit	Program mode exit
654	System Inactivity	System Inactivity
655	Reset Master Code	User Code

\*If APL is enabled, AlarmNet 360™ will generate a special comm. fail message (E316) if it does not hear from a unit within 15 minutes after a delayed alarm is delivered. This message is meant to alert the Central Station that the system has been tampered with and may have been compromised.

**Contact ID® Event Log Codes**

<b>CID Code</b>	<b>Definition</b>	<b>Event Log Display</b>
759	Resident Monitor Zone Response	Resident Monitor Zone Response
760	Resident Response Zone Response	Resident Response Zone Response
761	General Monitor Zone Response	General Monitor Zone Response
762	General Response Zone Response	General Response Zone Response
1401	Local Alarm	Local Alarm
3000	Binary Switch Off	Switch Off (Z-Wave Device)
3001	Binary Switch On	Switch On (Z-Wave Device)
3100	Multi Level Switch Change Level (Off)	Multilevel Switch Off (Z-Wave Device)
3101	Multi Level Switch Change Level (On)	Multilevel Switch On (Z-Wave Device)
3200	Garage Door Close	Garage Door Close
3201	Garage Door Open	Garage Door Open
3300	Door Lock Unlocked	Door Unlocked (Z-Wave Device)
3301	Door Lock Locked	Door Locked (Z-Wave Device)
3302	Door Lock Jammed	Door Lock Jammed (Z-Wave Device)
3400	Thermostat Mode Off	Thermostat Mode Off
3401	Thermostat Mode Heat	Thermostat Mode Heat
3402	Thermostat Mode Cool	Thermostat Mode Cool
3403	Thermostat Mode Auto	Thermostat Mode Auto
3404	Thermostat Mode Aux /Em Heat	Thermostat Mode Aux /Em Heat
3405	Thermostat Fan Mode Auto	Thermostat Fan Mode Auto
3406	Thermostat Fan Mode Manual On	Thermostat Fan Mode Manual On
3407	Thermostat Fan Mode Circulate	Thermostat Fan Mode Circulate
3408	Thermostat Set Heat Point	Thermostat Set Heat Point (and temperature)
3409	Thermostat Set Cool Point	Thermostat Set Cool Point (and temperature)
3410	Thermostat Hold	Thermostat Hold
3411	Thermostat No Scheduling	Thermostat No Scheduling
3412	Thermostat Normal Mode	Thermostat Normal Mode
3500	Low Battery	Low Battery (Z-Wave Device)
3501	Low Battery Restore	Low Battery Restore (Z-Wave Device)
4000	Voice Command Success	Displays Variable Voice Command Text
4001	Voice Command Failed	Displays Variable Voice Command Text
4002	Voice Trigger Success	Displays Variable Voice Trigger Text
4003	Voice Trigger Fail	Displays Variable Voice Trigger Text
5000	Critical Panel Firmware Update Downloaded	Critical Panel Update Downloaded

**Central Station Messages**

The following messages are sent by the controller internal cellular or WiFi devices for the conditions listed below.

<b>Alarm Condition</b>	<b>Alarm Code</b>	<b>Restore Code</b>
Power On / Reset	E33900950	
Primary Communication Path Supervision	E350C0951	R350C0951
Secondary Communication Path Supervision	E350C0952	R350C0952
Test	555555559	

## Testing the System

### TO THE INSTALLER

Regular maintenance and inspection (at least annually) by the installer and frequent testing by the user are vital to continuous satisfactory operation of any alarm system.

The installer should assume the responsibility of developing and offering a regular maintenance program to the user as well as acquainting the user with the proper operation and limitations of the alarm system and its component parts. Recommendations must be included for a specific program of frequent testing (at least weekly) to ensure the system's proper operation at all times.

### Test Modes

The following tests are available to the Installer or User via the "Advanced" programming option:

Option	Function
System Information	System Information is displayed. Select OK to return to the previous screen.
Walk Test	The Walk Test mode allows each protection point to be checked for proper operation. Refer to the User Manual for additional information.
Comm. Test	

The following tests are available to the Installer via the Gateway keypad.

RF Sniffer Test	Used to verify the RF transmitters have been properly installed.
Go-No-Go Test	Used to verify adequate RF signal strength from proposed transmitter locations.
Diagnostics	Provides access to the Reboot Feature. Refer to the paragraph in this section for additional information regarding this feature.
Zone Discovery	Provides access to the Zone Discovery mode. Refer to the paragraph in this section for additional information regarding the Zone Discovery feature.

### Testing the System

After installation is completed, the security system should be carefully tested, as follows:

Step	Action
1.	With the system in the disarmed state, check that all zones are intact. If the Status Shield is not lit green, select the "Security" icon on the Smart Device followed by the "Zones" icon to display the faulted zone(s). If necessary, restore faulted zone(s) so that the "Home" button lights. Fault and restore every sensor individually to assure that it is being monitored by the system.

### Armed System Test (via AlarmNet 360)

Alarm messages will be sent to the Central Station during the following steps 1 and 2. Notify the Central Station in advance that tests will be in progress.

Step	Action
1.	Arm the system and fault one or more zones. Silence alarm sounder(s) and disarm the system by selecting "Disarmed" and entering the Security Code. Check entry/exit delay zones.
2.	Check the keypad-initiated alarms that are in the system by selecting "Emergency" followed by applicable Panic keys. If the system has been programmed for audible emergency, the keypad will emit a steady alarm sound, and "Alert" will flash red. In addition, "ALARM" and zone number will be displayed on Smart Device. Silence the alarm by selecting "Disarmed" and entering the Security Code. If the system has been programmed for silent emergency, there will be no audible alarms or displays, but a report will be sent to the Central Station.
3.	Notify the Central Station when all tests are finished, and verify results with them.
4.	To test the wireless part of the system and the RF receiver, perform the RF Sniffer Mode and Go-No-Go Tests.

**NOTE:** System Test mode and Go/No Go Test will be automatically terminated after 3-1/2 to 4 hours if the installer or user does not manually terminate it. This ensures that fire and panic zones will not remain disabled. However, Sniffer mode does not automatically expire. You must manually exit Sniffer mode by selecting the Home key and entering the Master Code, to return to normal operation. During the final 5 minutes the system will emit double beeps indicating that the end of Test mode is nearing.

### RF Sniffer Test Mode

This mode is used to verify that all transmitters have been properly programmed. Sniffer Mode does not automatically expire. You must manually exit Sniffer Mode to return to normal operation.

### Go-No-Go Test Mode



Conducting this test with your hand wrapped around the transmitter will cause inaccurate results. If a button is pressed on a transmitter that has been programmed to set ARM AWAY, ARM STAY, or DISARM, the system will exit the Go/No Go Test mode and the programmed action will occur.

The Go-No-Go tests is used to verify adequate RF signal strength from the proposed transmitter location, and allow you to reorient or relocate transmitters if necessary, before mounting the transmitters permanently. This mode is similar to the RF Sniffer Mode, except that the wireless receiver gain is reduced. This will enable you to make sure that the RF signal from each transmitter is received with sufficient signal amplitude when the system is in the normal operating mode. During Go/No-Go mode the system beeps every 30-40 seconds.

#### Enter Go/No-Go Test mode

1. Enter Installer Code (4112) + 11 + 51 (on the Gateway keypad).

#### Exit Go/No-Go Test mode

1. Select "Disarmed"+ Enter Installer Code (4112).

### Zone Discovery Mode



Zone Discovery mode requires Installer supervision when in use. The system is not fully operational for fire or life safety while Zone Discovery Mode is active.

Zone discovery mode can be used to remotely view all zones that have been programmed in the system for operation. The zones must have a response type programmed and in the case of RF zones, must also have a serial number programmed. All zones programmed (except for duress) will be displayed.

#### Enter Zone Discovery

1. With the System in the Installer Programming mode, select the "Test" button and then select the "Zone Discovery" button. The "Zone Discovery" button will be highlighted indicating that the mode is active.

#### Exit Zone Discovery

1. Select the Home key and enter the Master Code. If you do not exit Zone Discovery mode manually, the system will automatically exit zone discovery mode in approximately 1-4 minutes dependent upon the number of zones that are programmed. The system beeps once and returns to the home screen.

### Rebooting the System

The Reboot function allows you to restart the system if required. To reboot the system perform the following:

Step	Action
1.	Select the "Security" icon followed by the "Tools" icon.
2.	Enter the Master User code (1234) and select the "Advanced" icon.
3.	Select the "Reboot" button. A confirmation screen appears.
4.	Select "Yes" to reboot the Gateway.

**NOTE:** After the reboot sequence is complete it is recommended that you perform a "Walk Test" to verify that all transmitters are operational in the system.

## Programming Default Values

Programming Field	Options	Programmed Default
<b>System</b>		
Alarm Report Delay	No delay, 15 Seconds, 30 Seconds, 45 Seconds	30 Seconds
Burglary Alarm Sound	Yes, No	Yes
Daylight Savings Time	Yes, No	Yes
Time Zone Offset		(UTC-5:00 Eastern Time (US & Canada))
Software Version	XX.XX.XXXXX.XXX	XX.XX.XXXXX.XXX
Temperature Unit	Fahrenheit, Celsius	Fahrenheit
Installer Language	English, Spanish, French, Portuguese	English
Two-way Voice	Not programmable	No
Local Programming Lockout	Yes, No	No
Z-Wave Support	Yes, No	Yes
Display alarm Cancel	Yes, No	Yes
Lack of Usage Notify	Disabled, 1 Day, 7 Days, 27 Days, 90 Days, 180 Days, 365 Days	Disabled
RF Jam	Disabled, RF Jam Log, RF Jam Log and Report	RF Jam Log
Number of Reports (Swinger Shutdown)	1, 2, 3, 4, 5, 6	2
First Test Report Offset	6 Hours, 12 Hours, 18 Hours, 24 Hours	6 Hours
Report Frequency	Never, Every Day, Every 7 Days, Every 30 Days	Never
System	Not programmable	Yes
Reporter	Not programmable	Yes
Panel Sync Delay Time	0 Minutes - 120 Minutes	3 Minutes
Z-Wave Door Lock	Disabled, Arm Stay, Arm Away, Arm Without Autostay	Disabled
<b>Area</b>		
Area Number	1	1
Entry Delay 1	None, 15 Seconds, 30 Seconds, 45 Seconds, 60 Seconds, 90 Seconds, 2 Minutes, 3 Minutes, 4 Minutes	30 Seconds
Entry Delay 2	None, 15 Seconds, 30 Seconds, 45 Seconds, 60 Seconds, 90 Seconds, 2 Minutes, 3 Minutes, 4 Minutes	30 Seconds
Exit Delay	45 Seconds, 60 Seconds, 90 Seconds, 120 Seconds	60 Seconds
Burglary Bell Timeout	No, 4 Minutes, 8 Minutes, 12 Minutes, 16 Minutes,	4 Minutes
Fire Bell Timeout	No, 4 Minutes, 8 Minutes, 12 Minutes, 16 Minutes,	4 Minutes
Quick Arm	Yes, No	Yes
Quick Exit	Yes, No	Yes
Restart Exit Time	Yes, No	Yes
Chime Mode	Yes, No	Yes
Force Bypass	Yes, No	No
Exit Warning	Not programmable	Yes
Display Exit Time	Yes, No	Yes
Power-Up In Previous	Not programmable	Yes
Auto Stay Arming	Yes, No	Yes
Arm Confirm	All RF, None, RF Keyfob, RF Keypad	None
<b>Communicator</b>		
City ID	01-99	Blank
CS ID	01-FE	Blank
Sub ID	0001-9999	Blank
Supervision	None, 24 Hours, 30 Days	30 days
High Usage Plan	Yes, No	No
Old Alarm Time	10 Minutes, 15 Minutes, 30 Minutes, 1 Hour, 2 Hours, 4 Hours, 8 Hours, 12 Hours, 24 Hours	10 Minutes
IP Fault Time	1 - 99 Minutes	60 Minutes
Communications Path (Inter. Dev.)	Cellular, WiFi - IP	WiFi - IP

## Programming Default Values

Programming Field	Options	Programmed Default
Use DHCP	Yes, No	Yes
NIC IP Address	Up to 12 digits	255.255.255.255
Subnet Mask	Up to 12 digits	255.255.255.255
Gateway IP Address	Up to 12 digits	255.255.255.255
DNS Server IP Address	Up to 12 digits	255.255.255.255
Cellular Fault Time	1 - 99 Minutes	60 Minutes
Cellular 24 Hr Test/UL864 Comm. Fire	Yes, No	No
Cellular Rollover	Yes, No	Yes
<b>Reporter</b>		
Arm Away	Yes, No	Yes
Arm Stay	Yes, No	Yes
Disarm	Yes, No	Yes
Exit Error	Not programmable	Yes
Alarm Restore	Yes, No	Yes
Alarm Cancel	Yes, No	Yes
Test	Not programmable	Yes
Test Restore	Not programmable	Yes
Low Battery	Yes, No	Yes
Low Battery Restore	Yes, No	Yes
RF Low Battery	Yes, No	Yes
RF Low Battery Restore	Yes, No	Yes
Recent Closing	Not programmable	Yes
Event Log Full	Yes, No	No
Trouble	Yes, No	Yes
Trouble Restore	Yes, No	Yes
Bypass	Yes, No	Yes
Bypass Restore	Yes, No	Yes
AC Loss	Yes, No	Yes
AC Loss Restore	Yes, No	Yes
Log All Events	Yes, No	Yes
Log Alarm Events	Yes, No	Yes
Log Open/Close Events	Yes, No	Yes
Log Trouble Events	Yes, No	Yes
Log Non Security Events	Yes, No	Yes
Log Bypass Events	Yes, No	Yes

### Zone Programming

The defaults are shown. Refer to the Programming Field Explanations for additional information.

Zones 1-64 are RF Zones, RF Zones 65-69 are Garage Door Zones. (Refer to "SENSORS" in AlarmNet 360)

Zones 131-162 are Keyfob Zones (Refer to "KEYFOBS" in AlarmNet 360)

Zones 280-291 are Temperature Zones (Refer to "SENSORS" in AlarmNet 360)

Zones 850-857 are Keypad Zones (Refer to "KEYPADS" in AlarmNet 360)

Zones 995, 996, 998 and 999 are Panic Zones (Refer to "SENSORS" in AlarmNet 360)

## Programming Default Values (Continued)

For Zone Programming Options refer to Explanation of Zone Assignment Table Headings

Zone No.	Loop No.	Device Type	Response Type	Alarm Report	Chime	Supervision	Arm Night	Zone Descriptor
1	2	Door	Entry Exit 1	Yes	Standard	Supervised	N/A	Front
2	2	Door	Entry Exit 1	Yes	Standard	Supervised	N/A	Back
3	2	Window	Perimeter	Yes	Standard	Supervised	N/A	
4	2	Window	Perimeter	Yes	Standard	Supervised	N/A	
5	2	Window	Perimeter	Yes	Standard	Supervised	N/A	
6	2	Window	Perimeter	Yes	Standard	Supervised	N/A	
7	1	Motion Sensor	Interior with Delay	Yes	Disabled	Supervised	No	
8	8	Smoke Detector	Fire No Verification	Yes	Disabled	Supervised	N/A	
9-64			See Programming Field Explanations					
131	3	Key Fob	Arm Away	Yes	Disabled	Button	N/A	
132	2	Key Fob	Disarm	Yes	Disabled	Button	N/A	
133	4	Key Fob	No Response	No	Disabled	Button	N/A	
134	1	Key Fob	No Response	No	Disabled	Button	N/A	
135	3	Key Fob	Arm Away	Yes	Disabled	Button	N/A	
136	2	Key Fob	Disarm	Yes	Disabled	Button	N/A	
137	4	Key Fob	No Response	No	Disabled	Button	N/A	
138	1	Key Fob	No Response	No	Disabled	Button	N/A	
139	3	Key Fob	Arm Away	Yes	Disabled	Button	N/A	
140	2	Key Fob	Disarm	Yes	Disabled	Button	N/A	
141	4	Key Fob	No Response	No	Disabled	Button	N/A	
142	1	Key Fob	No Response	No	Disabled	Button	N/A	
143	3	Key Fob	Arm Away	Yes	Disabled	Button	N/A	
144	2	Key Fob	Disarm	Yes	Disabled	Button	N/A	
145	4	Key Fob	No Response	No	Disabled	Button	N/A	
146	1	Key Fob	No Response	No	Disabled	Button	N/A	
147	3	Key Fob	Arm Away	Yes	Disabled	Button	N/A	
148	2	Key Fob	Disarm	Yes	Disabled	Button	N/A	
149	4	Key Fob	No Response	No	Disabled	Button	N/A	
150	1	Key Fob	No Response	No	Disabled	Button	N/A	
151	3	Key Fob	Arm Away	Yes	Disabled	Button	N/A	
152	2	Key Fob	Disarm	Yes	Disabled	Button	N/A	
153	4	Key Fob	No Response	No	Disabled	Button	N/A	
154	1	Key Fob	No Response	No	Disabled	Button	N/A	
155	3	Key Fob	Arm Away	Yes	Disabled	Button	N/A	
156	2	Key Fob	Disarm	Yes	Disabled	Button	N/A	
157	4	Key Fob	No Response	No	Disabled	Button	N/A	
158	1	Key Fob	No Response	No	Disabled	Button	N/A	
159	3	Key Fob	Arm Away	Yes	Disabled	Button	N/A	
160	2	Key Fob	Disarm	Yes	Disabled	Button	N/A	
161	4	Key Fob	No Response	No	Disabled	Button	N/A	
163	1	Key Fob	No Response	No	Disabled	Button	N/A	
280	N/A	Temperature	Monitor	Yes	Disabled	High Temp	N/A	
281	N/A	Temperature	Monitor	Yes	Disabled	Low Temp	N/A	
282	N/A	Temperature	Monitor	Yes	Disabled	High Temp	N/A	
283	N/A	Temperature	Monitor	Yes	Disabled	Low Temp	N/A	
284	N/A	Temperature	Monitor	Yes	Disabled	High Temp	N/A	
285	N/A	Temperature	Monitor	Yes	Disabled	Low Temp	N/A	
286	N/A	Temperature	Monitor	Yes	Disabled	High Temp	N/A	
287	N/A	Temperature	Monitor	Yes	Disabled	Low Temp	N/A	
288	N/A	Temperature	Monitor	Yes	Disabled	High Temp	N/A	
289	N/A	Temperature	Monitor	Yes	Disabled	Low Temp	N/A	
290	N/A	Temperature	Monitor	Yes	Disabled	High Temp	N/A	
291	N/A	Temperature	Monitor	Yes	Disabled	Low Temp	N/A	
850	N/A	SiX™ Keypad	N/A	N/A	N/A	60Min	N/A	
851	N/A	SiX™ Keypad	N/A	N/A	N/A	60Min	N/A	
852	N/A	SiX™ Keypad	N/A	N/A	N/A	60Min	N/A	
853	N/A	SiX™ Keypad	N/A	N/A	N/A	60Min	N/A	
854	N/A	SiX™ Keypad	N/A	N/A	N/A	60Min	N/A	
855	N/A	SiX™ Keypad	N/A	N/A	N/A	60Min	N/A	
856	N/A	SiX™ Keypad	N/A	N/A	N/A	60Min	N/A	
857	N/A	SiX™ Keypad	N/A	N/A	N/A	60Min	N/A	
995	N/A	Fire	Fire No Verification	Yes	Disabled	Panic Trigger	N/A	
996	N/A	Medical	24 Hour Auxiliary	Yes	Disabled	Panic Trigger	N/A	
998	N/A	Local Alarm	Local Alarm	Yes	Disabled	Panic Trigger	N/A	
999	N/A	Police	24 Hour Silent	Yes	Disabled	Panic Trigger	N/A	

## Programming Default Values (Continued)

### Explanation of Zone Assignment Table Headings

**Loop Number** - Used with 5800 Devices. Entries are 1-4, depending on device being used. Refer to the transmitter's instructions or the figure provided for appropriate loop numbers.

**Device Type**- Dependent upon the Zone Number being programmed.

**Response Type** - Dependent upon the Device Type that has been selected.

**Alarm Report** - Activate/Deactivate reporting option for the device.  
Options: Yes, No

**Chime** - Enable/Disable chime sounding for the device (applies to Entry/Exit, Perimeter and Interior Response Types only).

Disabled	Melody Long	Alert 1	Doorbell 2
Standard	Ascend	Alert 2	Evolve
Melody	Ascend Long	Doorbell 1	

**Supervision** - Dependent upon the Zone Number being programmed.

Wireless Zone (Zone 1-69)	Key Zone (Zone 131-162)	Temperature Zone (Zone 280-291)
Supervised	Button	High Temp
Unsupervised		Low Temp

**Arm Night** - Activate/Deactivate specific Motion Sensors at (applies to Motion Sensor Response Type only).  
Options: Yes, No

**Zone Description1/2** - Enter Zone Descriptors on displayed keypad. System Announces pre-programmed voice descriptors.

### Device/Response Type Matrix





Device Type	Response Type	Entry Exit 1	Entry Exit 2	Perimeter	Resident Monitor	Resident Response	General Monitor	General Response	Day/Night	Interior Follower	Interior With Delay	Fire No Verification	Fire With Verification	Carbon Monoxide	24 Hour Auxiliary	24 Hour Audible	24 Hour Silent	Monitor	Not Used	Arm Stay	Arm Away	Disarm	No Response	Silent Burglary	Garage	Garage Monitor	Trouble	Local Alarm
Carbon Monoxide Detector														x														
Door		x	x	x	x	x	x	x																				
Environmental															x			x										
Fire												x							x									
Flood															x			x										
Garage Door																									x	x		
Glass Break				x	x	x	x	x																				
Heat Sensor												x																
Medical															x	x			x									
Motion Sensor				x	x	x	x	x	x	x	x																	
Other		x	x	x	x	x	x	x	x	x	x	x	x	x	x	x	x	x	x	x	x	x	x	x	x	x	x	x
Police															x	x	x		x									
Smoke Detector												x	x															
Temperature															x			x										
Window		x	x	x	x	x	x	x																				



## Zone Response Type Matrix

### SiX™ Series Device Signal Strength

Signal strength for the enrolled SiX Series Devices is displayed on the Zone Programming Screen for the individual Zone that is programmed. Signal strength information is provided below.

Icon	Description	Signal Strength
	Four Green Bars	Supérieure à -27 dBm
	Three Green Bars	Supérieure à -45 dBm
	Two Green Bars	Supérieure à -63 dBm
	One Green Bar	Supérieure à -81 dBm
	Four Red Bars	Inférieure à -81 dBm (en dessous du seuil)

## Regulatory Agency Statements

### Federal Communications Commission (FCC) Part 15

The user shall not make any changes or modifications to the equipment unless authorized by the Installation Instructions or User's Manual. Unauthorized changes or modifications could void the user's authority to operate the equipment.

#### CLASS B DIGITAL DEVICE STATEMENT

NOTE: This equipment has been tested and found to comply with the limits for a Class B digital device, pursuant to part 15 of the FCC Rules. These limits are designed to provide reasonable protection against harmful interference in a residential installation. This equipment generates, uses and can radiate radio frequency energy and, if not installed and used in accordance with the instructions, may cause harmful interference to radio communications. However, there is no guarantee that interference will not occur in a particular installation. If this equipment does cause harmful interference to radio or television reception, which can be determined by turning the equipment off and on, the user is encouraged to try to correct the interference by one or more of the following measures:

- Reorient or relocate the receiving antenna.
- Increase the separation between the equipment and receiver.
- Connect the equipment into an outlet on a circuit different from that to which the receiver is connected.
- Consult the dealer or an experienced radio/TV technician for help.

This Class B digital apparatus complies with Canadian ICES-003.

Cet appareil numérique de la classe B est conforme à la norme NMB-003 du Canada.

#### FCC IC Statement

This device complies with Part 15 of FCC Rules and RSS-210 of Industry Canada. Operation is subject to the following two conditions: (1) This device may not cause harmful interference, and (2) This device must accept any interference received, including interference that may cause undesired operation.

Cet appareil est conforme à la partie 15 des règles de la FCC & de RSS-210 des Industries Canada. Son fonctionnement est soumis aux conditions suivantes: (1) Cet appareil ne doit pas causer d'interférences nuisibles. (2) Cet appareil doit accepter toute interférence reçue y compris les interférences causant une réception indésirable.

### RF Exposure Warning



The antenna(s) used for this transmitter must be installed to provide a separation distance of at least 7.8 in (20 cm) from all persons and must not be co-located or operated in conjunction with any other transmitter except in accordance with FCC multi-transmitter product procedures.

### Mise en Garde

**Exposition aux Fréquences Radio:** L'antenne (s) utilisée pour cet émetteur doit être installée à une distance de séparation d'au moins 7,8 pouces (20 cm) de toutes les personnes.

### IMPORTANT NOTES ABOUT EXTERNAL ANTENNAS

If an external cellular radio antenna is used, the antenna may be installed or replaced ONLY by a professional installer.

#### TO THE INSTALLER

For the Lyric-3G, the external antenna must not exceed a maximum directional gain (including cable loss) of 3.2 dBi at 850 MHz and 2.3 dBi at 1900 MHz.

For the Lyric-CDMA, the external antenna must not exceed a maximum directional gain (including cable loss) of 8.5 dBi at 850 MHz and 4.1 dBi at 1900 MHz.

## WARNING THE LIMITATIONS OF THIS ALARM SYSTEM

While this System is an advanced design security system, it does not offer guaranteed protection against burglary, fire or other emergency. Any alarm system, whether commercial or residential, is subject to compromise or failure to warn for a variety of reasons. For example:

- Intruders may gain access through unprotected openings or have the technical sophistication to bypass an alarm sensor or disconnect an alarm warning device.
- Intrusion detectors (e.g., passive infrared detectors), smoke detectors, and many other sensing devices will not work without power. Battery-operated devices will not work without batteries, with dead batteries, or if the batteries are not put in properly. Devices powered solely by AC will not work if their AC power supply is cut off for any reason, however briefly.
- Signals sent by wireless transmitters may be blocked or reflected by metal before they reach the alarm receiver. Even if the signal path has been recently checked during a weekly test, blockage can occur if a metal object is moved into the path.
- A user may not be able to reach a panic or emergency button quickly enough.
- While smoke detectors have played a key role in reducing residential fire deaths in the United States, they may not activate or provide early warning for a variety of reasons in as many as 35% of all fires, according to data published by the Federal Emergency Management Agency. Some of the reasons smoke detectors used in conjunction with this System may not work are as follows. Smoke detectors may have been improperly installed and positioned. Smoke detectors may not sense fires that start where smoke cannot reach the detectors, such as in chimneys, in walls, or roofs, or on the other side of closed doors. Smoke detectors also may not sense a fire on another level of a residence or building. A second floor detector, for example, may not sense a first floor or basement fire. Finally, smoke detectors have sensing limitations. No smoke detector can sense every kind of fire every time. In general, detectors may not always warn about fires caused by carelessness and safety hazards like smoking in bed, violent explosions, escaping gas, improper storage of flammable materials, overloaded electrical circuits, children playing with matches, or arson. Depending on the nature of the fire and/or location of the smoke detectors, the detector, even if it operates as anticipated, may not provide sufficient warning to allow all occupants to escape in time to prevent injury or death.
- Passive Infrared Motion Detectors can only detect intrusion within the designed ranges as diagrammed in their installation manual. Passive Infrared Detectors do not provide volumetric area protection. They do create multiple beams of protection, and intrusion can only be detected in unobstructed areas covered by those beams. They cannot detect motion or intrusion that takes place behind walls, ceilings, floors, closed doors, glass partitions, glass doors, or windows. Mechanical tampering, masking, painting or spraying of any material on the mirrors, windows or any part of the optical system can reduce their detection ability. Passive Infrared Detectors sense changes in temperature; however, as the ambient temperature of the protected area approaches the temperature range of 90° to 105°F (32° to 40°C), the detection performance can decrease.
- Alarm warning devices such as sirens, bells or horns may not alert people or wake up sleepers if they are located on the other side of closed or partly open doors. If warning devices are located on a different level of the residence from the bedrooms, then they are less likely to waken or alert people inside the bedrooms. Even persons who are awake may not hear the warning if the alarm is muffled by noise from a stereo, radio, air conditioner or other appliance, or by passing traffic. Finally, alarm warning devices, however loud, may not warn hearing-impaired people.
- **Communication paths needed to transmit alarm signals from a premises to a central monitoring station may be out of service or temporarily out of service. Communication paths are also subject to compromise by sophisticated intruders.**
- Even if the system responds to the emergency as intended, occupants may have insufficient time to protect themselves from the emergency situation. In the case of a monitored alarm system, authorities may not respond appropriately.
- This equipment, like other electrical devices, is subject to component failure. Even though this equipment is designed to last as long as 10 years, the electronic components could fail at any time.

The most common cause of an alarm system not functioning when an intrusion or fire occurs is inadequate maintenance. This alarm system should be tested weekly to make sure all sensors and transmitters are working properly. The security keypad (and remote keypad) should be tested as well.

Wireless transmitters are designed to provide long battery life under normal operating conditions. Longevity of batteries may be as much as 4 to 7 years, depending on the environment, usage, and the specific wireless device being used. External factors such as humidity, high or low temperatures, as well as large swings in temperature, may all reduce the actual battery life in a given installation. This wireless system, however, can identify a true low battery situation, thus allowing time to arrange a change of battery to maintain protection for that given point within the system.

Installing an alarm system may make the owner eligible for a lower insurance rate, but an alarm system is not a substitute for insurance. Homeowners, property owners and renters should continue to act prudently in protecting themselves and continue to insure their lives and property.

We continue to develop new and improved protection devices. Users of alarm systems owe it to themselves and their loved ones to learn about these developments.

### Agency Notices

1. For Residential Burglar Alarm installations with line security, total exit delay time must not exceed 60 seconds. For Burglar Alarm installations without line security, total exit delay time must not exceed 120 seconds.
2. Periodic testing must be at least every 24 hours.
3. Remote downloading without an alarm company technician on-site (unattended downloading) is not permissible for ETL installations.
4. As SIA limits for delay of alarm reporting and sounding can exceed UL Standard limits for commercial and residential applications, the following requirements per UL681 are provided:  
 The maximum time that a control unit shall be programmed to delay the transmission of a signal to a remote monitoring location, or to delay the energizing of a local alarm sounding device to permit the alarm system user to enter and disarm the system, or to arm the system and exit shall not exceed:
  - a) 60 seconds for a system with standard line security or encrypted line security,
  - b) 120 seconds for a system without standard line security or encrypted line security, or
  - c) 120 seconds for a system that does not transmit an alarm signal to a remote monitoring location.

### SIA Quick Reference Guide

Programming Section	Feature	Range	Shipping Default	SIA Requirement
<b>Installation and Setup Guide or Programming Guide</b>				
<b>Reporter/ Report Selection</b>	Exit Error	Not selectable	Enabled	Enabled
	Recent Closing	Not selectable	Enabled	Enabled
	Alarm Cancel	Enabled or Disabled	Enabled	Enabled
<b>Reporter/Options</b>	Number of Reports	1 to 6 Reports	2 Reports	2 Reports
	Alarm Report Delay (Abort Window)	15, 30 and 45 seconds	30 seconds	30 seconds*
<b>System Settings</b>	Entry Delay # 1	None, 15, 30, 45, 60 and 90 seconds and 2, 3 or	30 seconds	30 seconds minimum
	Entry Delay # 2	None, 15, 30, 45, 60 and 90 seconds and 2, 3 or	30 seconds	30 seconds minimum
	Exit Delay	45, 60, 90 seconds and 2 minutes	60 Seconds	45 seconds minimum
	Restart Exit Time	Enabled or Disabled	Yes (Enabled)	Enabled
	Exit Warning	Not selectable	Yes (Enabled)	Enabled
	Auto Stay Arming	Enabled or Disabled	Yes (Enabled)	Enabled
	Cross Zone Delay	30 seconds and 2 minutes (in 30 second increments), 3 minutes	None (Disabled)	Enabled and two zones programmed
<b>Zones</b>	Fire Alarms	Zone Type "Fire with Verification" must be selected for Fire Zone	Disabled	Disabled
<b>User Guide</b>				
<b>User Functions/ User Access</b>	Duress	Duress Code is Programmed by Master User as User 48	Disabled	Disabled
<b>System Functions/ Testing the System**</b>	System Test	System tests provided as a User Function	n/a	n/a
	Communications	While the system is in Test mode, no alarm reports are sent to the Central Station	Disabled	Disabled

\* Combined Entry Delay and Alarm Report Delay (Abort Window) should not exceed 1 minute.

\*\* Refer to the User Guide for procedures on Testing the System.

## Specifications

### Lyric Gateway Residential Burglar and Fire Alarm Control Panel

**Physical:**

Dimensions: 8.75" (222mm) W x 7" (178mm) H x 1.5" (38mm) D

**Electrical:**

Voltage Input: 110VAC, 60 Hz/9 Vdc from plug-in 2.5A power supply

Rechargeable Backup Battery: Nickel-metal hydride battery pack rated at 7.2 Vdc

**Communication:**

Formats Supported: ADEMCO Contact ID® Reporting, 10 characters/sec

SIA/DCS Format, 2225Hz Handshake, Data Tones, 2025/2235Hz, baud

For patent information, see [www.honeywell.com/patents](http://www.honeywell.com/patents)

## ***Glossary***

AES – Advanced Encryption Standard

APL – Advanced Protection Logic

dBm – decibels milliwatt (power ratio)

CDMA - Code Division Multiple Access is a channel access method used by various radio communication technologies that allows many users to occupy the same time and frequency allocations in a given band/space.

DHCP – Dynamic Host Configuration Protocol, which provides a mechanism for allocating IP addresses dynamically so that addresses can be reused when hosts no longer need them.

DNS – Domain Name System, which is a distributed hierarchical naming system used to resolve domain names (e.g., www.yahoo.com) into numerical IP addresses (e.g., 204.17.25.1).

Ec/Io – Signal to noise ratio of the current channel for CDMA (Measured in dB).

Eb/No – Signal to noise ratio of the current channel for UTMS (3G) (Measured in dB).

ESN – Electronic Serial Number (32 bit number that identifies a CDMA device)

Gateway IP Address – A gateway (sometimes called a router) is a computer and/or software used to connect two or more networks (including incompatible networks) and translates information from one network to the other. The Gateway IP address is the IP address for the gateway.

GPRS – General Packet Radio Service

GSM – Global System for Mobile communications, which is an international standard for digital mobile phone systems used for cellular communication.

HSDPA – High-Speed Downlink Packet Access

HSPA – High-Speed Packet Access

ICCID – Integrated Circuit Card Identifier (SIM Card serial number)

IMEI – International Mobile Equipment Identity number

IP – Internet Protocol

IP Address – A unique number consisting of four parts separated by periods, sometimes called a "dotted quad.," for example: 204.17.29.11, assigned to every computer/workstation connected to the Internet. IP numbers can be "static" (assigned and unchanging) or "dynamic," assigned via DHCP at each and every startup.

ISP – Internet Service Provider

KBPS – Kilobits per second

MAC ID – Media Access Code; located on the module label.

MEID – Mobile Equipment Identifier (56 bit number that identifies a CDMA device)

NIC – Network Interface Card

RSCP – Received Signal Code Power (Ratio of RSSI and Ec/No)

RSSI – Received Signal Strength Indication

SCID – SIM Card ID

Subnet Mask – A Subnet is a portion of a network that shares a network address with other portions of the network, and is distinguished by a subnet number. The Subnet Mask is a 32-bit address mask used in IP to indicate the bits of an IP address that are being used for the subnet address.

UMTS – Universal Mobile Telecommunications Service

WEP – Wired Equivalent Privacy

WPA – WiFi Protected Access

WPS – WiFi Protected Setup

## Contacting Technical Support

**PLEASE, before you call Technical Support, be sure you:**

- READ THE INSTRUCTIONS!
- Check all wiring connections.
- Determine that the power supply and/or backup battery are supplying proper voltages.
- Verify your programming information where applicable.
- Note the proper model number of this product, and the version level (if known) along with any documentation that came with the product.
- Note your Honeywell customer number and/or company name.

Having this information handy will make it easier for us to serve you quickly and effectively.

<p><i>Technical Support:</i> ..... 1-800-645-7492 (8 a.m.-10 p.m. E.S.T.)</p> <p><i>MyWebTech:</i> ..... <a href="https://www.mywebtech/honeywell.com">https:// www.mywebtech/honeywell.com</a></p>
---

## - Index -

24-Hour Silent.....	22	User Security Code .....	22
300-03864-AIO .....	7	Master User Tools Screen.....	17
300-03866-AIO .....	7	Memory of Alarm.....	22
300-04063V1.....	10	Navigating Menus.....	15, 17
300-04705V1.....	10	Navigation Keys .....	16
5800 Series Transmitter Loop Numbers.....	14	News.....	16
5800 Series Transmitters.....	13	Operator Commands.....	25
5802MN.....	13	Panic Key/Icons .....	22
5804E .....	13	Plug-In Power Supply .....	10
5816.....	13	Range .....	13
5834-4 .....	13	Reboot .....	29
5878.....	13	Rebooting the System.....	29
AC Power.....	10	Regulatory Agency Statements.....	36
AC Power Loss .....	7	Reset Master User Code.....	23
ADEMCO Contact ID.....	39	RF House Code.....	13
Armed System Test.....	28	Secondary User Codes .....	22
Audio Alarm Verification (Two-Way Voice Feature) .....	25	Security Codes.....	22
Babysitter Code .....	22	Security Screen .....	17
Backup Battery .....	10, 39	Programming Default Tables .....	30, 31, 32
Button Transmitters .....	13	Sixfob .....	13
CDMA Cellular Communications Module .....	11	Six™ Series Transmitters .....	13
Communication Modules.....	11	Sniffer Mode .....	28
Contact ID Event Log Codes .....	26, 27	Specifications.....	39
Contact ID Reporting.....	39	Super High Capacity Battery .....	11
Contacting Technical Support .....	41	Supervised RF.....	13
Devices.....	2	System Features .....	5, 6
Duress Code .....	22	System Operation.....	22
Enter Installer Programming Mode .....	18	System Standby Screen.....	18
Enter/Change The Master Code.....	22	Technical Support .....	41
Entry Delay .....	20	Test Modes.....	28
Entry/Exit Burglary.....	20	Testing the System .....	28, 29
Exit Delay .....	20, 28, 38	Touch-Screen Display .....	15
Exit Programming Mode.....	19	Traffic.....	16
GSM Cellular Communications Module.....	11	Transmitter Battery Life.....	13
Home Screen.....	16	Transmitter Input Type.....	13
House ID Code.....	13	Transmitter Loop Numbers .....	14
House Identification .....	13	Transmitter Supervision.....	13
Installer Code.....	22	Unsupervised Button.....	13
Installer Tools Menu Screen.....	18	Unsupervised RF.....	13
Installing Wireless Zones.....	14	Wall Mounting.....	8, 10
Key/Touchscreen Operation.....	22	Wireless Keys.....	13
Liquid Crystal Display (LCD) Touch-Screen ...	15	Wireless Zones .....	13
Loading Factory Defaults.....	19	World Wide Web Address.....	41
LYRIC-3G.....	11	Zone Discovery.....	29
LYRIC-CDMA.....	11	Zone Programming Default Values .....	34
Master Code .....	22	Zone Response Type Definitions.....	20
Master Security Code.....	22	Zone Response Type Matrix.....	35



THIS EQUIPMENT SHOULD BE INSTALLED IN ACCORDANCE WITH THE NATIONAL FIRE PROTECTION ASSOCIATION STANDARDS ANS/NFPA 70 NATIONAL ELECTRIC CODE AND NFPA 72 NATIONAL FIRE ALARM CODE, CHAPTER 2 (NATIONAL FIRE PROTECTION ASSOC., BATTERYMARCH PARK, QUINCY, MA 02169). PRINTED INFORMATION DESCRIBING PROPER INSTALLATION, EVACUATION PLANNING AND REPAIR SERVICE IS TO BE PROVIDED WITH THIS EQUIPMENT.

LYRIC GATEWAY ALSO COMPLIES WITH THE FOLLOWING: CANADIAN STANDARDS ASSOCIATION (CSA) C22.1, CANADIAN ELECTRICAL CODE, PART 1, SAFETY STANDARD FOR ELECTRICAL INSTALLATIONS AND CAN/ULC-S540 INSTALLATION OF RESIDENTIAL FIRE WARNING SYSTEMS.

THIS DEVICE COMPLIES WITH PART 15 OF FCC RULES. OPERATION IS SUBJECT TO THE FOLLOWING TWO CONDITIONS: (1) THIS DEVICE MAY NOT CAUSE HARMFUL INTERFERENCE, AND (2) THIS DEVICE MUST ACCEPT ANY INTERFERENCE RECEIVED, INCLUDING INTERFERENCE THAT MAY CAUSE UNDESIRABLE OPERATION.

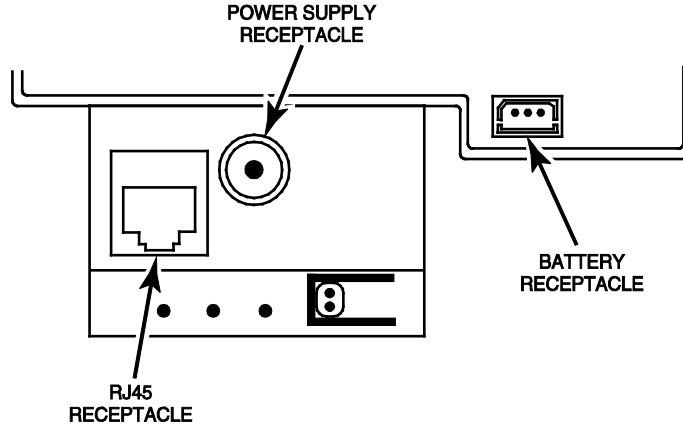

**IMPORTANT NOTES ABOUT EXTERNAL ANTENNAS**  
 IF AN EXTERNAL CELLULAR RADIO ANTENNA IS USED, THE ANTENNA MAY BE INSTALLED OR REPLACED ONLY BY A PROFESSIONAL INSTALLER. FOR THE LYRIC-9G THE EXTERNAL ANTENNA MUST NOT EXCEED A MAXIMUM DIRECTIONAL GAIN (INCLUDING CABLE LOSS) OF 3.2 dBI AT 850 MHz AND 2.3 dBI AT 1900 MHz. FOR THE LYRIC-CDMA THE EXTERNAL ANTENNA MUST NOT EXCEED A MAXIMUM DIRECTIONAL GAIN (INCLUDING CABLE LOSS) OF 8.5 dBI AT 850 MHz AND 4.1 dBI AT 1900 MHz.

**WEEKLY TESTING IS REQUIRED TO ENSURE PROPER OPERATION OF THIS SYSTEM**

THE LYRIC GATEWAY IS COMPATIBLE WITH THE FOLLOWING INTEGRAL RECHARGEABLE BATTERY PACKS:  
 P/N 300-03884-AIO (STANDARD CAPACITY)  
 P/N 300-03888-AIO (HIGH CAPACITY)  
**REPLACE EVERY FOUR YEARS**

**WARNING**  
 THIS UNIT MAY BE PROGRAMMED TO INCLUDE AN ALARM VERIFICATION FEATURE THAT WILL RESULT IN A DELAY OF THE SYSTEM ALARM SIGNAL FROM THE INDICATED FIRE CIRCUITS. THE TOTAL DELAY (CONTROL UNIT PLUS SMOKE DETECTORS) SHALL NOT EXCEED 80 SECONDS. NO OTHER INITIATING DEVICES SHALL BE CONNECTED TO THESE CIRCUITS UNLESS APPROVED BY THE LOCAL AUTHORITY HAVING JURISDICTION.

CIRCUIT (ZONE)	CONTROL UNIT		SMOKE DETECTOR	
	DELAY-SEC	MODEL	DELAY-SEC	DELAY-SEC
03 - 126 ZONE TYPE - SUPERVISED FIRE WITH VERIFICATION	30 seconds	5806W3	10 seconds	

gw\_keypad-SOC-V0

**LYRIC GATEWAY RESIDENTIAL BURGLAR AND FIRE ALARM CONTROL PANEL SUMMARY OF CONNECTIONS**

**Notes:** Connection of the fire alarm signal to a fire alarm headquarters or a Central Station shall be permitted with the approval of the local authority having jurisdiction. The burglar alarm signal shall not be connected to a police emergency number. The System must be checked by a qualified technician once every three years

## **SUPPORT, WARRANTY, & PATENT INFORMATION**

For the latest documentation and online support information, please go to:  
<https://mywebtech.honeywell.com/>

For the latest warranty information, please go to:  
[www.honeywell.com/security/hsc/resources/wa](http://www.honeywell.com/security/hsc/resources/wa).

For patent information, see [www.honeywell.com/patents](http://www.honeywell.com/patents)



**MyWebTech**



**Warranty**



**Patents**

# **Honeywell**

**2 Corporate Center Drive, Suite 100  
P.O. Box 9040, Melville, NY 11747  
Copyright © 2016 Honeywell International Inc.**

[www.honeywell.com/security](http://www.honeywell.com/security)



800-21666 10/16 Rev. A