

Preliminary Draft 1/19/11

Honeywell

DolphinTM 99EX Mobile Computer

with Windows[®] Embedded Handheld 6.5

User's Guide

Preliminary Draft 1/19/11

Disclaimer

Honeywell International Inc. ("HII") reserves the right to make changes in specifications and other information contained in this document without prior notice, and the reader should in all cases consult HII to determine whether any such changes have been made. The information in this publication does not represent a commitment on the part of HII.

HII shall not be liable for technical or editorial errors or omissions contained herein; nor for incidental or consequential damages resulting from the furnishing, performance, or use of this material.

This document contains proprietary information that is protected by copyright. All rights are reserved. No part of this document may be photocopied, reproduced, or translated into another language without the prior written consent of HII.

Web Address: www.honeywellaidc.com

Trademarks

Dolphin, Dolphin RF, HomeBase, Mobile Base, and QuadCharger are trademarks or registered trademarks of Hand Held Products, Inc. or Honeywell International Inc.

Microsoft, Windows, Windows Mobile, Windows Embedded Handheld, Windows CE, Windows 98 Second Edition, Windows NT, Windows 2000, Windows ME, Windows XP, ActiveSync, Outlook, and the Windows logo are trademarks or registered trademarks of Microsoft Corporation.

Other product names mentioned in this manual may be trademarks or registered trademarks of their respective companies and are the property of their respective owners.

Patents

For patent information, please refer to www.honeywellaidc.com/patents.

Other Trademarks

The Bluetooth trademarks are owned by Bluetooth SIG, Inc., U.S.A. and licensed to Honeywell.

©2011 Honeywell International Inc. All rights reserved.



Preliminary Draft 1/19/11

Table of Contents

Chapter 1 - Agency Information

Laser Safety	1-1
Label Locations	1-1
Laser Safety Label	1-1
Laser Eye Safety Statement	1-1
LED Safety	1-2
LED Safety Statement.....	1-2
Infrared LED Safety Statement	1-2
UL and C-UL Statement.....	1-2
Approvals by Country.....	1-2
R&TTE Compliance Statement—802.11a/b/g/n, Bluetooth, and/or GSM.....	1-2
Dolphin RF Terminal—802.11a/b/g/n, Bluetooth, and/or GSM.....	1-3
Canadian Compliance.....	1-4
Conformité à la réglementation canadienne	1-4
RF Exposure Information (SAR)	1-4
For European Community Users	1-5
Waste Electrical and Electronic Equipment Information	1-5

Chapter 2 - Getting Started

Out of the Box	2-1
Home Screen	2-4
Title Bar.....	2-4
Icons in the Title Bar	2-4
Horizontal Scroll.....	2-7
Tile Bar.....	2-7
Pop-Up Menus	2-7
Selecting Programs.....	2-8
File Explorer.....	2-8
Search.....	2-9

Chapter 3 - Hardware Overview

Standard Configurations for the 99EX	3-1
Peripherals for the 99EX.....	3-2
Accessories for the 99EX.....	3-3
Front Panel: 99EX.....	3-5
Front Panel Features for the 99EX	3-5
Back Panel: 99EX	3-7
Back Panel Features for the 99EX.....	3-7
Side Panels: 99EX	3-9
Left Side	3-9
Right Side	3-9
Installing a Memory Card	3-10
Installing a SIM Card.....	3-10
Bottom Panel: 99EX.....	3-11
I/O Connector.....	3-11

Preliminary Draft 1/19/11

Using the Touch Panel	3-12
Installing a Screen Protector.....	3-12
Healthcare Housing	3-12
Batteries	3-13
Main Battery Pack.....	3-13
Internal Backup Battery	3-14
Managing Battery Power	3-15
Checking Battery Power	3-16
Resetting the Terminal	3-16
Soft Reset (Warm Boot).....	3-16
Hard Reset (Cold Boot)	3-17
Suspend Mode	3-17

Chapter 4 - Using the Scan Image Engine

Overview.....	4-1
Angled Imaging.....	4-1
Laser Safety	4-1
LED Safety	4-1
Image Engine Specifications	4-1
N5603 Beam Divergence Angle	4-1
Depth of Field	4-2
Supported Bar Code Symbologies	4-3
Decoding	4-4
To Decode a Bar Code.....	4-4
Aiming Options	4-4
Capturing Images	4-6
Taking an Image.....	4-6
Uploading Images.....	4-7

Chapter 5 - Using the Color Camera

Overview.....	5-1
Taking a picture using the Camera Demo tool	5-1
Options	5-2
Taking a picture using the Windows Embedded Handheld 6.5 Camera tool	5-2
Menu.....	5-3
Options	5-3
Recording Video	5-3

Chapter 6 - Using the Keyboards

Available Keyboards.....	6-1
Keyboard Combinations	6-1
Common Buttons.....	6-1
Using the Function Keys.....	6-2
Using the Modifier Keys	6-3
Using the Navigation Keys	6-3

Preliminary Draft 1/19/11

34-Key Alpha/Numeric Keyboard	6-5
ALPHA Key.....	6-5
34-Key Alpha/Numeric Keyboard Combinations	6-6
34-Key Numeric (Calculator) Keyboard	6-8
ALPHA Key.....	6-8
34-Key Numeric (Calculator) Keyboard Combinations	6-9
43-Key Alpha/Numeric Keyboard	6-11
Number Lock (NUM) Key.....	6-11
43-Key Keyboard Combinations	6-12
55-Key Full Alpha/Numeric Keyboard	6-14
55-Key Keyboard Combinations	6-14

Chapter 7 - System Settings

Overview.....	7-1
Clock & Alarms	7-2
Personal Menu	7-3
Buttons.....	7-3
System Menu.....	7-7
About	7-8
Backlight	7-9
Battery	7-10
Certificates.....	7-10
Customer Feedback	7-10
Encryption.....	7-11
Error Reporting	7-11
External GPS	7-11
Five Volt Control	7-12
HISS	7-12
Managed Programs	7-14
Memory.....	7-14
RIL	7-15
Power.....	7-16
Regional Settings.....	7-16
Remove Programs.....	7-17
Screen	7-18
Task Manager.....	7-19

Chapter 8 - Communication

Connections Menu.....	8-1
Using the IrDA Port.....	8-2
IrDA Port Location	8-2
Sending Data	8-2
Receiving Data	8-3
Connections Manager	8-4
To Access the Connections Manager.....	8-4
Tasks	8-4
Advanced.....	8-5

Preliminary Draft 1/19/11

Dolphin Wireless Manager	8-6
Dolphin Wireless Manager Window	8-6
Enabling the Radios.....	8-6
Accessing Radio Configuration Utilities	8-7
Communication.....	8-8
Installing Additional Software	8-10
Adding Programs to the Terminal Using ActiveSync.....	8-10
Adding Programs Directly from the Internet.....	8-11
99EX COM Port Assignment Table	8-12

Chapter 9 - Working with Wireless Wide Area Networking (WWAN)

Overview.....	9-1
Penta Band Antenna.....	9-1
SIM Card Installation	9-3
Installing a SIM Card	9-4
Enabling the WWAN Radio	9-5
GSM/HSPA+ Global Radio Dolphin Models	9-5
Voice Communication.....	9-5
Audio Modes.....	9-5
Volume Control.....	9-6
Accessing the Dialer Window	9-6
Dialing.....	9-6
Sending Calls.....	9-7
Ending Calls.....	9-7
Accessing Voice Mail.....	9-7
View Options.....	9-7
Setup Options.....	9-7
Data Communication	9-9
Establishing Data Communication (GSM/HSPA+ Global Radio Dolphin Models).....	9-9
Ending the Data Connection.....	9-11
Manual Network Selection.....	9-12
GSM/CDMA Dolphin Models	9-13
Gobi Manager.....	9-13
Establishing Data Communication (GSM/CDMA Dolphin Models).....	9-14

Chapter 10 - Working with the Bluetooth Radio

Enabling the Bluetooth Radio	10-1
Connecting to Other Bluetooth Devices	10-2
Pairing and Trusted Devices	10-4
Types of Devices and Services	10-5
Connecting to Bluetooth Printers.....	10-6
Connecting to Bluetooth Headsets	10-6
Transferring Files.....	10-7
Making the Terminal Discoverable	10-8
Selecting COM Ports	10-8

Chapter 11 - Working with GPS

Overview.....	11-1
---------------	------

Preliminary Draft 1/19/11

Assisted GPS Support.....	11-1
Powering the GPS Module	11-1
Communication Ports	11-1
Selecting the Port	11-1
COM7	11-2
GPS Intermediate Driver.....	11-2
GPS Demo	11-2

Chapter 12 - Dolphin 99EX HomeBase Device

Overview.....	12-1
Parts and Functions.....	12-2
Power	12-5
Serial Connector.....	12-5
Charging the Main Battery.....	12-6
To Power a Terminal and Charge its Main Battery.....	12-6
Charging a Spare Battery in the Auxiliary Battery Well	12-6
Communication.....	12-7
Connecting the Communication Cables	12-7
Establishing Communication	12-7
Communicating with the Dolphin Terminal	12-7
Verifying Data Transfer.....	12-8
RS232 Communications Cables.....	12-8
RS232 Pin Configuration	12-8
Mounting.....	12-9
Desk Mounting.....	12-9

Chapter 13 - Dolphin 99EX eBase Device

Overview.....	13-1
Unpacking the eBase.....	13-1
Parts and Functions.....	13-2
Front Panel	13-2
Back Panel	13-4
Bottom Panel	13-5
Power	13-5
Connecting Power to the eBase	13-5
Charging the Main Battery.....	13-6
To Power a Terminal and Charge its Main Battery.....	13-6
Charging a Spare Battery in the Auxiliary Battery Well	13-6
Communication.....	13-7
Software Requirements	13-7
Establishing Ethernet Communication.....	13-7
Establishing USB Communication	13-8
Mounting.....	13-8
Using the DIN Rail	13-8

Chapter 14 - Dolphin 99EX Mobile Base Device

Overview.....	14-1
---------------	------

Preliminary Draft 1/19/11

Front Panel	14-2
Bottom Panel	14-3
Back Panel and Mounting Brackets	14-4
Mounting	14-5
Safety Precautions	14-5
Installation	14-5
Powering the Dolphin Terminal	14-6
Charging the Dolphin Terminal	14-6
Establishing Communication	14-6
Connecting the Communication Cables	14-6
Establishing ActiveSync or Windows Mobile Device Center Communication	14-7
RS232 Communication Cables	14-7
Serial Connector	14-8

Chapter 15 - Dolphin 99EX ChargeBase Device

Overview	15-1
Parts and Functions	15-2
Front Panel	15-2
Back Panel	15-3
Power	15-3
Connecting Power to the ChargeBase	15-3
Charging the Main Battery	15-4
To Power a Terminal and Charge its Main Battery	15-4
Mounting	15-4

Chapter 16 - Dolphin 99EX Net Base Device

Overview	16-1
Parts and Functions	16-2
Front Panel	16-2
Back Panel	16-3
Bottom Panel	16-4
Power	16-4
Connecting Power to the Net Base	16-4
Charging the Main Battery	16-5
To Power a Terminal and Charge its Main Battery	16-5
Communication	16-5
Software Requirements	16-5
Connecting the Dolphin Terminal to the Net Base	16-5
Mounting the Net Base	16-6
Using the DIN Rail	16-6

Chapter 17 - Dolphin 99EX QuadCharger Device

Overview	17-1
Parts and Functions	17-2
Supplying Power	17-3
Inserting and Charging Batteries	17-3

Preliminary Draft 1/19/11

Mounting.....	17-4
Desk Mounting.....	17-4
Troubleshooting.....	17-5

Chapter 18 - Dolphin 99EX Charge Rack and Net Rack Device

Overview.....	18-1
Parts and Functions.....	18-2
Front and Side Panel.....	18-2
Back Panel.....	18-2
Power	18-2
Connecting Power to the Rack	18-3
Charging the Main Battery.....	18-3
To Power a Terminal and Charge its Main Battery.....	18-3
Communication (Net Rack Only)	18-3
Software Requirements	18-3
Connecting the Dolphin Terminal to the Net Rack	18-4
Mounting the Rack.....	18-4

Chapter 19 - Customer Support

Product Service and Repair.....	19-1
Online Product Service and Repair Assistance.....	19-1
Technical Assistance.....	19-2
Online Technical Assistance.....	19-2
Limited Warranty	19-3
How to Extend Your Warranty	19-4

Preliminary Draft 1/19/11

Preliminary Draft 1/19/11

Agency Information

Dolphin 99EX mobile computers meet or exceed the requirements of all applicable standards organizations for safe operation. However, as with any electrical equipment, the best way to ensure safe operation is to operate them according to the agency guidelines that follow. Read these guidelines carefully before using your mobile computer.

Laser Safety

Label Locations

Dolphin 99EX with WLAN

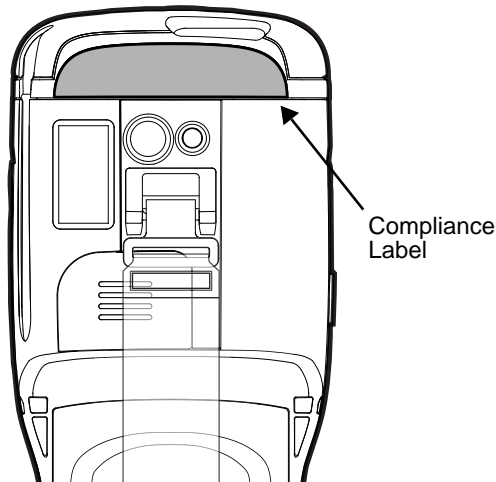

Dolphin 99EX with WWAN

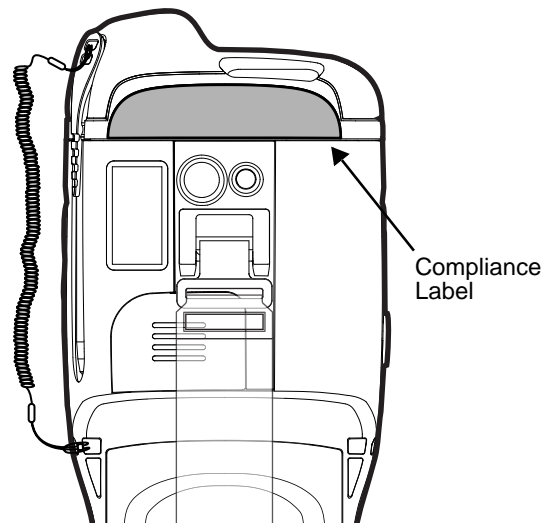

Laser Safety Label

If the following label is attached to your product, it indicates the product contains an engine with a laser aimer:

Image Engines with Integrated Laser Aimers



Laser Eye Safety Statement

This device has been tested in accordance with and complies with IEC60825-1(Ed. 2.0), EN60825-1:2007. Complies with 21 CFR 1040.10 and 1040.11, except for deviations pursuant to Laser Notice No. 50, dated June 24, 2007. LASER LIGHT, DO NOT STARE INTO BEAM. CLASS 2 LASER PRODUCT, 1.0 mW MAX OUTPUT: 650nm, pulse duration of 15.5msec, and pulse repetition rate of 32.25 Hz.

Caution! Use of controls or adjustments or performance of procedures other than those specified herein may result in hazardous radiation exposure.

Preliminary Draft 1/19/11

LED Safety

LED Safety Statement

LEDs have been tested and classified as “EXEMPT RISK GROUP” to the Standard: IEC 62471:2006.

Infrared LED Safety Statement

Caution! Do not view directly with optical instruments.

UL and C-UL Statement

UL and C-UL listed: UL60950-1 2nd Edition, and CSA C22.2 No. 60950-1-07 2nd Edition, ISA 12.12.01:2007, CAN/CSA: C22.2 No. 213-M1987.

Approvals by Country

Country	EMC, Radio, & SAR	Safety
U.S.A.	FCC Part 15, Subpart B FCC Part 15, Subpart C, 15.247 FCC Part 15, Subpart E FCC Part 22H FCC Part 24E FCC SAR OET 65 Supplement C	UL60950-1, 2nd Edition
Canada	ICES-003 (Class B) RSS 132 RSS 133 RSS 210	CSA C22.2 No. 60950-1-07, 2nd Edition
European Community/CE	EN300328, EN301893, EN55022, EN55024, EN301489-1, EN301489-7/24, EN301489-17, 3GPPTS 51.010-1, EN301511, EN301908, EN50360, EN50361, EN50371, EN50392, IEC6220-1, IEC6220-2, EN300440, 301 389- 25 (CDMA 2000)	EN60950-1, 2nd Edition EN60825-1, 2nd Edition

R&TTE Compliance Statement—802.11a/b/g/n, Bluetooth, and/or GSM

Dolphin RF terminals are in conformity with all essential requirements of the R&TTE Directive (1999/5/EC).

This product is marked with **CE0682** in accordance with the Class II product requirements specified in the R&TTE Directive. In addition, this product complies to 2006/95/EC Low Voltage Directive when supplied with the recommended power supply. Honeywell shall not be liable for use of our product with equipment (i.e., power supplies, personal computers, etc.) that is not CE marked and does not comply with the Low Voltage Directive.

Preliminary Draft 1/19/11

The equipment is intended for use throughout the European Community; PAN European Frequency Range: 2.402–2.480 GHz. Restrictions for use in France are as follows:

- Indoor use: Maximum power (EIRP*) of 100 mW for the entire 2.400–2.4835 GHz
- Outdoor use: Maximum power (EIRP*) of 100 mW for the 2.400–2.454 GHz band & maximum power (EIRP*) of 10 mW for the 2.454–2.483 MHz band.
- 5GHz band: UNII (Unlicensed National Information Infrastructure) or band1 (5.150 to 5.250 GHz) is restricted to indoor use only. Any other use will make the operation of the device illegal.

For further information, please contact:

Honeywell Scanning & Mobility Europe BV
Nijverheidsweg 9
5627 BT Eindhoven
The Netherlands

FCC Requirements

Dolphin RF Terminal—802.11a/b/g/n, Bluetooth, and/or GSM

This device complies with Part 15 of the FCC Rules. Operation is subject to the following two conditions: (1) this device may not cause harmful interference, and (2) this device must accept any interference received, including interference that may cause undesired operation.

This equipment has been tested and found to comply with the limits for a Class B digital device pursuant to Part 15 of the FCC Rules. These limits are designed to provide reasonable protection against harmful interference in a residential installation. This equipment generates, uses, and can radiate radio frequency energy and, if not installed and used in accordance with the instructions, may cause harmful interference to radio communications. However, there is no guarantee that interference will not occur in a particular installation. If this equipment does cause harmful interference to radio or television reception, which can be determined by turning the equipment off and on, the user is encouraged to try to correct the interference by one or more of the following measures:

- Reorient or relocate the receiving antenna.
- Increase the separation between the equipment and receiver.
- Connect the equipment into an outlet on a circuit different from that to which the receiver is connected.
- Consult the dealer or an experienced radio/TV technician for help.

In accordance with FCC 15.21, changes or modifications not expressly approved by the party responsible for compliance could void the user's authority to operate the equipment.

The antenna(s) used for this transmitter must not be co-located or operating in conjunction with any other antenna or transmitter.

If necessary, the user should consult the dealer or an experienced radio/television technician for additional suggestions. The user may find the following booklet helpful: "Something About Interference." This is available at FCC local regional offices. Our company is not responsible for any radio or television interference caused by unauthorized modifications of this equipment or the substitution or attachment of connecting cables and equipment other than those specified by our company. The correction is the responsibility of the user. Use only shielded data cables with this system.

Preliminary Draft 1/19/11

Canadian Compliance

This Class B digital apparatus complies with Canadian ICES-003 and RSS210. Operation is subject to the following two conditions:

1. This device may not cause harmful interference.
2. This device must accept any interference received, including interference that may cause undesired operation.

Conformité à la réglementation canadienne

Cet appareil numérique de la Classe B est conforme à la norme NMB-003 et RSS210 du Canada. Son fonctionnement est assujéti aux conditions suivantes:

1. Cet appareil ne doit pas causer de brouillage préjudiciable.
2. Cet appareil doit pouvoir accepter tout brouillage reçu, y compris le brouillage pouvant causer un fonctionnement indésirable.

RF Exposure Information (SAR)

This mobile phone meets the government's requirements for exposure to radio waves. This phone is designed and manufactured not to exceed the emission limits for exposure to radio frequency (RF) energy set by the Federal Communications Commission of the U.S. Government.

The exposure standard for wireless mobile phones employs a unit of measurement known as the Specific Absorption Rate, or SAR. The SAR limit set by the FCC is 1.6W/kg. *Tests for SAR are conducted using standard operating positions accepted by the FCC with the phone transmitting at its highest certified power level in all tested frequency bands. Although the SAR is determined at the highest certified power level, the actual SAR level of the phone while operating can be well below the maximum value. This is because the phone is designed to operate at multiple power levels so as to use only the power required to reach the network. In general, the closer you are to a wireless base station antenna, the lower the power output.

The highest SAR value for the model phone as reported to the FCC when tested for use at the ear is N/A W/kg and when worn on the body, as described in this user guide, is 0.377 W/kg (Body-worn measurements differ among phone models, depending upon available accessories and FCC requirements.)

While there may be differences between the SAR levels of various phones and at various positions, they all meet the government requirement.

The FCC has granted an Equipment Authorization for this model phone with all reported SAR levels evaluated as in compliance with the FCC RF exposure guidelines. SAR information on this model phone is on file with the FCC and can be found under the Display Grant section of www.fcc.gov/oet/ea/fccid after searching on **FCC ID: HD599EXL0**.

For body worn operation, this phone has been tested and meets the FCC RF exposure guidelines for use with an accessory that contains no metal and the positions the handset a minimum of **1.5 cm** from the body. Use of other accessories may not ensure compliance with FCC RF exposure guidelines. If you do not use a body-worn accessory and are not holding the phone at the ear, position the handset a minimum of **1.5 cm** from your body when the phone is switched on.

Preliminary Draft 1/19/11

For European Community Users

Honeywell complies with Directive 2002/96/EC OF THE EUROPEAN PARLIAMENT AND OF THE COUNCIL of 27 January 2003 on waste electrical and electronic equipment (WEEE).

Waste Electrical and Electronic Equipment Information

This product has required the extraction and use of natural resources for its production. It may contain hazardous substances that could impact health and the environment, if not properly disposed.

In order to avoid the dissemination of those substances in our environment and to diminish the pressure on the natural resources, we encourage you to use the appropriate take-back systems for product disposal. Those systems will reuse or recycle most of the materials of the product you are disposing in a sound way.



The crossed out wheeled bin symbol informs you that the product should not be disposed of along with municipal waste and invites you to use the appropriate separate take-back systems for product disposal.

If you need more information on the collection, reuse, and recycling systems, please contact your local or regional waste administration.

You may also contact your supplier for more information on the environmental performances of this product.

Pacemakers, Hearing Aids and Other Electrically Powered Devices

Most manufacturers of medical devices adhere to the IEC 601-1-2 standard. This standard requires devices to operate properly in an EM Field with a strength of 3V/m over a frequency range of 26 to 1000MHz. The maximum allowable field strength emitted by the Dolphin terminal is 0.3V/m according to Subpart B of Part 1 of the FCC rules. Therefore, the RF from the Dolphin terminal has no effect on medical devices that meet the IEC specification.

Microwaves

The radio in the Dolphin RF terminal operates on the same frequency band as a microwave oven. Therefore, if you use a microwave within range of the Dolphin RF terminal you may notice performance degradation in your wireless network. However, both your microwave and your wireless network will continue to function.

Preliminary Draft 1/19/11

Preliminary Draft 1/19/11

Getting Started

Out of the Box

Verify that the carton contains the following items:

- Dolphin 99EX mobile computer (the terminal)
- Main battery pack (i.e., standard 3.7V Li-poly or extended 3.7V Li-ion)
- Quick Start Guide

Note: If you ordered accessories for your terminals, verify that they are also included with the order.

Be sure to keep the original packaging in the event that the Dolphin terminal should need to be returned for service. For details, see [Product Service and Repair](#) on page 19-1.

Step 1. Install the Main Battery Pack

The 99EX is shipped with the battery packaged separate from the unit. Follow the steps below to install the main battery.

1. Release the hook securing the hand strap to the back panel of the terminal near the speaker.
2. Remove the battery door by lifting up the latches near the base of the battery door.
3. Insert the battery into the battery well.
4. Replace the battery door. Apply pressure to engage the door latch.

Note: The battery door must be installed prior to powering the unit.

5. Reattach the hand strap.

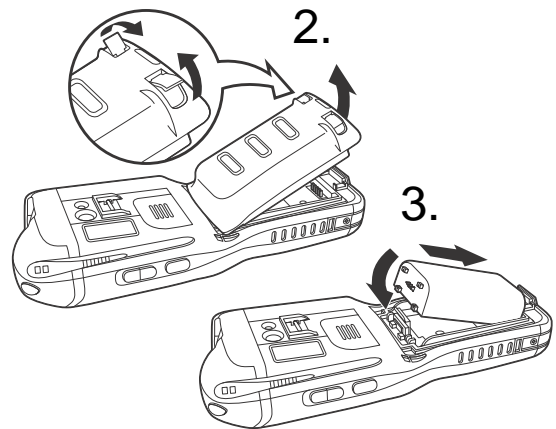

We recommend use of Honeywell Li-poly or Li-Ion battery packs. Use of any non-Honeywell battery may result in damage not covered by the warranty.

Step 2. Charge the Main and Backup Batteries

The power supply for Dolphin terminals consists of two types of battery power: the main battery pack that is accessible from the back panel, and the backup battery that resides inside the terminal.

The main battery powers the terminal. The internal backup battery charges off the main battery and maintains the application data stored in RAM memory for up to 30 minutes when the terminal's main battery pack is completely discharged or removed.

Battery Error Notification

If your terminal displays the following indicators, replace the main battery pack with a Honeywell Li-poly or Li-ion battery pack.

-  appears in the Title bar at the top of the touch screen
- The General Notification LED flashes red
- A Notification appears on the Tile bar at the bottom of the touch screen

Preliminary Draft 1/19/11

 We recommend use of Honeywell peripherals, power cables, and power adapters. Use of any non-Honeywell peripherals, cables, or power adapters may cause damage not covered by the warranty.

Before Initial Use

Terminals are shipped with both batteries discharged of all power. The initial charging time for the main battery pack is 4.5 hours for the standard 3.7V battery or 6 hours for the extended 3.7V battery. Connect the terminal to one of the 99EX series charging peripherals to charge; see [Peripherals for the 99EX](#) on page 3-2. Honeywell recommends charging the Dolphin terminal for at least 24 hours prior to initial use to ensure the internal backup battery is fully charged.

Using the Charging/Communication Cables

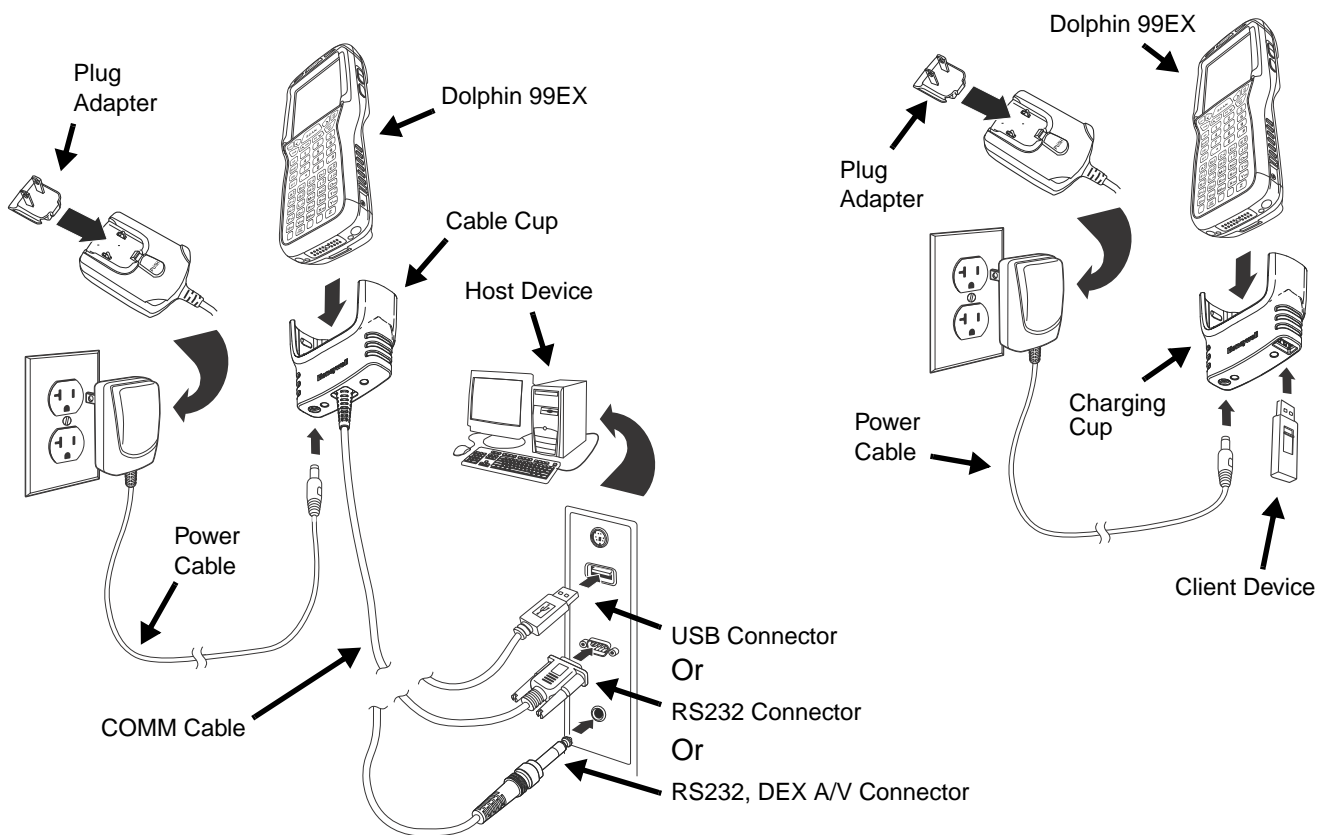

Step 3. Boot the Terminal

The terminal begins booting as soon as power is applied. Do NOT press any keys or interrupt the boot process. When the boot process is complete, the Home screen appears, and the terminal is ready for use.

Note: The Home screen appears several times during the boot process. To ensure the boot process is complete, wait several seconds before using the device.

Preliminary Draft 1/19/11

Step 4. Set the Time Zone, Time, and Date

On the Home screen, tap the line that displays the time and date.

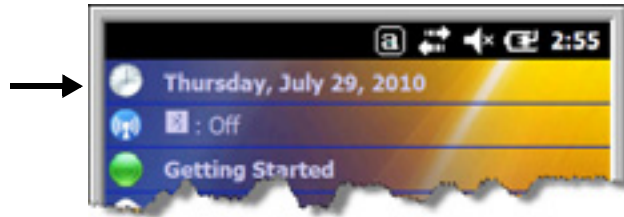

The Clock Settings screen appears.

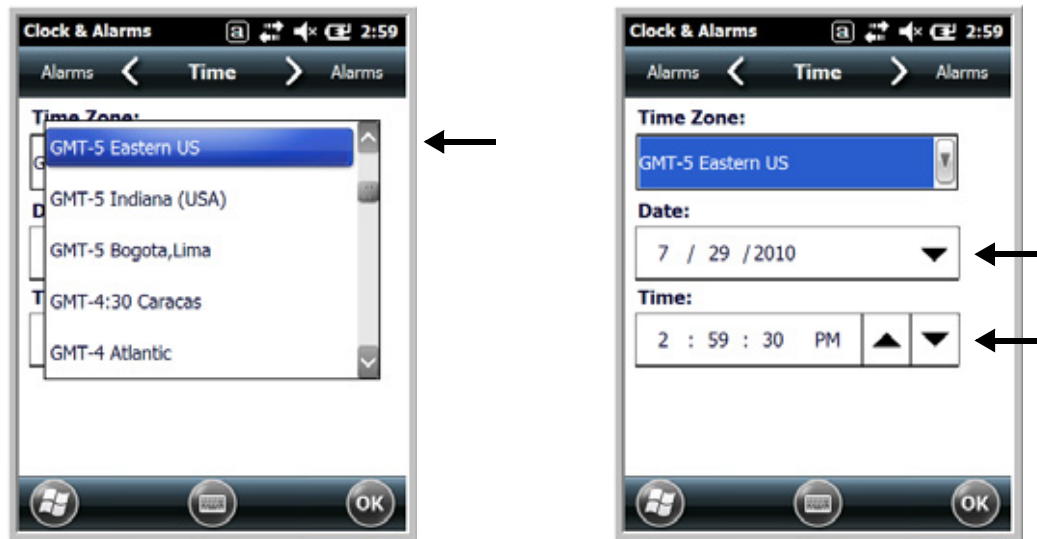



Tap the arrow to the right of the time zone to open the drop down menu. Select the appropriate time zone from the menu. Set the correct time and date in the remaining fields and tap **OK** to save.

Preliminary Draft 1/19/11

Home Screen

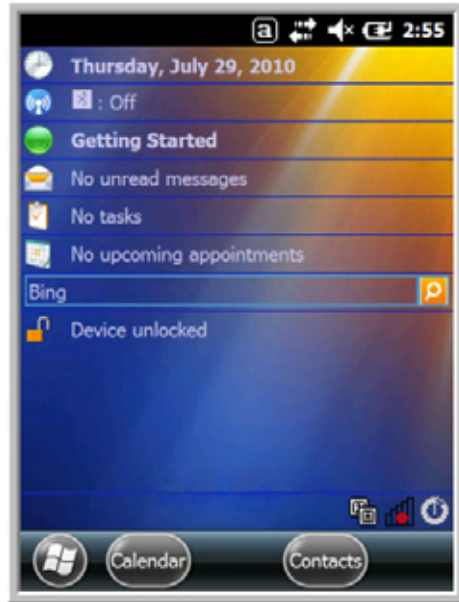
After the Dolphin terminal initializes the first time, you see the Home screen.



You can also display the Home screen anytime by tapping .

Title Bar

The Title bar, located at the top of the screen, displays the active program, the status of various system functions, and the current time. Tapping on the title bar provides access to the Horizontal Scroll. The scroll provides access to additional programs and application screens. For additional information, see [Horizontal Scroll](#) on page 2-7.

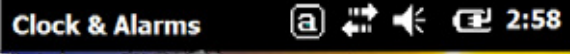

Text here indicates the active program.



Icons here indicate the status of various system functions.





















Note: Tapping the battery icon at the top of the screen does not open the Power applet with this version of Microsoft Windows Embedded Handheld. Windows Embedded Handheld

Icons in the Title Bar

Indicator	Meaning
	Synchronizing data
	The terminal could not synchronize data with the workstation via ActiveSync.
	New e-mail























Preliminary Draft 1/19/11

Icons in the Title Bar

Indicator	Meaning
	New text message
	New voicemail
	New instant message
	Vibrate on
	Ringer off
	Speakerphone on
	Voice call in progress
	Calls are forwarded
	Call on hold
	Missed call
	Data call in progress
	A battery error has occurred. Replace the main battery pack with a Honeywell Li-poly or Li-ion battery pack.
	Battery is has a full charge
	Battery has a high charge
	Battery has a medium charge
	Battery has a low charge
	Battery has a very low charge and requires charging
	Terminal is running on external power. If a battery pack is installed, the battery is charging in the background.
	The terminal is not connected to external power. A battery is installed, but is defective; specifically, its charge level cannot be measured.
	No SIM card is installed
	Active network connection

Preliminary Draft 1/19/11

Icons in the Title Bar

Indicator	Meaning
	No active network connection
	GPRS available
	GPRS connecting
	GPRS in use
	HSDPA available
	HSDPA connecting
	HSDPA in use
	EDGE available
	EDGE connecting
	EDGE in use
	UMTS available
	UMTS connecting
	UMTS in use
	Radio is off
	The radio is not connected to a network.
	The radio is connected. The bars indicate the signal strength.
	No radio signal
	The terminal is searching for a signal.
	Wi-Fi is on, but device is not connected
	Wi-Fi data call
	Pending alarm
	Bluetooth

Preliminary Draft 1/19/11

Horizontal Scroll

The Horizontal Scroll, located at the top of most application windows, provides access to additional application screens. You can flick left or right on the scroll or tap each label on the scroll, until you get to the desired screen. Tapping a label to the left or right of the center item brings new labels into view.

Note: Tap the Title bar to access the horizontal scroll if it is not visible on the screen.

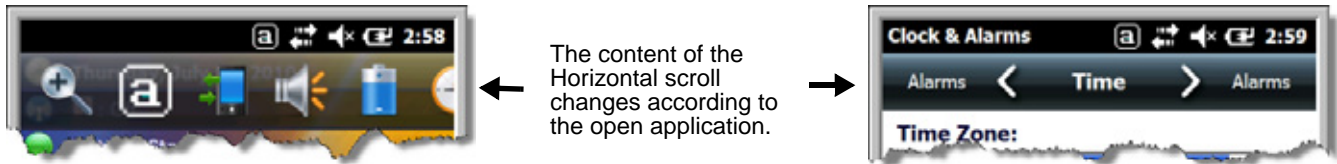

Tile Bar

The Tile bar is located at the bottom of application windows.

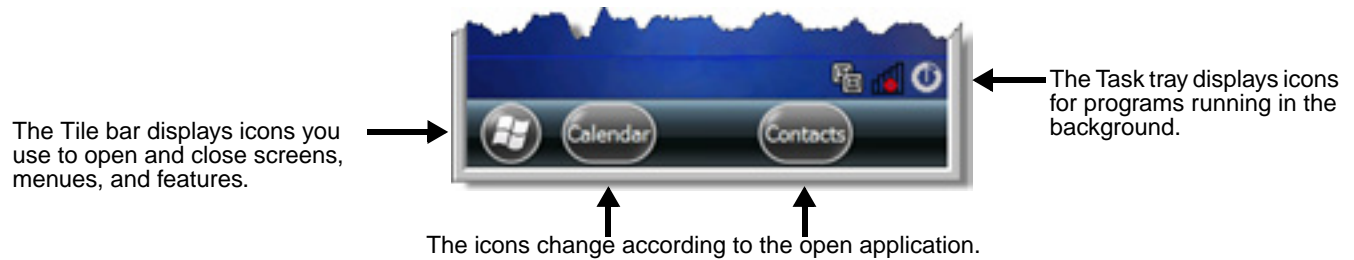

Pop-Up Menus

With pop-up menus, you can quickly choose an action for a selected item. To access a pop-up menu, tap and hold the stylus on the item name of the action you want to perform. When the menu appears, lift the stylus, and tap the action you want to perform.

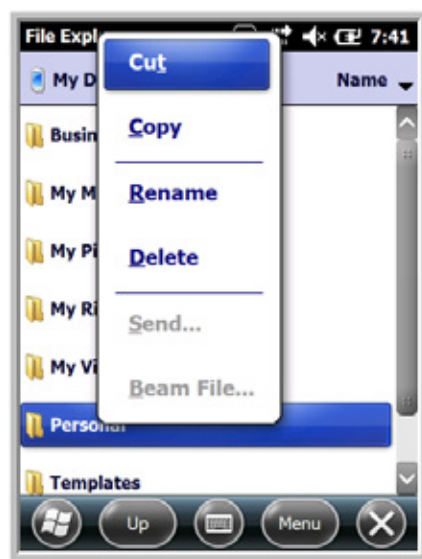

Tap anywhere outside the menu to close the menu without performing an action.

Preliminary Draft 1/19/11

Selecting Programs

To see the programs loaded on your terminal, tap  to access the Start Menu. To open a program, tap once on the program icon. To reposition an icon on the Start Menu, tap and hold the stylus on the icon, and then drag the icon to the desired position.

File Explorer

You can also use the File Explorer to find files and organize these files into folders.

Tap  > **File Explorer**  .



Tap the **Up** button at the bottom of the screen to move up one level in the directory.



You can move files in File Explorer by tapping and holding on the item you want to move, and then tapping **Cut** or **Copy** on popup menu.

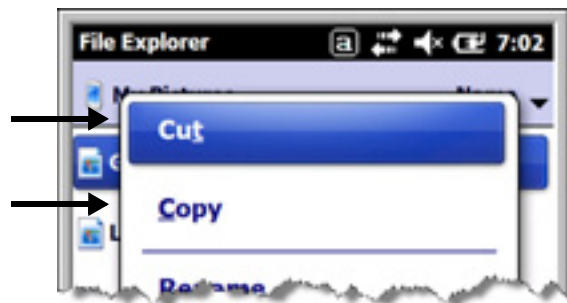

Preliminary Draft 1/19/11



Navigate to the folder you want to move the file to, and then tap and hold a blank area of the window. Tap **Paste** on the pop-up menu.

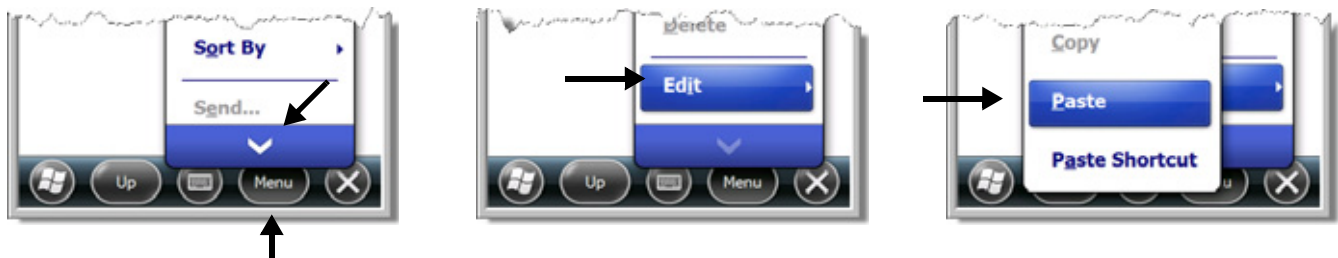

*Note: If there is no blank space available in the window, tap **Menu** on the command bar, navigate to the end of the menu using the down arrow, and then tap **Edit > Paste**.*



Search

The Search feature helps you quickly locate information. Tap  > **Search Phone** .

Enter the text you want to find, select a data type, and then tap **Go** to start the search. Select **Larger than 64 KB** in the **Type** drop-down field to quickly find information that is taking up storage space.

Preliminary Draft 1/19/11

Preliminary Draft 1/19/11

Hardware Overview

Standard Configurations for the 99EX

WLAN & WPAN

- Microsoft Windows Embedded Handheld 6.5 Classic
- OMAP3715 (1Ghz)
- 256MB RAM X 1GB Flash
- Four keyboard options
- 3.7V Li-poly or extended 3.7V Li-ion rechargeable battery pack
- Adaptus Imaging Technology: N5603ER/SR/HD or N5600ER/SR/HD image engines
- 802.11a/b/g/n and Bluetooth

WLAN, WPAN & Camera

- Microsoft Windows Embedded Handheld 6.5 Classic
- OMAP3715 (1Ghz)
- 256MB RAM X 1GB Flash
- Four keyboard options
- 3.7V Li-poly or extended 3.7V Li-ion rechargeable battery pack
- Adaptus Imaging Technology: N5603ER/SR/HD or N5600ER/SR/HD image engines
- 802.11a/b/g/n and Bluetooth
- 3.1 megapixel auto control color camera

WLAN, WPAN, with GPS

- Microsoft Windows Embedded Handheld 6.5 Classic
- OMAP3715 (1Ghz)
- 256MB RAM X 1GB Flash
- Four keyboard options
- 3.7V Li-poly or extended 3.7V Li-ion rechargeable battery pack
- Adaptus Imaging Technology: N5603ER/SR/HD or N5600ER/SR/HD image engines
- 802.11a/b/g/n and Bluetooth
- GPS
- 3.1 megapixel auto control color camera

WLAN, WPAN, with GPS & Camera

- Microsoft Windows Embedded Handheld 6.5 Classic
- OMAP3715 (1Ghz)
- 256MB RAM X 1GB Flash
- Four keyboard options
- 3.7V Li-poly or extended 3.7V Li-ion rechargeable battery pack
- Adaptus Imaging Technology: N5603ER/SR/HD or N5600ER/SR/HD image engines
- 802.11a/b/g/n and Bluetooth
- GPS
- 3.1 megapixel auto control color camera

WLAN, WPAN, & WWAN

- Microsoft Windows Embedded Handheld 6.5 Professional
- OMAP3715 (1Ghz)
- 256MB RAM X 1GB Flash
- Four keyboard options
- 3.7V Li-poly or extended 3.7V Li-ion rechargeable battery pack
- Adaptus Imaging Technology: N5603ER/SR/HD or N5600ER/SR/HD image engines
- 802.11a/b/g/n, Bluetooth, and GSM/HSPA+ or GSM/CDMA

WLAN, WPAN, & WWAN with GPS

- Microsoft Windows Embedded Handheld 6.5 Professional
- OMAP3715 (1Ghz)
- 256MB RAM X 1GB Flash
- Four keyboard options
- 3.7V Li-poly or extended 3.7V Li-ion rechargeable battery pack
- Adaptus Imaging Technology: N5603ER/SR/HD or N5600ER/SR/HD image engines
- 802.11a/b/g/n, Bluetooth, and GSM/HSPA+ or GSM/CDMA
- GPS

Preliminary Draft 1/19/11

WLAN, WPAN, WWAN with GPS & Camera

- Microsoft Windows Embedded Handheld 6.5 Professional
- OMAP3715 (1Ghz)
- 256MB RAM X 1GB Flash
- Four keyboard options
- 3.7V Li-poly or extended 3.7V Li-ion rechargeable battery pack
- Adaptus Imaging Technology: N5603ER/SR/HD or N5600ER/SR/HD image engines
- 802.11a/b/g/n, Bluetooth, and GSM/HSPA+ or GSM/CDMA
- GPS
- 3.1 megapixel auto control color camera

Some configurations of the 99EX terminal are available with an external housing made of plastic that is specifically designed for the healthcare industry. For more information, see [Healthcare Housing](#) on page 3-12.

Peripherals for the 99EX

Each of the following items is sold separately to enhance the capabilities of your Dolphin terminal.

Dolphin 99EX HomeBase™ Device

The Dolphin 99EX HomeBase device is a charging and communication cradle supporting both RS232 and USB communications, which enables the terminal to interface with the majority of PC-based enterprise systems. This device also contains an auxiliary battery well that charges a spare Honeywell Li-poly or extended Li-ion battery.

For more information, see [Dolphin 99EX HomeBase Device](#) on page 12-1.

Dolphin 99EX Mobile Base™ Device

The Dolphin 99EX Mobile Base device is a charging and communication cradle designed specifically for in-premise and in-transit data collection applications. It features a flexible mounting bracket and a cigarette lighter adapter to adapt it to your environment.

The serial connector supports RS232 communication and power out to peripheral devices, such as handheld scanners. The USB connector is a high-speed 2.0v compliant host port. Using a USB cable, you can connect the base to a peripheral device, such as a memory stick or printer.

For more information, see [Dolphin 99EX Mobile Base Device](#) on page 14-1.

Dolphin 99EX eBase™ Device

The Dolphin 99EX eBase device enables a single 99EX mobile computer to communicate with a host device over USB and Ethernet network. This device also contains an auxiliary battery well that charges a spare Honeywell Li-poly or extended Li-ion battery.

For more information, see [Dolphin 99EX eBase Device](#) on page 13-1.

Preliminary Draft 1/19/11

Dolphin 99EX Net Base™ Device

The Dolphin 99EX Net Base device enables up to four 99EX mobile computers to communicate with a host device over an Ethernet network. In addition, the Net Base provides a second RJ45 Ethernet port for connection to an additional device such as a printer, workstation, eBase, or another Net Base.

For more information, see [Dolphin 99EX Net Base Device](#) on page 16-1.

Dolphin 99EX Net Rack™ Device

The Dolphin 99EX Net Rack device enables up to thirty 99EX mobile computer to communicate with a host device over an Ethernet network.

For more information, please consult the Dolphin 99EX Net Rack and Charge Rack User's Guide.

Dolphin 99EX ChargeBase

The Dolphin 99EX ChargeBase is a 4-slot charging cradle that holds, powers, and charges terminals.

For more information, see [Dolphin 99EX ChargeBase Device](#) on page 15-1.

Dolphin 99EX ChargeRack™ Device

The Dolphin 99EX Charge Rack device is a 30-slot charging rack that holds, powers, and charges terminals.

For more information, please consult the Dolphin 99EX Net Rack and Charge Rack User's Guide.

Dolphin 99EX QuadCharger™ Device

The Dolphin 99EX QuadCharger device is a 4-slot charging station for 99EX standard Li-poly or extended Li-ion battery packs.

For more information, see [Dolphin 99EX QuadCharger Device](#) on page 17-1.

Accessories for the 99EX

Each of the following items is sold separately to enhance your terminal's capabilities.

Note: When using accessories where the terminal is worn on the body, the terminal's touch panel must face away from the body.

Dolphin 99EX Mobile Charger

The Dolphin 99EX Mobile Charger is a charging cable that connects the terminal directly to a 12 Volt DC power source, such as a cigarette lighter port inside a vehicle, eliminating the need for a cradle. Intelligent battery technology on-board the terminal ensures proper charging. The Dolphin 99EX Mobile Charger is an ideal low-cost charging solution for in-transit mobile applications.

Preliminary Draft 1/19/11

Dolphin 99EX Mobile Mount

The Dolphin 99EX Mobile Mount, which holds a Dolphin terminal securely in place inside a vehicle, is an ideal, low-cost alternative to the Dolphin 99EX Mobile Base when communications is not required. When used in conjunction with the Dolphin 99EX Mobile Charger, the Dolphin 99EX Mobile Mount creates a complete mounting and charging solution for in-transit applications. The entire kit includes an adjustable vehicle mounting bracket.

Communication/Charging Cables

Dolphin communication/charging cable kits are an all-in-one solution for mobile applications. Each cable kit powers the terminal, charges its main battery, and communicates with host or peripheral devices without the need for a cradle. Cable kits can support RS232 or USB communications and are available with U.K. or European power cords.

Protective Holster

Holsters provide convenient storage for terminals and protect them from damage in mobile environments. **The holster features a front pocket that holds an extra battery, a side pocket to hold an extra stylus, and a belt loop to secure the holster to a belt.**

Protective Enclosure

Protective enclosures help seal and protect terminals from damage while providing full access to all terminal parts and features. These enclosures feature a swivel clip on the back that enables you to secure the enclosure to a belt. Enclosures also come with an adjustable shoulder strap for added convenience.

Stylus Kits

There are two stylus kits for each terminal type: one contains three styli and the other includes additional coiled tethers to secure the stylus to the terminal, which helps prevent loss.

Stylus for Dolphin 99EX with WLAN

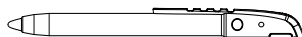

Stylus for Dolphin 99EX with WWAN



Battery Pack

The rechargeable battery pack (i.e., standard 3.7V, 3060mA Li-poly or extended 3.7V, 5000mA Li-ion) provides the main power for the terminal. For more information, see [Batteries](#) on page [3-13](#).

Preliminary Draft 1/19/11

Front Panel: 99EX

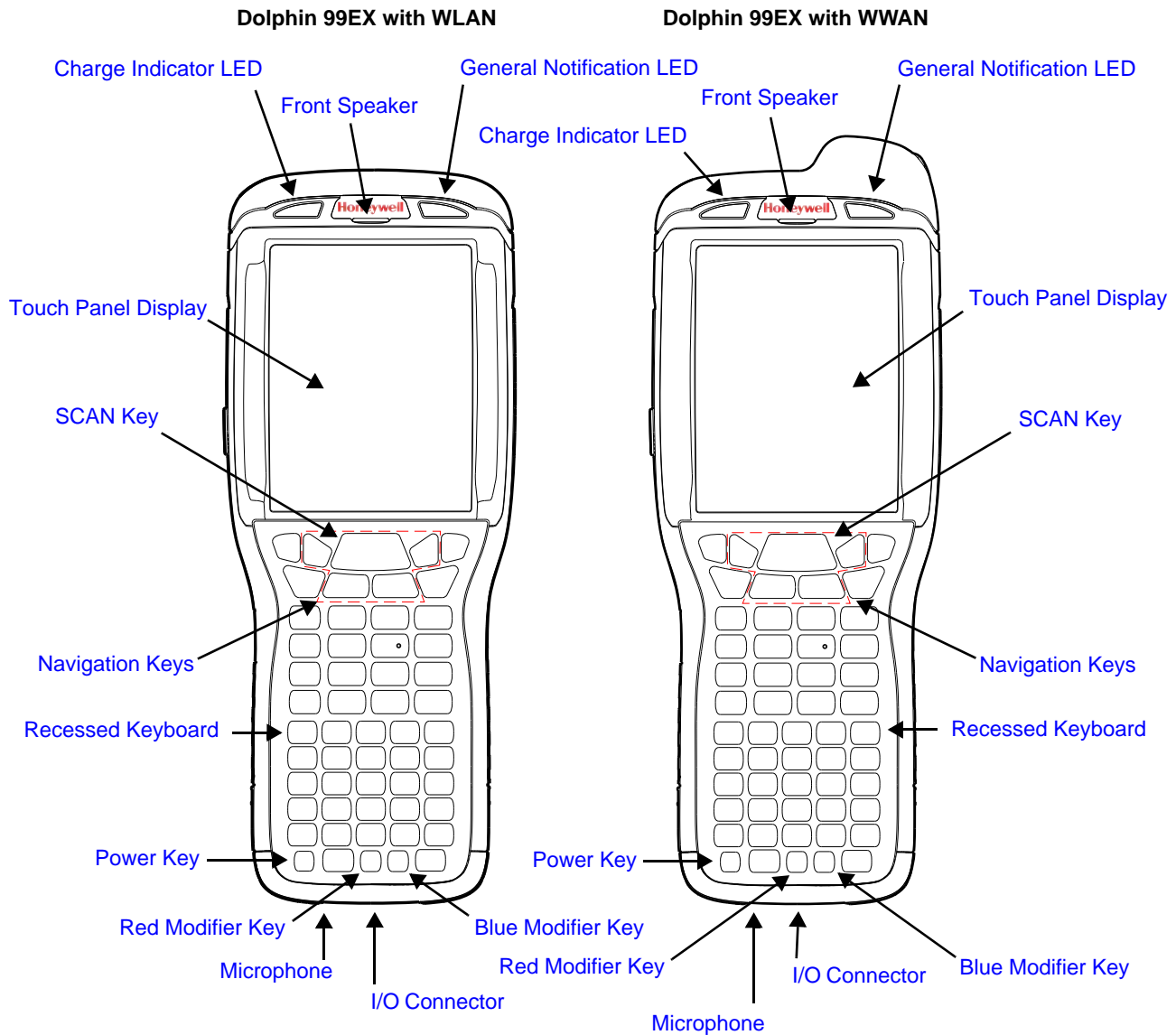

Note: The illustrations above show the 55-Key Full Alpha/Numeric Keyboard option. For a complete overview of the optional keyboards available for the 99EX, see [Using the Keyboards](#) on page 6-1.

For a description of each callout, see [Front Panel Features for the 99EX](#) on page 3-5.

Front Panel Features for the 99EX

Blue Modifier Key

See [Using the Modifier Keys](#) on page 6-3.

Front Speaker

The front speaker is the receiver for handset voice calls. See [GSM/HSPA+ Global Radio Dolphin Models](#) on page 9-5.

Preliminary Draft 1/19/11

General Notification LED

The light emitting diode (LED) located above the top right corner of the LCD display flashes and illuminates during resets, scanning/imaging, and taking a picture. This LED can be programmed by various software applications.

Charge Indicator LED

The light emitting diode (LED) located above the top left corner of the LCD display illuminates when the Power Tools **BattMon** application is enabled and the device is on AC charge. For more information, consult the Dolphin Power Tools User's Guide for Windows Embedded Handheld 6.5.

Microphone

The integrated microphone that provides audio input for handset and speakerphone voice calls. See [Voice Communication](#) on page 9-5.

Navigation Keys

The centrally located navigation keys enable you to move and position the cursor through software programs. The up and down arrows are programmed to perform specific functions when pressed in combination with the Blue and Red modifier keys. For more details, see [Using the Navigation Keys](#) on page 6-3.

Power Key

The power key  located at the lower left corner of the keypad puts the terminal in Suspend Mode or wakes the terminal from Suspend Mode. See [Software/Operating System Upgrades](#) on page 3-17.

Recessed Keyboard

There are three keyboard options: a 34-key alpha/numeric keyboard, a 43-key alpha/numeric keyboard or a 55-key full alpha/numeric keyboard. For a complete overview of each keyboard, see [Using the Keyboards](#) on page 6-1.

Red Modifier Key

See [Using the Modifier Keys](#) on page 6-3.

SCAN Key

The SCAN key is centrally located for easy access with the right or left hand. When pressed, the SCAN key activates the scanner/imager. The SCAN key also functions as a system wake-up control for the terminal.

Touch Panel Display

The color 3.7 inch liquid crystal display (LCD) touch panel is covered with an industrial, protective lens for greater durability. The video graphic array (VGA) display resolution is 480 X 640.

The **262K color (18 bit RGB)** LCD uses thin film transistor (TFT) technology. The touch panel backlight illuminates when the screen is touched, but not when the Backlight key is pressed. For more information, see [Backlight](#) on page 7-9.

The touch panel can be activated by the stylus (included with the terminal) or a finger. For more information, see [Using the Touch Panel](#) on page 3-12.

Preliminary Draft 1/19/11

Back Panel: 99EX

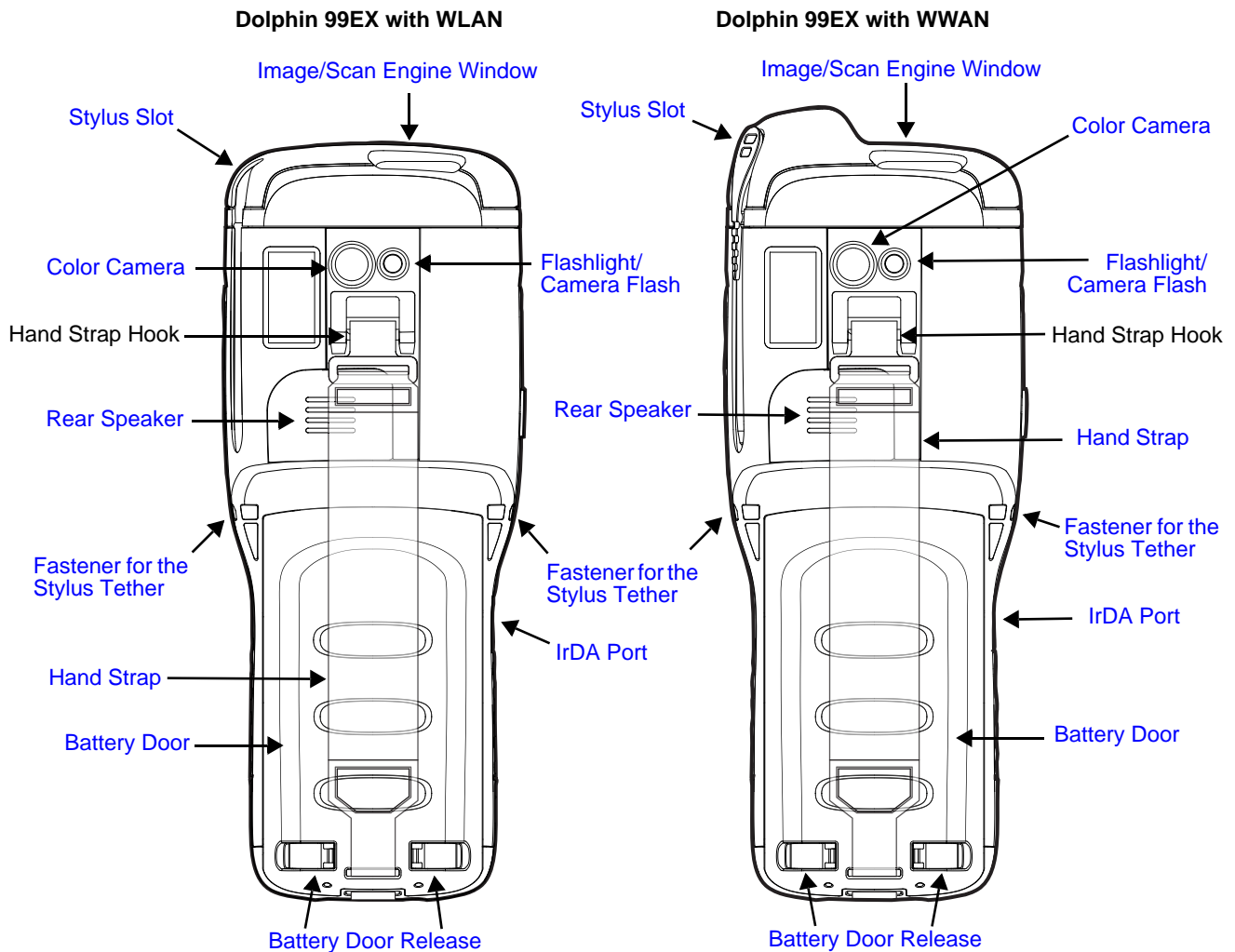

For a description of each callout, see [Back Panel Features for the 99EX](#) below.

Back Panel Features for the 99EX

Battery Door

The battery door secures the Li-ion or Li-poly battery pack in the terminal's battery well. For more information, see [Batteries](#) on page 3-13.

Color Camera

The 3.1-Megapixels Resolution (QXGA 2048H x 1536V) color camera provides easy picture capture with Automated Camera Control (ACC). Additional features include automated picture profiles and an Application Programming Interface (API).

Preliminary Draft 1/19/11

Fastener for the Stylus Tether

Stylus tethers can be purchased separately to help prevent accidental loss when the stylus is not stored in the stylus slot. A stylus tether is a coiled, elastic cord that tethers the stylus to the terminal. Secure one end of the cord to the back panel of the terminal and the other end to the stylus.

Flashlight/Camera Flash

The flashlight/camera flash is located on the back panel of the terminal. When used as a Flashlight, press the Blue key +  key to turn the flashlight on or off. When used as a Camera Flash with the terminal's color camera, the flash is controlled by the camera application.

Hand Strap

The 99EX comes with a removable, elastic hand strap.

Image/Scan Engine Window

The available image engines read and decode linear, stacked linear (e.g., PDF417), and 2D matrix bar code symbologies. The available image engines contain a laser aimer for greater accuracy. The laser apertures for the imaging engines' laser aimers are contained behind this window. For more details, see [Using the Scan Image Engine](#) on page 4-1.

Memory Card Socket and SIM Card Socket

The memory card socket provides the user with the option to expand the terminal's memory capacity using industry-standard microSD or microSDHC memory interfaces. The expansion socket is located under the main battery in the battery well.

When the protective SIM/memory card door, battery pack, and the battery door are properly installed, the memory card is sealed against moisture and particle intrusion, read/write data is stored securely, and the terminal's environmental rating is preserved; see [Installing a Memory Card](#) on page 3-10.

The card socket for the Subscriber Identity Module (SIM) is also located under the main battery in the battery well. See [SIM Card Installation](#) and [SIM Card Requirements](#), on page 9-3 for additional information.

Rear Speaker

The integrated rear speaker sounds audio signals as you scan bar code labels and enter data. The integrated speaker also supports playback of wave and MP3 files, software mixer, and Speakerphone for WWAN/GSM audio. The operating frequency range is 600-3000Hz at >90dB.

Stylus Slot

The stylus is used to operate the touch panel. The back panel of the terminal features a storage slot to hold the stylus when not in use. The stylus features a special tip for added accuracy and ease of use.

Stylus for Dolphin 99EX with WLAN



Stylus for Dolphin 99EX with WWAN



Preliminary Draft 1/19/11

Side Panels: 99EX

The left and the right side panels of the Dolphin contain different features.

Left Side

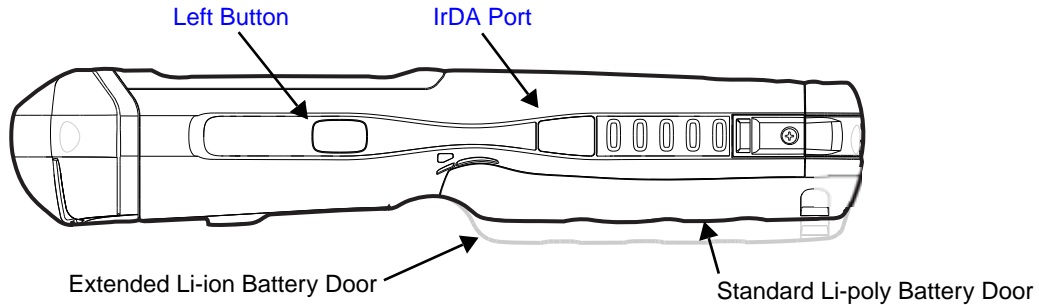

Left Button

By default, the Left Button triggers the scanner/imager. You can reassign the button to launch applications or execute commands. For additional information, see [Changing Button Assignments](#) on page 7-4.

IrDA Port

The IrDA port enables infrared communication. The maximum data transfer speed is 115 kbps. For more information about using this port, see [Using the IrDA Port](#) on page 8-2.

Note: The infrared LED aperture is located behind the IrDA Port window.

Right Side

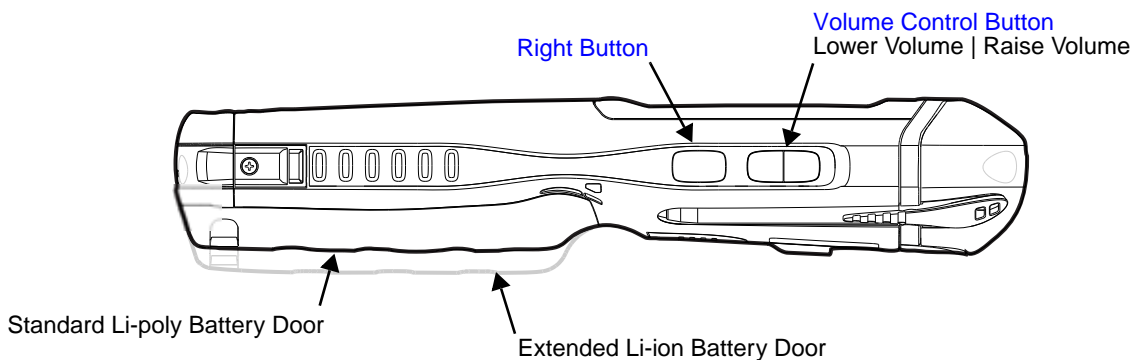

Right Button



By default, the Right Button triggers the scanner/imager. You can reassign the button to launch applications or execute commands. For additional information, see [Changing Button Assignments](#) on page 7-4.

Volume Control Button

Press the top or bottom of the volume button to raise or lower the volume of the active speaker.

Preliminary Draft 1/19/11

Installing a Memory Card

1. Press the Power key  to put the terminal in Suspend Mode.
2. Release the hand strap hook near the speaker on the back panel of the terminal.
3. Remove the battery door and the battery.
4. Remove the T6 torque screw securing the protective door closed.
5. Lift up the lower left corner of the door to access the memory socket.
6. Unlock  the access door to the memory socket by sliding the door toward the IrDA port side of the terminal.
7. Lift the door up to expose the socket.
8. Slide the microSD or microSDHC card into the door of the socket.

Note: Make sure the interface on the memory card is connected to the interface in the socket; align the notch on the card with the notch of the socket.

9. Close and lock  the access door.
10. Close the protective door over the memory socket. Install and tighten the T6 torque screw to secure the door closed.
11. Install the battery and the battery door. Reattach the hand strap to the terminal.
12. Press the Power key or SCAN key to wake the terminal.

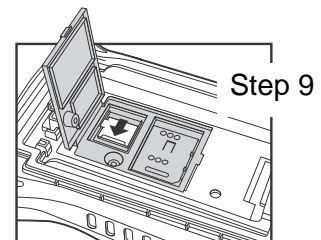
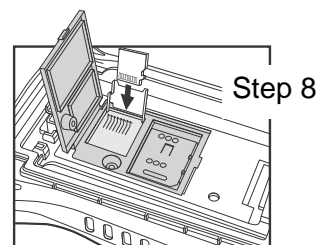
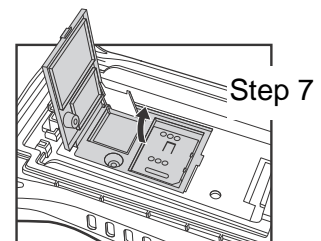
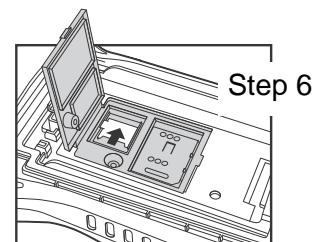
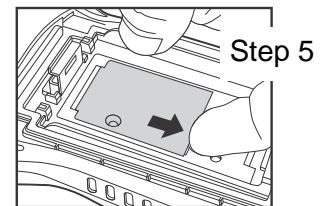
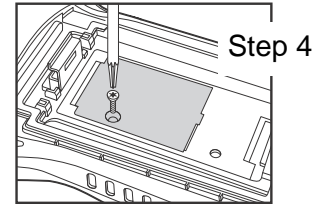

Installing a SIM Card

See [Installing a SIM Card](#) on page 9-4.

Preliminary Draft 1/19/11

Bottom Panel: 99EX

Pin	Description
1	GND
2	GND
3	USBC_DET
4	USBC_D-
5	RTS
6	USBC_D+
7	DTR
8	SPK
9	Audio_GND
10	MIC
11	CTS
12	USBH_D-
13	5V_OUT
14	USBH_D-
15	TXD
16	RXD
17	VCC
18	VCC

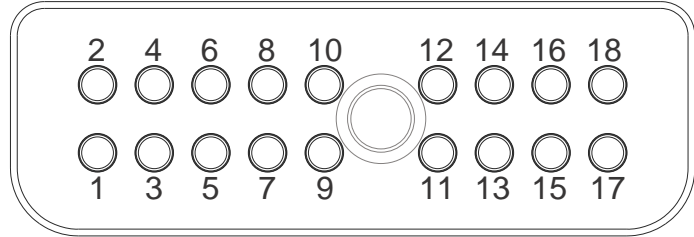

Note: Signals referenced are for a DTE device.

I/O Connector

The I/O connector powers the terminal, charges the main battery, and facilitates communication. All Dolphin peripherals are designed to work exclusively with this connector.

The I/O connector supports RS232 and high speed USB v2.0 communication. For RS232, the maximum communication speed is 115.2 Kbps with seven baud rate settings. For USB, the communication speed is up to 480 Mbps.

I/O Power Out

The I/O connector also provides power out (to peripheral devices) +5V at 500mA. This means that, with the proper cable, the terminal can power another device. By default, power out is disabled, but the 5V output may be enabled, see [Five Volt Control](#) on page 7-12.

Preliminary Draft 1/19/11

Using the Touch Panel

Honeywell defines proper use of the terminal touch panel as using a screen protector and proper stylus. Screen protectors maintain the ongoing integrity (i.e., prevent scratching) of the touch panel, which is why their use is recommended for applications that require a high to medium level of interface with the touch panel, such as signature capture for proof of delivery.

Honeywell advocates the use of screen protectors on all Dolphin devices. We recommend implementing a screen protector replacement program to ensure that screen protectors are replaced periodically when signs of damage/wear are noticeable. For general use, we recommend replacing the screen protector every thirty (30) days. However, replacement cycles vary according to the average level of touch panel use in your application.

Replacement screen protectors can be purchased directly from Honeywell. Please contact a Honeywell sales associate for details.

Honeywell also mandates use of a proper stylus, which is one that has a stylus tip radius of no less than 0.8 mm. Use of the Honeywell stylus included with the terminal is recommended at all times.

Honeywell warranty policy covers wear on the touch panel for the first twelve (12) months if a screen protector is applied and an approved stylus is used for the 12 month duration covered by the warranty.

Installing a Screen Protector

Dolphin terminals ship with a screen protector already installed. You will need to replace the screen protector at regular intervals.

1. After the current screen protector has been removed from the touch panel, clean the touch panel thoroughly with a clean, non-abrasive, lint-free cloth. Make sure there is no debris on the touch panel.
2. Align the exposed section of the protector with the bottom edge of the touch panel. Make sure that the screen protector is flush with each side of the touch panel. To reposition, lift up gently and reapply.
3. Press the screen protector firmly and carefully across the surface of the touch panel as you peel away the backing.
4. If necessary, smooth out any air pockets or bumps.

Healthcare Housing

Some configurations of the 99EX terminal are available with an external plastic housing that is designed to resist the effects of harsh chemicals in a healthcare environment. The plastic is crystalline in nature, which helps prevent chemicals from seeping through the housing.

Important! The following cleaning solutions have been tested to assure safe cleaning of your terminal's disinfectant-ready housing. They are the only solutions approved for use with these terminals. Damage caused by the use of cleaners other than those listed below may not be covered by the warranty.

- Sani-Cloth[®] HB wipes
- Sani-Cloth[®] Plus wipes
- Sani-Cloth[®] Bleach wipes
- Super Sani-Cloth[®] wipes

Preliminary Draft 1/19/11

- Isopropyl Alcohol wipes (70%)
- CaviWipes™
- Virex® 256
- 409® Glass and Surface Cleaner
- Windex® Blue
- Gentle dish soap and water

Batteries

There are three types of battery power: the main battery pack installed in the back panel, the backup battery located inside the terminal and the Real Time Clock (RTC) battery located inside the terminal. They are designed to work together to prevent data loss when the terminal is in use over long periods.

All batteries must be completely charged before using a Dolphin terminal for the first time!

Note: The RTC battery will preserve the Real Time Clock 60 days after the main battery and internal backup battery are fully depleted.

Main Battery Pack



We recommend use of Honeywell Li-ion or Li-poly battery packs. Use of any non-Honeywell battery may result in damage not covered by the warranty.

The standard 3.7 V, 11.3 watt hour Li-poly or extended 3.7 V, 18.5 watt hour Li-ion battery pack is the primary power source for the terminal. The Li-poly and Li-ion battery packs are designed to operate in a temperature range of -10° to 50°C (14° to 122°F).

Note: Honeywell recommends placing the terminal in [Software/Operating System Upgrades](#) (see page 3-17) before removing the battery cover.

Charging Options

When the main battery pack is installed in the terminal, use one of the following peripherals:

- [Dolphin 99EX HomeBase Device](#) (see page 12-1)
- [Dolphin 99EX eBase Device](#) (see page 13-1)
- [Dolphin 99EX Mobile Base Device](#) (see page 14-1)
- [Dolphin 99EX ChargeBase Device](#) (see page 15-1)
- [Dolphin 99EX Net Base Device](#) (see page 16-1)

When the main battery pack is not installed in the terminal:

- Place the battery pack in the [Dolphin 99EX QuadCharger Device](#) (see page 17-1)
- Place the battery pack in the [Auxiliary Battery Well](#) of the [Dolphin 99EX HomeBase Device](#) (see page 12-2) or [Dolphin 99EX eBase Device](#) (see page 13-1).

Charging Time

The standard 3.7V Li-poly battery pack requires 4.5 hours to charge completely before initial use.

The extended 3.7V Li-ion battery pack requires 6 hours to charge completely before initial use.

Honeywell recommends charging the Dolphin terminal for at least 24 hours prior to initial use to ensure the internal backup battery is fully charged.

Preliminary Draft 1/19/11

Battery Error Notification

If your terminal displays the following indicators, replace the main battery pack with a Honeywell Li-poly or Li-ion battery pack.

-  appears in the Title bar at the top of the touch screen.
- The General Notification LED flashes red.
- A Notification appears on the Tile bar at the bottom of the touch screen.

Storing Batteries

To maintain top performance from batteries, avoid storing batteries outside of the following temperature ranges:

- 14°F to 113°F (-10°C to +45°C) for short term storage of less than one month
- 32°F to 86°F (-0°C to +30°C) for long term storage

Do not store batteries in extremely high humidity. For prolonged storage, do not keep batteries stored in a charger that is connected to a power source.

Guidelines for Battery Pack Use and Disposal

The following are general guidelines for the safe use and disposal of batteries:

- We recommend use of Honeywell Li-ion or Li-poly battery packs. Use of any non-Honeywell battery may pose a personal hazard to the user.
- Replace defective batteries immediately; using a defective battery could damage the Dolphin terminal.
- Never throw a used battery in the trash. A battery contains heavy metals and should be recycled according to local guidelines.
- Do not use a battery in any other manner outside its intended use in Dolphin terminals and peripherals.
- Do not short-circuit a battery or throw it into a fire; it can explode and cause severe personal injury.
- Excessive discharge damages a battery. Recharge the battery when your terminal indicates low battery power.
- If you observe that the Honeywell battery supplied is physically damaged, please send it to Honeywell International Inc. or an authorized service center for inspection. Refer to the Product Service and Repair section of this guide.
- Although your battery can be recharged many times, the battery life is limited. Replace it after the battery is unable to hold an adequate charge.
- If you are not sure the battery or charger is working properly, send it to Honeywell International or an authorized service center for inspection.

Internal Backup Battery

Located inside the terminal, the backup battery is a 3.6 Volt nickel metal hydride (NiMH) battery.

The internal backup battery prevents the terminal from being reset if you need to remove and replace the main battery pack. It retains RAM data. If the terminal is left without the main battery pack for more than 30 minutes, the internal backup battery needs to be recharged to function according to its specifications.

Note: Data and programs stored in Flash memory are not lost even if the internal backup battery fails.

Preliminary Draft 1/19/11

Charging

The internal backup batteries are powered by the main battery pack. Therefore, charging the internal backup batteries require that the main battery pack be installed in the terminal and the terminal be connected to a charging device.

Note: Honeywell recommends placing the terminal in [Software/Operating System Upgrades](#) (see page 3-17) before removing the battery cover.

The internal backup battery must be fully charged before using the terminal for the first time. Honeywell recommends charging the Dolphin terminal for at least 24 hours prior to initial use to ensure the internal backup battery is fully charged. After that, if the internal backup battery becomes fully discharged of power, it requires a minimum of 30 hours of charging time to function normally.

Guidelines for Use

Follow these guidelines to maximize the life of the internal backup battery:

- Keep a charged Li-ion or Li-poly battery pack in the terminal; the backup battery prematurely discharges if there is not at least a partially charged battery in the terminal.
- Keep the terminal connected to power when the terminal is not in use.

Managing Battery Power

Letting the backup battery become fully discharged causes the terminal to lose all data in RAM. Honeywell recommends, you keep a charged battery pack in the terminal at all times to help prevent data loss. The internal battery discharges prematurely if there is not at least a partially charged battery in the terminal. When you remove a battery pack, insert another charged battery pack in the terminal immediately.

Default Critical and Low Battery Points

When the terminal is running on battery power (as opposed to external power), warnings are displayed when the battery reaches critical and low battery points. The warning points are determined by the following registry entry:

[HKEY_LOCAL_MACHINE\ControlPanel\Power]

There are two DWORD values in this registry entry: **MedState** and **LowState**.

The default values for these entries are as follows:

MedState=25%

This sets the Low Battery point to 25%. When the battery hits the percentage charge specified here, the user is notified.

LowState=10%

This sets the Critical Battery point to 10%. When the battery hits the percentage charge specified here, the user is notified.

Note: Warnings do not appear when the terminal is on external power.

Preliminary Draft 1/19/11

Setting Critical and Low Battery Points

Developers can reset the battery parameters in the registry from 0 (no warning) to 99 (would nearly always warn). You can review and set these battery points in the RegEdit Power Tool.

1. Tap  > **Power Tools** > **RegEdit**.
2. Drill down to **HKEY_LOCAL_MACHINE** > **ControlPanel** > **Power**.
3. Tap the **Value Name** to change the Value Data.
You can reset the Value Data from 0 (no warning) to 99 (would nearly always warn).
4. Tap **OK** to save changes.

For more information about the RegEdit Power Tool, refer to the Dolphin Power Tools User's Guide available for download at www.honeywellaidc.com.

Checking Battery Power

Tap  > **Settings** > **System** > **Power**.

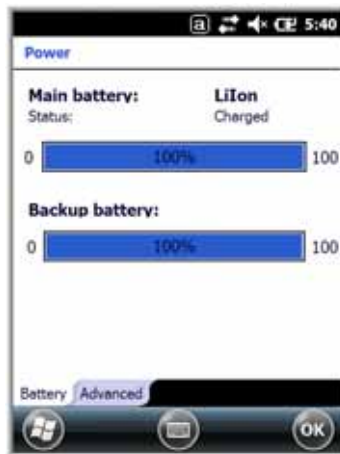

For more information, see [Power](#) on page 7-16.

Note: Tapping the battery icon at the top of the screen does not open the Power applet with this version of Microsoft Windows Embedded Handheld.

Resetting the Terminal

There are three types of system resets: a soft reset, a hard reset and a factory reset. The soft and hard resets preserve all data stored in the file system. See Honeywell support for more information on how to perform a factory reset.



Soft Reset (Warm Boot)

A soft reset re-boots the device and preserves any objects created in RAM. You would perform a soft reset when:

- the terminal fails to respond.

Preliminary Draft 1/19/11



- after installing some software applications.
- after making changes to certain system settings, such as network cards.

1. Press and hold the CTRL  + ENTER  keys for approximately 5 seconds.
2. The decode and scan LEDs flash for approximately three seconds as the terminal resets.
3. When the reset is complete, the Home screen displays.

Hard Reset (Cold Boot)

A hard reset re-boots the device and clears RAM data. Files in the user store are not affected unless you are performing a software upgrade.

 *A hard reset erases all of the data stored in RAM memory!*

1. Press and hold the CTRL  + ESC  keys for approximately 5 seconds.
2. The decode and scan LEDs light for approximately 3 seconds.
3. The terminal re-initializes; see [Initialize the Mobile Computer](#) on page 2-8.

Software/Operating System Upgrades

Software upgrades reset the device back to a factory state. Back up all user files to a storage card or external memory prior to performing a software upgrade. All files in the user store will be erased during an operating system upgrade. Data stored in the IPSM directory is preserved during an operating system upgrade.

Suspend Mode

The terminal goes into Suspend Mode automatically when the terminal is inactive for a programmed period of time. You can program this time on the Advance tab of the Power System Setting; see [Power](#) on page 7-16.

To put the terminal into Suspend Mode manually, press the Power key  and the screen goes blank.

To wake the terminal from Suspend Mode, press the Power key  or SCAN key .

Hardware Maintenance

When needed, clean the image engine window and the LCD display with a clean, non-abrasive, lint-free cloth. The terminal can be cleaned with a damp cloth.

For additional information on hardware maintenance specific to the Dolphin Healthcare Housings, see [page 3-12](#).

Preliminary Draft 1/19/11

Preliminary Draft 1/19/11

Using the Scan Image Engine

Overview

The Dolphin terminal houses a compact image engine that instantly reads popular 1D and 2D bar codes and supports omni-directional aiming and decoding for greater flexibility in real-world settings. The image engine can also capture black and white digital images, such as signatures and pictures of damaged inventory.

With the latest CMOS-based technology, the engine works like a digital camera and enables black and white digital image capture, signature capture, and reading of OCR characters.

Angled Imaging

All imagers are installed at a 25 degree downward-facing angle for enhanced comfort and maneuverability while scanning.

Laser Safety

See [Laser Safety](#) on page 1-1.

LED Safety

See [LED Safety](#) on page 1-2.

Image Engine Specifications

Engines	1D	2D	Image Capture	Aiming Pattern	Omni-Directional Aiming
N5603SR/ER/HD	Y	Y	Y	N5603 Red High-Vis Aiming Pattern (page 4-5) See Laser Safety on page 1-1.	Y
N5600SR/ER/HD	Y	Y	Y	Capturing Images (page 4-6)	Y

N5603 Beam Divergence Angle

Engines	Horizontal Beam Divergence Angle (degrees)	Vertical Beam Divergence Angle (degrees)
N5603SR/HD	18.1	14.3
N5603ER	13.1	9.9

Preliminary Draft 1/19/11

Depth of Field

The depth of field measurements used the following parameters:

- Distances are measured from the front of the engine.
- +23°C (+73°F), 0 lux
- Photographic quality codes

Focus	N5603/N5600 High Density (HD)			N5603/N5600 Standard Range (SR)			N5603/N5600 Extended Range (ER)		
	Distance (in/cm)		Delta (in/cm)	Distance (in/cm)		Delta (in/cm)	Distance (in/cm)		Delta (in/cm)
	Near	Far		Near	Far		Near	Far	
3 mil C39/128	2.1 (5.3)	3.4 (8.6)	1.3 (3.3)	-	-	-	-	-	-
5 mil C39/128	1.3 (3.3)	4.8 (12.2)	3.5 (8.9)	2.7 (6.9)	6.2 (15.7)	3.5 (8.9)	5.8 (14.7)	9.0 (22.9)	3.2 (8.1)
7.5 mil C39/128	1.3 (3.3)	5.7 (14.5)	4.4 (11.2)	2.3 (5.8)	9.4 (23.9)	7.1 (18)	4.0 (10.2)	12.8 (32.5)	8.8 (22.4)
10 mil C39/128	1.3 (3.3)	5.6 (14.2)	4.3 (10.9)	1.3 (3.3)	13.5 (34.3)	12.2 (31)	2.7 (6.9)	17.6 (44.7)	14.9 (37.8)
15 mil C39/128	1.3 (3.3)	7.8 (19.8)	6.5 (16.5)	1.3 (3.3)	19.5 (49.5)	18.2 (46.2)	1.9 (4.8)	21.4 (54.4)	19.5 (49.5)
20 mil C39/128	2.1 (5.3)	9.4 (23.9)	7.3 (18.5)	2.0 (5.1)	20.1 (51.1)	18.1 (46)	2.8 (7.1)	26.5 (67.3)	23.7 (60.2)
100% UPC	1.9 (4.8)	7.1 (18)	5.2 (13.2)	1.8 (4.6)	17.0 (43.2)	15.2 (38.6)	2.7 (6.9)	20.9 (53.1)	18.2 (46.2)
5 mil PDF417	1.3 (3.3)	4.9 (12.4)	3.6 (9.1)	2.2 (5.6)	5.8 (14.7)	3.6 (9.1)	6.1 (15.5)	7.9 (20.1)	1.8 (4.6)
6.7 mil PDF417	1.3 (3.3)	4.9 (12.4)	3.6 (9.1)	1.9 (4.8)	6.6 (16.8)	4.7 (11.9)	4.6 (11.7)	9.9 (25.1)	5.3 (13.5)
10 mil PDF417	1.6 (4.1)	6.3 (16)	4.7 (11.9)	1.9 (4.8)	11.3 (28.7)	9.4 (23.9)	2.4 (6.1)	16.0 (40.6)	13.6 (34.5)
5 mil MicroPDF	1.7 (4.3)	3.3 (8.4)	1.6 (4.1)	-	-	-	-	-	-
5 mil Data Matrix	1.6 (4.1)	3.0 (7.6)	1.4 (3.6)	-	-	-	-	-	-
10 mil Data Matrix/Aztec	1.3 (3.3)	5.3 (13.5)	4.0 (10.2)	1.9 (4.8)	8.2 (20.8)	6.3 (16)	5.4 (13.7)	11.3 (28.7)	5.9 (15)
20 mil Data Matrix	1.9 (4.8)	8.0 (20.3)	6.1 (15.5)	1.9 (4.8)	16.0 (40.6)	14.1 (35.8)	2.4 (6.1)	19.9 (50.5)	17.5 (44.5)

Preliminary Draft 1/19/11

10 mil QR	3.3 (8.4)	5.0 (12.7)	3.5 (8.9)	2.1 (5.3)	7.2 (18.3)	5.1 (13)	4.1 (10.4)	10.6 (26.9)	6.5 (16.5)
20 mil QR	2.0 (5.1)	8.0 (20.3)	6.0 (15.2)	1.9 (4.8)	15.8 (40.1)	13.9 (35.3)	2.0 (5.1)	19.6 (49.8)	17.6 (44.7)
32 mil Maxicode	2.2 (5.6)	8.8 (22.4)	6.6 (16.8)	2.1 (5.3)	19.3 (49)	17.1 (43.4)	3.7 (9.4)	23.2 (58.9)	19.5 (49.5)

Supported Bar Code Symbolologies

Symbology Type	Symbology Name
1D Symbolologies	Codabar Code 3 of 9 Code 11 Code 32 Pharmaceutical (PARAF) Code 93 Code 128 EAN with Add-On EAN with Extended Coupon Code EAN-8 EAN-13 GS1-128 GS1 Databar Interleaved 2 or 5 ISBT 128 Matrix 2 of 5 MSI Plessey PosiCode Straight 2 of 5 IATA Straight 2 of 5 Industrial Telepen Trioptic Code UPC UPC-A UPC-E
2D Symbolologies	Aztec Codablock Code 16K Code 49 Composite Data Matrix GS1 Databar MaxiCode Micro PDF OCR PDF417 QR Code
Composite Codes	Aztec Mesa Codablock F EAN-UCC GS1 Databar-14
OCR	OCR US Money Font MICR (E 13 B) and SEMI Font OCR-A OCR-B
Postal Codes	Postnet and most international 4-state codes Australian Post British Post Canadian Post China Post Japanese Post KIX (Netherlands) Post Korea Post Planet Code

Preliminary Draft 1/19/11

Decoding

The terminal supports two types of image decoding for use in various bar code reading and imaging applications: full-area imaging and Advanced Linear Decoding (ALD).

Full-Area Imaging

Full-area imaging provides omni-directional reading of linear and non-linear 1D and 2D bar codes, OCR, signature capture, and picture taking. When reading all bar code types using full-area imaging, a positive read can be obtained from many positions; see [Aiming Options](#) on page 4-4. To achieve the best read, the aiming beam should be centered horizontally across the bar code.

ALD

ALD provides fast reading of linear and stacked linear bar codes. To achieve a positive read when reading linear 1D and PDF417 bar codes, the green aiming beam should be centered horizontally across the bar code. When ALD is enabled, the reader does not read matrix or postal codes.

To Decode a Bar Code

The aiming beam should be oriented in line with the bar code to achieve optimal decoding. A range of 4-10 inches (10-25 cm) from the bar code is recommended.

1. Tap  > **Demos**  > **Scan Demo** .
2. Point the Dolphin terminal at the bar code.

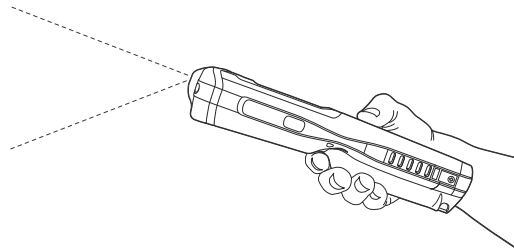

3. Project the aiming beam or pattern by pressing and holding the SCAN key .
4. The scan LED lights red.
5. Center the aiming beam over the bar code; see [Aiming Options](#) on page 4-4.
6. When the bar code is successfully decoded, the decode LED lights green and the terminal beeps.
7. The bar code information is entered into the application in use.

Aiming Options

The aiming beams are smaller when the terminal is held closer to the code and larger when it is farther from the code. Symbologies with smaller bars or elements (mil size) should be read closer to the unit whereas symbologies with larger bars or elements (mil size) should be read farther from the unit.

Preliminary Draft 1/19/11

N5603 Red High-Vis Aiming Pattern

If your Dolphin terminal is configured with a 5603 imager, high-vis aimers frame the bar code for more intuitive aiming. See [Laser Safety](#) on page 1-1.

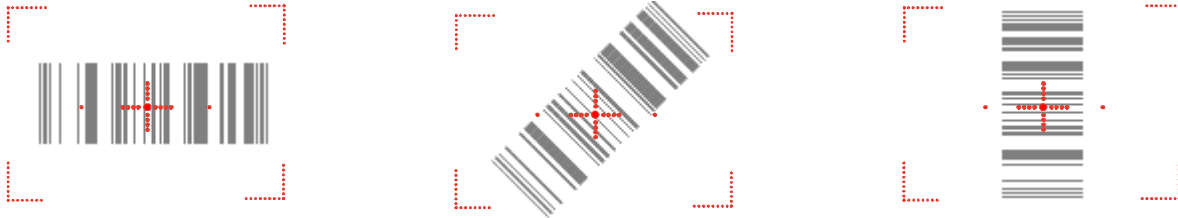

N5600 Green Aiming Beam

Linear Bar Code



2D Matrix Symbol



Preliminary Draft 1/19/11

Capturing Images

The image-capture process is an intuitive, split-second operation for experienced users. By following the basic guidelines, new users can easily develop their own technique and, with practice, quickly learn to adapt it to different application environments.

Image Preview

When the imaging process is initiated, the touch screen displays a preview of the object. This is a live video image of what the imager is currently viewing. The live video image has a slightly degraded appearance compared to the captured image. This is normal.

Scan Key

On all 99EX terminals, the SCAN key captures images.

File Formats

File formats supported for image storage include Bitmap (BMP), JPEG (JPG) and Portable Network Graphics (PNG). The default file format for images is a grayscale JPG.



Compression

Digital images have a maximum image size of 640 x 480 pixels and may have up to a 256 grayscale image definition.

The image quality and related file size are determined by the data compression method used by the software application used to take images. The average size of the image file is approximately 4–8K. However, the size of the image depends on the content of the image - the more complex the content, the larger the file size.

Taking an Image

The following steps are basic guidelines for taking images:

1. Tap  > **Demos** > **Imaging Demo** .
2. Point the Dolphin terminal at the object.

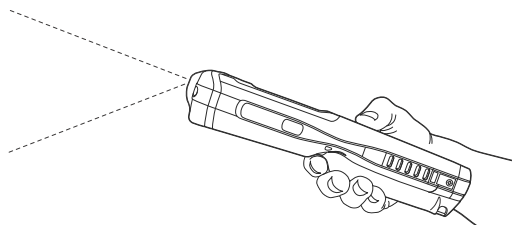

3. To preview the image, press and hold the SCAN key .
4. The touch screen displays a preview of the object, and the decode and scan LEDs light red.
5. Adjust the terminal's position until the object appears on the screen the way you want it to appear in the image.
6. Hold the terminal still and release the SCAN key. The scan and decode LEDs flash red, the screen flashes, and the captured image appears on the screen.

Preliminary Draft 1/19/11

7. Unless otherwise specified by the application in use, the image is saved to the **My Device\My Documents** folder.

Enabling the Aimer

If your Dolphin terminal is configured with the 5300 imager, you can enable the aiming pattern for imaging in the Imaging Demo. For details about the aimer, see [Capturing Images](#) on page 4-6.

1. Tap  > **Demos** > **Imaging Demo** > **Setup** menu > **Aimer**.



2. The aiming pattern is now enabled for imaging.

Uploading Images

Image files can be uploaded to a host workstation via Microsoft ActiveSync and a Dolphin communication peripheral or your wireless radio connection.

Note: You can download the most current version of ActiveSync from www.microsoft.com.

Note: Visit the [Microsoft Windows 7 website](#) for information on how to sync your music, pictures, contacts and calendars using Device Stage.

Note: Visit the [Microsoft Windows Vista website](#) for information on how to sync your music, pictures, contacts and calendars using Windows Mobile Device Center.



We recommend use of Honeywell peripherals, power cables, and power adapters. Use of any non-Honeywell peripherals, cables, or power adapters may cause damage not covered by the warranty.

Preliminary Draft 1/19/11



Preliminary Draft 1/19/11

Using the Color Camera



Overview

Dolphin 99EX terminals equipped with a 3.1-Megapixels Resolution color camera with Automated Camera Control (ACC), and an Application Programming Interface (API) provide easy integration of color picture and video capture into business applications. The camera lens and camera flash are located on the back panel of the terminal.

Taking a picture using the Camera Demo tool

1. Tap  > **Demos**  > **Camera Demo** .
2. Adjust the camera settings using the icon menu at the top of the display screen.



3. Point the terminal's camera lens at the object you want to capture. The camera lens is located on the back panel of the terminal.
4. Center the object in the touch screen display.
5. Press the ENT key  or tap **Snap** . The terminal's red LED illuminates during picture capture.

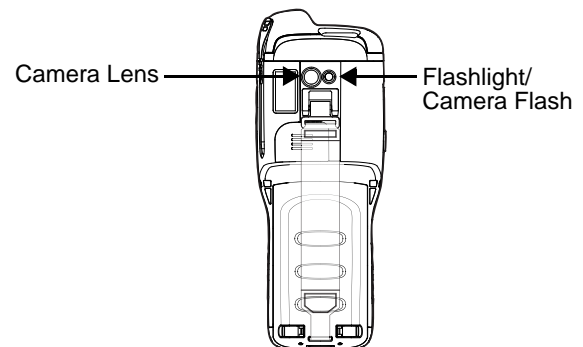

Note: Tap the green arrow  to review or edit your pictures.

Tap the green box  to exit the picture review/edit screen.

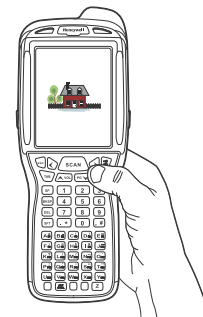

Preliminary Draft 1/19/11

Options

Tap **Options > Camera**.



The Camera Options menu appears. There are five tabs of configurable options accessible from the Camera Options menu.

Profile Tab



The profile tab allows you to customize your camera settings, or chose from several predefined profiles designed to provide the best picture quality for common tasks.



Capture Tab





Caption Tab



File Tab



Taking a picture using the Windows Embedded Handheld 6.5 Camera tool

1. Tap  > **Pictures & Videos > Camera**
2. Point the terminal's camera lens at the object you want to capture. The camera lens is located on the back panel of the terminal.
3. Center the object in the touch screen display.
4. Press the ENT key .
5. The touch screen displays the captured photo.

Preliminary Draft 1/19/11

Menu

Tap **Menu** on the Command Bar to adjust the camera settings, switch to video mode, and access additional camera options.

Item	Descriptions
Video	Activate Video Mode
Mode	Normal Mode, Burst Mode, Timer Mode
Resolution	Set picture resolution (i.e., 320 x 240, 640 x 480, 800 x 600, 1600 x 1200)
Zoom	Set zoom (i.e., x1, x2, x3, and x4)
Flash	Camera Flash On or Camera Flash Off
Focus	Focus On, Focus Off, Focus on Trigger, or Fixed-Focus
Brightness	Set the brightness setting from +2.0 EV to -2.0 EV in .5 EV increments
Full Screen	Switch to full screen mode
Options	Set General, Slide Show, Camera, and Video options
Focus	Manual focus adjustment

Options

Tap **Menu > Options**. The Options menu contains four screens:

General Tab



Slide Show Tab





Camera Tab



Video Tab



Recording Video

1. Tap  > **Pictures & Videos > Camera > Menu > Video**
2. Point the terminal's camera lens at the object you want to capture.
3. Press the ENT key  to start recording.
4. Tap Stop or press ENT to stop recording.

Preliminary Draft 1/19/11

Preliminary Draft 1/19/11

Using the Keyboards

Available Keyboards

There are four keyboard options in the 99EX series:

34-Key Alpha/Numeric
Keyboard



34-Key Numeric
(Calculator) Keyboard



43-Key Alpha/Numeric
Keyboard



55-Key Full Alpha/
Numeric Keyboard

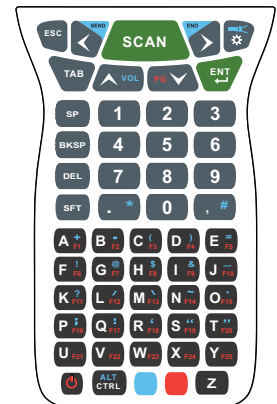

All Keyboards Contain the Following:

- Backlit for easy viewing in various lighting conditions.
- Centrally located Scan key for both right- and left-hand operation.
- Color-coding so you can clearly see the most common keyboard combinations.
- Function, navigation, and modifier keys.

Keyboard Combinations

See [34-Key Alpha/Numeric Keyboard Combinations](#) on page 6-6.

See [34-Key Numeric \(Calculator\) Keyboard Combinations](#) on page 6-9.

See [43-Key Keyboard Combinations](#) on page 6-12.

See [55-Key Keyboard Combinations](#) on page 6-14.

Common Buttons









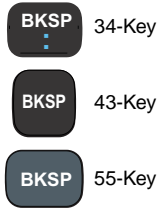

See [Using the Function Keys](#) on page 6-2.

See [Using the Modifier Keys](#) on page 6-3.

See [Using the Navigation Keys](#) on page 6-3.



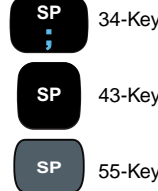



Preliminary Draft 1/19/11

Using the Function Keys

Name	Key	Function
Backlight		Turns the keyboard backlight on and off.
Flashlight		Turns the flashlight on and off. The flashlight is located on the back panel of the terminal.
Backspace (BKSP)		Moves the cursor back one space each time the key is pressed. If you are typing text, it deletes the previous character each time it is pressed.
Delete (DEL)		Deletes the next character each time the key is pressed. This key only appears on the 34-key and 55-key keypad options.
Enter (ENT)		Confirms data entry.
Escape (ESC)		Cancels the current action.
Power Key		Puts the terminal in and wakes the terminal from Suspend Mode; see Software/Operating System Upgrades on page 3-17.
SCAN Key		Activates the scan and “wakes” the terminal from Sleep Mode. Its position allows convenient one-handed image-taking and/or bar code decoding.
Space (SP)		Moves the cursor one space.
Tab		Moves the cursor to the next tab stop or the next control (on a form).





Preliminary Draft 1/19/11

Using the Modifier Keys



Name	Key	Function
ALPHA	 34-Key	The ALPHA key enables you to toggle between the alpha and numeric modes. See ALPHA Key on page 6-5.
Blue and Red	 Blue  Red	The blue and red keys are used in combination with other keys to type special characters and perform system functions. Each key modifies only the next key pressed. Each keyboard is color-coded to indicate the character typed or function performed when specific keys are pressed immediately after the blue or red modifier key.
Number Lock (NUM)	 43-Key	The Number Lock key enables you to toggle between the alpha and numeric modes. See Number Lock (NUM) Key on page 6-11.
Shift (SFT)	 34-Key  43-Key  55-Key	The shift key modifies only the next key pressed; it must be pressed before each key you wish to modify. Shift toggles the keyboard between uppercase alphabet mode and lowercase alphabet mode. Press the shift key twice to toggle Caps Lock on and off. When Caps Lock is toggled on, characters are uppercase; when toggled off, characters are lowercase.

Using the Navigation Keys

Located in the center of each keyboard for easy access with either hand, the navigation keys navigate the cursor through application screens.

Key	Function
	Moves the cursor up one row or line.
	Moves the cursor down one row or line.
	Raises the volume.
	Lowers the volume.
	Moves the cursor up one page.

Preliminary Draft 1/19/11

Key	Function
 Red	Moves the cursor down one page.
	Moves the cursor one character to the right.
	Moves the cursor one character to the left.

Note: Additional functionality varies according to the application in use.

Preliminary Draft 1/19/11

34-Key Alpha/Numeric Keyboard

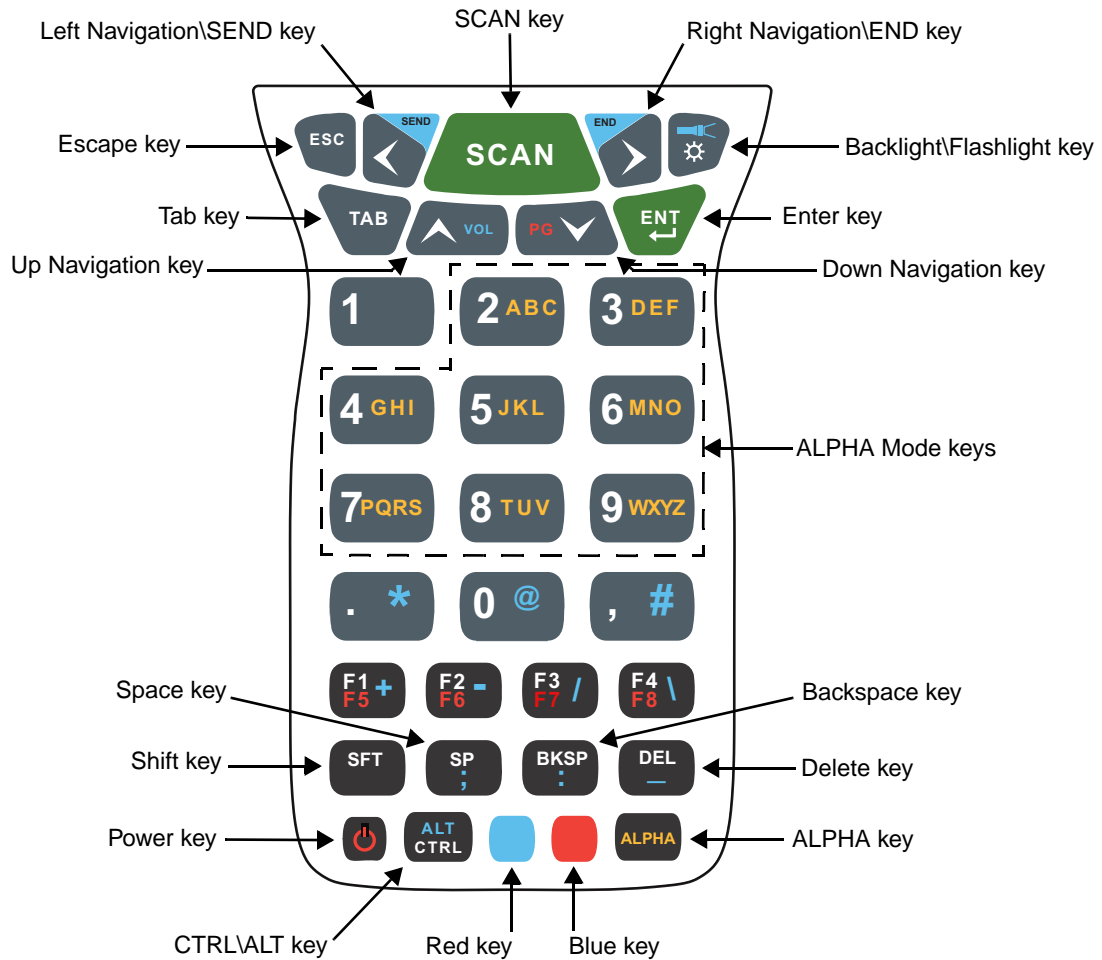

ALPHA Key

The ALPHA lock key enables you to toggle between the alpha and numeric keyboard modes. On the 34-Key Keyboard, numeric mode is the default. Press the ALPHA key once to switch to ALPHA lock mode. Press the ALPHA key again to exit the ALPHA lock mode.

Preliminary Draft 1/19/11

34-Key Alpha/Numeric Keyboard Combinations

Key	NUM (Default)	Shift-NUM	ALPHA	Shift- ALPHA	Blue	Red
ESC	Escape					
Left	Left	Left	Left	Left	Send (Phone)	Left
Scan	Scan					
Right	Right	Right	Right	Right	End (Phone)	Right
Backlight	Toggles Keyboard Backlight On/Off				Toggles Flashlight On/Off	Toggles Keyboard Backlight On/ Off
TAB	Tab	Tab	Tab	Tab	Tab	Tab
Up	Up	Up	Up	Up	Volume Up	Prior
Down	Down	Down	Down	Down	Volume Down	Next
Enter	Return					
1	1	!				
2	2	@	a,b,c	A,B,C		
3	3	#	d,e,f	D,E,F		
4	4	\$	g,h,i	G,H,I		
5	5	%	j,k,l	J,K,L		
6	6	^	m,n,o	M,N,O		
7	7	& (ampersand)	p,q,r,s	P,Q,R,S		
8	8	* (multiply)	t,u,v	T,U,V		
9	9	(w,x,y,z	W,X,Y,Z		
Period	. (period)	>	. (period)	>	* (multiply)	
0	0)			@	
Comma	, (comma)	<	, (comma)	<	#	

Preliminary Draft 1/19/11

Key	NUM (Default)	Shift-NUM	ALPHA	Shift- ALPHA	Blue	Red
F1	F1	F1	F1	F1	+	F5
F2	F2	F2	F2	F2	-	F6
F3	F3	F3	F3	F3	/	F7
F4	F4	F4	F4	F4	\	F8
SFT	Shift	Shift	Shift	Shift		
SP	Space	Space	Space	Space	;	Space
BKSP	Backspace	Backspace	Backspace	Backspace	:	Backspace
DEL	Delete	Delete	Delete	Delete	Underscore	Delete
Power	Off/On					
CTRL	Control		Control		Menu	
Blue	Blue		Blue		Blue	
Red	Red		Red			Red
ALPHA	Toggles between ALPHA mode and NUM Lock mode					

Preliminary Draft 1/19/11

34-Key Numeric (Calculator) Keyboard

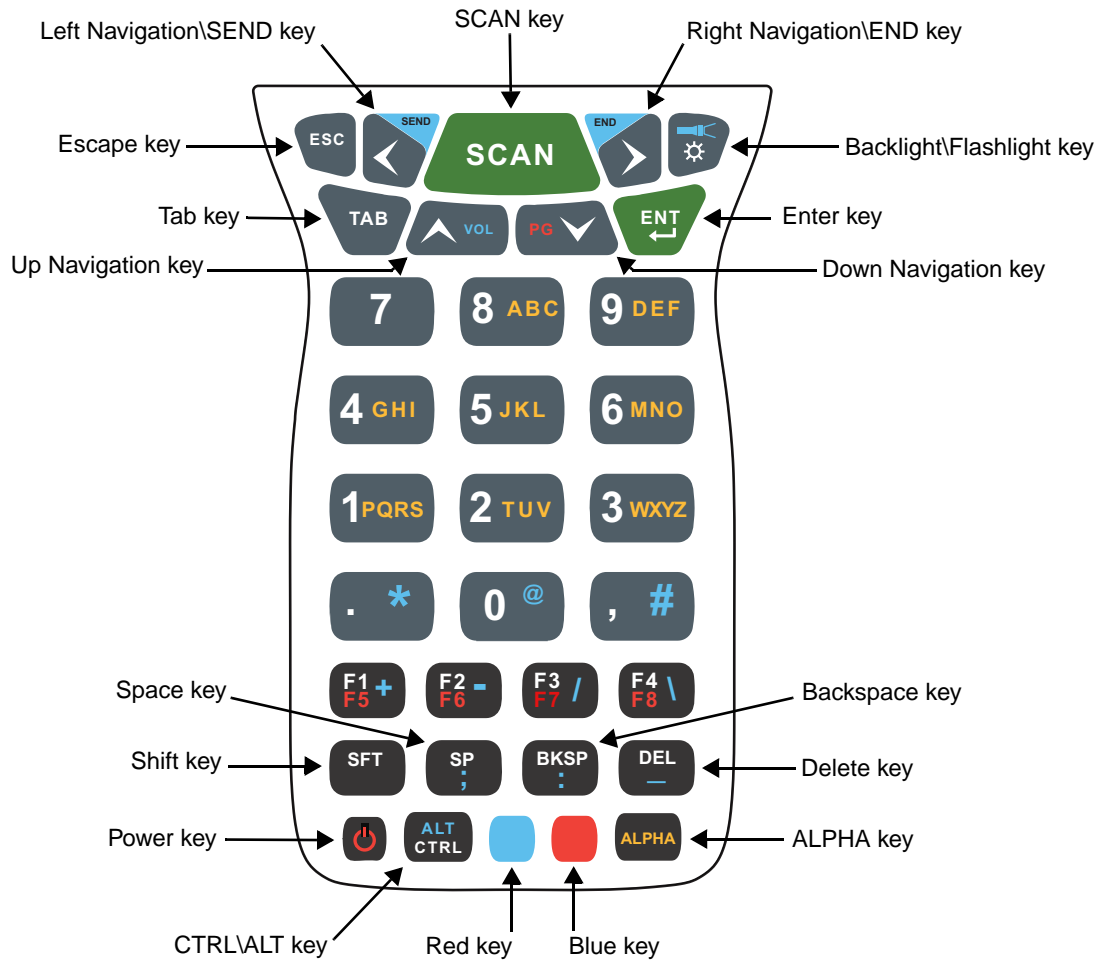

ALPHA Key

The ALPHA lock key enables you to toggle between the alpha and numeric keyboard modes. On the 34-Key Keyboard, numeric mode is the default. Press the ALPHA key once to switch to ALPHA lock mode. Press the ALPHA key again to exit the ALPHA lock mode.

Preliminary Draft 1/19/11

34-Key Numeric (Calculator) Keyboard Combinations

Key	NUM (Default)	Shift-NUM	ALPHA	Shift- ALPHA	Blue	Red
ESC	Escape					
Left	Left	Left	Left	Left	Send (Phone)	Left
Scan	Scan					
Right	Right	Right	Right	Right	End (Phone)	Right
Backlight	Toggles Keyboard Backlight On/Off				Toggles Flashlight On/Off	Toggles Keyboard Backlight On/ Off
TAB	Tab	Tab	Tab	Tab	Tab	Tab
Up	Up	Up	Up	Up	Volume Up	Prior
Down	Down	Down	Down	Down	Volume Down	Next
Enter	Return					
1	1	!				
2	2	@	a,b,c	A,B,C		
3	3	#	d,e,f	D,E,F		
4	4	\$	g,h,i	G,H,I		
5	5	%	j,k,l	J,K,L		
6	6	^	m,n,o	M,N,O		
7	7	& (ampersand)	p,q,r,s	P,Q,R,S		
8	8	* (multiply)	t,u,v	T,U,V		
9	9	(w,x,y,z	W,X,Y,Z		
Period	. (period)	>	. (period)	>	* (multiply)	
0	0)			@	
Comma	, (comma)	<	, (comma)	<	#	

Preliminary Draft 1/19/11

Key	NUM (Default)	Shift-NUM	ALPHA	Shift- ALPHA	Blue	Red
F1	F1	F1	F1	F1	+	F5
F2	F2	F2	F2	F2	-	F6
F3	F3	F3	F3	F3	/	F7
F4	F4	F4	F4	F4	\	F8
SFT	Shift	Shift	Shift	Shift		
SP	Space	Space	Space	Space	;	Space
BKSP	Backspace	Backspace	Backspace	Backspace	:	Backspace
DEL	Delete	Delete	Delete	Delete	Underscore	Delete
Power	Off/On					
CTRL	Control		Control		Menu	
Blue	Blue		Blue		Blue	
Red	Red		Red			Red
ALPHA	Toggles between ALPHA mode and NUM Lock mode					

Preliminary Draft 1/19/11

43-Key Alpha/Numeric Keyboard

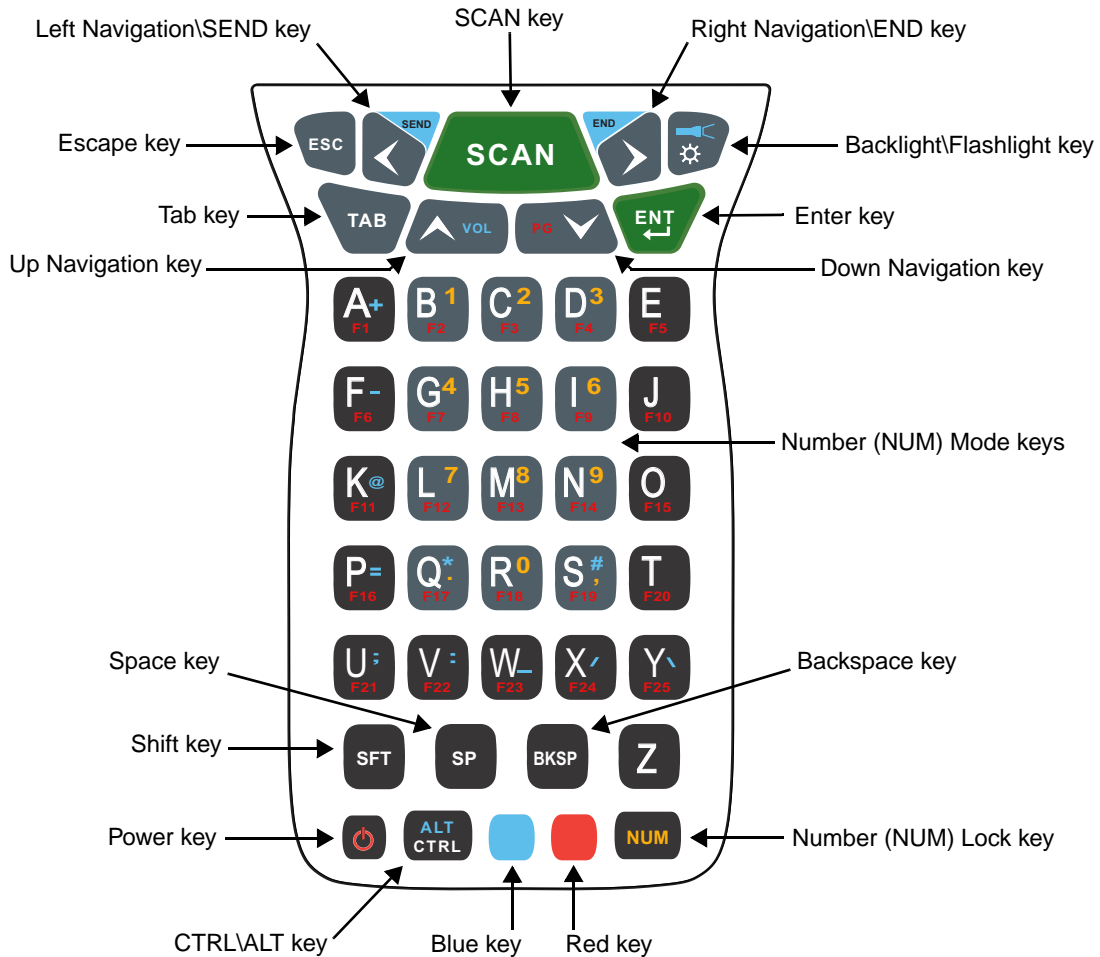

Number Lock (NUM) Key

The Number Lock key enables you to toggle between the alpha and numeric keyboard modes. On the 43-key keyboard, alpha mode is the default. Press the NUM key once to switch to NUM lock mode. Press the NUM key again to exit the NUM lock mode.

Preliminary Draft 1/19/11

43-Key Keyboard Combinations

Key	ALPHA (Default)	Shift-ALPHA	NUM	Shift-NUM	Blue	Red
ESC	Escape					
Left	Left	Left	Left	Left	Send (Phone)	Left
Scan	Scan					
Right	Right	Right	Right	Right	End (Phone)	Right
Backlight	Toggles Keyboard Backlight On/Off				Toggles Flashlight On/Off	Toggles Keyboard Backlight On/ Off
TAB	Tab					
Up	Up	Up	Up	Up	Volume Up (Phone)	Prior
Down	Down	Down	Down	Down	Volume Down (Phone)	Next
Enter	Return					
A	a	A			+ (add)	F1
B	b	B	1	!		F2
C	c	C	2	@		F3
D	d	D	3	#		F4
E	e	E				F5
F	f	F			- (subtract)	F6
G	g	G	4	\$		F7
H	h	H	5	%		F8
I	i	I	6	^		F9
J	j	J				F10
K	k	K		@	@	F11

Preliminary Draft 1/19/11

Key	ALPHA (Default)	Shift-ALPHA	NUM	Shift-NUM	Blue	Red
L	l	L	7	&		F12
M	m	M	8	* (multiply)		F13
N	n	N	9	(F14
O	o	O				F15
P	p	P			=	F16
Q	q	Q	. (period)	>	* (multiply)	F17
R	r	R	0)		F18
S	s	S	, (comma)	<	#	F19
T	t	T				F20
U	u	U			;	F21
V	v	V			:	F22
W	w	W			<u>(underscore)</u>	F23
X	x	X			/	F24
Y	y	Y			\	F25
SFT	Shift		Shift			
SP	Space					
BKSP	Backspace					
Z	z	Z				
Power	Off/On					
CTRL	Control		Control		Menu	
Blue	Blue		Blue		Blue	
Red	Red		Red			Red
NUM	Toggles between NUM lock mode and ALPHA mode					

Preliminary Draft 1/19/11

55-Key Full Alpha/Numeric Keyboard

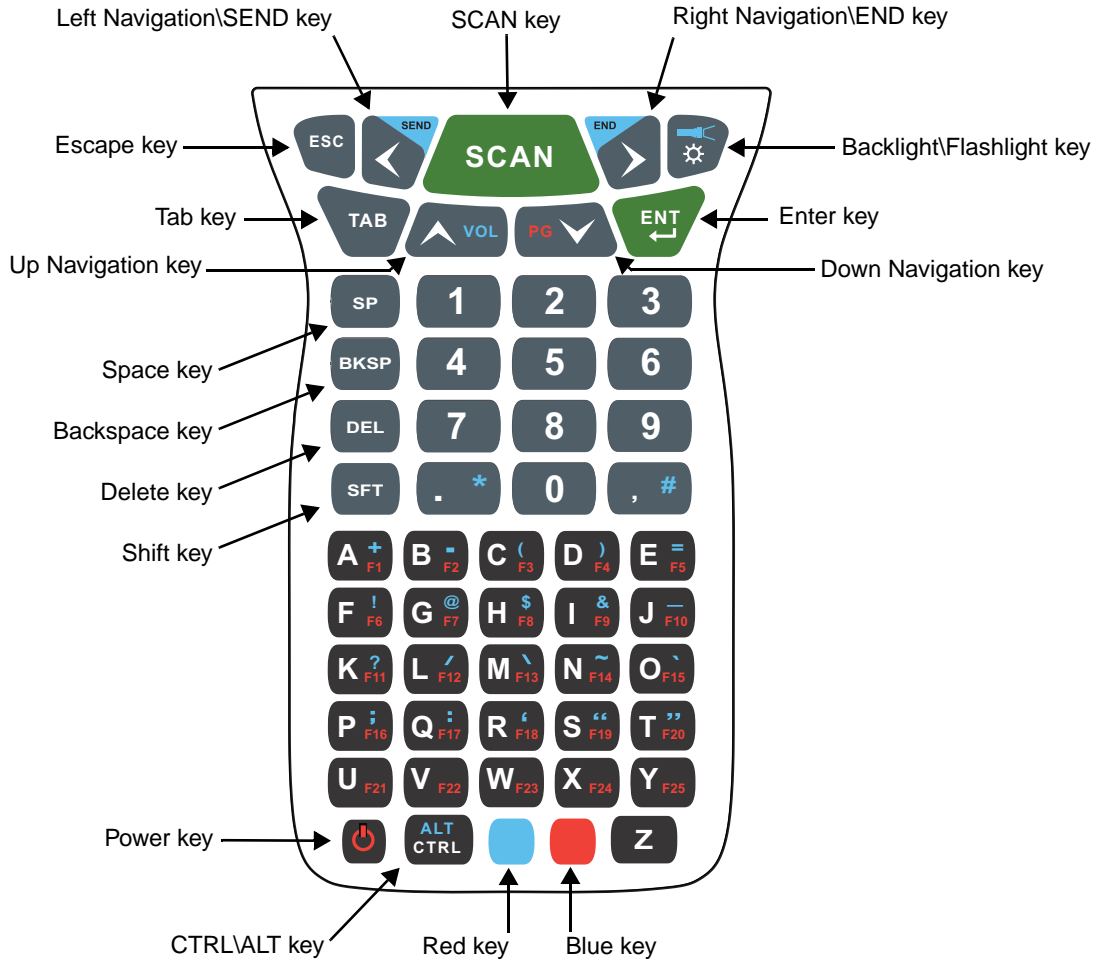

55-Key Keyboard Combinations

Key	Normal	Shift	Blue	Red
ESC	Escape			
Left	Left	Left	Send (Phone)	Left
Scan	Scan			
Right	Right	Right	End (Phone)	Right

Preliminary Draft 1/19/11

Key	Normal	Shift	Blue	Red
Backlight	Toggle Keyboard Backlight On/Off		Toggle Flashlight On/Off	Toggle Keyboard Backlight On/Off
TAB	Tab			
Up	Up	Up	Volume Up	Prior
Down	Down	Down	Volume Down	Next
Enter	Return			
SP	Space			
1	1	!	1	1
2	2	@	2	2
3		#	3	3
BKSP	Backspace			
4	4	\$	4	4
5	5	%	5	5
6	6	^	6	6
DEL	Delete			
7	7	&	7	7
8	8	*	8	8
9	9	(9	9
SHIFT	Shift			
Period	. (period)	>	* (multiply)	. (period)
0	0)	0	0
Comma	, (comma)	<	_ (underscore)	, (comma)
A	a	A	+ (add)	F1
B	b	B	- (subtract)	F2
C	c	C	(F3

Preliminary Draft 1/19/11

Key	Normal	Shift	Blue	Red
D	d	D)	F4
E	e	E	=	F5
F	f	F	!	F6
G	g	G	@	F7
H	h	H	\$	F8
I	i	I	&	F9
J	j	J	_ (underscore)	F10
K	k	K	?	F11
L	l	L	\	F12
M	m	M	/	F13
N	n	N	~	F14
O	o	O	'	F15
P	p	P	;	F16
Q	q	Q	:	F17
R	r	R	' (back quote)	F18
S	s	S	" (quotes)	F19
T	t	T	" (back quotes)	F20
U	u	U	u or U	F21
V	v	V	v or V	F22
W	w	W	w or W	F23
X	x	X	x or X	F24
Y	y	Y	y or Y	F25
Power	Off/On			
CTRL	Control		Menu	
Blue	Blue			

Preliminary Draft 1/19/11

Key	Normal	Shift	Blue	Red
Red	Red			
Z	z	Z	z or Z	z or Z

Preliminary Draft 1/19/11







Preliminary Draft 1/19/11

System Settings



Overview

Customized settings are available on the System Settings menu. Tap  > **Settings** and the settings screen opens.



Icon	Description
Bluetooth 	Configures the Bluetooth radio. See Working with the Bluetooth Radio on page 10-1.
Clock & Alarms 	Set the system clock, date, time and schedule alarms. See Clock & Alarms on page 7-2.
Lock 	Password protect the terminal to limit access to the terminal.
Sounds & Notifications 	Set the sound volume, enable or disable sounds for specific actions, set sound parameters for system notifications and enable or disable vibrator notification.
Home 	Customize the look and the information displayed on the Home screen.
Connections 	Establishes network connections settings. See Connections Menu on page 8-1.
Personal 	Customizes buttons, and set SIP options. See Personal Menu on page 7-3.

Preliminary Draft 1/19/11

Icon		Description
System		Adjusts system settings. See System Menu on page 7-7.
Microsoft My Phone		Synchronizes your phone's contacts, calendar, tasks, text messages, music, photos, videos, and other documents with your My Phone account at http://myphone.microsoft.com .

Clock & Alarms

The Clock & Alarms settings can be accessed from the Home screen or the Settings Menu.

1. On the Home screen, tap the line that displays the time and date

OR

Tap  > **Settings** > **Clock & Alarms**,

2. The Clock Settings screen appears. This setting sets the system clock. All scheduled items run according to this setting.

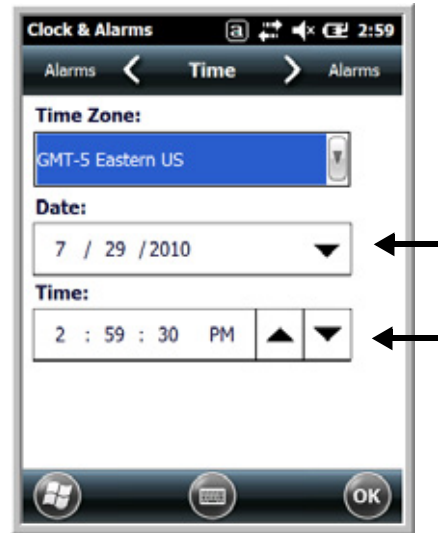



Tap the arrow to the right of the time zone to open the drop down menu. Select the appropriate time zone from the menu. Set the correct time and date in the remaining fields and tap **OK** to save.

Preliminary Draft 1/19/11

Personal Menu

To access the Personal Menu, tap  > **Settings** > **Personal**. The screen opens displaying the Personal Menu.





Icon	Description
Buttons 	Program the side buttons to perform specific tasks. See Buttons on page 7-3.
Owner Information 	Enter your contact information. This information will appear on the Home screen.
Phone 	When the GSM radio is enabled, tap this icon to set up user parameters. See Setup Options on page 9-7.

Buttons

The Buttons setting programs certain keyboard buttons to launch applications or execute commands.

Enable HotKeys

Default Buttons setting assignments are inactive until you enable the HotKeys Power Tool.

Tap  > **Power Tools** and tap the HotKeys icon  **once**. HotKeys is enabled, and the button assignments in the Buttons setting are active.

For more information about the HotKeys Power Tool, refer to the Dolphin Power Tools User's Guide, which is available for download from the web at www.honeywellaidc.com.

Preliminary Draft 1/19/11

Changing Button Assignments

1. After HotKeys is enabled, tap  > **Settings** > **Personal**  > **Buttons** .



Note: The buttons that appear on this window are the only buttons that can be programmed via the Buttons setting. You cannot add buttons to this window.

2. To change button assignment, tap on the name of the button in the **Button** column, and then select a program or command in the **Assign a program** drop down list.
3. Tap **OK** to save.
4. Press the button to verify that the program is launched or action performed.

Available Applications

The **Assign a program** list contains the applications installed on the terminal. If there is a program installed that you would like to see in this list, paste a Shortcut to the program in the `\\Windows\Start Menu\Programs` folder. For instructions about creating shortcuts, see [Using File Explorer](#) on page 7-5.

Additional Functions

The **Assign a program** list also contains the following commands:

Command	Description
<Context Menu>	Performs the same function as tap-and-hold to open the context menu for the control.
<Input Panel>	Opens the soft input panel.
<Left Softkey>	Opens the menu or performs the action displayed on the left side of the Command bar.
<Left Trigger>	Activates the scanner/imager.
<None>	Nothing happens when the button is pressed.
<OK/Close>	Performs the same function as tapping OK on the screen.

Preliminary Draft 1/19/11

Command	Description
<Right Softkey>	Opens the menu or performs the action displayed on the right side of the Command bar.
<Right Trigger>	Activates the scanner/imager.
<Rotate Screen>	Changes the screen orientation from portrait to landscape.
<Scroll Down>	Scrolls down in the open application.
<Scroll Left>	Scrolls left in the open application.
<Scroll Right>	Scrolls right in the open application.
<Scroll Up>	Scrolls up in the open application.
<Start Menu>	Opens the Start menu.

Using File Explorer

If you do not see the program listed, you can either use File Explorer to move the program or ActiveSync on the workstation to create a shortcut to the program and place the shortcut in the Start Menu folder.

Note: We recommend that you Copy and Paste Shortcut so that you do not alter your program configurations by accident. Using Copy and Paste Shortcut (as opposed to Cut and Paste) ensures that the program files remain where they need to be for the system to find them to perform system functions.

1. Tap  > **File Explorer** , and navigate to the program (**My Device > Program Files**).



2. Tap and hold on the program, then tap **Copy** on the pop-up menu.

Preliminary Draft 1/19/11

3. Navigate to the Windows folder and open the Start Menu (**My Device > Windows > Start Menu > Programs**), tap and hold a blank area of the window, and tap **Paste Shortcut** on the pop-up menu.



Note: If there is no blank space available in the window, tap on **Menu > Edit > Paste Shortcut**.



4. Tap  to verify that the program now appears on the Start menu.

Using ActiveSync on the Workstation

Here, you are performing the same basic process as on the terminal, except that you are using the Explore utility (Windows Explorer) to copy and paste the shortcut.

1. Open **ActiveSync > Explore** and navigate to the program.
2. Right-click on the program and select **Create Shortcut**.
3. Select the shortcut, right-click, and select **Cut**.
4. Navigate to the **Start Menu** folder (**Windows > Start Menu > Programs**).
5. Right-click on an empty area and select **Paste Shortcut**.
6. On the terminal, tap the **Start** menu.
7. Verify that program appears.

Preliminary Draft 1/19/11



System Menu

The System menu enables you to verify and sometimes alter system parameters. To access the System menu, go to **Start > Settings > System**. Tap the appropriate icon to open that system setting.



Icon	See Page
 About	See About on page 7-8.
 Backlight	See Backlight on page 7-9.
 Battery	See Battery on page 7-10.
 Certificates	See Certificates on page 7-10.
 Customer Feedback	See Customer Feedback on page 7-10.
 Encryption	See Encryption on page 7-11.
 Error Reporting	See Error Reporting on page 7-11.

Preliminary Draft 1/19/11

Icon		See Page
External GPS		See External GPS on page 7-11.
Five Volt Control		See Five Volt Control on page 7-12.
HISS		See HISS on page 7-12.
Managed Programs		See Managed Programs on page 7-14.
Memory		See Memory on page 7-14.
Power		See Power on page 7-16.
RIL		See RIL on page 7-15.
Regional Settings		See Regional Settings on page 7-16.
Remove Programs		See Remove Programs on page 7-17.
Screen		See Screen on page 7-18.
Task Manager		See Task Manager on page 7-19.

About

The About system setting displays specific information about the terminal. It contains three screens:

- Version Screen** Displays the information about the software, operating system, and processor.
- Device ID Screen** Displays the information the terminal uses to identify itself to other devices. It can be important to know this information if the Dolphin terminal is going to be part of a networked system of devices.
- Device name:** Displays the system's default name. (This is the name used by ActiveSync.)
- Description:** Displays the description of the device ID.

Preliminary Draft 1/19/11

Copyrights Screen Displays important copyright information.

Backlight

The Backlight system setting enables you to customize backlight functionality for the display. The backlight for the color display is user-defined. The Backlight system setting screen contains three tabs: Battery Power, External Power, and Brightness.

Tap  > **Settings** > **System** > **Backlight**.



The **Battery Power** tab determines the backlight timeout when the terminal is running on battery power.

The **External Power** tab determines the backlight timeout when the terminal is running on external power.

The options on the power tabs are the same.

Turn off backlight: Select how many minutes you want to elapse before the backlight automatically turns off.

Turn on backlight: Select this option if you want the backlight to turn on when the button is pressed or the touch screen is tapped.

The **Brightness** tab determines the backlight intensity. Move the slider to set the intensity of the backlight. The default is 8.

Preliminary Draft 1/19/11

Battery

The Battery system settings menu contains two tabs: Battery Status and Log Config. The **Battery Status** tab provides the status of the main battery pack (e.g., Battery Life Percentage, Voltage, Current, Temperature, Type, and Serial Number). The **Log Config** Tab allows you to enable and customize a time-event log.

Tap  > **Settings** > **System** > **Battery**

Battery Status Tab



Log Config Tab



Certificates

Certificates shows you the certificates that are recognized by the operating system. It contains three screens.

Intermediate Screen



Personal Screen



Root Screen



Customer Feedback

Customer Feedback gives you the option to participate in the Microsoft Customer Experience Improvement Program.

Preliminary Draft 1/19/11

Encryption

Encryption gives you the option of encrypting files placed on storage cards so that those files cannot be read by any other device.



Error Reporting

Error Reporting gives you the option of enabling or disabling the error reporting function of Windows Embedded Handheld 6.5.

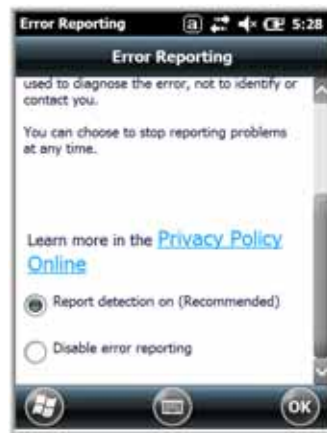

External GPS

External GPS determines which port a third-party GPS software application can use to access the GPS receiver.

Battery Power Tab

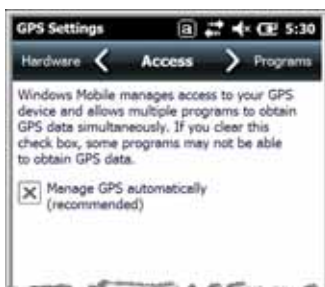

External Power Tab



Brightness Tab



Note: You need the installation parameters from the GPS manufacturer to configure the connection.

Preliminary Draft 1/19/11

Five Volt Control

Five Volt Control gives you the option to enable 5V output.

Note: Do not leave the USB Host enabled at all times.

HISS

The Honeywell Integrated Smart Sensor (HISS) configuration utility enables you to configure the Dolphin's integrated accelerometer, light, and proximity sensors.

Tap  > **Settings** > **System** > **HISS**.

Motion Settings

Motion Settings enable you to customize how the terminal responds to motion and object proximity for advanced power management.

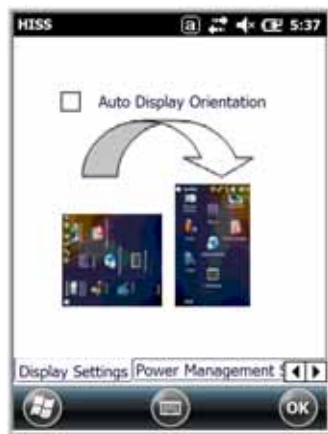

Display Settings enables or disables **Auto Display Orientation**. When enabled, the Dolphin's display automatically switches between portrait and landscape depending on how you hold the terminal.



Power Management Settings customize how the terminal responds to object proximity and motion.

- Save power by turning off the display or suspending the terminal when it is placed face down.
- Modify the Motion Detection settings to wake the terminal from suspend mode or prevent the terminal from entering suspend mode when motion is detected.

Preliminary Draft 1/19/11



Event Track displays an event log summary of detected free fall events **exceeding 2 ft. over 250 ms**. The summary includes the time, date, and duration of the most recent 50 events. Several options are provided for audible notification of free fall events.

Light Settings



Light Sensor Settings customize how the terminal responds to the environmental lighting conditions in which the terminal is being used.

- **Enable Display Backlight Adjustment** automatically adjusts the brightness of the display screen depending on the environmental lighting conditions.
- **Enable Automatic Keypad Backlight** automatically turns the keypad backlight on or off depending on the environmental lighting conditions.

Proximity Settings

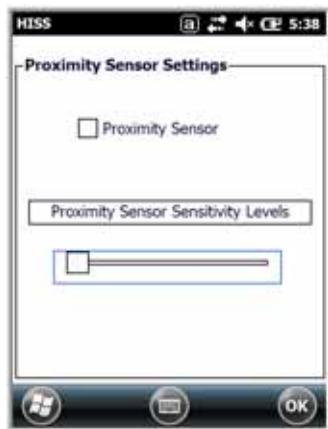

Proximity Sensor Settings customize how the terminal responds to objects detected close to the touch screen display (e.g., a person's face, carrying holster, or tabletop). When enabled, the terminal automatically turns the display off when it detects an object in close proximity to the entire touch panel display. The display turns back on when the sensor detects the removal of the object. Sensor sensitivity is adjusted using the slider bar.

Preliminary Draft 1/19/11

Accelerometer Calibration



Tap **Start** to calibrate the integrated accelerometer sensor used for motion detection. When calibration is complete, the "Accelerometer Calibration Finished!" message window appears.

Managed Programs

Managed Programs are a list of programs that are managed if enrolled to enterprise domain. Managed Programs is the client-side that works with the server product System Center Mobile Device Manager (MDM). MDM consists of MDM Gateway Server and one or more computers that run MDM Device Management Server; MDM Enrollment Server; and Microsoft SQL Server® 2005 databases.

It lets system administrators:

- provide an authenticated connection to LOB applications, managed Group Policy, and application packages.
- use Group Policy and software packages to manage the enrolled Windows phones (enforce policy, wipe devices, etc.).
- manage the requests for and retrieving of certificates for devices and for creating the Active Directory® Domain Service objects that represent these devices. By using these objects, you can manage the devices as if they were members of a domain.

Memory

The Memory system setting displays capacity and usage statistics for both RAM (volatile) and IPSM/ Storage Card (non-volatile) memory. Access this setting whenever you receive system messages about memory.

You cannot change the terminal's memory allocation in the Memory system setting. To change the memory allocation, you need to use the SetRAM Power Tool (**Start > Power Tools > SetRAM**). For more details, please refer to the Honeywell Power Tools User's Guide, which is available for download from www.honeywellaidc.com.

Preliminary Draft 1/19/11

There are two screens: Main and Storage Card.

Main Screen



This screen displays the usage statistics of the on-board, volatile RAM memory.

Columns:

Storage = RAM memory used to store programs and program data.
Program = RAM memory used to run programs.

Rows:

Total = Displays the current MB of memory allocated for use.
In use = Displays the total MB of that allocated memory being used.
Free = Displays the total MB of memory available.

Storage Card Screen



This screen displays the current capacity and usage statistics of the selected memory type: IPSM or Storage Card.

Select the memory type from the drop-down list. IPSM is selected by default.

Total storage card memory=
The total MB of memory capacity of IPSM or Storage Card.
In use = The MB currently being used.
Free = The MB that is still available for use.

Note: The IPSM partition is fixed at 128MB and cannot be increased in size.

IPSM—Short for Internal Persistent Storage Manager, this is the on-board Flash memory that is non-volatile. This memory is non-volatile, data or programs stored in IPSM are not affected when power is removed or the operating system is upgraded. Autoinstall programs, for example, are stored in \\IPSM\Honeywell\Autoinstall so that they are always installed after a operating system upgrade or factory reset. See Honeywell support for more information on how to perform a factory reset.

Storage Card—You can install one memory card in Dolphin terminals (see [Installing a Memory Card](#) on page 3-10). If a storage card is installed in the terminal, you can select it in the drop-down list and see capacity and usage statistics for the card.

RIL

The RIL Information screen displays useful statistics for the GSM WAN Voice module (PH8).

To verify whether or not the GSM radio is enabled, check the [Dolphin Wireless Manager](#) (see page 8-6).

Preliminary Draft 1/19/11

Power

Power system settings contains two tabs: Battery and Advanced.

Battery Tab

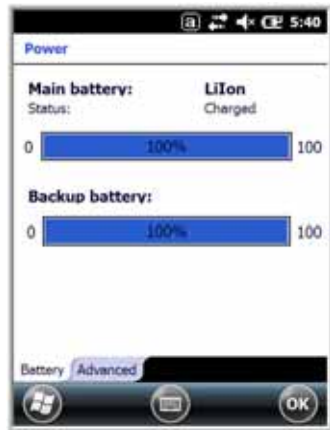

For more information, see [Batteries](#) on page 3-13.

Advanced Tab



Determines power time-outs.

For **On battery power**, select from the drop-down list, the number of minutes of inactivity you want to pass before the terminal powers off when running on battery power.

For **On external power**, select from the drop-down list, the number of minutes of inactivity you want to pass before the terminal powers off when running on external power.

Note: You can also set automatic turn-off times for the terminal to conserve power. When the terminal is “turned off,” that means that it goes into Suspend Mode, see [Software/Operating System Upgrades](#) on page 3-17.

Regional Settings

Regional Settings enables you to customize the appearance and formatting to your geographic region. Specifically, you can customize numbers (i.e., number of decimal places allowed), currency (i.e., using the \$ or € symbol), time, and date. These specifications apply to all screens, including the Home screen. The Region tab displays an overview of the region selected in the drop-down list at the top.

The terminal is loaded with a number of pre-programmed regional settings. Select one from the list and the results appear on the screen. To see specific settings or to change a specific setting, tap on one of the tabs, make the change, and tap **OK** to save it.

Preliminary Draft 1/19/11

Remove Programs

Remove Programs enables you to remove programs installed on the terminal. Use this setting to troubleshoot when you receive messages that the terminal is out of memory. The programs removed are removed from RAM memory. Any program (usually CAB or DLL files) stored in the Autoinstall folder (**My Device > IPSM > Honeywell > Autoinstall**) will re-install after the next hard reset, operating system upgrade or a factory reset.

For information about the hard reset process, see [Hard Reset \(Cold Boot\)](#) on page 3-17. See Honeywell support for more information on how to perform a factory reset.

1. Tap **Remove Programs**. In the list, select the program you want to remove.



2. Tap **Remove**. The following message appears:



3. Tap **Yes**. Wait while the program is removed.
4. Verify that the program no longer appears in the list.

Preliminary Draft 1/19/11

Screen

The Screen system setting contains three screens: General, Clear Type, and Text Size.

General Screen

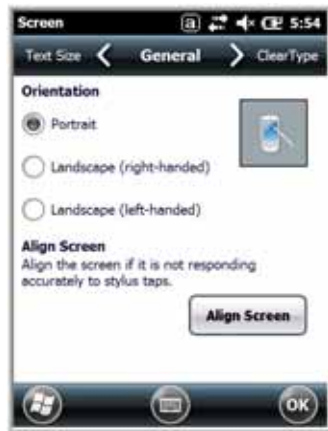

Orientation

The General screen enables you to set the dynamic screen rotation. Three choices of screen orientation are supported: Portrait, Landscape (right-handed), and Landscape (left-handed).

Align Screen

The General Tab also allows you to re-align the screen. You need to re-align the screen if tapping buttons or icons with the stylus no longer seems to work appropriately.

Tapping **Align Screen** brings up the align screen window where you are guided to tap a target several times. This recalibrates how the touch screen receives input.

- Alignment should always be performed with a stylus designed for touch panel applications. The small point is required for accurate calibration.
- Press the stylus firmly into the center of the cross-hair target once and release. Do not “double-tap” the target.

ClearType Screen



The display supports ClearType font rendering, which is a Microsoft technology that dramatically increases the readability of text on LCD displays.

To enable ClearType font rendering, select **Enable ClearType** and tap **OK**.

For more information about ClearType font rendering, visit: www.microsoft.com/typography/WhatIsClearType.mspx.

Preliminary Draft 1/19/11

Text Size Screen

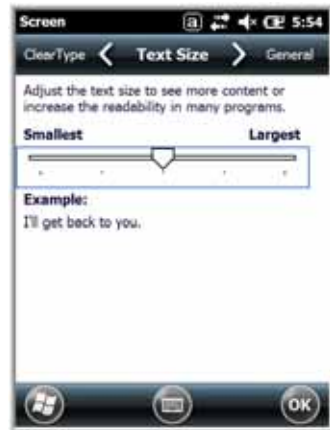

The Text Size screen enables you to perform font scaling within certain views of the:

- Home screen,
- Contacts,
- Calendar,
- Messaging, and
- Tasks.

Font scaling means that you can increase or decrease the point size of the font on application windows.

To change the font size, move the slider toward **Smallest** or **Largest**. The Example text changes to reflect the font change. Tap **OK** to save the new font size setting.

Task Manager

The Task Manager provides information about applications and processes running on your mobile computer. You can use the Task Manager to monitor the memory and CPU usage of specific applications and processes. Check the Task Manager when you are receiving out of memory errors or when the mobile computer is running slowly.

Application	Mem	CPU
ActiveSync	628K	0 %
File Explorer	196K	0 %
Task Manager	92.0K	0 %

Preliminary Draft 1/19/11

Using the Task Manager

Applications



To view the status of the programs running on your mobile computer, tap the **Menu** button at the bottom of the screen, then tap **View > Applications**.

From the application list, you can:

- Tap and hold on an application, then tap **Switch To** on the pop-up menu.
- Tap and hold on an application, then tap **End Task** or **End All Tasks** on the pop-up menu.

Note: Anytime you stop a running program, it frees up RAM memory. Be advised that, when you stop a program here, any unsaved data in that program is lost. To free up memory without risking data loss, return to the running program, save your data, and close the application.

Processes



To view information about the processes running on the mobile computer, tap the **Menu** button at the bottom of the screen, then tap **View > Processes**.





Preliminary Draft 1/19/11

Communication

Connections Menu

The Connections system setting provides access to the terminal's various wireless communication options.



Icon		Tapping this icon...
Beam		Enables infrared communication. See Receiving Data on page 8-3.
Connections		Opens Microsoft's connections manager. See Connections Manager on page 8-4.
Domain Enroll		Opens the Enrollment screen for connecting your phone with company resources. <i>Note: System administrator password is required for domain enrollment.</i>
USB to PC		Enables advanced wired USB to PC communication via sync software. See Communication on page 8-8.
Wi-Fi		Enables you to configure Wireless Zero Config (WZC). This icon appears only if the 802.11a/b/g driver is loaded on the terminal and the Honeywell WLAN Security Supplicant is not loaded. By default, the Wireless Zero Config is disabled and the supplicant is loaded. This icon appears only if you removed the supplicant and cold booted the terminal.

Note: All server-assigned IP addresses use Dynamic Host Configuration Protocol (DHCP).

Note: The Dolphin Wireless Manager controls the wireless radios installed in the terminal, see [Dolphin Wireless Manager Window](#) on page 8-6. for additional information.

Preliminary Draft 1/19/11

Using the IrDA Port

Using the IrDA port, you can send and receive data between the terminal and other devices equipped with infrared. This can include, but is not limited to, Windows Embedded Handheld information such as Contacts and Tasks, as well as software upgrades.

IrDA Port Location

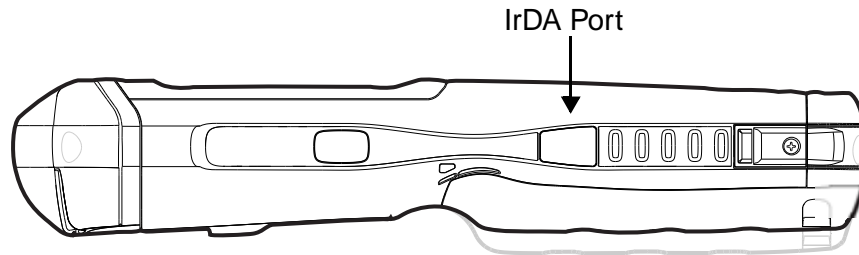

To send or receive, the IrDA ports of both devices - whether it is two terminals, or a terminal and a host device - must be aligned with each other and within a close range. The maximum data transfer speed is 115 Kbps.

Sending Data

1. Align the IrDA ports.
2. Open the program where you created the item you want to send and locate the item in the list. You can also beam files, but not folders, from File Explorer.
3. Tap and hold the item and select **Beam File**.



4. The IrDA port searches for a receiving IrDA port in the vicinity. The selected device reads "Pending."

