

# Preliminary Draft 1/19/11

---

- When the IrDA port finds the aligned IrDA port, it immediately starts sending the selected file. The selected device reads "Sending."

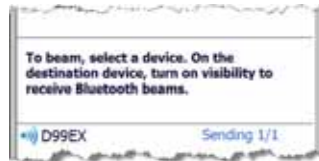

- When the file transfer is complete, the selected device reads "Done."

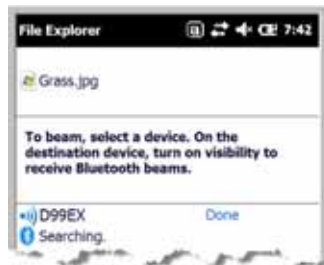

## ***Receiving Data***

The Beam Setting must be set to receive all incoming beams from other infrared devices.

- Verify that beam settings are set to receive. Tap  > **Settings** > **Connections** > **Beam**. The Beam Settings window should appear as follows:



- Align the IrDA ports.
- Have the owner of the other device send the data to you.
- Your terminal automatically begins receiving the data.
- A popup message appears asking if you want to save the incoming file.
- Tap **Yes** to receive the file.

# Preliminary Draft 1/19/11

---

## **Connections Manager**

Microsoft's Connections Manager sets up multiple network connections to Internet Service Providers (ISPs) via external modem.

**Do NOT enter connection parameters in the Connections Manager if:**

- You are using one of the on-board wireless radios to connect to a network.  
The Dolphin terminal uses the settings from each radio's configuration utility to connect.
- You are using Wireless Zero Config. By default, WZC is disabled on Dolphin terminals.

## **To Access the Connections Manager**

Tap  > **Settings** > **Connections**  > **Connections** .



## **Tasks**

The Tasks screen enables you to initially configure, and then manage network settings when using a modem. Select an item in this list and then complete the setup screens that follow with the appropriate information for your network.

### **My ISP**

The links under this heading enables you to add and manage modem connections to an ISP. To complete the setup screens, obtain the following information from your ISP:

- ISP dial-up access telephone number
- Username
- Password
- TCP/IP settings

### **My Work Network**

These links enable you to establish the following connections types:

- Modem
- Virtual Private Network (VPN)

# Preliminary Draft 1/19/11

---

- Proxy server connection

*Note: If you are connected to your ISP or private network during synchronization, the terminal should download the proper proxy settings during synchronization with the PC. If these settings are not on your PC or need to be changed, ask your ISP or network administrator for the proxy sever name, server type, port, type of Socks protocol used, and your user name and password.*

To complete the setup screens, obtain the network parameters from your system administrator.

## *Modify an Existing Connection*

**Manage Existing Connections** appears on the Connections tab after at least one network connection has been established.

Tap **Manage Existing Connections** on the Horizontal scroll and follow the setup screens.



## **Advanced**

The Advanced screen enables you to select the default network, dialing rules, and IP address exceptions for modem connections.



*Note: You should not need to change Advanced settings because most ISPs now use DHCP addresses.*

# Preliminary Draft 1/19/11

## ***Dolphin Wireless Manager***

The Dolphin Wireless Manager provides a centralized interface that enables and disables all the on-board radios. Each radio has its own configuration program. The Dolphin Wireless Manager also provides shortcuts to the configuration utilities for each radio.

Tap  on the Home screen to access the **Dolphin Wireless Manager**.

OR

1. Tap once on the Title bar to access the Horizontal Scroll bar.

2. Tap .

3. Select, "Dolphin Wireless Manager".



## ***Dolphin Wireless Manager Window***



These buttons show you the state of the radio.

If applicable, information about the radio appears when the radio is activated.

## ***Enabling the Radios***

1. Tap  on the Home screen to access the **Dolphin Wireless Manager**.



2. Tap anywhere inside the rectangle or the **OFF** button inside the rectangle.

# Preliminary Draft 1/19/11

---

3. The radio begins activating.

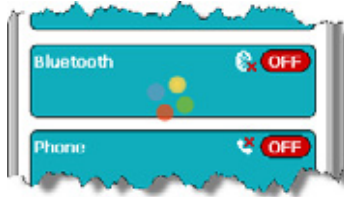

4. When the radio is activated (i.e., transmitting a signal), the **OFF** button changes to **ON**.



*Note: If applicable, information about the radio appears in the rectangle.*

## **Accessing Radio Configuration Utilities**

Each of the four radios has its own configuration utilities that you can access through the **Menu**.



There are four radio configuration utilities:

For **802.11a/b/g/n**: Tap **WLAN Settings** and the Honeywell WLAN Security Supplicant opens.  
The *Honeywell WLAN Security Supplicant User's Guide* is available for download from the Dolphin 99EX product page at [www.honeywellaidc.com](http://www.honeywellaidc.com).

For **Bluetooth**: Tap **Bluetooth Settings** and the Bluetooth Settings open.  
For details, see [Working with the Bluetooth Radio](#) on page 10-1.

For **GSM/HSDPA**: Tap **Phone Settings** and the Phone opens.  
For details, see [Working with Wireless Wide Area Networking \(WWAN\)](#) on page 9-1.

For **GSM/CDMA**: Tap **Gobi Settings** and the Gobi Manager opens. For details, see [Gobi Manager](#) on page 9-13.

# Preliminary Draft 1/19/11

---

## **Communication**

To synchronize data between the terminal and the workstation, ActiveSync (version 4.5 or higher) or Windows Mobile Device Center must be installed and configured for the appropriate communication type on the host workstation and the Dolphin terminal.

Dolphin terminals ship with ActiveSync already installed. Therefore, if ActiveSync is already installed on the host workstation, you just need to connect the Dolphin terminal to the host workstation (via Dolphin peripheral) to initiate communication.

If ActiveSync 4.5 or higher is not installed on the host workstation, you can download and install the most current version of ActiveSync from [www.microsoft.com](http://www.microsoft.com).

*Note: ActiveSync on your Dolphin terminal works with Windows Mobile Device Center on host workstations running Windows Vista or Windows 7 and with ActiveSync on host workstations running Windows XP. For detailed information on ActiveSync and WMDC visit Microsoft's Windows Mobile Web site.*



*When communicating via ActiveSync or Windows Mobile Device Center, your terminal is designed to be connected to the host workstation with a communication peripheral sold/manufactured by Honeywell, such as the charge/communication cable. Use of any peripheral not sold/manufactured by Honeywell may cause damage not covered by the warranty.*

## **Capabilities**

- Back up and restore your device data.
- Copy (rather than synchronize) files between your device and workstation.
- Control when synchronization occurs by selecting a synchronization mode. For example, you can synchronize continually while connected to your workstation or only when you choose the synchronize command.
- Select which information types are synchronized, controlling how much data is synchronized. For example, you can choose how many weeks of past appointments you want synchronized.

## **Communication Types**

The Dolphin terminal supports the following types of communication via ActiveSync through its [I/O Connector](#) (see page 3-11) on the bottom panel:

- USB**            The USB cable and hardware peripherals allow the terminal to communicate with a workstation or to networked through a USB hub. The Dolphin terminal supports high-speed USB communication (USB 2.0); maximum data transfer rate is 480 Mbps. The Dolphin terminal defaults to USB communication out of the box.
- RS232**           The RS232 cable allows the terminal to communicate with a workstation, modem, or any RS232 device. Maximum data transfer rate is 115 Kbps.

## **Hardware Requirements for Setup**

- Dolphin communication peripheral or cable
- Dolphin power cable from Honeywell
- USB cable (for USB communication)
- Serial cable (for RS232 communication)

## **Software Requirements for Communication**

- To synchronize successfully, ActiveSync (v4.5 or higher) or Windows Mobile Device Center must be configured for same communication type on both the host workstation and the Dolphin terminal.

# Preliminary Draft 1/19/11

ActiveSync or Windows Mobile Device Center must be setup on your workstation *before* you initiate synchronization from the terminal for the first time.

- Windows 98 Second Edition, Windows Me, Windows 2000, Windows NT (4.0 SP6 or higher), Windows XP, Windows Vista, and Windows 7 operating systems.

## Setting Up the Host Workstation

Verify that ActiveSync is configured to use the appropriate communication type by clicking **File > Connection Settings** in the ActiveSync window on your workstation.

For USB communication, check **Allow USB connections**.

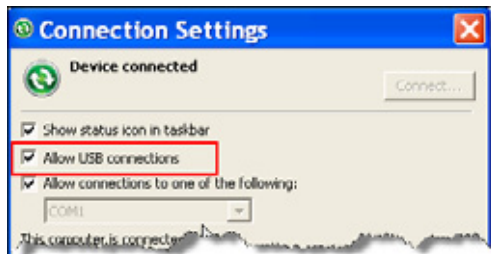

For RS232 communication, connect to **COM1**.

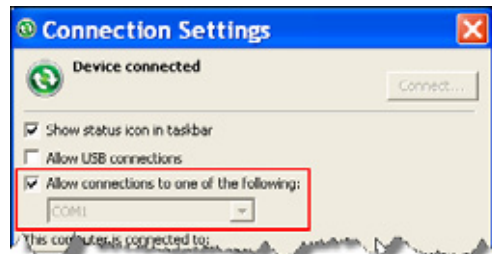

*Note: You can have both USB and RS232 selected in the software without affecting processing. However, your hardware setup should use only RS232 or USB, not both.*

## Communicating with the Dolphin Terminal

After setting up both the workstation and the terminal, ActiveSync connection should be automatic.

1. Connect the Dolphin terminal to a Dolphin communication peripheral.
2. The Dolphin terminal automatically opens ActiveSync to establish a connection.

## Synchronizing with the Host Workstation

After setup, synchronization begins automatically whenever the terminal's mechanical connector connects to a Dolphin peripheral that is connected to a host workstation with ActiveSync installed.

## Exploring the Terminal from the Workstation

When the Dolphin terminal and workstation are connected, open the main ActiveSync window (on the desktop), and click **Explore**.

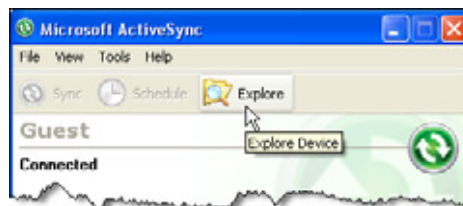

# Preliminary Draft 1/19/11

---

The Mobile Device folder opens in Windows Explorer.



The Dolphin terminal is now treated as a mass storage device, and transferring files is as simple as dragging and dropping or copying and pasting.

## ***Installing Additional Software***

In addition to the default programs installed on your terminal when it is first booted up, you can install any program (created for a Windows Embedded Handheld-based device), as long as the terminal has enough memory to store the program and the program has an EXE, CAB, or DLL extension.

The most popular place to find software is on the Windows Mobile website: [www.microsoft.com/windowsmobile/en-us/downloads/default.aspx](http://www.microsoft.com/windowsmobile/en-us/downloads/default.aspx)



*When selecting programs, verify that the program and version of the program are designed for Windows Embedded Handheld and your processor. You can verify your processor by tapping  > Settings > System > About > Version. Make a note of the information in the Processor field.*

You can install additional software via:

- ActiveSync - see page 8-10.
- Infrared - see page 8-2.
- Network connection (via wireless radio) - see page 8-11.
- Connect to your ISP.

## ***Adding Programs to the Terminal Using ActiveSync***



*When selecting programs, verify that the program and version of the program are designed for Windows Embedded Handheld and your processor. You can verify your processor by tapping  > Settings > System > About > Version. Make a note of the information in the Processor field.*

Depending on the application, the software must be stored or installed on the host PC.

1. Download the program to your desktop computer from either the Internet or the CD or disk that contains the program. You may see a single EXE or setup.exe file, a CAB file, or DLL. There may also be several versions of files for different device types and processors.
2. Read any installation instructions, Read Me files, or documentation that comes with the program. Many programs provide special installation instructions.
3. Connect the terminal to the desktop computer via a Honeywell communication peripheral.

### ***If the File is an Installer:***

An installer program is one that installs on the PC and the terminal simultaneously; one process installs to both devices.

1. On the PC, double-click the EXE or \*.setup.exe file. The installation wizard begins.



# Preliminary Draft 1/19/11

---

2. Follow the directions on the PC screen. The installation process includes transferring the software to the terminal.

## *If the File is Not an Installer:*

Some programs cannot be installed on PCs because they are designed for terminals. In these cases, the appropriate files must be stored on the host PC, transferred via ActiveSync, and installed on the terminal. If an error message stating that the program is valid but designed for a different type of computer appears during installation, you will know the program cannot be installed on the PC.

1. If you cannot find any installation instructions for the program in the Read Me file or documentation, open **ActiveSync** and click **Explore**.
2. Click on the **My Windows Mobile-Based Device**  folder and copy the program file or files to the **Program Files** folder on the terminal.
  - If you want the program to be part of the Autoinstall that occurs after every hard reset, place the program file in the **Autoinstall** folder (**My Windows Mobile-Based Device > IPSM > Honeywell > Autoinstall**).
3. Depending on the program, you may need to open **File Explorer** on the terminal, navigate to the folder where the program is located, and tap on the program file to install it.
  - If you copied the file to the **Autoinstall** folder, you can either tap on the program inside the Autoinstall folder or perform a hard reset and the program will install as part of the Autoinstall process that occurs during each hard reset. Remember, a hard reset erases RAM data! For more information, see [Hard Reset \(Cold Boot\)](#) on page 3-17.

After installation on the terminal is complete, tap  and the program and its icon appears on the Start screen. Tap it to open the program.

## **Adding Programs Directly from the Internet**



*When selecting programs, verify that the program and version of the program are designed for Windows Embedded Handheld and your processor. You can verify your processor by tapping  > **Settings > System > About > Version**. Make a note of the information in the Processor field.*

1. Determine your device and processor type so that you know which version of the software to install.  
Tap  > **Settings > System > About**. On the **Version** tab, make a note of the information in the **Processor** field.
2. Download the program to your device straight from the Internet using Internet Explorer Mobile. You may see a single EXE or setup.exe file, or several versions of files for different device types and processors.
3. Read any installation instructions, Read Me files, or documentation that comes with the program. Many programs provide special installation instructions.
4. Tap the file, such as an EXE file. The installation wizard begins. Follow the directions on the screen.
5. Select the radio or radio combination and tap **Apply**.  
The Radio Manager begins enabling your radio or radio combination.
6. When enabled, the **Status** field reads "Success".

# Preliminary Draft 1/19/11

---

## ***99EX COM Port Assignment Table***

| <b>COM Port</b> | <b>Description</b>  |
|-----------------|---|
| <b>COM0</b>     | Unused  |
| <b>COM1</b>     | <b>Serial Port:</b> RS232 Connector on the bottom panel   |
| <b>COM2</b>     | Bluetooth   |
| <b>COM3</b>     | <b>IrDA:</b> Serial Infrared (SIR) up to 115 Kbps         |
| <b>COM4</b>     | Available   |
| <b>COM5</b>     | Bluetooth DUN   |
| <b>COM6</b>     | IrCOMM  |
| <b>COM7</b>     | <b>GPS:</b> COM Port for the GPS receiver                 |
| <b>COM8</b>     | <b>USB Serial:</b> Virtual USB Serial port for ActiveSync |
| <b>COM9</b>     | Bluetooth BTHATCI server                                  |

# Preliminary Draft 1/19/11

## Working with Wireless Wide Area Networking (WWAN)

### Overview

The Dolphin 99EX terminal can be configured with an integrated, embedded GSM/UMTS/GPRS/EDGE penta-band radio module for WWAN communication.

|              |  |
|--------------|--|
| <b>GSM</b>   | Short for Global System for Mobile communications, GSM is an open, non-proprietary wireless WAN system that is constantly evolving and growing.  |
| <b>HSPA+</b> | Short for High-Speed Download Packet Access, HSPA+ is a non-voice value added service that allows packet-switched data to be instantly sent and received across mobile telephone networks.         |
| <b>UMTS</b>  | Short for Universal Mobile Telecommunications System, UMTS is a non-voice value added service that allows packet-switched data to be instantly sent and received across mobile telephone networks. |
| <b>GPRS</b>  | Short for General Packet Radio Service, GPRS is a non-voice value added service that allows packet-switched data to be instantly sent and received across mobile telephone networks.               |
| <b>EDGE</b>  | E-GPRS is a non-voice value added service that allows packet-switched data to be instantly sent and received across mobile telephone networks at a higher data rate than standard GPRS.            |

### Requirements

Using GSM/HSPA+/UMTS/GPRS/EDGE requires a:

- Network subscription to a GSM/HSPA+/UMTS/GPRS/EDGE network (you need to know what service providers are in your geographic area), and
- An installed SIM card that has been activated by the network service provider (see [SIM Card Installation](#) on page 9-3).

### Penta Band Antenna

The GSM radio features an internal antenna that is optimized for power output and receiver sensitivity. This is an omni-directional antenna.

For the HC-25 radio, there is a unified penta-band antenna that supports 850/900/1800/1900 (GSM/GPRS/EDGE) and 850/1900/2100 (HSPA+/UMTS) MHz for obtaining GSM service worldwide.



### Signal Strength

The signal strength of the GSM connection is indicated by the number of bars that appear in the signal strength icon in the Title bar at the top of the window.



# Preliminary Draft 1/19/11

---

| Icon  | Indicates...  |
|---|---|
|  | The signal strength of the radio connection.  |
|  | The signal strength of the phone (voice) connection; see <a href="#">GSM/HSPA+ Global Radio Dolphin Models</a> on page 9-5. |
|  | The signal strength of the data connection; see <a href="#">Data Communication</a> on page 9-9.                             |

## ***Voice and Data Communication***

Dolphin terminals with integrated GSM/HSPA+/UMTS/GPRS/EDGE radios are optimized for the following two-way voice and data communications:

**Voice:** GSM voice data (dial-up)

**Data:** Available speed depends on the wireless network carrier and their supported packet-data technology in addition to network conditions.

GPRS Class 10: data transmission max. 85.6 kbps (DL), max. 42.8 kbps (UL)

HSPA+: data transmission max. 3.6 Mbps (DL), max. 384 Kbps (UL)

UMTS: data transmission max. 384 Kbps (DL), max 384 Kbps (UL)

EDGE (E-GPRS) Class 10: data transmission max. 237 Kbps (DL), max. 118 kbps (UL)

You can use the GSM radio for voice communication and data communication but not at the same time. If you want to communicate over the phone (voice), you cannot send data. If you want to send data, you cannot use the phone.

# Preliminary Draft 1/19/11

---

## ***SIM Card Installation***

Short for Subscriber Information Module, a SIM card stores the subscriber's personal information, GSM/GPRS radio settings, security keys, contacts, etc. SIM cards can be installed in compatible mobile devices, enabling you to switch devices without losing personal and setup information.

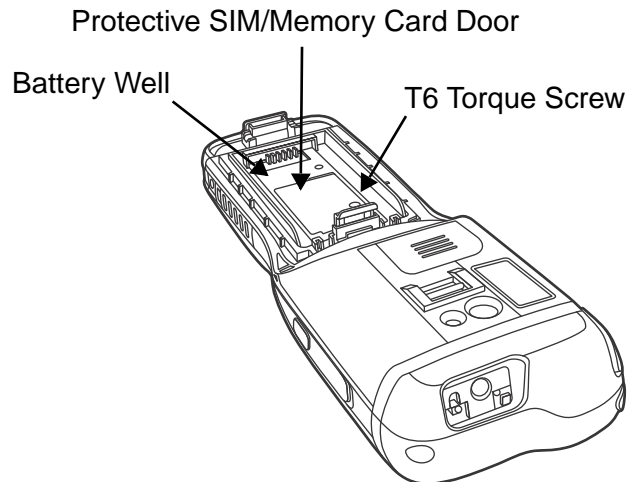

## ***SIM Card Requirements***

Before installing the SIM card:

- The service provider **must** activate the SIM card.
- The terminal **must** be powered down.

*Note: If no SIM card is installed, you can still make emergency phone calls such as 9-1-1, for example.*

# Preliminary Draft 1/19/11

## Installing a SIM Card

1. Press the Power key  to put the terminal in Suspend Mode.
2. Release the hand strap near the speaker on the back panel of the terminal.
3. Remove the battery door and the battery.
4. Remove the T6 torque screw securing the protective door closed.
5. Lift up the lower left corner of the door to access the SIM card socket.
6. Unlock the access door to the memory socket by sliding the door toward the IrDA port side of the terminal.
7. Lift the door up to expose the socket.
8. Insert the SIM card into the socket.

*Note: Make sure the interface on the card is connected to the SIM Card interface in the socket; align the beveled corner of the card with the beveled corner of the socket.*

9. Close and lock the access door.
10. Close the protective door over the memory socket. Install and tighten the T6 torque screw to secure the door closed.
11. Install the battery and the battery door.
12. Press the Power key  or SCAN key to wake the terminal.

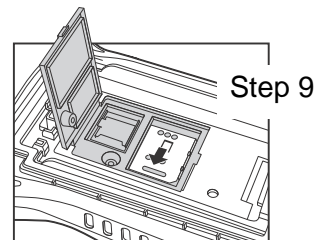
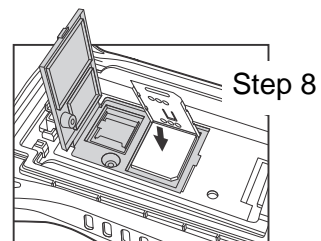
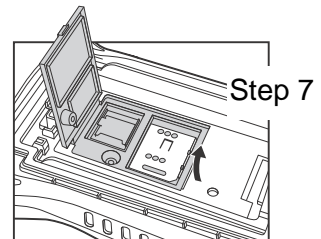
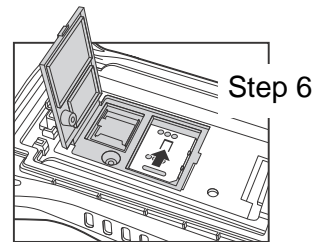
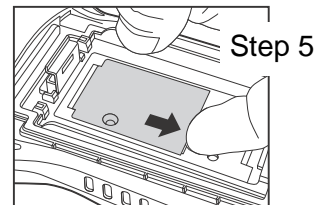
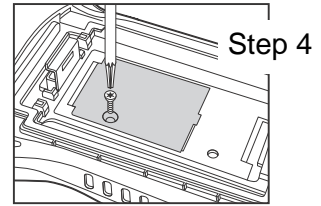

# Preliminary Draft 1/19/11

---

## ***Enabling the WWAN Radio***

By default, the WWAN radio is not enabled after a hard reset. Verify the status of the radio in the Dolphin Wireless Manager.

Tap  on the Home screen to access the **Dolphin Wireless Manager**.



If the WWAN radio is OFF, tap the rectangle to enable or turn ON the radio.

## ***GSM/HSPA+ Global Radio Dolphin Models***

### ***Voice Communication***

You can use the Dolphin terminal as a phone over the GSM radio.

### ***Audio Modes***

The front panel of the 99EX contains both a speaker and a microphone that you can use to send and receive audio signals over the GSM network, see [Front Panel: 99EX](#) on page 3-5.

There are two audio modes:

- **Handset Mode** - The front speaker is used for receiving handset voice calls and the front panel microphone provides audio input to the terminal.
- **Hands-Free Mode** - Hands-free mode is when you use the rear speaker as a speakerphone. To switch to speakerphone, tap on the speaker button in the Dialer window, see [Accessing the Dialer Window](#) on page 9-6.

# Preliminary Draft 1/19/11

## Volume Control



Use the Dolphin keyboard to adjust the volume.

To raise the volume, press the Blue modifier key + up arrow.

To lower the volume, press the Blue modifier key + down arrow.

Or

Press the up or down arrow on the Volume Control button on the right side of the device to adjust the volume of the active speaker, see [Volume Control Button](#) on page 3-9.

## Accessing the Dialer Window

Note: The WWAN radio must be active for voice communication, see [Enabling the WWAN Radio](#) on page 9-5.

Tap on the Home screen or tap > **Phone** to open the Phone dialer.

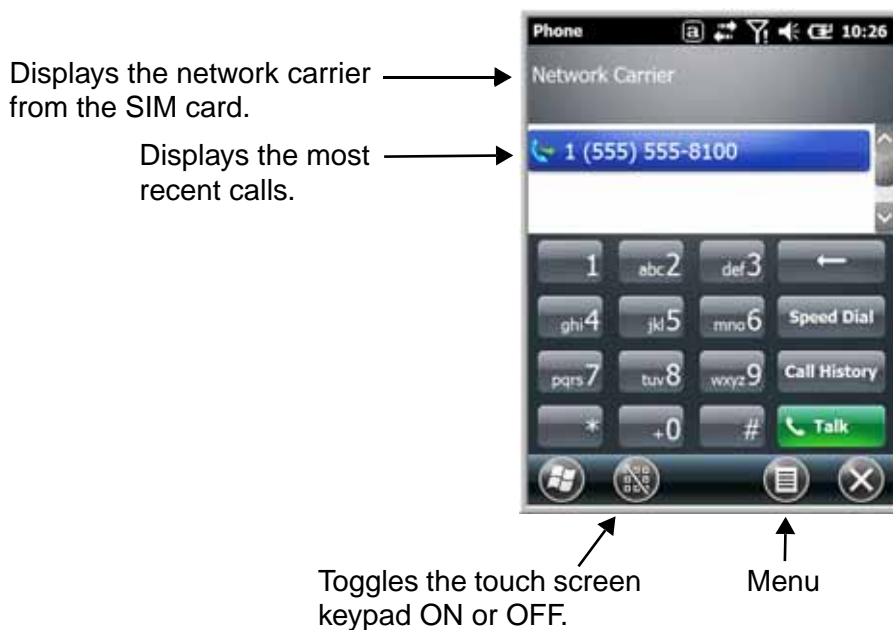

## Dialing

Once the dialer window is open, you can dial out two ways:

- Tap the buttons on the dialer window.
- Use the physical keyboard (when the keyboard is in numeric mode).



# Preliminary Draft 1/19/11

---

## **Sending Calls**

After the number is dialed, tap **Talk**  or press the **Blue**  + **Send** key .

*Note: The  icon indicates that the phone is in use.*

## **Ending Calls**

While the phone call is live, tap **End**  or press the **Blue**  + **End Key** .

## **Accessing Voice Mail**

Tap  > **Phone**  > **Speed Dial**  > **Voice Mail** > **Call**.

*Note: Update the voice mail retrieval number by turning the phone OFF and then ON via the Dolphin Wireless Manager, see [Enabling the WWAN Radio](#) on page 9-5.*

## **View Options**

From the view menu, you can modify the display screen to show Calls and Contacts, All Calls or Speed Dial numbers.

Tap **Menu**  > **View**.

## **Setup Options**

The Options menu contains four setting widows: Sounds, Security, Services, and Network.

Tap **Menu**  > **Options**.

### **Sounds**



The **Sounds** screen enables you to customize the:

- Ring type (e.g., Ring, Increasing ring, Ring once, Vibrate, Vibrate and ring, Vibrate then ring or None)
- Ring tone
- Keypad tone (e.g., Long, Short, or Off)

# Preliminary Draft 1/19/11

---

## Security



The **Security** screen provides access to establish or change your security PIN. Check the box next to, “Require a PIN when the phone is used” to enable the PIN security feature.

## Services



For each service, the phone reads settings from the network stored on the SIM card and then displays the available options from the carrier on the screen. To customize the settings, select it from the list and tap “Get Settings”.

# Preliminary Draft 1/19/11

---

## Network



You can find, select, and set your preferred network order from the **Network** screen.

## ***Data Communication***

You set up data communication via the Connections Manager. The carrier on the SIM card is the ISP.

## ***System Requirements***



- The GSM radio must be enabled; see [Enabling the WWAN Radio](#) on page 9-5.
- You must have an active SIM card with a DATA plan installed; see [SIM Card Installation](#) on page 9-3.

## ***Information Requirements***

You must have from the SIM card carrier:

- The APN (access point name).
- The username and password of the account.

## ***Establishing Data Communication (GSM/HSPA+ Global Radio Dolphin Models)***

1. Tap  > **Settings** > **Connection** > **Connections** .
2. Under My ISP, tap **Add a new modem connection**.

# Preliminary Draft 1/19/11

---

3. Enter a name for the connection. Select **Cellular Line (GPRS)** as the modem. Tap **Next**.

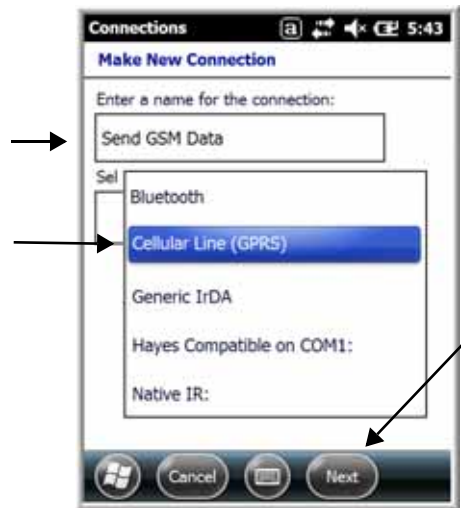

4. Enter the Access point name. Tap **Next**.



5. Enter the username and password from the account. Tap **Finish**.

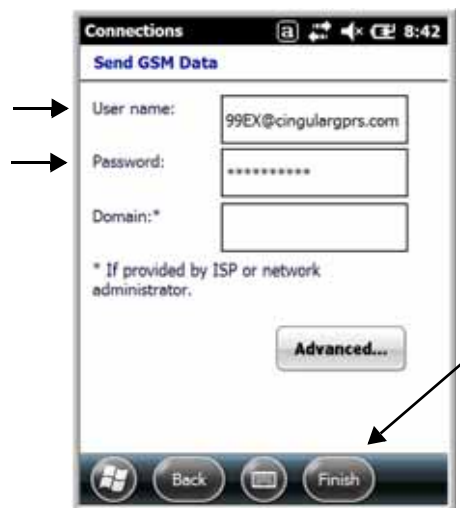

# Preliminary Draft 1/19/11

---

6. The connection you just created should appear in the list on the modem tab.

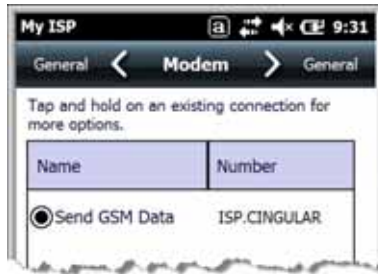

7. Tap and hold on the connection. Select **Connect** on the popup menu.

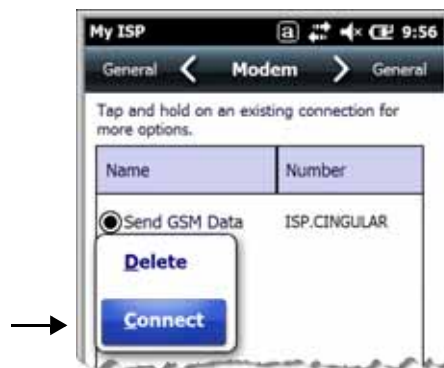

8. The network icon in the Title bar indicates the GSM radio is attempting to connect .

*Note: When the device is on a 2G (EDGE/GPRS) network, a data connection failure occurs if the phone is in use for a voice call while attempting a data connection. Simultaneous voice and data use is only supported if the device is on a 3G network. In 2G mode, a voice call takes precedence over data connections. Active data connections are placed in "park" mode automatically and the data is "retrieved" when the voice call ends.*

9. When the connection is complete, the network icon changes to: .
10. You can now send data over GSM.

## **Ending the Data Connection**

By default, the data connection will disconnect after a certain amount of time passes without use. This period of time is determined by ISP.

To end the data connection manually, tap the network icon  in the Title bar and select **Disconnect** on the popup bubble.

# Preliminary Draft 1/19/11

---

## Manual Network Selection

You can select Automatic or Manual network selection. The Phone defaults to Automatic network selection.

1. When an active SIM card is inserted in the terminal, tap

 > **Settings** > **Personal** > **Phone**  > **Menu** > **Options**.

2. Select the **Network** tab.



3. Under **Network selection**, select **Automatic** (the default selection) or **Manual**.
  - a. If you select **Manual**, the Phone searches for available networks.



- b. The found networks appear.



- c. Select a new network and tap **OK**. The Phone registers on the new network and the Network tab appears.
  - d. To switch to another network, tap the now active **Select** button and the process repeats.
4. To switch back to automatic roaming, select **Automatic** under **Select networks** and tap **OK**.

# Preliminary Draft 1/19/11

## GSM/CDMA Dolphin Models

### Gobi Manager

The Gobi Manager enables you to see real time status of the radio, setup your Network selection, view you're profile and scan for networks. The Gobi Manager contains five tabs: Status, Setup, Profile, Scan, and About.

1. Tap  on the Home screen to access the **Dolphin Wireless Manager**.
2. Tap **Menu**.
3. Select **Gobi Settings**.

#### Status Tab



The **Status** tab contains the real time radio status information including:

- The power status of the radio (e.g., ON or OFF)
- The received signal strength intensity (RSSI)
- The radio mode used (e.g., GSM, UMTS, EVDO or 1xRTT)
- The network firmware used
- The IP Address assigned

You can also turn the radio ON or OFF and Start or Stop a data session from the Status tab.

#### Setup Tab



The **Setup** tab allows you to view and customize the Network Setup including:

- The Network Firmware (e.g., AT&T, Verizon, Sprint, or T-Mobile)
- The SIM Slot accessed
- The Access Point Name (APN)
- The Username of the account
- The Password of the account
- Enable or Disable Automatic Data Sessions
- Activate Over the Air (OTA) or Manual

# Preliminary Draft 1/19/11

---

## Profile Tab

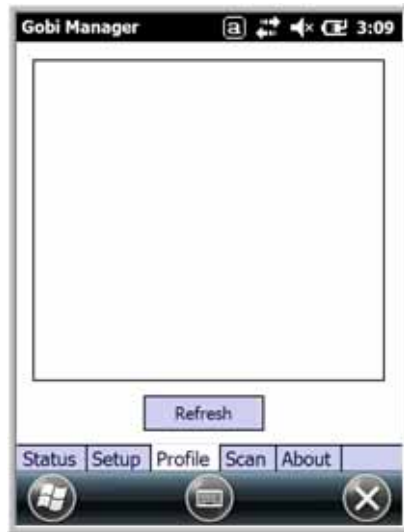

The **Profile** tab allows you to see Radio capability information and network statistics including:

- Radio Hardware and Software versions
- Radio and SIM identification numbers
- Serving network connection type and state
- Available radio interfaces for the current serving network

## Scan Tab

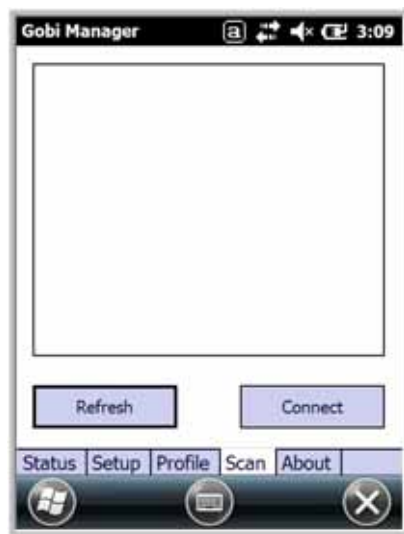

The **Scan** tab allows you to scan and connect to networks within the vicinity.

**About Tab** Displays copyright and version information for the Gobi Connection Manager

## ***Establishing Data Communication (GSM/CDMA Dolphin Models)***

### *Direct IP Method (Recommended)*

1. Tap  on the Home screen to access the **Dolphin Wireless Manager**.
2. Tap **Menu** and then select **Gobi Settings**.
3. From the **Setup** tab, select the carrier and enter user information (GSM only).
4. Check the **Auto Start Data Session** checkbox to automatically start the data session.





# Preliminary Draft 1/19/11

---

5. Tap the **Apply** button. The Connection Manager automatically switches to the **Status** Tab.
6. Tap the **Radio Power ON** button.
7. When the radio connects to the network, the status changes to “Registered” and a Signal Strength is displayed.
8. If **Auto Start Data Session** was checked on the **Setup** tab, the state automatically changes from “Registered” to “Data Session Open” and an IP address appears. If **Auto Start Data Session** was not selected, then the Data session can be started manually by tapping **Start Data Session** button from the **Status** tab.

## *Dial-up PPP Method*

1. Tap  > **Settings** > **Connection** > **Connections** .
2. Under My ISP, tap **Add a new modem connection**.
3. Enter a name for the connection. Select **SW Gobi ATPPP Modem**. Tap **Next**.

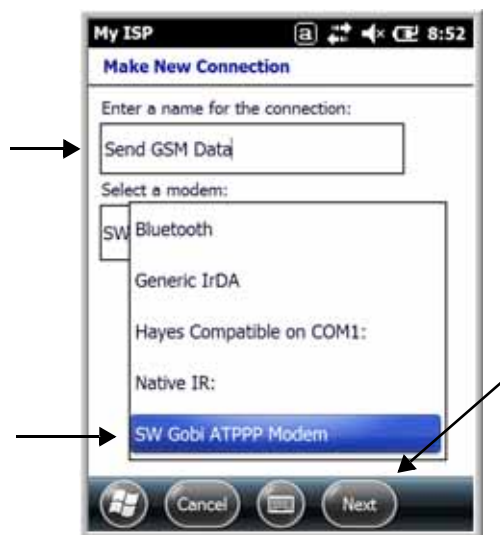

# Preliminary Draft 1/19/11

4. Enter the number. Tap **Next**.

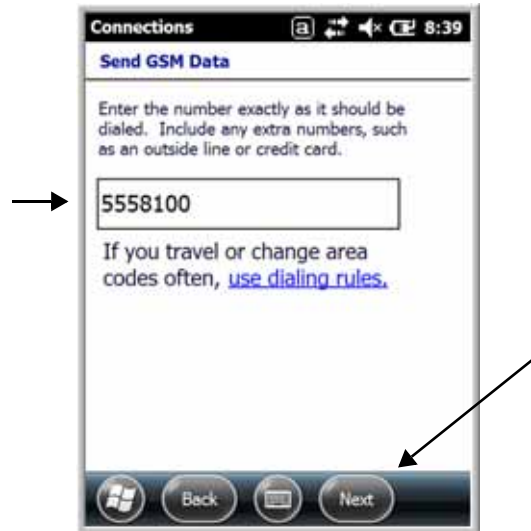

5. Enter the user name and password for the account. Enter the network APN in the Domain box. Tap **Finish**.



6. The connection you just created should appear in the list on the modem screen.



# Preliminary Draft 1/19/11

---

7. Tap and hold on the connection. Select **Connect** on the popup menu.



# Preliminary Draft 1/19/11

---

# Preliminary Draft 1/19/11

## Working with the Bluetooth Radio

### Enabling the Bluetooth Radio

You enable the Bluetooth radio in the [Dolphin Wireless Manager](#) (see page 8-6).

1. Tap  on the Home screen to access the **Dolphin Wireless Manager**.



2. Tap anywhere inside the Bluetooth rectangle and Bluetooth begins activating.

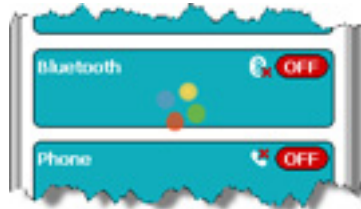

3. When the radio is activated (i.e., transmitting a signal), the **OFF** button changes to **ON**.



Now, the Bluetooth radio is transmitting a signal. Additional text in the Bluetooth section tells information about the Bluetooth radio. "Visible" and "Not visible" indicates whether the Bluetooth radio is discoverable or not discoverable by other Bluetooth devices.

Now, you can connect to other transmitting and discoverable Bluetooth devices (see page [10-2](#)).

To make the terminal discoverable for other Bluetooth devices, you need to make the Bluetooth radio discoverable (see page [10-8](#)).

# Preliminary Draft 1/19/11

---

## ***Connecting to Other Bluetooth Devices***

You need to perform a device discovery and then select a discovered device and connect to it. Pairing happens as part of the connection process.

1. In the Dolphin Wireless Manager, tap **Menu** > **Bluetooth Settings**.

OR

Tap  > **Settings** > **Bluetooth** .

2. Tap **Add new device**. The terminal begins searching for discoverable Bluetooth devices.



3. Select a device from the list and tap **Next**.



4. You are prompted to enter a passcode.  
If the device has a specific passcode, enter it in the **Passcode** field and tap **Next**.  
If the device does not have a specific passcode, enter one in the **Passcode** field and tap **Next**.

# Preliminary Draft 1/19/11

---

The Bluetooth radio tries to connect with the device.



5. If you created a passcode, you will be prompted by the other device to enter the same passcode. Enter the created passcode to establish a paired connection.  
If you entered a device specific passcode, you should not have to do anything on the other device.
6. When the connection is complete, a list of matching and supported services on the device appears.



7. Select the services you want to use and tap **Save**.  
The services on the new devices have to be selected or the pairing won't include those services, even though the devices are paired. If services are not selected, you will be continually re-prompted for the passcode from the device.

# Preliminary Draft 1/19/11

---

8. The device appears in the list on the main window.



9. After the passcodes have been accepted on both sides, you have a trusted ("paired") connection.

## ***Pairing and Trusted Devices***

The terminal does support pairing. Pairing happens during general connection setup. Paired devices are "trusted" devices. This means that there is unrestricted access to all services (including services that require authorization and authentication).

A connection can exclude pairing. A device that is connected to the terminal but not paired with it is considered an untrusted device. Content can still be passed to untrusted devices by requiring authorization with each attempt (for example, with the initialization of a file exchange). The Beam File method of file transfer can be used to pass a file as an untrusted device; see [Transferring Files](#) on page 10-7.



# Preliminary Draft 1/19/11

---

## ***Types of Devices and Services***

When you tap **Add new device** on the Devices tab, the Bluetooth radio scans for discoverable Bluetooth devices in range, which are Bluetooth devices that have been made discoverable.

### ***Device Types***

The types of devices in the vicinity of the radio appear in the list of discovered devices. →



### ***Supported Services***

Only the services that are mutually supported on both devices appear on the Partnership Settings window.



# Preliminary Draft 1/19/11

---

## ***Connecting to Bluetooth Printers***

1. Make sure the Bluetooth printer is in range and set to be discoverable by other Bluetooth devices.
2. Look up the Bluetooth printer's broadcasted ID.
3. Perform a device discovery (Tap **Settings** > **Bluetooth** > **Add new device.**)
4. Look for the Bluetooth printer's broadcasted ID in the list of discovered devices.
5. Click on the Bluetooth printer's ID and wait for the prompt to enter a **Passcode**.
6. Enter the **Passcode** and tap **Next**.  
The passcode may default to either "1111" or "0000." If there is no default, consult the printer literature for the number.
7. Select a printing-related service in the list of services.
8. Tap **Save** to establish the connection on the terminal.
9. Complete any additional steps required by the printer.

## ***Connecting to Bluetooth Headsets***

1. Make sure the Bluetooth headset is in range and set to be discoverable by other Bluetooth devices.
2. Look up the headset's broadcasted ID.
3. Perform a device discovery (Tap **Settings** > **Bluetooth** > **Add new device.**)
4. Look for the headset's broadcasted ID in the list of discovered devices.
5. Click on the headset's ID and wait for prompt to enter a passcode.
6. Enter the **Passcode** and tap **Next**.  
The passcode may default to either "1111" or "0000." If there is no default, consult the headset literature for the number.
7. Select **Headset** in the list of services.
8. Tap **Save** to establish the connection on the terminal.
9. Complete any additional steps required by the headset.

# Preliminary Draft 1/19/11

## Transferring Files

1. Tap  > **File Explorer**.
2. Navigate to the file you want to transfer.
3. Tap and hold on the file and select **Beam File** on the popup menu.



4. The Bluetooth radio begins searching for devices.



When a Bluetooth device is first found, it appears as an Unknown device; the  icon indicates that the device is a Bluetooth device.

As data is retrieved, the

5. Tap the device to begin sending the selected file.
6. While trying to connect, the selected device reads "Pending".

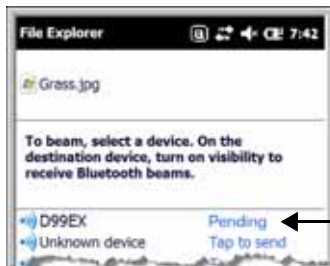

7. When the file is being transferred, the selected device reads "Sending".

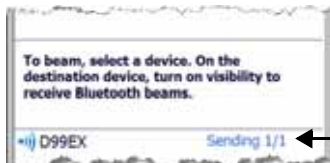

# Preliminary Draft 1/19/11

---

## ***Making the Terminal Discoverable***

By default, the Dolphin terminal is not discoverable, which means that the terminal will not be found by other Bluetooth devices.

To make the terminal discoverable, tap **Mode** on the Horizontal scroll. Select **Make this device visible to other devices** and tap **OK**.



## ***Selecting COM Ports***

You can select COM ports 0-9. For more information, see [99EX COM Port Assignment Table](#) on page 8-12.



### Overview

The Dolphin 99EX terminal contains an integrated GPS module that allows location tracking of workers and vehicles, providing better utilization of field assets. Optional mapping and navigation software provides turn-by-turn driving directions and location information.

### Assisted GPS Support

The operating system software does not inhibit nor explicitly support assisted GPS modes, which usually requires installing a vendor-specific client on the terminal that communicates with the GPS module. This client would then provide the almanac and/or ephemeris data for warm or hot start modes of operation, allowing a lower time to first fix (TTFS). The Client must be configured on the terminal, active, and provide the data to the GPS module through the standard COM port.

### Powering the GPS Module

The GPS module powers on automatically when accessed by a software application and powers off automatically when that software application closes. You cannot manually power on and off the GPS module.

### Communication Ports

There are two ways to access the GPS module: through the actual COM port (COM7) or the GPS Intermediate Driver. The method you use depends on the software application you are using. If the software application requires the actual COM Port, set the operating system to use COM7. If the software application requires the GPS Intermediate Driver, set the operating system to use the GPS Intermediate Driver.

### Selecting the Port

1. Tap  > **Settings** > **System** > **External GPS**.
2. In the **GPS program port:** drop-down list, select **COM7** or **GPD1** (the GPS Intermediate Driver) as required by the application.



# Preliminary Draft 1/19/11

---

3. Tap **OK** to save.

## **COM7**

COM Port 7 can be set to the following baud rates:

- 4800
- 9600 (This is the default baud rate and recommended for optimal GPS functioning.)
- 19200
- 38400

Other baud rates are not possible. The baud rate selected on COM7 is the actual baud rate with which the GPS will be communicating.

## **GPS Intermediate Driver**

When the first user of GPD1 opens the port, the GPS Intermediate Driver in turn opens port COM7. The GPS Intermediate Driver allows multiple applications to open GPD1, and the GPS data is broadcast to all open ports.

When the GPSID driver is in use, the COM7 port is allocated to GPSID as READ|WRITE (COM7 is still available for access mode of 0).

For more information about Microsoft's GPS Intermediate Driver, follow this link:

<http://msdn.microsoft.com/en-us/library/ms850332.aspx>

## **GPS Demo**

The GPS Demo demonstrates the main functionality of the integrated GPS module. The GPS Demo uses COM7.

To see the GPS Demo, tap  > **Demos** > **GPS Demo**.

For complete information about how to operate the GPS Demo, refer to the *Demos User's Guide for Windows Mobile 6.5*, which is available for download from [www.honeywellaidc.com](http://www.honeywellaidc.com).

# Preliminary Draft 1/19/11

## Dolphin 99EX HomeBase Device

### **Overview**

As the hub of your Dolphin system, the Dolphin 99EX HomeBase charging and communication cradle supports both RS232 and USB communications, which make it able to interface with the majority of PC-based enterprise systems.

### **Charge Time**

The base completes a full charge of the main battery pack installed in the terminal seated in the terminal well in 4.5 hours for the standard 3.7V battery or 6 hours for the extended 3.7V battery. The base completes a full charge of the battery pack in the [Auxiliary Battery Well](#) (see page 12-2) in 4.5 hours for the standard 3.7V battery or 6 hours for the extended 3.7V battery.

### **Charging Process**

The base also provides power to the intelligent battery charging system in all Dolphin terminals that senses when a full charge has been achieved and switches to a trickle charge to maintain the full charge.

### **Communications**

Reliable data communications at speeds of up to 115K baud can be transmitted by the base through the RS232 serial port. Using the high-Speed USB port, the data transmission rate goes up to 480 Mbps. These bases cannot be physically connected to each other - sometimes referred to as "daisy-chained".

### **Convenient Storage**

The intelligent battery charging system makes this base a safe and convenient storage receptacle for your Dolphin terminal.

### **Capacity**

The base holds one terminal and features an auxiliary battery well behind the terminal well that can charge a battery pack independently of the terminal well. This means that one base can charge two battery packs: the one installed in the terminal and a spare.



*We recommend use of Honeywell Li-ion or Li-poly battery packs. Use of any non-Honeywell battery may result in damage not covered by the warranty.*



*We recommend use of Honeywell peripherals, power cables, and power adapters. Use of any non-Honeywell peripherals, cables, or power adapters may cause damage not covered by the warranty.*

# Preliminary Draft 1/19/11

---

## Parts and Functions

### Front Panel

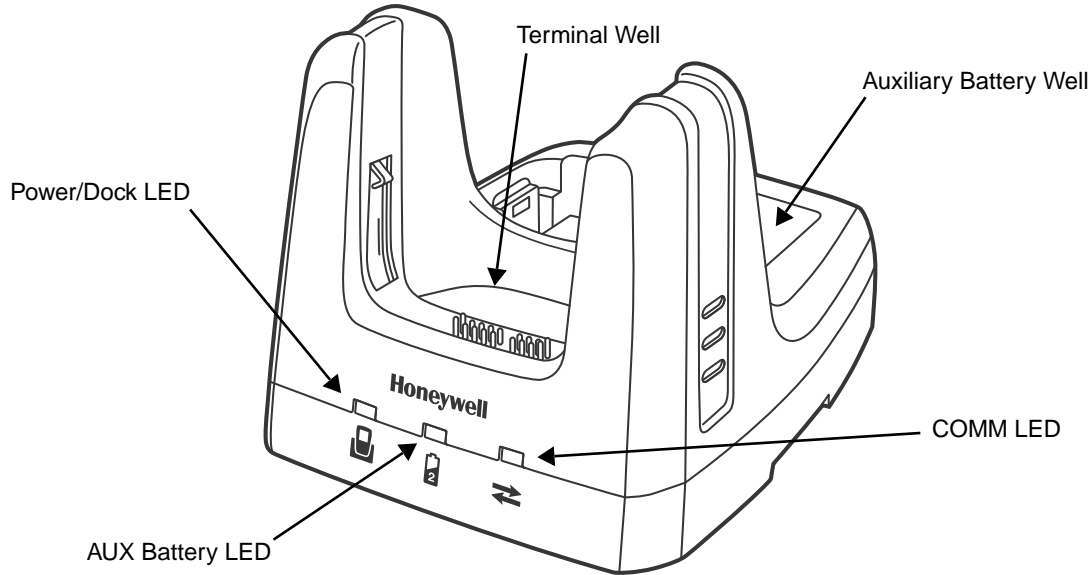

### Terminal Well

Place the terminal in this well to communicate with a host device, power the terminal, and charge the installed battery pack. The base completely charges the main battery in a Dolphin terminal in 4.5 hours for the standard 3.7V battery or 6 hours for the extended 3.7V battery. If the host device is a workstation that uses ActiveSync, synchronization begins immediately.

### Auxiliary Battery Well

See [Auxiliary Battery Well](#) on page 12-4.

### Power/Dock LED

Indicates if power is supplied to the HomeBase and if a terminal is docked properly in the base.

| This color | means... |
|------------|----------|
|------------|----------|

|     |   |
|-----|---|
| Red | The HomeBase has power but no terminal is docked. |
|-----|---|

|       |   |
|-------|---|
| Green | The HomeBase has power and the terminal is properly seated in the base. |
|-------|---|

### AUX Battery LED

Indicates status of the battery charging in the auxiliary battery well; see [Back Panel](#) on page 12-4.

| This color | means... |
|------------|----------|
|------------|----------|

|        |                                    |
|--------|------------------------------------|
| Orange | The auxiliary battery is charging. |
|--------|------------------------------------|

|       |  |
|-------|--|
| Green | The auxiliary battery has completed charging and is ready for use. |
|-------|--|



# Preliminary Draft 1/19/11

---

**Red, Flashing** The internal temperature of the auxiliary battery is too hot or there is a battery error. Charge the auxiliary battery in a cooler environment or replace the battery with a new Honeywell Li-ion or Li-poly battery.

For information about charging a battery in the auxiliary battery well, see page 12-6.

## **COMM LED**

This is the communication LED. It indicates the status of data transfer between the Dolphin terminal and the host device. The color of this LED differs if the base is using the serial or USB port connection.

### **If using the serial port**

**This color**      **means...**

**Red**              Serial data is being sent from the host device to the base.

**Green**           Serial data is being sent from the base to the host device.

**Orange**          Serial data is being sent in both directions at the same time.

### **If using the USB port**

**This color**      **means...**

**Green**           A USB Connection is established with the host workstation.

# Preliminary Draft 1/19/11

---

## Back Panel

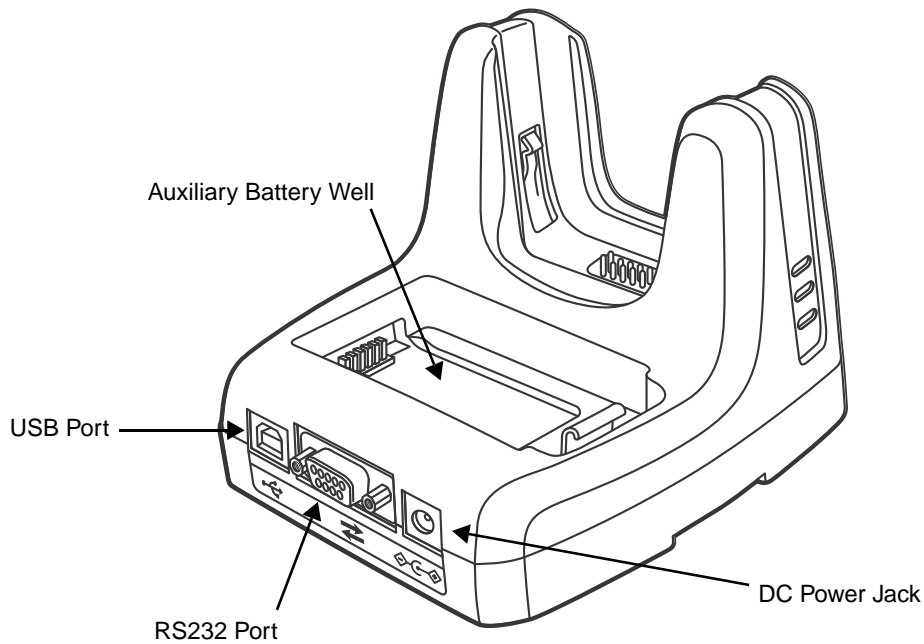

### Auxiliary Battery Well

The base enables you to charge an additional battery pack independently of the terminal well in 4.5 hours for the standard 3.7V battery or 6 hours for the extended 3.7V battery. This feature ensures that you can always have a fully-charged battery for your terminal. See [Charging a Spare Battery in the Auxiliary Battery Well](#) on page 12-6.

### USB Port

This USB port is USB v2.0 high-speed compliant. Using a USB cable, you can connect the base to a host device, such as a workstation. USB communication occurs through Microsoft ActiveSync (v4.5 or higher) or Microsoft Windows Mobile Device Center (WMDC) depending on the host workstation's operating system. When the terminal is seated in the terminal well, it is connected to the host device via the base.

*Note:* ActiveSync on your Dolphin terminal works with Windows Mobile Device Center on host workstations running Windows Vista or Windows 7 and with ActiveSync on host workstations running Windows XP. For detailed information on ActiveSync and WMDC visit Microsoft's Windows Mobile Web site.

### RS232 Port

Use the 9-pin, RS232 cable from Honeywell to connect this port to a peripheral device for RS232 data communication. For more information, see [Serial Connector](#) on page 12-5.

### DC Power Jack

Use the power cable from Honeywell that comes with the base to supply power to this power jack. For more information, see [Power](#) section that follows.

# Preliminary Draft 1/19/11

---

## **Power**

The base requires 12 Volts DC input for communications, battery charging, and power output to the terminal; the power adapter included with the base converts the voltage from the AC power source to 12 Volts DC. Use only the Honeywell 12VDC, 3A power supply provided with the base. The operating temperature range is -10° to 45°C (14° to 113°F).

Honeywell recommends that you leave the base connected to its power source at all times, so that it is always ready to use.

1. Connect the power cable to the DC jack on the rear panel of the base.
2. Connect the power cable to the power adapter.
3. Plug the power adapter cable into the power source. The base is now powered.

## **Serial Connector**

The following diagram displays the pin diagram of the serial connector of the base.

| Pin | Description              |
|-----|--------------------------|
| 1   | Internal Jumper to Pin 6 |
| 2   | TXD                      |
| 3   | RXD                      |
| 4   | No Connect               |
| 5   | GND                      |
| 6   | DTR                      |
| 7   | CTS                      |
| 8   | RTS                      |
| 9   | RI                       |

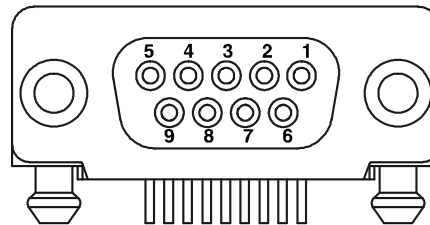

*Note: The signal names are referenced to the terminal. The terminal is a DCE RS232 device. Refer to section, RS232 Communications Cables and RS232 Pin Configuration for more details. The base is at a right-angle to the printed circuit board (PCB). The ninth pin has a ring indicator (RI).*

# Preliminary Draft 1/19/11

---

## Charging the Main Battery

The base powers the terminal and fully charges its main battery pack in 4.5 hours for the standard 3.7V battery or 6 hours for the extended 3.7V battery.

The terminal contains an intelligent battery charging system that protects the battery from being damaged by overcharging. The unit senses when a battery pack is fully charged and automatically switches to a trickle charge that maintains the battery at full capacity. Therefore, terminals may be stored in the base without damage to the terminals, battery packs, or peripherals.

To check battery power, use the Power system setting; see [Power](#) on page 7-16.

For more information about Honeywell Li-ion batteries, see [Batteries](#) on page 3-13.

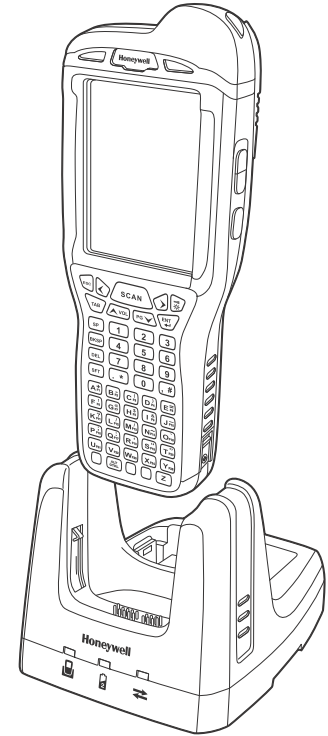

## To Power a Terminal and Charge its Main Battery

1. Install the battery pack in the terminal; see [Install the Main Battery Pack](#) on page 2-1.
2. Connect the base to the power supply provided by Honeywell.
3. Slide the terminal into the terminal well until the Dock LED lights green to indicate that the terminal is properly seated. The battery pack begins charging.



*Make sure the terminal is dry before placing it in the base. Do NOT place a wet terminal in the base! Doing so may cause damage not covered by the warranty.*



*We recommend use of Honeywell Li-ion or Li-poly battery packs. Use of any non-Honeywell battery may result in damage not covered by the warranty.*

## Charging a Spare Battery in the Auxiliary Battery Well

The auxiliary battery well located on the back of the base charges a spare battery independently of the terminal well. The Aux Battery LED on the front panel indicates the status of the battery in this well.

Charge time is 4.5 hours for the standard battery pack or 6 hours for the extended battery pack; see [Auxiliary Battery Well](#) on page 12-4.

1. Insert the battery at an angle so the battery pack contacts and the auxiliary well contacts align.
2. Snap the battery into place with a hinging motion. The Aux Battery LED lights orange.
3. Use the AUX Battery LED to monitor the charging progress. The LED lights green when the auxiliary battery has completed charging and is ready for use.

*Note: If the AUX Battery LED flashes red, the internal temperature of the battery is too hot or there is a battery error. Charge the auxiliary battery in a cooler environment or replace the battery with a new Honeywell Li-ion or Li-poly battery.*

# Preliminary Draft 1/19/11

---

## ***Communication***

### **USB**

Dolphin terminals support USB communications out of the box.

The base also supports USB communications via the USB port located on the back. The base acts as a USB device by interfacing the USB signals of the Dolphin terminal to the USB of the host workstation. Using a standard USB cable, the base's USB interface allows the Dolphin terminal to communicate with a workstation.

### **RS232**

The base supports RS232 communications via the RS232 Communications Port located on the back of the device. This port enables the Dolphin terminal to communicate to a workstation, modem, or any RS232 device using a standard serial cable and communications software.

## ***Requirements***

- A base powered by a power cable and power adapter cable
- For RS232 communications, a serial cable
- For USB communications, a USB cable
- A work station running Windows 98 Second Edition, Windows Me, Windows 2000, Windows NT (4.0 SP6 or higher), Windows XP, Windows Vista, or Windows 7.
- ActiveSync (v4.5 or above) or Widows Mobile Device Center on the workstation

## ***Connecting the Communication Cables***

1. Plug in the power supply and connect it to the back of the base.
2. Plug the USB or the RS232 communication cable into the back of the base.
3. Connect the communication cable into the back of the workstation.
4. At this point, the hardware is installed and operating. You may need to reboot your workstation to complete the installation process.

## ***Establishing Communication***

USB or RS232 communication with the terminal is usually auto-detected and configured by ActiveSync or Windows Mobile Device Center based on the communication cable connected. If you are using a USB cable to connect to the workstation, the sync software sets up a USB connection. If you are using an RS232 cable, the sync software sets up an RS232 connection.

For more information, see [Communication](#) on page 12-7.

## ***Communicating with the Dolphin Terminal***

To initiate communications between the Dolphin terminal and peripheral, complete these steps:

1. Insert the Dolphin terminal into the terminal well of the base.
  - The DOCK LED illuminates green. If the DOCK LED does not illuminate, make sure that the terminal is properly seated. You may need to remove and re-insert the terminal.
  - The Dolphin terminal activates; if the power is off, the terminal automatically powers on. If the terminal does not power on, verify that the Honeywell power supply is properly connected to the cradle and plugged into a functioning outlet.

# Preliminary Draft 1/19/11

---

- If the base is connected to the workstation, the Dolphin terminal automatically opens ActiveSync or the Windows Mobile Device Center to establish a connection.
2. The base can now transfer data between the terminal and the host device. If communication does not occur, check the port connections to ensure that the cradle is correctly configured.

## **Verifying Communication**

You can verify that the USB driver is functioning by watching the COMM LED on the USB base. When the COMM LED illuminates solid green, the base is communicating with the host device.

## **Verifying Data Transfer**

The COMM LED flashes when data is being transferred via the base. For an RS232 connection, the COMM LED flashes red and green. For a USB connection, the COMM LED does not flash during data transfer.

## **RS232 Communications Cables**

Connect the base to the host workstation or other device by plugging an RS232 serial cable into the RS232 Communications Port on the rear of the base. The wiring of your cable depends on whether the other device is set up as a Data Communications Equipment (DCE) or Data Terminal Equipment (DTE) device.

The Communication Port is configured as a DCE device. To communicate with a DCE device, use either a null modem adapter in line with a standard RS232 cable, or a null-modem serial cable. To communicate with a DTE device such as a workstation, use a standard (or straight-through) RS232 cable.

You can make your own cables by following the pin configuration in the chart that follows. To do so, you must determine if your host RS232 device is 9-pin or 25-pin, and whether it is configured as a DCE or DTE device.

## **RS232 Pin Configuration**

| Base /Host Port (DCE)     | IBM AT DB9 (DTE) | IBM XT DB25 (DTE) | Modem DB25 (DCE) |
|---------------------------|------------------|-------------------|------------------|
| <b>Pin / Input Signal</b> |                  |                   |                  |
| <b>2 / (RD)</b>           | 2                | 3                 | 2                |
| <b>3 / (TD)</b>           | 3                | 2                 | 3                |
| <b>5 / (SG)</b>           | 5                | 7                 | 7                |
| <b>4 / (DTR)</b>          | 4                | 20                | 6                |
| <b>6 / (DSR)</b>          | 6                | 6                 | 20               |
| <b>7 / (RTS)</b>          | 7                | 4                 | 5                |
| <b>8 / (CTS)</b>          | 8                | 5                 | 4                |

*Note: This base cannot be daisy-chained.*

*Note: The input signal names are referenced to the DTE target device (ie. workstation or host computer) in accordance with the RS232 standard.*

# Preliminary Draft 1/19/11

---

## ***Mounting***

Set the base on a dry, stable surface, such as a desktop or workbench near an electrical outlet. Be sure to provide enough workspace with good lighting for the user to view and operate the Dolphin terminal while it is in the base.

When choosing a mounting location, bear in mind that the location must allow users' easy access to the Auxiliary Battery Well and the back panel of the HomeBase where the serial port, USB port, and the power jack are located.

## **Installation Hardware**

**Screw:** 3/16 in. dia x 5/8 in. long pan head screw

**Washer:** 1/2 in. OD x 7/32 in. ID x 3/64 in. thick

**Nut:** 3/16 in. dia

## ***Desk Mounting***

The DIN rail slot (7.5 X 35 mm) may be mounted on the bottom to allow for secure desk attachment of the unit if desired.

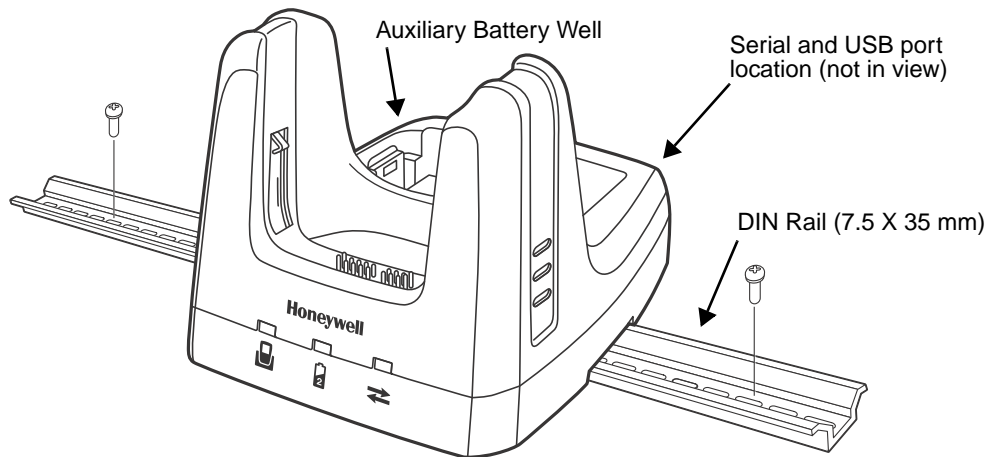

Slide the DIN rail slot along the bottom panel.

Then, using the appropriate nuts and bolts, secure the DIN rail to the desk or flat surface.

# Preliminary Draft 1/19/11

---



# Preliminary Draft 1/19/11

## Dolphin 99EX eBase Device

### Overview

The Ethernet Base (eBase) enables a single Dolphin 99EX computer to communicate with a host device over an Ethernet network.



*We recommend use of Honeywell peripherals, power cables, and power adapters. Use of any non-Honeywell peripherals, cables, or power adapters may cause damage not covered by the warranty.*

### Unpacking the eBase

Open the shipping box and inspect the package to see that the following standard items are included:

- One Dolphin eBase Ethernet cradle
- One universal AC/DC power adapter for the Dolphin eBase
- One power cord

You will also need to provide a standard CAT-5 Ethernet network cable. These items are needed to set up and operate the eBase. If any items are missing or anything appears to be damaged, contact your Customer Account Representative.

Keep the original packaging in case you need to return the eBase for service or to store the eBase while not in use.

### Charge Time

The base completes a full charge of the main battery pack installed in the terminal seated in the terminal well in 4.5 hours for the standard 3.7V battery or 6 hours for the extended 3.7V battery. The base completes a full charge of the battery pack in the [Auxiliary Battery Well](#) (see page 13-2) in 4.5 hours for the standard 3.7V battery or 6 hours for the extended 3.7V battery.

### Convenient Storage

The intelligent battery charging system makes this base a safe and convenient storage receptacle for your Dolphin terminal.

### Capacity

The base holds one terminal and features an auxiliary battery well behind the terminal well that can charge a battery pack independently of the terminal well. This means that one base can charge two battery packs: the one installed in the terminal and a spare.



*We recommend use of Honeywell Li-ion or Li-poly battery packs. Use of any non-Honeywell battery may result in damage not covered by the warranty.*



*We recommend use of Honeywell peripherals, power cables, and power adapters. Use of any non-Honeywell peripherals, cables, or power adapters may cause damage not covered by the warranty.*

# Preliminary Draft 1/19/11

## Parts and Functions

### Front Panel

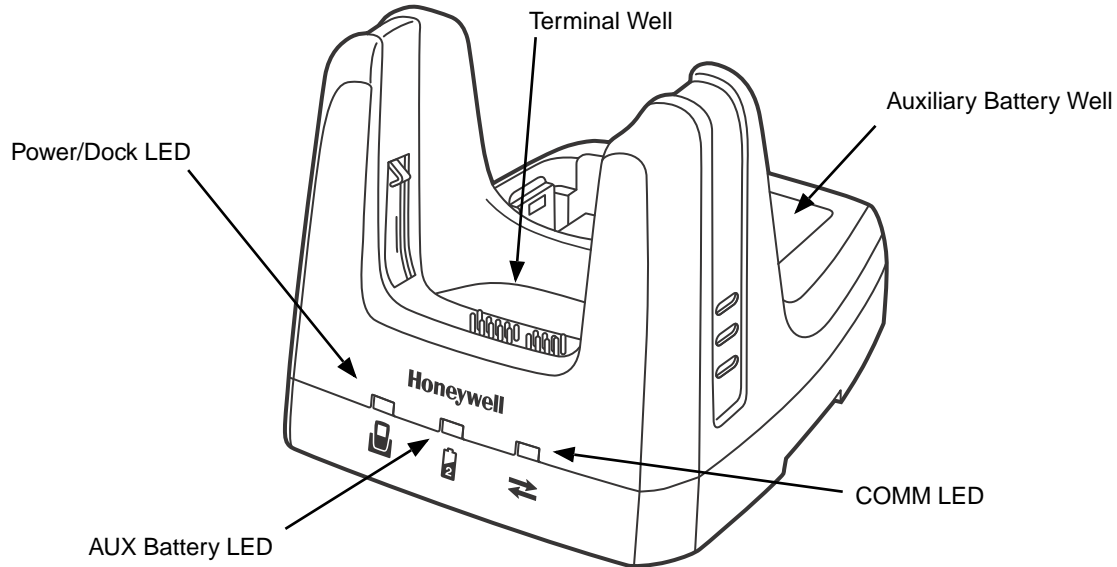

### Terminal Well

Place the terminal in this well to communicate with a host device, power the terminal, and charge the installed battery pack. The eBase completely charges the main battery in a Dolphin terminal in 4.5 hours for the standard 3.7V battery or 6 hours for the extended 3.7 battery.

### Auxiliary Battery Well

See [Auxiliary Battery Well](#) on page 13-4.

### Power/DOCK LED

Indicates if power is supplied to the eBase and if a terminal is docked properly in the base.

| This color | means... |
|------------|----------|
|------------|----------|

|     |  |
|-----|--|
| Red | The eBase has power but no terminal is docked. |
|-----|--|

|       |  |
|-------|--|
| Green | The eBase has power and the terminal is properly seated in the base. |
|-------|--|

### AUX Battery LED

The AUX Battery LED indicates the status of the battery charging in the auxiliary battery well; see [Back Panel](#) on page 13-4.

| This color | means... |
|------------|----------|
|------------|----------|

|        |                                    |
|--------|------------------------------------|
| Orange | The auxiliary battery is charging. |
|--------|------------------------------------|

|       |  |
|-------|--|
| Green | The auxiliary battery has completed charging and is ready for use. |
|-------|--|

# Preliminary Draft 1/19/11

---

**Red Flashing** The internal temperature of the auxiliary battery is too hot or there is a battery error. Charge the auxiliary battery in a cooler environment or replace the battery with a Honeywell Li-ion or Li-poly battery.

## **COMM LED** ⇔

The COMM LED indicates the status of data transfer between the Dolphin terminal and the eBase.

### **Ethernet Communication**

When the Dolphin terminal is docked:

| <b>This color</b> | <b>and status</b> | <b>means...</b>  |
|-------------------|-------------------|--|
| Green             | Solid             | A connection has been established between the Dolphin terminal and the Ethernet. |
| Green             | Flashing          | Data transfer in progress.   |

### **USB Communication**

When the Dolphin terminal is docked:

| <b>This color</b> | <b>and status</b> | <b>means...</b>  |
|-------------------|-------------------|--|
| Red               | Solid             | A USB connection has been established between the Dolphin terminal and the host workstation. |

# Preliminary Draft 1/19/11

---

## Back Panel

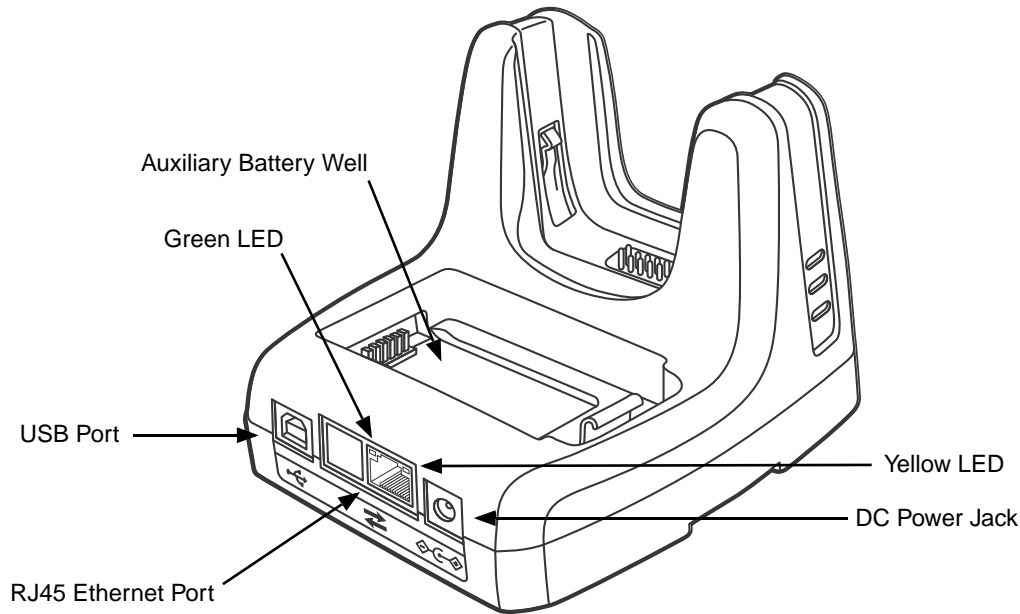

### Auxiliary Battery Well

The eBase enables you to charge an additional battery pack independently of the terminal well in 4.5 hours for the standard 3.7V battery or 6 hours for the extended 3.7V battery. This feature ensures that you can always have a fully charged battery for your terminal.

### USB Port

This USB port is USB v2.0 high-speed compliant. Using a USB cable, you can connect the eBase to a USB compliant device to facilitate USB communication to and from the terminal. USB communication occurs through Microsoft ActiveSync (v4.5 or higher) or Microsoft Windows Mobile Device Center depending on the host workstation's operating system. When the terminal is seated in the terminal well, it is connected to the peripheral device via the eBase.

*Note: ActiveSync on your Dolphin terminal works with Windows Mobile Device Center on host workstations running Windows Vista or Windows 7 and with ActiveSync on host workstations running Windows XP. For detailed information on ActiveSync and Windows Mobile Device Center visit [Microsoft's Windows Mobile Web site](#).*

### RJ45 Ethernet Port

Use a standard CAT-5 Ethernet cable; you can connect the ebase to an Ethernet-compliant device to facilitate Ethernet communication to and from the terminal.

| This color | and status | means...   |
|------------|------------|--|
| Green      | Flashing   | Data transfer in progress.   |
|            | Solid      | A connection has been established between the Dolphin terminal and the Ethernet. |
| Yellow     | Solid      | Ethernet is connected at 100T.   |
|            | Off        | Ethernet is connected at 10T.  |

# Preliminary Draft 1/19/11

---

## DC Power Jack

Use the power cable from Honeywell that comes with the ebase to supply power to this power jack. For more information, see [Power](#) on page 13-5.

## Bottom Panel

For details on how to mount the eBase, see [Mounting](#) on page 13-8.

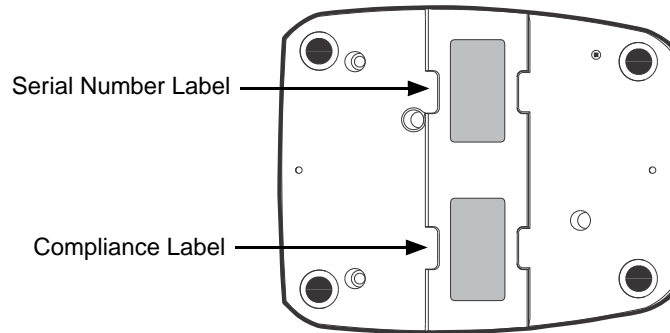

## Power

The terminal requires 12 Volts DC input for communications and battery charging; the power adapter on the power cable converts the voltage from the power source to 12 Volts DC. **Only** the Honeywell 12VDC, 3A power supply provided with the ebase converts the voltage appropriately. The operating temperature range is -10° to 45°C (14° to 113°F).

Honeywell recommends that you leave the eBase connected to its power source at all times, so that it is always ready to use.

 *We recommend use of Honeywell peripherals, power cables, and power adapters. Use of any non-Honeywell peripherals, cables, or power adapters may cause damage not covered by the warranty.*

## Connecting Power to the eBase

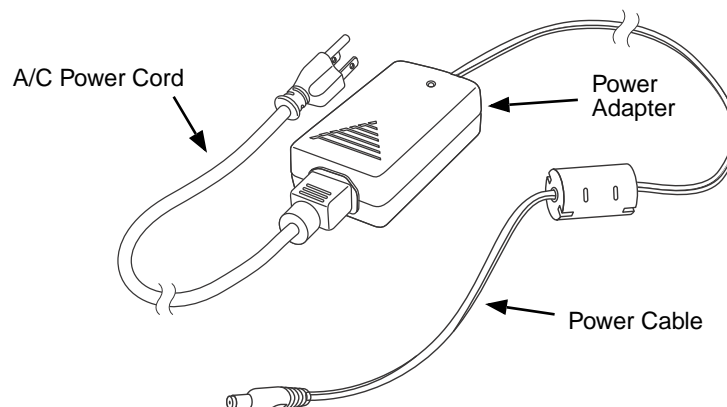

1. Plug the A/C power cord into the power adapter.
2. Plug the power cable into the power connector on the back of the eBase.

# Preliminary Draft 1/19/11

---

3. Plug the A/C power cord into a standard wall outlet. The Power/Dock LED on the eBase illuminates solid red to indicate the eBase has power and no terminal is docked.

## **Charging the Main Battery**

The eBase provides power to the Dolphin terminal and allows the charging of the terminal's main battery. The intelligent battery charging system incorporated into all Dolphin terminals prevents overcharging, which means that Dolphin terminals may be stored in the eBase indefinitely without damage to the terminals, battery packs, or the eBase.

To check battery power, use the Power system setting; see [Power](#) on page 7-16.

For more information about Honeywell Li-ion batteries, see [Batteries](#) on page 3-13.

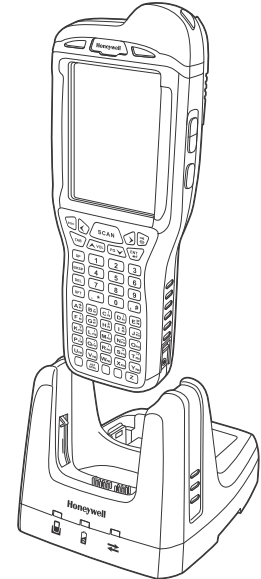

## **To Power a Terminal and Charge its Main Battery**

1. Install the battery pack in the terminal; see [Install the Main Battery Pack](#) on page 2-1.
2. Verify the base has power. If the Power/Dock LED is not illuminated, see [Connecting Power to the eBase](#) on page 13-5.
3. Slide the terminal into the terminal well. The Power/Dock LED changes to green. Battery charging begins immediately if required by the Dolphin terminal.

 *Make sure the terminal is dry before placing it in the eBase. Do NOT place a wet terminal in the eBase! Doing so may cause damage not covered by the warranty.*

 *We recommend use of Honeywell Li-Ion or Li-poly battery packs. Use of any non-Honeywell battery may result in damage not covered by the warranty.*

## **Charging a Spare Battery in the Auxiliary Battery Well**

The auxiliary battery well located on the back of the base charges a spare battery independently of the terminal well. The Aux Battery LED on the front panel indicates the status of the battery in this well.

Charge time is 4.5 hours for the standard battery pack or 6 hours for the extended battery pack; see [Auxiliary Battery Well](#) on page 13-4.

1. Insert the battery at an angle so the battery pack contacts and the auxiliary well contacts align.
2. Snap the battery into place with a hinging motion. The Aux Battery LED lights orange.
3. Use the AUX Battery LED to monitor the charging progress. The LED lights green when the auxiliary battery has completed charging and is ready for use.

*Note: If the AUX Battery LED flashes red, the internal temperature of the battery is too hot or there is a battery error. Charge the auxiliary battery in a cooler environment or replace the battery with a new Honeywell Li-ion or Li-poly battery.*

# Preliminary Draft 1/19/11

---

## Communication

### Software Requirements

Before you connect the Dolphin terminal to the eBase, make sure you have the most current software installed. To check the terminal's system information, tap  > **Power Tools** > **SysInfo**.

- The Kernel version must be 26.01 or later in terminals running Windows Embedded Handheld 6.5 Classic.
- In terminals running Windows Embedded Handheld 6.5 Professional, the kernel version must be 25.01 or later.



### Applications on the Dolphin Terminal

Applications running on the Dolphin terminal when it is connected to the eBase should be designed specifically for a partially connected network. For more details, please refer to the *Best Practices for Partially Connected Networks* document available at [www.honeywellaidc.com](http://www.honeywellaidc.com).

## Establishing Ethernet Communication

### Connecting the Dolphin Terminal to the eBase

By default, the Dolphin terminal is configured to obtain IP addresses automatically via DHCP server. This means that in most cases you would simply plug-and-play the unit.

1. Verify the base has power. If the Power/Dock LED is not illuminated, see [Connecting Power to the eBase](#) on page 13-5.
2. Plug the CAT-5 Ethernet cable into the RJ45 connector on the back of the eBase.
3. Plug the Ethernet cable into the network.
4. Insert the Dolphin into the terminal well. The DOCK LED for the well changes from red to green and the connection icon on the Dolphin's title bar changes from  to .

*Note: Instead of using the default for DHCP assigned IP addresses, the Dolphin terminal can use a statically assigned IP address. See standard Microsoft Windows Mobile documentation for how to assign a static IP address to a network adapter. In this case, set a static IP address for the adapter named "SMSC9500 USB2.0 FAST Ethernet Drive".*

### Displaying the eBase and Terminal IP Address

Once the Dolphin terminal has been successfully connected to the eBase, the terminal uses the eBase IP address. This IP address can be used by any application on the Dolphin terminal.

1. Tap  > **Power Tools** > **Network Utilities** > **IPConfig**.
2. Change a **Adapter** to SMC9500.
3. On the Input tab, tap the **Display full configuration** button.
4. The Dolphin terminal retrieves and displays the IP configuration for the entire terminal and eBase. Locate the **IpAddress** field in the IP configuration list.



# Preliminary Draft 1/19/11

---

## **Establishing USB Communication**

Dolphin terminal's support USB communication out of the box. The eBase also supports USB communications using the USB port located on the back panel of the eBase. The eBase acts as a USB device by interfacing the USB signals of the Dolphin terminal to the USB of the host workstation. Using a standard USB cable, the ebase's USB interface allows the Dolphin terminal to communicate with a host workstation.

### *Setting Up and Connecting the Dolphin Terminal to the eBase*

1. Verify the base has power. If the Power/Dock LED is not illuminated, see [Connecting Power to the eBase](#) on page 13-5.
2. Plug the USB communication cable into the USB port on the back of the eBase.  
*Note: The Dolphin terminal should always be removed from the eBase when connecting or disconnecting the USB cable.*
3. Connect the other end of the USB cable to the host workstation.
4. Insert the Dolphin terminal in the eBase terminal well. The Power/Dock LED changes to green and the COMM LED illuminates red.
5. The Dolphin terminal activates and automatically opens ActiveSync to establish a connection.
6. The connection icon in the Dolphin's navigation bar changes from  to  it indicates a successful connection. The eBase can now transfer data between the terminal and the host device.

## **Mounting**

Set the eBase on a dry, stable surface, such as a desktop or workbench near an electrical outlet. Be sure to provide enough workspace with good lighting for the user to view and operate the Dolphin terminal while it is in the eBase.

When choosing a location, bear in mind that:

- the mounting location must allow users easy access to the Auxiliary Battery Well, and
- the Ethernet and USB ports as well as the power jack face straight out of the rear panel, and you will most likely want easy access to them in the future.

## **Using the DIN Rail**

### **Installation Hardware**

- Screw:** 3/16 in. dia x 5/8 in. long pan head screw  
**Washer:** 1/2 in. OD x 7/32 in. ID x 3/64 in. thick  
**Nut:** 3/16 in. dia

The DIN rail slot (7.5 X 35 mm) may be mounted on the bottom to allow for secure desk attachment of the unit if desired.

1. Slide the DIN rail slot along the bottom panel.
2. Then, using the appropriate nuts and bolts, secure the DIN rail to the desk or flat surface.

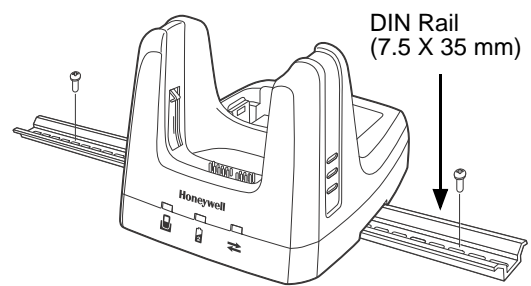



# Preliminary Draft 1/19/11

## *Dolphin 99EX Mobile Base Device*

### **Overview**

This charging and communication cradle is designed specifically for in-premise and in-transit data collection applications. It features a flexible mounting bracket and a cigarette lighter adapter to adapt it to your environment.

The serial connector supports RS232 communication and power out to peripheral devices, such as handheld scanners. The USB connector supports USB communication and power to peripheral devices such as a memory stick or printer.

As the hub of your Dolphin mobile data collection system, the base performs three important functions: charging, communications, and storage.

### **Charging**

The base completes a full charge of the main battery pack in 4.5 hours for the standard 3.7V battery pack or 6 hours for the extended 3.7V battery pack. The base also provides power to the intelligent battery charging system in all terminals that senses when a full charge has been achieved and switches to a trickle charge to maintain the full charge.

### **Communications**

The base supports both RS232 and USB communications. Through the RS232 serial port, you can transmit reliable data communications at speeds of up to 115K baud. By using the high-speed USB (v2.0) port, the data transmission rate goes up to 480 Mbps.

### **Convenient Storage**

Intelligent battery charging makes the base a safe and convenient storage receptacle for your Dolphin terminal.



*We recommend use of Honeywell Li-Ion or Li-poly battery packs. Use of any non-Honeywell battery may result in damage not covered by the warranty.*



*We recommend use of Honeywell peripherals, power cables, and power adapters. Use of any non-Honeywell peripherals, cables, or power adapters may cause damage not covered by the warranty.*

# Preliminary Draft 1/19/11

---

## Front Panel

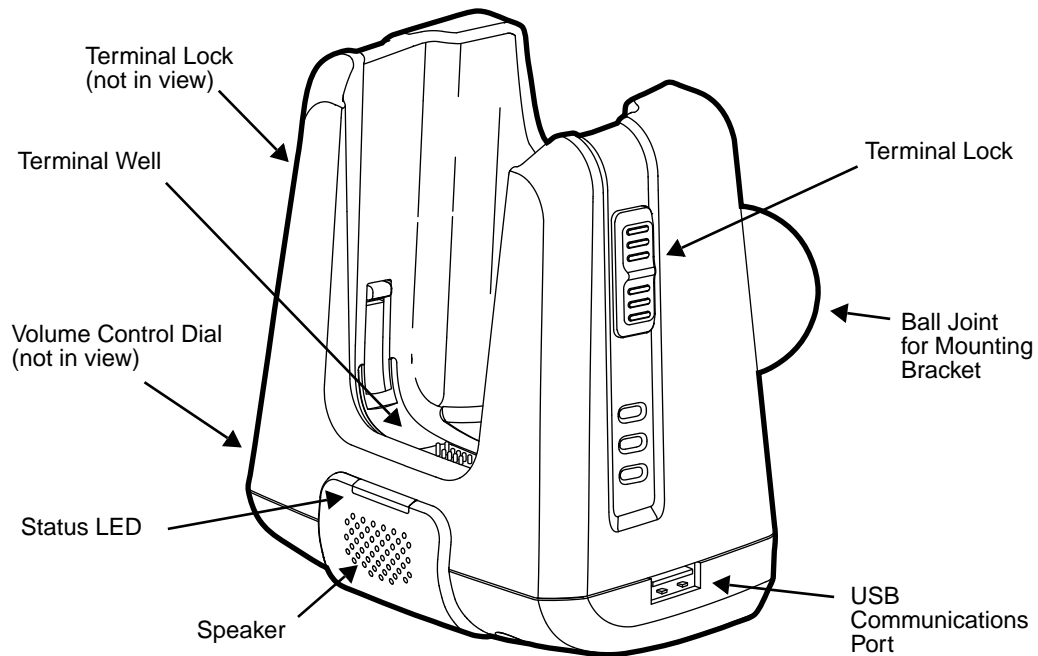

## Mounting Bracket

Used to mount the base to a fixed location.

## Speaker

Amplifies the Dolphin's audio signals.

## Status LED

Illuminates solid green when the Dolphin terminal is properly seated in the terminal well.

## Terminal Locks

The mobile base has a locking switch on the left and right side. Pushing one of the switches up locks the terminal in the base. To unlock the terminal push either switch down.

## Terminal Well

Place the terminal in this well. Once seated, the terminal can communicate with a host device and its main battery pack begins charging.

## USB Communications Port

This USB Port is host high-speed 2.0v compliant. You can connect the base to a peripheral device, such as a memory stick or to a printer using a USB cable. When the terminal is seated in the terminal well, it is connected to the peripheral device via the base.

## Volume Control Dial

The speaker volume is adjusted via the dial located on the side of the base.

# Preliminary Draft 1/19/11

---

## **Bottom Panel**

The power supply and RS232 connectors are located on the bottom of the unit.

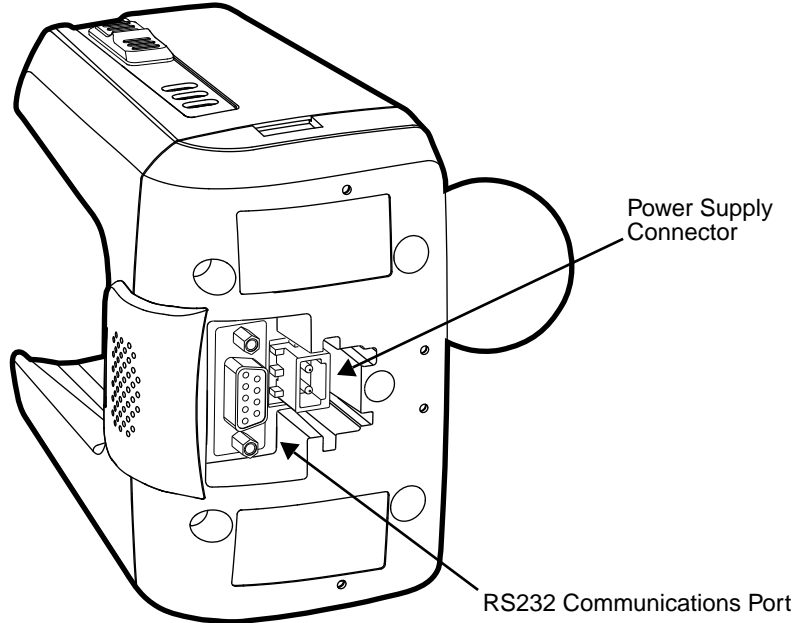

### **Power Supply Connector**

To run on vehicle power, you can use the 12 VDC cable. The appropriate cable comes with the kit you ordered. The 12 VDC cable can be used with a cigarette lighter outlet.

 *Verify that the power source is always within the specified range and observe correct input voltage polarity. An improper input voltage range or reverse polarity could damage the power conversion circuitry.*

### **RS232 Communications Port**

Use a standard serial cable to connect the unit to a host device via RS232; see [Serial Connector](#) on page 14-8.

# Preliminary Draft 1/19/11

---

## **Back Panel and Mounting Brackets**

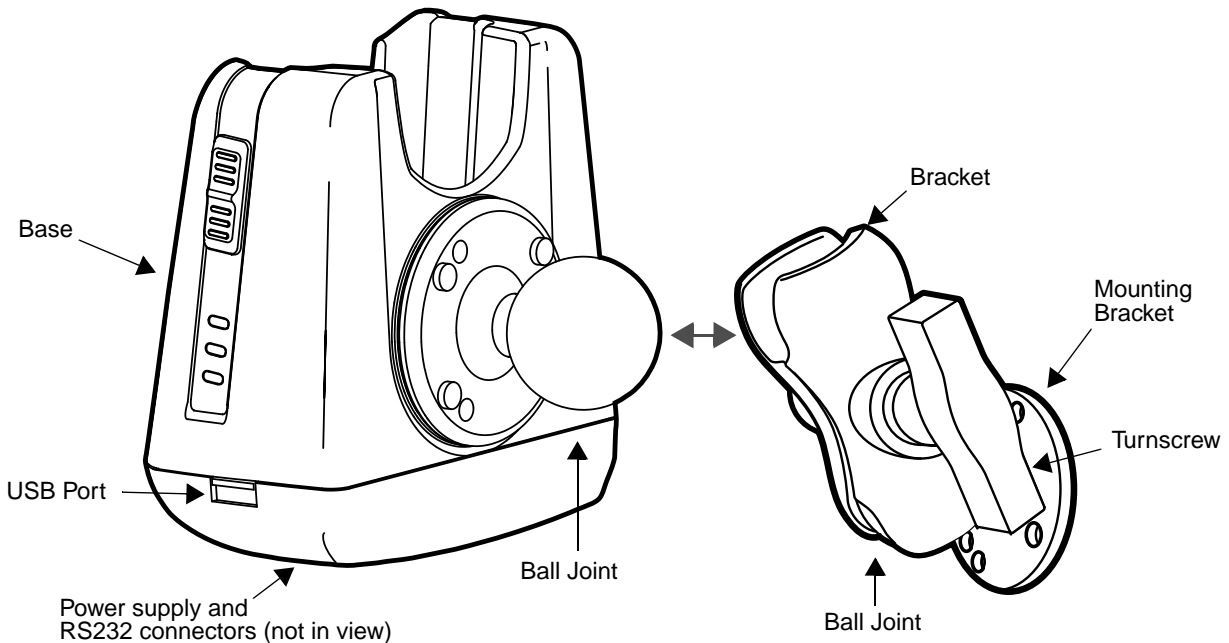

### **Ball Joints**

There are two ball joints: one on the back of the base and one on the mounting bracket. Both ball joints are inserted into the bracket and secured to mount the base.

### **Connectors**

The power and RS232 connectors are located on the bottom panel. For more information, see [Bottom Panel](#) on page 14-3.

### **Bracket**

The bracket contains the turnscrew and two slots. Ball joints are inserted into each slot and secured with the turnscrew.

### **Turnscrew**

The turnscrew is located on the top of the bracket. Rotate the turnscrew to secure or loosen the ball joint slots.

### **Mounting Bracket**

The mounting bracket is what you attach to the mounting surface. It is comprised of a ball joint and flat disk. The disk contains drill holes you use to secure the base to the mounting surface.

# Preliminary Draft 1/19/11

---







## **Mounting**

The adjustable mounting bracket holds the terminal securely in place and gives the user a variety of options for mounting the base.

## **Safety Precautions**

Honeywell is not responsible for any damages caused to you, your vehicle, or other individuals due to the installation of the Dolphin Mobile mount.

Follow these safety precautions when mounting the mobile base:

-  Never drill into a surface in your vehicle without first consulting a mobile installation professional experienced with your vehicle type to avoid damaging the vehicle's safety features, gas tank, electrical system or other sensitive vehicle components.
-  Do not install the Mobile base in an air bag deployment zone. Honeywell assumes no responsibility of liability for injury or death because of car crashes and/or air bag deployment.
-  Do not mount the base in a location where it prevents safe operation of the vehicle and/or impedes the vehicle operator's field of view.
-  Do not mount the base in a location where the connectors on the bottom panel of the base are not easily accessible. Be sure to leave enough room for unrestricted cable connections.
-  The Mobile base is intended for use in an enclosed space protected from the elements. Do not mount the Mobile base on external vehicle surfaces.
-  Select a mounting surface that is flat and smooth like the console area in the vehicle located between the seats.

## **Installation**

Mounting hardware is not included. You must provide the appropriate hardware for your particular application and vehicle type. **To ensure a safe installation, consult a mobile installation professional experienced with your vehicle type.**

1. Using the bracket as a template, mark the locations for the mounting screws.
2. Drill the appropriate size pilot holes in the mounting surface.
3. Secure the mounting bracket to the mounting surface using the appropriate screw type for your application and vehicle type.
4. Loosen the turnscrew.
5. Insert the ball joint of the mounting bracket to the back of the bracket.
6. Insert the ball joint on the back of the base into the other side of the bracket.
7. Tighten the turnscrew to secure both ball joints.

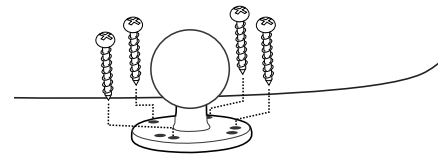

# Preliminary Draft 1/19/11

---

## ***Powering the Dolphin Terminal***

When seated in a base that is connected to the appropriate power source, the Dolphin terminal receives the power to charge its main battery and run its internal circuitry. Keep the base plugged into the power source so that the Dolphin terminal battery pack stays fully charged.

*Note: Honeywell recommends that you leave the base connected to its power source at all times.*

The base is powered via the power connector on the bottom panel; see [Bottom Panel](#) on page 14-3. Both the power and serial connectors are straight out, not at an angle. The base requires a 12 VDC power input.

## ***Charging the Dolphin Terminal***

The base supplies charging power to the Dolphin terminal so that the terminal can monitor the charging of its battery pack. This charging method protects the battery from being damaged by overcharging. Therefore, the Dolphin terminal may be stored indefinitely in the base without damage to the terminal, the battery pack, or the base.

1. Insert a battery pack into the terminal.
2. Slide the terminal, imager window up and the LCD visible, into the terminal well until it stops.
3. When the terminal is properly seated, the DOCK LED on the base illuminates solid green. The terminal begins charging automatically.

## ***Establishing Communication***

The RS232 interface allows the terminal to communicate to a workstation, modem, any standard RS232 device using a standard RS232 and communications software.

### **Requirements**

You need the following equipment:

- A Mobile Base device powered by a power adapter cable
- For RS232 communications, a serial cable
- ActiveSync v4.5 or above or Windows Mobile Device Center on the host workstation
- Windows 98 Second Edition, Windows Me, Windows 2000, Windows NT (4.0 SP6 or higher), Windows XP, Windows Vista or Windows 7 on the host workstation.

## ***Connecting the Communication Cables***

*Note: You must be using ActiveSync (4.5 or higher) or Windows Mobile Device Center.*

1. Plug in the power supply and connect it to the bottom of the base.
2. Plug the RS232 communication cable into the appropriate connector on base.
3. Connect the other end of the communication cable into the back of the workstation.
4. At this point, the hardware is installed and operating.  
You may need to reboot your workstation to complete the installation process.

# Preliminary Draft 1/19/11

---

## ***Establishing ActiveSync or Windows Mobile Device Center Communication***

The Dolphin terminal is usually auto-detected and configured by ActiveSync or Windows Mobile Device Center based on the communication cable. The synchronization software automatically sets up an RS232 connection when you are using an RS232 cable.

For more details, see [Communication](#) on page 8-8.

## ***RS232 Communication Cables***

Connect the base to the host workstation or other device by plugging an RS232 serial cable into the RS232 Communications Port on the bottom of the base. Plug the other end of the RS232 serial cable into the correct port on the host RS232 device. The wiring of your cable depends on whether the other device is set up as a Data Communications Equipment (DCE) or Data Terminal Equipment (DTE) device.

The Communication Port is configured as a DCE device. To communicate with a DTE device such as a workstation, use a standard (or straight-through) RS232 cable. To communicate with a DCE device, use either a null modem adapter in line with a standard RS232 cable, or a null-modem serial cable.

You can make your own cables by following the pin configuration in the chart that follows. To do so, you must determine if your host RS232 device is 9-pin or 25-pin, and whether it is configured as a DCE or DTE device.

## ***RS232 Pin Configuration***

| <b>Base/Host Port (DCE)</b> | <b>IBM AT DB9 (DTE)</b> | <b>IBM XT DB25 (DTE)</b> | <b>Modem DB25 (DCE)</b> |
|-----------------------------|-------------------------|--------------------------|-------------------------|
| <b>Pin / Input Signal</b>   |                         |                          |                         |
| <b>2 / (RD)</b>             | 2                       | 3                        | 2                       |
| <b>3 / (TD)</b>             | 3                       | 2                        | 3                       |
| <b>5 / (SG)</b>             | 5                       | 7                        | 7                       |
| <b>4 / (DTR)</b>            | 4                       | 20                       | 6                       |
| <b>6 / (DSR)</b>            | 6                       | 6                        | 20                      |
| <b>7 / (RTS)</b>            | 7                       | 4                        | 5                       |
| <b>8 / (CTS)</b>            | 8                       | 5                        | 4                       |

*Note: The input signal names are reference to the DTE target device (i.e., workstation or host computer) in accordance with the RS232 standard.*

# Preliminary Draft 1/19/11

---

## **Serial Connector**

The base connector is straight to the printed circuit board (PCB). This can power a peripheral device, such as a mobile printer.

| Pin | Description              |
|-----|--------------------------|
| 1   | Internal Jumper to Pin 6 |
| 2   | TXD                      |
| 3   | RXD                      |
| 4   | DSR                      |
| 5   | GND                      |
| 6   | DTR                      |
| 7   | CTS                      |
| 8   | RTS                      |
| 9   | 5 Volt Out               |

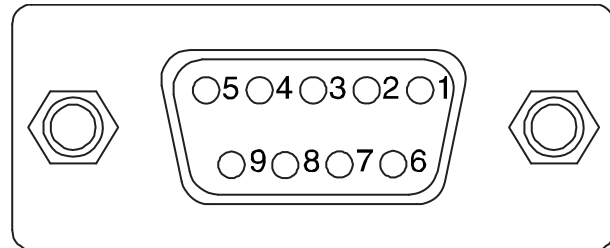

*Signals referenced are for a DTE device.*



# Preliminary Draft 1/19/11

## *Dolphin 99EX ChargeBase Device*

### **Overview**

This 4-slot charging cradle that can power 4 Dolphin terminals, and charge their main batteries in 4.5 hours for the standard 3.7V battery or 6 hours for the extended 3.7V battery.

### **Charging**

The base supplies power to the intelligent battery charging system in all Dolphin terminals, which senses when a full charge has been achieved and switches to a trickle charge to maintain the full charge.

As battery packs charge, the charging circuitry follows the two-step charging process (CC-CV) that is recommended for Li-ion or Li-poly batteries. The process monitors changes in temperature, current, and voltage. The main battery of each terminal charges in 4.5 hours for the standard 3.7V battery or 6 hours for the extended 3.7V battery.

### **Convenient Storage**

Intelligent battery charging makes this base a safe and convenient storage receptacle for your Dolphin terminal.

### **Capacity**

The base can hold up to 4 Dolphin terminals. Each charging well charges each terminal independently of the other wells.



*We recommend use of Honeywell Li-Ion or Li-poly battery packs. Use of any non-Honeywell battery may result in damage not covered by the warranty.*



*We recommend use of Honeywell peripherals, power cables, and power adapters. Use of any non-Honeywell peripherals, cables, or power adapters may cause damage not covered by the warranty.*

# Preliminary Draft 1/19/11

---

## Parts and Functions

### Front Panel

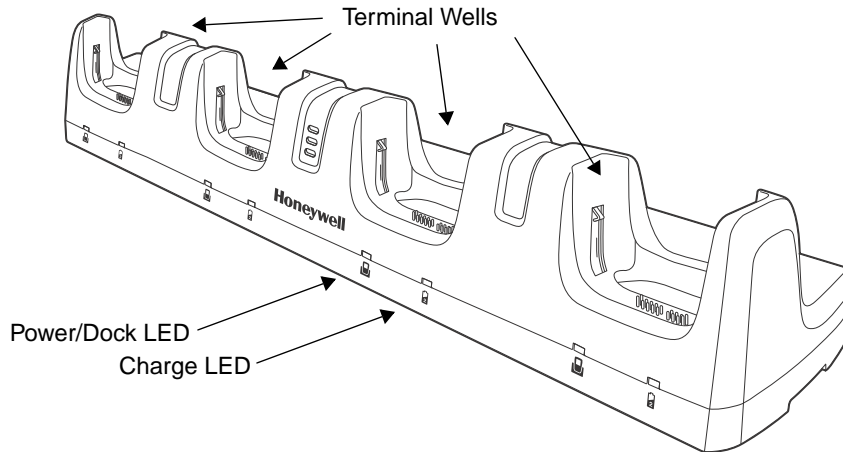

### Terminal Wells

The base contains four terminal wells. Each well has its own dedicated Power/Docking LED and Charging LED indicator.

### Power/Dock LEDs

The Power/Dock LED indicates if the ChargeBase has power and if the terminal is properly seated in the terminal well. Each terminal well has its own dedicated Power/Dock LED.

| This color | means... |
|------------|----------|
|------------|----------|

|     |   |
|-----|---|
| Red | The ChargeBase has power but no terminal is docked. |
|-----|---|

|       |   |
|-------|---|
| Green | The ChargeBase has power and the terminal is properly seated in the well facilitating communication between the base and terminal |
|-------|---|

### Charge LEDs

Each terminal well displays a Charge LED on the front that lights green to indicate charging. For details, see [Charging the Main Battery](#) on page 15-4.

# Preliminary Draft 1/19/11

## Back Panel

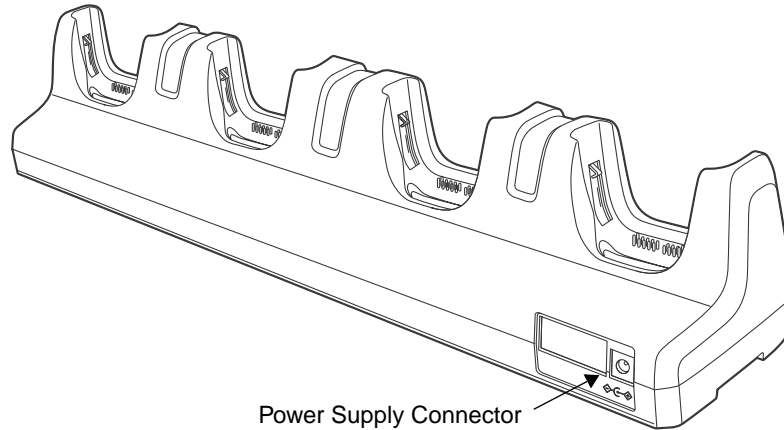

## Power Supply Connector

This connector receives input from the power adapter. Plug the power connector cable from the power adapter into this connector.

## Power

The terminal requires 12 Volts DC input for battery charging; the power adapter on the power cable converts the voltage from the power source to 12 volts DC. **Only** the Honeywell 12V/8.5A power supply provided with the Net Base converts the voltage appropriately. The operating temperature range is -10° to 45°C (14° to 113°F).

Honeywell recommends that you leave the ChargeBase connected to its power source at all times, so that it is always ready to use.

 We recommend use of Honeywell peripherals, power cables, and power adapters. Use of any non-Honeywell peripherals, cables, or power adapters may cause damage not covered by the warranty.

## Connecting Power to the ChargeBase

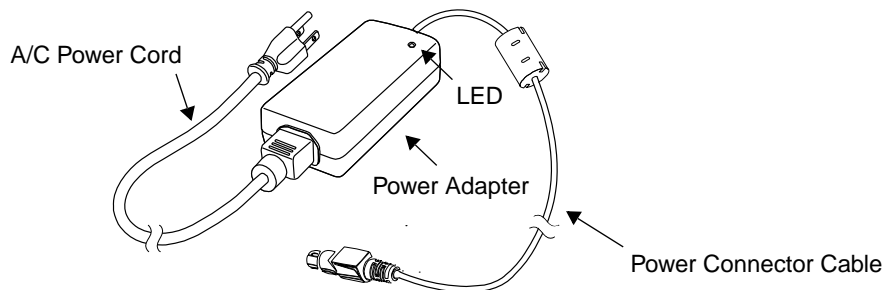

1. Plug the A/C power cord into the power adapter.
2. Plug the power connector cable into the power connector on the back panel of the ChargeBase.
3. Plug the A/C power cord into a standard wall outlet. The LED on the Power Adapter illuminates to indicate power.
4. All of the Power/Dock LEDs illuminate red to indicate the base has power. Terminal wells with properly docked Dolphins indicate power with a green LED.

# Preliminary Draft 1/19/11

5. The base is ready to begin charging terminals.

## ***Charging the Main Battery***

The base provides power to the Dolphin terminals and allows charging of the main batteries in the terminals. The main battery of each terminal charges in 4.5 hours for the standard 3.7V battery or 6 hours for the extended 3.7V battery. The intelligent battery charging system incorporated into all Dolphin terminals prevents overcharging, which means that Dolphin terminals may be seated in the base indefinitely without damage to the terminals, battery packs, or the base.

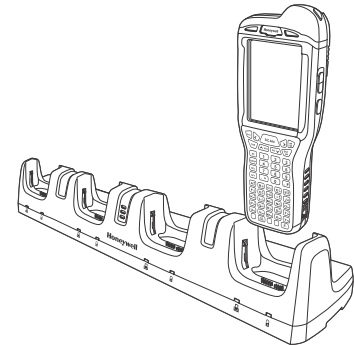

## ***To Power a Terminal and Charge its Main Battery***

1. Install the main battery pack in the terminal; see [Install the Main Battery Pack](#) on page 2-1.
2. Verify the base has power. If the Power/Dock LEDs are not illuminated, see [Connecting Power to the ChargeBase](#) on page 15-3.
3. Slide the Dolphin terminal into one of the four terminal wells. The the Power/Dock LED for the well changes to green. Charging begins immediately if required by the Dolphin terminal.

- ⚠ *Make sure the terminal is dry before placing it in the Net Base. Do NOT place a wet terminal in the Net Base! Doing so may cause damage not covered by the warranty.*
- ⚠ *We recommend use of Honeywell Li-Ion or Li-poly battery packs. Use of any non-Honeywell battery may result in damage not covered by the warranty.*

## ***Mounting***

This base should be mounted to a dry, stable surface. When choosing a location, always bear in mind that

- The mounting location must allow users easy access to the power connector.'
- The **base** should be oriented so that users can easily see the LEDs.

## ***Bottom Panel***

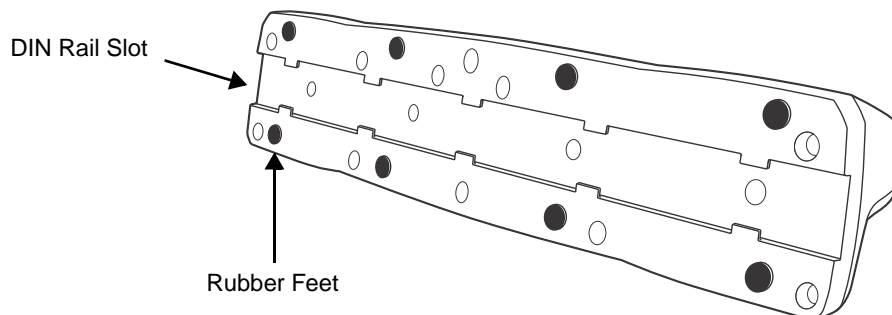

## ***Desk Mounting***

The DIN Rail (7.5 X 35 mm) slot on the bottom panel enables secure mounting.

# Preliminary Draft 1/19/11

---

## Installation Hardware

**Screw:** 3/16 in. dia x 5/8 in. long pan head screw

**Washer:** 1/2 in. OD x 7/32 in. ID x 3/64 in. thick

**Nut:** 3/16 in. dia

1. Slide the DIN Rail into the DIN Rail slot on the bottom panel.

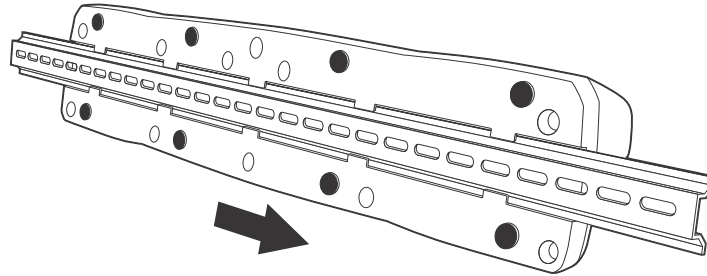

2. Turn the base and DIN Rail right side up.
3. Secure the DIN Rail to a stable, flat horizontal surface.

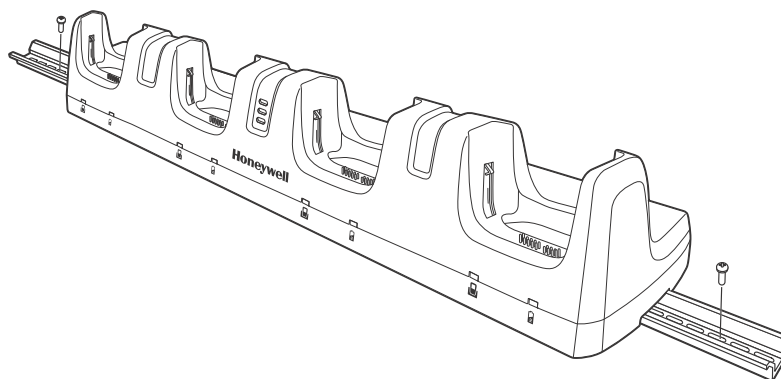

# Preliminary Draft 1/19/11

---

# Preliminary Draft 1/19/11

## Dolphin 99EX Net Base Device

### Overview

The Net Base enables up to four Dolphin 99EX mobile computers to communicate with a host device over an Ethernet network. In addition, the Net Base provides a second RJ45 Ethernet port for connection to an additional device such as a printer, workstation, eBase, or another Net Base.



*We recommend use of Honeywell peripherals, power cables, and power adapters. Use of any non-Honeywell peripherals, cables, or power adapters may cause damage not covered by the warranty.*

### Unpacking the Net Base

Open the shipping box and inspect the package to see that the following standard items are included:

- One Dolphin Net Base Ethernet cradle
- One universal AC/DC power adapter for the Dolphin Net Base
- One power cord

You will also need to provide a standard CAT-5 Ethernet network cable. These items are needed to set up and operate the Net Base. If any items are missing or anything appears to be damaged, contact your Customer Account Representative.

Keep the original packaging in case you need to return the Net Base for service or to store the Net Base while not in use.

### Charge Time

The base supplies power to the intelligent battery charging system in all Dolphin terminals, which senses when a full charge has been achieved and switches to a trickle charge to maintain the full charge.

As battery packs charge, the charging circuitry follows the two-step charging process (CC-CV) that is recommended for Li-ion or Li-poly batteries. The process monitors changes in temperature, current, and voltage. The main battery of each terminal charges in 4.5 hours for the standard 3.7V battery or 6 hours for the extended 3.7V battery.

### Convenient Storage

Intelligent battery charging makes this base a safe and convenient storage receptacle for your Dolphin terminal.

### Capacity

The base can hold up to 4 Dolphin terminals. Each charging well charges each terminal independently of the other wells.



*We recommend use of Honeywell Li-ion or Li-poly battery packs. Use of any non-Honeywell battery may result in damage not covered by the warranty.*



*We recommend use of Honeywell peripherals, power cables, and power adapters. Use of any non-Honeywell peripherals, cables, or power adapters may cause damage not covered by the warranty.*

# Preliminary Draft 1/19/11

## Parts and Functions

### Front Panel

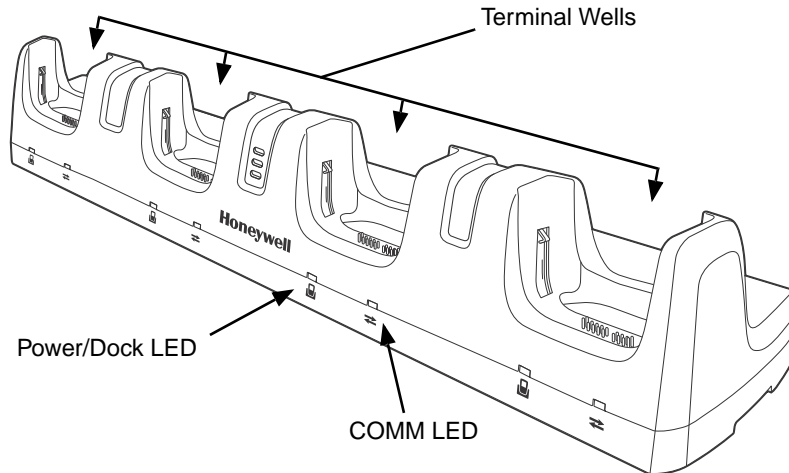

### Terminal Wells

The Net Base contains four terminal wells. Each well has its own dedicated Power/Dock LED and COMM LED indicator.

Place the Dolphin terminal in any one of the four wells to communicate with a host device, power the terminal, and charge the installed battery pack. The Net Base completely charges the main battery in a Dolphin terminal in 4.5 hours for the standard 3.7V battery or 6 hours for the extended 3.7 battery.

### Power/DOCK LED

Indicates if power is supplied to the Net Base and if a terminal is docked properly in the terminal well. Each terminal well has its own dedicated Dock LED.

#### **This color**      **means...**

Red                      The Net Base has power but no terminal is docked.

Green                    The Net Base has power and the terminal is properly seated in the base.

### COMM LED

The COMM LED indicates the status of connection and data transfer between the Dolphin terminal and the Ethernet. Each terminal well has its own dedicated COMM LED.

When the Dolphin terminal is docked:

#### **This color**      **and status**      **means...**

Green                    Solid                      A connection has been established between the Dolphin terminal and the Ethernet.

Green                    Flashing                Data transfer in progress.



# Preliminary Draft 1/19/11

---

## Back Panel

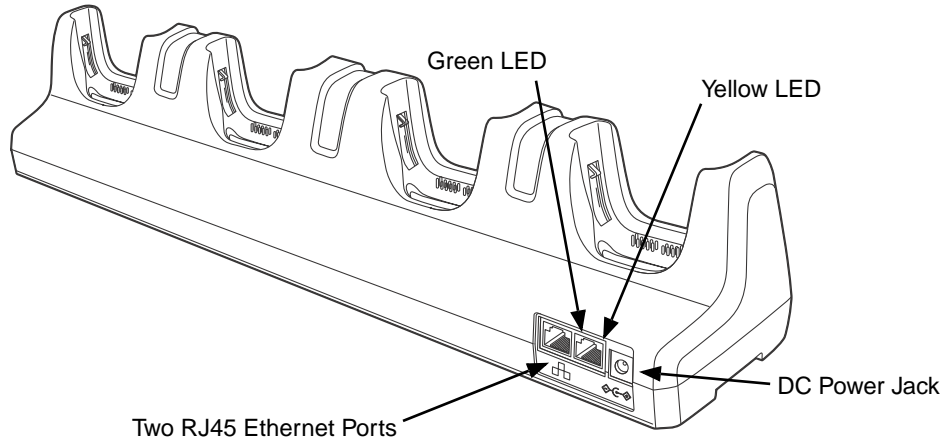

## DC Power Jack

Use the power cable from Honeywell that comes with the Net Base to supply power to this power jack. For more information, see [Power](#) on page 16-4.

## RJ45 Ethernet Ports

The Net Base contains two RJ45 Ethernet ports. You can connect the Net Base to an Ethernet-compliant device to facilitate Ethernet communication to and from the terminal by plugging a standard CAT-5 Ethernet cable into one of the two Ethernet ports provided. The second RJ45 Ethernet port can be used for connection to an additional device such as a printer, workstation, eBase, or another Net Base.

*Note:* The Net Base does not use a Spanning Tree Protocol (STP). When both RJ45 Ethernet ports are used, do not connect both Net Base interfaces to the same layer 2 LAN.

Each Ethernet port has a dedicated green and yellow status LED.

| This color | and status | means...   |
|------------|------------|--|
| Green      | Flashing   | Data transfer is in progress.  |
|            | Solid      | A connection has been established between the Dolphin terminal and the Ethernet. |
| Yellow     | Solid      | Ethernet is connected at 100T.   |
|            | Off        | Ethernet is connected at 10T.  |

# Preliminary Draft 1/19/11

---

## Bottom Panel

For details on how to mount the Net Base, see [Mounting the Net Base](#) on page 16-6.

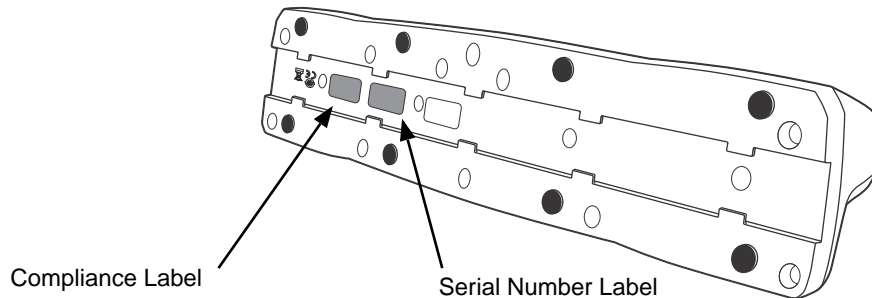

## Power

The terminal requires 12 Volts DC input for communications and battery charging; the power adapter on the power cable converts the voltage from the power source to 12 volts DC. **Only** the Honeywell 12V/ 8.5A power supply provided with the Net Base converts the voltage appropriately. The operating temperature range is -10° to 45°C (14° to 113°F).

Honeywell recommends that you leave the Net Base connected to its power source at all times, so that it is always ready to use.



*We recommend use of Honeywell peripherals, power cables, and power adapters. Use of any non-Honeywell peripherals, cables, or power adapters may cause damage not covered by the warranty.*

## Connecting Power to the Net Base

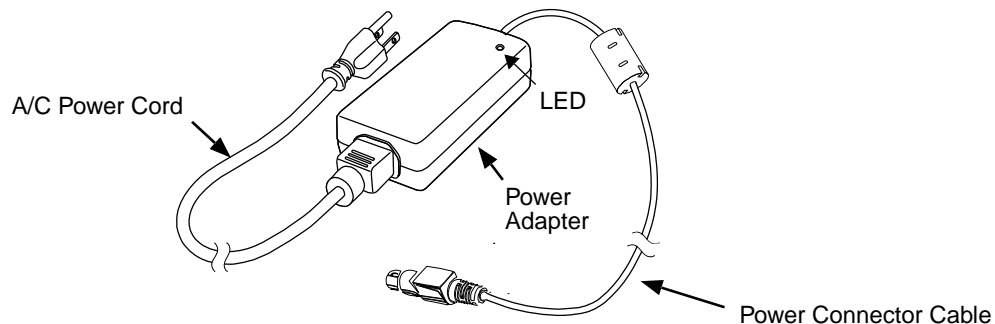

1. Plug the A/C power cord into the power adapter.
2. Plug the power connector cable into the power connector on the back of the Net Base.
3. Plug the A/C power cord into a standard wall outlet. The LED on the Power Adapter illuminates to indicate power.
4. All four Power/Dock LEDs illuminate solid red to indicate the base has power. Terminal wells with properly docked Dolphins indicate power with a green LED.
5. The base is ready to begin charging terminals.

# Preliminary Draft 1/19/11

---

## Charging the Main Battery

The base provides power to the Dolphin terminals and allows the charging of the main batteries in the terminals. The main battery of each terminal charges in 4.5 hours for the standard 3.7V battery or 6 hours for the extended 3.7V battery. The intelligent battery charging system incorporated into all Dolphin terminals prevents overcharging, which means that Dolphin terminals may be stored in the base indefinitely without damage to the terminals, battery packs, or the base.

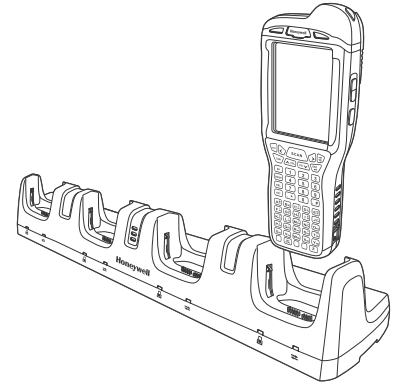

## To Power a Terminal and Charge its Main Battery

1. Install the main battery pack in the terminal; see [Install the Main Battery Pack](#) on page 2-1.
2. Verify the base has power. If the Power/Dock LEDs are not illuminated, see [Connecting Power to the Net Base](#) on page 16-4.
3. Slide the Dolphin terminal into one of the four terminal wells. The the Power/Dock LED for the well changes to green. Charging begins immediately if required by the Dolphin terminal.

 *Make sure the terminal is dry before placing it in the Net Base. Do NOT place a wet terminal in the Net Base! Doing so may cause damage not covered by the warranty.*

 *We recommend use of Honeywell Li-Ion or Li-poly battery packs. Use of any non-Honeywell battery may result in damage not covered by the warranty.*

## Communication

### Software Requirements

Before you connect the Dolphin terminal to the Net Base, make sure you have the most current software installed. To check the terminal's system information, tap  > **Power Tools** > **SysInfo**.

- The Kernel version must be 26.01 or later in terminals running Windows Embedded Handheld 6.5 Classic.
- In terminals running Windows Embedded Handheld 6.5 Professional, the kernel version must be 25.01 or later.

### Applications on the Dolphin Terminal

Applications running on the Dolphin terminal when it is connected to the Net Base should be designed specifically for a partially connected network. For more details, please refer to the *Best Practices for Partially Connected Networks* document available at [www.honeywellaidc.com](http://www.honeywellaidc.com).



## Connecting the Dolphin Terminal to the Net Base

By default, the Dolphin terminal is configured to obtain IP addresses automatically using a DHCP server. This means that in most cases, you would simply plug-and-play the unit.

1. Verify the base has power. If the Power/Dock LEDs are not illuminated, see [Connecting Power to the Net Base](#) on page 16-4.
2. Plug the CAT-5 Ethernet cable into one of the RJ45 connectors on the back of the Net Base.

# Preliminary Draft 1/19/11

---

3. Plug the Ethernet cable into the network.
4. Insert the Dolphin into one of the terminal wells. The DOCK LED for the well changes from red to green and the connection icon on the Dolphin's title bar changes from  to .
5. By default, the DHCP server assigns a unique IP address to each of the Dolphin terminals docked in the Net Base. This IP address can be used by any application on the Dolphin terminal.

*Note: Instead of using the default for DHCP assigned IP addresses, the Dolphin terminal can use a statically assigned IP address. See standard Microsoft Windows Mobile documentation for how to assign a static IP address to a network adapter. In this case, set a static IP address for the adapter named "SMSC9500 USB2.0 FAST Ethernet Drive".*

## *Displaying the Net Base Terminal Well and Dolphin IP Address*

Once the Dolphin terminal establishes communication, it uses the unique IP address assigned to the terminal well it is docked in on the Net Base. If four Dolphin terminals are successfully connected, then four different IP addresses are assigned **to the adapter associated with the Dolphin terminal.**

1. Tap  > **Power Tools > Network Utilities > IPConfig.**
2. Change a **Adapter** to SMC9500.
3. On the Input tab, tap the **Display full configuration** button.
4. The Dolphin terminal retrieves and displays the IP configuration for the entire Dolphin terminal and the Net Base terminal well where the Dolphin is docked.
5. Locate the **IpAddress** field in the IP configuration list.

## ***Mounting the Net Base***

Set the Net Base on a dry, stable surface, such as a desktop or workbench near an electrical outlet. Be sure to provide enough workspace with good lighting for the user to view and operate the Dolphin terminal while it is in the Net Base. When choosing a location, bear in mind that the mounting location must allow users easy access to the terminal wells, the Ethernet ports, and the power jack.

## ***Using the DIN Rail***

### **Installation Hardware**

- Screw:** 3/16 in. dia x 5/8 in. long pan head screw  
**Washer:** 1/2 in. OD x 7/32 in. ID x 3/64 in. thick  
**Nut:** 3/16 in. dia

The DIN rail slot (7.5 X 35 mm) on the bottom panel enables secure mounting to a horizontal surface.

1. Slide the DIN rail into the DIN rail slot along the bottom panel of the Net Base.

# Preliminary Draft 1/19/11

---

2. Then, using the appropriate nuts and bolts, secure the DIN rail to the desk or flat surface.

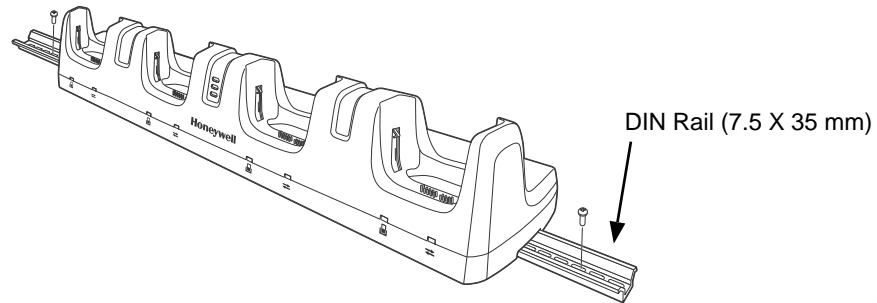

# Preliminary Draft 1/19/11

---

# Preliminary Draft 1/19/11

## *Dolphin 99EX QuadCharger Device*

### **Overview**

This 4-slot charging station provides intelligent battery management for the rechargeable battery packs used in Dolphin terminals.

### **Capacity**

The charger holds 4 Honeywell 3.7V Li-ion or 3.7V Li-poly batteries.

### **Charging Time**

Charge time is 4.5 hours for the standard 3.7V battery or 6 hours for the extended 3.7V battery.

### **Charging Process**

Each charging slot works independently of the other three. As battery packs charge, the charging circuitry follows the two-step charging process (CC-CV) that is recommended for Li-ion and Li-poly batteries. The process monitors changes in temperature, current, and voltage and resets the battery pack.



*We recommend use of Honeywell Li-Ion or Li-poly battery packs. Use of any non-Honeywell battery may result in damage not covered by the warranty.*



*We recommend use of Honeywell peripherals, power cables, and power adapters. Use of any non-Honeywell peripherals, cables, or power adapters may cause damage not covered by the warranty.*

# Preliminary Draft 1/19/11

---

## Parts and Functions

### Top Panel

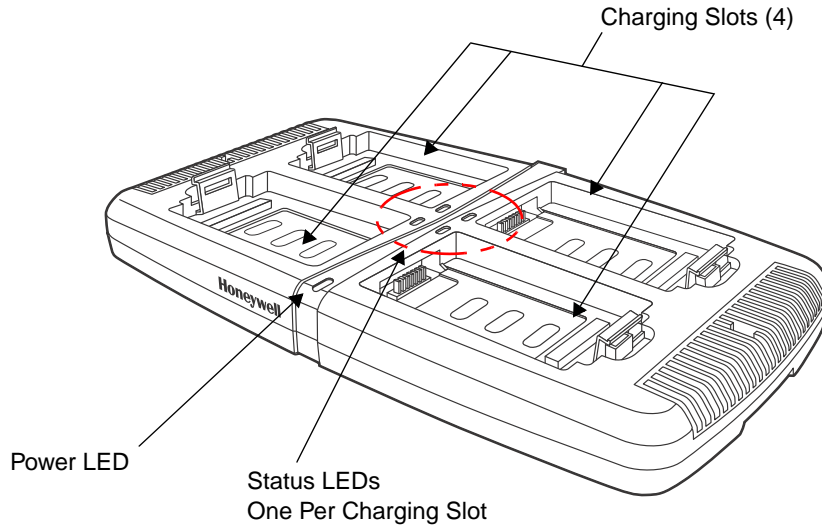

### Charging Slots

There are 4 charging slots. Each slot holds one Li-ion or Li-poly battery and charges it independently of the other slots. When a battery is placed in each slot, it immediately begins charging.

### Power LED

The power LED indicates if the QuadCharger is powered and operational. When the QuadCharger is receiving power, the LED illuminates green.

### Power Supply Connector

You attach the power supply to this connector. The universal power supply accepts input voltages between 90-265 volts. See [Supplying Power](#) on page 17-3.

### Status LEDs

A status LED is located at one corner of each of the 4 battery slots. The color of the LED indicates the charge status of the batteries in its slot.

| Color          | This color indicates that the battery in the slot...      |
|----------------|---|
| Green (Solid)  | Has completed its charge cycle and is ready for use.      |
| Orange (Solid) | Is being charged at a maximum charge rate.                |
| Red (Flashing) | Encountered an error during the most recent charge cycle. |



# Preliminary Draft 1/19/11

---

## **Supplying Power**

The charger must be connected to a power source via the Honeywell power adapter cable so that voltage is adjusted appropriately. Use only the Honeywell 12VDC, 3A power supply provided with the base.

1. Locate the AC power adapter cable and plug it into the power source.
2. Connect the power cable to the power adapter.
3. Connect the power cable to the supply connector on the back of the charger.

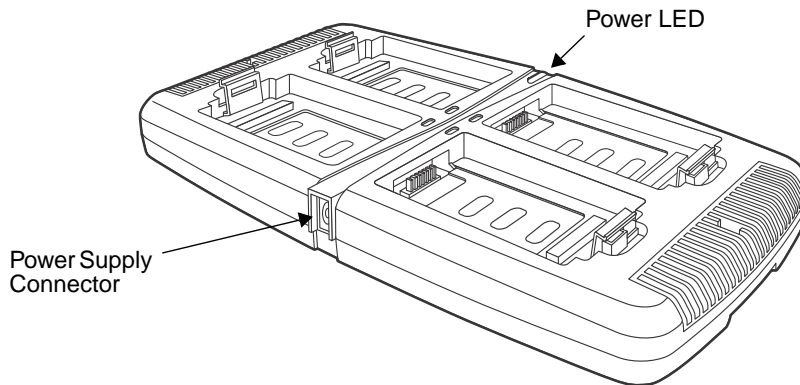

4. The power LED illuminates green, and the charger performs a self-diagnostic test that lasts approximately five seconds.

## **Recommendations for Storing Batteries**

To maintain top performance from batteries, avoid storing batteries outside of the following temperature ranges:

- 14°F to 113°F (-10°C to +45°C) for short term storage of less than one month
- 32°F to 86°F (-0°C to +30°C) for long term storage

Do not store batteries in extremely high humidity. For prolonged storage, do not keep batteries stored in a charger that is connected to a power source.

## **Inserting and Charging Batteries**

For best results, battery packs should be at room temperature before recharging them; temperature has a marked effect on charging. The recommended temperature range is 50°F to 95° F (10°C to 35° C).

1. Set up the charger, see [Supplying Power](#) above.
2. Power the charger. The Power LED illuminates green.
3. Insert the battery at an angle so the battery pack contacts and the QuadCharger contacts align.
4. Snap the battery into place with a hinging motion.
5. The Status LED for that particular slot illuminates orange to indicate the battery is seated properly and the charging cycle has begun.
6. When the Status LED turns green, the battery in the slot has completed charging.

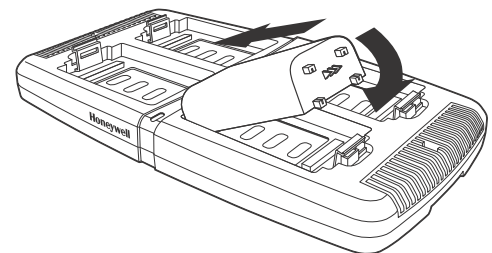

# Preliminary Draft 1/19/11

---

## ***Mounting***

The charger should be on a dry, stable surface and can be mounted on a flat, horizontal surface such as a desktop or workbench.

When choosing a location, always bear in mind that

- the mounting location must allow users easy access to the power connector.
- the charger should be oriented so that users can easily insert and remove battery packs and see the LEDs.

## ***Installation Hardware***

The DIN rail slot on the bottom panel enables secure mounting to a horizontal surface.

**Screw:** 3/16 in. dia x 5/8 in. long pan head screw

**Washer:** 1/2 in. OD x 7/32 in. ID x 3/64 in. thick

**Nut:** 3/16 in. dia

## ***Desk Mounting***

1. Slide the DIN rail into the DIN rail slot (7.5 X 35 mm) on the bottom of the QuadCharger.
2. Then, using the appropriate nuts and bolts listed above, secure the DIN rail to the desktop.

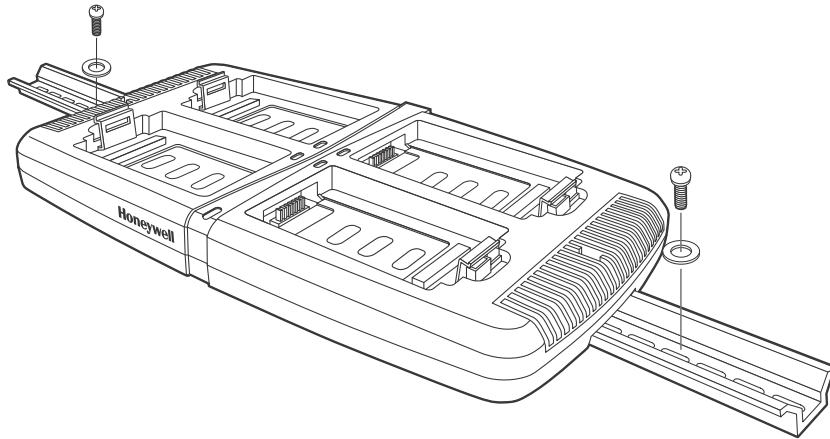

# Preliminary Draft 1/19/11

---

## ***Troubleshooting***

If you encounter problems with your QuadCharger device, refer to chart below for possible solutions. If problems persist, please contact Honeywell Technical Support.

| <b>Problem</b>   | <b>Issue</b>   |
|--|--|
| The Status LED does not come on when I insert a battery pack.                  | Check the power connections; make sure the Power cable is inserted into the Power supply connector and the battery pack is properly seated.  |
| The Status LED lights red during charging.                                     | Try to charge the battery in one of the other charging slots. If the red Status LED comes on again, then the problem is associated with the battery pack. If the red status stays with the charging slot, the problem is associated with the charging circuitry. |
| The Status LED lights red and stays on without a battery in the charging slot. | An error occurred during the self-diagnostic test for that particular charging pocket. Call Honeywell Product Service and request an RMA.<br><br>For additional warranty and return information, see <a href="#">Customer Support</a> on page 19-1.              |

# Preliminary Draft 1/19/11

---

# Preliminary Draft 1/19/11

## Dolphin 99EX Charge Rack and Net Rack Device

### Overview

*Note: The information in this chapter applies to both the Dolphin Charge Rack and Dolphin Net Rack unless otherwise indicated.*

You can power and charge the main battery in up to thirty Dolphin terminals using the Charge Rack or Net Rack. The Net Rack also enables up to thirty Dolphin 99EX mobile computers to communicate with a host device over an Ethernet network.

### Unpacking the Rack

Open the shipping box and inspect the package to see that the following standard items are included:

- One Dolphin Charge Rack or Net Rack
- One power cord

For the Net Rack, you will also need to provide a standard CAT-5 Ethernet network cable. The network cable is needed to set up and operate the Net Rack. If any items are missing or anything appears to be damaged, contact your Customer Account Representative.



*We recommend use of Honeywell peripherals, power cables, and power adapters. Use of any non-Honeywell peripherals, cables, or power adapters may cause damage not covered by the warranty.*

### Charge Time

The rack supplies power to the intelligent battery charging system in all Dolphin terminals, which senses when a full charge has been achieved and switches to a trickle charge to maintain the full charge. As battery packs charge, the charging circuitry follows the two-step charging process (CC-CV) that is recommended for Li-ion or Li-poly batteries. The process monitors changes in temperature, current, and voltage.

The rack completes a full charge of the Dolphin's main battery pack in 4.5 hours for the standard 3.7V battery or 6 hours for the extended 3.7V battery.



*We recommend use of Honeywell Li-ion or Li-poly battery packs. Use of any non-Honeywell battery may result in damage not covered by the warranty.*

### Convenient Storage

Intelligent battery charging makes this rack a safe and convenient storage receptacle for your Dolphin terminal.

### Capacity

The rack can hold up to thirty Dolphin terminals. Each charging well charges each terminal independently of the other wells.

# Preliminary Draft 1/19/11

## Parts and Functions

### Front and Side Panel

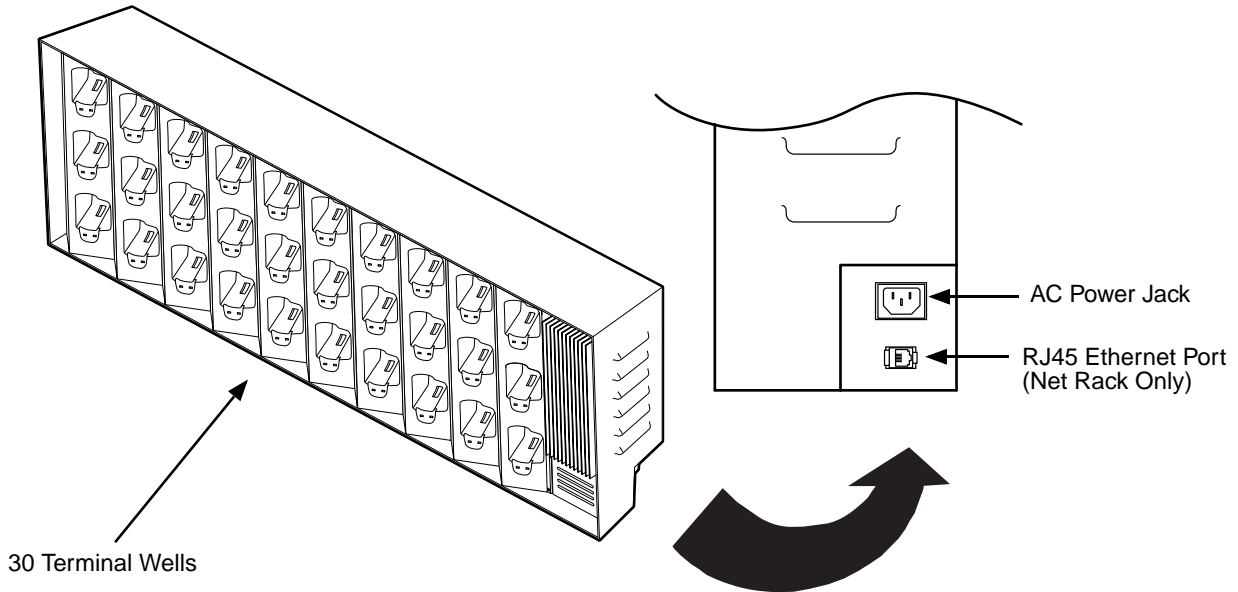

### Terminal Wells

The rack contains thirty terminal wells. Place the Dolphin terminal in any one of the thirty wells to communicate with a host device (Net Base only), power the terminal, and charge the installed battery pack. The rack completely charges the main battery in a Dolphin terminal in 4.5 hours for the standard 3.7V battery or 6 hours for the extended 3.7 battery.

### AC Power Jack

Use the AC power cable from Honeywell that comes with the rack to supply power to this power jack. For more information, see [Power](#) on page 18-2.

### RJ45 Ethernet Ports (Net Rack Only)

The Net Rack contains an RJ45 Ethernet port. You can connect the Net Rack to an Ethernet-compliant device to facilitate Ethernet communication to and from the terminal by plugging a standard CAT-5 Ethernet cable into the Ethernet port provided.

### Back Panel

For details on how to mount the Charge Rack or Net Rack, see [Mounting the Rack](#) on page 18-4.

### Power

The rack requires 100 - 240 Volts AC, 6 Amps of power to charge the Dolphin terminals. Honeywell recommends that you leave the rack connected to its power source at all times, so that it is always ready to use.



*We recommend use of Honeywell peripherals, power cables, and power adapters. Use of any non-Honeywell peripherals, cables, or power adapters may cause damage not covered by the warranty.*

# Preliminary Draft 1/19/11

---

## Connecting Power to the Rack

1. Plug the power cable into the power connector on the side of the rack, see [AC Power Jack](#) on page 18-2.
2. Plug the A/C power cord into a standard wall outlet. The rack is now powered.

## Charging the Main Battery

The rack provides power to the Dolphin terminals and allows the charging of the main batteries in the terminal. The intelligent battery charging system incorporated into all Dolphin terminals prevents overcharging, which means that Dolphin terminals may be stored in the rack indefinitely without damage to the terminals, battery packs, or the rack.

## To Power a Terminal and Charge its Main Battery

1. Install the main battery pack in the terminal; see [Install the Main Battery Pack](#) on page 2-1.
2. Slide the Dolphin terminal into one of the thirty terminal wells. The terminal screen turns off and the right LED illuminates orange indicating a properly seated terminal. Charging begins immediately if required by the Dolphin terminal.

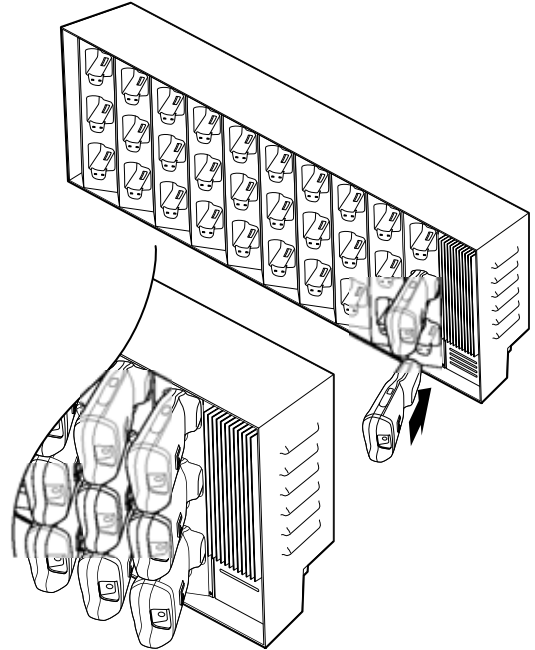

*Make sure the terminal is dry before placing it in the Charge/Net Rack. Do NOT place a wet terminal in the Charge/Net rack! Doing so may cause damage not covered by the warranty.*



*We recommend use of Honeywell Li-Ion or Li-poly battery packs. Use of any non-Honeywell battery may result in damage not covered by the warranty.*

## Communication (Net Rack Only)

### Software Requirements

Before you connect the Dolphin terminal to the Net rack, make sure you have the most current software installed. To check the terminal's system information, tap  > **Power Tools** > **SysInfo**.

- The Kernel version must be 26.01 or later in terminals running Windows Embedded Handheld 6.5 Classic.
- In terminals running Windows Embedded Handheld 6.5 Professional, the kernel version must be 25.01 or later.

### Applications on the Dolphin Terminal

Applications running on the Dolphin terminal when it is connected to the Net rack should be designed specifically for a partially connected network. For more details, please refer to the *Best Practices for Partially Connected Networks* document available at [www.honeywellaidc.com](http://www.honeywellaidc.com).

# Preliminary Draft 1/19/11

---

## **Connecting the Dolphin Terminal to the Net Rack**

By default, the Dolphin terminal is configured to obtain IP addresses automatically using a DHCP server. This means that in most cases, you would simply plug-and-play the unit.

1. Verify the Net Rack has power, see [Connecting Power to the Rack](#) on page 18-3.
2. Plug the CAT-5 Ethernet cable into the RJ45 connector on the side of the Net Rack.
3. Plug the Ethernet cable into the network.
4. Insert the Dolphin into one of the terminal wells. The terminal screen turns off and the right LED illuminates orange indicating a properly seated terminal.
5. By default, the DHCP server assigns a unique IP address to each of the Dolphin terminals docked in the Net Rack. This IP address can be used by any application on the Dolphin terminal.

*Note: Instead of using the default for DHCP assigned IP addresses, the Dolphin terminal can use a statically assigned IP address. See standard Microsoft Windows Mobile documentation for how to assign a static IP address to a network adapter. In this case, set a static IP address for the adapter named "SMSC9500 USB2.0 FAST Ethernet Drive".*

## **Mounting the Rack**

Mount the rack on a dry, stable surface, near an electrical outlet. Be sure to provide enough workspace with good lighting for the user to view Dolphin terminal's LEDs while it is in the rack. When choosing a location, bear in mind that the mounting location must allow users easy access to the terminal wells, the Ethernet port (Net Rack only), and the power jack.



# Preliminary Draft 1/19/11

## Installation Hardware

| <b>H-Bracket to the Mounting Surface</b>       |                   |                          |   |
|--|-------------------|--------------------------|---|
| <b>Mount Type</b>                              | <b>Drill Size</b> | <b>Washer</b>            | <b>Bolt</b>   |
| Hollow Wall (e.g., Steel stud or cinder block) | 7/8"              | 3/8" Flat Washer, Qty. 4 | Zinc-Plated Steel Toggle Bolt, Round Head, 3/8" Dia., 4" Length (2-5/8" Usable Length Required), Qty. 4 |
| Wood Stud                                      | 1/4"              | 3/8" Flat Washer, Qty. 4 | Hex Head (Lag Screw), Steel, Zinc-plated, 3/8" thread, 2-1/2" Length, Qty. 4                            |

| <b>Charge/Net Rack to the H-Bracket</b>   |  |   |
|---|--|---|
| <b>Washer</b>   | <b>Bolt</b>  | <b>Additional</b>   |
| 3/8" Flat Washer, Qty. 4  | 3/8"-16 , Cap Screw, Zinc-plated, 1" length, Grade 5, Qty. 4 | 3/8"-16 Nut for Strut Channel W/Spring, Zinc, for 13/16" Deep Strut, Qty. 4 |
| 150lbs. Max recommended load on H-Bracket (this is approx. 40lbs. Over a fully loaded rack)   |  |   |
| Use bracket and available studs to determine hole pattern (bracket to wall fasteners must be spaced at a minimum of 16" apart horizontally) |  |   |

1. Attach the mounting bracket to dry, stable surface.
2. Then, using the appropriate nuts and bolts, secure the Charge/Net Rack to the mounting bracket.

# Preliminary Draft 1/19/11

---

# Preliminary Draft 1/19/11

## *Customer Support*

### ***Product Service and Repair***

Honeywell International Inc. provides service for all its products through service centers throughout the world. To obtain warranty or non-warranty service, contact the appropriate location below to obtain a Return Material Authorization number (RMA #) before returning the product.

#### **North America**

Telephone: (800) 782-4263  
E-mail: [hsmnaservice@honeywell.com](mailto:hsmnaservice@honeywell.com)

#### **Latin America**

Telephone: (803) 835-8000  
Telephone: (800) 782-4263  
Fax: (239) 263-9689  
E-mail: [laservice@honeywell.com](mailto:laservice@honeywell.com)

#### **Brazil**

Telephone: +55 (11) 5185-8222  
Fax: +55 (11) 5185-8225  
E-mail: [brservice@honeywell.com](mailto:brservice@honeywell.com)

#### **Mexico**

Telephone: 01-800-HONEYWELL (01-800-466-3993)  
Fax: +52 (55) 5531-3672  
E-mail: [mxservice@honeywell.com](mailto:mxservice@honeywell.com)

#### **Europe, Middle East, and Africa**

Telephone: +31 (0) 40 2901 633  
Fax: +31 (0) 40 2901 631  
E-mail: [euroservice@honeywell.com](mailto:euroservice@honeywell.com)

#### **Hong Kong**

Telephone: +852-29536436  
Fax: +852-2511-3557  
E-mail: [apservice@honeywell.com](mailto:apservice@honeywell.com)

#### **Singapore**

Telephone: +65-6842-7155  
Fax: +65-6842-7166  
E-mail: [apservice@honeywell.com](mailto:apservice@honeywell.com)

#### **China**

Telephone: +86 800 828 2803  
Fax: +86-512-6762-2560  
E-mail: [apservice@honeywell.com](mailto:apservice@honeywell.com)

#### **Japan**

Telephone: +81-3-3839-8511  
Fax: +81-3-3839-8519  
E-mail: [apservice@honeywell.com](mailto:apservice@honeywell.com)

### ***Online Product Service and Repair Assistance***

You can also access product service and repair assistance online at [www.honeywellaidc.com](http://www.honeywellaidc.com).

# Preliminary Draft 1/19/11

---

For ongoing and future product quality improvement initiatives, the 99EX comes equipped with an embedded device lifetime counter function. Honeywell may use lifetime counter data for future statistical reliability analysis as well as ongoing quality, repair and service purposes.

## ***Technical Assistance***

If you need assistance installing or troubleshooting your device, please call your distributor or the nearest technical support office:

### **North America/Canada**

Telephone: (800) 782-4263  
E-mail: [hsmnasupport@honeywell.com](mailto:hsmnasupport@honeywell.com)

### **Latin America**

Telephone: (803) 835-8000  
Telephone: (800) 782-4263  
E-mail: [hsmlasupport@honeywell.com](mailto:hsmlasupport@honeywell.com)

### **Brazil**

Telephone: +55 (11) 5185-8222  
Fax: +55 (11) 5185-8225  
E-mail: [brsuporte@honeywell.com](mailto:brsuporte@honeywell.com)

### **Mexico**

Telephone: 01-800-HONEYWELL (01-800-466-3993)  
E-mail: [soporte.hsm@honeywell.com](mailto:soporte.hsm@honeywell.com)

### **Europe, Middle East, and Africa**

Telephone: +31 (0) 40 7999 393  
Fax: +31 (0) 40 2425 672  
E-mail: [hsmeurosupport@honeywell.com](mailto:hsmeurosupport@honeywell.com)

### **Hong Kong**

Telephone: +852-29536436  
Fax: +852-2511-3557  
E-mail: [aptechsupport@honeywell.com](mailto:aptechsupport@honeywell.com)

### **Singapore**

Telephone: +65-6842-7155  
Fax: +65-6842-7166  
E-mail: [aptechsupport@honeywell.com](mailto:aptechsupport@honeywell.com)

### **China**

Telephone: +86 800 828 2803  
Fax: +86-512-6762-2560  
E-mail: [aptechsupport@honeywell.com](mailto:aptechsupport@honeywell.com)

### **Japan**

Telephone: +81-3-3839-8511  
Fax: +81-3-3839-8519  
E-mail: [aptechsupport@honeywell.com](mailto:aptechsupport@honeywell.com)

## ***Online Technical Assistance***

You can also access technical assistance online at [www.honeywellaidc.com](http://www.honeywellaidc.com).

# Preliminary Draft 1/19/11

---

## ***Limited Warranty***

Honeywell International Inc. ("HII") warrants its products and optional accessories to be free from defects in materials and workmanship and to conform to HII's published specifications applicable to the products purchased at the time of shipment. This warranty does not cover any HII product which is (i) improperly installed or used; (ii) damaged by accident or negligence, including failure to follow the proper maintenance, service, and cleaning schedule; or (iii) damaged as a result of (A) modification or alteration by the purchaser or other party, (B) excessive voltage or current supplied to or drawn from the interface connections, (C) static electricity or electro-static discharge, (D) operation under conditions beyond the specified operating parameters, or (E) repair or service of the product by anyone other than HII or its authorized representatives.

This warranty shall extend from the time of shipment for the duration published by HII for the product at the time of purchase ("Warranty Period"). Any defective product must be returned (at purchaser's expense) during the Warranty Period to HII factory or authorized service center for inspection. No product will be accepted by HII without a Return Materials Authorization, which may be obtained by contacting HII. In the event that the product is returned to HII or its authorized service center within the Warranty Period and HII determines to its satisfaction that the product is defective due to defects in materials or workmanship, HII, at its sole option, will either repair or replace the product without charge, except for return shipping to HII.

EXCEPT AS MAY BE OTHERWISE PROVIDED BY APPLICABLE LAW, THE FOREGOING WARRANTY IS IN LIEU OF ALL OTHER COVENANTS OR WARRANTIES, EITHER EXPRESSED OR IMPLIED, ORAL OR WRITTEN, INCLUDING, WITHOUT LIMITATION, ANY IMPLIED WARRANTIES OF MERCHANTABILITY OR FITNESS FOR A PARTICULAR PURPOSE, OR NON-INFRINGEMENT.

HII'S RESPONSIBILITY AND PURCHASER'S EXCLUSIVE REMEDY UNDER THIS WARRANTY IS LIMITED TO THE REPAIR OR REPLACEMENT OF THE DEFECTIVE PRODUCT WITH NEW OR REFURBISHED PARTS. IN NO EVENT SHALL HII BE LIABLE FOR INDIRECT, INCIDENTAL, OR CONSEQUENTIAL DAMAGES, AND, IN NO EVENT, SHALL ANY LIABILITY OF HII ARISING IN CONNECTION WITH ANY PRODUCT SOLD HEREUNDER (WHETHER SUCH LIABILITY ARISES FROM A CLAIM BASED ON CONTRACT, WARRANTY, TORT, OR OTHERWISE) EXCEED THE ACTUAL AMOUNT PAID TO HII FOR THE PRODUCT. THESE LIMITATIONS ON LIABILITY SHALL REMAIN IN FULL FORCE AND EFFECT EVEN WHEN HII MAY HAVE BEEN ADVISED OF THE POSSIBILITY OF SUCH INJURIES, LOSSES, OR DAMAGES. SOME STATES, PROVINCES, OR COUNTRIES DO NOT ALLOW THE EXCLUSION OR LIMITATIONS OF INCIDENTAL OR CONSEQUENTIAL DAMAGES, SO THE ABOVE LIMITATION OR EXCLUSION MAY NOT APPLY TO YOU.

All provisions of this Limited Warranty are separate and severable, which means that if any provision is held invalid and unenforceable, such determination shall not affect the validity of enforceability of the other provisions hereof. Use of any peripherals not provided by the manufacturer may result in damage not covered by this warranty. This includes but is not limited to: cables, power supplies, cradles, and docking stations. HII extends these warranties only to the first end-users of the products. These warranties are non-transferable.

The limited duration of the warranty for the Dolphin 99EX is as follows:

- The duration of the limited warranty for terminals with an integrated imager is one year.
- The duration of the limited warranty for touch screens is one year.
- The duration of the limited warranty for the Dolphin 99EX HomeBase device, Dolphin 99EX QuadCharger device, Dolphin 99EX Mobile Base, and Dolphin 99EX ChargeBase device, Mobile is one year.
- The duration of the limited warranty for batteries is one year.  
Use of any battery from a source other than Honeywell may result in damage not covered by the warranty. Batteries returned to Honeywell International Inc. in a reduced state may or not be replaced under this warranty. Battery life will be greatly increased when following the battery instructions in this user's guide.

# Preliminary Draft 1/19/11

---

## ***How to Extend Your Warranty***

Honeywell International Inc. offers a variety of service plans on our hardware products. These agreements offer continued coverage for your equipment after the initial warranty expires. For more information, contact your Sales Representative, Customer Account Representative, or Product Service Marketing Manager from Honeywell International Inc., or your Authorized Reseller.

# Preliminary Draft 1/19/11

---

---

# Preliminary Draft 1/19/11

## **Honeywell Scanning & Mobility**

9680 Old Bailes Road

Fort Mill, SC 29707

[www.honeywellaidc.com](http://www.honeywellaidc.com)