

CT50

Mobile Computer
with Android™ 4.4 Operating System

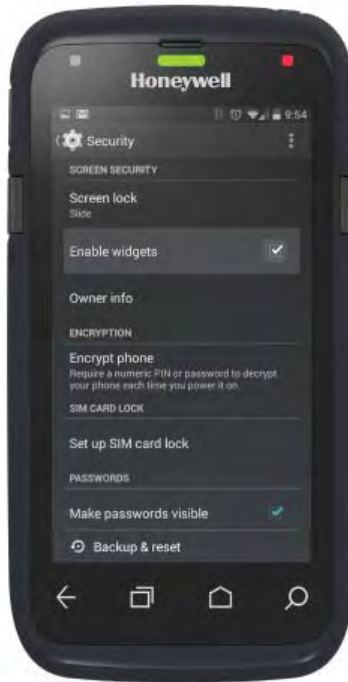

User Guide

Disclaimer

Honeywell International Inc. (“HII”) reserves the right to make changes in specifications and other information contained in this document without prior notice, and the reader should in all cases consult HII to determine whether any such changes have been made. The information in this publication does not represent a commitment on the part of HII.

HII shall not be liable for technical or editorial errors or omissions contained herein; nor for incidental or consequential damages resulting from the furnishing, performance, or use of this material. HII disclaims all responsibility for the selection and use of software and/or hardware to achieve intended results.

This document contains proprietary information that is protected by copyright. All rights are reserved. No part of this document may be photocopied, reproduced, or translated into another language without the prior written consent of HII.

Trademarks

Android, Google, and other marks are trademarks of Google Inc.

Microsoft, Windows are either registered trademarks or registered trademarks of Microsoft Corporation in the United States

and/or other countries.

The Bluetooth trademarks are owned by Bluetooth SIG, Inc., U.S.A. and licensed to Honeywell.

Other product names mentioned in this manual may be trademarks or registered trademarks of their respective companies and are the property of their respective owners.

Patents

For patent information, see www.hsmpats.com.

Copyright © 2015 Honeywell International Inc. All rights reserved.

Contents

Customer Support	vii
Product Service and Repair	vii
Limited Warranty	vii
Send Feedback	vii

1 About the Computer Features 1

About the Dolphin CT50 Mobile Computer	2
--	---

About the Battery	6
Charge the Battery	6
Change the Battery	7
About the Battery Status	9
Check the Battery Level	11
About Battery Life and Conservation	11
Battery Recommendations and Safety Precautions	12
Enable Airplane Mode	12

Power On the CT50	13
-----------------------------	----

Unlock the Screen	14
-----------------------------	----

About the Good Read LED	15
-----------------------------------	----

Configure the Screen Backlight	16
--	----

About the Audio Features	16
Adjust Ringtone and Notification Volume	16
Enable Vibrate Mode	18
Audio Settings	19

Insert a MicroSD Card	20
---------------------------------	----

How to Transfer Files	23
---------------------------------	----

How to Browse Files on the CT50	23
---	----

Accessories for the CT50	24
------------------------------------	----

2	About the User Interface and Applications	27
	About the User Interface	28
	About the Home Screen	28
	Navigation and Function Buttons	29
	Common Status and Notification Icons?	29
	Remap a Button	29
	View Notifications	30
	Manage Notifications	30
	Customize the Home Screen	31
	Customize the Favorites Tray	31
	Use Google™ Search	31
	About Screen Gestures	32
	Set the Time Zone	32
	About Honeywell Applications	33
3	About the Scanner	35
	About the Scanner	36
	How to Send Data as Android Keyboard Input	36
	Change the Scanner Settings	37
	Restore Default Scanner Settings	38
	Scanners Default Settings	38
	Data Processing Settings	38
	Symbology Settings	40
	Imager Settings	41
	Trigger Settings	41
	Notification Settings	41
	Scan a Bar Code	42
4	Use the Phone	43
	About the Phone	44
	Activate the UMTS Phone	44
	Activate the CDMA Phone	47
	Make a Phone Call	47
	Answer the Phone	48
	Switch Apps During a Phone Call	48
	Check Your Voicemail	48
	Set Your Voicemail Number	49
	Change Voicemail Settings	49

Make an Emergency Phone Call	49
Configure Phone Settings	49
5 Use the Camera	51
About the Color Camera	52
Adjust the Camera and Video Settings	52
How to Zoom	52
Change Camera Settings	52
Take a Picture	52
Record a Video	53
Change Video Settings	53
6 Configure the Computer	55
How to Configure the Computer	56
Start the Settings App	56
About the Structure of the Settings App	56
About Network Communications	60
Connect to a Wi-Fi Network	60
Configure Proxy Settings for a Wi-Fi Network	61
Disable Wi-Fi Notifications	62
Connect to an Ethernet Network	62
How to Connect to Virtual Private Networks	63
Add a VPN	63
Connect to a VPN	63
Edit VPN Information	64
About Wireless Security	64
About Certificates	64
Load a Certificate	65
Disable or Remove Certificates	65
About Bluetooth Communications	66
Connect a Bluetooth Device	66
Configure Bluetooth Settings	68
Making the CT50 Discoverable	68
Rename or Disconnect a Paired Device	68

Contents

About Serial and USB Communications	69
About Near Field Communication (NFC)	70
A Specifications	71
Physical and Environmental Specifications	72

Customer Support

If you need assistance installing or troubleshooting your product, contact us by using one of these methods:

Knowledge Base: www.hsmknowledgebase.com

Our Knowledge Base provides thousands of immediate solutions. If the Knowledge Base does not help you solve your problem, log into the Technical Support Portal to submit your problem or ask your question.

Technical Support Portal: www.hsmsupportportal.com

Log into the Technical Support Portal to search our Knowledge Base, submit your problem or question, request a call back, or provide feedback. When filling out one of the forms, provide as much detail as possible. You can even include attachments.

Telephone: www.honeywellaidc.com/locations

For our latest contact information, please check our website.

Product Service and Repair

Honeywell International Inc. provides service for all of its products through service centers throughout the world. To find your service center, go to www.honeywellaidc.com and select **Support > Contact Support > Service and Repair**. Contact your service center to obtain a Return Material Authorization number (RMA #) before you return the product.

To obtain warranty or non-warranty service, return your product to Honeywell (postage paid) with a copy of the dated purchase record.

Limited Warranty

For warranty information, go to www.honeywellaidc.com and click **Resources > Warranty**.

Send Feedback

Your feedback is crucial to the continual improvement of our documentation. To provide feedback about this manual, please contact the Technical Communications department directly at ACSHSMTechnicalCommunications@honeywell.com.

1

About the Computer Features

This chapter introduces the Dolphin CT50 Mobile Computer with the Android 4.4 operating system. Use this chapter to learn about the basic computer features, functions, and accessories.

About the Dolphin CT50 Mobile Computer

The Honeywell Dolphin CT50 Mobile Computer is an enterprise-focused smartphone that uses the Android operating system to provide reliable and secure management of corporate data and wireless communications. The CT50 offers a long availability cycle and key features such as a large display, long-lasting battery, bar code imager, and rugged durability.

- Android 4.4 operating system.
- 2 GB DRAM, 16 GB flash memory
- Large, sunlight-readable display with responsive multi-touch screen
- High performance 2D imager with ergonomic scan trigger keys
- Software-definable LTE/UMTS or CDMA/EVDO wireless WWAN radio for high speed data and quality voice support across all network technologies
- IEEE 802.11a/b/g/n radio
- Bluetooth radio
- NFC technology for short-range wireless data exchange
- Value-added software components supporting specialized imaging and OCR functions
- Mid-tier rugged specifications with IP67 sealing
- Customer-accessible microSD slot for removable memory cards (up to 32 GB)
- Integrated GPS receiver (with WWAN radio option)
- 8-megapixel color camera

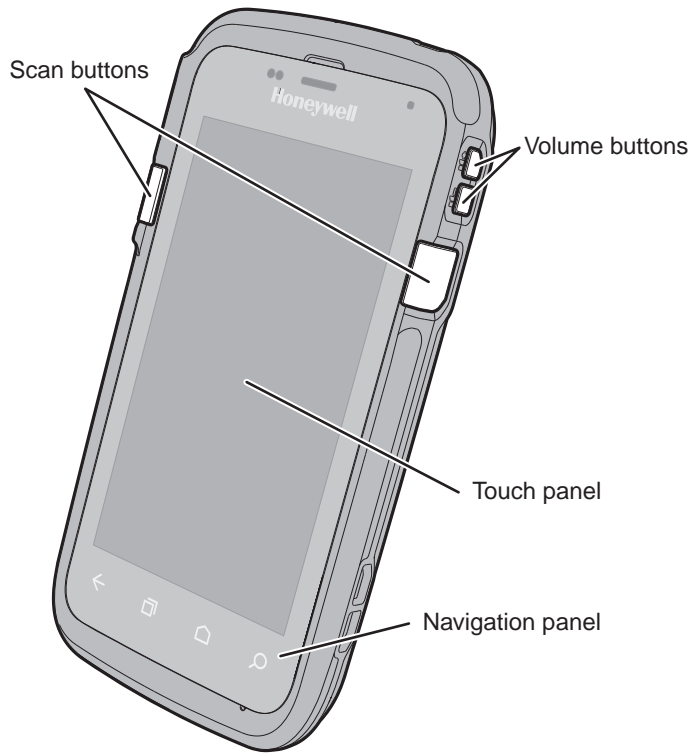

Front View of the CT50

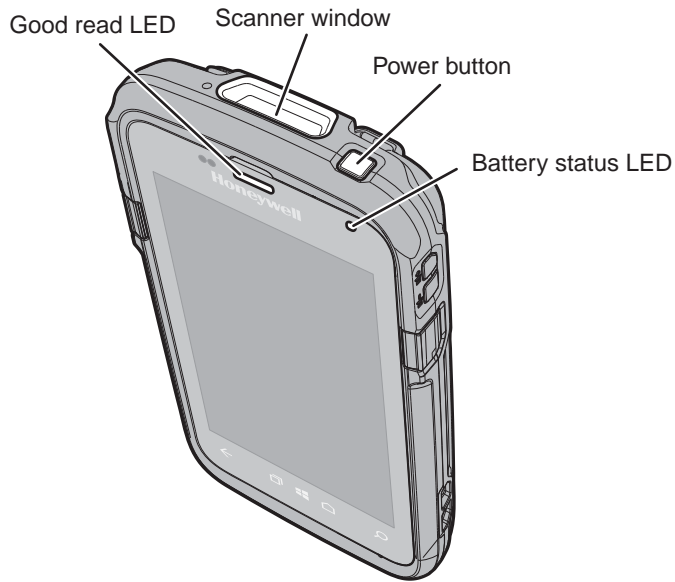

Top View of the CT50

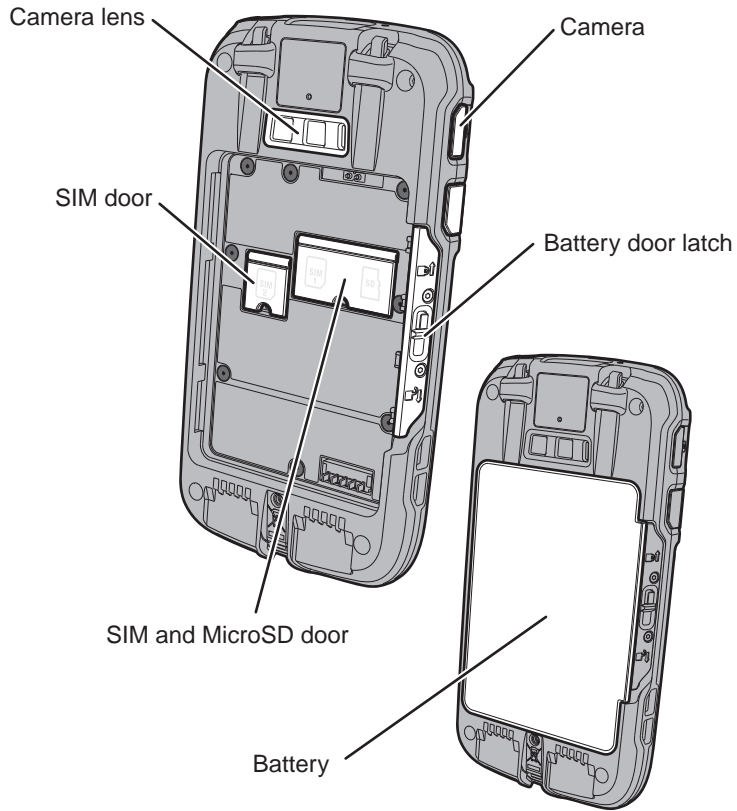

Back View of the CT50

About the Battery

The CT50 uses a rechargeable 3.6 Vdc Li-ion battery as its main power source. The battery has a 14.6 watt hour capacity. Several factors determine the life of your battery, such as display brightness, display timeout, input device, extreme temperature, and your usage. Honeywell recommends that you keep the battery charged at all times to prevent data loss.

Honeywell recommends that you keep the battery charged at all times to prevent data loss. When you change the battery, the computer automatically does into a power-off state and then cold boots.



Caution: The battery used in this device may present a fire or chemical burn hazard if it is mistreated. Do not disassemble it, heat it above 100 °C (212 °F), or incinerate it. Dispose of used batteries promptly. Keep away from children.

Contact your Honeywell representative for replacement batteries.

Charge the Battery

Make sure you fully charge the battery (Model CT50-BTSC) before you use your CT50. You can charge the battery before or after you install it in the CT50.

- Insert the battery into a Quad Battery Charger or the battery well of an eHomeBase.

or

- Insert the CT50 with the battery installed into an eHomeBase, ChargeBase, NetBase, USB Adapter, or Vehicle Power Adapter.

Battery Charge Times

Charging Accessory	Charge Time
eHomeBase	6 hours
ChargeBase	6 hours
NetBase	6 hours
Quad Battery Charger	6 hours
USB Adapter	6 hours
Vehicle Power Adapter	6 hours

Change the Battery

If your battery power is low, you need to either charge the battery in the computer, or replace it with a charged battery.

- 1 Save your files and close any open applications.
- 2 Press and hold the **Power** button. This screen appears:

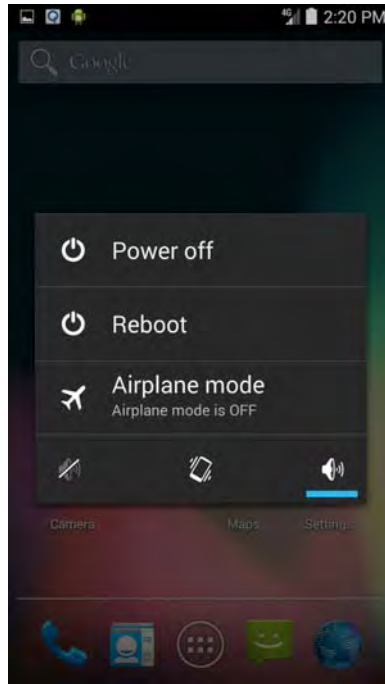

- 3 Tap **Power off**.
- 4 When prompted that the CT50 will shut down, tap **OK**.

- 5 Disconnect the handstrap from the bottom of the computer.

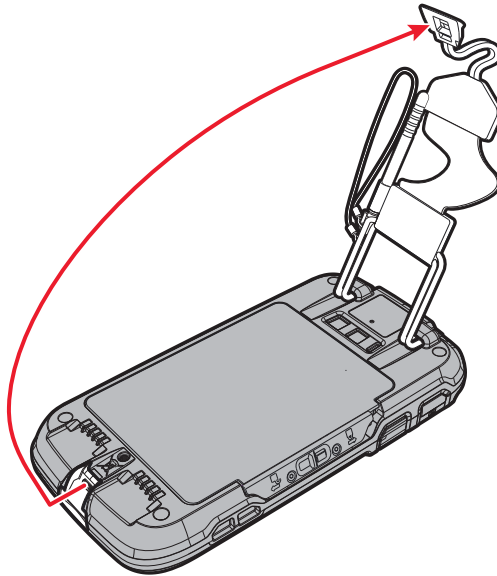

- 6 Press and slide the battery door toward the bottom of the computer to unlock the door.

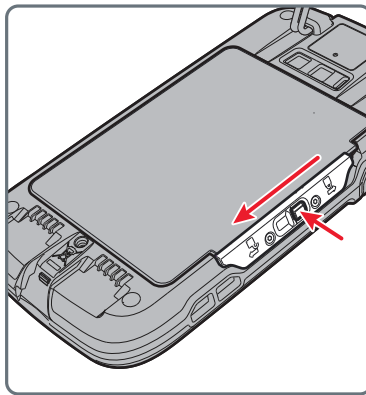

- 7 Lift up on the edge of the battery and remove it from the computer.

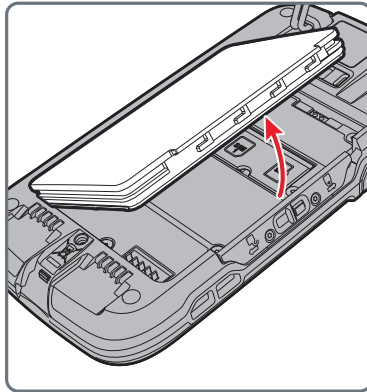





- 8 Insert the charged battery into the computer.
- 9 Press in on the battery door and slide it into the locked position.

About the Battery Status

Use the battery icon in the Status bar to see the power status of your battery. The table below only includes some of the icons. The icon actually goes from 100 percent all the way down to 15 percent? If you want more detailed information on your battery, such as usage time or charge remaining on the battery, go to **Settings > Battery**.

Battery Status Icons

Icon	Status
	The battery charge is at 100%.
	The battery charge is at 50%.
	The battery is critically low. You need to replace the battery now.
	The computer is connect to external power and the battery is charging.
??	There is a battery error. Install another battery. If the problem persists, call Honeywell Product Support.

The Battery status LED in the upper right corner of the computer indicates the charging status of the battery.

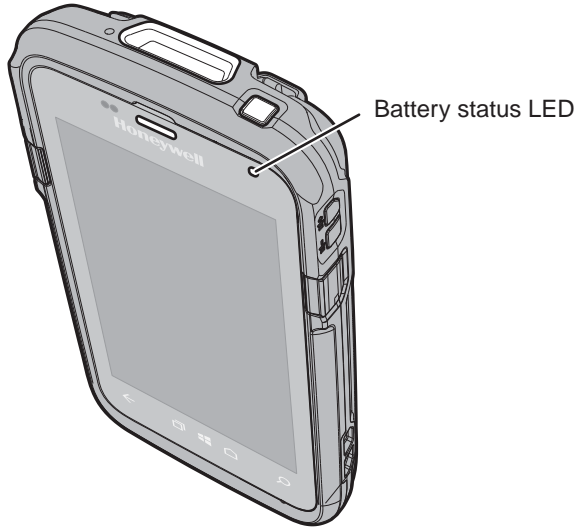

Battery Status LED Descriptions

LED State	Description
Steady green	The computer is connected to a charger and the battery is more than 95% charged.
Steady red	The computer is connected to a charger and the battery is less than 95% charged.
Blinking red	The battery is very low. The computer will soon go into Suspend mode. Charge or replace the battery.
Amber	There is a battery error. The battery is not charging because it is missing, faulty, or outside the allowable charging temperature range. If it is outside the charging temperature range, charging will resume when the battery temperature returns to the acceptable range of 0 °C to 45 °C (32 °F to 113 °F).
Off	The computer is not connected to external power and the battery is operating normally.

Check the Battery Level

In addition to the Battery status icons and the Battery status LED, you can get the battery status from the Settings app.

- 1 Tap the Settings app.
- 2 Tap **Battery**. The current percentage of battery power remaining and the amount of usage time left on the battery appear on the screen. A list shows the battery usage for individual apps and services.

For usage details, tap one of the apps or services in the list.

About Battery Life and Conservation

If you store the batteries outside of the computer for long periods of time, they slowly discharge. Honeywell recommends storing the battery in a charger to maintain battery performance.

Battery Conservation Tips

When You Want to:	Do this to Save Battery Power:
Use the computer and the low battery status icon appears or the battery light turns on.	Connect the computer to an external power source. Press and hold the Power button and then select Power off from the menu. After the computer turns off, remove the battery and insert a fully charged battery.
Stop using the computer for 5 minutes or more.	Make sure that the low battery status icon is not on the screen and that the battery status LED is not on. Press the Power button to suspend the computer.
Store the computer for more than a day.	<ul style="list-style-type: none"> • If you are storing the computer for a few days (such as over the weekend), install a charged battery or connect the computer to a power source. • If you are storing the computer for a longer period of time, remove and charge the battery. When the battery is done charging, store both the battery and the computer in a cool location. • If you store the battery for several months, recharge the battery periodically to keep it at peak performance.
Store the battery outside of the computer.	Store the batteries in a charger.

Battery Recommendations and Safety Precautions

- Charge the battery before use. Battery ships with a partial charge only.
- See “**Charge the Battery**” on page 6 for approved charging methods. Use of this battery in other devices could result in damage to the device or battery.
- The temperature range for charging this battery is 0 °C to 45 °C (32 °F to 113 °F). Do not charge this battery outside of this range. For maximum battery life, charge at 23 °C (73 °F).
- Do not store the battery at temperatures above 60 °C (140 °F), such as inside a car on a hot day or in direct sunlight. Storage above 60 °C (140 °F) may damage the battery.
- Avoid dropping the battery or computer. If you suspect that the battery or computer is damaged, send it to Honeywell service center for inspection.
- Replace this battery only with another model CT50-BTSC battery. These batteries have been tested in accordance with applicable safety standards. Contact your Honeywell sales representative or distributor if this battery is no longer available.
- Discarded batteries may create a safety hazard. Before disposal, cover the battery contacts with electrical insulating tape.
- Do not modify the battery or attempt to insert foreign objects into it.
- Do not solder directly to the battery contacts.
- Do not short circuit the battery, and keep it away from metallic items.
- Do not drop the battery or apply mechanical shocks or pressure to it.
- Do not disassemble or open, crush, bend or deform, puncture, shred or burn the battery.
- Do not immerse the battery in water or get the battery wet.
- Battery usage by children should be supervised.

Enable Airplane Mode

If you do not need to connect to any wireless networks, you can enable Airplane mode to turn off all the radios and save battery power.

- 1 Tap the Settings app.
- 2 In the Wireless & Networks section, tap **More**.
- 3 Select the **Airplane mode** check box to enable it.

Power On the CT50

The first time you power on the CT50, a Welcome screen appears. Follow the prompts on the Welcome screen as the setup wizard helps you:

- set the default language for the CT50.
- set up the Wi-Fi network connections.
- set the time, date, and time zone.
- personalize (name) the CT50.

After you have fully charged and installed a battery, power on the CT50 for the first time:

- Press and release the **Power** button.



Note: Once you complete the Setup Wizard, the Welcome screen no longer appears when you power on the CT50. You will now see the Lock screen each time you power it on.

Unlock the Screen

Every time you power on the CT50, you will need to unlock it.

- Drag the lock toward any edge of the screen to unlock it.

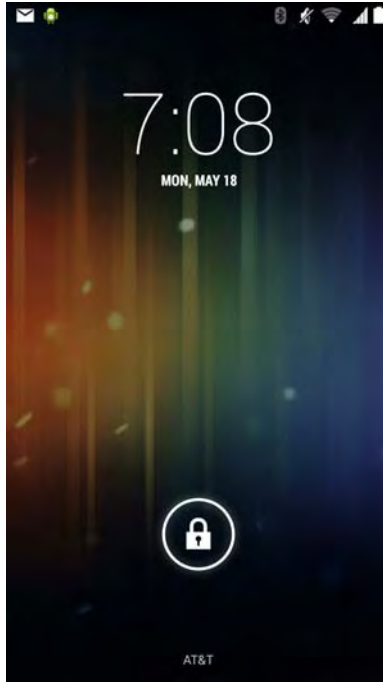

After you start using the CT50, you should set a password to protect the computer. Tap **All Apps** > **Settings** > **Security**.

About the Good Read LED

The Good Read LED indicates the status of the scanner. For more information on how to scan bar codes, see [“Scan a Bar Code” on page 42](#).

Good read LED



Good Read LED Descriptions

LED Color	Description
Green	Good read of a bar code.
Blinking red	Bad read of a bar code. Include information on what you should do? Bad bar code?
Blinking green	The data collection engine is processing or starting up.

Configure the Screen Backlight

The display has an ambient light sensor that automatically adjusts the backlight intensity to conserve power and ensure the display is readable. You can set the backlight intensity level as needed for your environment.

- 1 Tap the Settings app.
- 2 Tap **Display > Brightness**.
- 3 Tap AUTO to use the ambient light sensor to automatically adjust the brightness for your work environment.

Or, adjust the slider to set the brightness level.

About the Audio Features

The CT50 has a speaker, a microphone, and several software tools for configuring the volume of sounds.

Adjust Ringtone and Notification Volume

You can quickly adjust the volume of ringtone and notification sounds by using the side volume buttons.



Note: This method of adjusting the volume only affects the volume of ringtone and notification sounds. To change the volume for other sounds, open the Settings app and tap **Sound > Volumes**.

- 1 Press one of the buttons on the right side of the computer. The Volume slider appears.

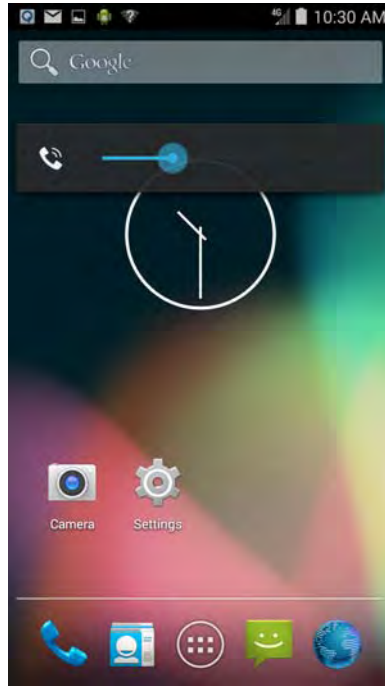



- 2 Press the buttons or adjust the slider to change the volume.

Enable Vibrate Mode

You can switch to Vibrate mode and disable the speaker if necessary for your working environment.

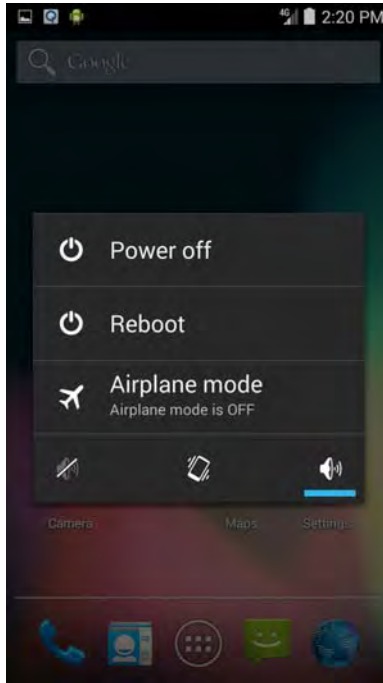
- 1 Press and hold the Power button. The power options screen appears.



- 2 Tap  to turn on Vibrate mode.

Audio Settings

This section describes the audio and sound settings you can configure in the Settings app. To change audio settings, start the Settings app and tap **Sound**.

Audio and Sound Settings

Setting	Description
Volumes	Use the sliders to set the volume for: <ul style="list-style-type: none">• music, video, games, and other media.• ringtone and notifications. You can also use the side volume buttons to change the volume.• alarms.
Phone ringtone	Select a ringtone.
Vibrate when ringing	Select to enable vibrate mode when the phone is ringing.
Default notification sound	Select a notification sound.
Dial pad touch tones	Select to enable audio tones when you use the phone keypad.
Touch sounds	Select to enable audio sounds when you use the touch screen.
Screen lock sound	Select to enable an audio tone when the screen is locked.
Vibrate on touch	Select to enable vibrate mode when you touch the screen.

Insert a microSD Card

You can use a microSD card to increase file storage capacity or to install software. Honeywell recommends the use of Single Level Cell (SLC) industrial grade microSD or microSDHC memory cards with the CT50 computer for maximum performance and durability.



Note: Format memory card before initial use.

- 1 Power off the computer.
- 2 Disconnect the handstrap from the bottom of the computer.

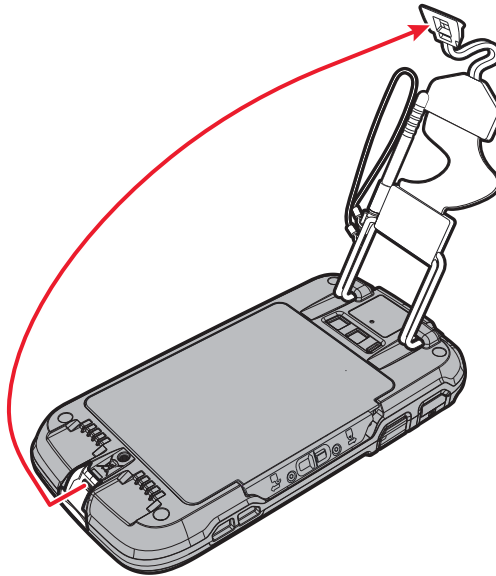

- 3 Press and slide the battery door toward the bottom of the computer to unlock the door.

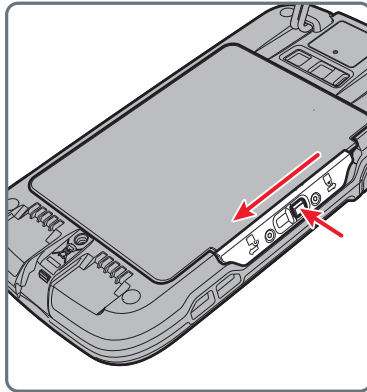

- 4 Lift up on the edge of the battery and remove it from the computer.
- 5 Press down on the SD card door and slide it toward the top of the computer to open it.

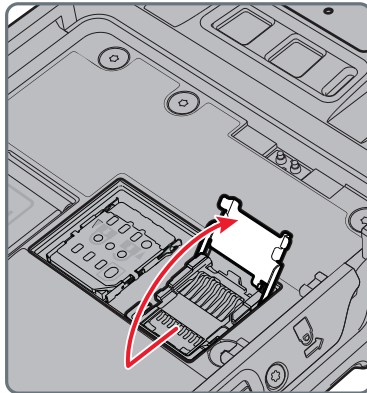

- 6 Insert the SD card into the door.

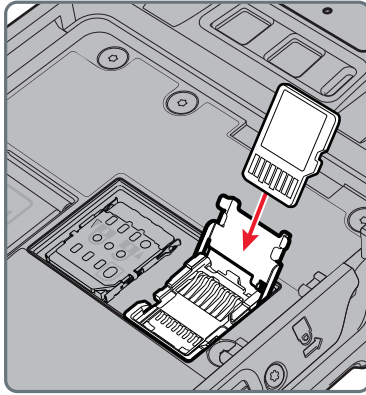

- 7 Press down on the SD card door and slide the door toward the bottom of the computer to lock it.
- 8 Insert the battery into the computer.
- 9 Press in on the battery door and slide it into the locked position.
- 10 Replace the handstrap.

How to Transfer Files

You can transfer files between your desktop PC and the CT50 with the HomeBase or USB adapter and a standard USB cable. When the computer is connected through USB, you can browse to it and drag-and-drop to move files back and forth to a Windows PC. If you are transferring files to and from a Mac, use the Android File Transfer application (available from www.android.com/filetransfer).

By default, the computer connects using MTP (Media Transfer Protocol). If you are transferring mainly camera images, you can configure the connection to use PTP (Picture Transfer Protocol). If your Windows PC does not support MTP, you may be able to transfer files using PTP instead.



Note: The CT50 supports Hi-Speed USB communications (USB 2.0) with a maximum data transfer rate of 480 Mbps.



- 11 Connect the CT50 to your PC.
- 12 On the CT50, select either **Connected as a media device (MTP)** or **Camera (PTP)**. The CT50 stores your selection as the default.
- 13 Browse to the CT50 from your PC. You can now copy, delete, or move files between the CT50 and your PC.

How to Browse Files on the CT50

You can use the File Browser application in Power Tools to browse the files on the CT50 and the microSD card.



Note: Due to system permissions, some file cannot be opened. Depending on the associated application, a choice of applications may be available to open the file.

- 1 Touch **All Apps** > **Power Tools**  > **File Browser** .
- 2 Touch a folder name or file name to open it.

Accessories for the CT50

The CT50 with a battery. All other accessories are ordered and shipped separately. For help, contact your local sales representative.

CT50 Accessories and Descriptions

Accessory	Description
CT50 Battery (Model CT50-BTSC)	The battery provides hours of power to the CT50. You may want to purchase spare battery packs for longer shifts.
eHomeBase	Use the eHomeBase to hold a CT50 with its battery installed, charge a spare battery pack, charge the main battery pack, and provide power to the mobile computer. The dock has USB host and client connectors as well as an Ethernet connector.
ChargeBase	The CT50 ChargeBase is a 4-slot charging cradle that can power four computers, and charge their main batteries in 6 hours.
NetBase	The Net Base enables up to four CT50 computers to communicate with a host device over an Ethernet network. The Net Base also provides a second RJ45 Ethernet port for connection to an additional device such as a printer, workstation, or another Net Base.
Vehicle Power Adapter	Use the vehicle power adapter to charge the battery installed in the CT50 from the accessory port in your vehicle.
Vehicle Dock	Use the vehicle docks to hold and charge the CT50 while using it on a vehicle.
Quad Charger	Use the quad charger to charge up to 4 batteries.
USB Adapter	Use this snap-on adapter to provide USB host and client communications through the CT50.

CT50 Accessories and Descriptions

Accessory	Description
DEX Adapter	Use this snap-on adapter to provide a DEX connector for the CT50.
Scan Handle	Attach to a CT50 to have an easy way to grip the computer and scan labels.
Holster	Use the holster to carry the CT50 hands-free in the work environment.
Screen Protector	Use the screen protector to keep the touchscreen free of scratches and dirt.

DRAFT

2

About the User Interface and Applications

Use this chapter to learn about the Android user interface and how to interact with the screen. You can also use this chapter to learn about the Honeywell applications on the computer.

About the User Interface

The Android 4.4 operating system provides a touch-friendly and easy to navigate user interface.

About the Home Screen

When you turn on the mobile computer, the Home screen is the first screen that appears after language provisioning is complete.

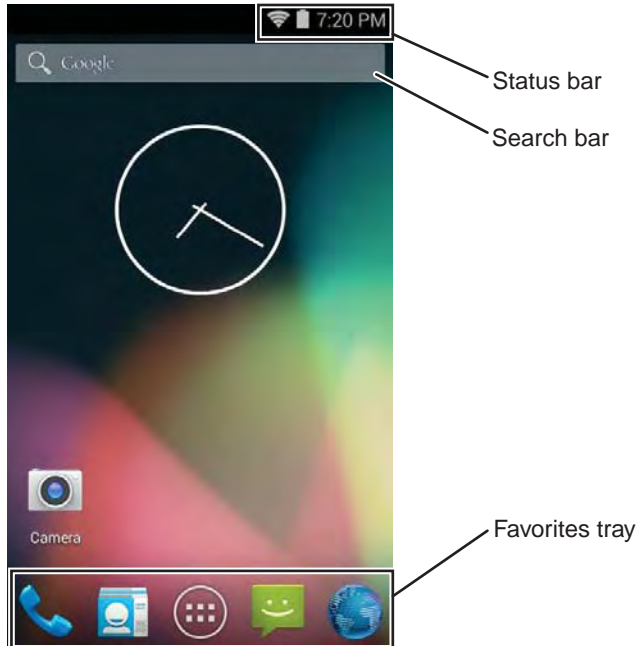





Understand the Home Screen

Item	Description
Status bar	Status icons to the left tell you when an app has sent notifications, such as an arriving message or a meeting notice. System icons to the right display the current wireless and network connection state and battery level.
Favorites tray	App icons in the tray are visible on every Home screen. The All Apps icon is always in the center of the Favorites tray.
Search bar	Search the internet or the computer using Google.

Navigation and Function Buttons

There are navigation and function buttons below the Favorites tray on the front panel of the CT50.

Navigation and Function Buttons

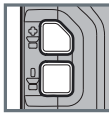
Button	Description	Function
	Back	Takes you back to the previous screen.
	Recent Apps	Lets you view and switch between recently used apps.
	Home	Returns you to the Home screen
	Search	Starts a search on the computer or the internet.
	Volume	Raises or lowers the volume of the speaker.

Common Status and Notification Icons?

Should I include a table with the icons and descriptions here?

Remap a Button

You can change the default function of the Left Scan, Right Scan, or Camera buttons.

- 1 Tap **All Apps** > **Settings** > **Key remap**.
- 2 Touch to button you want to remap.
- 3 Tap **KEYS** or **APP** to view the available functions.
- 4 Select the function you want to assign to the button. The function you selected now appears under the button name.

View Notifications

You can view the notifications shade to see a list of events on the CT50.

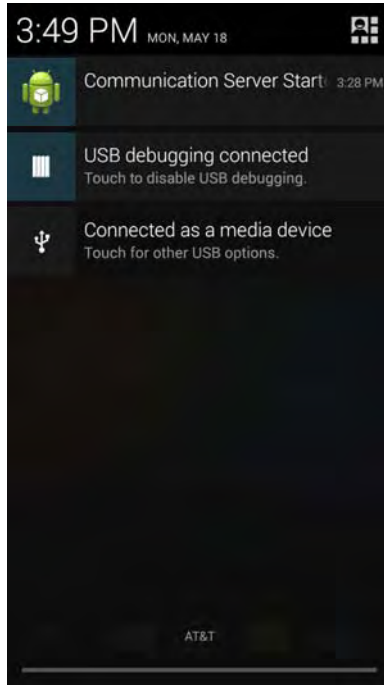

- To open the shade, swipe down from the top of the screen.
- To close the shade, swipe up from the bottom of the screen, or tap the Back or Home buttons.

Manage Notifications

When an app sends a notification to the CT50, you can easily respond to it.

- 1 When a notification icon appears, swipe down from the top of the screen.
- 2 To respond to a notification, touch it. The associated app opens so that you can respond.
 - To dismiss a notification, swipe it sideways.
 - To dismiss all notifications, tap the X in the top right corner.

Customize the Home Screen

You can add application icons to any Home screen to access them more easily.

- 1 Touch . The All Apps screen appears.
- 2 To add an app icon to a Home screen, touch and hold the icon for the app, and then slide your finger to place the icon on one of the Home screens.

To add a widget icon to a Home screen, touch **WIDGETS** at the top of the screen, touch and hold the icon for the widget, and then slide your finger to place the widget icon on one of the Home screens.

- 3 To remove an app or widget from the Home screen, touch and hold the icon and slide it over **Remove** at the top of the screen.

Customize the Favorites Tray

You can add application icons to the Favorites tray to access them more easily.

- 1 Touch . The All Apps screen appears.
- 2 Touch and hold an icon in the Favorites tray, and slide it over **X Remove** at the top of the screen.
- 3 To add an app icon to the Favorites tray, touch and hold the icon for the app, and then slide your finger to place the icon in the Favorites tray.

To add a Widget icon to the Favorites tray, touch **WIDGETS** at the top of the All Apps screen, touch and hold the icon for the widget, and then slide your finger to place the icon in the Favorites tray.

Use Google™ Search

Use the Google Search field at the top of the Home screen to help you find anything you need on the computer or on the web.

- 1 At the top of any Home screen, touch **Google** to type your search term. As you type, suggestions from Google web search appear below the Search box, and results from the computer (such as apps or contacts) appear below the web search results.
- 2 Tap a suggestion to search for it immediately, or touch its arrow just to add the term to the search field without starting to search.

About Screen Gestures

Use your fingers or the stylus to manipulate icons, buttons, menus, the onscreen keyboard, and other items on the screen.

- To select or activate something, tap it.
- To type something, such as a name or password, touch where you want to type. A keyboard appears that lets you type into the field.

Other common gestures include:

- **Touch and hold:** Touch and hold an item by touching it and lifting your finger until an action occurs.
- **Drag:** Touch and hold an item for a moment. Without lifting your finger, move your finger on the screen until you reach the target position. For example, you can drag to reposition shortcuts on the Home screen.
- **Swipe or slide:** Quickly move your finger across the screen, without pausing when you first touch. For example, you can slide a Home screen left or right to view the other Home screens.
- **Double-tap:** Tap quickly twice on a web page, map, or other screen to zoom in. Double-tap again to zoom out.
- **Pinch:** In some apps, you can zoom in and out by placing two fingers on the screen at once and pinching them together (to zoom out) or spreading them apart (to zoom in).

Set the Time Zone

The CT50 gets the current date and time from its network connection. You can manually set the time zone for your location.

- 1 Start the Settings app.
- 2 Tap **Date & time**.
- 3 Clear the check box for **Automatic time zone**.
- 4 Tap **Select time zone** and select the time zone for your location.

About Honeywell Applications

Should I add anything about Power Tools or Demos here?

Or maybe applications that might be on the product like Launcher for Android?

Can you download HTML5 Browser?

DRAFT

3

About the Scanner

Use this chapter to understand how to scan bar codes and how to configure the scanner.

About the Scanner

The internal scanner can read 1D and 2D bar code symbologies, composite symbologies, and postal codes. It also supports omnidirectional scanning for greater flexibility in real-world settings. The image engine can also capture black and white images, such as signatures and pictures of damaged inventory.

How to Send Data as Android Keyboard Input

The scan wedge feature sends scanned bar code data to an active application as Android keypad input. By default, scan wedging is enabled on the CT50 computer. You can use applications that are coded to use the scanner or applications that receive data through the scan wedge feature. If an application claims the scanner through the BarcodeReader API, the scan wedge feature is temporarily disabled. You can find information on how to create custom applications for the CT50 in the *Software Development Kit (SDK)* available for download at www.honeywellaidc.com.

Use this table to understand the settings associated with each step in the scan data process.

Scan Data Processing and Settings

Process Step	Associated Scan Setting	
Decode bar code.	Symbology Settings	
Interpret bar code as ISO8859-1.	Symbology Settings	
Detect special bar codes and implement specific action instead of normal processing.	Data Processing Settings	Launch Browser Scan to Intent Launch EZConfig
<ul style="list-style-type: none"> • URL bar code starts browser • Scan-to-Intent starts an application • EZConfig bar code starts EZConfig 		
Convert to selected character set.	Data Processing Settings	Charset

Scan Data Processing and Settings

Process Step	Associated Scan Setting	
Attach Prefixes and Suffix. The data string is composed in the following order: <ul style="list-style-type: none"> • Prefix • Symbology prefix • Bar code data • Suffix Interpret substitutions of the Prefix and Suffix strings.	Data Processing Settings	Prefix Symbology Prefix Suffix
Activate a Total Freedom plugin.	Data Processing Settings	Data Editing Plugin
Inject the final data string as Android KeyEvents.	Data Processing Settings	Wedge

Substitutions occur within the Prefix and Suffix string values.

Prefix and Suffix Interpretation

Substring	Replacement Character Code	Wedged as a KeyEvent
\r	13	No
\n	10	Yes
\t	9	Yes
\\	'\'	No

Change the Scanner Settings

Changes you make to the Default profile apply to all applications with no profile.

- 1 Tap the Settings app.
- 2 Tap **Scanning**.
- 3 Tap **Default**.
- 4 Select Data Processing Settings, Symbology Settings, Imager Settings, Trigger Settings, or Notification Settings.
- 5 Modify the settings to meet your application needs.

Restore Default Scanner Settings

You can easily discard all changes you made to the Default profile and restore the default values.



Note: When you select to restore the default values of one of the settings, it also restores the default values of all settings within the profile.

- 1 Tap (insert graphic of three dots) in the upper right corner of any of the scan settings screens.
- 2 Tap **Restore all defaults**.

Scanners Default Settings

Use these tables to understand the Data Processing Settings, Symbology Settings, Imager Settings, Trigger Settings, and Notification Settings.

Data Processing Settings

Use the Data Processing Settings to specify how bar code data is processed by the CT50.

Data Processing Settings

Setting	Description	Default
Wedge	Enable or disable sending the bar code data as Android KeyEvents when sending data to the active application.	Enabled
Charset	Select the character set to use when interpreting the bar code data into a string. Options include: <ul style="list-style-type: none"> • ISO-8859-1 • US-ASCII • UTF-16 • UTF-16BE • UTF-16LE • UTF-8 Corresponds to BarcodeReader property: PROPERTY_DATA_PROCESSOR_CHARSET	ISO-8859-1
Prefix	Defines the string added before the decoded bar code data.	None
Suffix	Defines the string added after the decoded bar code data.	None

Data Processing Settings (continued)

Setting	Description	Default
Data Editing Plugin	Specify a Total Freedom data editing plug-in.	None
Symbology Prefix	Specify a symbology identifier prefix to the bar code data. Options include: <ul style="list-style-type: none"> • None • Honeywell • AIM 	None
Launch Browser	Enable or disable URL bar code handling. If a bar code starts with http:// or https://, the browser opens using the bar code data as a URL. Corresponds to BarcodeReader property: PROPERTY_DATA_PROCESSOR_LAUNCH-BROWSER	Enable
Scan to Intent	Enable or disable special handling of scan-to-intent bar codes. Applies to bar codes in one of the following formats: ‘//’ ACTION ‘//’ intent-suffix ‘\$’ extra-data Where: ACTION and extra-data are any string of characters. Launches an application listening for the intent: Intent action: “com.honeywell.scantointent.intent.action.” + ACTION Intent extra “com.honeywell.scantointent.intent.extra.DATA” contains the remainder of the bar code data after the first ‘\$’ character. Corresponds to BarcodeReader property: PROPERTY_DATA_PROCESSOR_SCAN_TO_INTENT	Enabled
Launch EZ Config	Enable or disable special handling of EZConfig bar codes. Applies to EZConfig bar codes, which are encoded with the Aztec symbology and containing specific header data. Corresponds to BarcodeReader property: PROPERTY_DATA_PROCESSOR_LAUNCH_EZ_CONFIG	Enabled

Symbology Settings

Use the Symbology Settings to enable and disable bar code symbologies. Tap a symbology to view and modify the symbology configuration parameters.

Symbology Settings

Setting	Default
Code 128	Enabled
GS1-128	Enabled
Code 39	Enabled
Datamatrix	Enabled
UPC-A	Enabled
UPC-E	Disabled
EAN-8	Disabled
EAN-13	Enabled
Aztec	Enabled
China Post	Disabled
Codabar	Enabled
Codablock A	Enabled
Codablock F	Disabled
Code 11	Disabled
Code 93	Disabled
Composite	Disabled
Han Xin	Disabled
IATA 2 of 5	Disabled
Interleaved 2 of 5	Enabled
Korean Post	Disabled
Matrix 2 of 5	Disabled
Maxicode	Disabled
Micro PDF 417	Disabled
MSI	Disabled
PDF 417	Disabled
QR Code	Disabled
RSS (GS1)	Disabled
Standard 2 of 5	Disabled

Symbology Settings (continued)

Setting	Default
Telepen	Disabled
TLC 39	Disabled
Trioptic	Disabled
2D Postal Settings	Disabled
OCR	Disabled

Imager Settings

You should not need to modify the Imager Settings. The Override Recommended Values setting is disabled by default. The recommended Imager Settings are designed to work in a wide range of environments and should only be modified if you have an advanced understanding of imagers.

Trigger Settings

Use the Trigger Settings to configure how the scan buttons work.

Trigger Settings

Setting	Description	Default
Decode Timeout	Scanning automatically turns off after this number of seconds if the scan trigger is pressed and nothing has successfully decoded.	20

Notification Settings

Use the Notification Settings to configure how your CT50 responds when you scan a bar code.

Notification Settings

Setting	Description	Default
Good Read Notification	Enables or disables a good read notification. The notification consists of a green blink of the Good Read LED, a short beep, and an optional short vibration.	Enabled

Notification Settings

Setting	Description	Default
Bad Read Notification	Enables or disables notification of a failed scan. The notification consists of a red blink of the Good Read LED, an error beep, and an optional short vibration.	Disabled
Vibrate Enabled	Enables or disables whether the computer vibrates when there is a good or bad read.	Disabled

Scan a Bar Code

The scanner has an aiming beam to help you correctly frame bar codes. It also supports omni-directional (360°) scanning to make it easier for you to scan bar codes.



Note: Before you start scanning bar codes, use the Settings app to enable only the bar code symbologies that you need.

- 1 Point the scanner window at the bar code and hold the computer steady a few inches from the label.
- 2 Press one of the **Scan** buttons. The illumination frame appears.

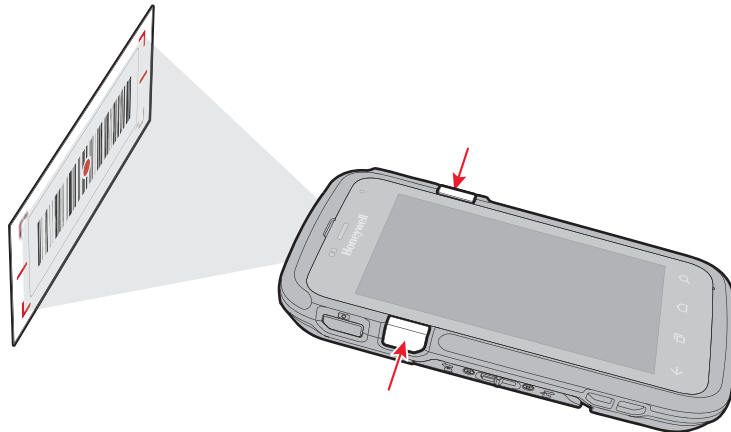

Make sure the entire bar code is inside of the frame. When the scanner successfully reads a bar code, you hear a high beep and the Good Read LED turns on briefly.

- 3 Release the **Scan** button.

4

Use the Phone

You can use the phone feature to make and receive phone calls as well as transmit data through wireless wide-area networks (WWANs).

About the Phone

Phone features on the computer include a speaker and a microphone. You can also use a Bluetooth headset or hands-free kit. The phone feature is enabled by default.

The WAN radio in your computer determines the supported network types:

- If your computer includes the UMTS/HSPA+ WAN radio, you can connect to UMTS networks.
- If your computer includes the Flexible Network Radio, you can connect to CDMA or UMTS networks in all regions that support these technologies. The Flexible Network Radio is a software-defined radio (SDR) that can be configured for CDMA or UMTS depending on your wireless communication needs.

Honeywell supports these CDMA network carriers:

- Sprint (United States only)
- Verizon (United States only)

For other carriers, contact Honeywell Technical Support.

After you turn on the phone and activate service with your wireless carrier, you can customize the phone features and network settings in the Wireless & Networks section of the Settings app.



Note: Both WWAN radios support Network Information and Time Zone (NITZ) messages to automatically set the system time.

Activate the UMTS Phone

Activating the UMTS phone on your CT50 is done the same way whether your computer has the Flexible Network Radio or the UMTS/HSPA+WAN radio.

You use a SIM card to activate the UMTS phone on the CT50. You can purchase the SIM card from your network provider.

- 1 Power off the CT50.
- 2 Disconnect the handstrap from the bottom of the computer.
- 3 Press and slide the battery door toward the bottom of the computer to unlock the door.
- 4 Lift up on the edge of the battery and remove it from the computer.

- 5 Lift up on the SIM and MicroSD door.

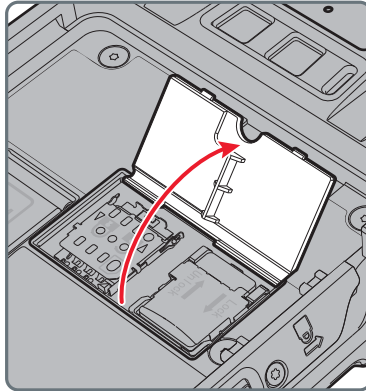

- 6 Press down and slide the SIM door toward the top of the CT50 to open it.

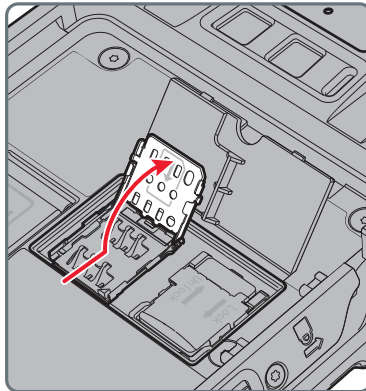

7 Insert the SIM card in the door.

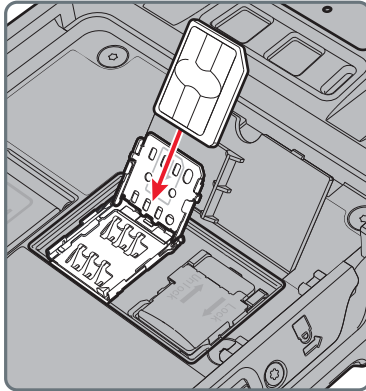

8 Close the SIM card door and slide it toward the bottom of the CT50 to secure it.

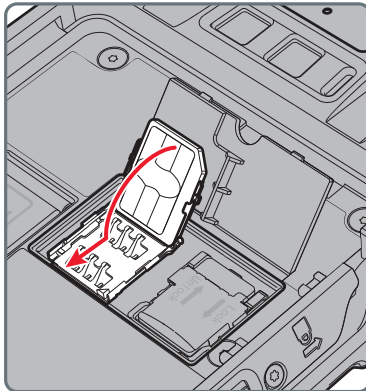

9 Replace the battery, reconnect the handstrap, and press the Power button to turn on the CT50. The phone is now ready to use.

Activate the CDMA Phone

To activate the CDMA phone in your mobile computer, you need to contact your wireless carrier and set up an account.

You also need to provide the carrier with the Mobile Equipment Identifier (MEID) for the computer. You can find the MEID:



- on a label located in the battery compartment.
- on the outside of the computer shipping box.



Note: For the CDMA phone, settings are permanently stored in the WWAN radio after activation. CDMA settings persist through a factory data reset.





The activation process is slightly different for each CDMA carrier. Your carrier sales contact and an Honeywell representative can guide you through the process. In general, you activate the CDMA phone as follows:

- 1 Contact your wireless provider and give the provider the MEID for the computer.
- 2 If your carrier is Sprint, reboot the computer. As soon as the Sprint network detects your phone, Hands-Free Activation (HFA) begins, and a series of notification messages appear. When activation is complete, a completion message appears and the WAN radio reboots. The phone is ready to use.

If your carrier is Verizon, tap , enter *228 on the phone keypad, and tap . After a short wait, a message appears, confirming either success or failure of the activation. After successful activation, the phone is ready to use.

Make a Phone Call



Once the phone is activated, you can make a phone call.

- 1 On the Home or All Apps screen, tap .
If the Phone app opens to a list of numbers instead of the keypad, swipe left or touch  to return to the keypad.
- 2 Touch the keys to enter the number, and then touch  below the keypad to dial.
- 3 To end a call in progress, tap .

Answer the Phone

When you receive a phone call, the Incoming Call screen opens, showing the caller ID. All incoming calls are recorded in the Call log. If you miss a call, you receive a notification.

When a call arrives, touch the white phone icon and slide over one of the icons:

- To answer the call: 
- To send the call to voicemail: 
- To send a message from a list of default text messages: 

Switch Apps During a Phone Call

You can switch apps while a phone call is in progress. For example, you can use the People app to look up contact information during your call.



Note: If you have only a WWAN connections, apps that need a data connection may be unable to access online data while the phone call is in progress. If simultaneous phone calls and stat connections are not possible due to provider limitations, voice calls receive priority. Check with your provider for more information.

- During a phone call, tap another app icon on the Home or All Apps screen to run that application. The green Phone icon appears in the Status bar while the call is underway.

Check Your Voicemail

When you have a new voicemail message, the voicemail icon appears at the top left of the screen.



Note: Consult your service provider for more information on setting up your voicemail account.



- 1 Swipe down from the top of the screen to view your notifications. The voicemail notification shows the number of unread messages and a number to dial.
- 2 Touch **New voicemail**. The phone dials the number. Follow the instructions to retrieve your messages.

Set Your Voicemail Number



To access your voicemail, you must set your voicemail number in the Phone app.



Note: This procedure does not apply if you are a Verizon customer.

- 1 Tap .
- 2 Tap  and then tap **Settings**. A list of call settings appears.
- 3 Tap **Voicemail > Setup > Voicemail number**.
- 4 If you are a Sprint customer, delete “*86” from the entry field and enter your voicemail number.
If you are an AT&T customer, enter your voicemail number.
- 5 Tap **OK**.

Change Voicemail Settings



- 1 Tap  on a Home or All Apps screen.
- 2 Tap  and then tap **Settings**.
- 3 Tap the voicemail setting you want to change.

Make an Emergency Phone Call

You can use the phone to make an emergency phone call, even if the SIM card is missing from your UMTS phone or if you do not have a valid CDMA account. In either case, the phone shows that you have no service. However, if you dial certain emergency numbers (such as 112, 911, 000, 08, 118, 119, or 999) the call will go through.

Configure Phone Settings

You can customize settings for the phone, including the ringtone, voicemail options, keypad tones, internet call settings, and other options.

- 1 Tap .
- 2 Tap  and then tap **Settings**. The Call settings menu appears.
- 3 Change phone settings as necessary.

5

Use the Camera

Use this chapter to learn how to take pictures and record videos with the color camera.

About the Color Camera

The CT50 contains an 8-megapixel color camera for taking pictures and videos. The camera and flash are located on the back of the computer.

Use the Gallery app  to view photos and videos stored on the CT50.

Adjust the Camera and Video Settings

The camera and video settings are adjustable from within the **Camera** app.



How to Zoom

The camera zoom is controlled using a pinching motion on the touch screen. Place two fingers on the screen at the same time, and then:

- spread them apart to zoom in (enlarge and object).
- pinch them together to zoom out.

Change Camera Settings

You can change the camera settings for best results when taking pictures.

- 1 Press the **Camera** button and then tap .
- 2 Tap .
- 3 Tap HDR or one of the icons  to change basic camera settings.
 - When HDR is enabled, the computer automatically captures multiple photos and combines them into one photo creating the best quality image possible.
 - Enable or disable different options such as scene mode, store location, and picture size.

Take a Picture





- 1 Press the **Camera** button or tap All Apps and then tap Camera .
- 2 Using the screen as a viewfinder, move the computer until you see the image you want to capture.
- 3 Tap the screen to set the focus. By default, the camera senses the lighting in the environment and turns the torch on if needed.

(Optional) To zoom in or out, drag the slider at the bottom of the viewfinder.

- 4 Press **Enter** or the shutter button . The camera takes a picture and a thumbnail image of the picture appears in the corner of the screen.
 - To view the picture, tap the thumbnail image.
 - To return to the Camera app, swipe the thumbnail image to the right.





Record a Video

This section explains how to record video with the camera in the computer.

- 1 Press the **Camera** button or tap All Apps and then tap Camera .
- 2 Tap .
- 3 Tap  to begin recording video. To zoom in or out, drag the slider at the bottom of the viewfinder.
- 4 When you are done recording, tap .

Change Video Settings

You can change the camera settings for best results when recording video.

- 1 Press the **Camera** button or tap All Apps and then tap Camera .
- 2 Tap .
- 3 Tap .
- 4 Tap .
- 5 Tap one of the icons  to change basic video settings.

6

Configure the Computer

Use this chapter to learn how to configure the CT50. You will also find information on how to configure network communications and wireless security.

How to Configure the Computer

You can configure many parameters on the computer such as the bar code symbologies it decodes, or the network settings. The values you set for these parameters determine how the computer operates.

You configure the computer using the Settings app.

Start the Settings App

The Settings app is located in the All Apps menu.

- Tap **All Apps > Settings**.

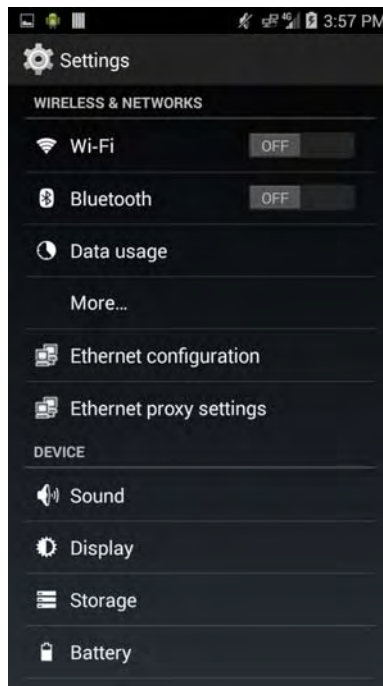

About the Structure of the Settings App

Use this section to learn about the structure of the Settings app so you can find parameters quickly.

Wireless & Networks

Setting	Description
Wi-Fi	Turns the Wi-Fi radio on and off. When Wi-Fi is turned on, tap the bar to see a list of Wi-Fi networks.
Bluetooth	Turns the Bluetooth radio on and off. when bluetooth is turned on, tap the bar to see a list of Bluetooth devices in range.
Data usage	Displays a list of phone data usage for the current data usage cycle. Tap the Data usage cycle list to select another date range.
More...	<p>Airplane mode: Turns airplane mode on and off.</p> <p>VPN: Sets the password parameters for a virtual private network (VPN).</p> <p>Mobile networks: Includes settings for mobile networks, including enabling data access and roaming over mobile networks, selecting access points and network operators, or selecting only 2G networks (to save battery life).</p> <p>Mobile plan: ??</p> <p>Cell broadcasts: Sets what emergency information you want to receive and how you want to receive it.</p>

Device

Setting	Description
Sound	Settings for the phone and notification sounds, including tones and volume.
Display	Settings for the display brightness, wallpaper, sleep timeout, font size, and screen auto-rotation.
Storage	Shows the remaining amount of storage.
Battery	Shows battery usage data and the current battery state.
Apps	Lists downloaded and running apps.

Personal

Setting	Description
Location	Turns location services (Google and GPS satellite data) on and off.
Security	Sets screen lock and administrator privileges.
Language & input	Selects the active language and default keyboard. Sets auto-typing features such as capitalization and punctuation. Adjusts the pointer speed for an external mouse or trackpad.
Backup & reset	Restores factory default settings.

Honeywell Settings

Setting	Description
Key remap	Remaps the Left Scan, Right Scan, and Camera buttons. For help, see “Remap a Button” on page 29 .
Smart sensors	Configures the integrated motion detection sensors for advanced power management.
Battery LED	Configures the battery LED behavior. Do I need to explain the difference in the choices? Does the battery LED work the same as the D75e?
Battery Health	View the current health of the battery.
Logger	Activates a logging service that creates an Android logcat log and kernel log for APP and system troubleshooting.
Scanning	Configures the CT50 imager. For help, see “Change the Scanner Settings” on page 37 .
Web applications	Enables the web interface settings and lets you set a port.

Accounts

Setting	Description
Add account	Adds a Corporate or Email account to the CT50.

System

Setting	Description
Date & time	Configures all date and time settings
Accessibility	Sets accessibility levels, such as larger display text and enabling text-to-speech output.
Printing	
Developer options	Enables developer-specific options such as USB debugging and SD card protection.
About phone	

About Network Communications

You can use the mobile computer in your wireless or wired data collection network. You can connect your computer using:



- 802.11 radio communications.
- Ethernet communications.
- Bluetooth communications.
- USB and serial communications.

Connect to a Wi-Fi Network

The CN51 has an 802.11 radio to transfer data using wireless communications. Before you connect to a Wi-Fi network, you need to know about your network security protocol and its required credentials. By default, the 802.11 radio is disabled.

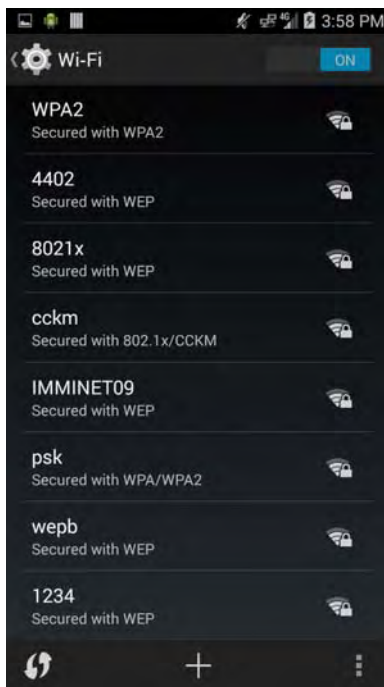
- 1 Start the Settings app and slide the Wi-Fi switch on.
- 2 When the switch turns blue, tap **Wi-Fi**. A list of discovered networks appears.



- 3 To quickly connect to a network through Wi-Fi Protected Access (WPS), tap . To search for a network not in the list, tap  and type the network name.
- 4 Tap a network name in the list to view details:

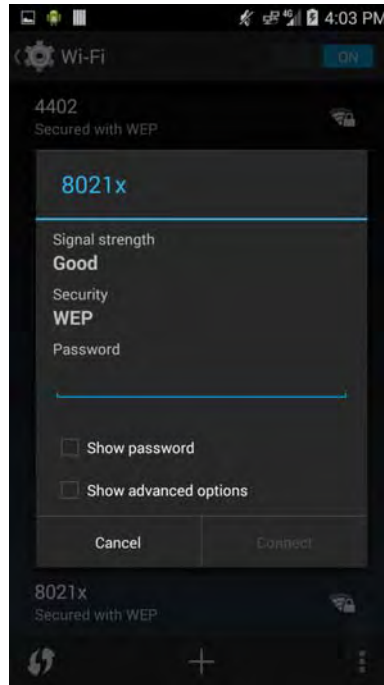

If the network is secured, a list of required information appears (such as a certificate name, a password, or other credentials). To connect to the secured network, enter the required information and tap **Connect**.

- To leave a connected network, tap **Forget**. For example, you could choose to forget a network you no longer use.
- To close the network details screen, tap **Cancel**.

Configure Proxy Settings for a Wi-Fi Network

If you need to connect to network resources through a proxy server, you can configure settings for the proxy server for each Wi-Fi network you add. By default, the Wi-Fi networks you add are not configured to connect through a proxy server.



Note: Proxy settings apply only to the Wi-Fi network you modify. You must change proxy settings for each network requiring a proxy server.

- 1 Open the Settings app and tap **Wi-Fi**. The list of available Wi-Fi networks appears.
- 2 Tap and hold the network name and then tap **Modify network**. A list of network settings appears.
- 3 At the bottom of the list of network settings, select **Show advanced options**.
- 4 If the network has no proxy settings, tap **None** in the Proxy Settings list, and then tap **Manual** in that list.
- 5 Enter the proxy settings for the network.
- 6 Tap **Save**.

Disable Wi-Fi Notifications

By default, when Wi-Fi is enabled, you receive notifications in the Status bar when the computer discovers a wireless network. You can disable these notifications.

- 1 Start the Settings app.
- 2 Tap and hold **Wi-Fi**.
- 3 Tap and then tap **Advanced**. The Advanced Wi-Fi menu appears.
- 4 Clear the **Network notification** check box to disable notifications.

Connect to an Ethernet Network

To connect the computer to an Ethernet network, you need an Ethernet dock.

- 1 Make sure the dock is connected to your Ethernet network.
- 2 Place the computer in the dock.
- 3 Start the Settings app and make sure Ethernet is enabled (Ethernet is enabled by default).

To enable Ethernet, slide the Ethernet switch on. When the switch turns blue, Ethernet is enabled.

- 4 Tap **Ethernet**. The Ethernet list shows the name of the current Ethernet connection. By default, the computer assumes a DHCP connection, and that your network has assigned an IP address automatically. If DHCP is working, the Ethernet dock should indicate that communication with the network is occurring.
- 5 (Optional) To assign a static IP address, tap the connection name (for example, eth0). The IP settings dialog box appears.
 - a Tap **DHCP** and then select **Static** from the list.
 - b Enter the required network information and then tap **Apply**.

How to Connect to Virtual Private Networks

The computer supports connecting to virtual private networks (VPNs). This section describes how to add and connect to VPNs. To configure VPN access, you must obtain details from your network administrator. You view and change VPN settings in the Settings app.



Note: Before you can access VPNs, you need to set a lock screen PIN or password.

Add a VPN

Before you can connect to a VPN, you must add VPN information.

- 1 Start the Settings app.
- 2 In the Wireless & Networks section, tap **More**.
- 3 Tap **VPN**.
- 4 Tap **Add VPN Profile**.
- 5 Enter information for the VPN.
- 6 Tap **Save**. The VPN name appears in the VPN list.

Connect to a VPN

- 1 Start the Settings app.
- 2 In the Wireless & Networks section, tap **More**.
- 3 Tap **VPN**.
- 4 Tap the name of the VPN in the list, and enter any necessary credentials when prompted.
- 5 Tap **Connect**. The computer connects to the VPN, and a Status icon and notification appear.

To disconnect from the VPN, tap the notification.

Edit VPN Information

- 1 Start the Settings app.
- 2 In the Wireless & Networks section, tap **More**.
- 3 Tap **VPN**.
- 4 Tap and hold the name of the VPN you want to edit, and select **Edit network** from the list.
- 5 Edit VPN settings as necessary.
- 6 When you are done, tap **Save**.

About Wireless Security

The computer provides these security solutions for your wireless network:

- Wi-Fi Protected Access 2 (WPA2™)
- Wi-Fi Protected Access (WPA)
- 802.1x
- LEAP
- WEP

Honeywell recommends WPA2 security with PSK (Personal) or 802.1x (Enterprise) key management.

Before you set security, you need to enable the radio, set the date, and set the SSID on your computer. To use 802.1x security, you need to load a root certificate on your computer. To use transport layer security (TLS) with 802.1x security, you also need to load a user certificate.

Use the Settings app to access and configure all wireless security settings.

About Certificates

You can use digital certificates to identify the computer for network access or authentication to servers. To use a certificate to identify your device, you must install it in the trusted credential storage on the computer.

Android supports DER-encoded X.509 certificates saved in files with a .crt or .cer file extension. To install a valid certificate with a .der or it. Android also supports X.509 certificates saved in PKCS#12 key store files with a .p12 or .pfx extension. To install a valid key store file with another extension, you must change the extension to .p12 or .pfx to install it. When you install a certificate from a PKCS#12 key store, Android also installs any accompanying private key or certificate authority certificates.

Load a Certificate

To use a certificate, you must install it in the trusted credential storage on the computer.



Note: Apps such as Email and Browser that support certificates allow you to install certificates directly from within the app. For more information, see the Help that comes with the app.

- 1 Copy the certificate or key store from your PC to a microSD card.
- 2 Install the microSD card in the computer and turn the computer on.
- 3 Start the Settings app and tap **Security > Install from SD card**.
- 4 Tap the name of the certificate or key store to install it. If prompted, enter the key store password and tap **OK**.
- 5 Enter a name for the certificate and tap **OK**.

Disable or Remove Certificates

If a certificate is compromised, or your organization chooses not to trust it, you can disable or remove it.

- 1 Start the Settings app and tap **Security > Trusted credentials**. The trusted credentials screen has two tabs:
 - **System** shows CA certificates that are installed in the ROM.
 - **User** shows CA certificates you have installed yourself.
- 2 Tap the name of the certificate to disable or remove. The certificate details screen appears.
- 3 Scroll to the bottom of the details screen and tap **Disable** (for System certificates) or **Remove** (for User certificates).

If necessary, you can enable a disabled System certificate from this location. If you remove a User certificate, you must install it again to enable it.
- 4 Tap **OK**.

About Bluetooth Communications

The CN51 is Bluetooth-enabled, which lets you connect to other Bluetooth devices.

You need to turn on the Bluetooth radio before you can discover and connect to Bluetooth devices. By default, the radio is turned off.

The Bluetooth radio maintains its current state through a system reset. If you perform a factory data reset, you must recreate pairings to devices.

The System bar icons indicate Bluetooth status.

Connect a Bluetooth Device

To connect to a Bluetooth device, you must enable Bluetooth and then select the device from a list of discovered devices.

- 1 Start the Settings app.
- 2 If Bluetooth is off, slide the Bluetooth switch on.
- 3 Tap **Bluetooth**. A list of available Bluetooth devices appears.



- (Optional) If the device you want does not appear in the list, make sure the device is turned on and discoverable, and tap **Search for devices**.
- Tap a device in the list to select it. If a pairing request message appears, enter the device PIN and tap **OK**. When the device is paired with the computer, the device name appears in **Paired Devices** at the top of the list.

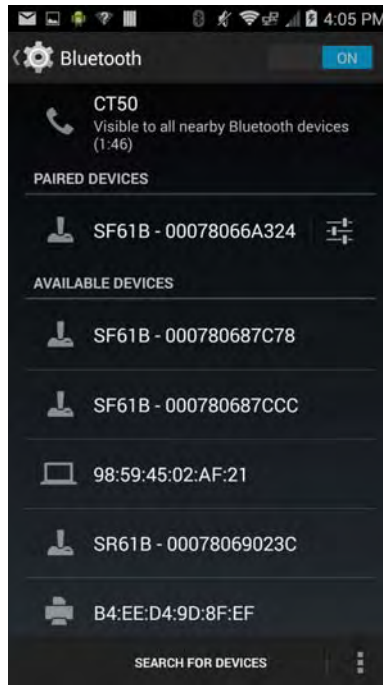

- To disconnect a paired device, tap the Quick Settings icon  next to the device name and then tap **Unpair**.

Configure Bluetooth Settings

You configure Bluetooth settings in the Settings app.

- 1 Start the Settings app and tap **Bluetooth**.
- 2 Tap the Menu icon  and select a setting from the menu:
 - Tap **Rename phone** to change the computer device name. Type the new name and then tap **Rename**.
 - Tap **Visibility timeout** to set the amount of time that the computer is visible to other Bluetooth devices. By default, the timeout is set to 2 minutes. You can select 5 minutes, one hour, or no timeout. Setting a shorter timeout value preserves battery life.
 - Tap **Show received files** to view statistics on the received files.

Making the CT50 Discoverable

By default, the CT50 is not discoverable, which means that the computer will not be found by other Bluetooth devices.

- 1 Tap **All Apps > Settings**.
- 2 Verify the **Bluetooth** radio is activated.
- 3 Tap **Bluetooth**.
- 4 Tap **CT50** (the default computer name) at the top of the screen to make the device discoverable. The computer starts a 2 minute count down during which time the computer is temporarily discoverable by other devices using Bluetooth technology.

Rename or Disconnect a Paired Device

You can rename or disconnect a paired Bluetooth device from the Settings app.

- 1 Open the Settings app and tap **Bluetooth**.
- 2 Tap the Settings icon  in the **Paired Devices** list.
- 3 To rename the device, tap **Rename**, type the new name, and then tap **OK**.
 - To disconnect the device, tap **Unpair**.

About Serial and USB Communications

You can use these accessories to transmit data to and receive data from another device through serial or USB communications:

- vehicle dock
- HomeBase
- USB snap-on adapter
- RS-232 DEX adapter

For information on these accessories, contact your local sales representative.

About Near Field Communication (NFC)

NFC technology provides the ability for short-range, wireless data transfer between the CT50 and NFC tags or other NFC enabled devices placed in close proximity to the back of the computer. NFC equipped CT50 models support the following modes of operation:

- **NFC tag reader/writer mode:** The computer reads and/or writes digital information from or to an NFC tag.
- **Peer-to-Peer (P2P) mode:** The computer uses Android Beam and/or Bluetooth technology to transfer screen content (such as a picture, contact information, Web page url, or file) between NFC enabled devices.
- **NFC card emulation mode:** The computer emulates an NFC card (smart card) that an external card reader can access. You have the option to enable the embedded secure element (eSE) SmartMX™ or Host Emulation. Secure element implementation is commonly used for financial transactions or coupon and loyalty mobile marketing applications that require a secure memory and execution environment for the storage of personal information (such as account information and credentials) and running custom smart card applets.



Note: Sleep Mode (Suspend Mode) and the screen lock temporarily turns the NFC radio off.

DRAFT

A

Specifications

Physical and Environmental Specifications

This sections lists the physical and environmental specifications for the CT50.

Physical Dimensions

Length:	160 mm
Width:	82.5 mm
Depth:	22 mm
Weight (with battery):	350 g (including battery)

Tumble and Drop Specifications

Tumble specification:	1000 1 m tumbles
Drop specification:	5 ft multiple drops to unyielding steel plate, -10 to +50 °C temperature range and 4 ft drop at 20 ° C

Power and Electrical Specifications

Operating battery:	Rechargeable Lithium-ion 3.7 V, 4000 mAh battery
Backup battery:	??
Electrical rating:	??

Temperature and Humidity Specifications

Operating temperature:	-20 °C to 50 °C (-4 °F to 122 °F)
Storage temperature:	-30 °C to 70 °C (-22 °F to 158 °F) For maximum battery life, store at 23 °C (73 °F) at 50% charge.
Charging temperature:	??
Relative humidity (operating):	5% to 95% non-condensing
Environmental rating:	IP67, Category 1

Screen Specifications

4.8-inch TFT color LCD with backlight, 720-pixel HD, outdoor viewable touch screen.

Language Support

World-wide English, French, German, Italian, Spanish, Simplified Chinese, Traditional Chinese.

Imager Reading Distances - what imager is in the CT50??

MVT9V022 non-decoded slim imager

I need specifications and depth of field information.

DRAFT