

Dolphin[®] 9900 Mobile Computers

Dolphin 9900

Dolphin 9950

Dolphin 9951

with Windows Mobile[®] 6.1

User's Guide

Disclaimer

Honeywell International Inc. ("HII") reserves the right to make changes in specifications and other information contained in this document without prior notice, and the reader should in all cases consult HII to determine whether any such changes have been made. The information in this publication does not represent a commitment on the part of HII.

HII shall not be liable for technical or editorial errors or omissions contained herein; nor for incidental or consequential damages resulting from the furnishing, performance, or use of this material.

This document contains proprietary information that is protected by copyright. All rights are reserved. No part of this document may be photocopied, reproduced, or translated into another language without the prior written consent of HII.

Web Address: www.honeywellaidc.com

Trademarks

Dolphin, Dolphin RF, HomeBase, Mobile Base, and QuadCharger are trademarks or registered trademarks of Hand Held Products, Inc. or Honeywell International Inc.

Microsoft, Windows, Windows Mobile, Windows CE, Windows NT, Windows 2000, Windows ME, Windows XP, ActiveSync, Outlook, and the Windows logo are trademarks or registered trademarks of Microsoft Corporation.

Other product names mentioned in this manual may be trademarks or registered trademarks of their respective companies and are the property of their respective owners.

Patents

Please refer to the product packaging for a list of patents.

Other Trademarks

The Bluetooth trademarks are owned by Bluetooth SIG, Inc., U.S.A. and licensed to Honeywell.

©2008–2010 Honeywell International Inc. All rights reserved.



Table of Contents

Chapter 1 - Agency Information

Label Locations	1-1
LED Safety Statement	1-2
Infrared LED Safety Statement	1-2
UL and C-UL Statement.....	1-2
Approvals by Country.....	1-3
R&TTE Compliance Statement—802.11b/g, Bluetooth, and/or GSM.....	1-3
Dolphin RF Terminal—802.11b/g, Bluetooth, and/or GSM.....	1-4
For European Community Users	1-4
Waste Electrical and Electronic Equipment Information	1-4
ANATEL	1-5

Chapter 2 - Getting Started

Out of the Box	2-1
Today Screen.....	2-3
Navigation Bar	2-3
Command Bar.....	2-4
Icons in the Navigation Bar	2-5
Pop-Up Menus	2-6

Chapter 3 - Hardware Overview

Standard Configurations for the 9900	3-1
Standard Configuration for the 9950	3-1
Standard Configuration for the 9951	3-1
Peripherals for the 9900, 9950, and 9951	3-2
Accessories for the 9900, 9950, and 9951	3-3
Front Panel: 9900, 9950, and 9951	3-4
Front Panel Features for the 9900, 9950, and 9951	3-5
Back Panel: 9900	3-6
Back and Side Panels: 9950 and 9951	3-7
Side Panel	3-7
Back Panel	3-8
Back Panel Features for the 9900, 9950, and 9951	3-9
Side Panels: 9900, 9950, and 9951	3-10
Left Side	3-10
Right Side	3-10
Installing a Memory Card	3-11
Bottom Panel: 9900, 9950, and 9951	3-12
I/O Connector.....	3-12
Using the Touch Panel.....	3-13
Installing a Screen Protector	3-13
Healthcare Housing	3-14

Batteries	3-14
Main Battery Pack.....	3-14
Internal Backup Battery	3-15
Managing Battery Power	3-16
Checking Battery Power	3-17
Resetting the Terminal	3-18
Soft Reset (Warm Boot).....	3-18
Hard Reset (Cold Boot)	3-18
Suspend Mode	3-18

Chapter 4 - Using the Scan Image Engine

Overview.....	4-1
Angled Imaging.....	4-1
Image Engine Specifications	4-1
Available Laser Engines	4-2
Laser Specifications	4-2
Supported Bar Code Symbolologies	4-3
Decoding	4-4
To Decode a Bar Code	4-4
Aiming Options	4-5
Capturing Images	4-6
Taking an Image	4-6
Uploading Images.....	4-7

Chapter 5 - Using the Keyboards

Available Keyboards.....	5-1
Keyboard Combinations	5-1
Common Buttons	5-2
Using the Function Keys.....	5-2
Using the Modifier Keys	5-3
Using the Navigation Keys	5-3
Sticky Key Functionality.....	5-4
35-Key Alpha/Numeric Keyboard	5-5
35-Key Keyboard Combinations	5-6
43-Key Alpha/Numeric Keyboard	5-8
43-Key Keyboard Combinations	5-9
56-Key Full Alpha/Numeric Keyboard	5-11
56-Key Keyboard Combinations	5-12
General Windows Keyboard Shortcuts	5-14

Chapter 6 - System Settings

Overview.....	6-1
Personal Tab	6-2
Buttons.....	6-3
Input.....	6-4
Menus	6-5

System Tab	6-7
About	6-8
Backlight	6-8
Certificates	6-9
ClearType Tuner	6-9
Clock & Alarms	6-9
Encryption	6-10
Error Reporting	6-10
External GPS	6-10
Memory	6-11
Power	6-12
Regional Settings	6-13
Remove Programs	6-13
Screen	6-14
WAN Info	6-15

Chapter 7 - Communication

Connections Tab	7-1
Using the IrDA Port	7-2
IrDA Port Location	7-2
Sending Data	7-2
Receiving Data	7-3
Connections Manager	7-4
To Access the Connections Manager	7-4
Task Tab	7-4
Advanced Tab	7-5
Dolphin Wireless Manager	7-6
Dolphin Wireless Manager Window	7-6
Enabling the Radios	7-6
Accessing Radio Configuration Utilities	7-7
ActiveSync Communication	7-8
Installing Additional Software	7-10
Adding Programs to the Terminal Using ActiveSync	7-10
Adding Programs Directly from the Internet	7-11
9900/9950/9951 COM Port Assignment Table	7-12

Chapter 8 - Working with GSM

Overview	8-1
Quad Band Antenna	8-1
SIM Card Installation	8-2
Enabling the GSM Radio	8-4

Voice Communication.....	8-5
Audio Modes.....	8-5
Volume Control.....	8-5
Accessing the Dialer Window	8-5
Dialing.....	8-5
Sending Calls.....	8-6
Ending Calls.....	8-6
Keyboard Combinations for Calls	8-6
View Options.....	8-6
Setup Options.....	8-7
Data Communication	8-8
Establishing Data Communication.....	8-8
Ending the Data Connection.....	8-10
Roaming	8-11

Chapter 9 - Working with the Bluetooth Radio

Enabling the Bluetooth Radio	9-1
Connecting to Other Bluetooth Devices	9-2
Pairing and Trusted Devices	9-4
Types of Devices and Services	9-5
Connecting to Bluetooth Printers.....	9-6
Connecting to Bluetooth Headsets	9-6
Transferring Files.....	9-7
Making the Terminal Discoverable	9-8
Selecting COM Ports	9-8

Chapter 10 - Working with GPS

Overview.....	10-1
Assisted GPS Support.....	10-1
Powering the GPS Module	10-1
Communication Ports	10-1
Selecting the Port	10-1
COM7	10-2
GPS Intermediate Driver.....	10-2
GPS Demo	10-2

Chapter 11 - Dolphin HomeBase Device

Overview.....	11-1
Parts and Functions.....	11-2
Power	11-4
Serial Connector.....	11-5
Charging the Main Battery.....	11-6
To Power a Terminal and Charge its Main Battery.....	11-6
Charging a Spare Battery in the Auxiliary Battery Well	11-6
Communication.....	11-7
Connecting the Communication Cables	11-7
Establishing Communication	11-7

Communicating with the Dolphin Terminal	11-8
Verifying Data Transfer.....	11-8
RS-232 Communications Cables	11-8
RS-232 Pin Configuration	11-9
Mounting.....	11-9
Desk Mounting.....	11-10
Wall Mounting.....	11-10

Chapter 12 - Dolphin Mobile Base Device

Overview.....	12-1
Front Panel.....	12-2
Bottom Panel	12-3
Powering the Dolphin Terminal	12-3
Charging the Dolphin Terminal.....	12-4
Mounting.....	12-4
Power	12-5
Establishing Communication	12-6
Connecting the Communication Cables	12-6
Establishing ActiveSync Communication.....	12-6

Chapter 13 - Dolphin ChargeBase Device

Overview.....	13-1
Parts and Functions.....	13-2
Supplying Power.....	13-3
Inserting and Removing Terminals.....	13-4
Charging Terminals	13-4
Mounting.....	13-5

Chapter 14 - Dolphin QuadCharger Device

Overview.....	14-1
Parts and Functions.....	14-2
Supplying Power.....	14-3
Inserting and Removing Battery Packs	14-4
Charging Batteries.....	14-4
Using the Battery Analyzer	14-5
Mounting.....	14-6
Desk Mounting.....	14-6
Wall Mounting.....	14-7
Troubleshooting.....	14-8

Chapter 15 - Customer Support

Product Service and Repair.....	15-1
Online Product Service and Repair Assistance.....	15-1
Technical Assistance.....	15-2
Online Technical Assistance.....	15-2
Limited Warranty	15-3
How to Extend Your Warranty	15-4



Agency Information

Dolphin 9900, 9950, and 9951 terminals meet or exceed the requirements of all applicable standards organizations for safe operation. However, as with any electrical equipment, the best way to ensure safe operation is to operate them according to the agency guidelines that follow. Please read these guidelines carefully before using your Dolphin terminal.

Label Locations

Dolphin 9900

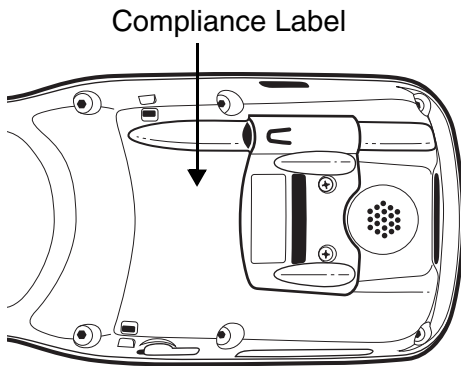

Dolphin 9950 & 9951

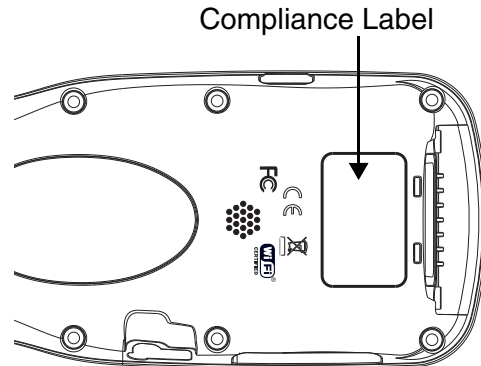

Laser Safety Label

If the following label is attached to your product, it indicates the product contains a laser engine or laser aimer:

SE1200 Laser Scan Engines

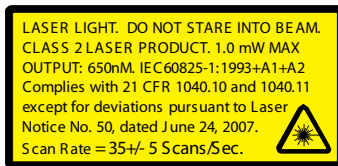
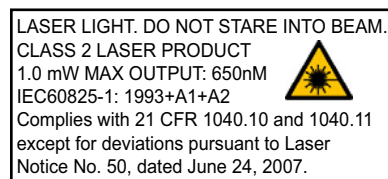

Image Engines with Integrated Laser Aimers



Laser Eye Safety Statement: This device has been tested in accordance with and complies with IEC60825-1: 1993+A1+A2 and 21 CFR 1040.10 and 1040.11, except for deviations pursuant to Laser Notice No. 50, dated June 24, 2007. LASER LIGHT, DO NOT STARE INTO BEAM, CLASS 2 LASER PRODUCT, 1.0 mW MAX OUTPUT: 650nm.



Caution - use of controls or adjustments or performance of procedures other than those specified herein may result in hazardous radiation exposure.

LED Safety Statement

The LED output on this device has been tested in accordance with IEC60825-1 LED safety and certified to be a Class 1 LED device.

The maximum power outputs for each diode are as follows:

- Illumination LED: 194.0 uW, wavelength: 626nm+/-30nm
- Aimer laser (5300 engine): 360.1 uW, wavelength: 655nm
- Aimer LED (5100 engine): 81.6 uW, wavelength: 526nm+/-30nm
- Laser (9951 models): <1.5 mW, wavelength: 650nm, scans/second (bidirectional): 35 (+/- 5)

Infrared LED Safety Statement



Caution - Do not view directly with optical instruments.

The maximum power outputs for the IR LED is 145.1 uW. LEDs are pulsed at a frequency of 115,200 Hz with a duty cycle of 18.75% where the “ON” time of a single pulse is 1.6275×10^{-6} seconds.

UL and C-UL Statement

UL and C-UL listed: UL60950-1 and CSA C22.2 No. 60950-1-03, ISA 12.12.01:2007

CAN/CSA: C22.2 No. 213-M1987

The following notes apply to 99XXXXX-XXXXXXI units (Hazardous Location rated. See [Approvals by Country](#) on page 1-3.).

Note: This equipment is suitable for use in Class 1, Division 2, Groups A, B, C, D, Class II, Division 2 Group G, Class III or non-hazardous locations only.

Note: Maximum operating ambient temperature rating 50°C.

Note: Underwriters Laboratories Inc. (UL) has not tested the performance or reliability of the global positioning system (GPS) hardware, GPS operating software or other GPS-related aspects of this product. UL has only tested for the explosion, fire, shock and casualty hazards required by the applicable hazardous locations standards. UL certification does not cover the performance or reliability of the GPS hardware, GPS operating software or other GPS-related aspects of this product. UL makes no representations, warranties or certifications whatsoever regarding the performance or reliability of any GPS-related functions of this product.

Approvals by Country

Country	EMC, Radio, & SAR	Safety
U.S.A.	FCC Part 15, Subpart C, 15.247 FCC Part 15, Subpart B FCC Part 22H FCC Part 24H FCC SAR OET 65 Supplement C	UL60950-1 *Hazardous Location: ISA 12.12.01:2007
Canada	ICES-003 (Class B) RSS 132 RSS 133 RSS 210	CSA C22.2 No. 60950-1-03 *Hazardous Location: CAN/CSA C22.2 No. 213-M1987
European Community/CE	EN300328-1/2 EN55022:1998+A1:2000+A2:2003 EN55024:1998+A1:2001+A2:2003 EN301489-1 EN301489-7 EN301489-17 EN300328 3GPPTS 51.010-1 ETSI EN301511 EN301511 EN60360 June 2001 EN50361 June 2001 EN50371 June 2001	EN60950-1:2000 EN60950-1:2001+A11:2004 EN60825-1:1994+A1:2002+A2:2001

**Applies to 99XXXXX-XXXXXXI units.*

This Class 2 Laser Product is in accordance with the requirements of IEC 60825-1 Ed. 1.2 Clause 6.2(a).

R&TTE Compliance Statement—802.11b/g, Bluetooth, and/or GSM

Dolphin RF terminals are in conformity with all essential requirements of the R&TTE Directive (1999/5/EC).

This product is marked with **CE0682** in accordance with the Class II product requirements specified in the R&TTE Directive. In addition, this product complies to 2006/95/EC Low Voltage Directive when supplied with the recommended power supply. Honeywell shall not be liable for use of our product with equipment (i.e., power supplies, personal computers, etc.) that is not CE marked and does not comply with the Low Voltage Directive.

The equipment is intended for use throughout the European Community; PAN European Frequency Range: 2.402–2.480 GHz. Restrictions for use in France are as follows:

- Indoor use: Maximum power (EIRP*) of 100 mW for the entire 2.400–2.4835 GHz
- Outdoor use: Maximum power (EIRP*) of 100 mW for the 2.400–2.454 GHz band & maximum power (EIRP*) of 10 mW for the 2.454–2.483 MGHz band.

For further information, please contact:

Honeywell Imaging & Mobility Europe BV
Nijverheidsweg 9
5627 BT Eindhoven
The Netherlands

Dolphin RF Terminal—802.11b/g, Bluetooth, and/or GSM

This device complies with Part 15 of the FCC Rules. Operation is subject to the following two conditions: (1) this device may not cause harmful interference, and (2) this device must accept any interference received, including interference that may cause undesired operation.

This equipment has been tested and found to comply with the limits for a Class B digital device pursuant to Part 15 of the FCC Rules. These limits are designed to provide reasonable protection against harmful interference in a residential installation. This equipment generates, uses, and can radiate radio frequency energy and, if not installed and used in accordance with the instructions, may cause harmful interference to radio communications. However, there is no guarantee that interference will not occur in a particular installation. If this equipment does cause harmful interference to radio or television reception, which can be determined by turning the equipment off and on, the user is encouraged to try to correct the interference by one or more of the following measures:

- Reorient or relocate the receiving antenna.
- Increase the separation between the equipment and receiver.
- Connect the equipment into an outlet on a circuit different from that to which the receiver is connected.
- Consult the dealer or an experienced radio/TV technician for help.

If necessary, the user should consult the dealer or an experienced radio/television technician for additional suggestions. The user may find the following booklet helpful: "Something About Interference." This is available at FCC local regional offices. Our company is not responsible for any radio or television interference caused by unauthorized modifications of this equipment or the substitution or attachment of connecting cables and equipment other than those specified by our company. The correction is the responsibility of the user. Use only shielded data cables with this system.

In accordance with FCC 15.21, changes or modifications not expressly approved by the party responsible for compliance could void the user's authority to operate the equipment.

CAUTION! Any changes or modifications not expressly approved by the grantee of this device could void the user's authority to operate the equipment.

Canadian Compliance

This Class B digital apparatus complies with Canadian ICES-003. Operation is subject to the following two conditions: (1) this device may not cause harmful interference, and (2) this device must accept any interference received, including interference that may cause undesired operation.

To prevent radio interference to the licensed service, this device is intended to be operated indoors and away from windows to provide maximum shielding. Equipment (or its transmit antenna) installed outdoors is subject to licensing.

Cet appareil numérique de la Classe B est conforme à la norme NMB-003 du Canada.

For European Community Users

Honeywell complies with Directive 2002/96/EC OF THE EUROPEAN PARLIAMENT AND OF THE COUNCIL of 27 January 2003 on waste electrical and electronic equipment (WEEE).

Waste Electrical and Electronic Equipment Information

This product has required the extraction and use of natural resources for its production. It may contain hazardous substances that could impact health and the environment, if not properly disposed.

In order to avoid the dissemination of those substances in our environment and to diminish the pressure on the natural resources, we encourage you to use the appropriate take-back systems for product disposal. Those systems will reuse or recycle most of the materials of the product you are disposing in a sound way.

 The crossed out wheeled bin symbol informs you that the product should not be disposed of along with municipal waste and invites you to use the appropriate separate take-back systems for product disposal.

If you need more information on the collection, reuse, and recycling systems, please contact your local or regional waste administration.

You may also contact your supplier for more information on the environmental performances of this product.

ANATEL

Este produto está homologado pela ANATEL, de acordo com os procedimentos regulamentados pela Resolução 242/2000, e atende aos requisitos técnicos aplicados.

Para maiores informações, consulte o site da ANATEL - www.anatel.gov.br.

Este equipamento opera em caráter secundário, isto é, não tem direito a proteção contra interferência prejudicial, mesmo de estações do mesmo tipo, e não pode causar interferência a sistemas operando em caráter primário.



(01)07898343089904

Pacemakers, Hearing Aids and Other Electrically Powered Devices

Most manufacturers of medical devices adhere to the IEC 601-1-2 standard. This standard requires devices to operate properly in an EM Field with a strength of 3V/m over a frequency range of 26 to 1000MHz. The maximum allowable field strength emitted by the Dolphin terminal is 0.3V/m according to Subpart B of Part 1 of the FCC rules. Therefore, the RF from the Dolphin terminal has no effect on medical devices that meet the IEC specification.

Microwaves

The radio in the Dolphin RF terminal operates on the same frequency band as a microwave oven. Therefore, if you use a microwave within range of the Dolphin RF terminal you may notice performance degradation in your wireless network. However, both your microwave and your wireless network will continue to function. The Dolphin Batch terminal does not contain a radio, and therefore, is not affected by microwave ovens.



Getting Started

Out of the Box

Verify that the carton contains the following items:

- Dolphin 9900 or 9950 or 9951 mobile computer (the terminal)
- Main battery pack (7.4v Li-ion)
- Microsoft Getting Started CD
- Quick Start Guide

Note: If you ordered accessories for your terminals, verify that they are also included with the order.

Be sure to keep the original packaging in the event that the Dolphin terminal should need to be returned for service. For details, see [Product Service and Repair](#) on page 15-1.

Step 1. Install the Main Battery Pack

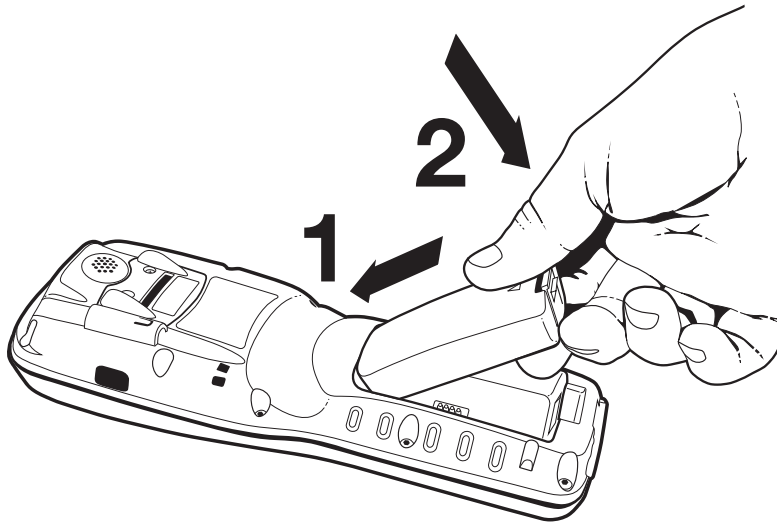

 We recommend use of Honeywell Li-Ion battery packs. Use of any non-Honeywell battery may result in damage not covered by the warranty.

Note: The following warnings apply to 99XXXXX-XXXXXXI units (Hazardous Location rated. See [Approvals by Country](#) on page 1-3.).



Replace only with battery pack type 200002586 manufactured by Honeywell International Incorporated.



Warning: Explosion Hazard. Charge or replace the battery only in an area known to be non-hazardous.



Warning: Explosion Hazard. Do not replace components unless power has been switched off or the area is known to be non-hazardous.



Warning: Substitution of any components may impair suitability.



Warning: Explosion Hazard. Do not use external connectors in areas known to be hazardous.

Step 2. Charge the Main and Backup Batteries

The power supply for Dolphin terminals consists of two types of battery power: the main battery pack installed on the back panel and the backup battery that resides inside the terminal.

The main battery powers the terminal. The internal backup battery charges off the main battery and maintains the application data stored in RAM memory for up to 30 minutes when the terminal's main battery pack is completely discharged or removed.

Before Initial Use

Terminals are shipped with both batteries discharged of all power. Charge the main battery pack for a minimum of 4.5 hours before initial use.

Time to Charge

Initial charging time for the main battery pack is 4.5 hours and 8 hours for the internal backup battery. Connect the terminal to one of the 9000 series charging peripherals to charge; see [Peripherals for the 9900, 9950, and 9951](#) on page 3-2.



We recommend use of Honeywell peripherals, power cables, and power adapters. Use of any non-Honeywell peripherals, cables, or power adapters may cause damage not covered by the warranty.

Note: The following warnings apply to 99XXXXX-XXXXXXI units (Hazardous Location rated. See [Approvals by Country](#) on page 1-3.).



Replace only with battery pack type 200002586 manufactured by Honeywell International Incorporated.



Warning: Explosion Hazard. Charge or replace the battery only in an area known to be non-hazardous.



Warning: Explosion Hazard. Do not replace components unless power has been switched off or the area is known to be non-hazardous.



Warning: Substitution of any components may impair suitability.



Warning: Explosion Hazard. Do not use external connectors in areas known to be hazardous.

Step 3. Boot the Terminal

The terminal begins booting as soon as power is applied and runs by itself. Do NOT press any keys or interrupt the boot process. Only tap the screen when prompted.

When the boot process is complete, the Today screen appears, and the terminal is ready for use.

Note: Because, the Today screen appears a number of times during the boot process, wait a few seconds before tapping anything on the Today screen.

Step 4. Set the Time and Date

You need to re-set the time and date after every hard reset of the terminal. It is a good idea to set the time and date before you begin using the device.

On the Today screen, tap the line that displays the time and date,

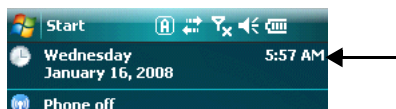

The Clock Settings screen appears.



The time zone defaults to **GMT-5 Eastern US**; tap the arrow to the right of GMT-5 Eastern US to select another time zone. Set the correct time and date in the remaining fields and tap **OK** to save.

Today Screen

After the Dolphin terminal initializes the first time, you see the Today screen.



You can also display the Today screen anytime by tapping **Start** and then Today.

Navigation Bar

The Navigation bar, located at the top of the screen, displays the active program and current time. It also provides access to the Start menu, which allows you to open programs and access the system settings.

Start menu: Grants access to system functions.









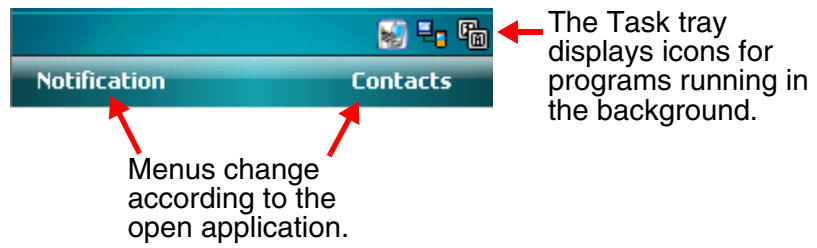











Icons here indicate the status of various system functions.

Command Bar













The Command bar is located at the bottom of application windows.



Icons in the Navigation Bar

Indicator	Meaning
	The terminal could not synchronize data with the workstation via ActiveSync.
	New e-mail or text message (SMS)
	New voicemail
	New instant message
	Ringer off
	Voice call
	Voice call in progress
	Calls are forwarded
	Call on hold
	Missed call
	Data call in progress
	Battery levels (1–4). Tap this icon to open the Power system setting and see the charge percentage (see page 3-17).
	Critical battery. The charge percentage is at the critical battery point set in the registry (the default is 10%). For details about the critical battery point, (see page 3-16). Tap this icon to open the Power system setting and see the charge percentage (see page 3-17).
	Terminal is running on external power. (If a battery pack is installed, that battery is charging.)
	The terminal is not connected to external power. A battery is installed, but is defective; specifically, its charge level cannot be measured.
	No SIM card is installed
	GPRS available
	GPRS connected
	EDGE available

Icons in the Navigation Bar

Indicator	Meaning
	EDGE connected
	Roaming
	Radio is disabled
	The radio is not connected to a network.
	Radio connected
	No radio signal
	The terminal is searching for a signal.
	Radio signal strength
	Wi-Fi on
	Wi-Fi data call
	Pending alarm
	Bluetooth

Pop-Up Menus

With pop-up menus, you can quickly choose an action for a selected item. To access a pop-up menu, tap and hold the stylus on the item name of the action you want to perform. When the menu appears, lift the stylus, and tap the action you want to perform.

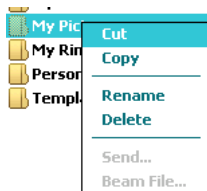

Tap anywhere outside the menu to close the menu without performing an action.

Selecting Programs

To see additional programs loaded on your terminal, tap **Start > Programs**. The Programs screen displays the programs that are not listed on the Start menu. To open a program, tap once on the icon.

Note: Some programs have abbreviated labels underneath the icon. To see the full spelling of an abbreviated label, tap and hold the stylus on the label. Drag the stylus off the label so that the command is not carried out.

File Explorer

You can also use the File Explorer to find files and organize these files into folders. Tap **Start > Programs > File Explorer**.

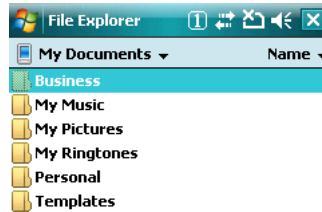

Tap the **Up** button at the bottom of the screen to move up one level in the directory.



You can move files in File Explorer by tapping and holding on the item you want to move, and then tapping **Cut** or **Copy** and **Paste** on popup menus.

Search

The Search feature helps you quickly locate information. Tap **Start > Programs > Search**  Search.

Enter the text you want to find, select a data type, and then tap **Go** to start the search. To quickly find information that is taking up storage space, select **Larger than 64 KB** in the **Type** drop-down field.



Hardware Overview

Standard Configurations for the 9900

WLAN & WPAN

- Microsoft Windows Mobile 6.1 Classic
- Intel XScale PXA27x 624 MHz
- 256MB RAM X 1GB Flash
- Three in-mold, hard-top keyboard options
- 2500mAh extended life main battery
- Adaptus Imaging Technology: 5100SR/SF or 5300SR/SF image engines
- 802.11b/g and Bluetooth

WLAN, WPAN, & WWAN

- Microsoft Windows Mobile 6.1 Professional
- Intel XScale PXA27x 624 MHz
- 256MB RAM X 1GB Flash
- Three in-mold, hard-top keyboard options
- 2500mAh extended life main battery
- Adaptus Imaging Technology: 5100SR/SF or 5300SR/SF image engines
- 802.11b/g, Bluetooth, and GSM/GPRS

WLAN, WPAN, & WWAN with GPS

- Microsoft Windows Mobile 6.1 Professional
- Intel XScale PXA27x 624 MHz
- 256MB RAM X 1GB Flash
- Three in-mold, hard-top keyboard options
- 2500mAh extended life main battery
- Adaptus Imaging Technology: 5100SR/SF or 5300SR/SF image engines
- 802.11b/g, Bluetooth, and GSM/GPRS
- GPS

Some configurations of the 9900 terminal are available with an external housing made of plastic that is specifically designed for the healthcare industry. For more information, see [Healthcare Housing](#) on page 3-14.

Standard Configuration for the 9950

- Microsoft Windows Mobile 6.1 Classic
- Intel XScale PXA27x 624 MHz
- 256MB RAM X 1GB Flash
- Three in-mold, hard-top keyboard options
- 2500mAh extended life main battery
- Adaptus Imaging Technology: 5100SR/SF or 5300SR/SF image engines
- 802.11b/g and Bluetooth

Standard Configuration for the 9951

- Microsoft Windows Mobile 6.1 Classic
- Intel XScale PXA27x 624 MHz
- 256MB RAM X 1GB Flash
- Three in-mold, hard-top keyboard options
- 2500mAh extended life main battery
- Laser scan engines - HP, LR, and ALR
- 802.11b/g and Bluetooth

Peripherals for the 9900, 9950, and 9951

Each of the following items is sold separately to enhance the capabilities of your Dolphin terminal.

Dolphin HomeBase™ Device

The Dolphin HomeBase device is a charging and communication cradle supporting both RS-232 and USB communications, which enables it to interface with the majority of PC-based enterprise systems. This device also contains an auxiliary battery well that charges a spare Li-ion battery.

For more information, see [Dolphin HomeBase Device](#) on page 11-1.

Dolphin Mobile Base™ Device

The Dolphin Mobile Base device is a charging and communication cradle designed specifically for in-premise and in-transit data collection applications. It features a flexible mounting bracket, a cigarette lighter adapter or power cable to adapt it to your environment.

The serial connector supports RS-232 communication and power out to peripheral devices, such as handheld scanners.

For more information, see [Dolphin Mobile Base Device](#) on page 12-1.

Dolphin ChargeBase

The Dolphin ChargeBase is a 4-slot charging cradle that holds, powers, and charges terminals.

For more information, see [Dolphin ChargeBase Device](#) on page 13-1.

Dolphin Net Base

The Dolphin Net Base is a 4-slot charging/communication cradle that holds, powers, charges, and communicates with terminals. Ethernet communication occurs via statically and dynamically-assigned IP addresses.

For more information about the Dolphin Net Base, please consult the Dolphin Net Base Quick Start Guide.

Dolphin QuadCharger™ Device

The Dolphin QuadCharger device is a 4-slot charging station for 9900, 9950, and 9951 Li-ion battery packs. The 4th slot features a battery analyzer that completely resets and re-calibrates a battery and displays its resulting capacity.

For more information, see [Dolphin QuadCharger Device](#) on page 14-1.

Accessories for the 9900, 9950, and 9951

Each of the following items is sold separately to enhance your terminal's capabilities.

Note: When using accessories where the terminal is worn on the body, the terminal's touch panel must face away from the body.

Dolphin Mobile Charger

The Dolphin Mobile Charger is a charging cable that connects the terminal directly to a 12 Volt DC power source, such as a cigarette lighter port inside a vehicle, eliminating the need for a cradle. Intelligent battery technology on-board the terminal ensures proper charging. The Dolphin Mobile Charger is an ideal low-cost charging solution for in-transit mobile applications.

Dolphin Mobile Mount

The Dolphin Mobile Mount, which holds a Dolphin terminal securely in place inside a vehicle, is an ideal, low-cost alternative to the Dolphin Mobile Base when communications are not required. When used in conjunction with the Dolphin Mobile Charger, the Dolphin Mobile Mount creates a complete mounting and charging solution for in-transit applications. The entire kit includes an adjustable vehicle mounting bracket.

Communication/Charging Cables

Dolphin communication/charging cable kits are an all-in-one solution for mobile applications. Each cable kit powers the terminal, charges its main battery, and communicates with host or peripheral devices without the need for a cradle. Cable kits can support RS-232 or USB communications and are available with U.K. or European power cords.

Protective Holster

Holsters provide convenient storage for terminals and protect them from damage in mobile environments. Both holsters feature a front pocket that holds an extra battery, a side pocket to hold an extra stylus, and a belt loop to secure the holster to a belt.

Protective Enclosure

Protective enclosures help seal and protect terminals from damage while providing full access to all terminal parts and features. These enclosures feature a swivel clip on the back that enables you to secure the enclosure to a belt. Enclosures also come with an adjustable shoulder strap for added convenience.

Stylus Kits

There are two stylus kits: one contains three styli and the other includes additional coiled tethers to secure the stylus to the terminal, which helps prevent loss.

Li-ion Battery Pack

The 7.4v, 18.5 watt hour Li-ion rechargeable battery pack provides the main power for the terminal.

Front Panel: 9900, 9950, and 9951

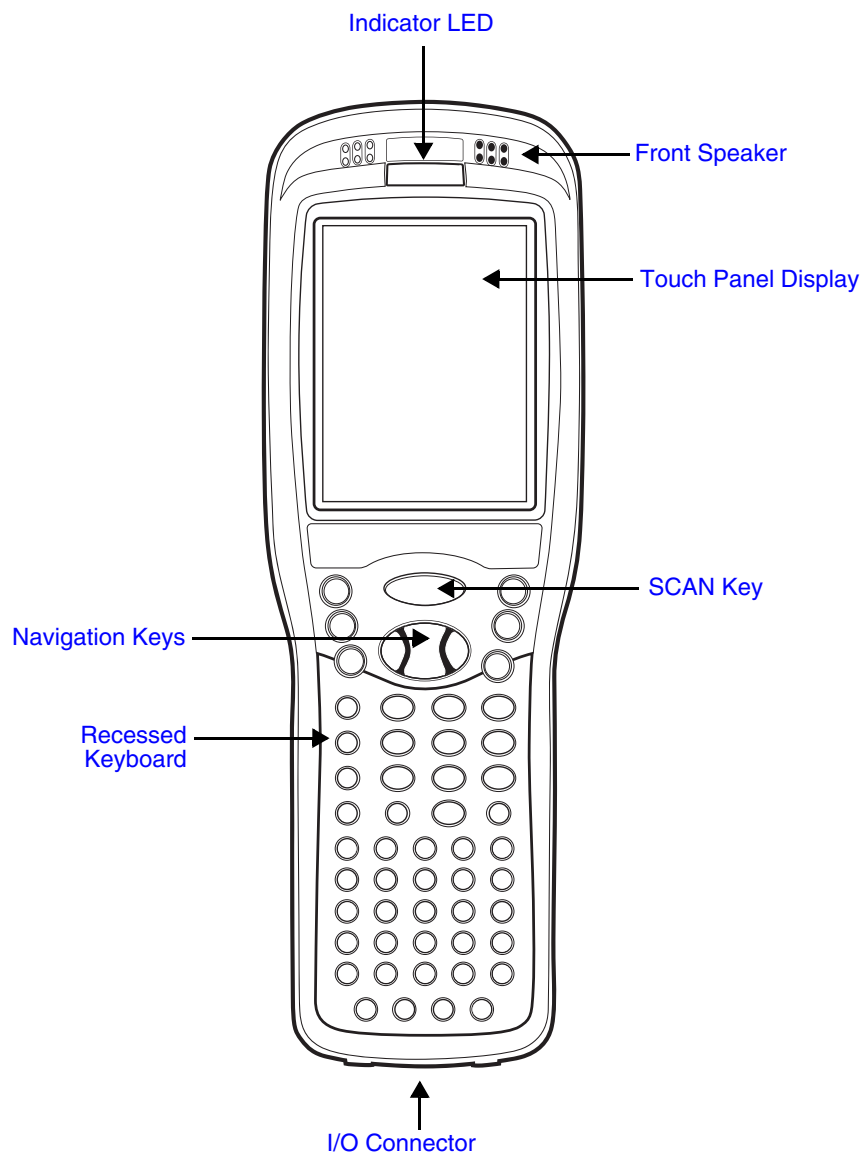

Front Panel Features for the 9900, 9950, and 9951

Front Speaker

The integrated speaker that sounds audio signals as you scan bar code labels and enter data. The operating frequency range is 500Hz at 71 dB up to 80 dB.

I/O Connector

See [I/O Connector](#) on page 3-12.

Indicator LED

The light emitting diode (LED) located at the top of the LCD display flashes and illuminates during resets and scanning/imaging. This LED can be programmed by various software applications.

Navigation Keys

The centrally-located navigation keys enable you to move and position the cursor through software programs. The up and down arrows are programmed to perform specific functions when pressed in combination with the Blue and Red modifier keys.

For more details, see [Using the Navigation Keys](#) on page 5-3.

Recessed Keyboard

There are three keyboard options: 35-key numeric/alpha keyboard, 43-key numeric/alpha keyboard, and 56-key full alpha/numeric keyboard.

For a complete overview of each keyboard, see [Using the Keyboards](#) on page 5-1.

SCAN Key

The SCAN key is centrally located for easy access with the right or left hand. When pressed, the SCAN key activates the scanner/imager. The SCAN key also functions as a system wake-up control for the terminal.

Touch Panel Display

The color 3.5 inch liquid crystal display (LCD) touch panel is covered with an industrial, protective lens for greater durability. The video graphic array (VGA) resolution is 1/4 (240 X 320 pixel).

The color LCD is 16 bits/pixel and uses thin film transistor (TFT) technology. The touch panel backlight lights when the screen is touched, but not when the Backlight key is pressed. For more information, see [Backlight](#) on page 6-8.

The touch panel can be activated by the stylus (included with the terminal) or a finger. For more information, see [Using the Touch Panel](#) on page 3-13.

Back Panel: 9900

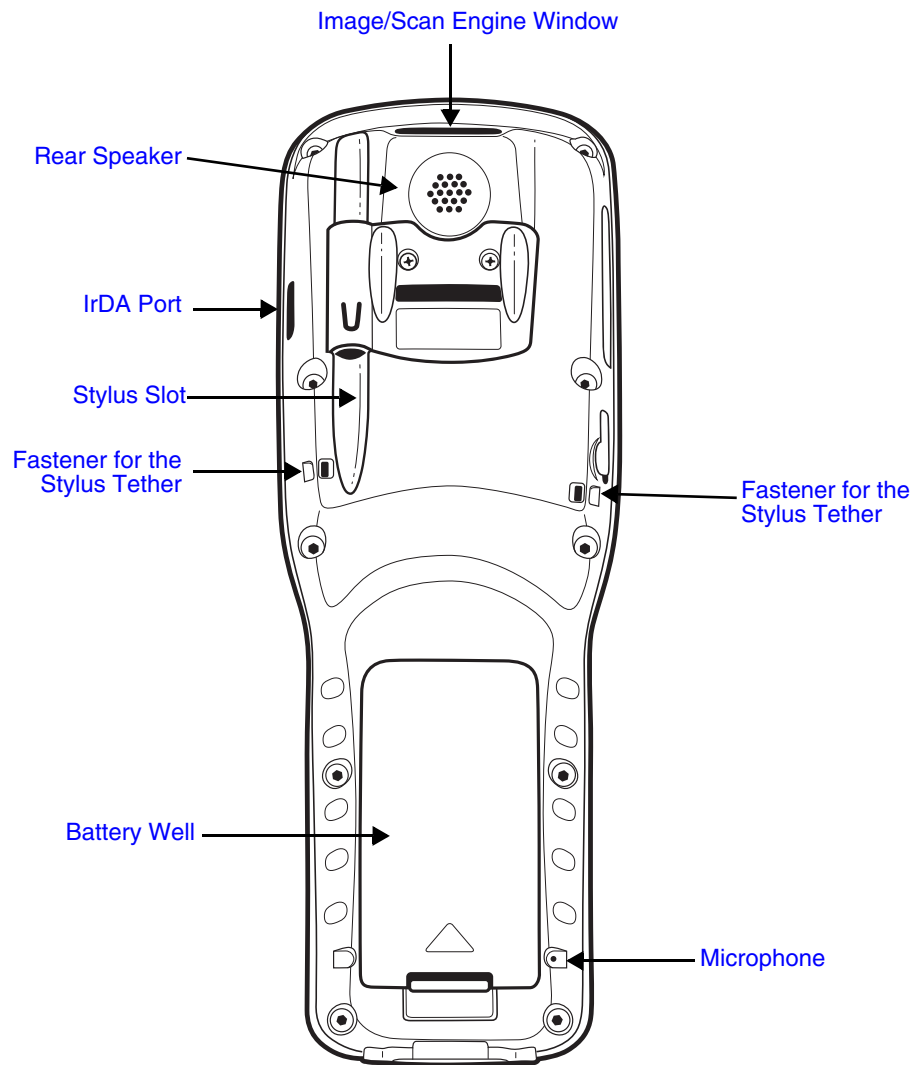

For a description of each callout, see [Back Panel Features for the 9900, 9950, and 9951](#) on page 3-9.

Back and Side Panels: 9950 and 9951

The back panel of the 9950 and 9951 contains an integrated, pistol-grip handle for a more ergonomic grip in scan-intensive applications. The stylus is stored inside the handle for easy access.

Side Panel

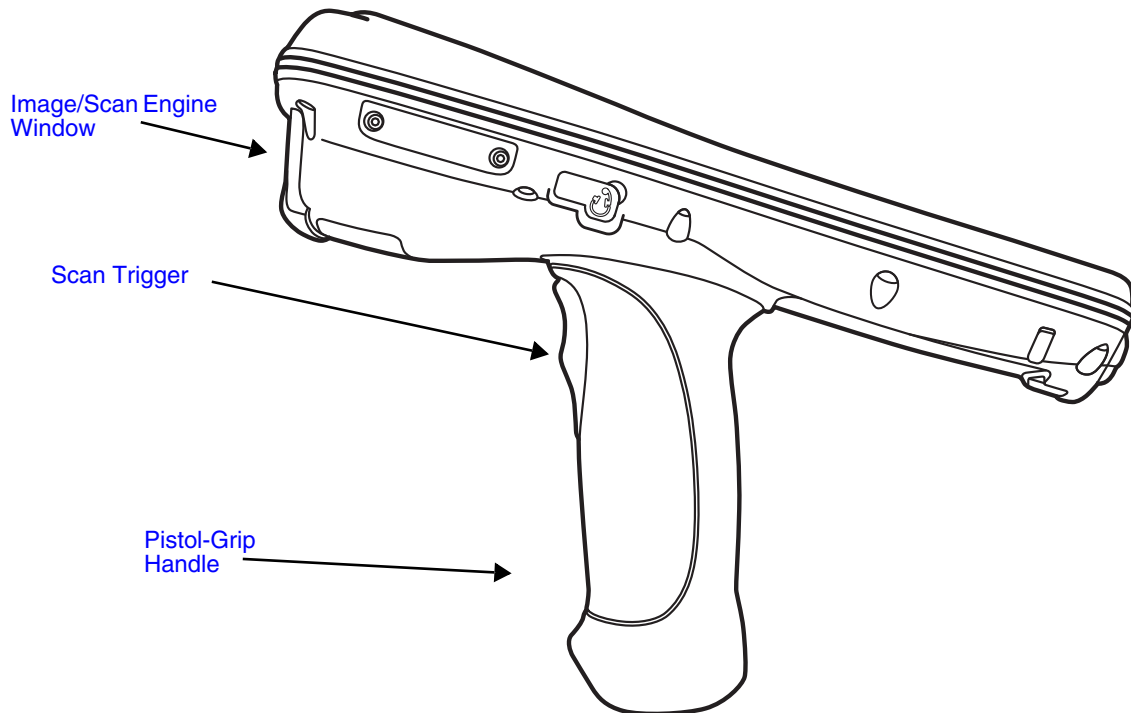

Scan Trigger

Press the scan trigger to activate the image or scan.

Pistol-Grip Handle

The pistol-grip handle is integrated into the back panel of the terminal and ergonomically designed to be comfortable through repetitive scans.

Back Panel

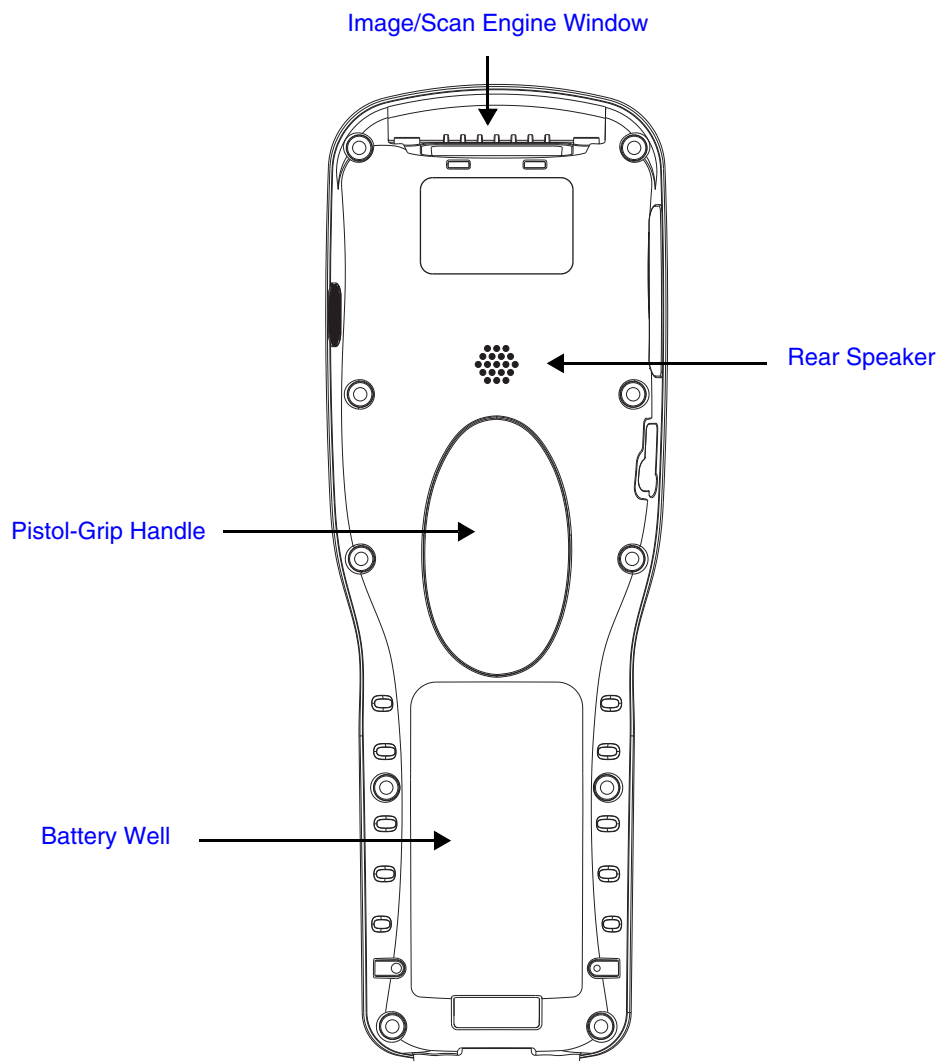

For a description of each callout, see [Back Panel Features for the 9900, 9950, and 9951](#) on page 3-9.

Back Panel Features for the 9900, 9950, and 9951

Battery Well

The Battery Well is a recessed area on the back panel that holds the Li-ion battery pack. For more information, see [Batteries](#) on page 3-14.

Fastener for the Stylus Tether

Stylus tethers can be purchased separately to help you keep the stylus attached to the 9900 when not in the slot to prevent loss. A stylus tether is a coiled, elastic cord with one end that can be attached to the stylus and another attached to the back panel.

Image/Scan Engine Window

The available image engines read and decode linear, stacked linear (e.g., PDF417), and 2D matrix bar code symbologies. The available laser engines contain a laser aimer for greater accuracy.

The laser apertures for the laser aimers for both the image engines and the scan engines are contained behind this window.

For more details, see [Using the Scan Image Engine](#) on page 4-1.

Microphone

The integrated microphone that provides audio input to the terminal when a headset is not plugged into the [Audio Jack](#), page 3-10. When a headset is plugged in, the terminal defaults to the microphone on the headset.

Rear Speaker

The integrated speaker that sounds audio signals as you scan bar code labels and enter data. The operating frequency range is 500Hz at 71 dB up to 80 dB.

Stylus Slot

The stylus is used to operate the touch panel. The back panel features this storage slot to hold the stylus when not in use.

The stylus features a special tip for added accuracy and ease of use.



Side Panels: 9900, 9950, and 9951

The left and the right side panels contain different features.

Left Side

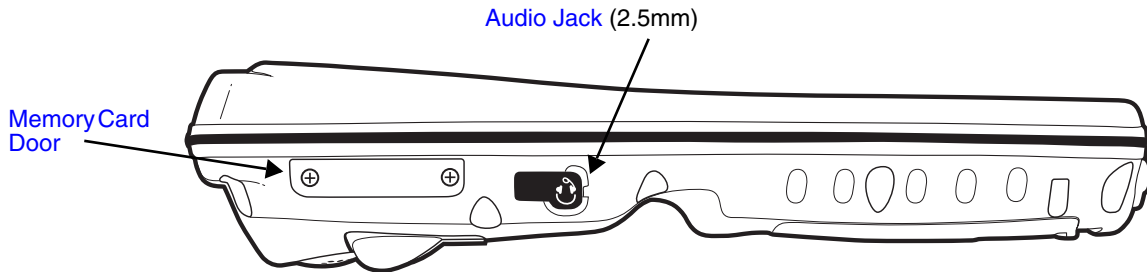

Memory Card Door

This door provides user access to the industry-standard SD memory interface. You can open this door to insert SD memory cards to expand the terminal's memory capacity.

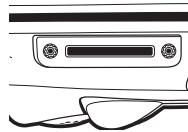

When this door is fastened securely and properly, the memory interface is sealed against moisture and particle intrusion, read/write data is stored securely, and the terminal's environmental rating is preserved; see [Installing a Memory Card](#) on page 3-11.

Audio Jack

The 2.5mm audio jack supports both speaker (stereo) and microphone (mono) headsets.

Right Side

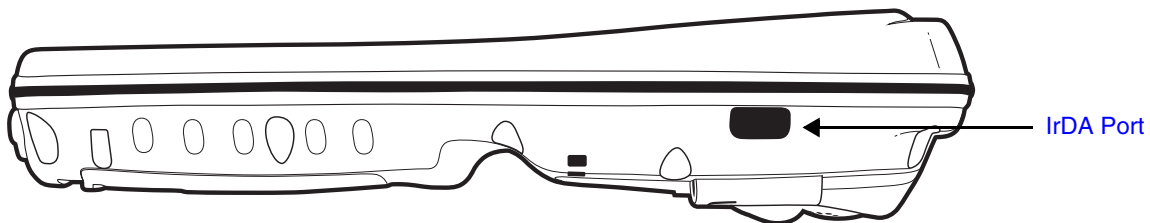

IrDA Port

The IrDA port enables infrared communication. The maximum data transfer speed is 115kbps.

Note: The infrared LED aperture is located behind the window.

For more information about using this port, see [Using the IrDA Port](#) on page 7-2.

Installing a Memory Card

1. Press the Power key  to put the terminal in Suspend Mode; see [Suspend Mode](#) on page 3-18.
2. Remove the battery.
3. Place the terminal on a flat, secure surface with the keyboard face down.
4. Unscrew both screws and remove the door.

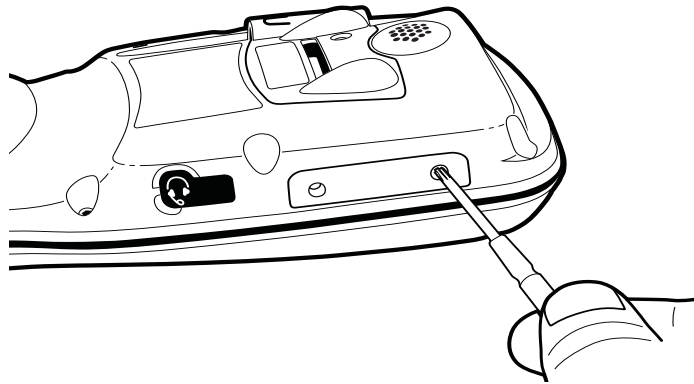

5. Slide the SD card into the appropriate slot until it clicks into place.

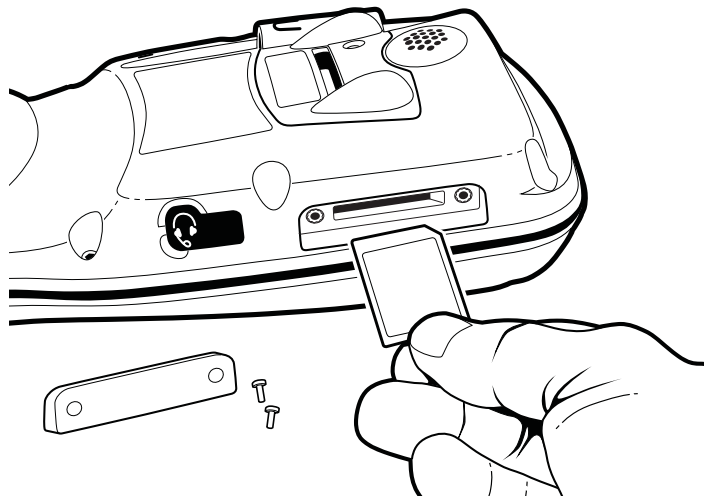

- a. To remove an installed SD card, tap on the edge lightly to unlock the card; the card will pop out just enough for you to grab its edge and pull it out.
6. Replace the access door and tighten the screws.
There is a rubber gasket on the inside of access door that **must** be in place when you seal the door. This gasket performs the sealing action for the door.

Bottom Panel: 9900, 9950, and 9951

I/O Connector

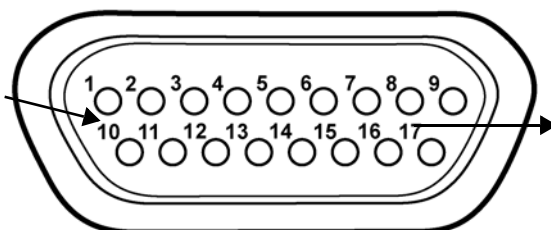

Pin #	Description
1	+USB
2	PWR
3	N/C
4	N/C
5	N/C
6	N/C
7	GND
8	5V OUT
9	DTR
10	-USB
11	USB DET
12	RI
13	DSR
14	RXD
15	RTS
16	TXD
17	CTS

Note: Signals referenced are for a DTE device.

I/O Connector

The I/O connector powers the terminal, charges the main battery, and facilitates communication. All Dolphin peripherals are designed to work exclusively with this connector.

The I/O connector supports RS-232 and USB communication. For RS-232, the maximum communication speed is 115 Kbps with seven baud rate settings. For USB, the communication speed is up to 12 Mbps.

Powering Out

The I/O connector also provides power out (to peripheral devices) 5V at 500mA. This means that, with the proper cable, the terminal can power another device. By default, power out is disabled. To enable power out, alter the registry as follows:

```
[HKEY_LOCAL_MACHINE\Drivers\BuiltIn\Serial4]
    Conn5Venable=1
```

Using the Touch Panel

Honeywell defines proper use of the terminal touch panel as using a screen protector and proper stylus. Screen protectors maintain the ongoing integrity (i.e., prevent scratching) of the touch panel, which is why their use is recommended for applications that require a high to medium level of interface with the touch panel, such as signature capture for proof of delivery.

Honeywell advocates the use of screen protectors on all Dolphin devices. We recommend implementing a screen protector replacement program to ensure that screen protectors are replaced periodically when signs of damage/wear are noticeable. For general use, we recommend replacing the screen protector every thirty (30) days. However, replacement cycles vary according to the average level of touch panel use in your application.

Replacement screen protectors can be purchased directly from Honeywell. Please contact a Honeywell sales associate for details.

Honeywell also mandates use of a proper stylus, which is one that has a stylus tip radius of no less than 0.8mm. Use of the Honeywell stylus included with the terminal is recommended at all times.

Honeywell warranty policy covers wear on the touch panel for the first 12 months provided that a screen protector is applied and an approved stylus is used for the 12 month duration covered by the warranty.

Installing a Screen Protector

Dolphin terminals ship with a screen protector already installed. You will need to replace the screen protector at regular intervals.

1. After the current screen protector has been removed from the touch panel, clean the touch panel thoroughly with a clean, non-abrasive, lint-free cloth. Make sure no debris is still attached to the touch panel.
2. Align the exposed section of the protector with the bottom edge of the touch panel. Make sure that the screen protector is flush with each side of the touch panel. To reposition, lift up gently and reapply.
3. Press the screen protector firmly and carefully across the surface of the touch panel as you peel away the backing.
4. If necessary, smooth out any air pockets or bumps.

Healthcare Housing

Some configurations of the 9900 terminal are available with an external plastic housing that is designed to resist the effects of harsh chemicals in a healthcare environment. The plastic is crystalline in nature, which helps prevent chemicals from seeping through the housing.

Important! The following cleaning solutions have been tested to assure safe cleaning of your terminal's disinfectant-ready housing. They are the only solutions approved for use with these terminals. Damage caused by the use of cleaners other than those listed below may not be covered by the warranty.

- Sani-Cloth® HB wipes
- Sani-Cloth® Plus wipes
- Super Sani-Cloth® wipes
- Isopropyl Alcohol wipes (70%)
- CaviWipes™
- Virex® 256
- 409® Glass and Surface Cleaner
- Windex® Blue
- Clorox® Bleach – 100%
- Gentle dish soap and water

Batteries

There are two types of battery power: the main battery pack installed in the back panel and the backup battery located inside the terminal. They are designed to work together to prevent data loss when the terminal is in use over long periods.

Both batteries must be completely charged before using a Dolphin terminal for the first time!

Main Battery Pack

 We recommend use of Honeywell Li-Ion battery packs. Use of any non-Honeywell battery may result in damage not covered by the warranty.

Note: The following warnings apply to 99XXXXX-XXXXXXI units (Hazardous Location rated. See [Approvals by Country](#) on page 1-3).

 Replace only with battery pack type 200002586 manufactured by Honeywell International Incorporated.

 Warning: Explosion Hazard. Charge or replace the battery only in an area known to be non-hazardous.

 Warning: Explosion Hazard. Do not replace components unless power has been switched off or the area is known to be non-hazardous.

 Warning: Substitution of any components may impair suitability.

 Warning: Explosion Hazard. Do not use external connectors in areas known to be hazardous.

The 7.4V, 18.5 watt hour Li-ion battery pack is the primary power source for the terminal. The Li-ion battery is designed to operate in a temperature range of -10° to 50°C (14° to 122°F).

Charging Options

When the Li-ion battery is installed in the terminal, use one of the following peripherals:

-
- [Dolphin HomeBase Device](#) (see page 11-1)
 - [Dolphin Mobile Base Device](#) (see page 12-1)
 - [Dolphin ChargeBase Device](#) (see page 13-1)
 - Dolphin Net Base (Please see the Dolphin Net Base Quick Start Guide on www.honeywellaidc.com.)
 - Dolphin Mobile Charger

When the Li-ion battery is not installed in the terminal:

- Place the battery pack in the Dolphin QuadCharger device (see page 14-4)
- Place the battery pack in the [Auxiliary Battery Well](#) of the Dolphin HomeBase device (see page 11-6).

Charging Time

The Li-ion battery pack requires 4.5 hours to charge completely before initial use.

Storing Batteries

To maintain optimal battery performance, follow these storage guidelines:

- Avoid storing batteries outside the specified range of -4° to 104° F (-20° to 40°C) or in extremely high humidity.
- For prolonged storage, to maximize battery life, it is recommended that the battery be at a 40% - 50% charge level, be removed from any device, and stored in a controlled temperature environment.

Guidelines for Battery Pack Use and Disposal

The following are general guidelines for the safe use and disposal of batteries:

- We recommend use of Honeywell Li-Ion battery packs. Use of any non-Honeywell battery may pose a personal hazard to the user.
- Replace defective batteries immediately; using a defective battery could damage the Dolphin terminal.
- Never throw a used battery in the trash. It contains heavy metals and should be recycled according to local guidelines.
- Don't use a battery in any other manner outside its intended use in Dolphin terminals and peripherals.
- Don't short-circuit a battery or throw it into a fire; it can explode and cause severe personal injury.
- Excessive discharge damages a battery. Recharge the battery when your terminal indicates low battery power.
- If you observe that the Honeywell battery supplied is physically damaged in some way, please send it to Honeywell International Inc. or an authorized service center for inspection. Refer to the Product Service and Repair section of this guide.
- Although your battery can be recharged many times, it will eventually be depleted. Replace it after the battery is unable to hold an adequate charge.
- If you are not sure the battery or charger is working properly, please send it to Honeywell International or an authorized service center for inspection.

Internal Backup Battery

Located inside the terminal, the backup battery is a 3.6 Volt nickel metal hydride (NiMH) battery.

The internal backup battery prevents the terminal from being reset if you need to remove and replace the main battery pack. It retains RAM data and allows the real-time clock to remain operational for up to 30 minutes when the main battery pack is removed. If the terminal is left without the main battery pack for more than 30 minutes, the internal backup battery needs to be recharged to function according to its specifications.

Note: Data and programs stored in Flash memory are not lost even if the internal backup battery fails. However, you must reset the real-time clock; see [Set the Time and Date](#) on page 2-2.

Charging

The internal backup battery is powered by the main battery pack. Therefore, charging the internal backup battery requires that the main battery pack be installed in the terminal and the terminal be connected to a charging device.

The internal backup battery must be fully charged before using the terminal for the first time. The initial charge cycle takes approximately 8 hours. After that, if the internal backup battery becomes fully discharged of power, it requires a minimum of 10 hours of charging time to function normally.

Guidelines for Use

Follow these guidelines to maximize the life of the internal backup battery under normal usage conditions:

- Keep a charged Li-ion battery pack in the terminal; the backup battery prematurely discharges if there is not at least a partially charged battery in the terminal.
- Keep the terminal connected to power when the terminal is not in use.

Managing Battery Power

Data and files saved on Dolphin terminals may be stored in RAM memory, which does not persist through a hard reset. Therefore, to help prevent data loss, maintain a continuous power supply to the terminal.

Letting the backup battery become fully discharged causes the terminal to lose all data in RAM. Therefore, you should keep a charged battery pack in the terminal at all times. The internal battery discharges prematurely if there is not at least a partially charged battery in the terminal. When you remove a battery pack, insert another charged battery pack in the terminal immediately.

Default Critical and Low Battery Points

When the terminal is running on battery power (as opposed to external power), warnings are displayed when the battery reaches critical and low battery points. The warning points are determined by the following registry entry:

[HKEY_LOCAL_MACHINE\System\CurrentControlSet\Control\Power]

There are two DWORD values in this registry entry: **LowBatt** and **CriticalBatt**. The default values for these entries are as follows:

LowBatt=19 (25%)

This sets the Low Battery point to 25% (19 hex=25 decimal). When the battery hits the percentage charge specified here, the user is notified by this icon in the Navigation bar .

If the main battery is low and the terminal is in Suspend Mode, pressing the SCAN or Power button won't wake the Dolphin terminal; you **must** replace the discharged battery with a battery charged over the 25% mark before you can resume terminal operation.

CriticalBatt=a (10%)

This sets the Critical Battery point to 10% (a hex= 0 decimal). When the battery hits the percentage charge specified here, the user is notified by this icon in the Navigation bar .

Note: Warnings do not appear when the terminal is on external power.

Setting Critical and Low Battery Points

Developers can reset the battery parameters in the registry from 0 (no warning) to 99 (would nearly always warn). You can review and set these battery points in the RegEdit Power Tool.

1. Tap **Start > Power Tools > RegEdit**.
2. Drill down to **HKEY_LOCAL_MACHINE > System > CurrentControlSet > Control > Power**.
3. Tap the **Value Name** to change the Value Data.
You can reset the Value Data from 0 (no warning) to 99 (would nearly always warn).
4. Tap **OK** to save changes.

For more information about the RegEdit Power Tool, refer to the Dolphin Power Tools User's Guide available for download at www.honeywellaidc.com.

Checking Battery Power

Tap **Start > Settings > System tab > Power**.

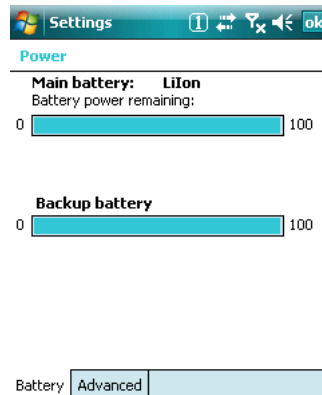

For more information, see [Power](#) on page 6-12.

Resetting the Terminal

There are two types of system resets: a soft and a hard reset.

Soft Reset (Warm Boot)

A soft reset re-boots the device without losing RAM data. You would perform a soft reset when

- the terminal fails to respond.
- after installing some software applications.
- after making changes to certain system settings, such as network cards.

1. On the 56-key keyboard, press and hold the CTRL  + SFT  keys for approximately 5 seconds.

On the 43-key keyboard, press and hold the CTRL  + NUM  keys for approximately 5 seconds.



2. The decode and scan LEDs flash for approximately three seconds as the terminal resets.
3. When the reset is complete, the Today screen displays.

Hard Reset (Cold Boot)

A hard reset resets the operating system, restores the terminal back to factory defaults, and resets the terminal after a bootloader, keyboard, and kernel upgrade.



A hard reset erases all of the data stored in RAM memory and all RAM installed applications!

1. Press and hold the CTRL  + ESC  keys for approximately 5 seconds.
2. The decode and scan LEDs light for approximately 3 seconds.
3. The terminal re-initializes; see [Initialize the Mobile Computer](#) on page 2-8.

Suspend Mode

The terminal goes into Suspend Mode automatically when the terminal is inactive for a programmed period of time. You can program this time on the Advance tab of the Power system setting; see [Power](#) on page 6-12.

To put the terminal into Suspend Mode manually, press the Power key  and the screen goes blank.

To wake the terminal from Suspend Mode, press the Power  or SCAN keys .

Hardware Maintenance

When needed, clean the image engine window and the LCD display with a clean, non-abrasive, lint-free cloth. The terminal can be cleaned with a damp cloth.

Using the Scan Image Engine

Overview

The Dolphin terminal houses a compact image engine that instantly reads popular 1D and 2D bar codes and supports omni-directional aiming and decoding for greater flexibility in real-world settings. The image engine can also capture digital images, such as signatures and pictures of damaged inventory.

With the latest CMOS-based technology, the engine works like a digital camera and enables digital image capture, signature capture, and reading of OCR characters.

Angled Imaging

All imagers are installed at a 33 degree downward-facing angle for enhanced comfort and maneuverability while scanning.

Image Engine Specifications

Engines	1D	2D	Image Capture	Aiming Pattern	Omni-Directional Aiming
5100SR/SF	Y	Y	Y	5100 Green Aiming Beam (page 4-5)	Y
5300SR	Y	Y	Y	5300 Red High-Vis Aiming Pattern (page 4-5)	Y

5100 Standard Range (5100SR) 5300 Standard Range (5300SR)

	8.3 mil Linear	10 mil PDF417	13 mil UPC	15 mil Data Matrix	15 mil QR	35 mil MaxiCode
Working Range:	(.020 cm)	(.025 cm)	(.033 cm)	(.038 cm)	(.038 cm)	(.089 cm)
Near	3.5 in. (8.9 cm)	3.1 in. (7.9 cm)	2.1 in. (5.3 cm)	2.3 in. (5.8 cm)	3.1 in. (7.9 cm)	2.0 in. (5.1 cm)
Far	7.6 in. (19.3 cm)	9 in. (22.9 cm)	13.2 in. (33.5 cm)	10.2 in. (25.9 cm)	8.8 in. (22.4 cm)	13.0 in. (33 cm)

5100 Smart Focus (5100SF)

	6.6 mil PDF417	7.5 mil Linear	10 mil Linear	10 mil PDF417	13 mil UPC	15 mil Data Matrix
Working Range:	(.017 cm)	(.019 cm)	(.025 cm)	(.025 cm)	(.033 cm)	(.038 cm)
Near	2.7 in. (6.8 cm)	2.4 in. (6.1 cm)	2.1 in. (5.3 cm)	2.1 in. (5.3 cm)	1.9 in. (4.8 cm)	1.7 in. (4.3 cm)
Far	5.9 in. (14.9 cm)	6.4 in. (16.2 cm)	7.5 in. (19 cm)	7.5 in. (19 cm)	8.8 in. (22.3 cm)	7.4 in. (18.8 cm)

Available Laser Engines

High Performance (HP)

	5 mil	55 mil reflective
Working Range:		
Near	2.75 in (0.07 m)	5 in (0.13 m)
Far	7 in (0.17 m)	66 in (1.7 m)

Long Range (LR)

	10 mil	100 mil reflective
Working Range:		
Near	11 in (0.28 m)	60 in (1.5 m)
Far	24 in (0.6 m)	240 in (6.1 m)

Advanced Long Range (ALR)

	13 mil	100 mil reflective
Working Range:		
Near	19 in (0.48 m)	125 in (3.2 m)
Far	39 in (1 m)	360 in (9.1 m)

Laser Specifications

The maximum power outputs for each diode are as follows:

- Illumination LED: 194.0 uW
- Aimer laser (5300 engine): 360.1 uW
- Aimer LED (5100 engine): 81.6 uW

Supported Bar Code Symbologies

Symbology Type	Symbology Name
1D Symbologies	Codabar Code 3 of 9 Code 11 Code 32 Pharmaceutical (PARAF) Code 93 Code 128 EAN with Add-On EAN with Extended Coupon Code EAN-8 EAN-13 GS1-128 GS1 Databar Interleaved 2 or 5 ISBT 128 Matrix 2 of 5 MSI Plessey PosiCode Straight 2 of 5 IATA Straight 2 of 5 Industrial Telepen Trioptic Code UPC UPC-A UPC-E
2D Symbologies	Aztec Codablock Code 16K Code 49 Composite Data Matrix GS1 Databar MaxiCode Micro PDF OCR PDF417 QR Code
Composite Codes	Aztec Mesa Codablock F EAN-UCC GS1 Databar-14
OCR	OCR US Money Font MICR (E 13 B) and SEMI Font OCR-A OCR-B
Postal Codes	Postnet and most international 4-state codes Australian Post British Post Canadian Post China Post Japanese Post KIX (Netherlands) Post Korea Post Planet Code

Decoding

The terminal supports two types of image decoding for use in various bar code reading and imaging applications: full-area imaging and Advanced Linear Decoding (ALD).

Full-Area Imaging

Full-area imaging provides omni-directional reading of linear and non-linear 1D and 2D bar codes, OCR, signature capture, and picture taking. When reading all bar code types using full-area imaging, a positive read can be obtained from many positions; see [Aiming Options](#) on page 4-5. To achieve the best read, the aiming beam should be centered horizontally across the bar code.

ALD

ALD provides fast reading of linear and stacked linear bar codes. To achieve a positive read when reading linear 1D and PDF417 bar codes, the green aiming beam should be centered horizontally across the bar code. When ALD is enabled, the reader does not read matrix or postal codes.

To Decode a Bar Code

The imager faces straight out the top panel. The aiming beam should be oriented in line with the bar code to achieve optimal decoding. A range of 4-10 inches (10-25 cm) from the bar code is recommended.

1. Point the Dolphin terminal directly at the bar code.
2. Project the aiming beam or pattern by pressing and holding the SCAN key.
3. The scan LED lights red.
4. Center the aiming beam over the bar code; see [Aiming Options](#) on page 4-5.
5. When the bar code is successfully decoded, the decode LED lights green and the terminal beeps.
6. The bar code information is entered into the application in use.

Aiming Options

The aiming beams are smaller when the terminal is held closer to the code and larger when it is farther from the code. Symbologies with smaller bars or elements (mil size) should be read closer to the unit whereas symbologies with larger bars or elements (mil size) should be read farther from the unit.

5100 Green Aiming Beam

Linear Bar Code



2D Matrix Symbol



5300 Red High-Vis Aiming Pattern

If your Dolphin terminal is configured with a 5300 imager, high-vis aimers frame the bar code for more intuitive aiming.

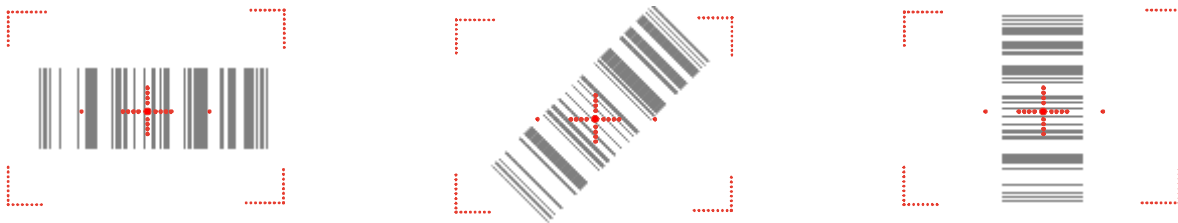

Capturing Images

The image-capture process is an intuitive, split-second operation for experienced users. By following the basic guidelines, new users can easily develop their own technique and, with practice, quickly learn to adapt it to different application environments.

Image Preview

When the imaging process is initiated, the touch screen displays a preview of the object. This is a live video image of what the imager is currently viewing. The live video image has a slightly degraded appearance compared to the captured image. This is normal.

Scan Key

On all 9900 terminals, the SCAN key captures images. On the 9950 and 9951, you can also use the [Scan Trigger](#) (see page 3-7).

File Formats

File formats supported for image storage include Bitmap (BMP), JPEG (JPG) and Portable Network Graphics (PNG). The default file format for images is a grayscale JPG.

Compression

Digital images have a maximum image size of 640 x 480 pixels and may have up to a 256 grayscale image definition.

The image quality and related file size are determined by the data compression method used by the software application used to take images. The average size of the image file is approximately 4–8K. However, the size of the image depends on the content of the image - the more complex the content, the larger the file size. For the highest quality image, take grayscale images.

Taking an Image

The following steps are basic guidelines for taking images:

1. Point the Dolphin terminal directly at the object. The imager points straight out the top panel.
2. To preview the image, press and hold the SCAN key.
3. The touch screen displays a preview of the object, and the decode and scan LEDs light red.
4. Adjust the terminal's position until the object appears on the screen the way you want it to appear in the image.
5. Hold the terminal still and release the SCAN key or Scan Trigger. The scan and decode LEDs flash red, the screen flashes, and the captured image appears on the screen.



6. Unless otherwise specified by the application in use, the image is saved to the **My DeviceMy Documents** folder (**Start > Programs > File Explorer > My Device > My Documents**).

Enabling the Aimer

If your Dolphin terminal is configured with the 5300 imager, you can enable the aiming pattern for imaging in the Imaging Demo. For details about the aimer, see [5300 Red High-Vis Aiming Pattern](#) on page 4-5.

1. Tap **Start > Demos > Imaging Demo > Setup** menu > **Aimer**.

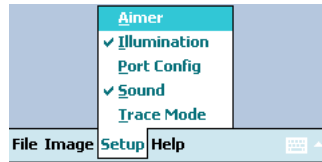

2. The aiming pattern is now enabled for imaging.

Uploading Images

Image files can be uploaded to a host workstation via Microsoft ActiveSync and a Dolphin communication peripheral or your wireless radio connection.



Using the Keyboards

Available Keyboards

There are three keyboard options in the 9900 series:

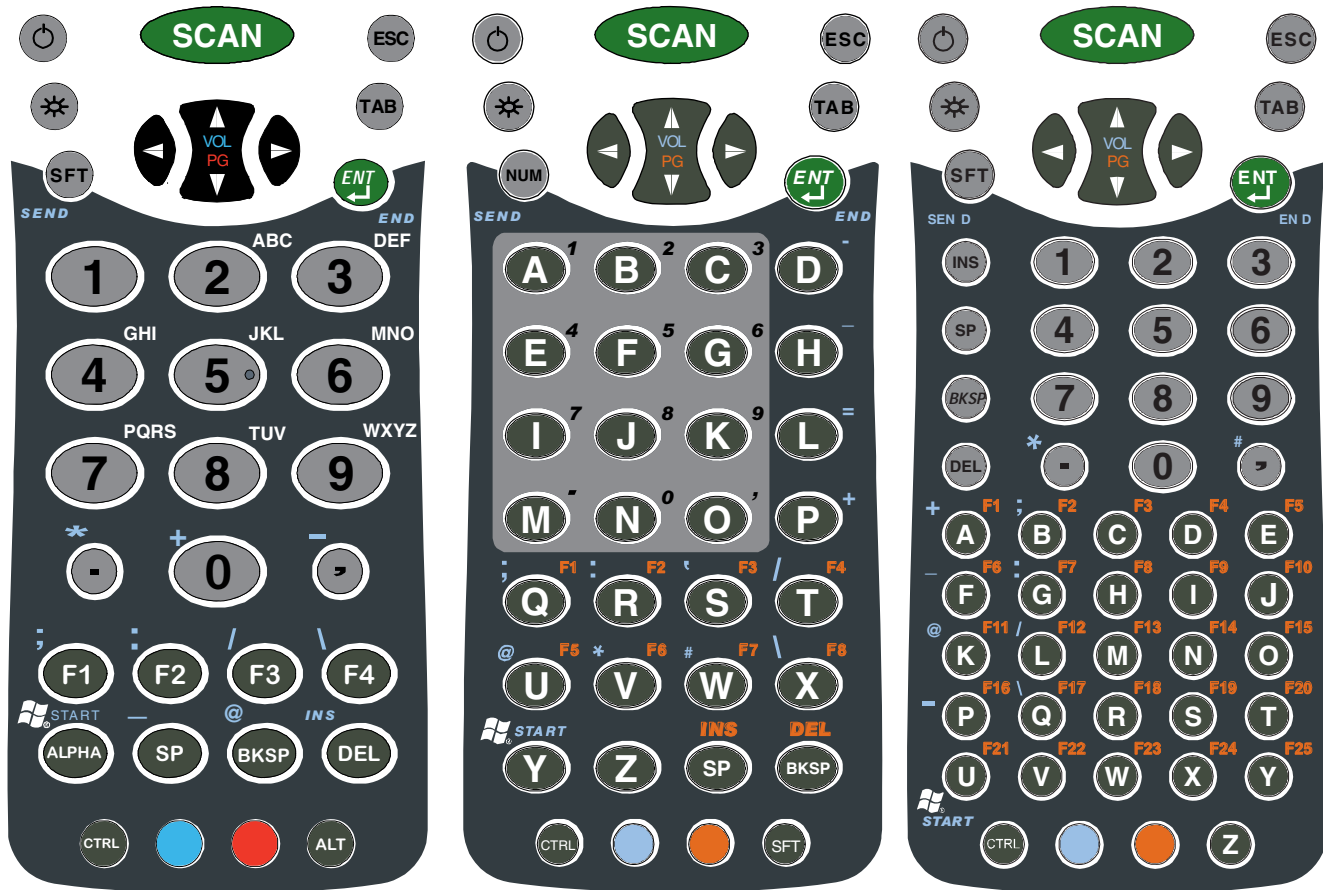

All Keyboards Contain the Following:

- Backlit for easy viewing in various lighting conditions.
- Centrally-located keys for both right- and left-hand operation.
- Color-coding so you can clearly see the most common keyboard combinations.
- A silver background to enhance readability.
- Function, navigation, and modifier keys.

Keyboard Combinations

See [35-Key Keyboard Combinations](#) on page 5-6.

See [43-Key Alpha/Numeric Keyboard](#) on page 5-8.

See [56-Key Full Alpha/Numeric Keyboard](#) on page 5-11.









Common Buttons

See [Using the Function Keys](#) on page 5-2.



See [Using the Modifier Keys](#) on page 5-3.

See [Using the Navigation Keys](#) on page 5-3.

Using the Function Keys





Name	Key	Function
Backlight		Turns the keyboard backlight on and off.
Backspace (BKSP)		Moves the cursor back one space each time the key is pressed. If you are typing text, it deletes the previous character each time it is pressed.
Delete (DEL)		Deletes the next character forward each time the key is pressed. This key appears on the 56-key keyboard only. 43-key keyboard= Red + BKSP.
Enter (ENT)		Confirms data entry.
Escape (ESC)		Cancels the current action.
Power Key		Puts the terminal in and wakes the terminal from suspend mode; see Suspend Mode on page 3-18.
SCAN Key		Activates the scan and “wakes” the terminals from sleep mode. Its position allows convenient one-handed image-taking and/or bar code decoding.
Space (SP)		Moves the cursor one space.
Tab		Moves the cursor to the next tab stop or the next control (on a form).

Using the Modifier Keys

Name	Key	Function
Shift		The SFT key modifies only the next key pressed; it must be pressed before each key you wish to modify. SFT toggles the keyboard between uppercase alphabet mode and lowercase alphabet mode. Double-tap SFT to toggle Caps Lock on and off. When Caps Lock is toggled on, characters are uppercase; when toggled off, characters are lowercase.
CTRL		The function of the CTRL key depends on the software application in use and the key combination.
Blue and Red		The blue and red keys are used in combination with other keys to type special characters and perform system functions. Each key modifies only the next key pressed. The overlay of each keyboard is color-coded to indicate the character typed or function performed when specific keys are pressed immediately after the blue or red modifier key.

Using the Navigation Keys

Located in the center of each keyboard for easy access with either hand, the navigation keys navigate the cursor through application screens.

Button	Function
	Moves the cursor up one row or line. OR Moves the cursor down one row or line.
	Raises the volume. OR Lowers the volume.
	Moves the cursor one character to the right.
	Moves the cursor one character to the left.

Note: Additional functionality varies according to the application in use.

Sticky Key Functionality

Sticky key functionality is supported for the CTRL key, which means that you don't have to press and hold the CTRL key when you press the next key. Instead, just tap CTRL and then the next key.

You need to open RegEdit and enable the `\HKEY_LOCAL_MACHINE\HARDWARE\DEVICEMAP\KEYBD` key.

1. Tap **Start > Power Tools > RegEdit**  .
2. Tap the + sign.
3. Tap **HKEY_LOCAL_MACHINE > HARDWARE > DEVICEMAP > KEYBD**.

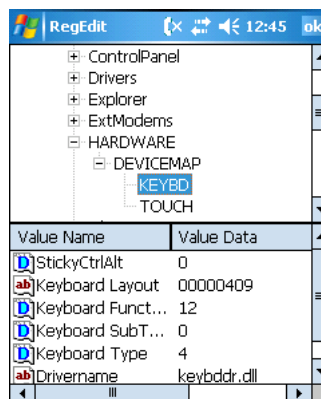

4. In the bottom half of the window, double-tap the **StickyCtrlAlt** key and change the Value Data from "0" to "1."

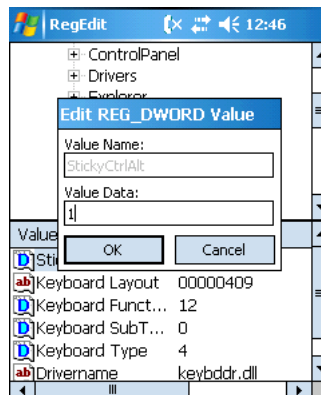

5. Tap **OK**, then **OK** in the upper right corner to save the change to the registry.
6. Press the CTRL key combination with other keys to verify that you do not need to hold them down while you press the next key. For an example of CTRL key combinations, see [General Windows Keyboard Shortcuts](#) on page 5-14.

35-Key Alpha/Numeric Keyboard

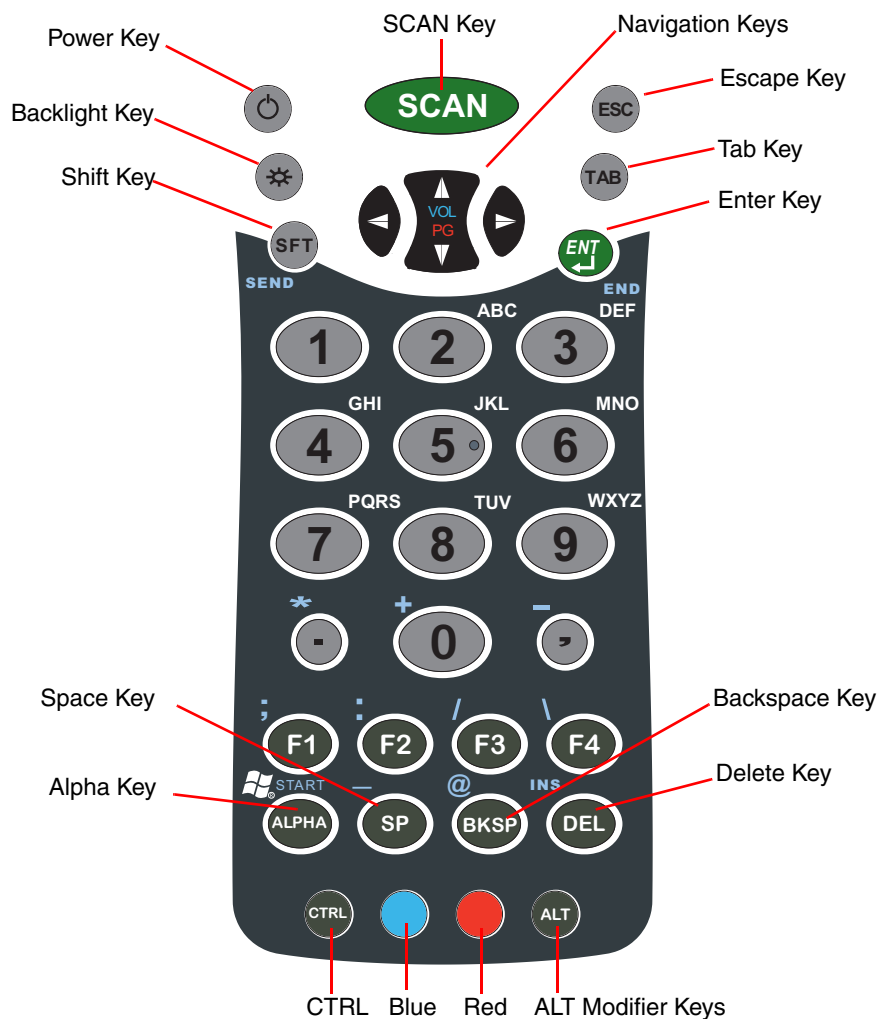

ALPHA Key

The ALPHA key enables you to toggle between the alpha and numeric modes.

- Single-tap ALPHA to switch only the next key pressed to alpha mode.
- Double-tap ALPHA to switch the keyboard to alpha mode.

Alpha mode is when you type letters with the letter keys. Numeric mode is when you type numbers with the letter keys. On the 35-key keyboard, numeric mode is the default.

35-Key Keyboard Combinations

Key	NUM	Shift-NUM	Alpha	Shift-Alpha	BLUE	RED
Power	Suspend/Resume					
Scan	Scan	Scan	Scan	Scan		
ESC	Escape	Escape	Escape	Escape		
Backlight	Toggles Keyboard Backlight On/Off					
TAB	Tab	Tab	Tab	Tab		
SHIFT	Shift		Shift		Send (phone call)	
ENTER	Enter	Enter	Enter	Enter	End (phone call)	
Left	Left	Left	Left	Left		
Up	Up	Up	Up	Up	Volume Up	Prior
Down	Down	Down	Down	Down	Volume Down	Next
Right	Right	Right	Right	Right		
1	1	!	1	!		
2	2	@	a,b,c	A,B,C		
3	3	#	d,e,f	D,E,F		
4	4	\$	g,h,i	G,H,I		
5	5	%	j,k,l	J,K,L		
6	6	^	m,n,o	M,N,O		
7	7	&	p,q,r,s	P,Q,R,S		
8	8	*	t,u,v	T,U,V		
9	9	(w,x,y,z	W,X,Y,Z		
Period	. (period)	>	. (period)	>	* (multiply)	
0	0)	0)	+ (add)	
Comma	, (comma)	<	, (comma)	<	- (subtract)	
F1	F1	F1	F1	F1	; (semi-colon)	
F2	F2	F2	F2	F2	: (colon)	
F3	F3	F3	F3	F3	\ (backslash)	
F4	F4	F4	F4	F4	/ (forward slash)	
ALPHA	NUM Lock	NUM Lock	NUM Lock	NUM Lock	Start Menu	
Space	Space	Space	Space	Space	_ (underscore)	

Key	NUM	Shift-NUM	Alpha	Shift-Alpha	BLUE	RED
BKSP	Backspace	Backspace	Backspace	Backspace	@	
Delete	Delete	Delete	Delete	Delete	Insert	
CTRL	Control		Control			
Blue	Blue		Blue			
Red	Red		Red			
ALT	Menu		Menu			

43-Key Alpha/Numeric Keyboard

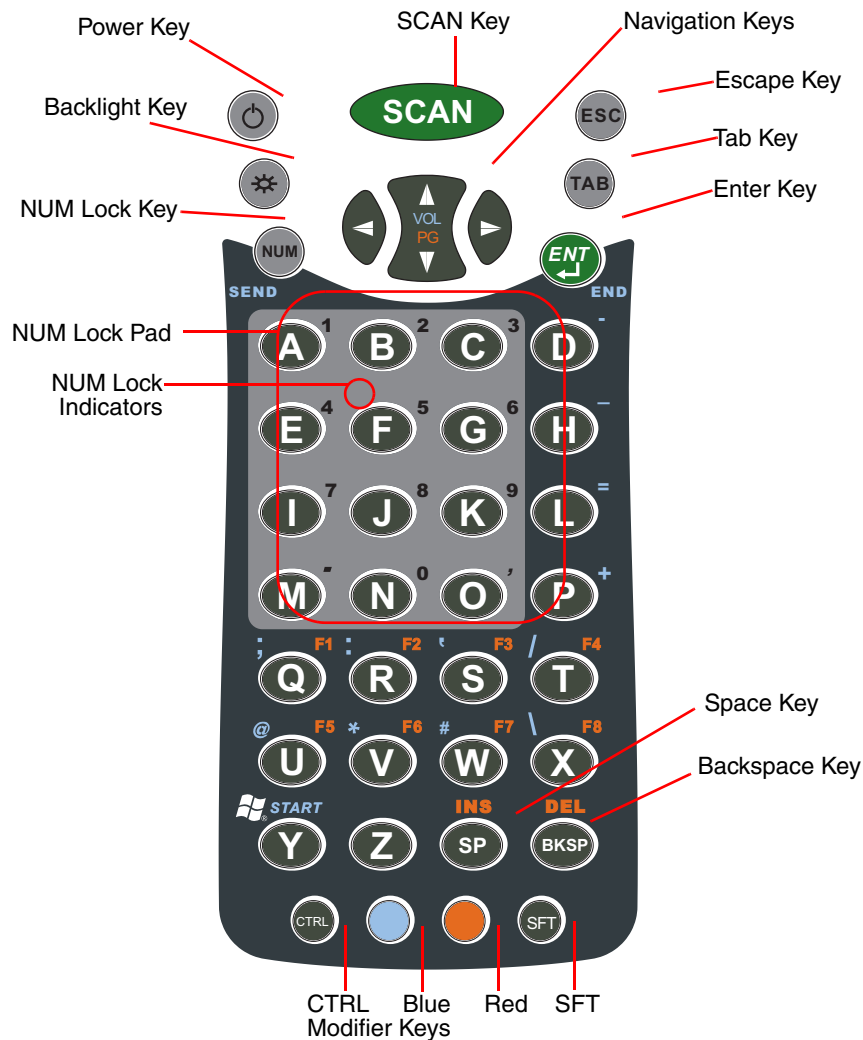

Number Lock (NUM) Key



The Number Lock key enables you to toggle between the alpha and numeric modes. Alpha mode is when you type letters with the letter keys. Numeric mode is when you type numbers with the letter keys. On the 43-key keyboard, alpha mode is the default.

Toggling Between Alpha and NUM Lock Modes

Press the NUM key only once to switch to NUM lock mode.

The **NUM Lock Indicators** above the letter keys in the **NUM Lock Pad** specify the number or character that will be typed when you press that letter key in numeric mode.

Note: The NUM key is also used to perform a soft reset in combination with the CTRL key.

43-Key Keyboard Combinations

Alpha	Alpha Shift	NUM Lock	NUM Shift	BLUE	RED
a	A	1	!		
b	B	2	@		
c	C	3	#		
d	D	d	D	- (subtract)	
e	E	4	\$		
f	F	5	%		
g	G	6	^		
h	H	h	H	_ (underscore)	
i	I	7	&		
j	J	8	*		
k	K	9	(
l	L	l	L	= (equals)	
m	M	. (period)	>		
n	N	0)		
o	O	, (comma)	<		
p	P	p	P	+ (plus)	
q	Q	q	Q	; (semi-colon)	F1
r	R	r	R	: (colon)	F2
s	S	s	S	' (apostrophe)	F3
t	T	t	T	/ (forward slash)	F4
u	U	u	U	@	F5
v	V	v	V	*	F6
w	W	w	W	#	F7
x	X	x	X	\ (backslash)	F8
y	Y	y	Y	Start menu	
z	Z	z	Z		
SP	Space	Space	Space		Insert
BKSP	Backspace	Backspace	Backspace		Delete
Up arrow	Up	Up	Up	Volume up	Page up

43-Key Keyboard Combinations

Alpha	Alpha Shift	NUM Lock	NUM Shift	BLUE	RED
Down arrow	Down	Down	Down	Volume down	Page down
SFT	Shift	Shift	Shift	Send (a phone call)	
ENT	Enter	Enter	Enter	End (a phone call)	

56-Key Full Alpha/Numeric Keyboard

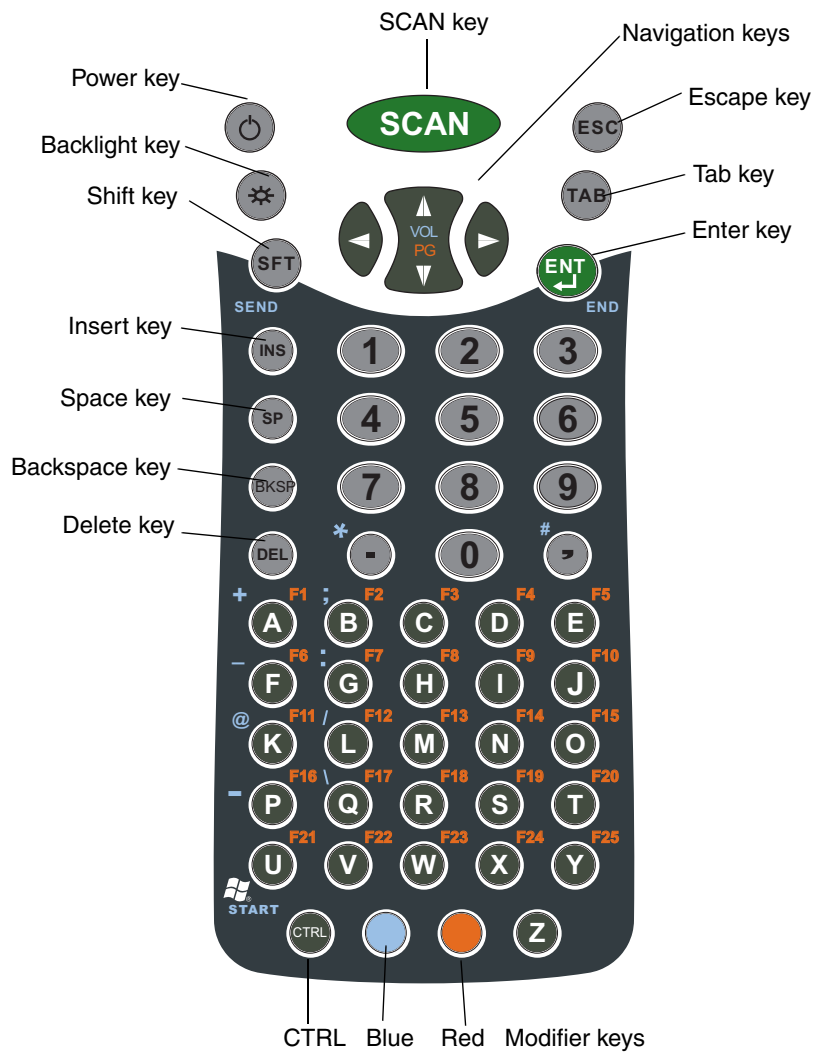

56-Key Keyboard Combinations

Key	SHIFT	BLUE	RED
1	!		
2	@		
3	#		
4	\$		
5	%		
6	^		
7	&		
8	*		
9	(
0)		
, (comma)	<	# (pound)	
. (period)	>	* (asterisk)	
A		+ (plus)	F1
B		; (semi-colon)	F2
C		[(left bracket)	F3
D] (right bracket)	F4
E		" (quotes)	F5
F		- (minus)	F6
G		: (colon)	F7
H		' (apostrophe)	F8
I		? (question mark)	F9
J		` (accent)	F10
K		@	F11
L		/ (forward slash)	F12
M		= (equal sign)	F13
N		~ (tilde)	F14
O			F15
P		_ (underscore)	F16
Q		\ (backslash)	F17

56-Key Keyboard Combinations

Key	SHIFT	BLUE	RED
R			F18
S			F19
T			F20
U		Start menu	F21
V			F22
W			F23
X			F24
Y			F25
Z			
Up arrow		Volume up	Page up
Down arrow		Volume down	Page down
SFT		Send (a phone call)	
ENT		End (a phone call)	
Blue	Toggle CAPSLOCK		

General Windows Keyboard Shortcuts

Press these keys,	To...
CTRL + C	Copy
CTRL + X	Cut
CTRL + V	Paste
CTRL + Z	Undo
DELETE	Delete
CTRL + Right Arrow	Move the insertion point to the beginning of the next word.
CTRL + Left Arrow	Move the insertion point to the beginning of the previous word.
CTRL + Down Arrow	Move the insertion point to the beginning of the next paragraph.
CTRL + Up Arrow	Move the insertion point to the beginning of the previous paragraph.
SHIFT + any of the arrow keys	Select more than one item in a window or on the desktop, or select text within a document.
CTRL+ A	Select all
CTRL + ESC	Display the Start menu.
Underlined letter in a command name on an open menu	Carry out the corresponding command.
Backspace	View the folder one level up in My Computer or File Explorer.

System Settings

Overview

Customized settings are available on the Start menu. Tap **Start > Settings** and the settings screen opens displaying the Personal tab. Settings consists of three tabs: Personal, System, and Connections.

Personal Tab

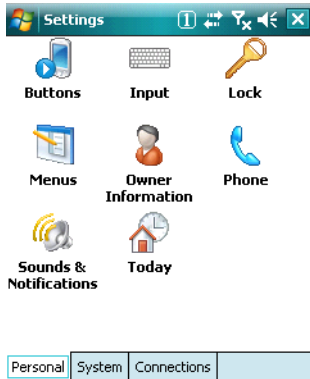

System Tab

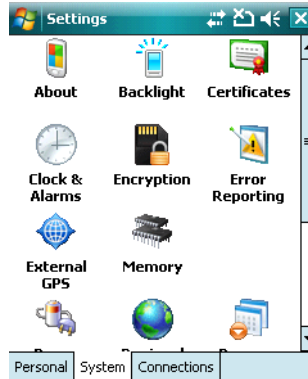

Connections Tab



Tab	Description	See Page
Personal	Customizes buttons, set SIP options, and adjust headset settings.	See Personal Tab on page 6-2.
System	Adjusts system settings.	See System Tab on page 6-7.
Connections	Establishes network connections settings.	See Connections Tab on page 7-1.

Personal Tab

To access the Personal tab, go to **Start > Settings**. The screen opens displaying the Personal tab.

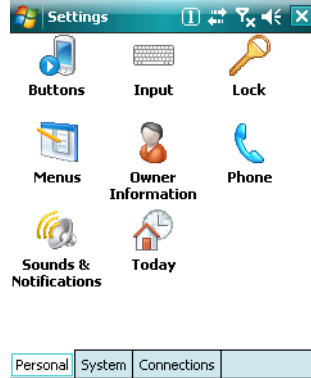

Icon	Description	See Page
Buttons	Program the side buttons to perform specific tasks.	See Buttons on page 6-3.
Input	Customizes the SIP (soft input panel).	See Input on page 6-4.
Lock	Password protect the terminal to limit access to the terminal.	
Menus	Customizes what appears on the Start menu.	See Menus on page 6-5.
Owner Information	Enter your contact information. This information will appear on the Today screen.	
Phone	When the GSM radio is enabled, tap this icon to set up user parameters.	See Setup Options on page 8-7.
Sounds & Notifications	Set the sound volume, enables and disables sounds for specific actions, and sets sound parameters for system notifications.	
Today	Customize the look and the information displayed on the Today screen.	

Note: Personal settings are stored in RAM memory. They are replaced by system defaults after each hard reset. For more information about resets, see [Soft Reset \(Warm Boot\)](#) on page 3-18.

Buttons

The Buttons setting programs certain keyboard buttons to launch applications or execute commands.

Enable HotKeys

Default Buttons setting assignments inactive until you enable the HotKeys Power Tool. Tap **Start** >

 **Power Tools** and tap the HotKeys icon **once** . HotKeys is enabled, and the button assignments in the Buttons setting are active.

For more information about the HotKeys Power Tool, refer to the Dolphin Power Tools User's Guide, which is available for download from the web at www.honeywellaidc.com.

Changing Button Assignments

1. After HotKeys is enabled, tap **Start** > **Settings** > **Personal** tab > **Buttons** 

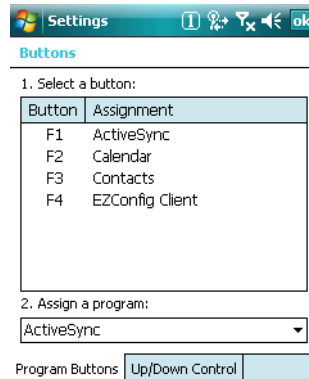

Note: The buttons that appear on this window are the only buttons that can be programmed via the Buttons setting. You cannot add buttons to this window.

2. To change button assignment, tap on the name of the application in the **Assignment** column and select a program or command in the **Assign a program** drop down list.
3. Tap **OK** to save.
4. Press the button to verify that the program is launched or action performed.

Available Applications

The **Assign a program** list contains the applications installed on the terminal. If there is a program installed that you would like to see in this list, paste a Shortcut to the program in the **\\Windows\Start Menu\Programs** folder. For instructions about creating shortcuts, see [Using File Explorer](#) on page 6-5.

Additional Functions

The **Assign a program** list also contains the following commands:

Command	Description
<Input Panel>	Opens the soft input panel.

Command	Description
<None>	Nothing happens when the button is pressed.
<OK/Close>	Performs the same function as tapping OK on the screen.
<Scroll Down>	Scrolls down in the open application.
<Scroll Left>	Scrolls left in the open application.
<Scroll Right>	Scrolls right in the open application.
<Scroll Up>	Scrolls up in the open application.
<Start Menu>	Opens the Start menu.
<Today>	Opens the Today screen.

Input

The Input settings enables you to customize input from the SIP, adjust word completion settings in Microsoft applications.

Input Method

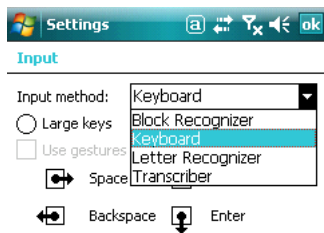

Input Method Word Completion Options

Word Completion

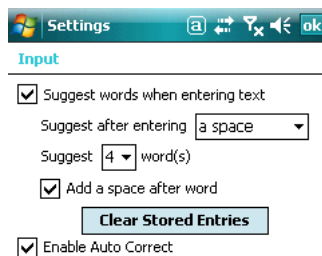

Input Method Word Completion Options

Options

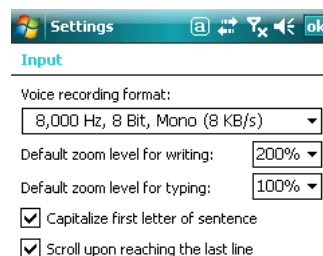

Input Method Word Completion Options

Menus

You can add existing programs you use often, such as File Explorer, to the Start menu for faster access. You are not installing the program, just allowing access to it from the Start menu.

To add programs to the Start menu, you can use

- The Menu setting on the Personal tab (see page 6-5),
- File Explorer (see page 6-5), or
- ActiveSync (see page 6-6).

Note: The Start menu can hold only seven applications at a time.

Using System Settings

1. Tap **Start > Settings > Personal tab > Menu**  **Menu**.

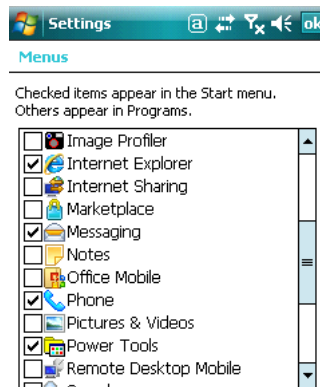

2. Tap the check box for the program you want to add and tap **OK** to save.

Note: If you try to go over seven applications, a warning message appears and you will have to delete applications as necessary.

3. Tap the **Start** menu to verify that the program appears on it.

Using File Explorer

If you do not see the program listed, you can either use File Explorer to move the program or ActiveSync on the workstation to create a shortcut to the program and place the shortcut in the Start Menu folder.

Note: We recommend that you Copy and Paste Shortcut so that you do not alter your program configurations by accident. Using Copy and Paste Shortcut (as opposed to Cut and Paste) ensures that the program files remain where they need to be for the system to find them to perform system functions.

1. Tap **Start > Programs > File Explorer**, and navigate to the program. File Explorer opens to My Documents by default; to see a list of all folders, tap the folder name and then **My Device**.

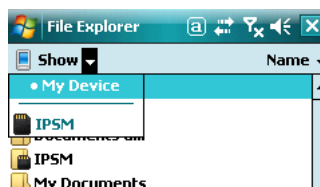

-
2. Tap and hold on the program, then tap **Copy** on the pop-up menu.
 3. Navigate to the Windows folder and open the Start Menu (My Device > Windows > Start Menu), tap and hold a blank area of the window, and tap **Paste Shortcut** on the pop-up menu.

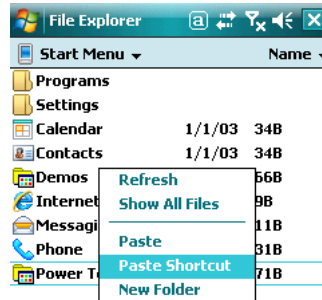

4. Tap the **Start** menu to verify that the program now appears on it.

Using ActiveSync on the Workstation

Here, you are performing the same basic process as on the terminal, except that you are using the Explore utility (Windows Explorer) to copy and paste the shortcut.

1. Open **ActiveSync > Explore** and navigate to the program.
2. Right-click on the program and select **Create Shortcut**.
3. Select the shortcut, right-click, and select **Cut**.
4. Navigate to the **Start Menu** folder (Windows > Start Menu).
5. Right-click on an empty area and select **Paste Shortcut**.
6. On the terminal, tap the **Start** menu.
7. Verify that program appears.

System Tab

The System tab enables you to verify and sometimes alter system parameters. To access the System tab, go to **Start > Settings > System** tab. Tap the appropriate icon to open that system setting.

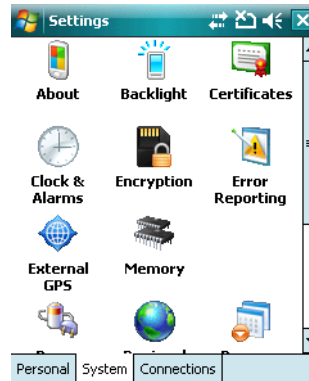

Icon	See Page
About	See About on page 6-8.
Backlight	See Backlight on page 6-8.
Certificates	See Certificates on page 6-9.
ClearType Tuner	See ClearType Tuner on page 6-9.
Clocks & Alarms	See Clock & Alarms on page 6-9.
Encryption	See Encryption on page 6-10.
Error Reporting	See Error Reporting on page 6-10.
External GPS	See External GPS on page 6-10.
Memory	See Memory on page 6-11.
Power	See Power on page 6-12.
Regional Settings	See Regional Settings on page 6-13.
Remove Programs	See Remove Programs on page 6-13.
Screen	See Screen on page 6-14.
WAN Info	See WAN Info on page 6-15.

About

The About system setting displays specific information about the terminal. It contains three tabs:

Version Tab Displays the information about the software, operating system, and processor.

Device ID Tab Displays the information the terminal uses to identify itself to other devices. It can be important to know this information if the Dolphin terminal is going to be part of a networked system of devices.

Device name: Displays the system's default name. (This is the name used by ActiveSync.)

Description: Displays the description of the device ID.

Copyrights Tab Displays important copyright information.

Backlight

The Backlight system setting enables you to customize backlight functionality for the display. The backlight for the color display is user-defined. Tap **Start > Settings > System tab > Backlight**.

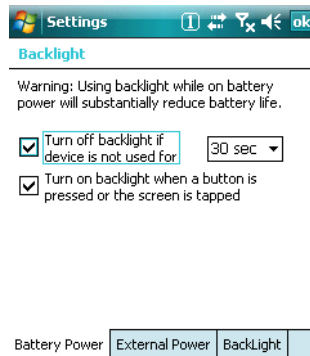

There are two tabs:

The Battery tab determines the backlight timeout when the terminal is running on battery power.

The External tab determines the backlight timeout when the terminal is running on external power.

The options on each tab are the same.

Turn off backlight: Select how many minutes you want to elapse before the backlight automatically turns off.

Turn on backlight: Select this option if you want the backlight to turn on when the a button is pressed or the touch screen is tapped.

Backlight Intensity

Tap the **Backlight** tab and move the slider to set the intensity of the backlight. The default is 8.

Certificates

The Certificates option shows you the certificates recognized by the operating system.

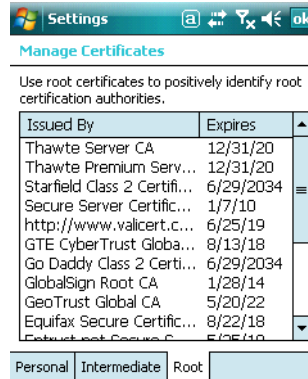

ClearType Tuner

This system setting enables you to adjust the level ClearType font rendering by moving a slider. The sample text displays the setting results immediately. Of course, you must first enable ClearType font rendering to change the appearance of fonts on the screen; see [ClearType Tab](#) on page 6-14.

Clock & Alarms

This setting sets the system clock, which means that all scheduled items run according to this setting. The time and date need to be reset after every hard reset of the terminal so that the system clock is accurate. On the Today screen, tap the line that displays the time and date,

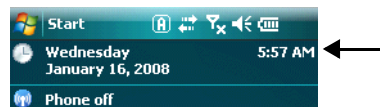

The Clock Settings screen appears. The selected time sets the system clock.



Encryption

Encryption gives you the option of encrypting files placed on storage cards so that those files cannot be read by any other device.



Error Reporting

Error Reporting gives you the option of enabling or disabling the error reporting function of Windows Mobile 6.1.



External GPS

External GPS determines which port a third-party GPS software application can use to access the GPS receiver.

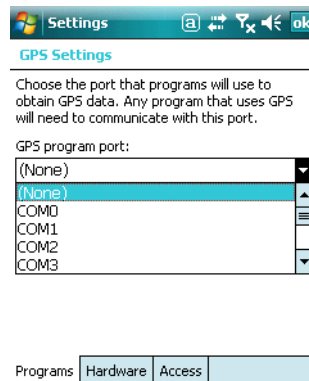

Note: You need the installation parameters from the GPS manufacturer to configure the connection.

Memory

The Memory system setting displays capacity and usage statistics for both RAM (volatile) and IPSM/ Storage Card (non-volatile) memory. Access this setting whenever you receive system messages about memory.

You cannot change the terminal's memory allocation in the Memory system setting. To change the memory allocation, you need to use the SetRAM Power Tool (Start > Power Tools > SetRAM). For more details, please refer to the Honeywell Power Tools User's Guide, which is available for download from www.honeywellaidc.com.

There are three tabs: Main, Storage Card, and Running Programs.

Main Tab

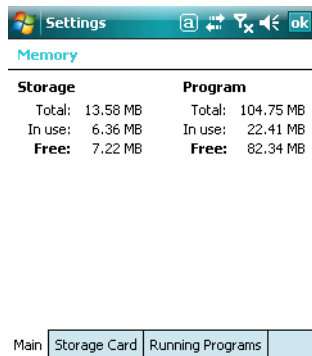

This tab displays the usage statistics of the on-board, volatile RAM memory.

Columns:

Storage=RAM memory used to store programs and program data.
Program=RAM memory used to run programs.

Rows:

Total= Displays the current MB of memory allocated for use.
In use=Displays the total MB of that allocated memory being used.
Free=Displays the total MB of memory available.

Storage Card Tab

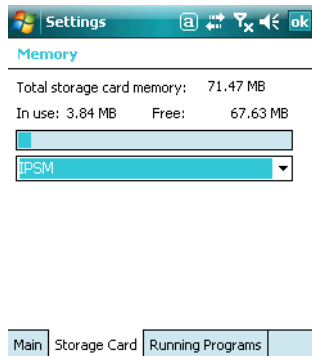

This tab displays the current capacity and usage statistics of the selected memory type; IPSM or Storage Card.

Select the memory type from the drop-down list. IPSM is selected by default.

Total storage card memory=

The total MB of memory capacity of IPSM or Storage Card.

In use=The MB currently being used.

Free=The MB that is still available for use.

IPSM—Short for Internal Persistent Storage Manager, this is the on-board Flash memory that is non-volatile. Because this memory is non-volatile, data or programs stored in IPSM are not affected when power is removed. Autoinstall programs, for example, are stored in IPSM so that they are always installed at cold-boot startup.

Storage Card—You can install one memory card in Dolphin terminals (see [Memory Card Door](#) on page 3-10). If a storage card is installed in the terminal, you can select it in the drop-down list and see capacity and usage statistics for the card.

Running Programs Tab

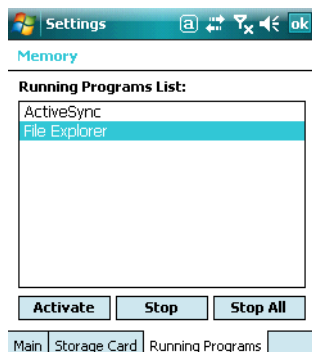

Displays the software programs currently using Storage memory.

Check this tab when you are receiving out of memory errors or when the mobile computer is running slowly.

You can

- Select a program in the list and tap **Stop** to stop it from running (and therefore from using memory), or
- Tap **Stop All** to automatically stop all running programs.

 Anytime you stop a running program, it frees up RAM memory. Be advised that, when you stop a program here, any unsaved data in that program is lost. To free up memory without risking data loss, return to the running program, save your data, and close the application.

Power

Power system settings contains two tabs: Battery and Advanced.

Battery Tab

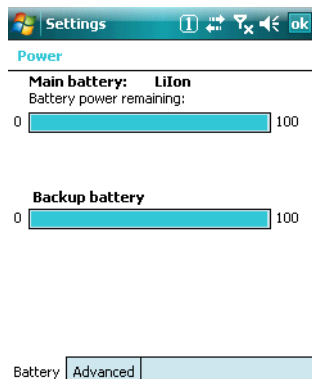

For more information, see [Batteries](#) on page 3-14.

Advanced Tab

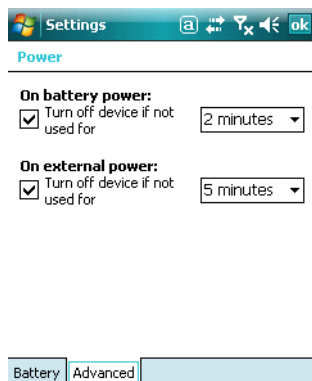

Determines power time-outs.

For **On battery power**, select from the drop-down list, the number of minutes of inactivity you want to pass before the terminal powers off when running on battery power.

For **On external power**, select from the drop-down list, the number of minutes of inactivity you want to pass before the terminal powers off when running on external power.

Note: You can also set automatic turn-off times for the terminal to conserve power. When the terminal is “turned off,” that means that it goes into suspend mode; see [Suspend Mode](#) on page 3-18.

Regional Settings

Regional Settings enables you to customize the appearance and formatting to your geographic region. Specifically, you can customize numbers (i.e., number of decimal places allowed), currency (i.e., using the \$ or € symbol), time, and date. These specifications apply to all screens, including the Today screen. The Region tab displays an overview of the region selected in the drop-down list at the top.

The terminal is loaded with a number of pre-programmed regional settings. Select one from the list and the results appear on the screen. To see specific settings or change a specific setting, tap on one of the tabs, make the change and tap **OK** to save it.

Remove Programs

Remove Programs enables you to remove programs installed on the terminal. Use this setting to troubleshoot when you receive messages that the terminal is out of memory. The programs removed are removed from RAM memory. Any program (usually CAB or DLL files) stored in the Autoinstall folder (My Device > IPSM > Autoinstall) will re-install after the next hard reset.

For information about the hard reset process, see [Hard Reset \(Cold Boot\)](#) on page 3-18.

1. Tap **Remove Programs**. In the list, select the program you want to remove.



2. Tap **Remove**. The following message appears:

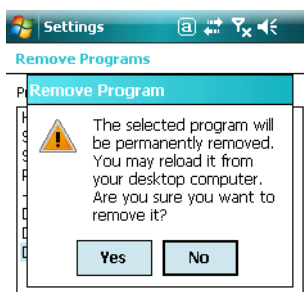

3. Tap **Yes**. Wait while the program is removed.
4. Verify that the program no longer appears in the list.

Screen

The Screen system setting contains three tabs: Alignment, Clear Type, and Text Size.

Alignment Tab

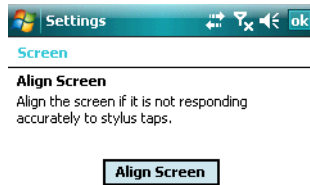

You need to re-align the screen if tapping buttons or icons with the stylus no longer seems to work appropriately.

Tapping **Align Screen** brings up the align screen window where you are guided to tap a target several times. This re-calibrates how the touch screen receives input.

- Alignment should always be performed with a stylus designed for touch panel applications. The small point is required for accurate calibration.
- Press the stylus firmly into the center of the cross-hair target once and release. Do not “double-tap” the target.

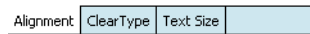

Note: By default, dynamic screen rotation (i.e., the ability to switch between landscape and portrait orientation) is disabled on all 9900 terminals. Please consult the Dolphin SDK Add-on to find out how to enable dynamic screen rotation.

ClearType Tab

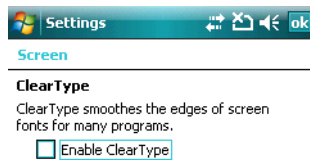

The display supports ClearType font rendering, which is a Microsoft technology that dramatically increases the readability of text on LCD displays.

To enable ClearType font rendering, select **Enable ClearType** and tap **OK**. To adjust the level of ClearType font rendering, use the ClearType Tuner; see [ClearType Tuner](#) on page 6-9.

For more information about ClearType font rendering, visit: www.microsoft.com/typography/cleartype/what.htm?fname=%20&fsize=

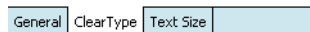

Text Size Tab

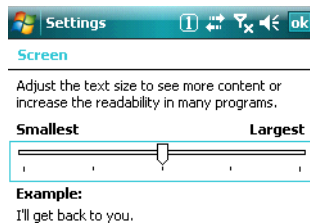

The Text Size tab enables you to perform font scaling within certain views of the

- Today screen,
- Contacts,
- Calendar,
- Messaging, and
- Tasks.

Font scaling means that you can increase or decrease the point size of the font on application windows.

To change the font size, move the slider toward **Smallest** or **Largest**. The Example text changes to reflect the font change. Tap **OK** to save the new font size setting.

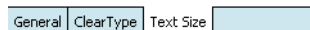

WAN Info

When the GSM radio is active, WAN Info displays useful statistics for the radio.

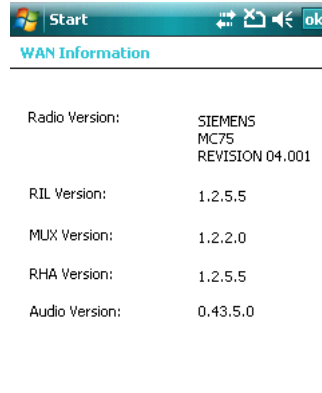

To verify whether or not the GSM radio is enabled, check the [Dolphin Wireless Manager](#) (see page 7-6).

Windows Update







Windows Update is designed to download Microsoft updates to the operating system directly from Microsoft.



Connections Tab

The Connections system setting provides access to the terminal's various wireless communication options.



Icon	Setting	Tapping this icon...	See Page
 Beam	Beam	Enables infrared communication.	7-11
 Bluetooth	Bluetooth	Configures the Bluetooth radio. This icon appears only if a Bluetooth radio and driver are installed on the terminal.	9-1
 Connections	Connections	Opens Microsoft's connections manager.	7-4
 Dolphin Wirele...	Dolphin Wireless Manager	Manages the wireless radios installed in the terminal.	7-6
 USB to PC	USB to PC	Enables advanced, wired USB communication via ActiveSync.	7-8
 Wi-Fi	Wi-Fi	Enables you to configure Wireless Zero Config (WZC). This icon appears only if the 802.11b/g driver is loaded on the terminal and the Honeywell WLAN Security Supplicant is not loaded. By default, the Wireless Zero Config is disabled and the supplicant is loaded. This icon appears only if you removed the supplicant and cold boot the terminal.	

Note: All server-assigned IP addresses use Dynamic Host Configuration Protocol (DHCP).

Using the IrDA Port

Using the IrDA port, you can send and receive data between the terminal and other devices equipped with infrared. This can include, but is not limited to, Windows Mobile information such as Contacts and Tasks, as well as software upgrades.

The maximum data transfer speed is 115 Kbps.

IrDA Port Location

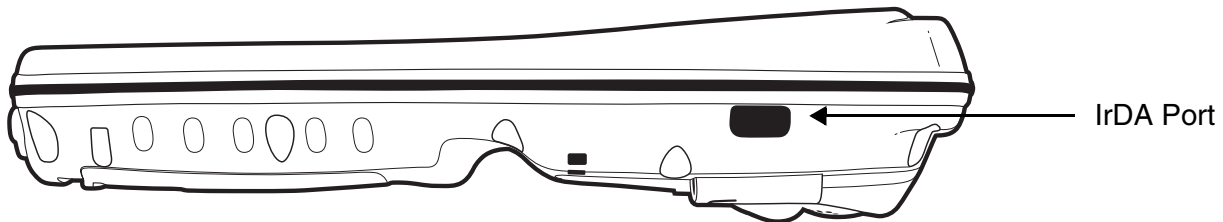

To send or receive, the IrDA ports of both devices - whether it's two terminals, or a terminal and a host device - must be aligned with each other and within a close range. The maximum data-transfer speed is 115 Kbps.

Sending Data

1. Align the IrDA ports.
2. Open the program where you created the item you want to send and locate the item in the list. You can also beam files, but not folders, from File Explorer.
3. Tap and hold the item and select **Beam File**.

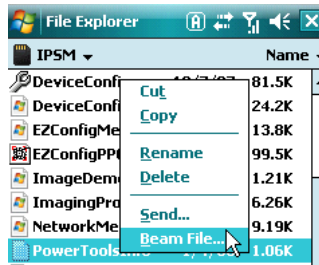

4. The IrDA port searches for a receiving IrDA port in the vicinity. The selected device reads "Pending."

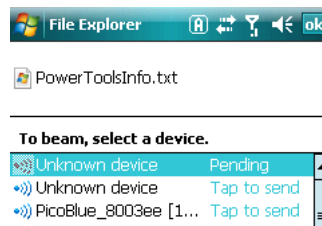

-
- When the IrDA port finds the aligned IrDA port, it immediately starts sending the selected file. The selected device reads “Sending.”

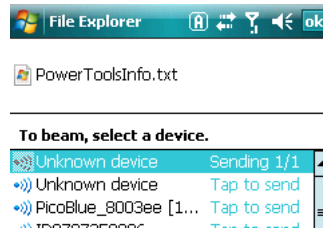

- When the file transfer is complete, the selected device reads “Done.”

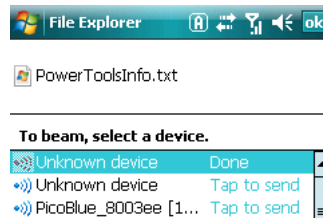

Receiving Data

The Beam Setting must be set to receive for the terminal to receive data from other infrared devices.

- Verify that beam settings are set to receive. Tap **Start** > **Settings** > **Connections** tab > **Beam**. The Beam Settings window should appear as follows:

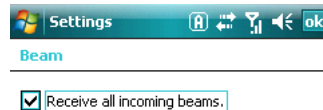

- Align the IrDA ports.
- Have the owner of the other device send the information to you.
- Your terminal automatically begins receiving it.
- A popup message appears asking if you want to receive the incoming file.

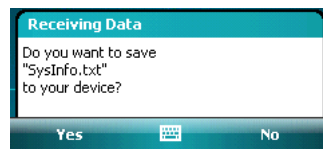

- Tap **Yes** to receive the file.

Connections Manager

Microsoft's connection manager sets up multiple network connections to Internet Service Providers (ISPs) via an external modem.

Do NOT enter connection parameters in the Connections Manager if:

- You are using one of the on-board wireless radios to connect to a network.
The Dolphin terminal uses the settings from each radio's configuration utility to connect.
- You are using Wireless Zero Config. By default, WZC is disabled on Dolphin terminals.

To Access the Connections Manager

Tap **Start** > **Settings** > **Connections** tab > **Connections** icon  **Connections**.



Task Tab

The Task tab enables you to initially configure, then manage network settings when using a modem. Select an item in this list and then complete the setup screens that follow with the appropriate information for your network.

My ISP

The links under this heading enables you to add and manage modem connections to an ISP. To complete the setup screens, obtain the following information from your ISP:

- ISP dial-up access telephone number
- Username
- Password
- TCP/IP settings

My Work Network

These links enable you to establish the following connections types:

- Modem
- Virtual Private Network (VPN)
- *Proxy server connection

To complete the setup screens, obtain the network parameters from your system administrator.

*Proxy Server Connections

If you are connected to your ISP or private network during synchronization, the terminal should download the proper proxy settings during synchronization with the PC. If these settings are not on your PC or need to be changed, ask your ISP or network administrator for the proxy server name, server type, port, type of Socks protocol used, and your user name and password.

Modify an Existing Connection

Manage Existing Connections appears on the Connections tab after at least one network connection has been established.

Tap **Manage Existing Connections** on the Tasks tab and follow the setup screens.



You will usually be walked through the same setup screens used to establish the connection.

Advanced Tab

The Advanced tab enables you to select the default network, dialing rules, and IP address exceptions for modem connections.

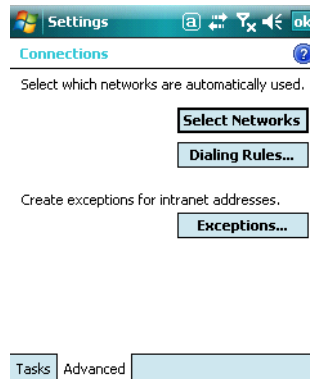

Note: You should not need to change Advanced settings because most ISPs now use DHCP addresses.

Online Help

For more information about modem connection setup, consult the online help on the setup screens by tapping the Help icon .

Dolphin Wireless Manager

The Dolphin Wireless Manager provides a centralized interface that enables and disables all the on-board radios. Each radio has its own configuration program. The Dolphin Wireless Manager also provides shortcuts to the configuration utilities for each radio.

Dolphin Wireless Manager Window

Tap **Start > Settings > Connections tab > Dolphin Wireless Manager**  .

If a rectangle is grayed-out, then the radio is not installed on the terminal.

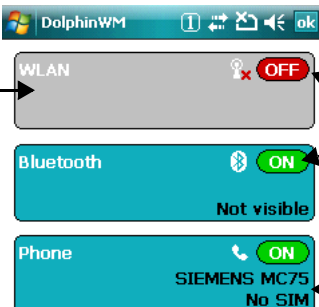

These buttons show you the state of the radio.

If applicable, information about the radio appears when the radio is activated.

Enabling the Radios

1. Tap **Start > Settings > Connections tab > Dolphin Wireless Manager**.

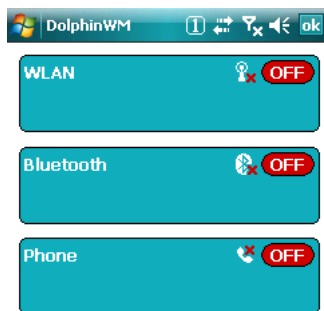

2. Tap anywhere inside the rectangle or the **OFF** button inside the rectangle. A message appears asking if you want to turn on the radio.



3. Tap **OK** and the radio begins activating.



-
4. When the radio is activated (i.e., transmitting a signal), the **OFF** button changes to **ON**.

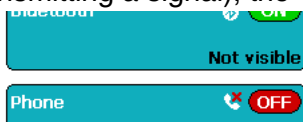

Note: If applicable, information about the radio appears in the rectangle.

Accessing Radio Configuration Utilities

Each of the three radios have their own configuration utilities that you can access through the **Menu**.



There are three radio configuration utilities:

For **802.11b/g**: Tap **WLAN Settings** and the Honeywell WLAN Security Supplicant opens.
The **Honeywell WLAN Security Supplicant User's Guide** is available for download from the Dolphin 9900 product page at www.honeywellaidc.com.

For **Bluetooth**: Tap Bluetooth Settings and the Bluetooth Settings open.
For details, see [Working with the Bluetooth Radio](#) on page 9-1.

For **GSM**: Tap **Phone Settings** and the Phone opens.
For details, see [Working with GSM](#) on page 8-1.

ActiveSync Communication

To synchronize data between the terminal and the workstation, ActiveSync 4.5 or higher must be installed and configured for the appropriate communication type on the host workstation and the Dolphin terminal. Dolphin terminals ship with ActiveSync already installed. Therefore, if ActiveSync is already installed on the host workstation, you just need to connect the Dolphin terminal to the host workstation (via Dolphin peripheral) to initiate communication.

If ActiveSync 4.5 or higher is not installed on the host workstation, install it from the Microsoft Companion CD that came with the Dolphin terminal. Insert the CD into the CD-ROM drive of the host workstation and follow the directions on your screen.

Note: You can also download the most current version of ActiveSync from www.microsoft.com and install.



When communicating via ActiveSync, your terminal is designed to be connected to the host workstation with a communication peripheral sold/manufactured by Honeywell, such as the charge/communication cable. Use of any peripheral not sold/manufactured by Honeywell may cause damage not covered by the warranty.

Capabilities

- Back up and restore your device data.
- Copy (rather than synchronize) files between your device and workstation.
- Control when synchronization occurs by selecting a synchronization mode. For example, you can synchronize continually while connected to your workstation or only when you choose the synchronize command.
- Select which information types are synchronized and control how much data is synchronized. For example, you can choose how many weeks of past appointments you want synchronized.

Communication Types

The Dolphin terminal supports the following types of communication via ActiveSync through its **I/O Connector** (see page 3-12) on the bottom panel:

- USB** The USB cable and hardware peripherals allow the terminal to communicate with a workstation or to network through a USB hub. The Dolphin terminal supports full-speed USB communication (USB 1.1); maximum data transfer rate is 12 Mbps. The Dolphin terminal defaults to USB communication out of the box.
- RS-232** The RS-232 cable allows the terminal to communicate with a workstation, modem, or any RS-232 device. Maximum data transfer rate is 115 Kbps.

Hardware Requirements for Setup

- Dolphin communication peripheral or cable
- Dolphin power cable from Honeywell
- USB cable (for USB communication)
- Serial cable (for RS-232 communication)

Software Requirements for Communication

- To sync successfully, ActiveSync v4.5 or higher must be configured for the same communication type on both the host workstation and the Dolphin terminal. ActiveSync must be setup on your workstation *before* you initiate synchronization from the terminal for the first time.
- Windows 98 Second Edition, Windows Me, Windows 2000, Windows NT (4.0 SP6 or higher), Windows XP, or Windows Vista operating systems.

Setting Up the Host Workstation

Verify that ActiveSync is configured to use the appropriate communication type by clicking **File > Connection Settings**.

For USB communication, check **Allow USB connections**.

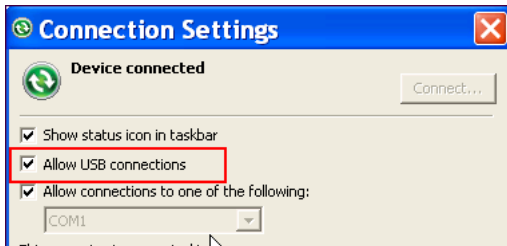

For RS-232 communication, connect to **COM1**.

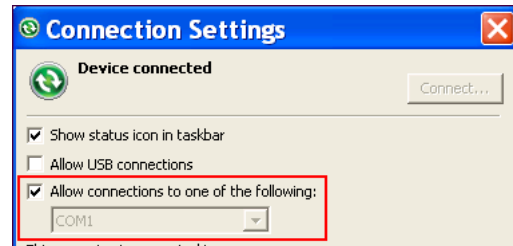

Note: You can have both USB and RS-232 selected in the software without affecting processing. However, your hardware setup should use only RS-232 or USB, not both.

Communicating with the Dolphin Terminal

After setting up both the workstation and the terminal, ActiveSync connection should be automatic.

1. Connect the Dolphin terminal to a Dolphin communication peripheral.
2. The Dolphin terminal automatically opens ActiveSync to establish a connection.

Synchronizing with the Host Workstation

After setup, synchronization begins automatically whenever the terminal's mechanical connector connects to a Dolphin peripheral that is connected to a host workstation with ActiveSync installed.

Exploring the Terminal from the Workstation

When the Dolphin terminal and workstation are connected, open the main ActiveSync window (on the desktop), and click **Explore**.

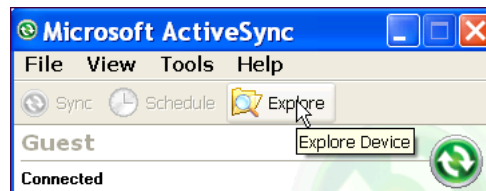

The Mobile Device folder opens in Windows Explorer.

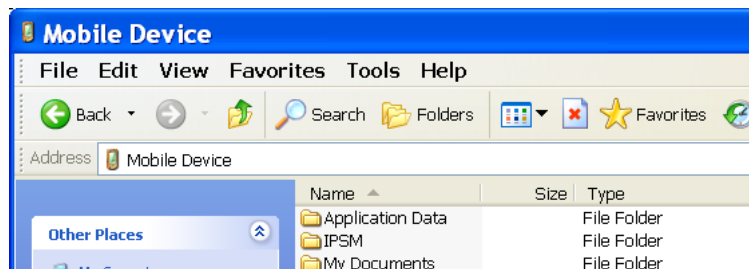

The Dolphin terminal is now treated as a mass storage device, and transferring files is as simple as dragging and dropping or copying and pasting.

Installing Additional Software

In addition to the default programs installed on your terminal when it is first booted up, you can install any program (created for a Windows Mobile-based device), as long as the terminal has enough memory to store the program and the program has an EXE, CAB, or DLL extension.

The most popular place to find software is on the Windows Mobile website: www.microsoft.com/windowsmobile/products/pocketpc/



When selecting programs, verify that the program and version of the program are designed for Windows Mobile and your processor. You can verify your processor by tapping Start > Settings > System tab > About > Version tab. Make a note of the information in the Processor field.

You can install additional software via:

- ActiveSync - see page 7-10.
- Infrared - see page 7-2.
- Network connection (via wireless radio) - see page 7-11.
- Connect to your ISP.

Adding Programs to the Terminal Using ActiveSync



When selecting programs, verify that the program and version of the program are designed for Windows Mobile and your processor. You can verify your processor by tapping Start > Settings > System tab > About > Version tab. Make a note of the information in the Processor field.

Depending on the application, the software must be stored or installed on the host PC.

1. Download the program to your desktop computer from either the Internet or the CD or disk that contains the program. You may see a single EXE or setup.exe file, a CAB file, or DLL. There may also be several versions of files for different device types and processors.
2. Read any installation instructions, Read Me files, or documentation that comes with the program. Many programs provide special installation instructions.
3. Connect the terminal to the desktop computer via a Honeywell communication peripheral.

If the File is an Installer:

An installer program is one that installs on the PC and the terminal simultaneously; one process installs to both devices.

1. On the PC, double-click the EXE or *.setup.exe file. The installation wizard begins.
2. Follow the directions on the PC screen. The installation process includes transferring the software to the terminal.

If the File is Not an Installer:

Some programs cannot be installed on PCs because they are designed for terminals. In these cases, the appropriate files must be stored on the host PC, transferred via ActiveSync, and installed on the terminal. You will know the program cannot be installed on the PC if an error message appears when you try to install it stating that the program is valid but designed for a different type of computer.

1. If you cannot find any installation instructions for the program in the Read Me file or documentation, open **ActiveSync** and click **Explore**.*
2. Navigate to the **My Pocket PC** folder and copy the program file or files to the **Program Files** folder on the terminal.
 - If you want the program to be part of the Autoinstall that occurs after every hard reset, place the program file in the **Autoinstall** folder (My Pocket PC > IPSM > Autoinstall).

-
3. Depending on the program, you may need to open **File Explorer** on the terminal, navigate to the folder where the program is located, and tap on the program file to install it.
 - If you copied the file to the **Autoinstall** folder, you can either tap on the program inside the Autoinstall folder or perform a hard reset and the program will install as part of the Autoinstall process that occurs during each hard reset. Remember, a hard reset erases RAM data! For more information, see [Hard Reset \(Cold Boot\)](#) on page 3-18.

After installation on the terminal is complete, tap **Start > Programs** and the program and its icon appears on the Programs screen. Tap it to open the program.

Adding Programs Directly from the Internet



When selecting programs, verify that the program and version of the program are designed for Windows Mobile and your processor. You can verify your processor by tapping Start > Settings > System tab > About > Version tab. Make a note of the information in the Processor field.

1. Determine your device and processor type so that you know which version of the software to install. Tap **Start > Settings > System tab > About**. On the **Version** tab, make a note of the information in the **Processor** field.
2. Download the program to your device straight from the Internet using Pocket Internet Explorer. You may see a single EXE or setup.exe file, or several versions of files for different device types and processors.
3. Read any installation instructions, Read Me files, or documentation that comes with the program. Many programs provide special installation instructions.
4. Tap the file, such as an EXE file. The installation wizard begins. Follow the directions on the screen.
5. Select the radio or radio combination and tap **Apply**. The Radio Manager begins enabling your radio or radio combination.
6. When enabled, the Status field reads "**Success.**"

9900/9950/9951 COM Port Assignment Table

COM Port	Description
COM0	Unused
COM1	Serial Port: RS-232 Connector on the bottom panel
COM2	Not accessible
COM3	IrDA: Serial Infrared (SIR) up to 115 Kbps
COM4	Not accessible
COM5	Bluetooth DUN
COM6	IrCOMM
COM7	GPS: COM Port for the GPS receiver
COM8	USB Serial: Virtual USB Serial port for ActiveSync
COM9	Bluetooth BTHATCI server

Working with GSM

Overview

The Dolphin 9900 terminal can be configured with an integrated, embedded GSM/GPRS quad-band radio module for WWAN communication.

- GSM** Short for Global System for Mobile communications, GSM is an open, non-proprietary wireless WAN system that is constantly evolving and growing.
- GPRS** Short for General Packet Radio Service, GPRS is a non-voice value added service that allows packet-switched data to be instantly sent and received across mobile telephone networks.

Note: The 9950 and 9951 are not available with GSM.

Requirements

Using GSM/GPRS requires a:

- Network subscription to a GSM/GPRS network (you need to know what service providers are in your geographic area), and
- An installed SIM card that has been activated by the network service provider (see [SIM Card Installation](#) on page 8-2).

Quad Band Antenna

The GSM radio features an external antenna that is optimized for power output and receiver sensitivity. This is an omni-directional antenna with zero dBm gain.

For the MC-75 radio, there are two different antennas based on geographical location; each supports two bandwidths:

Europe: Supports 900 MHz and 1800 MHz bands.

North America: Supports 850 MHz and 1900 MHz bands.

Signal Strength

The signal strength of the GSM connection is indicated by the number of bars that appear in the signal strength icon in the Navigation bar at the top of the window.



Icon	Indicates...
	The signal strength of the radio connection.
	The signal strength of the phone (voice) connection; see page 8-5.
	The signal strength of the data connection; see page 8-8.

Voice and Data Communication

Dolphin terminals with integrated GSM/GPRS radios are optimized for the following two-way voice and data communications:

Voice: GSM voice data ("dial-up")

Data: GPRS Class 10

Data transmissions average 40-60 Kbps (available speed depends on the wireless network carrier).

You can use the GSM radio for voice communication and data communication but not at the same time. If you want to communicate over the phone (voice), you cannot send data. If you want to send data, you cannot use the phone.

SIM Card Installation

Short for Subscriber Information Module, a SIM card stores the subscriber's personal information, GSM/GPRS radio settings, security keys, contacts, etc. SIM cards are installed in compatible mobile devices, enabling you to switch devices without losing personal and setup information.

SIM Card Requirements

Before installing the SIM card:

- The SIM card **must** be activated by the service provider.
- The terminal **must** be powered down.

Note: If no SIM card is installed, you can still make emergency phone calls such as 9-1-1, for example.

To Install a SIM Card

Access to the SIM card is located under the battery well.

1. Put the terminal in suspend mode and lay it face-down on a flat surface.
2. Remove the battery pack.

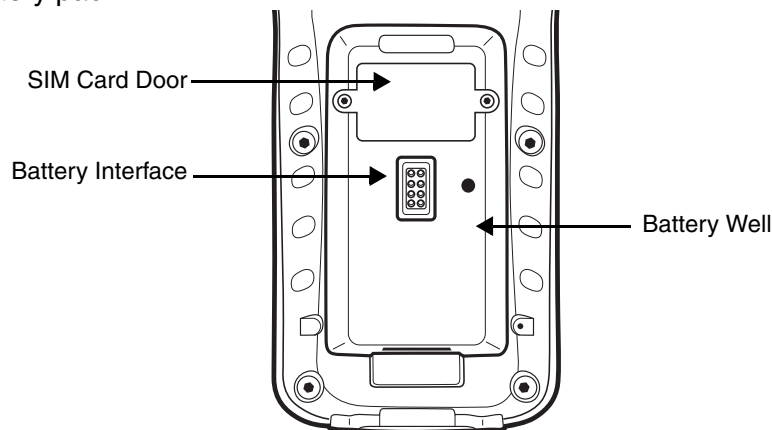

3. Unscrew the faceplate of the SIM card door. You **must** use a Torx T6 wrench. You can purchase this wrench from Honeywell, part number 100001700.
4. Insert your SIM card. Make sure the interface on the card is connected to the SIM Card interface in the slot; the beveled corner is in the upper right corner.

-
5. Place the SIM card door over the secured SIM card and fasten the screws.

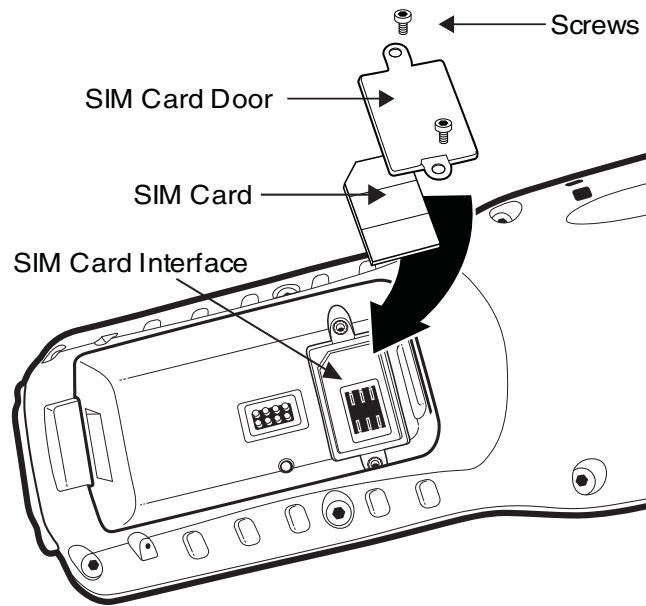

6. Install the battery pack and turn on the terminal.

Enabling the GSM Radio

By default, the GSM radio should be enabled after each hard reset. Verify the status of the radio in the Dolphin Wireless Manager.

Tap **Start > Settings > Connections tab > Dolphin Wireless Manager**



Dolphin
Wirele...

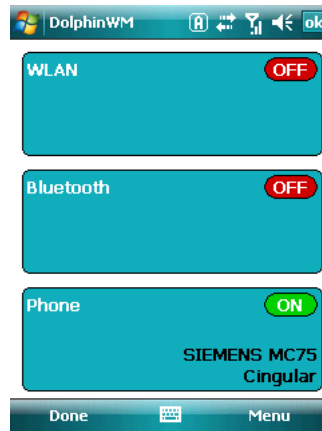

If the Phone is set to OFF, tap the Phone rectangle and the GSM radio enables.

Voice Communication

You can use the Dolphin terminal as a phone over the GSM radio.

Audio Modes

The back panel of the 9900, 9950, and 9951 contains both a speaker and a microphone that you can use to send and receive audio signals over the GSM network; see [Back Panel: 9900](#) on page 3-6.

There are two audio modes:

Headset Headset mode is when you plug a headset into the audio jack and speak into the microphone. You must use a 2.5mm plug; no other audio plug will fit.

Hands-Free Hands-free mode is when you use the back panel as a speakerphone. To switch the back panel to speakerphone, in the Dialer, tap **Settings > Speakerphone**. The audio levels adjust appropriately for speakerphone use.

Volume Control



Use the Dolphin keyboard to manually adjust the volume.

To raise the volume, press the Blue modifier key + up arrow.

To lower the volume, press the Blue modifier key + down arrow.

Accessing the Dialer Window

When the GSM radio is active, tap **Start > Settings > Connections** tab > **Dolphin Wireless Manager**, then tap **Menu > Phone Settings**. The Phone dialer opens.

Displays the network carrier from the SIM card.

Displays the most recent calls.



Dialing

Once the dialer window is open you can dial out two ways:

- Tap the buttons on the dialer window.
- Use the physical keyboard (when it's in numeric mode).

Sending Calls

After the number is dialed, tap **Talk**  or use the keyboard.



Note: The  icon indicated that the phone is in use.

Ending Calls

While the phone call is live, tap **End**  or use the physical keyboard.

Keyboard Combinations for Calls

Keyboard	To Send a Call, Press...	To End a Call, Press...
43-key keyboard	Blue + NUM	Blue + ENT
56-key keyboard	Blue + SFT	Blue + ENT

View Options

Tap **Menu** > **View**.

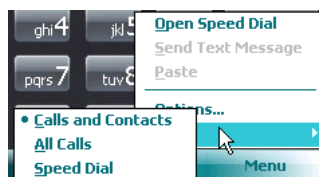

Setup Options

Tap Menu > Options.

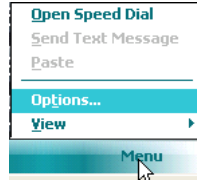

The Phone Settings tab windows appear.

Phone Tab

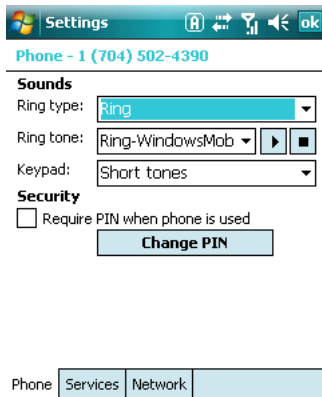

Establish or change a PIN on the Phone tab.

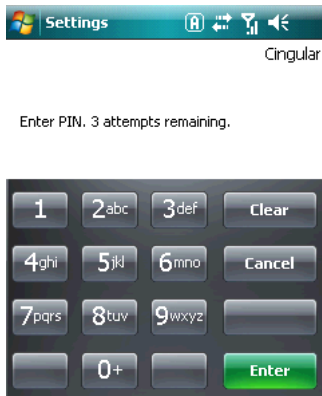

Services Tab

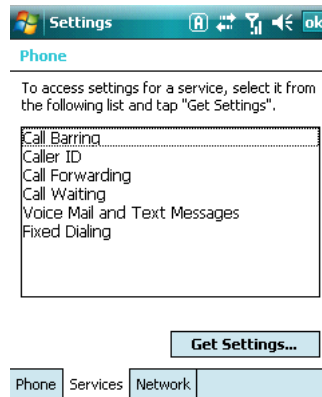

For each service, the phone will read settings from the network on the SIM and display the available options from the carrier.

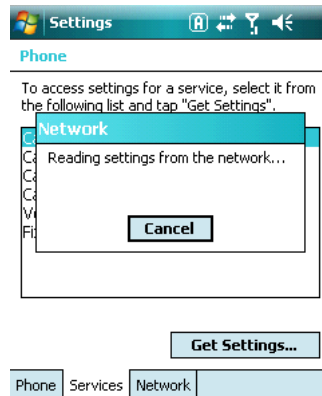

Network Tab



You can set networks on the Network tab.

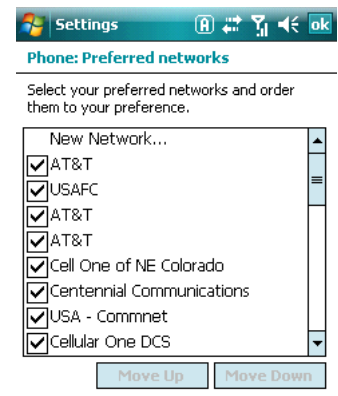

Data Communication

You set up data communication via the connections manager. The carrier on the SIM card is the ISP.

System Requirements

- The GSM radio must be enabled; see [Enabling the GSM Radio](#) on page 8-4.
- You must have an active SIM card installed; see [SIM Card Installation](#) on page 8-2.
- The Phone must not be in use. The  in the navigation bar indicates that the GSM phone is active but the phone is not in use.

Information Requirements

You must have from the SIM card carrier:

- The APN (access point name) number.
- The username and password of the account.

Establishing Data Communication

1. Tap **Start > Settings > Connection tab > Connections** .
2. Under My ISP, tap **Add a new modem connection**.
3. Enter a name for the connection, Select **Cellular Line (GPRS)** as the modem, and Tap **Next**.

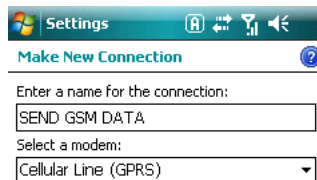

Settings

Make New Connection

Enter a name for the connection:

SEND GSM DATA

Select a modem:

Cellular Line (GPRS)



Cancel Next

4. Enter the APN and tap **Next**.

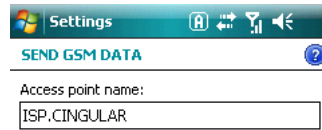

Settings SEND GSM DATA

Access point name:
ISP.CINGULAR



Back Next

5. Enter the username and password from the account and tap **Finish**.

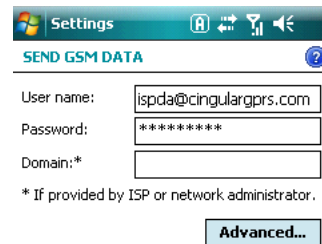

Settings SEND GSM DATA

User name: ispda@cingulargprs.com
Password: *****
Domain:*

* If provided by ISP or network administrator.

Advanced...



Back Finish

6. On the Connections window, tap **Manage existing connections**. The connection you just created should appear in the list on the modem tab.

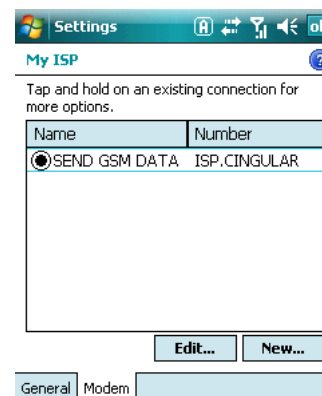

Settings My ISP

Tap and hold on an existing connection for more options.



Name	Number
SEND GSM DATA	ISP.CINGULAR

Edit... New...

General Modem

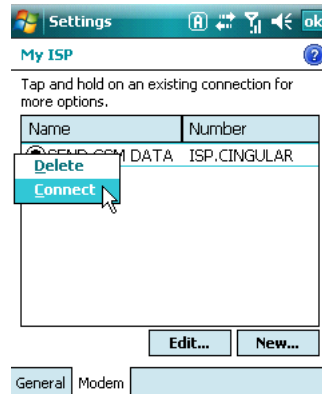
-
7. Tap and hold on the connection and select **Connect** on the popup menu.



8. The network icon in the navigation bar indicates the GSM radio is attempting to connect .
9. When the connection is complete, the network icon changes to: .
10. You can now send data over GSM.

Ending the Data Connection

You need to end the data connection to use the phone. By default, the data connection will disconnect after a certain amount of time passes without use. This period of time is determined by ISP.

To end the data connection manually, tap the network icon in the navigation bar  and select **Disconnect** on the popup bubble.

Roaming

You can select automatic or manual roaming. The Phone defaults to automatic roaming.

1. When an active SIM card is inserted in the terminal, tap **Start > Settings > Personal tab > Phone**



The Phone Settings window appears.

2. Select the **Network** tab.



3. Under **Network selection**, select **Automatic** (the default selection) or **Manual**.

- a. If you select **Manual**, the Phone searches for available networks.

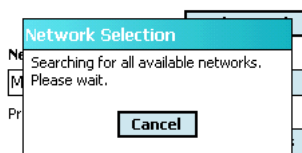

- b. The found networks appear.

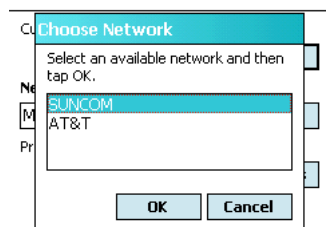

- c. Select a new network and tap **OK**. The Phone registers on the new network and the Network tabs appears.

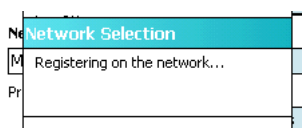

- d. To switch to another network, tap the now active **Select** button and the process repeats.

4. To switch back to automatic roaming, select **Automatic** under **Select networks** and tap **OK**.



Working with the Bluetooth Radio

Enabling the Bluetooth Radio

You enable the Bluetooth radio in the [Dolphin Wireless Manager](#) (see page 7-6).

1. Tap **Start > Settings > Connections tab > Dolphin Wireless Manager**  Dolphin Wirele...

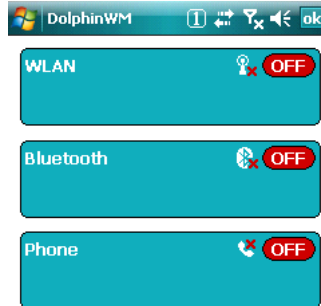

2. Tap anywhere inside the Bluetooth rectangle and Bluetooth begins activating.



3. When the radio is activated (i.e., transmitting a signal), the **OFF** button changes to **ON**.



Now, the Bluetooth radio is transmitting a signal. Additional text in the Bluetooth section tells information about the Bluetooth radio. "Visible" and "Not visible" indicates whether the Bluetooth radio is discoverable or not discoverable by other Bluetooth devices.

Now, you can connect to other transmitting and discoverable Bluetooth devices (see page 9-2).

To make the terminal discoverable for other Bluetooth devices, you need to make the Bluetooth radio discoverable (see page 9-8).

Connecting to Other Bluetooth Devices

You need to perform a device discovery and then select a discovered device and connect to it. Pairing happens as part of the connection process.

1. In the Dolphin Wireless Manager, tap **Menu** > **Bluetooth Settings**.

OR

Tap **Start** > **Settings** > **Connections** tab > **Bluetooth** 

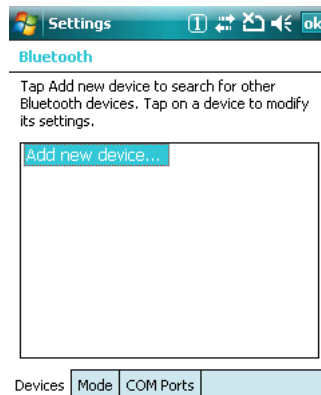

2. Tap **Add new device**. The terminal begins searching for discoverable Bluetooth devices.

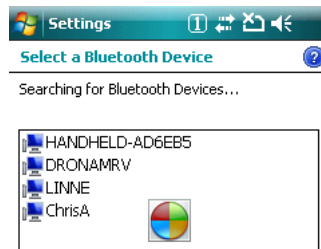

3. Select a device in the list and tap **Next**.

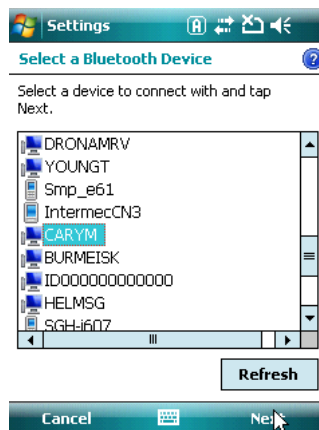

- You are prompted to enter a passcode.

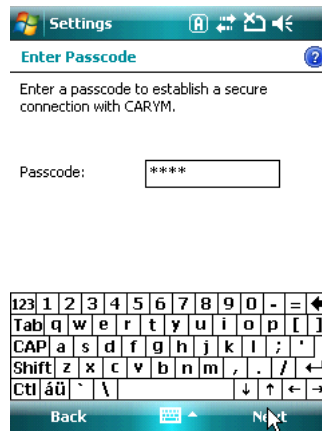

If the device has a specific passcode, enter it in the **Passcode** field and tap **Next**.
If the device does not have a specific passcode, enter one in the **Passcode** field and tap **Next**.

The Bluetooth radio tries to connect with the device.

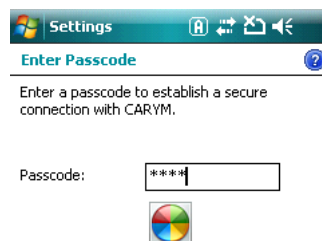

- If you created a passcode, you will be prompted by the other device to enter the same passcode. Enter the created passcode to establish a paired connection. (If you entered a the passcode from the device, you shouldn't have to do anything on the other device.)
- When the connection is complete, a list of matching and supported services on the device appears.

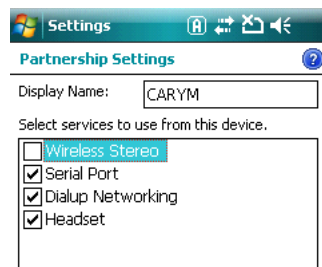

- Select the services you want to use and tap **Finish**.
The services on the new devices have to be selected or else the pairing won't include those services, even though the devices are paired. If services are not selected, you will be continually re-prompted for the passcode from the device.

-
8. The device appears in the list on the main window.



9. After the passcodes have been accepted on both sides, you have a trusted (“paired”) connection.

Pairing and Trusted Devices

The terminal does support pairing. Pairing happens during general connection setup. Paired devices are "trusted" devices. This means that there is unrestricted access to all services (including services that require authorization and authentication).

A connection can exclude pairing. A device that is connected to the terminal but not paired with it is considered an untrusted device. Content can still be passed to untrusted devices by requiring authorization with each attempt (for example, with the initialization of a file exchange). The Beam File method of file transfer can be used to pass a file as an untrusted device; see [Transferring Files](#) on page 9-7.

Types of Devices and Services

When you tap **Add new device** on the Devices tab, the Bluetooth radio scans for discoverable Bluetooth devices in range, which are Bluetooth devices that have been made discoverable.

Device Types

The types of devices in the vicinity of the radio appear in the list of discovered devices.

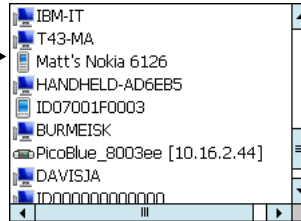

Supported Services

Only the services that are mutually supported on both devices appear on the Partnership Settings window.



Connecting to Bluetooth Printers

1. Make sure the Bluetooth printer is in range and set to be discoverable by other Bluetooth devices.
2. Look up the Bluetooth printer's broadcasted ID.
3. Perform a device discovery (Tap **Settings** > **Connections** > **Bluetooth** > **Add new device.**)
4. Look for the Bluetooth printer's broadcasted ID in the list of discovered devices.
5. Click on the Bluetooth printer's ID and wait for the prompt to enter a **Passcode**.
6. Enter the **Passcode** and tap **Next**.
The passcode may default to either "1111" or "0000." If there is no default, consult the printer literature for the number.
7. Select a printing-related service in the list of services.
8. Tap **Finish** to establish the connection on the terminal.
9. Complete any additional steps required by the printer.

Connecting to Bluetooth Headsets

1. Make sure the Bluetooth headset is in range and set to be discoverable by other Bluetooth devices.
2. Look up the headset's broadcasted ID.
3. Perform a device discovery (Tap **Settings** > **Connections** > **Bluetooth** > **Add new device.**)
4. Look for the headset's broadcasted ID in the list of discovered devices.
5. Click on the headset's ID and wait for prompt to enter a passcode.
6. Enter the **Passcode** and tap **Next**.
The passcode may default to either "1111" or "0000." If there is no default, consult the headset literature for the number.
7. Select **Headset** in the list of services.
8. Tap **Finish** to establish the connection on the terminal.
9. Complete any additional steps required by the headset.

Transferring Files

1. Tap **Start > Programs > File Explorer**.
2. Navigate to the file you want to transfer.
3. Tap and hold on the file and select **Beam File** on the popup menu.

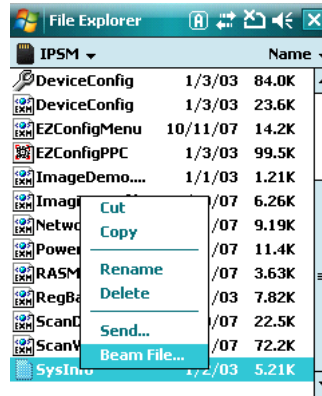

4. The Bluetooth radio begins searching for devices.

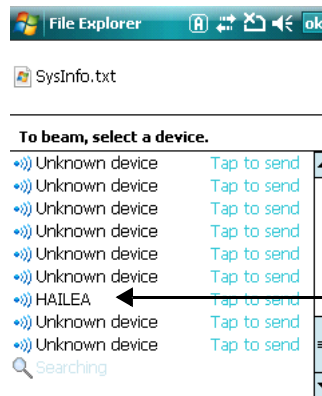

When a Bluetooth device is first found, it appears as an Unknown device; the icon indicates that the device is a Bluetooth device.

As data is retrieved, the device IDs appear in the list.

5. Tap the device to begin sending the selected file.

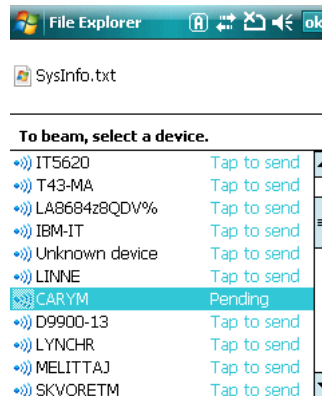

6. While trying to connect, the selected device reads "Pending."
7. When the file is being transferred, the selected device reads "Sending."

Making the Terminal Discoverable

By default, the Dolphin terminal is not discoverable, which means that the terminal will not be found by other Bluetooth devices.

To make the terminal discoverable, tap the **Mode** tab.

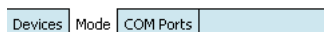
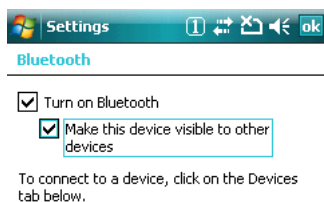

Select **Make this device visible to other devices** and tap **OK**.

Selecting COM Ports

You can select COM ports 0-9. For more information, see [9900/9950/9951 COM Port Assignment Table](#) on page [7-12](#).

Overview

The Dolphin 9900 terminal contains an integrated GPS module that allows location tracking of workers and vehicles, providing better utilization of field assets. Optional mapping and navigation software provides turn-by-turn driving directions and location information, allowing workers to arrive on time.

Note: The 9950 and 9951 are not available with GPS.

Assisted GPS Support

The operating system software does not inhibit nor explicitly support assisted GPS modes, which usually requires installing a vendor-specific client on the terminal that communicates with the GPS module. This client would then provide the almanac and/or ephemeris data for warm or hot start modes of operation, allowing a lower time to first fix (TTFFS). The Client must be configured on the terminal, active, and provide the data to the GPS module through the standard COM port.

Powering the GPS Module

The GPS module powers on automatically when accessed by a software application and powers off automatically when that software application closes. You cannot manually power on and off the GPS module.

Communication Ports

There are two ways to access the GPS module: through the actual COM port (COM7) or the GPS Intermediate Driver. The method you use depends on the software application you are using. If the software application requires the actual COM Port, set the operating system to use COM7. If the software application requires the GPS Intermediate Driver, set the operating system to use the GPS Intermediate Driver.

Selecting the Port

1. Tap **Start > Settings > System tab > External GPS**.
2. In the **GPS program port:** drop-down list, select **COM7** or **GPD1** (the GPS Intermediate Driver) as required by the application.

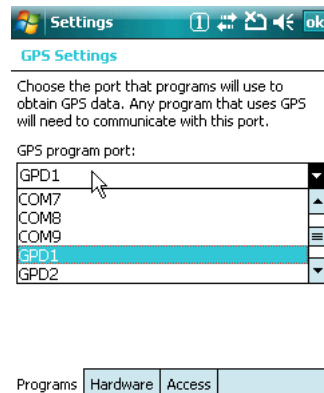

3. Tap **OK** to save.

COM7

COM Port 7 can be set to the following baud rates:

- 4800
- 9600 (This is the default baud rate and recommended for optimal GPS functioning.)
- 19200
- 38400

Other baud rates are not possible. The baud rate selected on COM7 is the actual baud rate with which the GPS will be communicating.

GPS Intermediate Driver

When the first user of GPD1 opens the port, the GPS Intermediate Driver in turn opens port COM7. The GPS Intermediate Driver allows multiple applications to open GPD1, and the GPS data is broadcast to all open ports.

When the GPSID driver is in use, the COM7 port is allocated to GPSID as READIWRITE. (COM7 is still available for access mode of 0.)

For more information about Microsoft's GPS Intermediate Driver, follow this link: <http://msdn2.microsoft.com/en-us/library/ms850332.aspx>

GPS Demo

The GPS Demo demonstrates the main functionality of the integrated GPS module. The GPS Demo uses COM7.

To see the GPS Demo, tap **Start > GPS Demo**.

For complete information about how to operate the GPS Demo, refer to the Demos User's Guide for Windows Mobile 6.1, which is available for download from www.honeywellaidc.com.

Dolphin HomeBase Device

Overview

As the hub of your Dolphin system, the Dolphin HomeBase charging and communication cradle supports both RS-232 and USB communications, which make it able to interface with the majority of PC-based enterprise systems.

Charge Time

The base completes a full charge of the main battery pack installed in the terminal seated in the terminal well in 4.5 hours. The base completes a full charge of the main battery pack in the [Auxiliary Battery Well](#) (see page 11-2) in 4 hours.

Charging Process

The base also provides power to the intelligent battery charging system in all Dolphin terminals that senses when a full charge has been achieved and switches to a trickle charge to maintain the full charge.

Communications

Reliable data communications at speeds of up to 115k baud can be transmitted by the base through the RS-232 serial port. Using the full-speed USB port, the data transmission rate goes up to 12 Mbps.

These bases cannot be physically connected to each other - sometimes referred to as “daisy-chained.”

Convenient Storage

The intelligent battery charging system makes this base a safe and convenient storage receptacle for your Dolphin terminal.

Capacity

The base holds one terminal and features an auxiliary battery well behind the terminal well that can charge a battery pack independently of the terminal well. This means that one base can charge two battery packs: the one installed in the terminal and a spare.



We recommend use of Honeywell Li-Ion battery packs. Use of any non-Honeywell battery may result in damage not covered by the warranty.



We recommend use of Honeywell peripherals, power cables, and power adapters. Use of any non-Honeywell peripherals, cables, or power adapters may cause damage not covered by the warranty.

Note: The following warnings apply to 99XXXXX-XXXXXXI units (Hazardous Location rated. See [Approvals by Country](#) on page 1-3.).



Replace only with battery pack type 200002586 manufactured by Honeywell International Incorporated.



Warning: Explosion Hazard. Charge or replace the battery only in an area known to be non-hazardous.



Warning: Explosion Hazard. Do not replace components unless power has been switched off or the area is known to be non-hazardous.



Warning: Substitution of any components may impair suitability.



Warning: Explosion Hazard. Do not use external connectors in areas known to be hazardous.

Parts and Functions

Front Panel

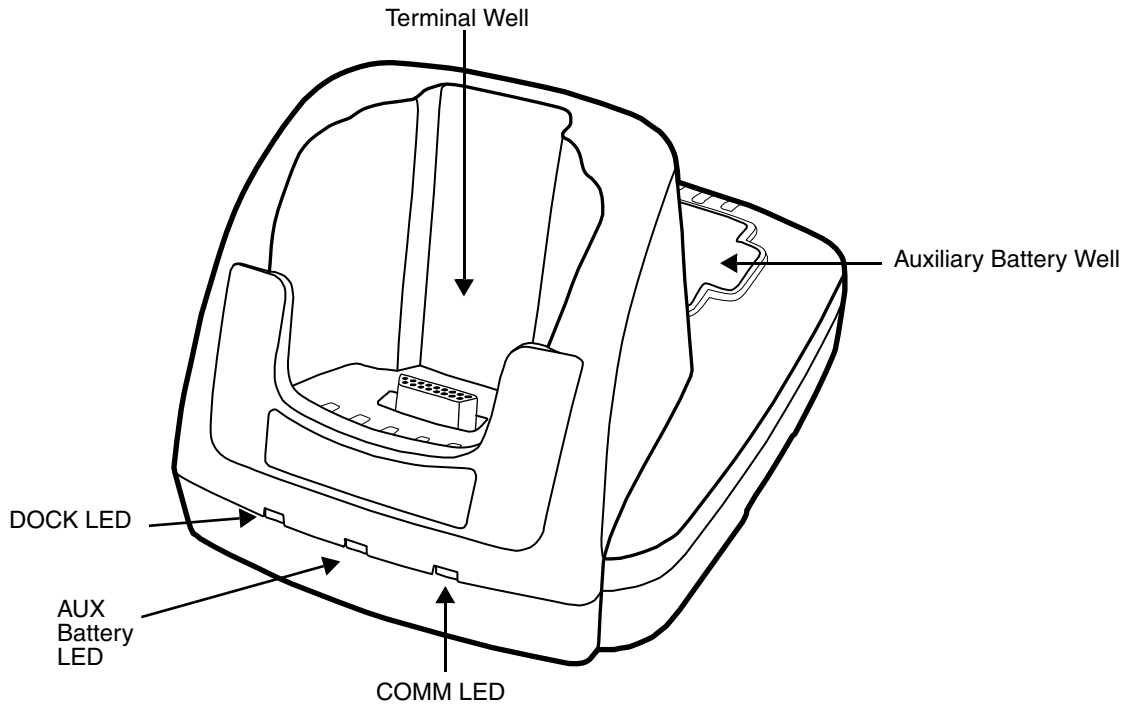

Terminal Well

Place the terminal in this well to communicate with a host device, power the terminal, and charge its battery pack. If the host device is a workstation that uses ActiveSync, synchronization begins immediately.

While seated in the terminal well, the main battery installed in the terminal charges. The base completely charges a battery pack installed in the terminal seated in this well in 4.5 hours.

Auxiliary Battery Well

See [Auxiliary Battery Well](#) on page 11-3.

DOCK LED

Turns solid green when the terminal is properly seated in the base.

AUX Battery LED

Indicates status of the battery charging in the auxiliary battery well; see [Back Panel](#) on page 11-3.

This color	means...
------------	----------

Orange	The auxiliary battery is charging.
---------------	------------------------------------

Green	The auxiliary battery has completed charging and is ready for use.
--------------	--

For information about charging a battery in the auxiliary battery well, see page 11-6.

COMM LED

This is the communication LED. It indicates the status of data transfer between the Dolphin terminal and the host device. The color of this LED differs if the base is using the serial or USB port connection.

If using the serial port

This color **means...**

Red Serial data is being sent from the host device to the base.

Green Serial data is being sent from the base to the host device.

Orange Serial data is being sent in both directions at the same time.

If using the USB port

This color **means...**

Green LED A USB Connection is established with the host workstation.

Back Panel

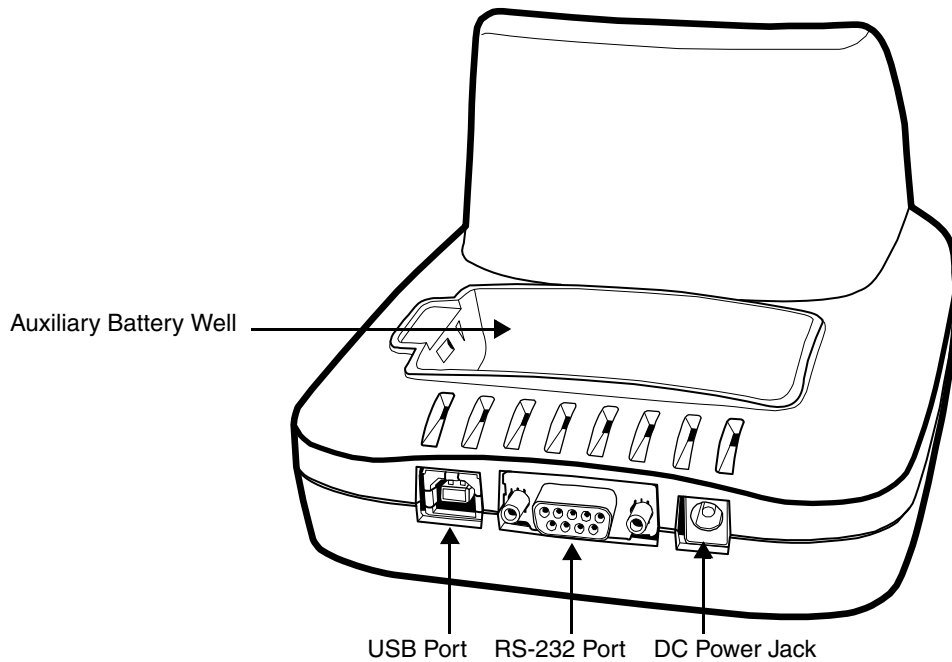

Auxiliary Battery Well

The base enables you to charge an additional Li-ion battery pack independently of the terminal well in 4 hours. This feature ensures that you can always have a fully-charged battery for your terminal. See [Charging a Spare Battery in the Auxiliary Battery Well](#) on page 11-6.

USB Port

This USB Port is full-speed and 2.0 compliant. Using a USB cable, you can connect the base to a peripheral device, such as a workstation or printer. When the terminal is seated in the terminal well, it is connected to the peripheral device via the base.

RS-232 Port

Use the 9-pin, RS-232 cable from Honeywell to connect this port to a peripheral device for RS-232 data communication. For more information, see [Serial Connector](#) on page 11-5.

DC Power Jack

Use the power cable from Honeywell that comes with the base to supply power to this power jack. For more information, see [Power](#) section that follows.

Power

The terminal requires 9.5 Volts DC input for communications and battery charging; the power adapter on the power cable converts the voltage from the power source to 9.5 volts DC. **Only** the Honeywell 9.5 VDC 4A power supply provided with the base converts the voltage appropriately.

Honeywell recommends that you leave the base connected to its power source at all times, so that it is always ready to use.

1. Connect the power cable to the DC jack on the rear panel of the base.
2. Connect the power cable to the power adapter.
3. Plug the power adapter cable into the power source. The base is now powered.

Serial Connector

The following diagram displays the pin diagram of the serial connector of the base.

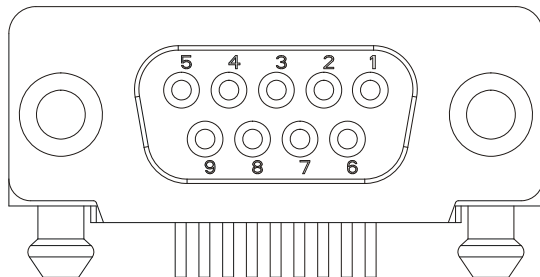

<u>Pin #</u>	<u>Description</u>
1	Internal Jumper to Pin 6
2	TXD
3	RXD
4	DSR
5	GND
6	DTR
7	CTS
8	RTS
9	RI

Note: Signals referenced are for a DTE device. The base is at a right-angle to the printed circuit board (PCB). The ninth pin has a ring indicator (RI).

Charging the Main Battery

The base powers the terminal and fully charges its main battery pack in 4.5 hours.

The base contains an intelligent battery charging system that protects the battery from being damaged by overcharging. The unit senses when a battery pack is fully charged and automatically turns off the charger. If the battery voltage drops below the charge threshold, the charger will again turn on to maintain the battery at full capacity. As a result, Dolphin terminals may be stored in the base indefinitely without damage to the terminals, battery packs, or peripherals.

To check battery power, use the Power system setting; see [Power](#) on page 6-12.

For more information about Honeywell Li-ion batteries, see [Batteries](#) on page 3-14.

To Power a Terminal and Charge its Main Battery

1. Install the battery pack in the terminal; see [Install the Main Battery Pack](#) on page 2-1.
2. Connect the base to the power supply provided by Honeywell.
3. Slide the terminal into the terminal well until the Dock LED lights green to indicate that the terminal is properly seated.
4. The battery pack begins charging.

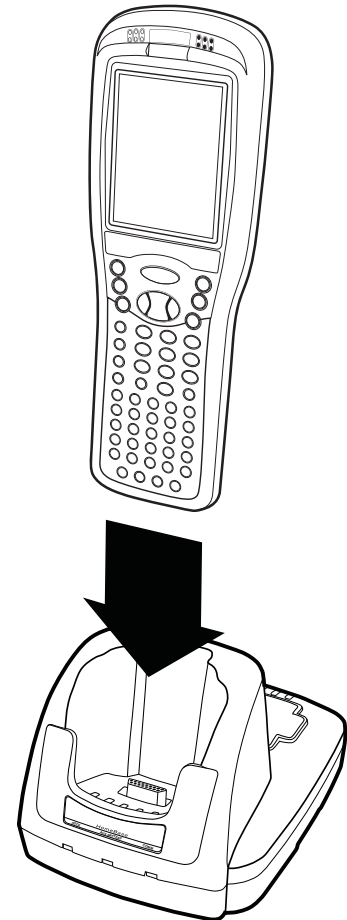

 *Make sure the terminal is dry before placing it in the base. Do NOT place a wet terminal in the base! Doing so may cause damage not covered by the warranty.*

Note: The following warnings apply to 99XXXXX-XXXXXXI units (Hazardous Location rated. See [Approvals by Country](#) on page 1-3).



Replace only with battery pack type 200002586 manufactured by Honeywell International Incorporated.



Warning: Explosion Hazard. Charge or replace the battery only in an area known to be non-hazardous.



Warning: Explosion Hazard. Do not replace components unless power has been switched off or the area is known to be non-hazardous.



Warning: Substitution of any components may impair suitability.



Warning: Explosion Hazard. Do not use external connectors in areas known to be hazardous.

Charging a Spare Battery in the Auxiliary Battery Well

The auxiliary battery well located on the back of the base charges a spare battery independently of the terminal well. The Aux Battery LED on the front panel indicates the status of the battery in this well.

Charge time is 4 hours; see [Auxiliary Battery Well](#) on page 11-3.

1. Insert the end of the battery without the locking tab into the bottom of the auxiliary well opening.

-
2. Snap the battery into place with a hinging motion. The Aux Battery LED lights orange.
 3. Use the AUX Battery LED to monitor charging progress.

Communication

USB

Dolphin terminals support USB communications out of the box.

The base also supports USB communications via the USB port located on the back. The base acts as a USB device by interfacing the USB signals of the Dolphin terminal to the USB of the host workstation. Using a standard USB cable, the base's USB interface allows the Dolphin terminal to communicate with a workstation.

RS-232

The base supports RS-232 communications via the RS-232 Communications Port located on the back of the device. This port enables the Dolphin terminal to communicate to a workstation, modem, or any RS-232 device using a standard serial cable and communications software.

Requirements

- A base powered by a power cable and power adapter cable
- For RS-232 communications, a serial cable
- For USB communications, a USB cable
- ActiveSync v4.5 or above on the host workstation
- Windows® 98 Second Edition*, Windows® Me, Windows® 2000, or Windows® XP on the host workstation.

Note: This base does not support Windows NT® when using a USB connection because Windows NT does not support USB. Windows® 98 second edition provides full USB support.

Connecting the Communication Cables

Note: You must be using ActiveSync 4.5 or higher.

1. Plug in the power supply and connect it to the back of the base.
2. Plug the USB or the RS-232 communication cable into the back of the base.
3. Connect the communication cable into the back of the workstation.
4. At this point, the hardware is installed and operating.
You may need to reboot your workstation to complete the installation process.

Establishing Communication

USB or RS-232 communication with the terminal is usually auto-detected and configured by ActiveSync based on the communication cable. If you are using a USB cable to connect to the workstation, ActiveSync will usually set up a USB connection. If you are using an RS-232 cable, ActiveSync will usually set up an RS-232 connection.

For more details, see [ActiveSync Communication](#) on page 7-8.

Communicating with the Dolphin Terminal

To initiate communications between the Dolphin terminal and peripheral, complete these steps:

1. Insert the Dolphin terminal into the terminal well of the base.
 - The DOCK LED illuminates green. If the DOCK LED does not illuminate, make sure that the terminal is properly seated. You may need to remove and re-insert the terminal.
 - The Dolphin terminal activates; if the power is off, the terminal automatically powers on. If the terminal does not power on, verify that the Honeywell power supply is properly connected to the cradle and plugged into a functioning outlet.
 - If the base is connected to the workstation, the Dolphin terminal automatically opens ActiveSync to establish a connection.
2. The base can now transfer data between the terminal and the host device. If communication does not occur, check the port connections to ensure that the cradle is correctly configured.

Verifying Communication

You can verify that the USB driver is functioning by watching the COMM LED on the USB base. When the COMM LED illuminates solid green, the base is communicating with the host device.

Verifying Data Transfer

The COMM LED flashes when data is being transferred via the base. For an RS-232 connection, the COMM LED flashes red and green. For a USB connection, the COMM LED flashes green.

RS-232 Communications Cables

Connect the base to the host workstation or other device by plugging an RS-232 serial cable into the RS-232 Communications Port on the rear of the base. The wiring of your cable depends on whether the other device is set up as a Data Communications Equipment (DCE) or Data Terminal Equipment (DTE) device.

The Communication Port is configured as a DCE device. To communicate with a DCE device, use either a null modem adapter in line with a standard RS-232 cable, or a null-modem serial cable. To communicate with a DTE device such as a workstation, use a standard (or straight-through) RS-232 cable.

You can make your own cables by following the pin configuration in the chart below. To do so, you must determine if your host RS-232 device is 9-pin or 25-pin, and whether it is configured as a DCE or DTE device.

RS-232 Pin Configuration

Base /Host Port (DCE)	IBM AT DB9 (DTE)	IBM XT DB25 (DTE)	Modem DB25 (DCE)
Pin / Input Signal			
2 / (RD)	2	3	2
3 / (TD)	3	2	3
5 / (SG)	5	7	7
4 / (DTR)	4	20	6
6 / (DSR)	6	6	20
7 / (RTS)	7	4	5
8 / (CTS)	8	5	4

Note: This base cannot be daisy-chained.

Mounting

Set the base on a dry, stable surface, such as a desktop or workbench near an electrical outlet. Be sure to provide enough workspace with good lighting for the user to view and operate the Dolphin terminal while it is in the base.

When choosing a location, bear in mind that:

- the mounting location must allow users easy access to the Auxiliary Battery Well, and
- the serial and USB ports as well as the power jack face straight out of the rear panel, and you will most likely want easy access to them in the future.

Installation Hardware

Screw: 3/16 in. dia x 5/8 in. long pan head screw
Washer: 1/2 in. OD x 7/32 in. ID x 3/64 in. thick
Nut: 3/16 in. dia

Desk Mounting

The DIN rail slot (7.5 X 35 mm) may be mounted on the bottom to allow for secure desk attachment of the unit if desired.

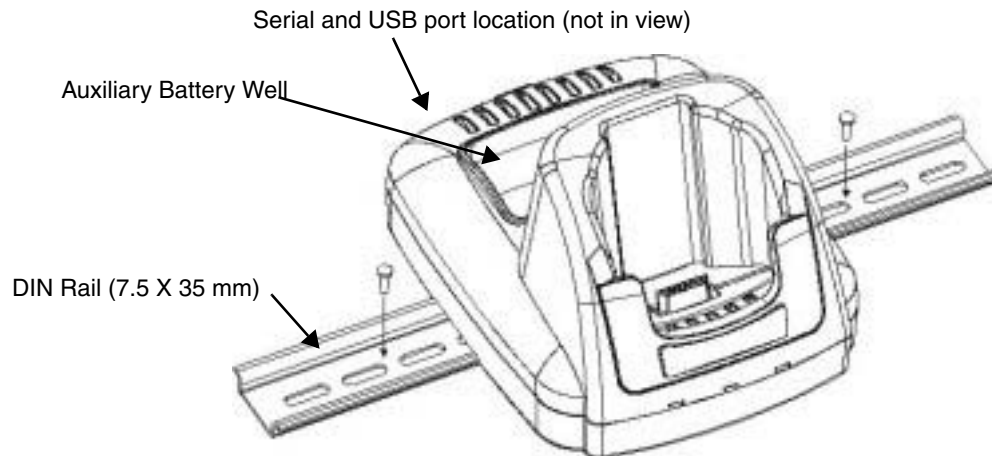

Slide the DIN rail slot along the bottom panel.

Then, using the appropriate nuts and bolts, secure the DIN rail to the desk or flat surface.

Wall Mounting

You can purchase a wall mount kit that contains

- a mounting bracket,
- three screws, and
- six washer/nut sets.

The back wedge of the mounting bracket contains an open slot for the power and communications cables. There is an extra space between this slot and the rear panel of the base to allow easy access to the power and communications ports. For more details on both ports, see [Back Panel](#) on page 11-3.

To Mount Using the Wall Mount Kit

1. Attach the mounting bracket to the wall using the [Recommended Hardware](#) (see page 11-10).
2. On the base, insert a screw into the round end of each screw slot on the bottom panel. Then, slide each screw towards the narrow end of the slot until it snaps in place.
3. Use a washer/nut set on each of the three screws to secure the screw in the slot.
4. Place the base on the mounting bracket; match the holes up with the secured screws.
5. Use the remaining washer/nut sets on each of the three screws to secure the base to the mounting bracket.

Recommended Hardware

If a metal or wood stud is present, drill a 3/32 in. pilot hole into the stud and use a #6 X 1 1/2 screw and washer to attach the bracket to the wall.

For any of the screws positioned so that they are going directly into dry wall, use a sheet rock anchor/screw set such as the one listed below.

For any of the screws attaching directly into concrete, drill the appropriately sized pilot hole into the concrete and secure the bracket to the wall using concrete anchor screws such as those listed below.

Wall	Recommended Anchors
Sheet Rock	Buildex E-Z Anchor Stud Solver Medium Duty Drywall Anchor (Model #25216); supports 50 lbs., screws included
Concrete	Buildex TAPCON concrete anchors 3/16 in. X at least 1 in.



Dolphin Mobile Base Device

Overview

This charging and communication cradle is designed specifically for in-premise and in-transit data collection applications. It features a flexible mounting bracket, a cigarette lighter adapter, and a power cable to adapt it to your environment.

The serial connector supports RS-232 communication and power out to peripheral devices, such as handheld scanners.

As the hub of your Dolphin mobile data collection system, the base performs three important functions: charging, communications, and storage.

Charging

The base completes a full charge of the main battery pack in 4.5 hours. The base also provides power to the intelligent battery charging system in all terminals that senses when a full charge has been achieved and switches to a trickle charge to maintain the full charge.

Communications

The base transmits data to other devices at speeds of up to 115K baud via its RS-232 serial port.

Convenient Storage

Intelligent battery charging makes the base a safe and convenient storage receptacle for your Dolphin terminal.



We recommend use of Honeywell Li-Ion battery packs. Use of any non-Honeywell battery may result in damage not covered by the warranty.



We recommend use of Honeywell peripherals, power cables, and power adapters. Use of any non-Honeywell peripherals, cables, or power adapters may cause damage not covered by the warranty.

Note: The following warnings apply to 99XXXXX-XXXXXXI units (Hazardous Location rated. See [Approvals by Country](#) on page 1-3.).



Replace only with battery pack type 200002586 manufactured by Honeywell International Incorporated.



Warning: Explosion Hazard. Charge or replace the battery only in an area known to be non-hazardous.



Warning: Explosion Hazard. Do not replace components unless power has been switched off or the area is known to be non-hazardous.



Warning: Substitution of any components may impair suitability.



Warning: Explosion Hazard. Do not use external connectors in areas known to be hazardous.

Front Panel

The following graphic features the base with a terminal inserted into the terminal well:

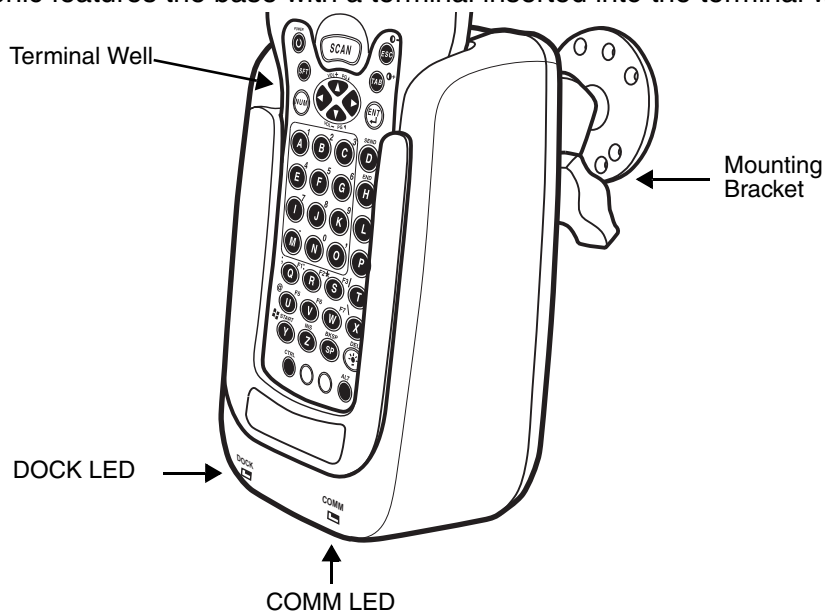

Terminal Well Place the terminal in this well. Once seated, the terminal can communicate with a host device and its main battery pack begins charging.

Mounting Bracket
Used to mount the base to a fixed location.

DOCK LED Illuminates solid green when the Dolphin terminal is properly seated in the terminal well.

COMM LED Indicates the status of data transfer between the host device and the Dolphin terminal

Color	Indicates that...
Red	Data is being sent from the host device to the base.
Green	Data is being sent from the base to the host device.
Orange	Data is being sent at high data rates.

Note: There is a separate version of this base that accommodates the integrated pistol-grip handle of the 9950 and 9951.

Bottom Panel

The power supply and RS-232 connectors are located on the bottom of the unit.

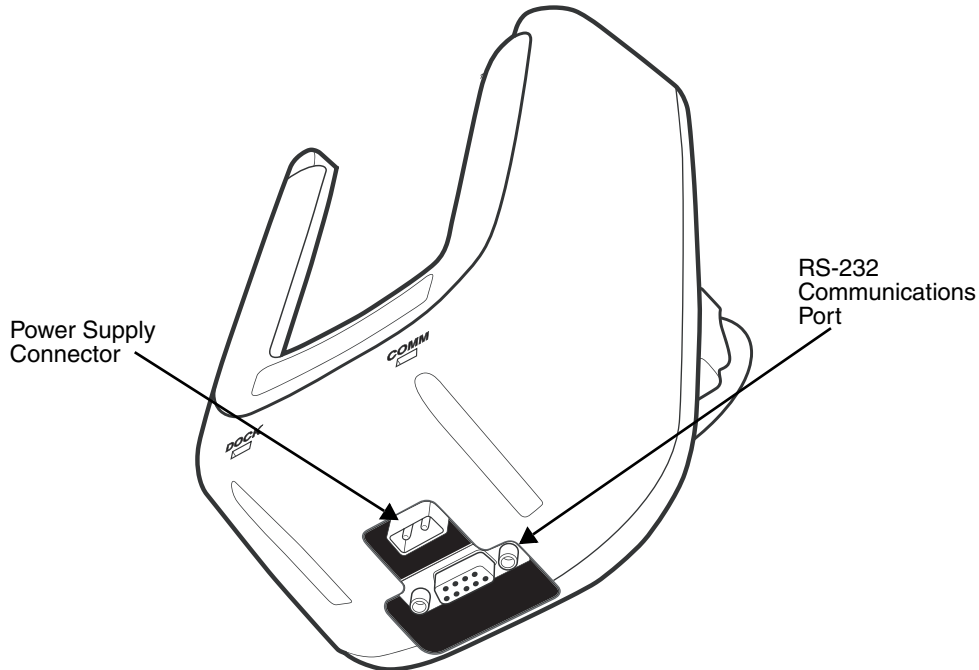

Power Supply Connector

Attach the power cable that came with the base to this connector. The base can be powered by an external DC power source of between 11 VDC to 48 VDC.

To run on vehicle power, you can use the 12 VDC cable or 24 VDC cable option. The appropriate cable comes with the kit you ordered. The 12 VDC cable can be used with a cigarette lighter outlet. The 24 VDC, pigtail cable can be used to “hard-wire” into the vehicle power bus.

 *Verify that the power source is always within the specified range and observe correct input voltage polarity. An improper input voltage range (above the 48 VDC maximum) or reverse polarity could damage the power conversion circuitry.*

RS-232 Communications Port

Use a standard serial cable to connect the unit to a host device via RS-232; see [Serial Connector](#) on page 12-8.

Powering the Dolphin Terminal

When seated in a base that is connected to the appropriate power source, the Dolphin terminal receives the power to charge its main battery and run its internal circuitry. Keep the base plugged into the power source so that the Dolphin terminal battery pack stays fully charged.

For more information about powering the base, see [Power](#) on page 12-5.

Charging the Dolphin Terminal

The base supplies charging power to the Dolphin terminal so that the terminal can monitor the charging of its battery pack. This charging method protects the battery from being damaged by overcharging. Therefore, the Dolphin terminal may be stored indefinitely in the base without damage to the terminal, the battery pack, or the base.

1. Insert a battery pack into the terminal.
2. Slide the terminal, imager window up and the LCD visible, into the terminal well until it stops.
3. When the terminal is properly seated, the DOCK LED on the base illuminates solid green. The terminal begins charging automatically.

Mounting

The adjustable mounting bracket holds the terminal securely in place and gives the user a variety of options for mounting the base. When selecting a location, keep in mind that the power supply and serial connectors point straight out the bottom panel.

1. Loosen the turnscrew.
2. Insert the ball joint of the mounting bracket to the back of the bracket.
3. Insert the ball joint on the back of the base into the other side of the bracket.
4. Tighten the turnscrew to secure both ball joints.
5. Secure the mounting bracket to the appropriate location.

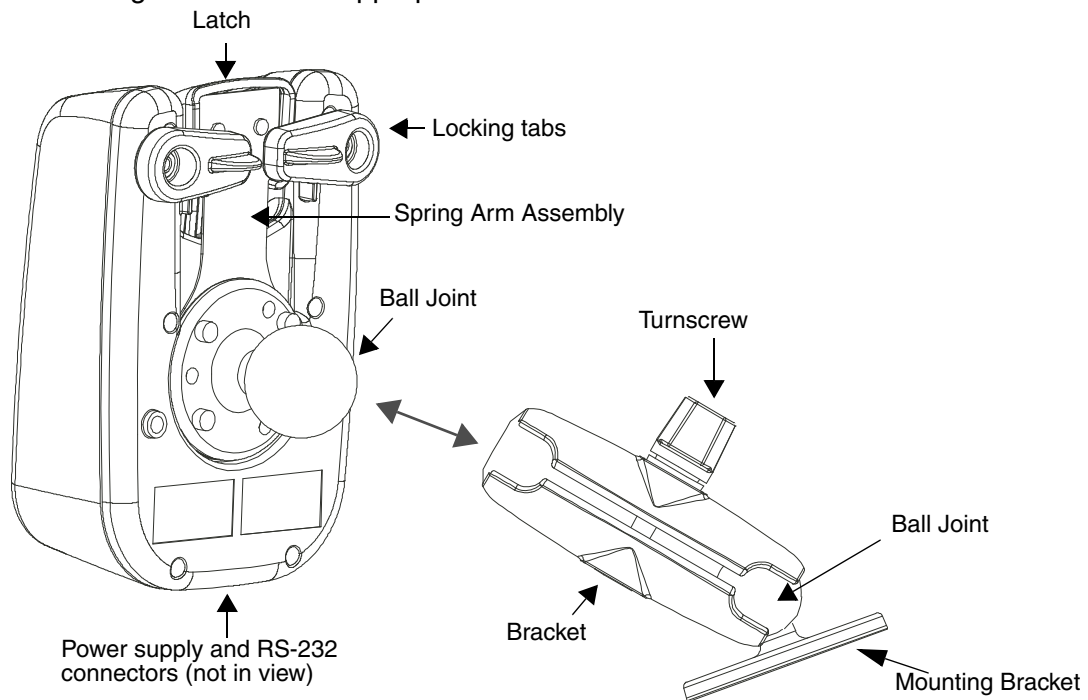

Back Panel

Latch

The latch sits on top of the spring arm assembly and holds the back of the terminal securely in place. The 9950/9951 version of the base contains a special latch to accommodate the integrated pistol-grip handle.

Locking Tabs

When positioned as shown in the above graphic, the locking tabs secure the spring arm assembly, latch, and terminal in place. When seating a terminal, turn both arms up to allow the spring arm to move as necessary while the terminal is being inserted. After the terminal is seated, turn both arms toward the center to lock them.

Both locking tabs must be pointing up to insert or remove a terminal in the base.

Spring Arm Assembly

The spring arm assembly is the column that connects the latch to the back of the base.

Ball Joints

There are two ball joints: one on the back of the base and one on the mounting bracket. Both ball joints are inserted into the bracket and secured to mount the base.

Connectors

The power and RS-232 connectors are located on the bottom panel. For more information, see [Bottom Panel](#) on page 12-3.

Brackets

Bracket

The bracket contains the turnscrew and two slots. Ball joints are inserted into each slot and secured with the turnscrew.

Turnscrew

The turnscrew is located on the top of the bracket. Rotate the turnscrew to secure or loosen the ball joint slots.

Mounting Bracket

The mounting bracket is what you attach to the mounting surface. It is comprised of a ball joint and flat disk. The disk contains drill holes you use to secure the base to the mounting surface.

Power

Note: Honeywell recommends that you leave the base connected to its power source at all times.

The base is powered via the power connector on the bottom panel; see [Bottom Panel](#) on page 12-3. Both the power and serial connectors are straight out, not at an angle. The base must be powered by a 12 to 48 volt DC source.

Establishing Communication

The RS-232 interface allows the terminal to communicate to a workstation, modem, or any standard RS-232 device using a standard serial cable and communications software.

Requirements

You need the following equipment:

- A Mobile Base device powered by a power cable and power adapter cable
- The RS-232 communications cable
- ActiveSync v4.5 or above on the host workstation
- Windows® 98 Second Edition*, Windows® Me, Windows® 2000, or Windows® XP on the host workstation

Connecting the Communication Cables

Note: You must be using ActiveSync 4.5 or higher.

1. Plug in the power supply and connect it to the back of the base.
2. Plug the RS-232 communication cable into the back of the base.
3. Connect the communication cable into the back of the workstation.
4. At this point, the hardware is installed and operating.
You may need to reboot your workstation to complete the installation process.

Establishing ActiveSync Communication

The Dolphin terminal is usually auto-detected and configured by ActiveSync based on the communication cable. If you are using an RS-232 cable, ActiveSync will usually set up an RS-232 connection.

For more details, see [ActiveSync Communication](#) on page 7-8.

Connecting the Cables

Connect the base to the host workstation or other device by plugging an RS-232 serial cable into the RS-232 Communications Port on the bottom of the base. Plug the other end of the RS-232 serial cable into the correct port on the host RS-232 device.

The wiring of your cable depends on whether the other device is set up as a Data Communications Equipment (DCE) or Data Terminal Equipment (DTE) device.

The Communication Port is configured as a DCE device. To communicate with a DTE device such as a workstation, use a standard (or straight-through) RS-232 cable. To communicate with a DCE device, use either a null modem adapter in line with a standard RS-232 cable, or a null-modem serial cable.

RS-232 Pin Configuration

Base/Host Port (DCE)	IBM AT DB9 (DTE)	IBM XT DB25 (DTE)	Modem DB25 (DCE)
Pin / Input Signal			
2 / (RD)	2	3	2
3 / (TD)	3	2	3
5 / (SG)	5	7	7
4 / (DTR)	4	20	6
6 / (DSR)	6	6	20
7 / (RTS)	7	4	5
8 / (CTS)	8	5	4

Refer to this table if you want to make your own cables.
To do so, you must determine if your host RS-232 device is:

- 9-pin or 25-pin and
- configured as a DCE or DTE device.

Serial Connector

The base connector is straight to the printed circuit board (PCB). The ninth pin sends 500mA at 5V power out. This can power a peripheral device, such as a mobile printer, as long as that peripheral device can accept 500mA at 5V.

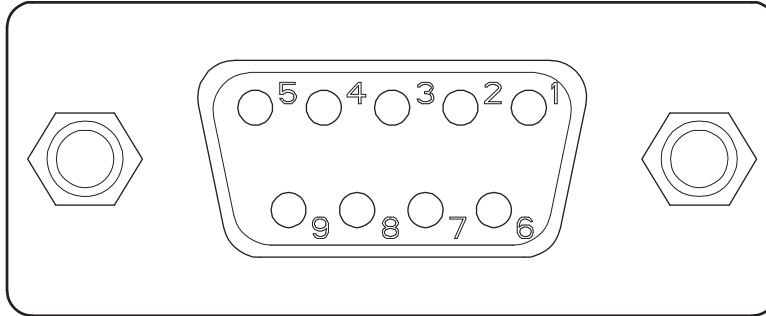

<u>Pin #</u>	<u>Description</u>
1	Internal Jumper to Pin 6
2	TXD
3	RXD
4	DSR
5	GND
6	DTR
7	CTS
8	RTS
9	5 VOLT OUT

Note: Signals referenced are for a DTE device.

Dolphin ChargeBase Device

Overview

This 4-slot charging cradle that can power 4 Dolphin terminals, and charge their main batteries in 4.5 hours.

Charging

The base supplies power to the intelligent battery charging system in all Dolphin terminals, which senses when a full charge has been achieved and switches to a trickle charge to maintain the full charge.

As battery packs charge, the charging circuitry follows the two-step charging process (CC-CV) that is recommended for Li-ion batteries. The process monitors changes in temperature, current, and voltage.

Convenient Storage

Intelligent battery charging makes this base a safe and convenient storage receptacle for your Dolphin terminal.

Capacity

The base can hold up to 4 Dolphin terminals. Each charging slot charges each terminal independently of the other slots.



We recommend use of Honeywell Li-Ion battery packs. Use of any non-Honeywell battery may result in damage not covered by the warranty.



We recommend use of Honeywell peripherals, power cables, and power adapters. Use of any non-Honeywell peripherals, cables, or power adapters may cause damage not covered by the warranty.

Note: The following warnings apply to 99XXXXX-XXXXXXI units (Hazardous Location rated. See [Approvals by Country](#) on page 1-3.).



Replace only with battery pack type 200002586 manufactured by Honeywell International Incorporated.



Warning: Explosion Hazard. Charge or replace the battery only in an area known to be non-hazardous.



Warning: Explosion Hazard. Do not replace components unless power has been switched off or the area is known to be non-hazardous.



Warning: Substitution of any components may impair suitability.



Warning: Explosion Hazard. Do not use external connectors in areas known to be hazardous.

Parts and Functions

Front Panel

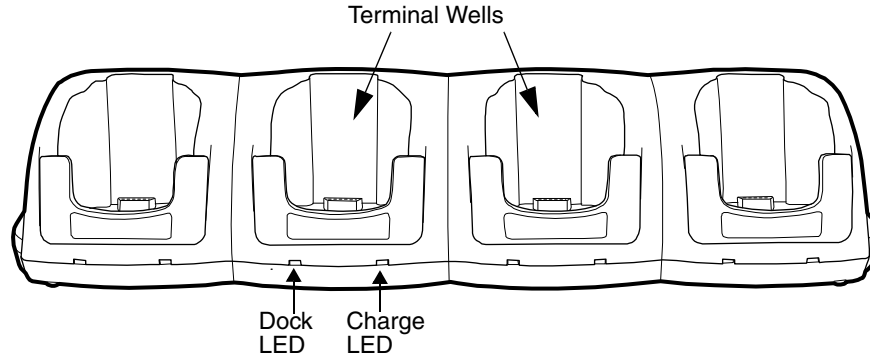

Terminal Wells

The base contains 4 terminals wells. Each well

- Holds and charges the main battery pack of one Dolphin terminal.
- Contains the companion to the I/O connector on the bottom panel of Dolphin terminals.
- Has two LEDs on the front: the Dock LED and the Charge LED.

Dock LED

Each terminal well displays a Dock LED on the front that lights solid green when a terminal is properly seated, which means that the terminal and the base are connected.

Charge LEDs

Each terminal well displays a Charge LED on the front that lights green to indicate charging. For details, see [Charging Terminals](#) on page 13-4.

Back Panel

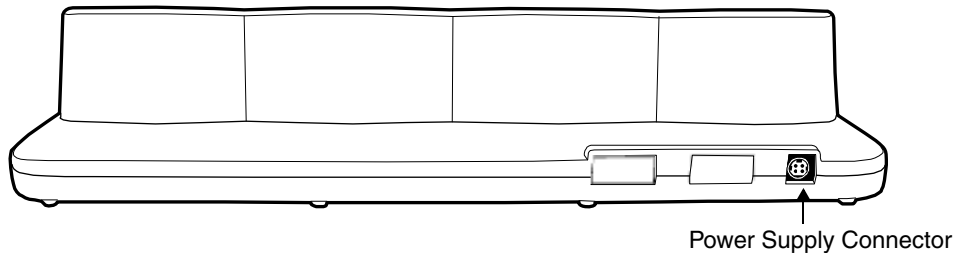

Power Supply Connector

This connector receives input from the power adapter. Plug the power connector cable from the power adapter into this connector. There is no ON/OFF switch on the back panel of the base. The power switch is on the power adapter.

Power Supply

The base includes a power supply that contains a power adapter to ensure the proper voltage. The power adapter is plugged into standard AC/DC outlets.

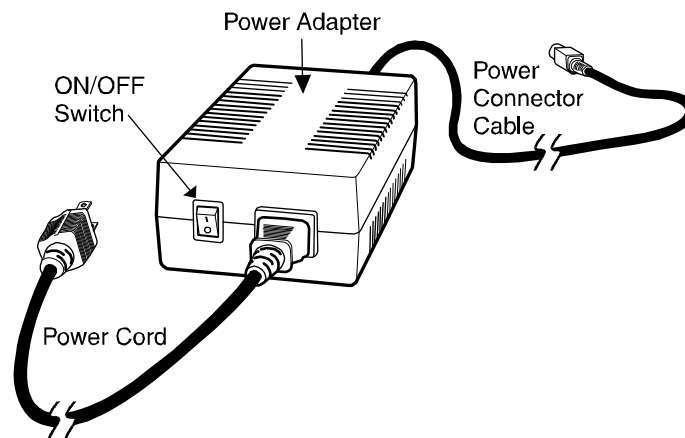

Supplying Power

1. Be sure the power switch on the power adapter is in the OFF position.
2. Plug the power cord into the power adapter.
3. Plug the power connector cable into the power connector on the back panel of the base.
4. Plug the power cord into a standard wall outlet.
5. On the power adapter, turn the power switch to the ON position. The LEDs illuminate as the base powers up.
6. The base is ready to begin charging terminals.

Inserting and Removing Terminals

1. Slide the terminal into the well until the Dock LED lights solid green.

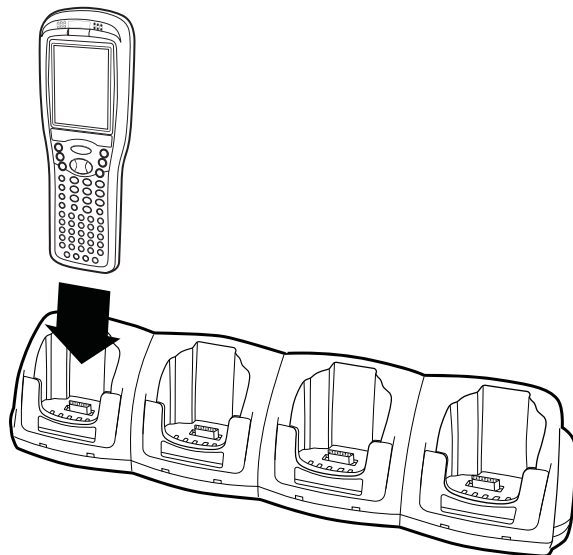

2. Charging begins immediately.

Note: To remove a terminal, grasp it firmly in your hand and lift it up and out of the terminal well. The LEDs for the terminal well turn off.

Charging Terminals

The main battery of each terminal charges in 4.5 hours. The intelligent battery charging system incorporated into all Dolphin terminals prevents overcharging, which means that Dolphin terminals may be seated in the base indefinitely without damage to the terminals, battery packs, or the base.

1. Power the base; see [Supplying Power](#) on page 13-3.
2. Slide the terminal into the well until the Charging LED lights solid green. The Charge LED lights green to indicate that the terminal is powered and charging.

Mounting

This base should be mounted to a dry, stable surface. When choosing a location, always bear in mind that

- The mounting location must allow users easy access to the power connector.
- The base should be oriented so that users can easily read the labels.

Bottom Panel

The bottom panel offers two mounting options: insert a DIN Rail for desk mounting or use mounting brackets with the available screw slots for wall mounting.

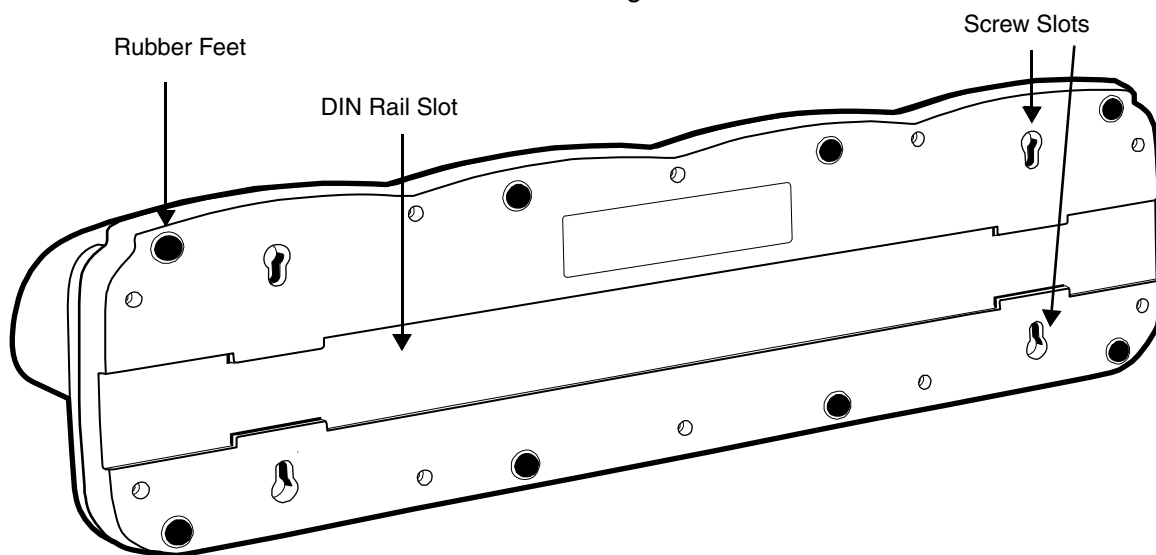

Desk Mounting

The DIN Rail (7.5 X 35 mm) slot on the bottom panel enables secure mounting.

Installation Hardware

Screw: 3/16 in. dia x 5/8 in. long pan head screw

Washer: 1/2 in. OD x 7/32 in. ID x 3/64 in. thick

Nut: 3/16 in. dia

1. Slide the DIN Rail into the DIN Rail slot on the bottom panel.

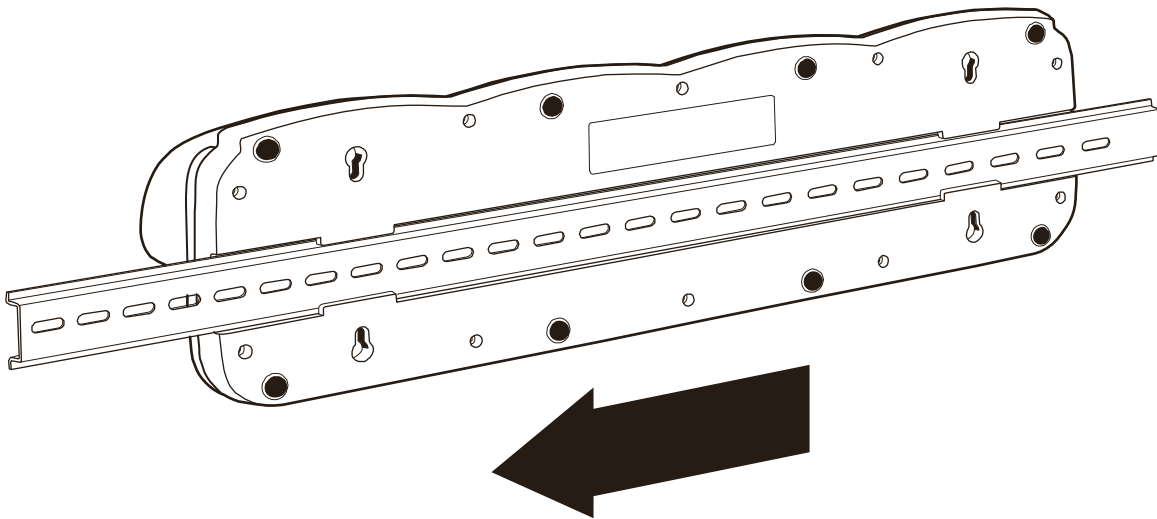

2. Turn the base and DIN Rail right side up.
3. Secure the DIN Rail to a stable, flat horizontal surface.

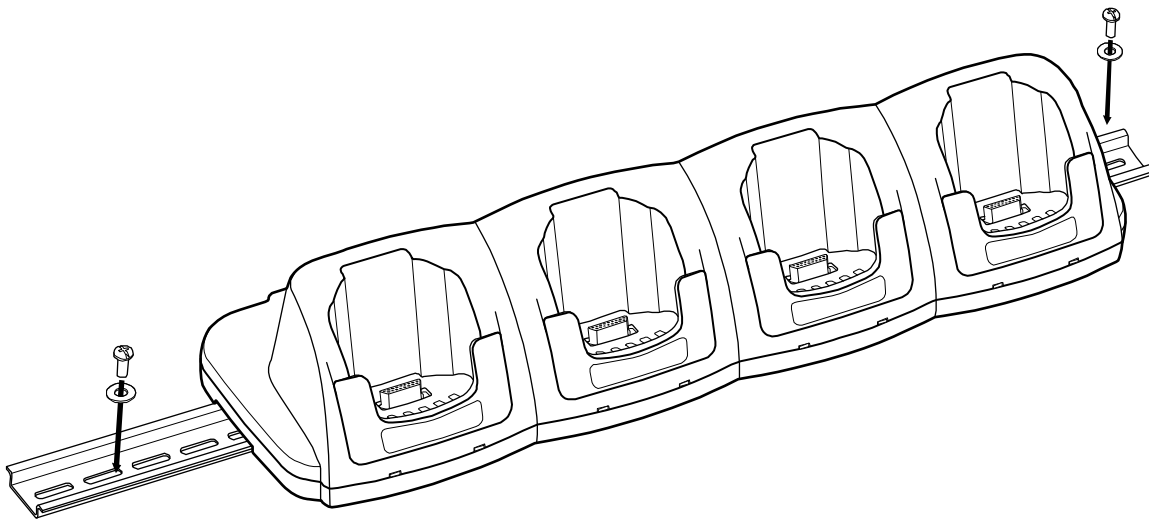

Wall Mounting

You need to purchase **two** wall mount kits that each contain:

- a mounting bracket,
- three screws, and
- six washer/nut sets.

You need two kits so that you have two mounting brackets—one for each end of the device—and enough screws (4) and washer/nut sets (8).

The mounting bracket contains an open slot between the back and bottom wedges to accommodate the connector cables.

To Mount Using the Wall Mount Kit

1. Attach the mounting bracket to the wall using the [Recommended Hardware](#) (see page 13-7).
2. On each end of the base, insert a screw into the round end of each of the 4 screw slots on the bottom panel. Then, slide each screw towards the narrow end of the slot until it snaps in place.
3. Use a washer/nut set on each of the 4 screws to secure the screw in the slot.
4. Place the base on the mounting bracket; match the holes up with the secured screws.
5. Use the remaining washer/nut sets on each of the 4 screws to secure the base to the mounting bracket.

Recommended Hardware

If a metal or wood stud is present, drill a 3/32 in. pilot hole into the stud and use a #6 X 1 1/2 screw and washer to attach the bracket to the wall.

For any of the screws positioned so that they are going directly into dry wall, use a sheet rock anchor/screw set such as the one listed below.

For any of the screws attaching directly into concrete, drill the appropriately sized pilot hole into the concrete and secure the bracket to the wall using concrete anchor screws such as those listed below.

Wall	Recommended Anchors
Sheet Rock	Buildex E-Z Anchor Stud Solver Medium Duty Drywall Anchor (Model #25216); supports 50 lbs., screws included
Concrete	Buildex TAPCON concrete anchors 3/16 in. X at least 1 in.



Dolphin QuadCharger Device

Overview

This 4-slot charging station provides intelligent battery management for the Li-ion battery packs used in Dolphin terminals. The 4th slot features a battery analyzer that completely resets a battery, then displays its remaining capacity.

Capacity

The charger holds 4 Li-ion batteries.

Charging Time

Charge time is 5 hours.

Charging Process

Each charging slot works independently of the other three. As battery packs charge, the charging circuitry follows the two-step charging process (CC-CV) that is recommended for Li-ion batteries. The process monitors changes in temperature, current, and voltage and resets the battery pack.



We recommend use of Honeywell Li-Ion battery packs. Use of any non-Honeywell battery may result in damage not covered by the warranty.



We recommend use of Honeywell peripherals, power cables, and power adapters. Use of any non-Honeywell peripherals, cables, or power adapters may cause damage not covered by the warranty.

Note: The following warnings apply to 99XXXXX-XXXXXXI units (Hazardous Location rated. See [Approvals by Country](#) on page 1-3.).



Replace only with battery pack type 200002586 manufactured by Honeywell International Incorporated.



Warning: Explosion Hazard. Charge or replace the battery only in an area known to be non-hazardous.



Warning: Explosion Hazard. Do not replace components unless power has been switched off or the area is known to be non-hazardous.



Warning: Substitution of any components may impair suitability.



Warning: Explosion Hazard. Do not use external connectors in areas known to be hazardous.

Parts and Functions

Top Panel

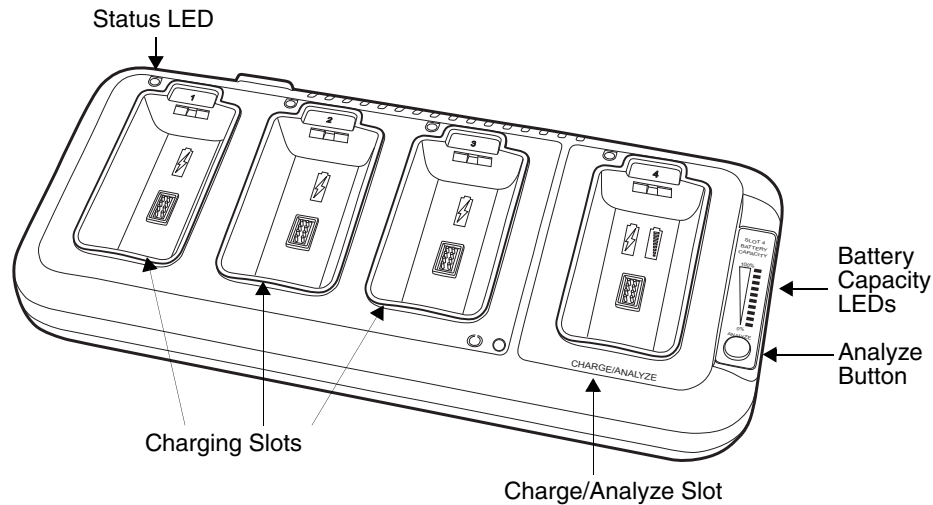

Charging Slots

There are 4 charging slots. Each slot holds one Li-ion battery and charges it independently of the other slots. When a battery is placed in each slot, it immediately begins charging.

Charge/Analyze Slot

This is the 4th slot and the only one that can be used to analyze a battery. When a battery is placed in this slot, it begins charging just as it does in the other three slots. However, if you press the ANALYZE button, it runs the battery in this slot through the complete Analyze cycle. For more information, see [Using the Battery Analyzer](#) on page 14-5.

Battery Capacity Indicator LEDs

These LEDs give a readout of the remaining battery capacity after it has run through a complete analyze cycle.

For more information, see [Battery Capacity Indicator LEDs](#) on page 14-2.

Analyze Button

Press this button to start an Analyze cycle; see [Using the Battery Analyzer](#) on page 14-5.

Status LEDs

A status LED is located above each of the 4 battery slots. The color of the LED indicates the charge status of the batteries in its slot.

Color	This color indicates that the battery in the slot...
Green	Has completed its charge cycle and is ready for use.
Orange	Is being charged at a maximum charge rate.
Red	Encountered an error during the most recent charge cycle.

Back Panel

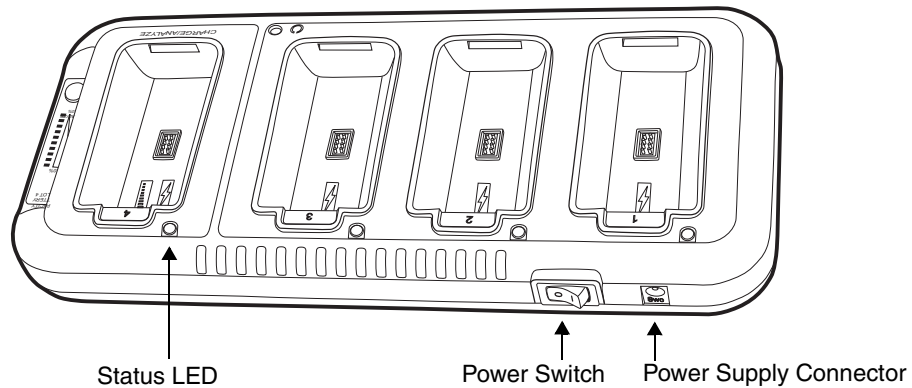

Power Switch

Toggle the power switch to turn the charger on and off.

Power Supply Connector

You attach the power supply to this connector. The universal power supply accepts input voltages between 90-265 volts.

Supplying Power

The charger must be connected to a power source via the Honeywell power adapter cable so that voltage is adjusted appropriately.

1. Locate the AC power adapter cable and plug it into the power source.
2. Connect the power cable to the power adapter.
3. Connect the power cable to the supply connector on the back of the charger.

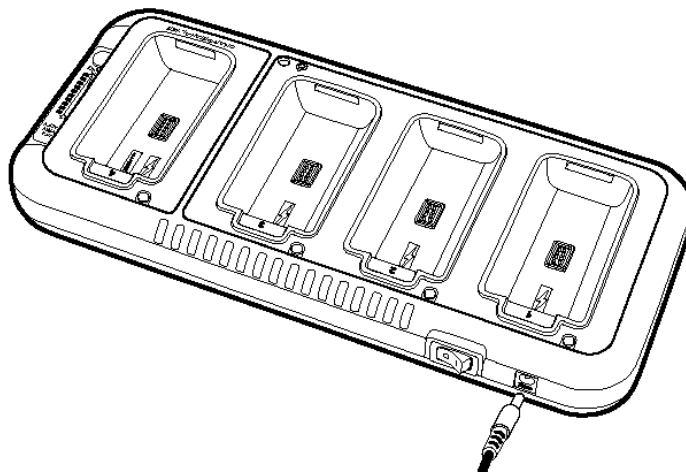

4. Press the power switch to the ON position.
The power LED illuminates green, and the charger performs a self-diagnostic test that lasts approximately five seconds.

Inserting and Removing Battery Packs

To insert a battery pack, place the end of the battery without the locking tab into the bottom of the charging pocket and snap the battery into place with a hinging motion. The Status LED for that particular slot illuminates orange when the battery has been properly inserted.

To remove a battery pack, push the locking tab down and pull the battery out from the charging slot with a hinging motion.

Recommendations for Storing Batteries

To maintain top performance from batteries, follow these storage guidelines:

- Avoid storing batteries outside of the specified temperature range of -4 to 104° F (-20 to 40°C) or in extremely high humidity.
- For prolonged storage, to maximize battery life, it is recommended that the battery be at a 40% - 50% charge level, be removed from any device, and stored in a controlled temperature environment.

Charging Batteries

For best results, battery packs should be at room temperature before recharging them; temperature has a marked effect on charging. The recommended temperature range is 50° to 95° F (10° to 35° C).

1. Set up the charger.
2. Power the charger.
3. Insert batteries into the appropriate slots.
The Status LED for each slot turns orange to indicate that the battery has begun a charge cycle.
4. When the Status LED turns green, the battery in the slot has completed charging.

Using the Battery Analyzer

Purpose

Using the Charge/Analyze slot helps you monitor the charge capacity of Li-ion batteries over time.

Location

The battery analyzer is located in the 4th slot - named the Charge/Analyze slot - of the ChargeBase. Only a battery placed in this slot can be run through an Analyze cycle. This slot contains Battery Capacity LEDs along the right side.

Analyze Cycle

The Analyze cycle is initiated when a battery is placed in the Charge/Analyze slot and the ANALYZE button is pressed. In an Analyze cycle, batteries are completely discharged, then recharged to capacity. The length of time it takes for a battery to complete the Analyze cycle varies depending on the initial state of the battery's charge. Minimum time is 8 hours, maximum time is 12 hours.



Battery Capacity LEDs

The Battery Capacity LEDs are located along the right side of the Charge/Analyze slot. Each LED equates to 10% battery capacity. These LEDs display the capacity of the battery at the end of the Analyze cycle. Battery capacity is displayed as a percentage of measured capacity/rated capacity.

Status LED

The Charge/Analyze slot also contains a standard status LED in the upper, left corner of the slot. When this slot is used for regular charging, this LED operates in the usual manner; see [Status LEDs](#) on page 14-2.

When this slot is being used to analyze a battery, the Status LED functions as follows:

Status LED color **Indicates that the battery in the slot...**

Solid Green Has completed the Analyze cycle.

Flashing Orange Is being analyzed.

Solid Red Encountered an error during the Analyze cycle.

To Analyze a Battery

1. Insert the battery into the Charge/Analyze slot (the 4th).
2. Press the ANALYZE button. The Status LED flashes orange to indicate that the analyzing cycle has begun.

 *The charger is accumulating battery pack information during the entire Analyze cycle. Do NOT remove the battery until the cycle has been completed.*

3. Upon completion of the Analyze cycle, the Status LED lights solid green, and the Battery Capacity Indicator LEDs display the battery's capacity.

You can verify a battery's capacity by installing the battery in a terminal and checking the power; see [Power](#) on page 6-12.

Mounting

The charger should be on a dry, stable surface and can be mounted on a flat, horizontal surface such as a desktop or workbench, or a flat, vertical surface such as a wall.

When choosing a location, always bear in mind that

- the mounting location must allow users easy access to power switch and power connector.
- the charger should be oriented so that users can easily insert and remove battery packs and read the labels, especially for the Battery Analyzer.

Installation Hardware

The DIN rail slot (7.5 X 35 mm) on the bottom panel to enables secure mounting to a desk or a wall.

Screw: 3/16 in. dia x 5/8 in. long pan head screw

Washer: 1/2 in. OD x 7/32 in. ID x 3/64 in. thick

Nut: 3/16 in. dia

Desk Mounting

Slide the DIN rail slot into the bottom panel.

Then, using the appropriate nuts and bolts listed above, secure the DIN rail to the desk or wall.

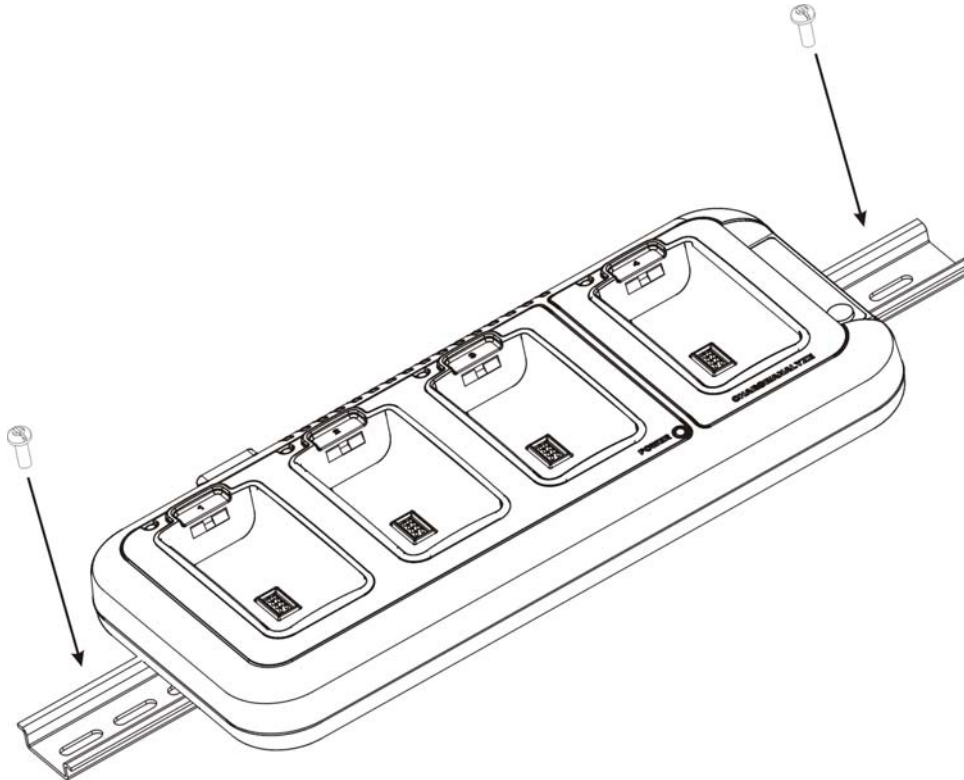

Wall Mounting

Use the appropriate nuts and bolts listed above to secure the DIN rail to a wall.

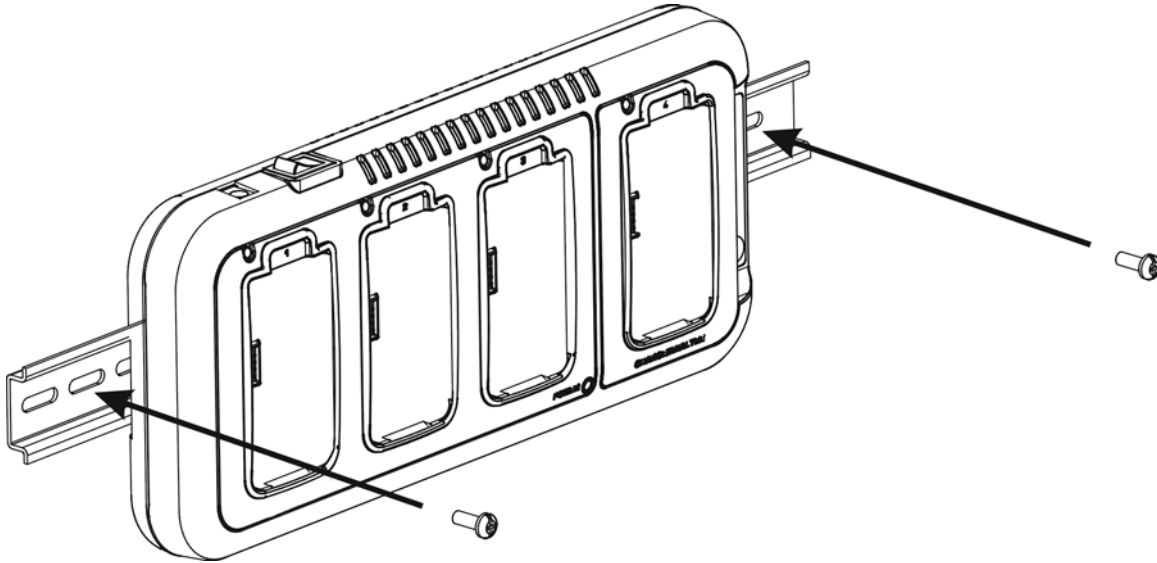

Troubleshooting

If you encounter problems with your, refer to chart below for possible solutions. If problems persist, please contact Honeywell Technical Support.

Problem	Issue
The Status LED does not come on when I insert a battery pac.	Check the power connections; make sure the POWER switch is ON and the battery pack is properly seated.
The Status LED lights red during charging.	Try to charge the battery in one of the other charging slots. If the red Status LED comes on again, then the problem is associated with the battery pack. If the red status stays with the charging slot, the problem is associated with the charging circuitry.
The Status LED lights red and stays on without a battery in the charging slot.	An error occurred during the self-diagnostic test for that particular charging pocket. Call Honeywell Product Service and request an RMA. For additional warranty and return information, see Customer Support on page 15-1.

Product Service and Repair

Honeywell International Inc. provides service for all its products through service centers throughout the world. To obtain warranty or non-warranty service, contact the appropriate location below to obtain a Return Material Authorization number (RMA #) before returning the product.

North America

Telephone: (800) 782-4263
E-mail: hsmnaservice@honeywell.com

Latin America

Telephone: (803) 835-8000
Telephone: (800) 782-4263
Fax: (239) 263-9689
E-mail: laservice@honeywell.com

Brazil

Telephone: +55 (11) 5185-8222
Fax: +55 (11) 5185-8225
E-mail: brservice@honeywell.com

Mexico

Telephone: 01-800-HONEYWELL (01-800-466-3993)
Fax: +52 (55) 5531-3672
E-mail: mxservice@honeywell.com

Europe, Middle East, and Africa

Telephone: +31 (0) 40 2901 633
Fax: +31 (0) 40 2901 631
E-mail: euroservice@honeywell.com

Hong Kong

Telephone: +852-29536436
Fax: +852-2511-3557
E-mail: apservice@honeywell.com

Singapore

Telephone: +65-6842-7155
Fax: +65-6842-7166
E-mail: apservice@honeywell.com

China

Telephone: +86 800 828 2803
Fax: +86-512-6762-2560
E-mail: apservice@honeywell.com

Japan

Telephone: +81-3-3839-8511
Fax: +81-3-3839-8519
E-mail: apservice@honeywell.com

Online Product Service and Repair Assistance

You can also access product service and repair assistance online at www.honeywellaidc.com.

For ongoing and future product quality improvement initiatives, 9900s, 9950s, and 9951s comes equipped with an embedded device lifetime counter function. Honeywell may use lifetime counter data for future statistical reliability analysis as well as ongoing quality, repair and service purposes.

Technical Assistance

If you need assistance installing or troubleshooting your device, please call your distributor or the nearest technical support office:

North America/Canada

Telephone: (800) 782-4263
E-mail: hsmnasupport@honeywell.com

Latin America

Telephone: (803) 835-8000
Telephone: (800) 782-4263
E-mail: hsmiasupport@honeywell.com

Brazil

Telephone: +55 (11) 5185-8222
Fax: +55 (11) 5185-8225
E-mail: brsuporte@honeywell.com

Mexico

Telephone: 01-800-HONEYWELL (01-800-466-3993)
E-mail: soporte.hsm@honeywell.com

Europe, Middle East, and Africa

Telephone: +31 (0) 40 7999 393
Fax: +31 (0) 40 2425 672
E-mail: hsmeurosupport@honeywell.com

Hong Kong

Telephone: +852-29536436
Fax: +852-2511-3557
E-mail: aptechsupport@honeywell.com

Singapore

Telephone: +65-6842-7155
Fax: +65-6842-7166
E-mail: aptechsupport@honeywell.com

China

Telephone: +86 800 828 2803
Fax: +86-512-6762-2560
E-mail: aptechsupport@honeywell.com

Japan

Telephone: +81-3-3839-8511
Fax: +81-3-3839-8519
E-mail: aptechsupport@honeywell.com

Online Technical Assistance

You can also access technical assistance online at www.honeywellaidc.com.

Limited Warranty

Honeywell International Inc. ("HII") warrants its products and optional accessories to be free from defects in materials and workmanship and to conform to HII's published specifications applicable to the products purchased at the time of shipment. This warranty does not cover any HII product which is (i) improperly installed or used; (ii) damaged by accident or negligence, including failure to follow the proper maintenance, service, and cleaning schedule; or (iii) damaged as a result of (A) modification or alteration by the purchaser or other party, (B) excessive voltage or current supplied to or drawn from the interface connections, (C) static electricity or electro-static discharge, (D) operation under conditions beyond the specified operating parameters, or (E) repair or service of the product by anyone other than HII or its authorized representatives.

This warranty shall extend from the time of shipment for the duration published by HII for the product at the time of purchase ("Warranty Period"). Any defective product must be returned (at purchaser's expense) during the Warranty Period to HII factory or authorized service center for inspection. No product will be accepted by HII without a Return Materials Authorization, which may be obtained by contacting HII. In the event that the product is returned to HII or its authorized service center within the Warranty Period and HII determines to its satisfaction that the product is defective due to defects in materials or workmanship, HII, at its sole option, will either repair or replace the product without charge, except for return shipping to HII.

EXCEPT AS MAY BE OTHERWISE PROVIDED BY APPLICABLE LAW, THE FOREGOING WARRANTY IS IN LIEU OF ALL OTHER COVENANTS OR WARRANTIES, EITHER EXPRESSED OR IMPLIED, ORAL OR WRITTEN, INCLUDING, WITHOUT LIMITATION, ANY IMPLIED WARRANTIES OF MERCHANTABILITY OR FITNESS FOR A PARTICULAR PURPOSE, OR NON-INFRINGEMENT.

HII'S RESPONSIBILITY AND PURCHASER'S EXCLUSIVE REMEDY UNDER THIS WARRANTY IS LIMITED TO THE REPAIR OR REPLACEMENT OF THE DEFECTIVE PRODUCT WITH NEW OR REFURBISHED PARTS. IN NO EVENT SHALL HII BE LIABLE FOR INDIRECT, INCIDENTAL, OR CONSEQUENTIAL DAMAGES, AND, IN NO EVENT, SHALL ANY LIABILITY OF HII ARISING IN CONNECTION WITH ANY PRODUCT SOLD HEREUNDER (WHETHER SUCH LIABILITY ARISES FROM A CLAIM BASED ON CONTRACT, WARRANTY, TORT, OR OTHERWISE) EXCEED THE ACTUAL AMOUNT PAID TO HII FOR THE PRODUCT. THESE LIMITATIONS ON LIABILITY SHALL REMAIN IN FULL FORCE AND EFFECT EVEN WHEN HII MAY HAVE BEEN ADVISED OF THE POSSIBILITY OF SUCH INJURIES, LOSSES, OR DAMAGES. SOME STATES, PROVINCES, OR COUNTRIES DO NOT ALLOW THE EXCLUSION OR LIMITATIONS OF INCIDENTAL OR CONSEQUENTIAL DAMAGES, SO THE ABOVE LIMITATION OR EXCLUSION MAY NOT APPLY TO YOU.

All provisions of this Limited Warranty are separate and severable, which means that if any provision is held invalid and unenforceable, such determination shall not affect the validity of enforceability of the other provisions hereof. Use of any peripherals not provided by the manufacturer may result in damage not covered by this warranty. This includes but is not limited to: cables, power supplies, cradles, and docking stations. HII extends these warranties only to the first end-users of the products. These warranties are non-transferable.

The limited duration of the warranty for Dolphins 9900, 9950, and 9951 is as follows:

- The duration of the limited warranty for terminals with an integrated imager is two years.
- The duration of the limited warranty for touch screens is one year.
- The duration of the limited warranty for the Dolphin HomeBase device, Dolphin QuadCharger device, Dolphin Mobile Base, Dolphin ChargeBase device, Dolphin Net Base device, and Mobile Charger is one year.
- The duration of the limited warranty for batteries is one year.
Use of any battery from a source other than Honeywell may result in damage not covered by the warranty. Batteries returned to Honeywell International Inc. in a reduced state may or not be replaced under this warranty. Battery life will be greatly increased when following the battery instructions in this user's guide.

How to Extend Your Warranty

Honeywell International Inc. offers a variety of service plans on our hardware products. These agreements offer continued coverage for your equipment after the initial warranty expires. For more information, contact your Sales Representative, Customer Account Representative, or Product Service Marketing Manager from Honeywell International Inc., or your Authorized Reseller.



Honeywell Scanning & Mobility
9680 Old Bailes Road
Fort Mill, SC 29707

www.honeywellaidc.com