

HMLCD15

15-inch LCD Monitor

User Manual

Honeywell

Video Systems
www.honeywellvideo.com
1-800-796-CCTV

© 2004 Honeywell International Inc.



All rights reserved. No part of this publication may be reproduced by any means without written permission from Honeywell Video Systems. The information in this publication is believed to be accurate in all respects. However, Honeywell Video Systems cannot assume responsibility for any consequences resulting from the use thereof. The information contained herein is subject to change without notice. Revisions or new editions to this publication may be issued to incorporate such changes.

SECTION 5: SPECIFICATIONS

ISSUE	DATE	REVISIONS
A	April 2004	Initial Release (PCN 1630)

LCD	Type	TFT Color XGA
	Screen Size	15" (diagonal)
PC Input	Signal	RGB Analog
	Type	15-Pin D-Sub
Sync	H-Freq	31.5~60KHz
	V-Freq	56-75Hz
Display	Color	16,777,216
Resolution		1024 × 768 (75Hz)
OSD Controls		Auto Geometry, Auto Brightness, Contrast, H/V Position, etc.
Power Management		VESA DPMS
Power Consumption		30W (max)
Power Saving Mode		Under 1W
Plug & Play		DDC1/2B
Speaker		2W × 2Ea.
Tilt	U/D	15° / 3°
Temperature	Operating	32°F to 104°F (0°C to 40°C)
	Storage	14°F to 122°F (-10°C to 50°C)
Humidity	Operating	30% ~ 80%
	Storage	5% ~ 90%
Dimensions (W x H x D)		14.5 x 14.5 x 6.7 inches (368 × 367 × 171 mm)

Specifications are subject to change without prior notice for product improvements. Actual specifications may vary depending on features and components.

4.4 LIMITED WARRANTY

Honeywell International Inc. ("Seller"), 1305 Waters Ridge Drive, Lewisville, TX 75057, warrants this monitor to be in conformance with its own plans and specifications and to be free from defects in materials and workmanship under normal use and service for a period of up to one (1) year from the date of manufacture. Seller's obligation shall be limited to repairing or replacing, at its option, free of charge for materials or labor, any product which is proved not in compliance with Seller's specifications or proves defective in materials or workmanship under normal use and service. Seller shall have no obligation under this Limited Warranty or otherwise if the product is altered or improperly repaired or serviced by anyone other than Honeywell factory service. For warranty service, return product transportation prepaid, to Honeywell Video Systems Factory Service, 1305 Waters Ridge Drive, Lewisville, TX 75057.

THERE ARE NO WARRANTIES, EXPRESS OR IMPLIED, OF MERCHANTABILITY, OR FITNESS FOR A PARTICULAR PURPOSE OR OTHERWISE, WHICH EXTEND BEYOND THE DESCRIPTION ON THE FACE HEREOF. IN NO CASE SHALL SELLER BE LIABLE TO ANYONE FOR ANY CONSEQUENTIAL OR INCIDENTAL DAMAGES FOR BREACH OF THIS OR ANY OTHER WARRANTY, EXPRESS OR IMPLIED, OR UPON ANY OTHER BASIS OF LIABILITY WHATSOEVER, EVEN IF THE LOSS OR DAMAGE IS CAUSED BY THE SELLER'S OWN NEGLIGENCE OR FAULT.

Seller does not represent that the products it sells may not be compromised or circumvented; that the products will prevent any personal injury or property loss by burglary, robbery, fire or otherwise; or that the products will in all cases provide adequate warning or protection. Customer understands that a properly installed and maintained alarm may only reduce the risk of a burglary, robbery, fire or other events occurring without providing an alarm, but it is not insurance or a guarantee that such will not occur or that there will be no personal injury or property loss as a result. CONSEQUENTLY, SELLER SHALL HAVE NO LIABILITY FOR ANY PERSONAL INJURY, PROPERTY DAMAGE OR OTHER LOSS BASED ON A CLAIM THE PRODUCT FAILED TO GIVE WARNING. HOWEVER, IF SELLER IS HELD LIABLE, WHETHER DIRECTLY OR INDIRECTLY, FOR ANY LOSS OR DAMAGE ARISING UNDER THIS LIMITED WARRANTY OR OTHERWISE, REGARDLESS OF CAUSE OR ORIGIN, SELLER'S MAXIMUM LIABILITY SHALL NOT IN ANY CASE EXCEED THE PURCHASE PRICE OF THE PRODUCT, WHICH SHALL BE THE COMPLETE AND EXCLUSIVE REMEDY AGAINST SELLER. This warranty replaces any previous warranties and is the only warranty made by Seller on this product. No increase or alteration, written or verbal, of the obligations of this Limited Warranty is authorized.

FCC COMPLIANCE STATEMENT

INFORMATION TO THE USER: This equipment has been tested and found to comply with the limits for a Class A digital device, pursuant to Part 15 of the FCC rules. These limits are designed to provide reasonable protection against harmful interference when the equipment is operated in a commercial environment. This equipment generates, uses, and can radiate radio frequency energy and, if not installed and used in accordance with the instruction manual, may cause harmful interference to radio communications. Operation of this equipment in a residential area is likely to cause harmful interference in which case the user will be required to correct the interference at his own expense.

CAUTION: Changes or modifications not expressly approved by the party responsible for compliance could void the user's authority to operate the equipment.

This Class A digital apparatus complies with Canadian ICES-003.

Cet appareil numérique de la Classe A est conforme à la norme NMB-003 du Canada.

EXPLANATION OF GRAPHICAL SYMBOLS



The lightning flash with arrowhead symbol within an equilateral triangle is intended to alert the user to the presence of uninsulated "dangerous voltage" within the product's enclosure that may be of sufficient magnitude to constitute a risk of electric shock to persons.



The exclamation point within an equilateral triangle is intended to alert the user to the presence of important operating and maintenance (servicing) instruction in the literature accompanying the product.

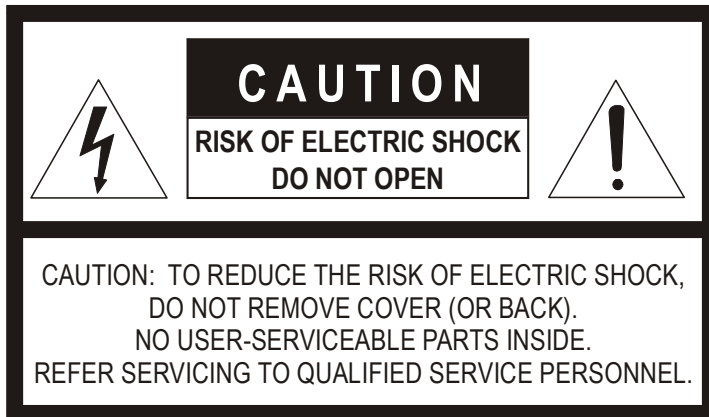

SECTION 4: TROUBLESHOOTING AND MAINTENANCE

4.1 TROUBLESHOOTING

No Power

- Make sure the Power cable is plugged to the wall and the back of the monitor.
- Make sure that the Power button on the front of the monitor is turned ON. Press the Power button firmly to turn the power OFF, then again to turn it ON.

Poor Picture Quality

If the quality of the picture is poor and cannot be improved by making adjustments on the front control panel, inspect all system connections and cable runs.

4.2 MAINTENANCE

To reduce the risk of electrical shock, do not remove the cover or back of monitor. No user-serviceable parts are inside.

4.3 SERVICE AND SUPPORT

Refer servicing to qualified personnel or contact the Technical Support at 1-800-796-CCTV for assistance.

NOTES:

WARNINGS

Installation and servicing should be performed only by qualified and experienced personnel.

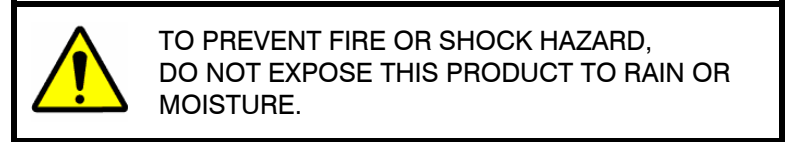

SAFEGUARDS

This product is made with consideration of the maximum safety of users. However, in order to prevent all possible accidents and financial lost, the monitor must be installed in the appropriate environment. Read instructions and follow all safeguards.

POWER WARNINGS

1. Insert the power plug completely into the socket and verify that it is inserted well. An unstable connection can cause fire.
2. Do not use a damaged power cable or plug or a loose socket. Doing so may cause electric shock or fire.
3. Do not touch the plug with wet hands. Doing so may cause electric shock or fire.
4. Do not overload the socket by using it for several devices at the same time. Doing so may cause a fire.

ENVIRONMENT/INSTALLATION WARNINGS

1. Do not install the unit in an extremely hot or humid location, or in a place subject to dust or mechanical vibration. Do not install in locations with oil or smoke or inside vehicles. The unit is not designed to be waterproof. Exposure to rain or water may damage the unit. Do not use this unit near water or in an unprotected outdoor installation, or any area which is classified as a wet location.

SAFEGUARDS, CONTINUED

2. Do not place candlelight, mosquito coils, or cigarettes on top of the monitor or install it close to heating appliances. Doing so may damage the product or create a fire danger. The product should be situated away from heat sources such as radiators, heat registers, stoves, or other products (including amplifiers) that produce heat.
3. Do not place this product on an unstable cart, stand, tripod, bracket, or table. Do not install in an unstable location or place the monitor on top of a smaller stand. The product may fall, causing serious injury to a child or adult and serious damage to the monitor."
4. Do not leave the power cable close to any heating appliance or product that may generate heat. Heat-producing items can melt the skin of the power cable and cause electric shock or fire.
5. Power supply cords should be routed so that they are not likely to be walked on or pinched by items placed upon or against them, paying particular attention to cords and plugs, convenience receptacles, and the point where they exit from the unit. Do not bend the power cable by force or place a heavy object on it as this may cause electric shock or fire.
6. When removing the power plug, hold the plug head properly. Pulling on the power cord itself may damage the core of the cable and cause heating or danger of fire.
7. Remove power from the monitor when cleaning the monitor or around the plug. Do not use flammable spray or material when cleaning the monitor or place any such materials near the monitor.
8. Slots and openings in the cabinet and the back or bottom are provided for ventilation and to ensure reliable operation of the equipment and to protect it from overheating. These openings must not be blocked or covered. Equipment should never be placed near or over a radiator or heat register. This product should not be placed in a built-in installation, such as a bookcase or rack unless proper ventilation is provided or the manufacturer's instructions have been adhered to.

3.4 GETTING OPTIMAL PICTURE

- Step 1:** Window's background or "H" character should be displayed on your screen.
- Step 2:** Adjust the screen to the center of the Display (LCD) by using the top and bottom display controls and the V-Position Adjust menu.



- Step 3:** Adjust the screen to the center of the Display (LCD) by using the right and left display controls and the Horizontal size and H=Position Adjust menu.

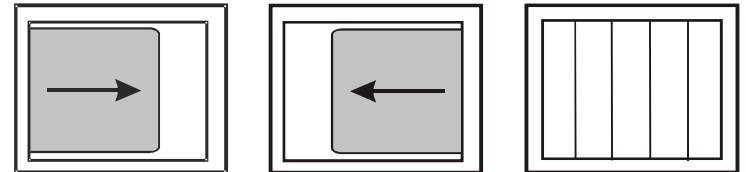

- Step 4:** Adjust the phase until the "H" character displays clearly.



- Step 5:** Using the Contrast, Brightness, and Color options, set the color.
- Step 6:** When finished adjusting, save the settings by pressing the Exit key.

3.3 ON-SCREEN DISPLAY (OSD) CONTROL PROCEDURE, CONTINUED

Using HOTKEY

Frequent adjustments such as auto-geometry, Brightness, Contrast, Audio-volume, Audio-Mute, and Source (selected in RGB/VIDEO) can be quickly done without calling the MENU. The following table describes the HOTKEY.

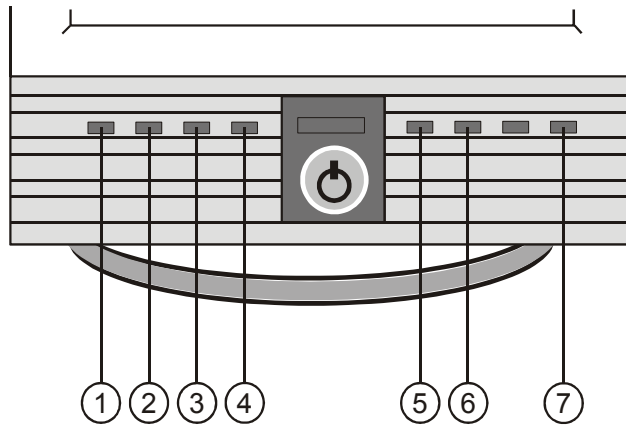

OSD KEY		DESCRIPTION
1	BRT	BRIGHTNESS
2	CONT	CONTRAST
3	VOL	AUDIO-VOLUME
4	MUTE	AUDIO- MUTE
5	SOURCE	SELECTED IN RGB/S-VHS COMPOSITE
6	CH	REFERENCE TO TV BOX MANUAL
7	AUTO	AUTO GEOMETRY

SAFEGUARDS, CONTINUED

CLEANING AND GENERAL USAGE

1. For added protection of this unit during a lightning storm, or when it is left unattended and unused for long periods of time, unplug it from the wall outlet and disconnect the cable system. This will prevent damage to the unit due to lightning and power-line surges.
2. Never push objects of any kind into this unit through openings as they may touch dangerous voltage points or short-out parts that could result in a fire or electric shock. Never spill liquid of any kind on the unit.
3. Do not attempt to service this unit yourself as opening or removing covers may expose you to dangerous voltage or other hazards. Refer all servicing to qualified service personnel.
4. When moving the monitor, turn the monitor OFF, unplug the power cord, and make sure that all other connecting cables are disconnected. This will prevent electric shock or fire caused by cable damage.
5. If the monitor makes an unusual noise or produces a burning odor or smoke, disconnect it from power immediately and contact the service center.
6. If the monitor is not used for a long period of time, disconnect it from the power outlet.
7. Consult with the service center once each year to clean the inside of the monitor. Accumulation of dust inside the monitor may cause fire or malfunction.
8. Unplug the unit from the outlet before cleaning. Do not use liquid or aerosol cleaners. Use a clean soft cloth for cleaning. Do not use wax, benzene, alcohol, thinner, mosquito spray, aromatic or lubricating oil, or any other detergent or chemical.
9. Do not place the monitor face down on the floor or press on it, otherwise the LCD screen may be damaged.
10. Careless use and improper repair may cause electric shock and/or damage to the product. Do not open the monitor.

PURCHASE INFORMATION

Date Purchased: _____

Serial Number: _____

Location Installed: _____

**3.3 ON-SCREEN DISPLAY (OSD) CONTROL PROCEDURE,
CONTINUED**

OSD Menu		Description	
OSD	Horizontal Position	Select OSD Menu horizontal position.	
	Vertical position	Select OSD MENU vertical position.	
	Timeout	Time after which OSD MENU leaves screen.	
	Transparency	Adjust the transparency of the OSD Menu.	
	Language	English	Select one of the five languages.
		French	
		German	
	Italian		
	Spanish		
Advanced	Horizontal Position	Select OSD Menu horizontal position.	
	Factory Preset	Initialize the current mode.	
	Information	Normal state of the monitor.	
Audio	Volume	Adjust the volume level.	
	Balance	Adjust the audio balance.	
	Treble	Adjust the volume of the high sounds.	
	Bass	Adjust the volume of the low sounds.	
	Mute	Turn the sound ON or OFF.	
Input Select	Analog	Selects analog signal.	
	S-VHS	Selects S-VHS mode.	
	Video	Selects Video mode.	
Video	Sharpness	Control the outline.	
	Brightness	Adjust the brightness of the screen.	
	Contrast	Adjust the contrast of the screen.	
	Color	Adjust the saturation of Red, Green, and Blue in the display area.	
	Hue	Adjust the tone of color.	

3.3 ON-SCREEN DISPLAY (OSD) CONTROL PROCEDURE, CONTINUED

OSD Menu Description

The following table describes the OSD menu and a description of each option.

OSD Menu		Description	
Picture	Auto adjustment	Automatically adjusts the Horizontal position, Vertical position, horizontal size and Phase. Windows background or characters should be displayed on the full screen prior to processing this function.	
	Horizontal position	Adjust the horizontal position of the screen's image.	
	Vertical position	Adjust the vertical position of the screen's image.	
	Horizontal size	Adjust the horizontal size of the screen's image.	
	Phase	Adjust the focus of the screen's image.	
	DOS/Graphics	Select priority of DOS mode/ Graphic mode.	
Color	Auto adjustment	Adjust the color balance of the screen.	
	Brightness	Adjust the brightness of the screen.	
	Contrast	Adjust the contrast of the screen.	
	Temperature	6500k	Control the temperature of the color
		9300k	
		User	Control the intensity of the color of the screen's image.
		Red	
	Green		
		Blue	

TABLE OF CONTENTS

SECTION 1: INTRODUCTION 1

1.1 INTRODUCTION 1

1.2 FEATURES 1

1.3 TFT LCD PANEL 2

1.4 CONTENTS OF PACKAGE 3

SECTION 2: CONTROLS AND CONNECTIONS 5

2.1 CONTROLS – FRONT PANEL 5

2.2 CONTROLS – REAR PANEL 6

2.3 INSTALLING THE MONITOR DRIVER 7

2.4 VGA CABLE 7

SECTION 3: OPERATION 9

3.1 POWER MANAGEMENT 9

3.2 PRESET MODE CHART 10

 Timing Charts 10

 Input Timing Limits 10

 Input Level Limits 10

 Preset Mode Table 11

3.3 ON-SCREEN DISPLAY (OSD) CONTROL PROCEDURE 12

 On-Screen Display (OSD) Control Adjustment 13

 OSD Menu Description 14

 Using HOTKEY 16

3.4 GETTING OPTIMAL PICTURE 17

TABLE OF CONTENTS, CONTINUED

SECTION 4: TROUBLESHOOTING AND MAINTENANCE..... 19

4.1 TROUBLESHOOTING 19

 No Power 19

 Poor Picture Quality..... 19

4.2 MAINTENANCE..... 19

4.3 SERVICE AND SUPPORT 19

4.4 LIMITED WARRANTY 20

SECTION 5: SPECIFICATIONS..... 21

3.3 ON-SCREEN DISPLAY (OSD) CONTROL PROCEDURE, CONTINUED

On-Screen Display (OSD) Control Adjustment

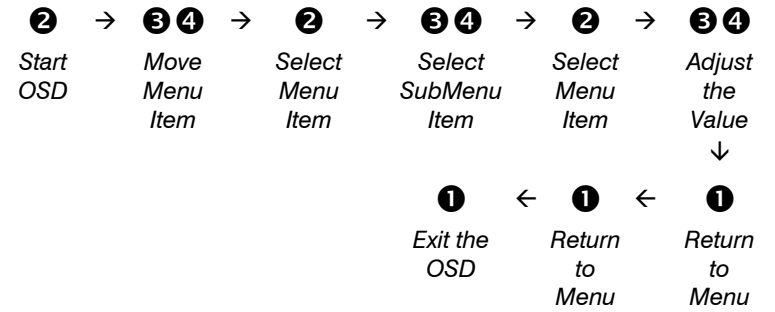

3.2 PRESET MODE CHART, CONTINUED

The monitor is compatible with additional modes within one of the following specified frequency ranges, provided they are different at least for one of the following:

Horizontal Frequency: ± 1 KHz

Vertical Frequency: ± 1 Hz

3.3 ON-SCREEN DISPLAY (OSD) CONTROL PROCEDURE

Image and sound can easily be adjusted through an OSD menu.

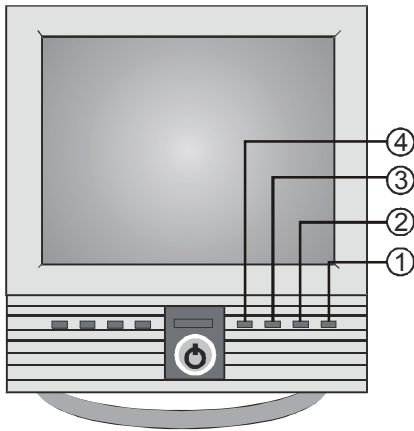

1	AUTO / EXIT	Used to exit OSD
2	MENU / SEL	Used to start the OSD and select options
3	CH ▷	Menu move/adjust buttons. Used to move the menu bar or adjust values.
4	SOURCE ◁	

SECTION 1: INTRODUCTION

1.1 INTRODUCTION

Honeywell's HMLCD15 TFT Color LCD Display features a 15.0" viewable active matrix LCD screen, with outstanding 1024 x 768 pixel resolution. When used in PC based applications the HMLCD15 provides connection points for VGA, PC Sound, and headphones. CCTV applications are supported by input connections for audio, Y/C (S-Video) and composite video sources while providing a flicker free viewing experience not normally experienced with traditional CRT-type monitors. Easy to access front panel OSD display controls including direct contrast, brightness, volume and mute control buttons along with single button source selection for quick and easy adjustments.

1.2 FEATURES

- XGA (1024x768) resolution LCD module
- 16,777,216 Color Display
- DPMS (Display Power Management Signaling)
- OSD (On-Screen Display) controls
- Multi-language OSD Menu
- Utilizes DDC1/2B controls. The system will perform Plug & Play feature if both monitor and host system support DDC1/2B protocol.
- Internal speakers

1.3 TFT LCD PANEL

Black spots (pixels that do not light) or luminescent spots (pixels that are always lit) may appear on the screen because of the intrinsic characteristics of TFT LCD technology. This is neither a malfunction nor a defect in the monitor. The warranty period for the occurrence of black spots and luminescent spots is 1 month from the date of purchase. Monitors with less than 3 such pixels will not be exchanged.

The HMLCD15 uses high-voltage fluorescent tubes. If a portion or whole of the screen becomes dark or flickers intermittently, the monitor can be exchanged for free. Contact Customer Service within one year of purchase date.

When the HMLCD15 is not in use, the screen must be turned off or the pattern must be frequently changed by using a screen saver. If the same pattern is displayed on the screen for a long period of time, image sticking may occur or the life of the monitor may be shortened.



Some computer systems are not compatible with the DDC standard. If your monitor is displaying the wrong resolution, check your computer system for a DDC compatible video card and contact the Service Center.

3.2 PRESET MODE CHART, CONTINUED

Preset Mode Table

Horizontal	Pixel	640	640	640	640	720	800	800
Frequency	KHz	31.444	31.469	37.862	37.500	31.440	35.156	37.879
Period (T1)	ms	31.778	31.778	26.413	26.667	31.778	28.444	26.400
Sync Width (T2)	ms	2.542	3.813	1.270	2.032	3.813	2.000	3.200
Back Poach (T3)	ms	3.178	1.907	4.064	3.810	1.907	3.556	2.200
Active (T4)	ms	25.422	25.422	20.317	20.317	25.422	22.222	20.000
Front Poach (T5)	ms	0.635	0.636	0.762	0.508	0.636	0.667	1.000
Vertical	Line	350	480	480	480	400	600	600
Frequency	Hz	70.087	59.940	72.539	75.000	70.087	56.250	60.317
Period (T1)	ms	14.268	16.683	13.735	13.333	14.268	17.778	16.579
Sync Width (T2)	ms	0.095	0.064	0.079	0.080	0.064	0.057	0.106
Back Poach (T3)	ms	1.905	1.048	0.739	0.427	1.080	0.626	0.607
Active (T4)	ms	11.136	15.253	12.678	12.800	12.711	17.067	15.840
Front Poach (T5)	ms	1.145	0.318	0.237	0.027	0.413	0.028	0.026
Interlaced	Y/N	N	N	N	N	N	N	N
Sync Polarity	H	P	N	N	N	N	P	P
	V	N	N	N	N	P	P	P

Horizontal	Pixel	800	800	832	1024	1024	1024
Frequency	KHz	48.077	46.875	49.726	48.363	56.476	60.023
Period (T1)	ms	20.800	21.333	20.110	20.677	17.707	16.660
Sync Width (T2)	ms	2.400	1.616	3.910	2.092	1.813	1.219
Back Poach (T3)	ms	1.280	3.232	1.117	2.462	1.920	2.235
Active (T4)	ms	16.000	16.162	14.524	15.754	13.653	13.653
Front Poach (T5)	ms	1.120	0.323	0.559	0.369	0.320	0.203
Vertical	Line	600	600	624	768	768	768
Frequency	Hz	72.188	75.000	74.552	60.004	70.069	75.029
Period (T1)	ms	13.853	13.333	13.414	16.666	14.272	13.328
Sync Width (T2)	ms	0.125	0.064	0.060	0.124	0.106	0.050
Back Poach (T3)	ms	0.478	0.448	0.784	0.600	0.513	0.466
Active (T4)	ms	12.480	12.800	12.549	15.880	13.599	12.795
Front Poach (T5)	ms	0.770	0.021	0.020	0.062	0.053	0.017
Interlaced	Y/N	N	N	N	N	N	N
Sync Polarity	H	P	P	-	N	N	P
	V	P	P	-	N	N	P

3.2 PRESET MODE CHART

Timing Charts

The monitor shall be capable of supporting the following video timings:

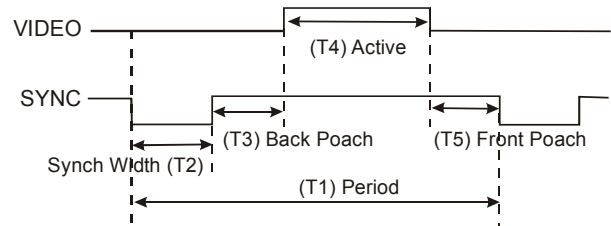

Input Timing Limits

H-Sync Pulse Width $1.0 \mu\text{s} \leq \text{Sync Pulse Width} \leq 6.0 \mu\text{s}$.
 V-Sync Pulse Width $0.04\text{ms} \leq \text{Sync Pulse Width} \leq 0.5\text{ms}$





NOTE: If the width of Sync Pulse is out of input timing range, the monitor may operate abnormally. Check Sync Pulse Width of Input Timing.

Input Level Limits

Low level: 0.4V (Max)
 High level: 2.4V (Min)

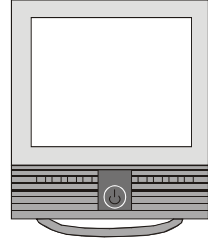
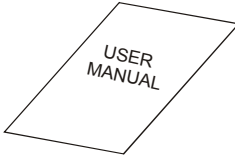
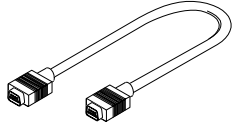
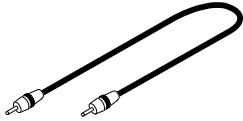
NOTE: For better quality display image, use the timing and polarity shown in the preset mode table. Refer to your video card's user guide to ensure compatibility.

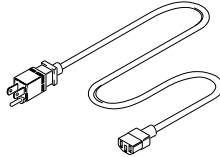
1.4 CONTENTS OF PACKAGE

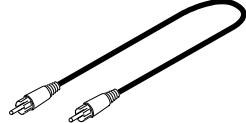
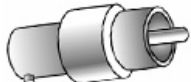
1. LCD Monitor 	2. User Manual 	3. VGA Cable 
4. Sound Cable 	5. AC/DC Adapter 	6. Installation Disk 
7. Power Cord 	8. Video Sound Cable 	
9. Composite Cable 	10. BNC to RCA Adapters (2) 	
OPTIONAL ACCESSORIES: S-video cable, Wall Mount adapter (VESA standard)		

SECTION 3: OPERATION

3.1 POWER MANAGEMENT

This monitor is equipped with DPMS (Display Power Management Signaling) function which automatically switches to power saving mode (less than 5 watts consumed) when the computer is left unattended. Although the monitor can be left in power saving mode for longer periods, it is recommended that you turn it off after your daily work.

The DPMS function requires support from the computer system of any software DPMS function currently being used. If the keyboard (or mouse) is left unattended for a certain period, the program or system will set the sync signals to SPMS modes. The DPMS function has three states. Recommended signals, power consumption, and recovery time are shown in the table below:

Status	Signal			Power Consumption	Recovery Time	LED Indicator
	HSync	VSynC	Video			
On	Pulse	Pulse	Active	30Watt	--	Green
Standby	No Pulse	Pulse	Blank	Less than 5Watt	Within 2sec	Alternating Green/Orange (1sec)
Suspend	Pulse	No Pulse	Blank			Alternating Green/Orange (0.5sec)
Off	No Pulse	No Pulse	Blank			Orange

NOTES:

SECTION 2: CONTROLS AND CONNECTIONS

2.1 CONTROLS – FRONT PANEL

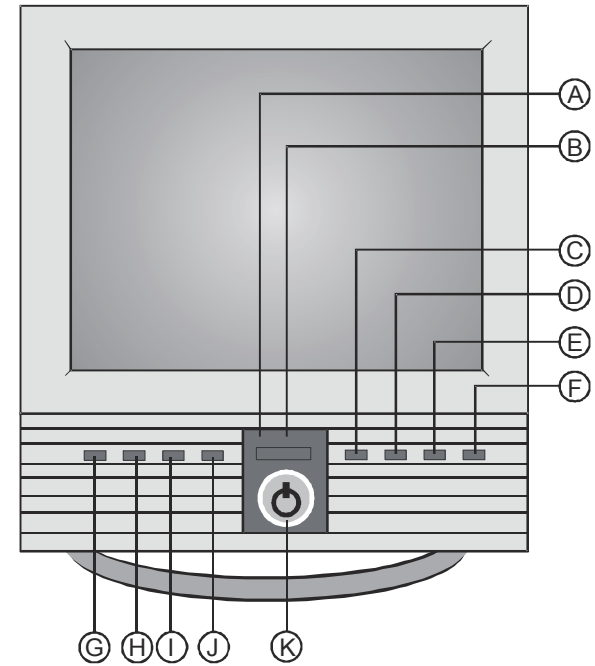

A	AV1	} LAMP
B	PC	
C	SOURCE ◀	
D	CH ▶	
E	MENU/SEL	

F	AUTO/EXIT
G	BRT ◀
H	CONT ▶
I	VOL ◀
J	MUTE ▶
K	POWER BUTTON

2.2 CONTROLS – REAR PANEL

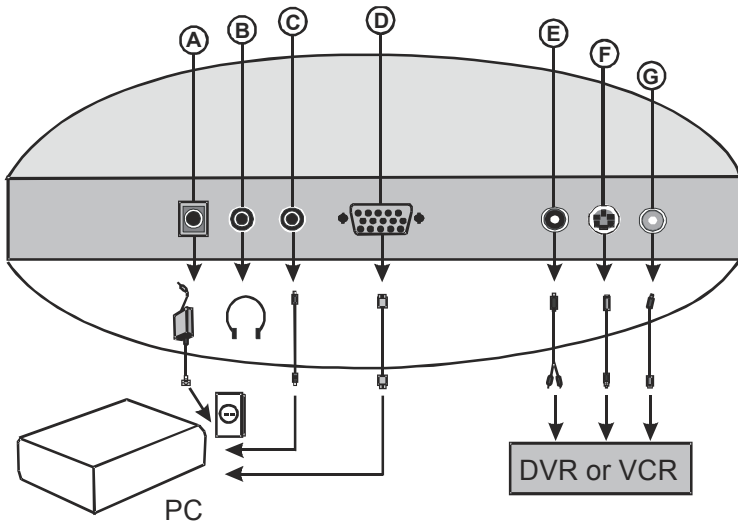

A	DC12V	
B	Ear	
C	PC Sound	
D	VGA	
E	Video Sound	} AV1
F	S-VHS	
G	Composite	

2.3 INSTALLING THE MONITOR DRIVER

You can achieve an optimal resolution and scanning rate by installing the monitor driver as follows:

1. Insert the monitor driver diskette into the floppy diskette drive and run INSTALL.EXE.
2. Select the monitor model then press OK. The installation will begin immediately.

2.4 VGA CABLE

A 15-pin D-Sub connector is used as the input signal connector. Pin and input signal are shown in the table below.

Pin	Name	Pin	Name	Pin	Name
1	Red	2	Green	3	Blue
4	N.C	5	GND	6	RED-GND
7	GREEN-GND	8	BLUE-GND	9	+5V
10	Logic-GND	11	N.C	12	SDA (DDC)
13	H-sync	14	V-sync	15	SCL (DDC)