

T775A,B,C,D Remote Temperature Controller

PRODUCT DATA

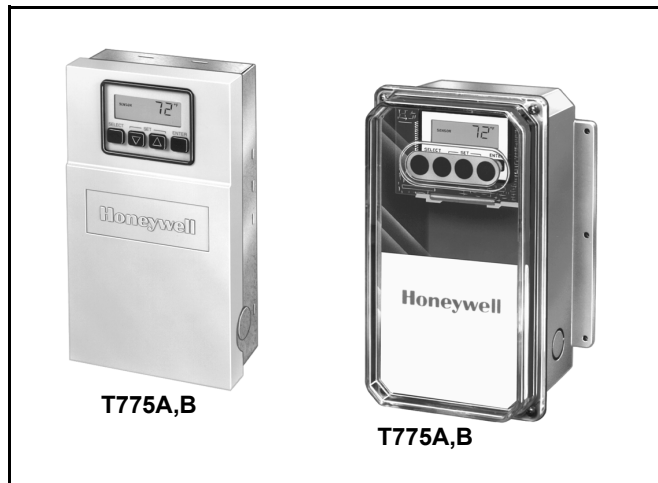

APPLICATION

The T775 family of Electronic Remote Temperature Controllers provide on-off temperature control for ducts, tanks, chillers, heating and refrigeration units, and other applications where electronic accuracy in addition to remote sensing is desired.

In addition, certain models of the T775 family of controllers provide on-off temperature control of heating, cooling, and ventilating systems in agricultural confinement buildings, storage areas and heavy industrial applications.

IMPORTANT

The T775 is an operating control, not a limit or safety control. If used in applications requiring safety or limit controls, a separate safety or limit control device should be used in conjunction with the T775.

FEATURES

- T775A models provide staged on-off control with one temperature input and one to four relay output stages.
- T775B models provide staged on-off control with two temperature inputs and two to four relay output stages.
- T775C models provide staged on-off control with one temperature input and four relay output stages.
- T775D models provide staged on-off control with two temperature inputs and four relay output stages.
- T775C,D models meet National Electrical Code (Article 547) requirements for animal confinement buildings.
- Setpoint temperature range is -40° to +220°F (-40° to +104°C).
- Ambient temperature range is -30° to +140°F for one and two stage models and -30° to +125°F for three and four stage models.
- Linear platinum temperature sensor with T775A,B.
- Water-tight linear platinum temperature sensor with T775C,D.
- Adjustable temperature range and differential.
- LCD indication for mode and output status.
- Keypad provides ease of programming and operation.
- Accuracy is within +/- 1°F (at nominal operating ambient temperature of 77°F and voltage input).
- Stage(s) independently programmed for heating or cooling.
- 24/120/240 Vac input voltage.
- Spdt relay outputs.

Contents

Application	1
Features	1
Specifications	2
Ordering Information	2
Installation	5
Wiring	6
Checkout	10



SPECIFICATIONS

IMPORTANT

Specifications given in this publication do not include normal manufacturing tolerances. Therefore, an individual unit may not exactly match the listed specifications. Also, this product is tested and calibrated under closely controlled conditions and some minor difference in performance can be expected if those conditions are changed.

Models (see Table 1):

The T775A,B Electronic Temperature Controllers provide staged on-off temperature control for ducts, tanks, chillers, heating and refrigeration units, and other applications where electronic accuracy and remote sensing are desired. The T775C,D Electronic Remote Temperature Controllers provide staged on-off temperature control of heating, cooling and ventilating systems in agricultural confinement buildings, storage areas, and heavy industrial applications.

Dimensions: See Fig. 1 and 2.

Mounting: Mounts on any suitable horizontal or vertical surface (see Fig. 3 and 4 for mounting hole locations).

Temperature Accuracy: +/-1°F (at nominal voltage in 77°F [25°C] ambient, nominal sensor value). Accuracy may vary based on deviation from nominal values of input voltage, operating ambient and sensor ambient.

Setpoint Adjustment Range: -40° to 220°F (-40° to 104°C).

Display Resolution: Sensed temperature and other operating parameters are displayed via a liquid crystal display (LCD) with a resolution of 1°F or 1°C.

Operating Ambient Temperature:
One and Two Stage units: -30° to 140°F.
Three and Four Stage units: -30° to 125°F.

Operating Humidity:
5% to 95% relative humidity (rh) noncondensing.

Sensor: Positive coefficient platinum type, 4.8 ohms/ °F, 1000 ft maximum distance between sensor and solid state controller (requires calibration over 400 ft). To maintain NEMA 4X rating, use environmental-proof cable and sensor.

Electrical Ratings:
Voltage Input: 24/120/240 Vac, 50/60 Hz (+10%/-15%).
Power Consumption:
For one and two stage units:
8 VA maximum at 60 Hz.
10 VA maximum at 50 Hz.
For three and four stage units:
13 VA maximum at 60 Hz.
20 VA maximum at 50 Hz.

Table 1. T775 Models.

Model	Inputs	Relay Outputs	Maximum Operating Ambient Temperature	Comments
T775A1001	1	1	140°F (60°C)	Includes one 193987GA Sensor.
T775A1019	1	2	140°F (60°C)	
T775A1027	1	3	125°F (52°C)	
T775A1035	1	4	125°F (52°C)	
T775B1000	2	2	140°F (60°C)	Includes two 193987GA Sensors.
T775B1018	2	3	125°F (52°C)	
T775B1026	2	4	125°F (52°C)	
T775C	1	4	125°F (52°C)	NEMA 4X enclosure. Includes one 203401B Remote Sensor.
T775D	2	4	125°F (52°C)	NEMA 4X enclosure. Includes two 203401B Remote Sensors.

ORDERING INFORMATION

When purchasing replacement and modernization products from your TRADELINE® wholesaler or distributor, refer to the TRADELINE® Catalog or price sheets for complete ordering number.

If you have additional questions, need further information, or would like to comment on our products or services, please write or phone:

1. Your local Honeywell Automation and Control Products Sales Office (check white pages of your phone directory).
2. Honeywell Customer Care
1885 Douglas Drive North
Minneapolis, Minnesota 55422-4386

In Canada—Honeywell Limited/Honeywell Limitée, 35 Dynamic Drive, Scarborough, Ontario M1V 4Z9.

International Sales and Service Offices in all principal cities of the world. Manufacturing in Australia, Canada, Finland, France, Germany, Japan, Mexico, Netherlands, Spain, Taiwan, United Kingdom, U.S.A.

Contact Ratings:

1/2 hp; 9.8 FLA, 58.8 LRA at 120 Vac.
 1/2 hp; 4.9 FLA, 29.4 LRA at 240 Vac.
 125 VA pilot duty at 120/240 Vac.
 10A at 24 Vac (resistive).

Approvals:

Underwriters Laboratories Inc. Listed: File no. E4436.
 Canadian Standards Assoc. certified: File no. LR47125.

Accessories:

T775A,B:

- A775A1003 Temperature Sensor Simulator.
- C7100C Duct Mount Averaging Sensor.
- 198212CA Water Resistant Sensor.
- 203401B Water Tight Sensor.
- T7047C1090 Wall Mounted Sensor Case.
- 107324A Bulb Holder, duct insertion.
- 121371A Copper Immersion Well.
- 121371E Stainless Steel Well.
- 107048 Heat Conduction Compound, 4 ounce.
- C7043A1098 Case and Immersion Well for running conduit to sensor.

T775C,D:

- 121371A Copper Immersion Well.
- 121371E Stainless Steel Well.
- 107048 Heat Conduction Compound, 4 ounce.
- C7043A1098 Case and Immersion Well for running conduit to sensor.

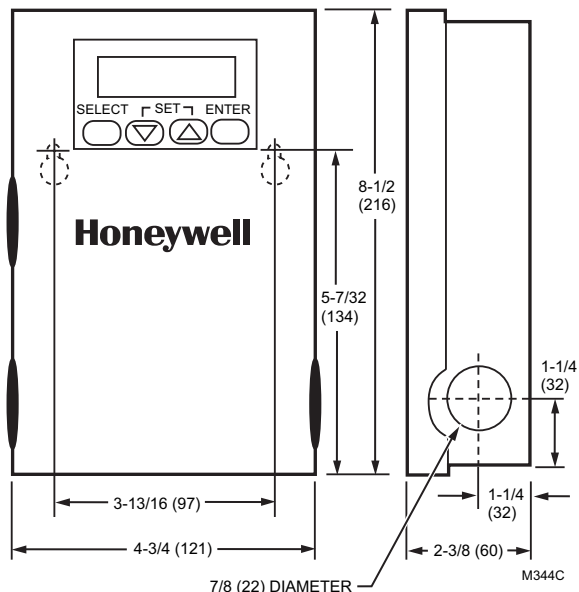

Fig. 1. Approximate dimensions of T775A,B in in. (mm).

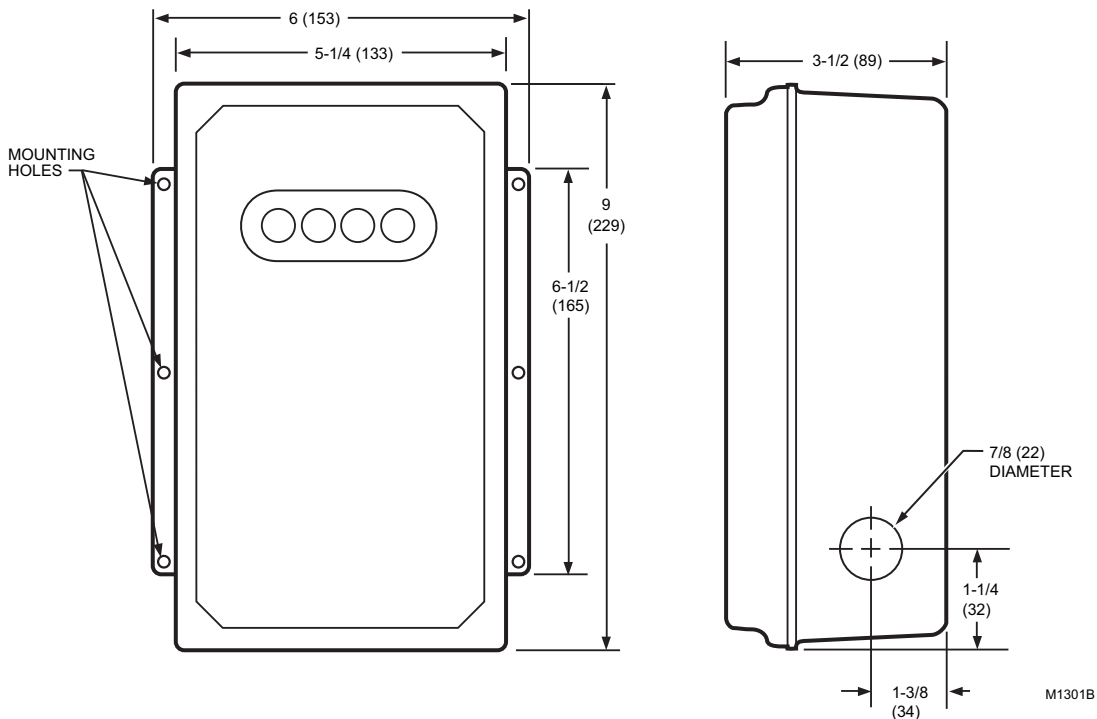

Fig. 2. Approximate dimensions of T775C,D in in. (mm)

T775A,B,C,D REMOTE TEMPERATURE CONTROLLER

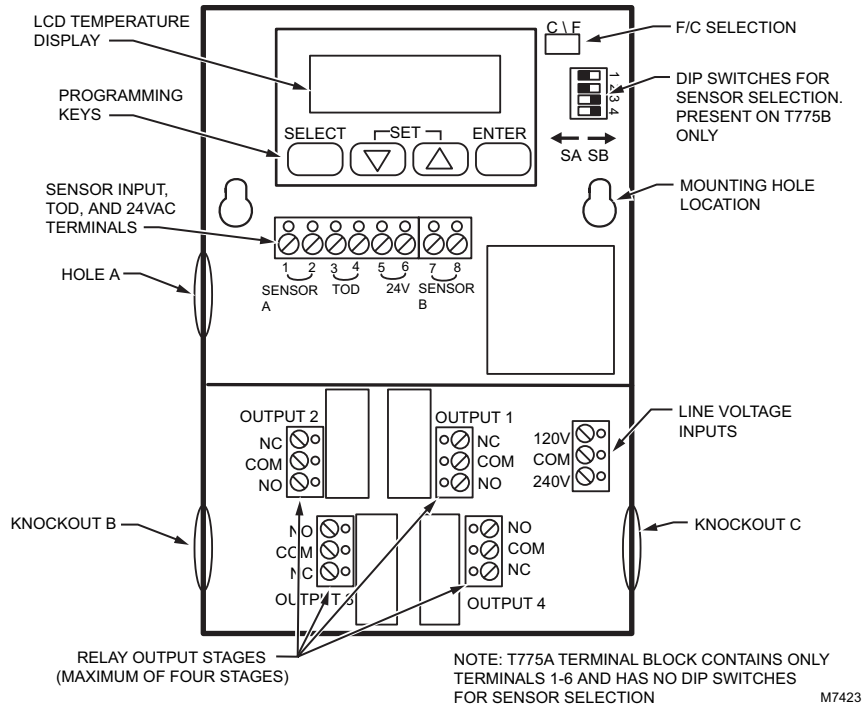

Fig. 3. Feature locations for T775A,B.

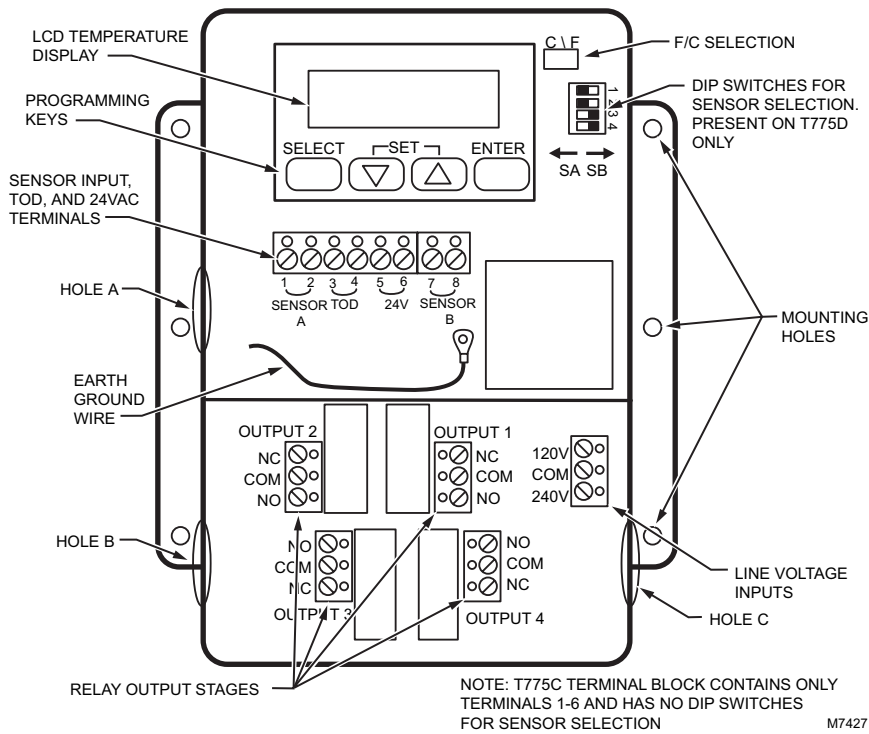

Fig. 4. Feature locations for T775C,D.

INSTALLATION

When Installing this Product...

1. Read these instructions carefully. Failure to follow them could damage the product or cause a hazardous condition.
2. Check ratings given in instructions and on the product to ensure the product is suitable for your application.
3. Installer must be a trained, experienced service technician.
4. After installation is complete, check out product operation as provided in these instructions.



CAUTION

Electrical Shock or Equipment Damage Hazard.
Can shock individuals or short equipment circuitry.

Disconnect power supply before installation.

Location and Mounting

Mount the controller on any convenient interior location using the two mounting holes provided on the back of the metal enclosure (mounting screws are not provided and must be obtained separately). Use controller dimensions in Fig. 1 (T775A,B) or Fig. 2 (T775C,D) as a guide.

Sensor Location

The 193987GA Sensor can be located up to 1000 feet (304m) from the T775 using standard AWG 18/2 unshielded wire. For cable runs greater than 25 feet shielded cable is recommended. See Fig. 5. It may be located on pipes, in an immersion well, in a wall-mounted case or on a bulb holder. See Fig. 7. The 193987GA is not a water tight or water resistant sensor. For wet applications, see the Accessories list in the Specifications section.

Multiple sensors can be parallel-series wired to sense average temperatures in large spaces.

To maintain control accuracy, the number of sensors parallel-series wired must be of the n2 power (for example, 4, 9, 16, etc.). See Fig. 8.

Sensor Mounting

Sensors can be mounted on a wall or panel for sensing space temperature (Fig. 7), strapped to a pipe or inserted in a well (Fig. 6) for hot/cold water sensing, or taped to a standard cap or bulb holder for duct air sensing. To prevent moisture or condensation entering the sensor through the leadwire holes, mount the sensor with the lead wires exiting the bottom of the sensor.

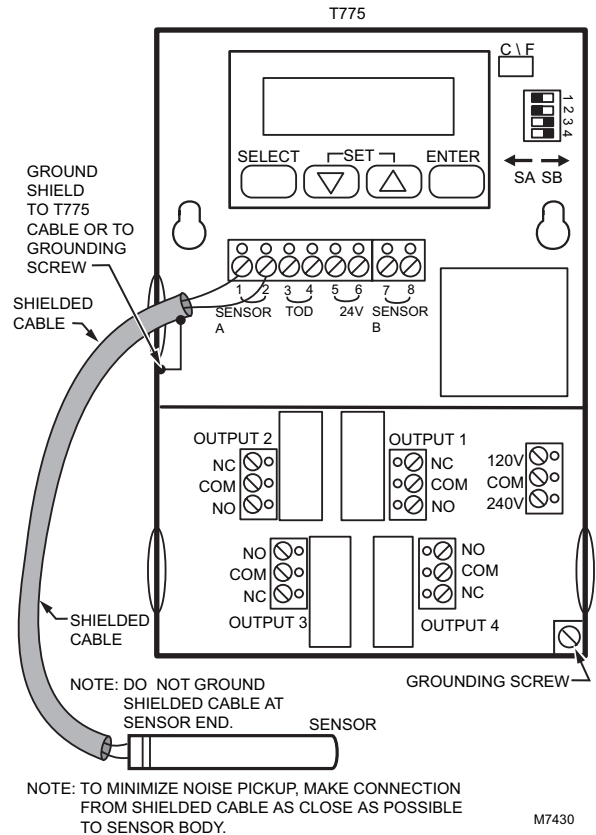

Fig. 5. Using shielded cable (cable runs longer than 25 ft).

NOTE: Use heat conductive compound in immersion wells. See Accessories in the Specifications section.



CAUTION

Electrical Shock Hazard.

Can short equipment circuitry.

Make sure that metal tube of sensor does not short against T terminals in wall-mounted case.

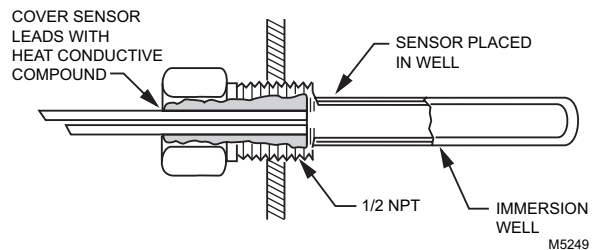

Fig. 6. Sensor inserted in immersion well.

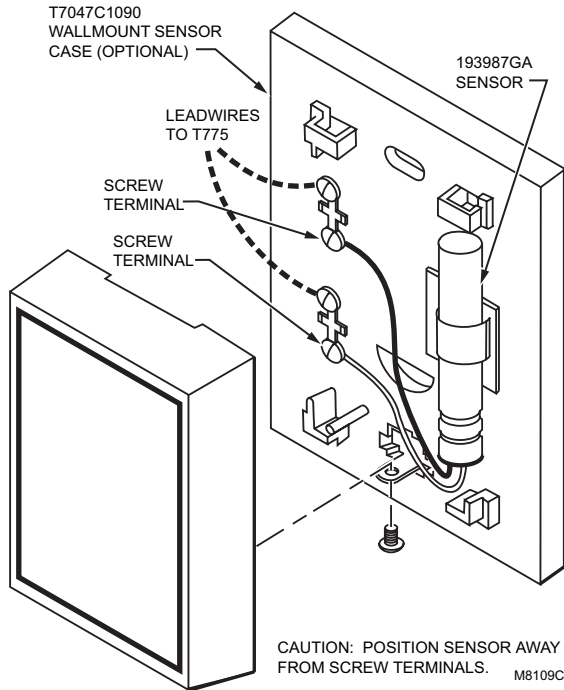

Fig. 7. Sensor mounted on wall.

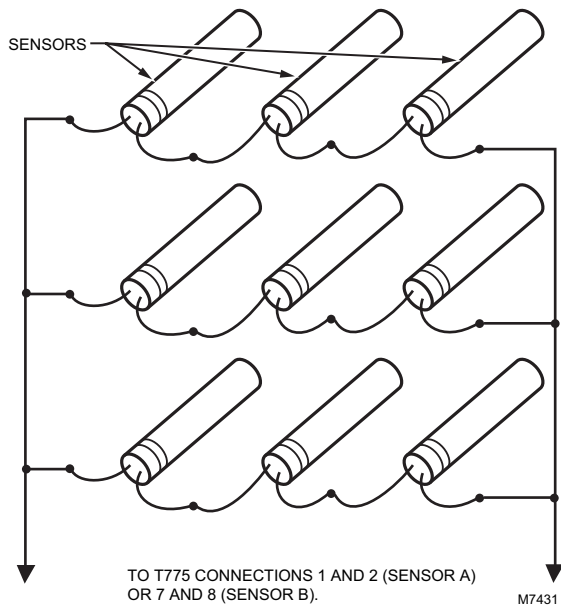

Fig. 8. Parallel-series wiring of sensors.

WIRING



CAUTION

Electrical Shock or Equipment Damage Hazard.
Can shock individuals or short equipment circuitry.

Disconnect power supply before installation.



CAUTION

Do not use 24 Vac power at terminals 5 and 6 to power any external loads if 120 Vac or 240 Vac is used to power the T775.

IMPORTANT

The T775 is an operating control, not a limit or safety control. If used in applications requiring safety or limit controls, use a separate safety or limit control device in conjunction with the T775.

Refer to Fig. 3 or 4 for locating the appropriate power inputs, remote sensor input, load output terminals, contact closure input and sensor selection switch. Access to the terminals can be gained through standard conduit knockouts (A through C) located around the perimeter of the enclosure.

NOTE: Hole A should only be used for sensor, low-voltage and contact closure wiring.

When wiring the input power, only one source of power can be applied to the T775 (for example, 24 Vac or 120 Vac or 240 Vac). Knockouts B and C can be used to gain access to 120 Vac or 240 Vac input terminals and the load relay output terminals.

See Fig. 11 through 14 for typical T775 wiring and applications.

IMPORTANT

Poor wiring practices can cause erratic temperature readings from the 193987GA Sensor. Avoid the following to ensure proper operation:

- Do not route the temperature sensor wiring with building power wiring.
- Do not locate the temperature sensor wiring next to control contactors.
- Do not locate the temperature sensor wiring near electrical motors.
- Do not locate the temperature sensor wiring near welding equipment.
- Make sure good mechanical connections are made to both the sensor and the controller.
- Do not mount the sensor with the leadwire end (wire end) pointing up in an area where condensation can occur.

If any of the above conditions cannot be avoided, use shielded cable.

NOTE: Ground the cable shield at the T775 connection only, not at the sensor connection (see Fig. 5).

OPERATION

Control Algorithm

On/Off Control

The T775AC operate with one temperature input supplied by the remote sensor while T775B,D have two temperature inputs. The T775A,B,C,D are all capable of providing up to four stages of on/off control relay outputs. Each controller stage has its own independent setpoint that can be configured to operate in either the heating or cooling mode. The mode of operation for each stage is user-determined by programming keys.

Heating Mode Operation

- Relay outputs energize at the temperature setpoint *minus* the differential value.
- Relay outputs de-energize at the temperature setpoint value.

Cooling Mode Operation

- Relay outputs energize at the temperature setpoint *plus* differential value.
- Relay outputs de-energize at the temperature setpoint value.

EXAMPLE

Using a device with one input and one relay output, the corresponding load energizes at the following temperatures based on the initial settings:

- Setpoint: 68°F
- Differential: 2°F

Outputs Energized

Heating Mode: Stage One energizes at 66°F.

Cooling Mode: Stage One energizes at 70°F.

The T775B,D have dual sensor inputs and allow two separate controllers to exist within one enclosure. Selection of the stage parameters (operation mode, setpoints, and differentials) is the same as for a single sensor device after each stage is assigned its operating sensor. This assignment is hardware driven via a four position DIP switch. An explanation of the DIP switch assignments appears in Fig. 9. See Fig. 3 and 4 for the DIP switch location.

Contact Closure Override Input

The two-terminal input allows the user to override a relay-energized condition on all outputs. This is done using contact closure between terminal pins 3 and 4 (TOD). (See Fig. 3 and 4 for location.) This can be achieved manually or by using an EMS controller or time clock with normally open contacts (W7505 or S7005, for example).

When this override is active:

- The display shows the number of stages that would be energized
- The words STAGE ENERGIZED flash on the display.
- Energized stages de-energize until the override returns to inactive (Off).

°F/°C Selection

A single jumper plug controls °F/°C indication of the displayed temperature value. See Fig. 3 and 4 for the location of this jumper. The unit ships with the jumper installed in the °F mode. To operate the device in the °C mode, remove the jumper. Replacing the jumper reinstates the °F mode.

NOTES: If, upon removing the jumper plug, the device does not display °C:

- Remove power from the device.
- Replace power to the device.

DIP Switch Selections

On the T775B,D, DIP switches are provided for assignment of each relay output stage to its operating sensor. If an individual switch is depressed to the right—toward its corresponding load number (1 through 4 on DIP switch)—Sensor B is the controlling sensor for that output stage. If an individual switch is depressed to the left, Sensor A is the controlling sensor for the output stage. An example of the switches and their corresponding positioning is shown in Fig. 9.

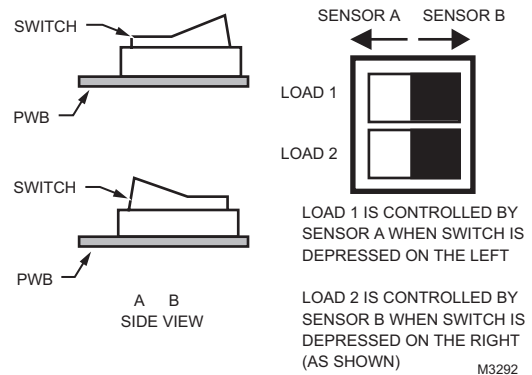

Fig. 9. DIP switch settings for sensor selection.

Device Setup

1. Determine loads to be controlled and the operating mode (heat or cool) and enter them in the Device Programming Worksheet (Table 2).

Table 2. Device Programming Worksheet.

Load 1:	
SetPt 1 _____	On at _____
Diff 1 _____	Off at _____
Load 2:	
SetPt 2 _____	On at _____
Diff 2 _____	Off at _____
Load 3:	
SetPt 3 _____	On at _____
Diff 3 _____	Off at _____
Load 4:	
SetPt 4 _____	On at _____
Diff 4 _____	Off at _____

For example: Load 1: Compressor 1 (cool)

Setpt 1	_____	On at	_____
Diff 1	_____	Off at	_____

- For two sensor models (T775B), determine which loads will be controlled from sensor A or sensor B and enter on the worksheet.

For example: Load 1: Compressor 1 (cool)—Sensor A

Setpt 1	_____	On at	_____
Diff 1	_____	Off at	_____

- Determine setpoint (Setpt) and switching differential (Diff) for each load and enter on the worksheet.

For example: Load 1: Compressor 1 (cool)—Sensor A

Setpt 1	78°F	On at	_____
Diff 1	4°F	Off at	_____

- Refer to the Control Algorithm subsection of Operation section to calculate the load on and off temperatures. Enter them on the worksheet.

NOTE: Remember that the on/off outputs are off at setpoint in both heating and cooling operating modes. When in cooling mode, the load turns off at setpoint plus the differential. When in heating mode, the load turns on at setpoint minus the differential.

For example: Load 1: Compressor 1 (cool)—Sensor A

Setpt 1	78°F	On at	82°F
Diff 1	4°F	Off at	78°F

 **CAUTION**

The T775 will not allow the user to program for both heating and cooling loads to be energized at the same time.

If this situation results, cooling loads will be energized and heating loads will be prevented from energizing. The number (1,2,3,4) of these nonenergized loads will flash along with the word HEAT to indicate a call for both heating and cooling loads controlled by one sensor has occurred and to alert the user to reprogram the affected control values.

- Remove the T775 cover and enter the values listed on the worksheet and the date in the first column on the label inside the T775 cover.

Keypad Programming and Display

The T775 utilizes a Liquid Crystal Display (LCD) for interactive prompting during programming and display of sensed and assigned setpoint and differential values. User programming of the T775 is accomplished through the four programming keys.

Programming Keys

The four programming keys are Select, Up and Down (arrows), and Enter:

- Select: Sequentially prompts the user about what parameter is being displayed. After the last parameter value is viewed, pressing the Select key again displays the control values from the beginning of the display loop. The parameters are:
 - setpoint,
 - differential,
 - stage energized,
 - heat or cool (operation mode),
 - 1,2,3,4 (indicating assigned stage).
- Up and Down: Allow the displayed parameter to be increased or decreased. After pressing Select, a control value can be changed using these keys. Control values increase or decrease by 1°F or 1°C each time an arrow key is pressed.
- Enter: Places the new value in the microprocessor memory.

IMPORTANT

Control values/operations are not placed in the micro-processor memory until the Enter key is pressed.

Press the Select and Enter keys at the same time to change the control algorithm from heating to cooling or from cooling to heating:

- Heating and cooling parameters are not displayed during normal Select key sequences.
- The only parameters displayed after pressing the Select and Enter keys at the same time are the stage indication, and the word heat or cool.
- To change the operation from heating to cooling (or vice versa) for a desired output stage, use the arrow keys.
- The next stage of heat or cool assignment appears after pressing the Select key. When all stages are programmed, the display reverts to sensed temperature and load energized status.

NOTE: Control values and operation selection remain in the device memory even after the power is removed.

Display

Once power is applied or restored to the device, the display counts down from 210 until the display reads zero. During this time all previously energized outputs de-energize. This is intended to protect compressors in the event of a power failure.

NOTE: To avoid viewing the entire countdown, press the Select key.

The LCD display now shows what it normally reads:

- load (sensed) temperature,
- stages energized,
- and, for two sensor devices, the sensor (Sensor A or Sensor B) being read.

NOTE: At any time during programming, a 60 second pause between key presses reverts the display to indicate the sensed temperature and stage status.

For two sensor applications, the user has three options for display of sensed temperature. The display can be configured to:

- lock onto continuous Sensor A,
- lock onto continuous Sensor B sensed temperature,
- alternate between Sensor A and Sensor B (at approximate five-second intervals).

This selection is accomplished in the Select screen scrolling loop:

1. To lock on to either sensor, use the Select key to scroll through the loop to the temperature prompt of interest.
2. Stop at Sensor A or Sensor B sensed temperature point.
3. When the loop is stopped at any other prompt, the display alternates between Sensor A and Sensor B sensed temperatures.

NOTE: Pressing the Select key at the end of the programming sequence configures the display for alternating temperature display.

Device Programming

Default Values

When power is initially applied to the T775, the control points will be at their default value set at the factory. See Table 3 for default values.

Table 3. Default Programming Values.

	Setpoint (°F)	Differential (°F)	Operating Mode
Stage 1	72	2	Heat
Stage 2	70	2	Heat
Stage 3	68	2	Heat
Stage 4	66	2	Heat

1. For the T775B and D, assign the loads to the appropriate sensor by setting the DIP switch in the upper right corner of the T775 (see DIP Switch Selection, Fig. 9).
2. Before programming the T775, verify that the °F/°C selection jumper is properly installed. The T775 ships from the factory with the jumper in the °F position. If °C is desired, remove the jumper.
3. Apply power to the device. The device begins counting down from 210. This countdown sequence lasts for approximately 3-1/2 minutes.

NOTE: If, upon removing the jumper plug, the device does not display °C:
 (a) Remove power from the device.
 (b) Replace power to the device.

4. Press Select to override the time delay.
5. Press Select and Enter keys simultaneously to begin programming the load operating mode (Heat or Cool).
6. Press the Set (down arrow) to change to cooling. The Set (up arrow) changes back to heating.
7. Press Enter to program mode displayed into memory.

8. Press Select to go to the next stage.
9. Repeat steps 6 through 9 for additional stages.
10. Press Select after setting the last stage to return to the display of the sensed temperature.

Programming Stage Control Values

1. Press Select to display the current stage setpoint.
2. Press Set (up arrow) to increase or Set (down arrow) to decrease to the desired setpoint.
3. Press Enter to place the displayed value into memory.
4. Press Select to display the current stage switching differential.
5. Press Set (up arrow) to increase or Set (down arrow) to decrease the switching differential.
6. Press Enter to place the displayed value into memory.
7. Repeat steps 1 through 6 to program an additional stage.
8. To return to stage 1 parameters:
 - a. T775A,C: Press Select two times.
 - b. T775B,D: Press Select four times
9. Scroll through the programming loop a second time to confirm that the appropriate values were entered into memory by pressing Select.
10. For the T775A,C, skip to step 12.

NOTE: The T775B and D have three display options for the sensed temperature:

- (1) Sensor A only.
- (2) Sensor B only.
- (3) Alternating between Sensor A and Sensor B (at approximately five-second intervals).

11. To change the T775B,D display option:
 - a. Sensor A only: Press Select after viewing the final stage switching differential.
 - b. Sensor B only: Press Select a second time.
 - c. Alternate between A and B: Press Select a third time.
12. Before replacing the cover on the T775, check to see that the control values were recorded on the label on the backside of the cover.

IMPORTANT

1. For the T775A and C only: After initial programming, altering the setpoints for stage 1 up or down results in a change in setpoints 2, 3, and 4 by the same number of degrees and in the same direction.
2. The control rejects any change to the stage 1 setpoint if it results in exceeding control limits (-40° to +220°F [-40° to +104°C]) for subsequent stages. This allows easy sequential output staging modifications while keeping the margin intact between setpoints.

CHECKOUT

Error Messages

There are seven error messages that can display in response to T775 software or hardware problems. The error Codes that can flash on the display are:

- SF: Sensor Failure
 - A flashing SF indicates an out-of-range or defective sensor. Make sure that the sensors are connected properly. For T775A,C all loads de-energize when this error message flashes.
 - For the T775B,D the loads controlled by the out-of-range sensor de-energize. The display flashes SF to indicate which sensor is defective or in error. In the event that only one sensor is defective, the remaining sensor and its load(s) operate normally. Only the load(s) controlled by the defective, out-of-range, or unconnected sensor de-energize.
- NOTE: Sensor values below -40°F or above 220°F are out-of-range.
- EF: EEPROM Failure
 - The values read back from the EEPROM are not the same as written into the EEPROM. This error cannot be field repaired. Replace the device. The EEPROM is not intended to be field repaired.
- CF: Calibration Failure
 - A calibration resistor reading was not within the range of the Analog to Digital converter. This error cannot be field repaired. Replace the device.
- OF: Stray Interrupt Failure
 - An unused interrupt occurred. This error cannot be field repaired. Replace the device.
- CE: Configuration Error
 - The device hardware was configured to a nonexistent device. This error cannot be field repaired. Replace the device.
- OE: ROM Error
 - The internal Read Only Memory (ROM) of the microprocessor is defective. This error cannot be field repaired. Replace the device.
- AE: RAM error
 - The internal Random Access Memory (RAM) of the microprocessor is defective. This error cannot be field repaired. Replace the device.

Setpoint Calibration

To maintain temperature accuracy, use 18 AWG two-conductor sensor wires. If the length of the sensor wire exceeds 400 feet, recalibration will be necessary to maintain accuracy. Table 4 shows the corresponding temperature offset to use for different

sensor wire lengths. This temperature offset should be added to the desired temperature setpoint for these applications. Refer to programming instructions in the Programming section for entering temperature setpoints.

Table 4. Temperature Offset Based on Wire Length.

Sensor Wire Length	Calibration Offset
0 to 399 ft	None required.
400 to 599 ft	1.0 degrees
600 to 799 ft	2.0 degrees
800 to 1000 ft	3.0 degrees

After the controller is installed and wired, apply power. Make initial adjustments and desired settings:

1. As shown in Fig. 10, record the sensed temperatures for both Sensor A and Sensor B as displayed on the device. Use the Select key to advance through the programming loop to determine and then write, on the Checkout Table (Fig. 10), the loads controlled by each sensor.
2. Write the operating mode (heat or cool) for each stage in the Checkout Table (Fig. 10).
3. Write the sensed temperature for each load on the Sensed Temp line.
4. Write the differential for each load on the Differential line.
5. Write the setpoint for each stage (Off temperature). Calculate the "On Temperature" for each stage.

NOTE: "On temperature" is setpoint plus differential for cooling, and it is setpoint minus differential for heating.

6. Plot the on and off (open/closed) values at which the device will energize and de-energize each output load, (Refer to the Device Programming Worksheet.)
7. Verify which loads are energized by using the Checkout Table (Fig. 10). As shown in the example, the display indicates, in the lower right corner, energized stages. If no stages are energized, the words "stage energized" will not appear.

NOTE: If the sensed temperature is between the On and Off temperatures, the load may either be energized or de-energized. Refer to the Control Algorithm section (in Operation) for further explanation.

8. If an error message flashes, refer to the description of these messages. If SF flashes:
 - a. Check sensor connections.
 - b. If properly connected and SF continues to flash, check the sensor location to make sure it is located in an ambient condition that is within the sensor capability (-40° to $+220^{\circ}\text{F}$).
9. If an error message other than SF flashes, the device cannot be field repaired. Replace the device.

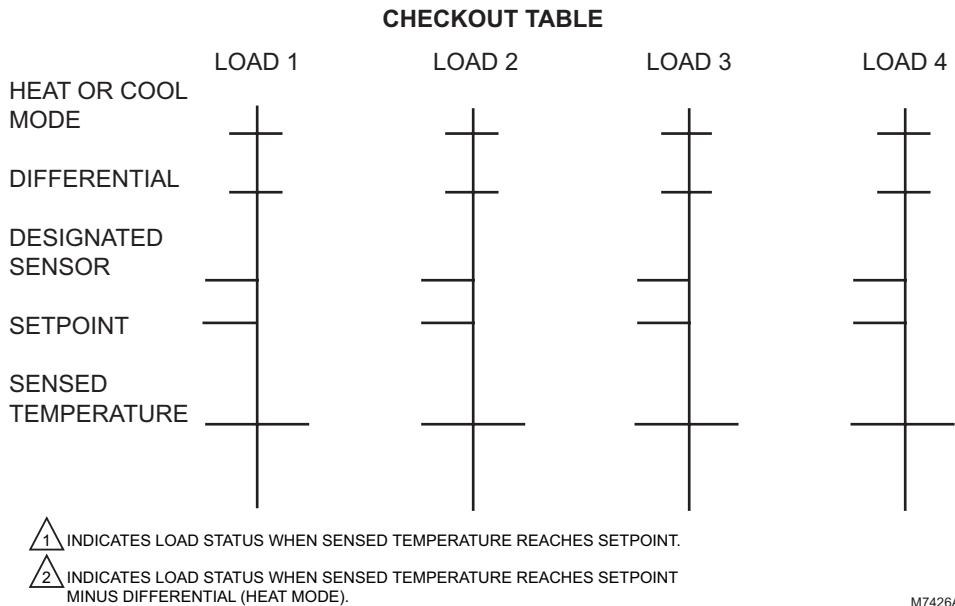
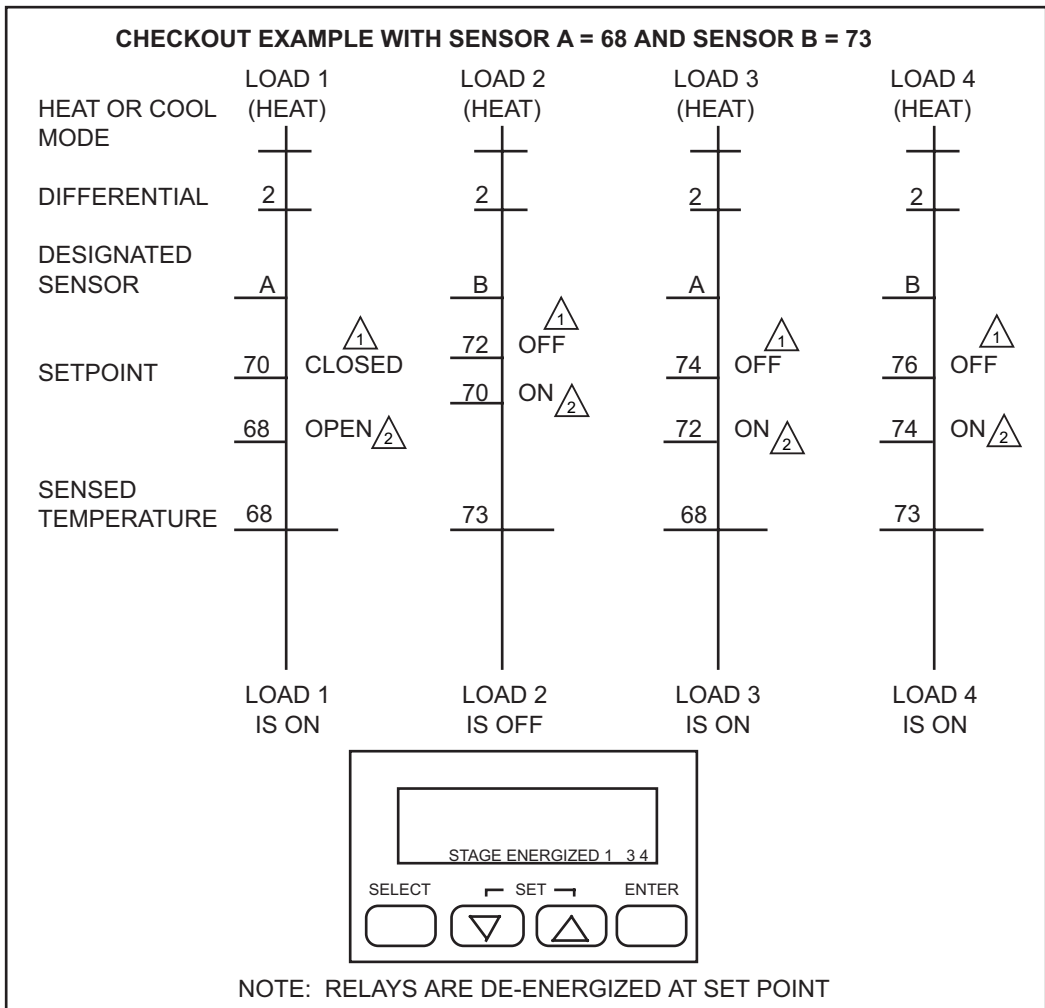
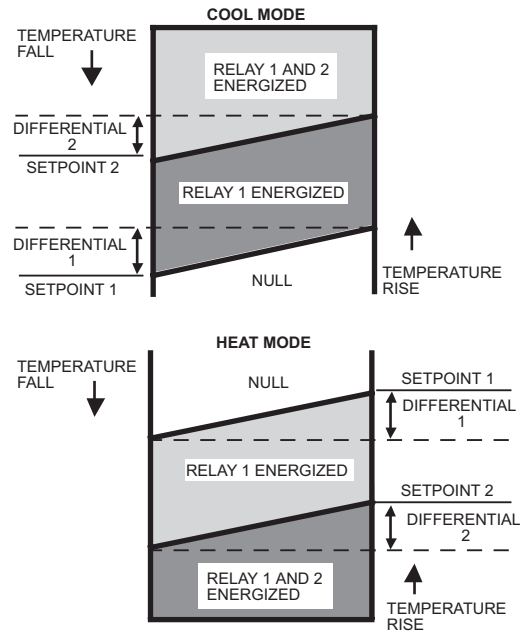
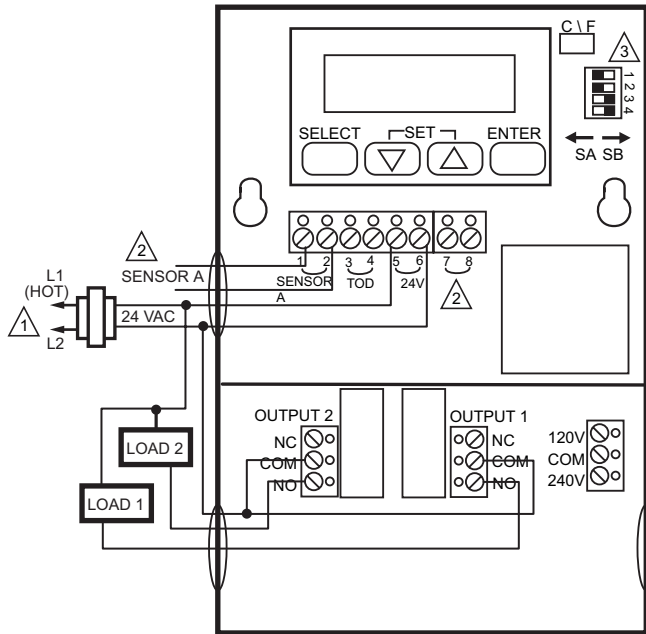

Fig. 10. Checkout Table and checkout example with Sensor A = 68°F and Sensor B = 73°F.

T775A,B,C,D REMOTE TEMPERATURE CONTROLLER



① POWER SUPPLY. PROVIDE DISCONNECT MEANS AND OVERLOAD PROTECTION AS REQUIRED.

② FOR T775B,D: CONNECT SENSOR B TO PINS 7 AND 8.

③ DIP SWITCHES FOR SENSOR SELECTION. PRESENT OF T775B,D ONLY.

M7421A

Fig. 11. Two-stage control, 24 Vac input, 24 Vac load.

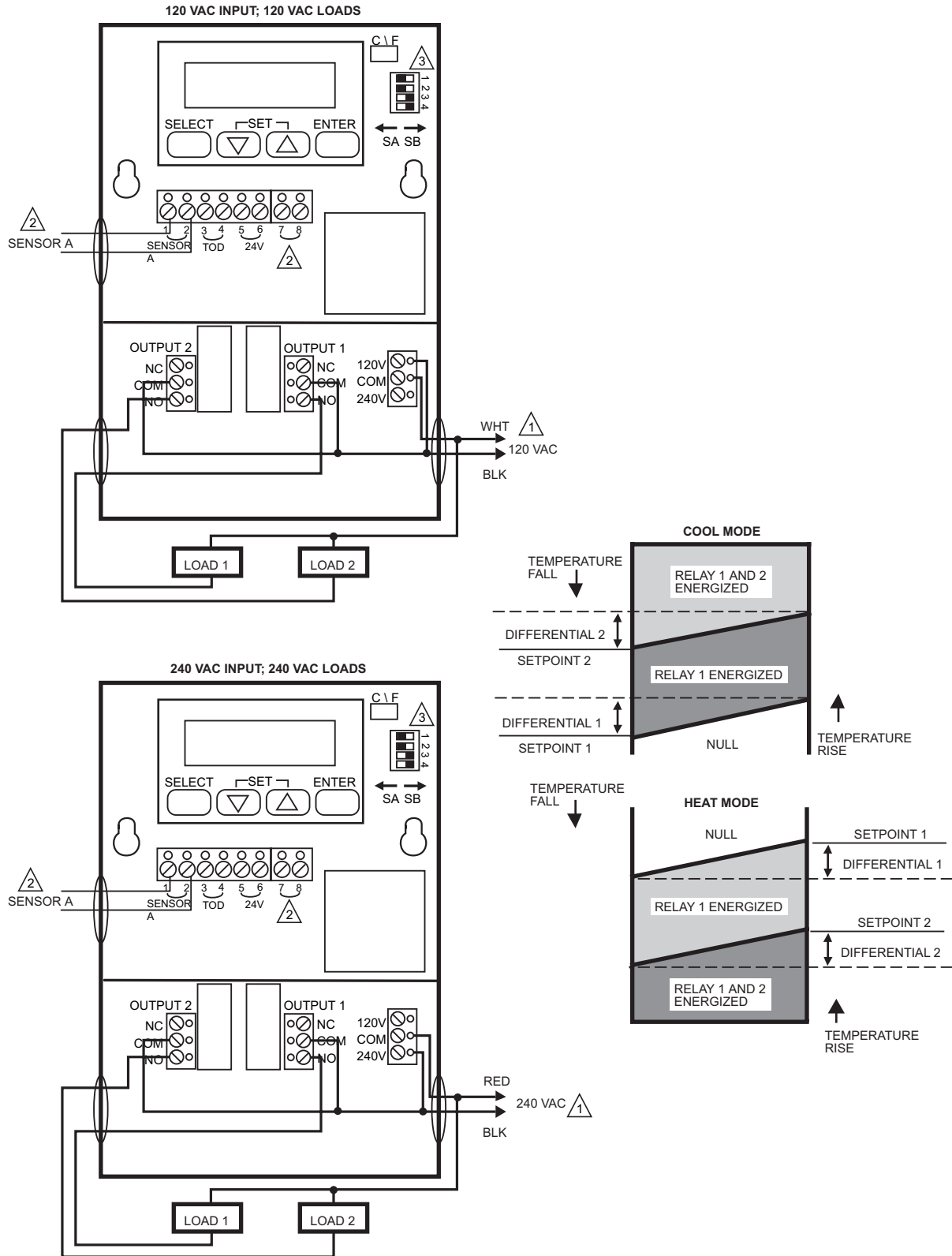

- ① POWER SUPPLY. PROVIDE DISCONNECT MEANS AND OVERLOAD PROTECTION AS REQUIRED.
- ② FOR T775B,D: CONNECT SENSOR B TO PINS 7 AND 8.
- ③ DIP SWITCHES FOR SENSOR SELECTION. PRESENT OF T775B,D ONLY.

M7422A

Fig. 12. Two-stage control, 120 or 240 Vac input; 120 or 240 Vac load.

T775A,B,C,D REMOTE TEMPERATURE CONTROLLER

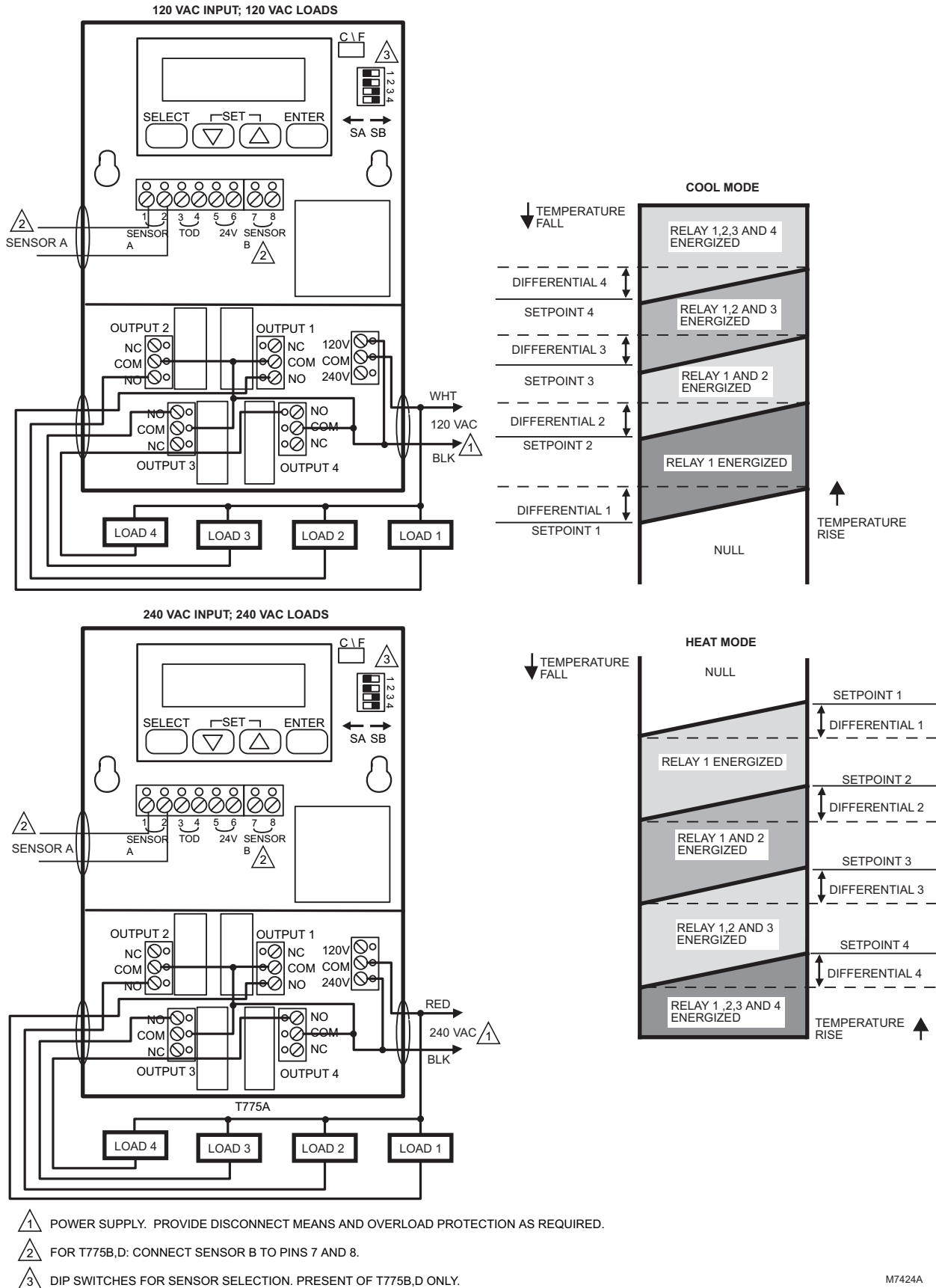
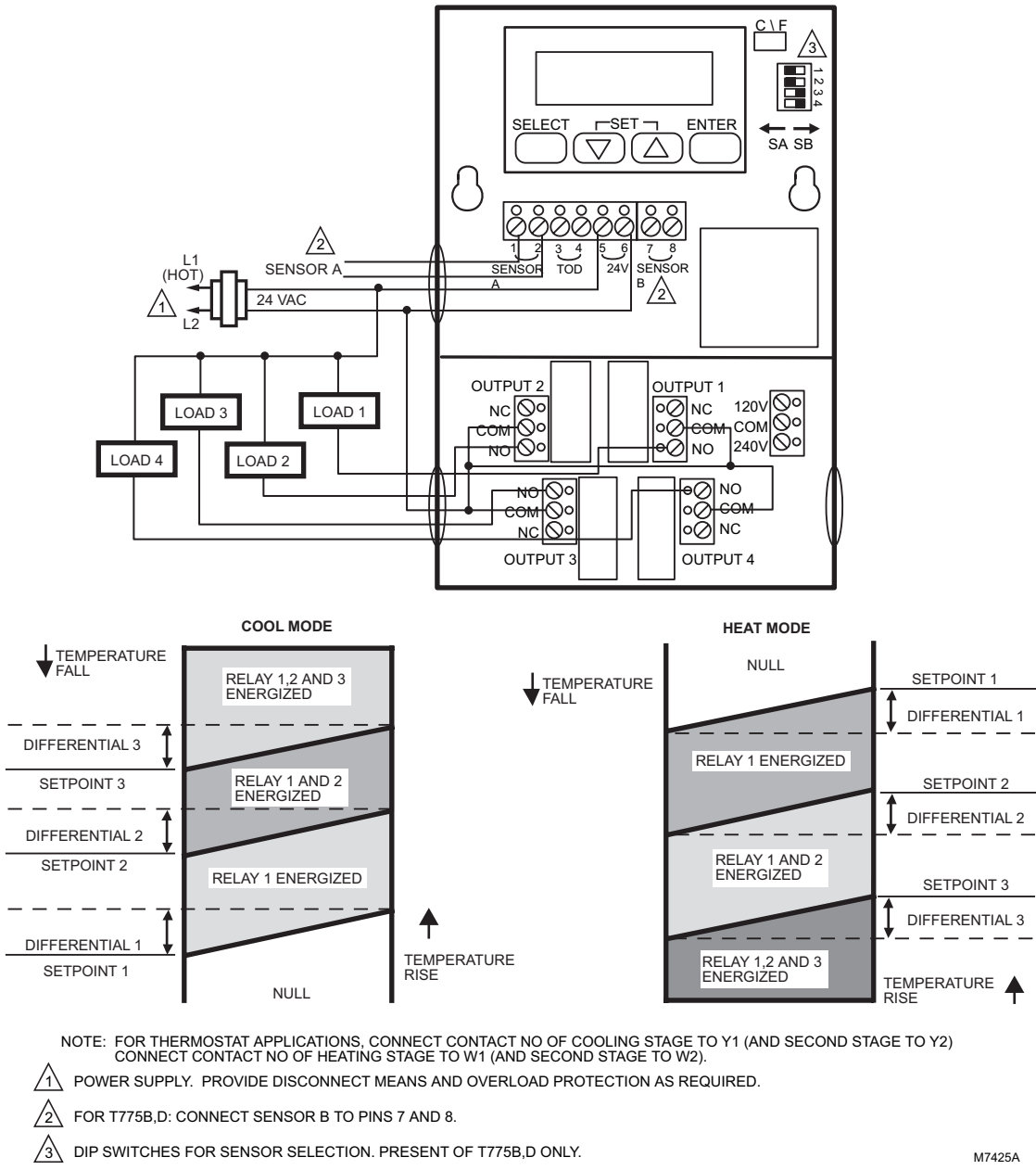

Fig. 13. Four stage control, 120 or 240 Vac input, 120 or 240 Vac load.



M7425A

Fig. 14. Four-stage control, 24 Vac input; 24 Vac load.

Automation and Control Solutions

Honeywell International Inc.
1985 Douglas Drive North
Golden Valley, MN 55422
customer.honeywell.com

Honeywell Limited-Honeywell Limitée
35 Dynamic Drive
Scarborough, Ontario M1V 4Z9

® U.S. Registered Trademark
© 2005 Honeywell International Inc.
63-2489—2 B.B. Rev. 07-05



Printed in U.S.A. on recycled
paper containing at least 10%
post-consumer paper fibers.

Honeywell