

Honeywell

HRSD8, HRSD16

**8-, 16-Channel Models
Color Digital Video Recorder**

User Guide

Revisions

Issue	Date	Revisions
Rev A	11/07	New Document
Rev B	11/07	Minor text changes
Rev C	11/07	More text changes; added clause about DVR channels on cover page; added RoHS logo
Rev D	12/07	Changes to Appendix C: ClipPlayer
Rev E	12/07	Added CE Compliance section to the front matter (p.3)
Rev F	02/08	Added a Caution to "Connecting the Power Cord" section of the Installation chapter.

FCC Compliance Statement

INFORMATION TO THE USER: This equipment has been tested and found to comply with the limits for a Class A digital device, pursuant to part 15 of the FCC rules. These limits are designed to provide reasonable protection against harmful interference when the equipment is operated in a commercial environment. This equipment generates, uses, and can radiate radio frequency energy and, if not installed and used in accordance with the instruction manual, may cause harmful interference to radio communications. Operation of this equipment in a residential area is likely to cause harmful interference in which case the user will be required to correct the interference at his own expense.

CAUTION: Changes or modifications not expressly approved by the party responsible for compliance could void the user's authority to operate the equipment.

This Class A digital apparatus complies with Canadian ICES-003.

Cet appareil numérique de la Classe A est conforme à la norme NMB-003 du Canada.

CE Compliance

This equipment has been tested in accordance with the following directives:

- 2006/95/EC The Low Voltage Directive
- 2004/108/EC The Electromagnetic Compatibility Directive

WARNING: This is a Class A product. In a domestic environment this product may cause radio interference in which case the user may be required to take adequate measures.



Explanation of Graphical Symbols



This symbol alerts the user to the presence of uninsulated "dangerous voltage" within the product's enclosure that may be of sufficient magnitude to constitute a risk of electric shock.



This symbol alerts the user to the presence of important operating and maintenance (servicing) instructions in the literature accompanying the appliance.

	WARNING RISK OF ELECTRIC SHOCK DO NOT OPEN	
WARNING: TO REDUCE THE RISK OF ELECTRIC SHOCK, DO NOT REMOVE COVER (OR BACK). NO USER-SERVICEABLE PARTS INSIDE. REFER SERVICING TO QUALIFIED SERVICE PERSONNEL.		

WEEE Compliance

WEEE (Waste Electrical and Electronic Equipment)

Correct Disposal of this Product (Applicable in the European Union and other European countries with separate collection systems)



This marking shown on the product or its literature, indicates that it should not be disposed with other household wastes at the end of its working life. To prevent possible harm to the environment or human health from uncontrolled waste disposal, please separate this from other types of wastes and recycle it responsibly to promote the sustainable reuse of material resources.

Household users should contact either the retailer where they purchased this product, or their local government office, for details of where and how they can take this item for environmentally safe recycling.

Business users should contact their supplier and check the terms and conditions of the purchase contract. This product should not be mixed with other commercial wastes for disposal.

RoHS



Contents

Figures	7
Tables	11
About This Document	13
Overview of Contents	13
About Cautions and Warnings	14
Important Safeguards	14
Typographical Conventions	18
1 Introduction	19
Features	19
Technical Overview	20
2 Installation	23
Package Contents	23
Required Installation Tools	23
Connecting the Video Source	24
Connecting the Loop Through Video	24
Connecting Audio	25
Connecting the Monitor	25
Connecting the DVR for Remote Access	26
Connecting Alarm Inputs and Outputs	27
Connecting USB Ports	28
Factory Reset	28
Connecting the Power Cord	29
3 Configuration	31
Front Panel Controls	31
Turning on the Power	34
Initial Unit Setup	34
Logging In	35
Setup Screen	35
Network & Notification Setup	50
Configuring Devices	61
Recording Settings	71
Event Settings	76
4 Operation	103
Turning on the Power	104
Live Monitoring	104
Using PIP Mode	105

Contents

- Active Cameo Mode 105
- Freeze Mode 106
- Zoom Mode 106
- Adjusting the Image 106
- Browsing with Sequence Mode 107
- Using a Mouse During Live Monitoring. 108
- Event Monitoring 110
- Covert Camera Settings 110
- Spot Monitoring. 111
- PTZ Mode. 112
- Recording. 115
 - Recording Video 115
 - Recording Audio 116
- Playing Recorded Video 116
 - Searching Video 118
- Appendix A USB Hard Disk Drive Preparation 133**
 - Preparing the USB-IDE hard disk drive in Windows 2000 133
 - Preparing the USB-IDE hard disk drive in Windows 98 134
- Appendix B Text-In Query Examples 135**
 - Query Example I 135
 - Query Example II 136
- Appendix C Reviewing Video Clips 137**
- Appendix D Time Overlap 141**
- Appendix E Troubleshooting 143**
- Appendix F Connector Pinouts 145**
- Appendix G Map of Screens. 147**
- Appendix H System Log Notices 149**
- Appendix I Error Code Notices. 151**
- Appendix J Specifications 153**
- Index. 155**

Figures

Figure 1-1	Typical DVR Installation for the HRSD8/16 DVR	21
Figure 2-1	16-Channel DVR Rear Panel	23
Figure 2-2	Video Input Connectors	24
Figure 2-3	Video Loop Through Connectors	24
Figure 2-4	Audio Connectors	25
Figure 2-5	VGA Connector	25
Figure 2-6	Video Out Connector	26
Figure 2-7	RS-232C Port	26
Figure 2-8	Network Port	26
Figure 2-9	RS485 Port	27
Figure 2-10	Alarm Connector Strip	27
Figure 2-11	USB Ports	28
Figure 2-12	Factory Reset Switch	28
Figure 2-13	Power Cord Connector	29
Figure 3-1	16-Channel DVR Front Panel	31
Figure 3-2	Login Screen	35
Figure 3-3	Setup Screen	35
Figure 3-4	Virtual Keyboard	36
Figure 3-5	Information Screen	37
Figure 3-6	Upgrade Screen	37
Figure 3-7	Setup Import Screen	38
Figure 3-8	Setup Export Screen	39
Figure 3-9	System Log Screen	39
Figure 3-10	Date/Time Setup Screen	40
Figure 3-11	Holiday Setup Screen	41
Figure 3-12	Time Sync. Screen	42
Figure 3-13	Storage Information Screen	43
Figure 3-14	Device Format Screen	43
Figure 3-15	Device Information Screen	44
Figure 3-16	Storage Status Screen	45
Figure 3-17	User Setup Screen	46
Figure 3-18	New Group Setup Screen	48

Figures

Figure 3-19	New User Setup Screen	49
Figure 3-20	Shutdown Screen	50
Figure 3-21	Logout Screen	50
Figure 3-22	Network Menu	50
Figure 3-23	Network Setup Screen.	51
Figure 3-24	LAN (Manual) Setup Screen	52
Figure 3-25	Port Numbers Setup Screen.	53
Figure 3-26	LAN (DHCP) Setup Screen	54
Figure 3-27	LAN (ADSL) Setup Screen.	54
Figure 3-28	Modem Setup Screen	55
Figure 3-29	DVRNS Setup Screen	56
Figure 3-30	Notification Mail Setup Screen.	58
Figure 3-31	Notification Callback Setup Screen	60
Figure 3-32	Devices Menu	61
Figure 3-33	Camera Setup Screen	61
Figure 3-34	Camera PTZ Setup Screen	62
Figure 3-35	PTZ Device List	63
Figure 3-36	Port Setup Window	63
Figure 3-37	Audio Setup Screen	64
Figure 3-38	Alarm-Out Settings Screen	65
Figure 3-39	Alarm-Out Schedule Screen	66
Figure 3-40	Display OSD Screen	67
Figure 3-41	OSD Margin Screen	68
Figure 3-42	Main Monitor Screen.	68
Figure 3-43	Spot Monitor Screen.	70
Figure 3-44	Remote Control Setup Screen.	70
Figure 3-45	Record Menu.	71
Figure 3-46	Record Setup Screen	71
Figure 3-47	Schedule Setup Screen	73
Figure 3-48	Default Setup Screen	74
Figure 3-49	Pre-Event Setup Screen	75
Figure 3-50	Event Menu	76
Figure 3-51	Alarm-In Settings Screen	76
Figure 3-52	Alarm-In Actions 1 Setup Screen	78
Figure 3-53	Alarm-In Notify Menu	79
Figure 3-54	Alarm-In Actions 2 Screen	80
Figure 3-55	Motion Detection Settings Screen	81
Figure 3-56	Motion Detection Sensitivity Screen.	82
Figure 3-57	Motion Detection Zone Screen	82
Figure 3-58	Motion Detection Zone Setup Menu.	82
Figure 3-59	Daytime Setup Screen.	84
Figure 3-60	Motion Detection Actions 1 Screen	85
Figure 3-61	Motion Detection Actions 2 Screen	86

Figures

Figure 3-62	PTZ Preset Screen	87
Figure 3-63	Video Loss Settings Screen	88
Figure 3-64	Video Loss Actions 1 Screen	89
Figure 3-65	Video Loss Notify Menu	90
Figure 3-66	Video Loss Actions 2 Screen	90
Figure 3-67	Text-In Settings Screen	91
Figure 3-68	Port Setup Screen	92
Figure 3-69	Text-In Actions 1 Screen	94
Figure 3-70	Text-In Actions 2 Screen	96
Figure 3-71	Health Check Screen	97
Figure 3-72	Check Recording Screen	97
Figure 3-73	Storage Screen	98
Figure 3-74	S.M.A.R.T Setup Screen	99
Figure 3-75	System Event Actions Screen	100
Figure 3-76	Event Status Screen	101
Figure 4-1	DVR Front Panel and Controls	103
Figure 4-2	Page Sequence	107
Figure 4-3	Mouse Menu	108
Figure 4-4	Mouse Display Menu	109
Figure 4-5	Sequence Menu	111
Figure 4-6	PTZ Select Camera Menu	112
Figure 4-7	PTZ Preset Screen	113
Figure 4-8	Preset View Screen	114
Figure 4-9	PTZ Toolbar	114
Figure 4-10	Playback Toolbar	118
Figure 4-11	Search Menu	119
Figure 4-12	Go to the Date/Time Screen	120
Figure 4-13	Calendar Search Screen	120
Figure 4-14	Event Log Search Screen	122
Figure 4-15	Event Log Search Option Screen	123
Figure 4-16	Text-In Search Screen	125
Figure 4-17	Text-In Search Option Screen	126
Figure 4-18	Motion Search Screen	127
Figure 4-19	Motion Search Option Screen	128
Figure 4-20	Clip-Copy Screen	130
Figure B-1	Query Example 1	135
Figure B-2	Query example 2	136
Figure C-1	ClipPlayer Screen	137
Figure D-1	Time Overlap	141
Figure D-2	Time Overlap Segment Selection	141
Figure D-3	Time Overlap Start/Stop Time Selection	141
Figure F-1	I/O Connector Pinouts	145
Figure F-2	RS485 Connector Pinouts	145

Figures

Tables

Table 2-1	Rear Panel Connections	24
Table 3-1	16-Channel DVR Front Panel Controls	32
Table 3-2	Information Screen Options	40
Table 3-3	Storage Status Information	45
Table 3-4	New Group Authority Level Assignments	48
Table 3-5	Modem Setup Screen Options	56
Table 3-6	DVRNS Setup Screen Options	57
Table 3-7	Notification Mail Setup Screen Options	58
Table 3-8	Notification Callback Setup Screen Options	60
Table 3-9	Options in the Alarm-Out Settings Tab	65
Table 3-10	Alarm-Out Schedule Options	66
Table 3-11	Record Setup Screen Options	72
Table 3-12	Motion Detection Zone Setup Screen Menu	83
Table 4-1	Front Panel Controls	103
Table 4-2	Mouse Functions	108
Table 4-3	Right Mouse Button Menu Functions	108
Table 4-4	Mouse Display Menu Functions	109
Table 4-5	PTZ Toolbar Tools	114
Table 4-6	Playback Button Functions	117
Table 4-7	Playback Toolbar Functions	118
Table 4-8	Search Menu Options	119
Table 4-9	Event Log Search Options	123
Table 4-10	Self-Diagnostic Events	124
Table 4-11	Text-In Search Options	126
Table 4-12	Motion Search Options	128
Table 4-13	Using the Clip-Copy Function	129
Table 4-14	Clip Copy Options	130

About This Document

This document introduces the HRSD Series Digital Recorder (DVR) and describes how to install, configure, and operate the DVR.

This guide covers both the 8- and 16-channel HRSD Series DVRs. They are identical except for the number of cameras and alarms that can be connected, and the number of cameras that can be displayed. For simplicity, the illustrations and descriptions in this guide refer to the 16-camera model.

Overview of Contents

This document contains the following chapters and appendices:

- *Chapter 1, Introduction*, introduces the HRSD Series DVRs, lists the features, and gives a functional overview of its components.
- *Chapter 2, Installation*, describes how to install the DVR and connect the system components.
- *Chapter 3, Configuration*, provides an overview of the front panel controls and LCD displays, and provides instructions for configuring the DVR.
- *Chapter 4, Operation*, describes live monitoring, recording video and audio, playing recorded video, and searching for video.
- *Appendix A, USB Hard Disk Drive Preparation*, shows how to prepare the USB hard disk drive for computers using Microsoft® Windows 2000/98/SP/Vista operating systems.
- *Appendix B, Text-In Query Examples*, shows how to search for video using text-in queries.
- *Appendix C, Reviewing Video Clips*, describes the ClipPlayer program features.

- *Appendix D, Time Overlap*, instructs how to search for recorded video when you have overlapping time segments.
- *Appendix E, Troubleshooting*, provides answers for common technical issues.
- *Appendix F, Connector Pinouts*, describes I/O and RS485 connector pinouts.
- *Appendix G, Map of Screens*, provides a graphic illustration of the menu screens.
- *Appendix H, System Log Notices*, lists all the system log notices.
- *Appendix I, Error Code Notices*, lists the system upgrade and clip copy error code notices.
- *Appendix J, Specifications*, lists the DVR specifications.

About Cautions and Warnings

Caution A caution advises users that failure to take or avoid a specified action could result in loss of data or damage to the equipment.

WARNING! A warning advises users that failure to take or avoid a specified action could result in physical injury to a person or irreversible damage to the equipment.

Important Safeguards

1. Read Instructions
All the safety and operating instructions should be read before the appliance is operated.
2. Retain Instructions
The safety and operating instructions should be retained for future reference.
3. Cleaning
Unplug this equipment from the wall outlet before cleaning it. Do not use liquid aerosol cleaners. Use a damp soft cloth for cleaning.
4. Attachments
Never add any attachments and/or equipment without the approval of the manufacturer as such additions may result in the risk of fire, electric shock, or other personal injury.

5. Water and/or Moisture

Do not use this equipment near water or in contact with water.

6. Accessories

Do not place this equipment on an unstable cart, stand, or table. The equipment may fall, causing serious injury to a child or adult, and serious damage to the equipment. Wall or shelf mounting should follow the manufacturer's instructions, and should use a mounting kit approved by the manufacturer.



This equipment and cart combination should be moved with care. Quick stops, excessive force, and uneven surfaces may cause the equipment and cart combination to overturn.

7. Power Sources

This equipment should be operated only from the type of power source indicated on the marking label. If you are not sure of the type of power, please consult your equipment dealer or local power company.

8. Power Cords

Operator or installer must remove power, BNC, alarm, and other connections before moving the equipment.

9. Lightning

For added protection for this equipment during a lightning storm, or when it is left unattended and unused for long periods of time, unplug it from the wall outlet and disconnect the antenna or cable system. This will prevent damage to the equipment due to lightning and power-line surges.

10. Overloading

Do not overload wall outlets and extension cords to avoid the risk of fire or electric shock.

11. Objects and Liquids

Never push objects of any kind through openings of this equipment as they may touch dangerous voltage points or short out parts that could result in a fire or electric shock. Never spill liquid of any kind on the equipment.

12. Servicing

Do not attempt to service this equipment yourself. Refer all servicing to qualified service personnel.

13. Damage Requiring Service

Unplug this equipment from the wall outlet and refer servicing to qualified service personnel under the following conditions:

- When the power-supply cord or the plug has been damaged
- If liquid is spilled or objects have fallen into the equipment
- If the equipment has been exposed to rain or water
- If the equipment does not operate normally by following the operating instructions, adjust only those controls that are covered by the operating instructions as an improper adjustment of other controls may result in damage and will often require extensive work by a qualified technician to restore the equipment to its normal operation.
- If the equipment has been dropped or the cabinet damaged
- When the equipment exhibits a distinct change in performance—this indicates a need for service.

14. Replacement Parts

When replacement parts are required, be sure the service technician has used replacement parts specified by the manufacturer or that have the same characteristics as the original part. Unauthorized substitutions may result in fire, electric shock, or other hazards.

15. Safety Check

Upon completion of any service or repairs to this equipment, ask the service technician to perform safety checks to determine that the equipment is in proper operating condition.

16. Field Installation

This installation should be made by a qualified service person and should conform to all local codes.

17. Correct Batteries

WARNING! Risk of explosion if battery is replaced by an incorrect type. Dispose of used batteries according to the instructions.

18. Operating Temperature

An operating temperature range is specified (see *Appendix J, Specifications*) so that the customer and installer may determine a suitable operating environment for the equipment.

19. Elevated Operating Ambient Temperature

If installed in a closed or multi-unit rack assembly, the operating ambient temperature of the rack environment may be greater than room ambient. Therefore, consideration should be given to installing the equipment in an environment compatible with the specified operating temperature range.

20. Reduced Air Flow

Installation of the equipment in the rack should be such that the amount of airflow required for safe operation of the equipment is not compromised.

21. Mechanical Loading

Mounting of the equipment in the rack should be such that a hazardous condition is not caused by uneven mechanical loading.

22. Circuit Overloading

Consideration should be given to connection of the equipment to supply circuit and the effect that overloading of circuits might have on over-current protection and supply wiring. Appropriate consideration of equipment nameplate ratings should be used when addressing this concern.

23. Reliable Earthing (Grounding)

Reliable grounding of rack mounted equipment should be maintained. Particular attention should be given to supply connections other than direct connections to the branch circuit (for example, use of power strips).

Typographical Conventions

[you can delete the conventions that don't apply to your document]

This document uses the following typographical conventions:

Font	What it represents	Example
Swiss721 Lt BT	Keys on the keyboard	Press Ctrl+C
Lucida	Values of editable fields that are mentioned in the body text of the document for reference purposes, but do not need to be entered as part of a procedure	The Time field can be set to Hours:Minutes:Seconds.
	Text strings displayed on the screen	The message Password Updated displays.
Lucida Bold	Words or characters that you must type. The word "enter" is used if you must type text and then press the Enter or Return key.	Enter the vehicle ID number: Goldwing
	Values of editable fields that appear in tables (on first mention)	The Background Recording field can be set to one of the following values: Enabled Disabled
Swiss721 BT bold	Menu titles and other items you select	Double-click FVC Tool icon.
	Buttons you click to perform actions	Click Exit to close the program.
<i>Italic (any font)</i>	Placeholders: words that vary depending on the situation	<i>vehicle ID</i>
<i>Palatino italic</i>	Cross-reference to external source	Refer to the <i>FareView Player - Image Viewing/Archiving Tool Application Note</i> .
	Cross-reference within document	See <i>Introduction</i> .

Introduction

Features

Your color digital video recorder (DVR) provides recording capabilities for 8 or 16 camera inputs. It provides exceptional picture quality in both live and playback modes, and offers the following features:

- 8 or 16 Composite Video Input Connectors
- Compatible with Color (NTSC or PAL) and B&W (CCIR and EIA-170) Video Sources
- Auto Detection for NTSC and PAL
- Multiple Monitor Connectors: 1 BNC Video Out, 1 Spot, 1 VGA
- Multiple Search Engines (Date/Time, Calendar, Event)
- Records up to 120/100 Images per Second (NTSC/PAL)
- "Loop-Through" Video Connectors
- Continuous Recording in Disk Overwrite Mode
- 2 USB 2.0 Ports
- Continues Recording while Transmitting to Remote Site and during Playback
- User-friendly Graphical User Interface (GUI) Menu System
- Multiple Recording Modes (Time-lapse, Pre-event, Alarm, Motion, Text, and Panic)
- 2-Channel Audio Recording and 1-Channel Audio Playback
- Text Input for ATM and POS
- Alarm Connections Include: Input, Output, and Reset Input
- Built-in Alarm Buzzer
- Live or Recorded Video Access via Ethernet or Modem
- Time Synchronization using industry standard protocol
- Built-in CD-RW Drive
- Self-diagnostics with automatic notification including hard disk drive S.M.A.R.T. protocol

Technical Overview

In addition to replacing both a time-lapse VCR and a multiplexer in a security installation, your DVR has many features that make it much more powerful and easier to use than even the most advanced VCR.

The DVR converts analog NTSC or PAL video to digital images and records them on a hard disk drive. Using a hard disk drive allows you to access recorded video almost instantaneously; there is no need to rewind tape. The technology also allows you to view recorded video while the DVR continues recording video.

Digitally recorded video has several advantages over analog video recorded on tape. There is no need to adjust tracking. You can freeze frames, fast forward, fast reverse, slow forward and slow reverse without image streaking or tearing. Digital video can be indexed by time or events, and you can instantly view video after selecting the time or event.

Your DVR can be set up for event or time-lapse recording. You can define times to record, and the schedule can change for different days of the week and user-defined holidays.

The DVR can be set up to alert you when the hard disk drive is full, or it can be set to record over the oldest video once the disk is full.

Your DVR uses a proprietary encryption scheme making it nearly impossible to alter video.

You can view video and control your DVR remotely by connecting via Ethernet. There are two USB ports that can be used to upgrade the system or copy video clips to external hard disk, CD-RW, and flash drives.

Note This manual covers the 8- and 16-channel digital video recorders. The DVRs are identical except for the number of cameras and alarms that can be connected and the number of cameras that can be displayed. For simplicity, the illustrations and descriptions in this manual refer to the 16-camera model.

Figure 1-1 Typical DVR Installation for the HRSD8/16 DVR

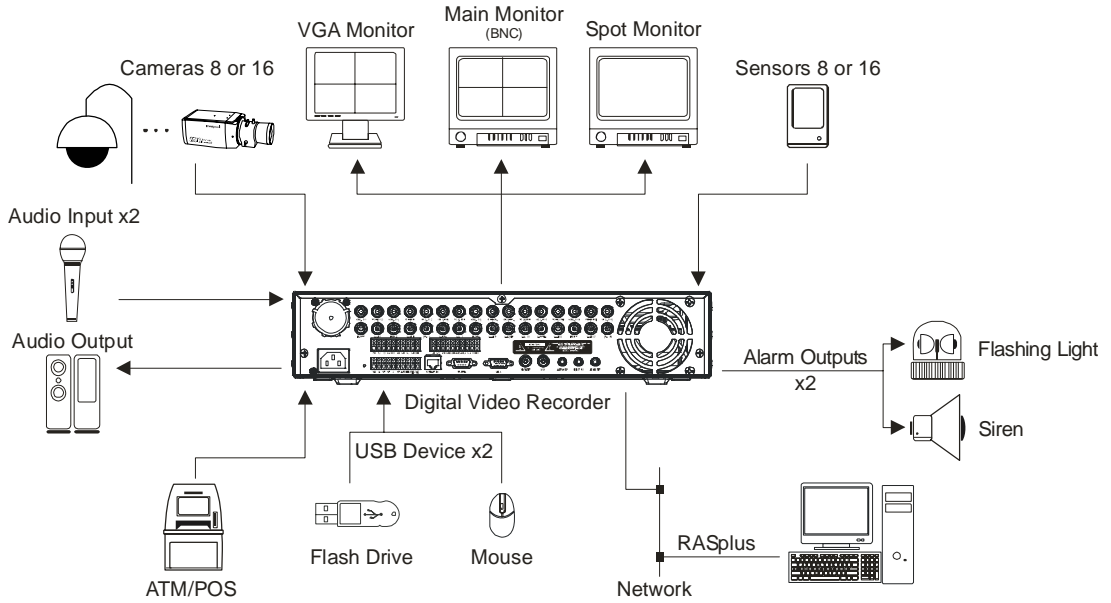

2

Installation

Package Contents

The package contains the following: Digital Video Recorder

- Power Cord
- User Guide (This Document)
- Multilingual User Guide (RASplus CD-ROM)
- RASplus User Guide
- Multilingual RASplus Software CD and User Guide (RASplus CD-ROM)
- DVRNS Server Software and User Guide (RASplus CD-ROM)
- Rack-mount Kit

Required Installation Tools

No special tools are required to install the DVR. Refer to the installation manuals for the other items that make up part of your system.

Figure 2-1 16-Channel DVR Rear Panel

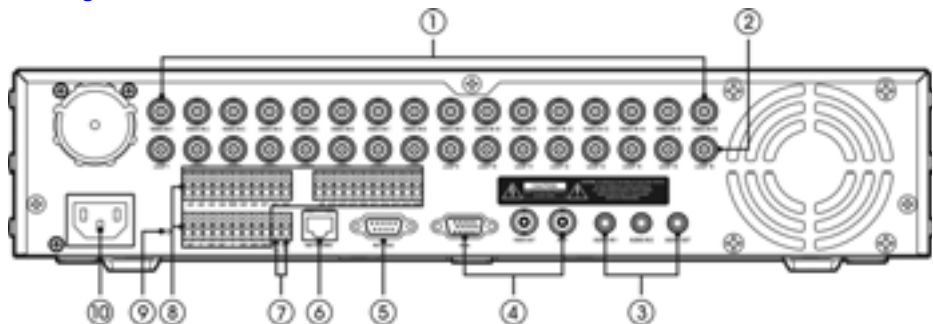

Table 2-1 Rear Panel Connections

#	Connection	#	Connection
1	Video input	6	Network/Ethernet port
2	Looping connectors	7	RS485 port for remote devices
3	Audio input x2; audio output x1	8	Alarm inputs
4	Video main: BNC or VGA; Spot-BNC	9	Alarm outputs
5	Serial RS-232C port	10	Power cord connector

Your DVR can be used with either NTSC or PAL equipment.

Note You cannot mix NTSC and PAL equipment. For example, you cannot use a PAL camera and an NTSC monitor.

Connecting the Video Source

Connect the coaxial cables from the video sources to the BNC Video In connectors.



Connecting the Loop Through Video

If you would like to connect your video source to another device, you can use the Loop BNC connectors.



Note The Loop BNC connectors are auto terminated. Do *NOT* connect a cable to the Loop BNC unless it is connected to a terminated device because it will cause poor quality video.

Connecting Audio

Note It is the user's responsibility to determine if local laws and regulations permit recording audio.

Your DVR can record audio from up to two sources. Connect the audio sources to Audio In 1 and Audio In 2 as needed using RCA jacks. Connect Audio Out to your amplifier.



Note The DVR does not have amplified audio output, so you need a speaker with an amplifier. The DVR does not have a pre-amplifier for audio input, so the audio input should be from an amplified source, not directly from a microphone.

Connecting the Monitor

Using a Computer Monitor

A VGA connector is provided so that you can use a standard, multi-sync computer monitor as your main monitor. Use the cable supplied with your monitor to connect it to the DVR.



Using a Spot Monitor

Connect the main monitor to the Video Out connector. Connect the spot monitor to the SPOT connector as needed.

Figure 2-6 Video Out Connector



Note The VGA and Video Out (BNC) connectors may be connected to individual monitors for simultaneous operation.

Connecting the DVR for Remote Access

Connecting the RS-232C Port

An RS-232C port is provided to connect an external modem for remote monitoring, configuration, software upgrades, and to connect a remote control keyboard. Use a modem cable with a DB-9S (female) connector to connect to the DVR. See *Chapter 3, Configuration* for how to configure the modem.

Figure 2-7 RS-232C Port



Note The DVR is not supplied with a modem cable, and many modems are not supplied with cables. Ensure that you have the correct cable when purchasing the modem.

Connecting the Network Port

The DVR can be networked using the 10/100Mb Ethernet connector. Connect a Cat5 cable with an RJ-45 jack to the DVR connector. The DVR can be networked with a computer for remote monitoring, searching, configuration, and software upgrades. See *Chapter 3, Configuration* for configuring the Ethernet connections.

Figure 2-8 Network Port



Caution The network connector is not designed to be connected directly with cable or wire intended for outdoor use.

Connecting the RS485 Port

The DVR can be controlled remotely by an external device or control system, such as a control keyboard, using RS485 half-duplex serial communications signals. The RS485 connector can also be used to control PTZ (pan, tilt, zoom) cameras. Connect the RX-/TX- and RX+/TX+ of the control system to the TX-/RX- and TX+/RX+ (respectively) of the DVR. See *Chapter 3, Configuration* and the PTZ camera or remote controller manufacturer's manual for configuring the RS485 connection.

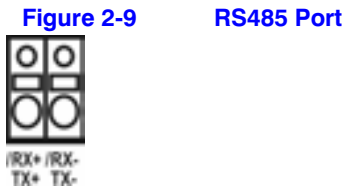

Connecting Alarm Inputs and Outputs

Note To make connections on the Alarm Connector Strip, press and hold the button and insert the wire in the hole below the button. After releasing the button, tug gently on the wire to ensure that it is connected. To disconnect a wire, press and hold the button above the wire and pull out the wire.



AI 1 to 16 (Alarm-In)

You can use external devices to signal the DVR to react to events. Mechanical or electrical switches can be wired to the AI (Alarm-In) and GND (Ground) connectors. The threshold voltage is 4.3V and should be stable at least 0.5 seconds to be detected. See *Chapter 3, Configuration* for configuring alarm input.

GND (Ground)

Connect the ground side of the Alarm input and/or alarm output to the GND connector.

Note All the connectors marked GND are common.

**NC/NO
(Relay
Alarm
Outputs)**

The DVR can activate external devices such as buzzers or lights. Connect the device to the C (Common) and NC (Normally Closed) or C and NO (Normally Open) connectors. NC/NO is a relay output which sinks 0.5A@125VAC and 1A@30VDC. See *Chapter 3, Configuration* for configuring alarm output.

**ARI (Alarm
Reset In)**

An external signal to the Alarm Reset In can be used to reset both the Alarm Out signal and the DVR's internal buzzer. Mechanical or electrical switches can be wired to the ARI (Alarm Reset In) and GND (Ground) connectors. The threshold voltage is below 0.3V and should be stable at least 0.5 seconds to be detected. Connect the wires to the ARI (Alarm Reset In) and GND (Ground) connectors.

Connecting USB Ports

Two USB ports on the front panel are provided to connect external hard disk, CD-RW, or flash drives for video clip copying or system upgrades. Position external drives close enough to the DVR so that you can make the cable connections, usually less than 6 feet. Use the USB cable provided with the hard disk drive to connect it to the DVR.

Figure 2-11 USB Ports



A USB mouse (not supplied) can be connected to one of the ports. You can use the mouse to navigate through the screens and menus much like you would on a computer.

A USB to Serial converter can be connected to the USB port. Multiple text-in devices can be used with a USB to Serial converter.

Factory Reset

The DVR has a Factory Reset switch to the left of the Alarm Output connectors on the rear panel. This switch should be used only on the rare occasions that you want to return all the settings to the original factory settings.

Figure 2-12 Factory Reset Switch

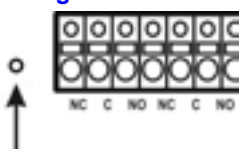

Caution When you use the Factory Reset, you lose any settings you have saved.

To reset the unit, you need a straightened paperclip:

1. Turn off the DVR.
2. Turn it on again.
3. While the DVR is initializing, the front panel LEDs blink. When the front panel LEDs blink, poke the straightened paperclip to the unlabeled hole in the left of the Alarm Output connectors.
4. Hold the switch until all the LEDs on the front panel are lit.

Note When the DVR successfully resets to factory defaults all the LEDs on the front panel flash five times.

5. Release the reset switch. All of the DVR's settings are now at the original settings it had when it left the factory.

Connecting the Power Cord

Caution In noisy electrical environments, use an Uninterruptible Power Supply (UPS) to minimize the potential of damage to the DVR from undesired power related hazards. Connect the UPS between the DVR and the AC voltage supply.

Connect the AC power cord to the DVR and then to a wall outlet.

Figure 2-13 Power Cord Connector



Caution Route power cords so that they are not a tripping hazard. Ensure that the power cord can not be pinched or abraded by furniture. Do not install power cords under rugs or carpets.

The power chord has a grounding pin. If your power outlet does not have a grounding pin receptacle, do not modify the plug. Do not overload the circuit by plugging too many devices in to one circuit.

Your DVR is now ready to operate. See *Chapter 3, Configuration* for how to configure the DVR's settings, and *Chapter 4, Operation* for how to operate the DVR.

3

Configuration

Note Your DVR should be completely installed before proceeding. If you have not installed the DVR, please see *Chapter 2, Installation*.

Front Panel Controls

The front panel looks and operates much like a VCR combined with a multiplexer. Many of the buttons have multiple functions. The following describes each button and control. Take a few minutes to review the descriptions. You will use these to initially set up your DVR and for daily operations.

Note You can also use a USB mouse (not supplied) to navigate through the screens and menus much like you would on a computer.

Figure 3-1 16-Channel DVR Front Panel

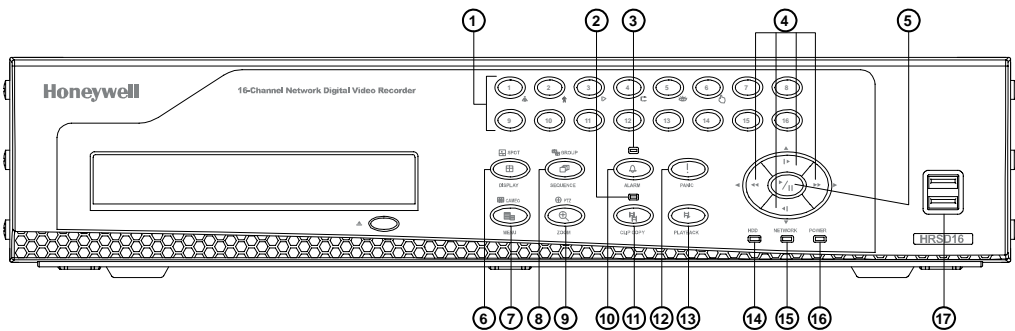

Table 3-1 16-Channel DVR Front Panel Controls























Position	Control	Function
1	Camera Buttons (1 to 16)	<p>Press the individual camera buttons to display the selected camera full screen. Buttons 1 to 9 are also used to enter passwords.</p> <p>In the PTZ mode, press Camera 1 to zoom in and Camera 2 to zoom out. Press Camera 3 to focus near and Camera 4 to focus far. Press Camera 5 to move to the preset and Camera 6 to save the preset.</p>
2	Clip Copy LED	The Clip Copy LED lights when the DVR is clip-copying.
3	Alarm Out LED	The Alarm Out LED lights when alarm output or internal buzzer is activated.
4	Arrow Buttons	<p>These buttons are used to navigate through menus and GUI. You can also use them to change numbers by highlighting a number in the menu and using the Up and Down arrows to increase or decrease the number's value.</p> <p>These buttons are also used to control Pan and Tilt when in the PTZ mode. When in the PIP display format, press the Up and Down arrows to move the position of the small screen counter-clockwise and clockwise, and press the Left and Right arrows to change the PIP screen size.</p> <p>In the playback mode, press  to play video backward at high speed. Press  again to toggle the playback speed from ,  and . The screen displays ,  and  respectively. Press  to play video forward at high speed. Press  again to toggle the playback speed from ,  and . The screen displays ,  and  respectively. When in the pause mode, press  to move to the next image and press  to move to the previous image.</p>
5	PLAY/PAUSE Button	<p>In the live monitoring mode, press  to freeze the current screen. The screen displays the  icon. When in the playback mode, press  to play back images at regular speed or pause playing video.</p> <p>Press  to select a highlighted item or complete an entry that you have made during system setup.</p>
6	DISPLAY/SPOT Button	<p>Press DISPLAY/SPOT to toggle different display formats. The available formats are: PIP, 2x2, 3x3 and 4x4.</p> <p>Press and hold DISPLAY/SPOT for two seconds or longer to select which cameras display on the Spot monitor.</p>

Table 3-1 16-Channel DVR Front Panel Controls







Position	Control	Function
7	MENU/CAMEO Button	<p>Press MENU/CAMEO to enter the Setup screen. You need to enter the authorized user password to access Setup. Press MENU/CAMEO to close the current menu or setup dialog box. In the Playback mode, press MENU/CAMEO to display the Search menu.</p> <p>Press and hold MENU/CAMEO for two seconds or longer to enter the cameo mode. The yellow outline around the video indicates the active cameo.</p> <p>Press the arrows to move the active cameo.</p> <p>Press the desired camera button in the active cameo to edit the cameo and display the video of selected camera.</p> <p>Press  (Play/Pause) to exit the Active Cameo mode. You can also exit the Active Cameo mode by selecting Exit Group Edit in the cameo menu that displays when you press MENU/CAMEO.</p>
8	GROUP/SEQUENCE Button	<p>When in the live mode, press GROUP/SEQUENCE to change the screen from the current camera group to the next camera group. The screen displays the page number.</p> <p>Press and hold GROUP/SEQUENCE for two seconds or longer to display live channels sequentially.</p>
9	ZOOM/PTZ Button	<p>Press ZOOM/PTZ to zoom in the current image to double its size on the screen. You can use the arrows to move the rectangle to another area. Press  to zoom in on the image in the rectangle.</p> <p>Press and hold ZOOM/PTZ for two seconds or longer to enter the PTZ (Pan/Tilt/Zoom) mode. The PTZ icon flickers. Press ZOOM/PTZ again to exit the PTZ mode.</p> <p>Press the arrows or MENU/CAMEO to control cameras that are properly configured.</p>
10	ALARM Button	<p>The ALARM button has two functions:</p> <ul style="list-style-type: none"> • It resets the programmed DVR outputs including the internal buzzer during an alarm. • It displays the event log when you are in the live monitoring mode, unless there is an active alarm. This operation can be protected by a user password.
11	CLIP COPY Button	Press CLIP COPY to copy video clips.
12	PANIC Button	Press PANIC to start panic recording of all camera channels. The  icon displays on the screen. Press PANIC again to stop panic recording.

Table 3-1 16-Channel DVR Front Panel Controls



Position	Control	Function
13	PLAYBACK Button	Press PLAYBACK to enter the playback mode. Press PLAYBACK again to exit the playback mode. When entering the playback mode, video is paused. Press  to play back video at regular speed. The screen displays  when the DVR is in the Pause mode and the screen displays  when the DVR is playing back video.
14	HDD LED	The HDD LED flickers when the DVR is recording or searching video on the hard disk drive.
15	Network LED	The NETWORK LED lights when the unit is connected to a network via Ethernet.
16	Power LED	The POWER LED lights when the unit is On
17	USB Connectors	

Turning on the Power

Connecting the power cord to the DVR turns on the unit. The unit takes approximately 60 seconds to initialize.

Initial Unit Setup

Before using your DVR for the first time, you will want to establish the initial settings. This includes items such as time and date, display language, camera, audio, remote control, record mode, network, and password. Your DVR can be set up using various screens and dialog boxes.

Throughout the screens you will see . Highlight  and press  (Play/Pause) to reset that screen to its default settings.

Logging In

1. Press **MENU** to enter the setup screens. The Login screen appears.

Figure 3-2 Login Screen

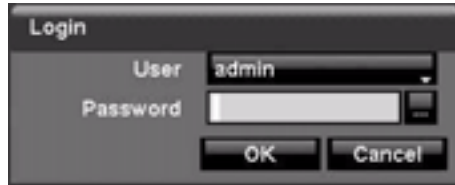

2. Select a User and enter the password by pressing the appropriate combination of Camera number buttons, and then . There is no default password when logging in the Admin User for the first time.

Note To assure the secure management of the system, setting up a password is strongly recommended.

Note Instead of using the front panel buttons, you can use a mouse (not supplied) to access the Login screen. Click the right mouse button to display the Login screen. Click ... to enter a password. The virtual keyboard appears. See *Using the Virtual Keyboard* on page 36 for instructions.

Setup Screen

Press the **MENU** button to enter the Setup screen.

Figure 3-3 Setup Screen

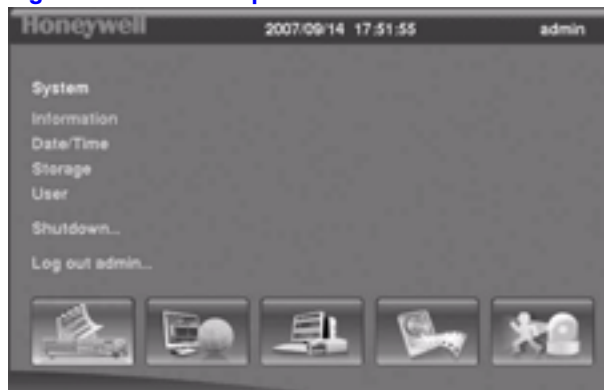

When setting up the DVR, there are many opportunities to enter names and titles. To make these entries, a Virtual Keyboard appears.

Figure 3-4 Virtual Keyboard

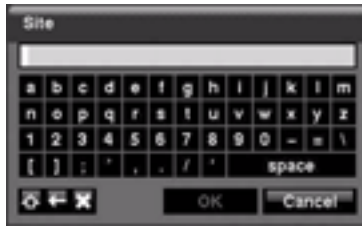

Using the Virtual Keyboard

Use the arrow keys to highlight the character you want in the name or title and press **↵**. That character appears in the title bar and the cursor moves to the next position. You can use up to 31 characters, including spaces, in your title.

Press **⇧** to toggle between the upper and lower case keyboards.

Press **←** to move back a space.

Press **✕** to delete entered characters.

Special characters can be created using **^** and a capital letter. For example, **^J** for NL (New Line); **^M** for CR (Carriage Return). Special characters are commonly used by text input devices and are useful when performing Text-In Searches.

Information Screen

In the Information screen, you can:

- name the site location
- assign a System ID number
- select the language the screens are displayed in
- display software version number
- upgrade the software
- show the System Log
- display recorded time data
- clear all data

1. Highlight **Information** and press **↵**. The Information screen appears.

Figure 3-5 Information Screen

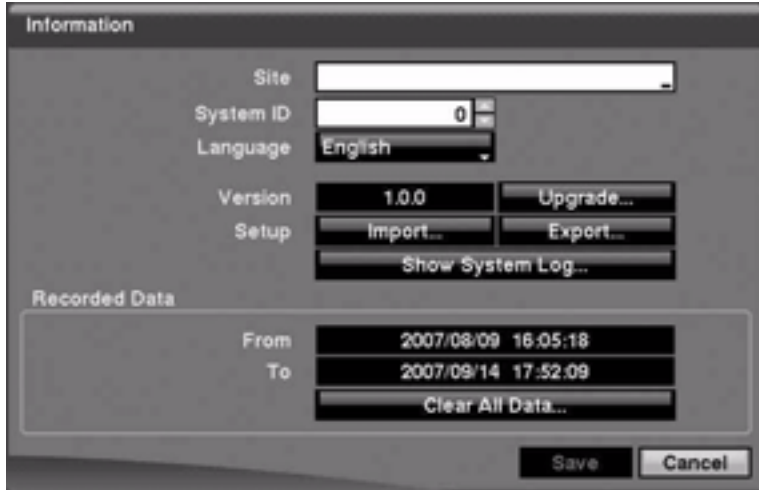

2. Highlight the **Site** field in the Information screen and press $\left(\frac{\text{v}}{\text{u}}\right)$. A virtual keyboard appears that you can use to enter a Site Name.
3. Highlight **Close** and press $\left(\frac{\text{v}}{\text{u}}\right)$ once you have entered your title.
4. Highlight the field beside **System ID** and press $\left(\frac{\text{v}}{\text{u}}\right)$. To change the number, highlight it and use the **Up** and **Down** arrows to choose from **0** to **99**.

Note The System ID number is used to identify the unit when it is connected with other DVRs through the RS485 port. You cannot use the same ID number for two or more DVRs that are in the same RS485 network. It is possible to have multiple DVRs with System ID of 0 that are in the same area as long as they are not part of an RS485 network.

5. Highlight the field beside **Language** and press $\left(\frac{\text{v}}{\text{u}}\right)$. A drop-down menu displays the available languages. Highlight the desired language and press $\left(\frac{\text{v}}{\text{u}}\right)$.

The field beside Version displays the software version of the DVR.

Upgrading the System Software

1. Connect to the DVR a USB device that contains the upgrade package file.
2. Highlight **Upgrade...** in the Information screen and press $\left(\frac{\text{v}}{\text{u}}\right)$. The Upgrade screen appears.

Figure 3-6 Upgrade Screen

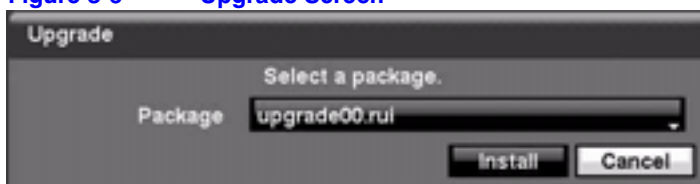

The screen displays the upgrade package file names that are available. The .rui extension indicates that the file is for software upgrades.

3. Select the desired file and press \leftarrow/\rightarrow .
4. Highlight **Install** and press \leftarrow/\rightarrow to install the selected software package.
5. Highlight **Cancel** and press \leftarrow/\rightarrow to close the window without upgrading the software. You get an error message if the upgrade package file is not installed correctly on the DVR.

The system restarts automatically after completing the upgrade.

Note The **Upgrade** button deactivates if the hard disk drive has not been formatted, as upgrading the system requires hard disk drive space for temporary files.

Caution The USB device must be FAT16 or FAT32 format.

You can import saved DVR settings or export the current DVR settings.

Importing Saved DVR Settings

1. Connect the USB device containing the setup file .dat to the DVR.
2. Highlight **Setup - Import...** in the Information screen and press \leftarrow/\rightarrow . The Setup Import screen appears.

Figure 3-7 Setup Import Screen

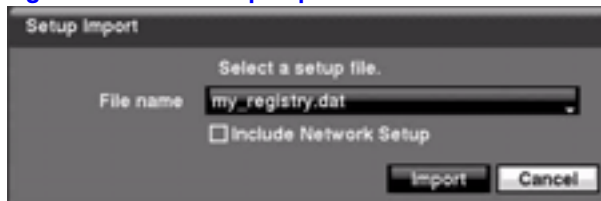

3. Select the desired setup file and press **Import** to import the selected settings and change the DVR settings accordingly.
4. Highlight **Include Network Setup** and press \leftarrow/\rightarrow to toggle between **On** and **Off**. When set to **Off**, the network settings will not be changed.
5. Select **Import** and press \leftarrow/\rightarrow .

Exporting Current DVR Settings

1. Connect the USB device to the DVR.
2. Highlight **Setup - Export...** in the Information screen and press \leftarrow/\rightarrow . The Setup Export screen appears.

Figure 3-8 Setup Export Screen



3. Highlight the field beside **File** name and press **F7**. A virtual keyboard appears to allow you to enter the file name.
4. Select **Export** to save the current settings in .dat file format on the USB device.

Note Even after changing the DVR settings by importing saved settings, the time-related settings (Date/Time, Time Zone and Daylight Saving Time) do *NOT* change.

Caution The USB device must be FAT16 or FAT32 format.

Viewing the System Log

The System Log screen lists system activities (up to 5,000, from the latest). It lists them from the latest activity, and includes the time and date of each event. The  icon displays in the last column for system activities from the remote site.

1. Highlight **Show System Log...** in the Information screen and press **F7** to display the System Log.

Figure 3-9 System Log Screen



2. Select log entries by either scrolling through the log pages by using the **UP** and **DOWN** arrows, or by choosing a log page directly by entering the log page number in the field at the bottom left of the screen.
3. Highlight **Close** and press **F7** to exit the screen.

Other Options in the Information Screen

Table 3-2 Information Screen Options

Option	Action
Recorded Data - From / To	Displays the time information of recorded data
Clear All Data...	Highlight Clear All Data... and press ↵ to clear all video data. You are asked to verify that you wish to clear all data before the DVR erases the video data. Clear All Data... does not clear the System Log.
Save	<p>After you have finished with the Information Screen, you can highlight Save and press ↵ to save the changes and exit the screen.</p> <p>If you do not wish to save the changes, highlight Cancel and press ↵ to exit the screen.</p>

Setting Up the Date and Time

1. Highlight **Date/Time** in the System menu and press **↵**. The Date/Time setup screen appears.

Figure 3-10 Date/Time Setup Screen

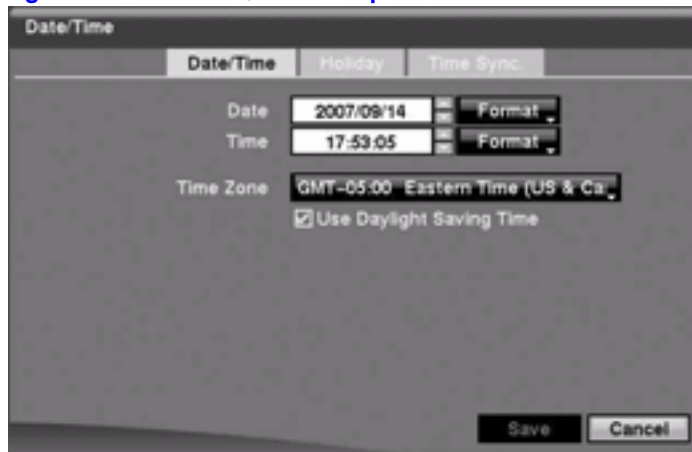

2. Highlight the first field beside **Date** and press **↵**. The individual sections of the date highlight. Use the **UP** and **DOWN** arrows to change the number. Use the **LEFT** and **RIGHT** arrows to move between month, date, and year. Press **↵** when you have the correct date.
3. Highlight the **Format** field beside Date and press **↵**. Select from the three available date formats and press **↵** to save the selected format.
4. Highlight the first field beside **Time** and press **↵** to scroll through the individual sections of the time.

Use the **UP** and **DOWN** arrows to change the number. Use the **LEFT** and **RIGHT** arrows to move between hour, minutes, and seconds. Press **↵** when you have the correct time.

5. Highlight the **Format** field beside Time and press $\left(\frac{\uparrow}{\downarrow}\right)$. Select from the three available time formats and press $\left(\frac{\uparrow}{\downarrow}\right)$ to save the selected format.

Note The clock does not start running until you highlight **Save** and press $\left(\frac{\uparrow}{\downarrow}\right)$.

6. Highlight the field beside **Time Zone** and press $\left(\frac{\uparrow}{\downarrow}\right)$. Select the correct time zone from the list and press $\left(\frac{\uparrow}{\downarrow}\right)$.
7. Highlight **Use Daylight Saving Time** and press $\left(\frac{\uparrow}{\downarrow}\right)$ to toggle between **On** and **Off**.

Setting Holidays

1. Highlight the **Holiday** tab, and the Holiday setup screen appears.

Figure 3-11 Holiday Setup Screen



2. Highlight + and press $\left(\frac{\uparrow}{\downarrow}\right)$. The current date appears.
3. Press $\left(\frac{\uparrow}{\downarrow}\right)$ again to change the date. Use the **LEFT** and **RIGHT** arrows to toggle from month to day. A white box highlights use the **UP** and **DOWN** arrows to change the number values.
4. Highlight the month and day, and change them by using the **UP** and **DOWN** arrows. Press $\left(\frac{\uparrow}{\downarrow}\right)$ to add the date. Dates can be deleted by highlighting the **X** beside the date and pressing $\left(\frac{\uparrow}{\downarrow}\right)$.

Note Holidays that do not fall on the same date each year should be updated after the current year's holiday has passed.

Synchronizing with a Standard Time Server

You can set up time synchronization between the DVR and standard time servers that are available in most time zones and countries, or between this DVR and another DVR.

1. Highlight the **Time Sync.** tab. The Time Sync. screen displays.

Figure 3-12 Time Sync. Screen

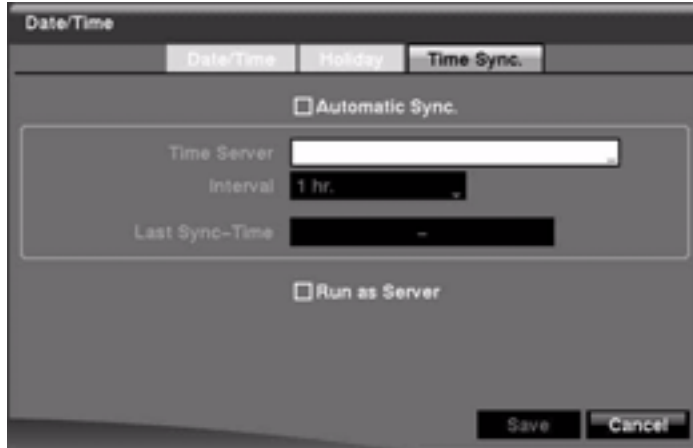

2. Highlight the field beside **Automatic Sync.** and press $\left(\frac{\text{v}}{\text{u}}\right)$ to toggle between **On** and **Off**. When set to **On**, the Time Server and Interval fields become active.
3. Highlight the field beside **Time Server** and press $\left(\frac{\text{v}}{\text{u}}\right)$. Use the virtual keyboard to enter the IP address or domain name of the time server.

Note You can use the domain name instead of the IP address if you have already set up the DNS Server when setting up the LAN.

4. Highlight the field beside **Interval** and press $\left(\frac{\text{v}}{\text{u}}\right)$. Set the time interval for synchronization from **30** minutes to **1** day at various time intervals.

The Last Sync-Time field displays the last time the DVR was synchronized with the time server.

5. Highlight **Run as Server** and press $\left(\frac{\text{v}}{\text{u}}\right)$ to toggle between **On** and **Off**. When it is **On**, the DVR you are setting up runs as a time server.
6. Save your changes by highlighting **Save** and pressing $\left(\frac{\text{v}}{\text{u}}\right)$. Select **Cancel** to exit the screen without saving the changes.

Storage Screen

Highlight **Storage** in the System menu and press $\left(\frac{\text{v}}{\text{u}}\right)$. The Storage Information Setup screen appears and displays information about the DVR storage devices.

Figure 3-13 Storage Information Screen

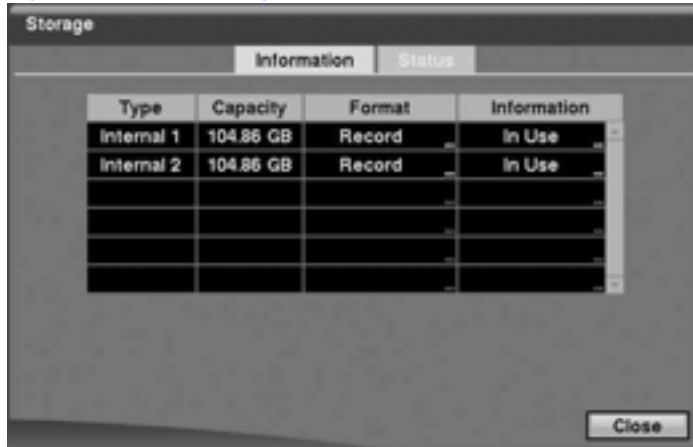

Column	Indication
Type	The Type column describes the storage device.
Capacity	The Capacity column displays the capacity of the storage device.
Format	Use this field to format the storage device. The Format column displays whether the device is used for recording (Record) or not (Not Using). Not Formatted indicates the device is not formatted.  indicates when the device has temporary space set aside so that video clips can be saved on a CD-RW or DVD RW. See Formatting a Device for Recording on page 43.
Information	The Information column indicates the status of the device. The status ranges from Used , Not Used , and Other , which indicates that the device has been used for another DVR. See Using the Information Column on page 44.

Formatting a Device for Recording

You can use this DVR to format devices for recording.

1. In the **Format** column, highlight the field for the desired storage device and press . The Device Format screen appears.

Figure 3-14 Device Format Screen



2. To format the device but not use it for recording, select **Not Using** from the **Use As** drop down menu.

3. To set aside space to store temporary files for CD or DVD burning, select **Partition - CD/DVD Burn**.
4. Highlight **Format** and press **(F4)**.

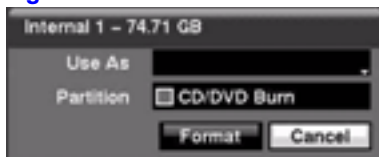
Note The DVR does *NOT* support USB hard disk drives with a version lower than 2.0.

Note System upgrades require formatting internal hard disk drives.

Using the Information Column

In the Information column, you can find the time and date information for the recorded data. Highlight the field for the desired storage device and press **(F4)**. The Device Information screen appears.

Figure 3-15 Device Information Screen

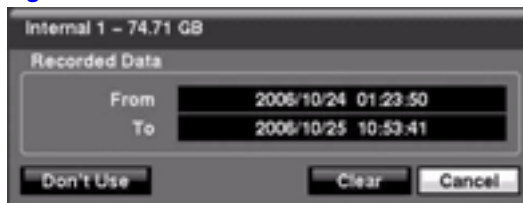

Erasing Recorded Data from a Device using the Device Information Screen

1. Highlight **Clear** and press **(F4)**. The Confirmation to Clear All Data screen appears.
2. Confirm that you want to delete the data.

Storage Status

Highlight the **Status** tab in the Storage Screen. The **Storage Status** screen displays.

Figure 3-16 Storage Status Screen

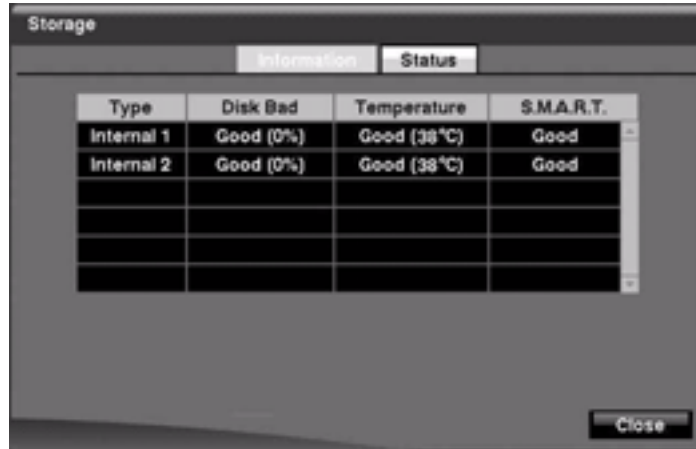

Table 3-3 Storage Status Information

Column	Information
Type	The Type column displays the type of storage device.
Disk Bad	The Disk Bad column displays the percentage of bad sectors. Not Formatted indicates the device is not formatted.
Temperature	The Temperature column displays the temperature of the storage device.
S.M.A.R.T.	The S.M.A.R.T. column displays Good, Bad, or N/A, depending on storage conditions. <ul style="list-style-type: none"> • Good: The storage condition is normal. • Bad: Data cannot be written on or read from the storage device. • N/A: Storage conditions are normal. However, the S.M.A.R.T. monitoring is not working or supported.

Note When the storage condition is Bad, the **Event Status - Storage** screen appears, and you can check the storage condition for details. If the Bad message displays, it is recommended that you replace the hard disk drive, usually within 24 hours.

Note Temperature and S.M.A.R.T. information is available only for IDE hard disk drives that support the S.M.A.R.T. (Self-Monitoring Analysis and Reporting Technology) monitoring program.

Select **Close** and press **↵** to exit the Storage Status screen.

User Setup Screen

The User setup screen displays the authorized groups and users. You can add and delete groups and users. When adding a group, you can assign authority levels to the group.

Highlight **User** in the System menu and press F10 . The User Setup screen appears.

Figure 3-17 User Setup Screen



Viewing All the Users in a Group

You can use the +/- column to collapse and expand user groups.

If there is a...	This means that...
+ or - in this column	The item is a Group Name
- in front of the Group Name	The group has been expanded and all of the User Names within that group are displayed below the Group Name.
+ in front of the Group Name	The group has been collapsed and all of the User Names within that group are hidden

To collapse or expand a group, highlight the +/- column in front of the desired group and press F10 .

Changing the Authority Levels Assigned to a Group

Highlight a Group Name and press F10 to toggle between all authority levels being turned **On** and **Off**. Highlight the individual authority level boxes and press F10 to toggle between that authority **On** and **Off**.

Adding or Changing a User's Password

1. Highlight the User Name.
2. Press **(F10)** to add or change the password assigned to that user.

You can also change the group to which the user is assigned.

Caution Write down the new password and save it in a secure place. If the password is forgotten, the unit must be reset using the Factory Reset Button and all data settings will be lost.

Deleting a User or an Entire Group

Use the **X** column to delete a User Name or an entire Group. If the **X** is grayed out, then that Group or User cannot be deleted.

1. Highlight **X** and press **(F10)**.
2. Confirm that you want to delete the User or Group.

Note To delete the User currently logged into the DVR on a local system or a PC running RASplus (Remote Administration System), log that user out of the system first and then delete the user.

Adding a Group

1. Highlight the + **Group...** field and press **(F10)**. A virtual keyboard appears where you can enter the Group name. You can use up to 15 characters, including spaces, for the group name.
2. When you have entered a New Group name, highlight **OK** and press **(F10)**. The New Group Setup screen appears.

Figure 3-18 New Group Setup Screen



3. Assign authority levels to the group in the New Group setup screen.
 To change all authority levels of the group, highlight the **Authority** field and press **F7** to toggle between On and Off.
 To change the authority level of a single User, highlight the individual authority level boxes and press **F7** to toggle between **On** and **Off**.
 The authority levels that can be turned **On** and **Off** are shown in *Table 3-4*:

Table 3-4 New Group Authority Level Assignments

Authority Level	Action
Shutdown	The user can shut the system down on a local system.
Upgrade	The user can upgrade the software on a local system or a PC running RASplus.
System Time Change	The user can change the system date and time on a local system or a PC running RASplus.
Data Clear	The user can clear all video data or format disks on a local system or a PC running RASplus.
Setup	The user without Setup authority cannot establish any system settings excluding system shutdown and logout on a local system or a PC running RASplus.
Color Control	The user can control brightness, contrast, hue, and saturation for cameras on a local system or a PC running RASplus.
PTZ Control	The user can control the PTZ camera on a local system or a PC running RASplus.
Alarm-Out Control	The user can reset the DVR outputs including the internal buzzer that plays during an alarm by pressing the ALARM button on a local system or alarm-out control button on a PC running RASplus.
Covert Camera View	The user can view video from cameras set to Covert while in the Live Monitoring or Search mode on a local system or a PC running RASplus.
System Check	The user can view the remote system status or check the remote system status as a batch process on a PC running RASplus.

Table 3-4 New Group Authority Level Assignments

Authority Level	Action
Record Setup	The user can establish all Record settings on a local system or a PC running RASplus.
Search	The user can access the Search mode on a local system or a PC running RASplus.
Clip-Copy	The user can copy video clips on a local system or a PC running RASplus, and save video data in an AVI, bitmap, or JPEG file format.

Adding a User



1. Highlight the + **User...** field and press . A virtual keyboard appears where you can enter the User Name.

Figure 3-19 New User Setup Screen

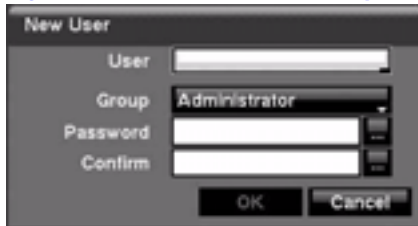

2. Enter the new user's name by highlighting and selecting a group, and then selecting **OK**.
3. Assign the User to a Group.
4. Assign a password to the User. You can use camera buttons 1 to 9 on the front panel or the virtual keyboard to assign the password. The password can be up to 8 digits.
5. Confirm the password.
6. Select **OK** and press .

Note In addition to using the front panel buttons, you can use the virtual keyboard to assign the password. To display the virtual keyboard click the ... button using the mouse (not supplied).

Options for the New User

To allow a User to be automatically logged in when the DVR is powered up, highlight the field beside **Auto Login**. These can also be set to never let a user log in automatically.

To select a time after which a user will automatically be logged out, highlight the field beside **Auto Logout** and select a time from the list: Never, 1 min., 3 min., 5 min., 10 min., 15 min., 20 min., 25 min., 30 min. and 1 hr.

Save your changes by highlighting **Save** and pressing the button. Select **Cancel** to exit the screen without saving the changes.

Shutting Down the DVR

1. Highlight **Shutdown** in the System menu and press \leftarrow . The Shutdown screen displays asking you to confirm whether or not you want to shut the system down.

Figure 3-20 Shutdown Screen

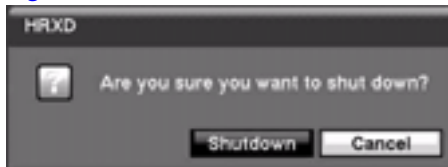

2. Select **Shutdown** and press \rightarrow to confirm shut down. A screen appears that tells you when it is safe to disconnect power.

Logging Out of the DVR

1. Highlight **Logout** in the System menu and press \leftarrow . The Logout screen appears and asks you to confirm whether or not you want to log out the current user.

Figure 3-21 Logout Screen

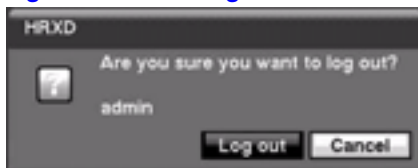

2. Select **Log out** and press \rightarrow to confirm that you want to log out.

Network & Notification Setup

In the Main screen, use the **LEFT** or **RIGHT** arrows to display the Network menu.

Figure 3-22 Network Menu

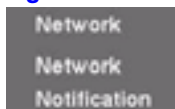

Setting up the Network

Highlight **Network** in the Network menu and press \leftarrow/\rightarrow . The Network setup screen displays. In the Network Setup screen, you are able to change the Network, LAN, Modem, and DVRNS settings.

Figure 3-23 Network Setup Screen



Configuring the Network

1. Highlight the first field beside **Transfer Speed**. Press the **Up** and **Down** arrows to set the Transfer Speed from **50 Kbps** to **100 Mbps**.
2. Highlight the second field beside **Transfer Speed**. You can select the unit of measure for the transfer speed between: **bps** and **ips**. Press \leftarrow/\rightarrow to set the unit of measure.
3. Highlight the field beside **Quality** and press \leftarrow/\rightarrow . You can select the Quality from: **Very High**, **High**, **Standard**, and **Basic**.
4. Press \leftarrow/\rightarrow to set the Quality.

Note The higher Quality settings require higher Transfer Speed settings. The transfer speed you set is the maximum speed. Depending on the network environment, this speed may not be achieved.

Note The local recording speed might be affected by various network bandwidth (Transfer Speed) conditions.

Setting Up the LAN

1. Highlight the **LAN** tab. The LAN (Manual) Setup screen displays.

Figure 3-24 LAN (Manual) Setup Screen



2. Highlight the field beside **Type** and press $\left(\frac{\uparrow}{\downarrow}\right)$. You can select the type of network configuration from: **Manual**, **DHCP**, and **ADSL (with PPPoE)**.

Select the desired type and press $\left(\frac{\uparrow}{\downarrow}\right)$.

Configuring the LAN Parameters Manually

1. Select **Manual** from the LAN Type field to set up LAN parameters manually.

Note You need to get the appropriate IP Address, Gateway, and Subnet Mask values from your network administrator.

2. Press $\left(\frac{\uparrow}{\downarrow}\right)$ to select the field. A white box appears over the adjustable field.
3. Change the numbers by highlighting them and using the **UP** and **DOWN** arrows to increase or decrease the number.
The factory default LAN settings are:
IP Address:192 . 168 . 1 . 129
Gateway:192 . 168 . 1 . 254
Subnet Mask:255 . 255 . 255 . 0
4. Highlight the field beside **DNS Server**. Press the **UP** and **DOWN** arrows to set the IP address of the DNS server.
5. Highlight the **Port Number Setup...** field and press $\left(\frac{\uparrow}{\downarrow}\right)$. The Port Number Setup screen appears.

Figure 3-25 Port Numbers Setup Screen

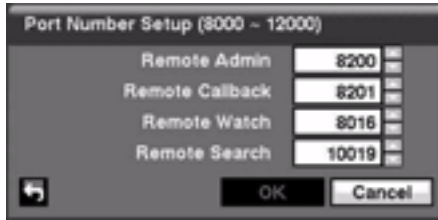

6. Change the numbers by highlighting them and pressing \uparrow/\downarrow to select the number field. Use the **UP** and **DOWN** arrows to increase or decrease the number value. The factory default Port settings are:

Remote Admin: 8200
Remote Callback:8201
Remote Watch: 8016
Remote Search:10019

Note You need to get the appropriate Port Numbers for each RASplus or a related program (Admin, Callback, Watch, and Search) from your network administrator.

Note The system restarts automatically after changing the port settings.

Note Do *NOT* use the same port number for two different programs. If you do, the DVR cannot be connected with the PC running RASplus.

Caution When changing the port settings, you must change the port settings on the PC running RASplus as well. Refer to the RASplus manual for details.

Using the Current LAN Settings Using DHCP

Select **DHCP** from the LAN Type field, highlight **Save**, and then press \uparrow/\downarrow . The DHCP (Dynamic Host Configuration Protocol) network reads and configures the current IP address of the DVR.

Figure 3-26 LAN (DHCP) Setup Screen



Configuring the LAN Using ADSL

1. Select **ADSL (with PPPoE)** in the LAN Type field. The LAN (ADSL) setup screen appears.

Note ADSL and modem cannot be configured at the same time. If the DVR is configured by modem, the ADSL (with PPPoE) can not be selected.

Figure 3-27 LAN (ADSL) Setup Screen



2. Highlight the field beside **ID** and press F_7 . A virtual keyboard appears so you can enter the ID for ADSL connection.
3. Highlight the field beside **Password** and press F_7 . A virtual keyboard appears so you can enter the password for ADSL connection.

Note Entering the ID and Password and highlighting **OK** reads the current IP address of the DVR configured by the ADSL network.

Note If the DVR is configured for DHCP or an ADSL network, the IP address of the DVR might change whenever the unit is turned on.

Setting Up the Modem

Highlight the **Modem** tab in the Network screen, and the Modem screen appears.

Figure 3-28 Modem Setup Screen



Note If the RS-232C port is in use for remote control, networking cannot be configured for a modem.

Table 3-5 Modem Setup Screen Options

Option	Action
Enable	Highlight Enable and press $\leftarrow \rightarrow$ to toggle between On and Off. You can only change the settings if Modem is enabled.
Baud Rate	Highlight the field beside Baud Rate and press $\leftarrow \rightarrow$. A list of baud rates ranging from 300 to 115,200 appears.
Data Bit	Highlight the field beside Data Bit and press $\leftarrow \rightarrow$. Choose between 7 bit and 8 bit formats.
Stop Bit	Highlight the field beside Stop Bit and press $\leftarrow \rightarrow$. Choose between 1 and 2 Stop Bits .
Parity	Highlight the field beside Parity and press $\leftarrow \rightarrow$. A drop-down list appears. You can select from None , Odd , or Even parity.

DVRNS Setup

Highlight the **DVRNS** tab in the Network screen. The DVRNS screen appears.

Figure 3-29 DVRNS Setup Screen









Note When LAN settings have been changed, set up the DVRNS after saving your LAN changes by highlighting **Save** and pressing .

Table 3-6 DVRNS Setup Screen Options

Option	Action
Use DVR Name Service	Highlight Use DVR Name Service and press  to toggle between On and Off .
<p>Note The DVRNS (DVR Name Service) allows the DVR to use Dynamic IP addresses for remote connection. When this feature is On, you can access your DVR remotely using the DVR name instead of its IP address. For the DVRNS feature, the DVR should be registered on the DVRNS server.</p>	
DVRNS Server	Highlight the field beside DVRNS Server and press  . A virtual keyboard appears with which you can enter the IP address or domain name of the DVRNS server.
<p>Note You need to get the IP Address or domain name of the DVRNS Server from your network administrator.</p>	
<p>Note You can use the domain name instead of IP address if you already set up the DNS Server when setting up the LAN.</p>	
Port	Highlight the field beside Port and press  . Set the port number of the DVRNS server using the Up and Down arrows to increase or decrease the numbers.
Use NAT	Highlight Use NAT and press  to toggle between On and Off .
<p>Note When using the NAT (Network Address Translation) device, refer to the NAT manufacturer's instructions for the proper network settings.</p>	
DVR Name	Highlight the field beside DVR Name and press  . A virtual keyboard appears allowing you to enter the DVR name to be registered on the DVRNS server.
Check	Highlight the Check field and press  to enable or disable the name you entered.

Note The DVR name you entered should be checked by selecting **Check**, otherwise the DVRNS changes will not be saved.

Note An error message displays if you don't enter a name or if you enter a name that is already registered on the DVRNS server.

Highlight **Save** and press **F10** to register the DVR on the DVRNS server. Proper DVRNS settings display the help desk information of the DVRNS server in the box beside Help Desk.

Notification Setup

The DVR can be set up to send an email or to contact a computer running RASplus (Remote Administration System) when an event occurs.

Highlight **Notification** in the Network menu and press **F10**. The Notification screen displays. With this screen, you can change the Mail and Callback settings.

Configuring Mail Notification Settings

Highlight the **Mail** tab in the Notification screen if it isn't already highlighted.





Figure 3-30 Notification Mail Setup Screen



Table 3-7 Notification Mail Setup Screen Options

Option	Action
Enable	Highlight Enable and press F10 to toggle between On and Off . You can make changes to the settings only if Mail is enabled.
SMTP Server	Highlight the field beside SMTP Server and press F10 . Use the virtual keyboard to enter the SMTP Server IP address or domain name obtained from your system administrator.
Note	You need to get the IP Address or domain name of the SMTP Server from your network administrator.

Table 3-7 Notification Mail Setup Screen Options

Option	Action
Note	You can use the domain name instead of the IP address if you already set up the DNS Server when setting up the LAN.
Port	Highlight the field beside Port and press  . Use the arrows to enter the SMTP Server port number obtained from your system administrator. The default port number is 25.
Use SSL/TLS	Highlight Use SSL/TLS and press  to toggle between On and Off . When it is On , the DVR can send an email via an SMTP server requiring SSL (Secure Sockets Layer) authentication.
Authentication	<ol style="list-style-type: none"> Highlight the field beside Authentication and press . An Authentication screen appears. <div data-bbox="389 620 776 807" data-label="Image"> </div> Highlight Use and press  to toggle between On and Off. Highlight the field beside User/Password and press . Use the virtual keyboard to enter the user ID and password.
Sender	Highlight the field beside Sender and use the virtual keyboard to enter the sender's e-mail address.
Note	The e-mail address must include the "@" character to be a valid address.
Recipient	Highlight the field beside Recipient and use the virtual keyboard to enter the recipient's e-mail address.

Configuring Notification Callback Settings

Highlight the **Callback** tab. The Callback screen appears.

Figure 3-31 Notification Callback Setup Screen



Table 3-8 Notification Callback Setup Screen Options

Option	Action
LAN	Highlight LAN and press $\left(\frac{1}{n}\right)$ to toggle between On and Off . When LAN is turned On , you can change the IP addresses.
IP Address	Highlight the IP Address field that you want to change and press $\left(\frac{1}{n}\right)$. Enter the IP address of the computer you want contacted during an event. You can enter up to five IP addresses.
Retry	Highlight the field beside Retry and enter the number of times you would like the DVR to try contacting the computer. You can select from 1 to 10 retries.
Modem	If the modem was enabled in the Network screen (see <i>Setting Up the Modem</i> on page 55), you can set the DVR to contact a computer running RASplus. Highlight Modem and press $\left(\frac{1}{n}\right)$ to toggle between On and Off . When Modem is turned On you can enter a telephone number.
Remote Server Phone Number	Highlight the field beside Remote Server Phone Number and use the virtual keyboard to enter the telephone number of the computer running RASplus.
Outside Line Call	Highlight the field beside Outside Line Call and enter any numbers that must be dialed for an outside line for your telephone system. For example, you may have to dial 9 to get an outside line.
Callback Phone Number	Highlight the field beside Callback Phone Number and use the virtual keyboard to enter the telephone number of the DVR.

Save your Notification changes by highlighting **Save** and pressing $\left(\frac{1}{n}\right)$. Select **Cancel** to exit the screen without saving the changes.

Configuring Devices

Using the configuration devices, you can configure the:

- video
- audio
- alarm
- display
- remote control devices connected to the DVR

Figure 3-32 **Devices Menu**

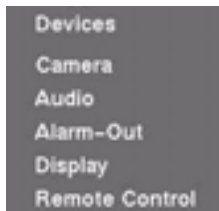

Configuring the Camera Setup

Highlight **Camera** in the Devices menu and press \odot . The Camera Setup screen appears.

Figure 3-33 **Camera Setup Screen**

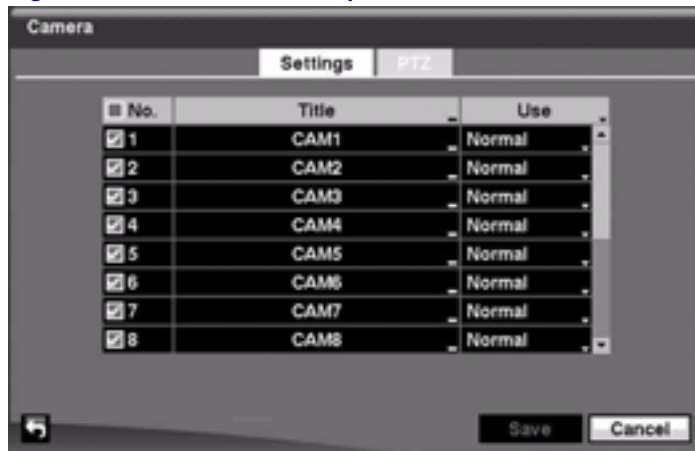

To turn the camera number **On** or **Off**, select the field under **No.** and press \odot .

To change the Title of each camera, highlight the name under the **Title** column and use the virtual keyboard.

To determine which cameras display on the monitors, select **Normal**, **Covert 1**, or **Covert 2** from a drop-down list in the **Use** column.

Note If you select **Covert 1**, the DVR displays the camera title and status icons on the covert video.

If you select **Covert 2**, the DVR displays only the camera title on the covert video.

Note A user who does not have Covert Camera View authority cannot view video from cameras set to **Covert 1** or **Covert 2**. This applies to both the live monitoring mode and the playback.

Adding a Camera to the PTZ List

1. Highlight the **PTZ** tab, and the PTZ setup screen displays.

Figure 3-34 Camera PTZ Setup Screen



Note You can only set up PTZ devices if the PTZ port is set to **RS-232C** or **RS485**. You can not use a modem if you are using the RS-232C port for PTZ control.

2. Highlight the field in the **Product** column for the PTZ camera you wish to configure and press . A list of PTZ devices appears.

Figure 3-35 PTZ Device List

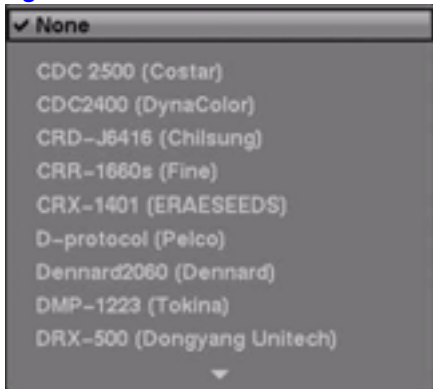

3. Select your camera from the list and press **↵**. You need to connect the camera to the RS-232C or RS485 connector on the back of the DVR following the camera manufacturer's instructions.
4. Assign an ID to the camera by highlighting the field under the **ID** heading and pressing **↵**. Change the number by highlighting it and using the **Up** and **Down** arrows to increase and decrease the number. The PTZ ID number can be set from **0** to **256**.

Configuring a PTZ Camera in the Port Setup Window

After selecting a Port in the PTZ tab, you can configure PTZ up to 16 cameras.

1. Highlight the **Setup...** field and press **↵**. The Port Setup window appears.

Figure 3-36 Port Setup Window

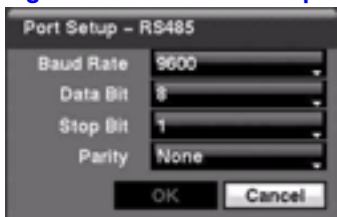

2. Configure the port settings based on the PTZ camera manufacturer's instructions.
3. Save your Camera changes by highlighting **Save** and pressing **↵**. Select **Cancel** to exit the screen without saving the changes.

Audio Setup Screen

The DVR can record up to two audio inputs. You can assign a camera to each audio input.

1. Highlight **Audio** in the Devices menu and press **↵**. The Audio setup screen appears.

Figure 3-37 Audio Setup Screen

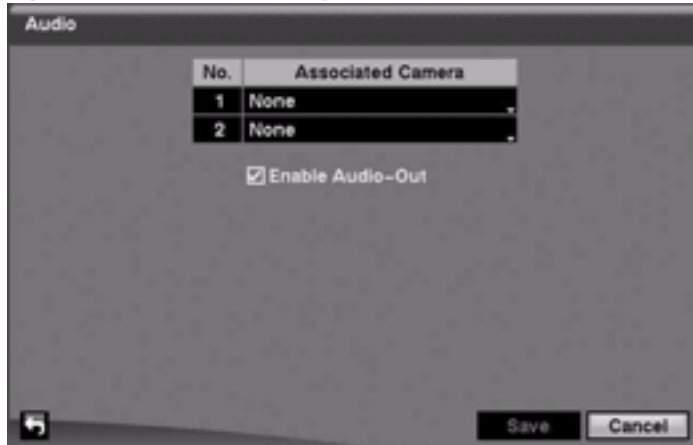

2. Highlight the field beside the input and press \leftarrow . A list of cameras appears, and you can select which camera you want associated with that audio input.
3. Highlight **Enable Audio-Out** and press \leftarrow to toggle between enabling and disabling the audio out feature.

Note The DVR does *NOT* record audio when the recording speed is set to less than 1 ips.

4. Save your Audio changes by highlighting **Save** and pressing \leftarrow . Select **Cancel** to exit the screen without saving the changes.

Alarm-Out Screen

The Alarm-Out screen allows you to change the settings and to establish a schedule for each alarm output from the back of the DVR.

Highlight **Alarm-Out** in the Devices menu and press \leftarrow . The Alarm-Out screen appears.

Figure 3-38 Alarm-Out Settings Screen



Table 3-9 Options in the Alarm-Out Settings Tab

Option	Action
Title	Each alarm output can be given its own title by highlighting the field under the Title heading and pressing F10 . A virtual keyboard appears with which you can enter the title.
Type	Highlight the fields under the Type heading to set the alarm output for NO or NC (normally open or normally closed).
Dwell Time	Highlight the field beside Dwell Time and press F10 to set the dwell time of the alarm output. Dwell times range from 5 seconds to 15 minutes .

Creating a Schedule for Alarm-Out

Highlight the **Schedule** tab. The Alarm-Out Schedule screen displays.

Figure 3-39 Alarm-Out Schedule Screen



You can add and edit alarm output schedules using this screen.

Table 3-10 Alarm-Out Schedule Options

Option	Action
+	Highlight the + and press $\left(\frac{1}{n}\right)$ to add a schedule. Highlight the fields under the Column headings (Day, Range, Mode, Channels) and press $\left(\frac{1}{n}\right)$ to edit the information in those fields.
Day	Use the Day field to select the days that the alarm schedule are active. The choices are: Sun, Mon, Tue, Wed, Thu, Fri, Sat, M~F, Hol, and All .
Range	Use the Range field to set the time, in 15-minute increments from 00:00 to 24:00 , that the alarm schedule is active.
Mode	Use the Mode field to set how the alarm reacts during the scheduled time. When set to On , the Alarm-Out is active during the scheduled time. When set to Event , the Alarm-Out is only active when there is an Event during the scheduled time.
Channels	Use the Channels field to set which alarm outputs are active. You can also turn On and Off the internal buzzer for the DVR.
X	Use the X field to delete an alarm output schedule. You are asked to confirm whether or not you really wish to delete the schedule.

Save your Alarm-Out changes by highlighting **Save** and pressing $\left(\frac{1}{n}\right)$. Select **Cancel** to exit the screen without saving the changes.

Display Screen

The Display screen allows you to select what information is displayed on the monitor.

Highlight **Display** in the Devices menu and press $\left(\frac{1}{n}\right)$.

Figure 3-40 Display OSD Screen



To toggle an item **On** and **Off**, highlight it and press \odot/\oplus . When an item is **On**, there is a checkmark in the box beside it. The following items can be turned **On** or **Off**:

Zoom	displays on the enlarged video.
Network	displays when the unit is connected to a network via either Ethernet or modem.
Freeze & Sequence	displays when the DVR is in Freeze mode, and the icon displays when the DVR is in Sequence mode.
Screen Group	The number of screen group displays when the DVR is not in the 4x4 display mode of the 16-channel DVR, and 3x3 mode of the 8-channel DVR.
Free Space	displays when the DVR is in the Recycle mode. The percentage of available storage space displays when the DVR is not in the Recycle mode.
Date/Time	Displays the current date and time information.
User Name	Displays the name of the current user who is logged in.
Camera No.	Displays the camera number at the top-left corner of each camera screen.
Camera Title	Displays the camera title at the top-left corner of each camera screen.
Record	The record related icons display on each camera screen.
PTZ	displays on each PTZ camera screen.
Text-In	The text input strings display on the screen. You can adjust the Display Dwell time (sec.) for the text input strings displayed on the screen.

Adjusting the Transparency of the On-Screen Display

To adjust the transparency of the setup screens, highlight **Transparency** and use the **Left** and **Right** arrows to select a value.

Adjusting the On-Screen Display Margins

To display how OSD text appears on the monitor, highlight **OSD Margin...** and press **F7**. The OSD Margin screen appears.

Figure 3-41 OSD Margin Screen



Use the horizontal and vertical sliders to adjust the horizontal and vertical margins so that text and icons are not hidden beyond the edges of the monitor.

Setting Up Sequences for the Display Main Monitor

On the Main Monitor tab you can make the following adjustments:

- adjust the display dwell time for each camera displayed on the main monitor
- define the screen layout in a variety of formats
- set the DVR to sequence through the different screen layouts (pages) so that all the cameras are displayed
- set up the DVR to display one camera or a group of cameras all the time while cycling through the remaining cameras in a Cameo window

Highlight the **Main Monitor** tab to switch to the Sequence screen.

Figure 3-42 Main Monitor Screen



Selecting the Display Sequence for the Main Monitor

If you press and hold **SEQUENCE** for two seconds or longer, the DVR sequences the cameras displayed on the monitor. The DVR has two sequence modes: Full and Cameo.

1. Highlight the field beside **Mode** and press **F7**.

2. Select between **Full Sequence** and **Cameo Sequence**.

In the Full Sequence mode, the DVR sequences through the cameras and displays them full screen.

In the Cameo Sequence mode, the bottom right window in a multi-screen format sequences through the cameras.

Note Any cameras that are **Off**, have lost video, or are set to **Covert** (unless the user has authority to view covert cameras) are excluded from the Cameo sequence.

Defining the Screen Layout

You can define the screen layout in a variety of formats and set the DVR to sequence through the different screen layouts (pages) so that all the cameras are displayed.

You can also set up the DVR to display one camera or a group of cameras all the time while cycling through the remaining cameras in a Cameo window. This can be done with one camera displayed full screen while displaying the cameo window as a PIP (picture in picture), or displaying the cameras in a grid pattern with the bottom right window as the cameo.

Note Sequence cannot be used in the 4x4 display mode of the 16-channel, and 3x3 mode of the 8-channel DVR.

Adjusting the Display Dwell Time

1. Highlight the field beside **Interval** in the Main Monitor screen and press $\left(\frac{*}{n}\right)$. You can select dwell intervals ranging from **1** second to **1** minute.
2. Highlight **Event Monitoring On** in the Main Monitoring screen and press $\left(\frac{*}{n}\right)$ to toggle between **On** and **Off**. When set to **On**, the DVR displays the camera associated with the event when an event occurs.

Defining Which Cameras Display Sequentially on the Spot Monitor

1. Highlight the **Spot Monitor** tab to switch to the Spot Monitor screen.

Figure 3-43 Spot Monitor Screen



2. Highlight the field in the **Channels** column and press \leftarrow . The Spot Monitor 1: Channels screen appears.
3. Select the cameras you want in the sequence by using the **UP** and **DOWN** arrows to scroll through the list. Press \leftarrow to toggle the cameras **On** and **Off**.
4. Select the Dwell time by highlighting that field and pressing \leftarrow . You can select from **1** to **20** seconds.

Save your Display settings by highlighting **Save** and pressing \leftarrow . Select **Cancel** to exit the screen without saving the changes.

Remote Control Screen

With the Remote Control Setup screen, you can select a port and make correct settings for a remote keyboard.

1. Highlight **Remote Control** in the Devices menu and press \leftarrow .

Figure 3-44 Remote Control Setup Screen

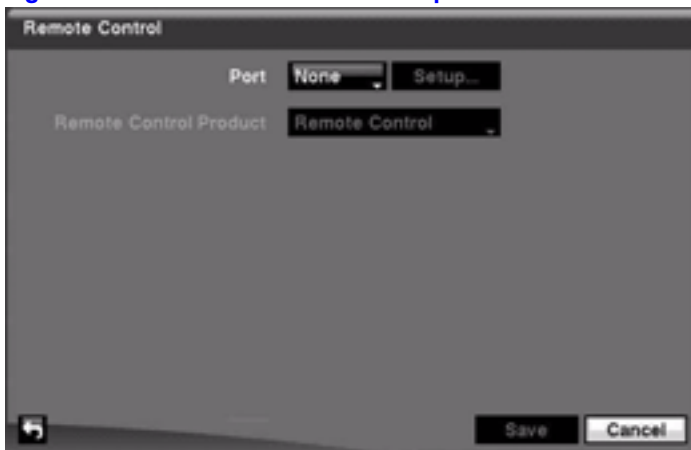

2. Highlight the field beside **Port** and select from **None**, **RS-232C**, and **RS485**. If the RS-232C port and RS485 port are in use for PTZ control, networking, or text input, the remote keyboard cannot be configured.
3. Highlight **Setup...** and select the correct Baud Rate, Parity, Data Bits and Stop Bits for the device you are connecting to the DVR.
4. Highlight the field beside **Remote Control Product** and select the device from the list.

Save your Remote Control settings by highlighting **Save** and pressing . Select **Cancel** to exit the screen without saving the changes.

Recording Settings

Your DVR offers a variety of flexible recording modes. You can set it to:

- record all the time
- record only events
- continue recording once the hard disk drive is full by recording over the oldest video
- stop recording and alert you when the hard disk is full

Figure 3-45 Record Menu

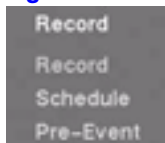

Record Screen





Highlight **Record** in the Record menu and press . The Record setup screen appears.

Figure 3-46 Record Setup Screen



Table 3-11 Record Setup Screen Options

Option	Action
Recycle	<p>Highlight Recycle and press  to toggle between On and Off.</p> <p>In the Recycle mode, the DVR records over the oldest video data when all available storage space has been used.</p> <p>When Recycle is turned Off, the DVR stops recording when all available storage space has been used.</p>
Resolution	<p>Highlight the Resolution field and select from High and Standard. If all other variables are equal, then selecting High resolution decreases the recording and playback speed by half that of Standard resolution.</p>
Event Record Dwell	<p>Highlight the Event Record Dwell field and set the length of time you would like to record for the associated event. You can set the dwell from 5 seconds to 15 minutes.</p> <p>See <i>Event Settings</i> on page 76 in this chapter for information regarding event recording.</p>
Auto Deletion	<p>Highlight the slide bar beside Auto Deletion, and use the Left and Right arrows to adjust the length of time recorded data is kept from Never to 1 to 99 days.</p> <p>The DVR automatically deletes video recorded earlier than the user-defined period under three conditions: at midnight, whenever the system reboots, or whenever the user changes the Auto Deletion settings.</p> <p>Selecting Never disables the Auto Deletion function.</p>
Use Panic Recording	<p>Highlight Use Panic Recording and press  to toggle between On and Off.</p>
<p>Note The following three options are only active if the Use Panic Recording option is active.</p>	
Panic Recording - Duration	<p>Highlight the Panic Recording - Duration field and set the duration of panic recording. You can set the dwell from No Limit to 5 minutes to 1 hour.</p> <p>Panic recording stops automatically after the preset duration as long as the PANIC button is not pressed to stop the panic recording.</p> <p>Select No Limit if you want to stop panic recording manually.</p>
Panic Recording - ips	<p>Highlight the Panic Recording - ips field and press  to set the images per second for Panic recording. You can select from 0.10 to 30.0 images per second (ips).</p>
Panic Recording - Quality	<p>Highlight the Panic Recording - Quality field and press  to set the recorded image quality for Panic recording. You can select from: Very High, High, Standard, and Basic.</p>

Save your Record settings by highlighting **Save** and pressing the **(F10)** button. Select **Cancel** to exit the screen without saving the changes.

Schedule Screen

Using the Schedule screen, you can program the DVR to record only during certain times based on time, day of the week, and holidays. The smallest time segment you can use is 15 minutes.

Scheduling Recording Times

Highlight **Schedule** in the Record menu and press **(F10)**. The Schedule setup screen appears.

Figure 3-47 Schedule Setup Screen

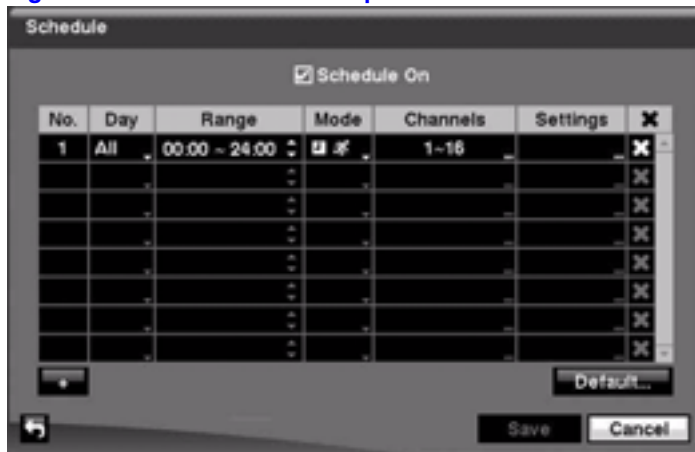

Option	Action
--------	--------

Schedule On	Highlight Schedule On and press (F10) to toggle between On and Off . In the Schedule On mode, the DVR records video based on the schedule established in the Schedule screen.
--------------------	------------------------------------------------------------------------------------------------------------------------------------------------------------------------------------------------------------------

Warning! The DVR stops recording when you turn off the schedule.

When you turn Schedule recording **Off**, you are asked to confirm your decision. After you confirm,  displays at the top-left corner of each camera screen to indicate that the schedule is turned off.

The Panic recording works even when **Schedule** is turned off.  displays during panic recording.

+	Highlight the + and press (F10) to add a schedule item.
----------	-----------------------------------------------------------------------

Day	Highlight the field under the Day heading and press (F10) to change the days that the scheduled recording takes place. Choose from: Sun, Mon, Tue, Wed, Thu, Fri, Sat, M~F, Hol, and All .
------------	------------------------------------------------------------------------------------------------------------------------------------------------------------------------------------------------------------------------









Option	Action
Range	Highlight the field under the Range heading and press $\left(\frac{\text{V}}{\text{H}}\right)$ to change the time range that the scheduled recording takes place. The schedule is based on a 24-hour clock, and the smallest time segment you can use is 15 minutes.
Mode	<p>Highlight the field under the Mode heading and press $\left(\frac{\text{V}}{\text{H}}\right)$ to change the recording mode that is used. Choose from: No Record, Time, Event, and Time & Event.</p> <p>When the DVR is in the No Record mode, it does not record during the preset day and time range as long as the PANIC button is not pressed. Use the No Record mode when you do <i>NOT</i> want the DVR to record during certain times.</p> <p>When the DVR is in the Time mode, the  icon displays at the top-left corner of the screen. The DVR records, and displays the  icon at the top-left corner of the screen during the scheduled times.</p> <p>When the DVR is in the Event mode, the red  icon displays at the top-left corner of the screen. The DVR records and displays the  icon at the top-left corner of the screen when any event occurs.</p> <p>When the DVR is in the Pre-Event recording mode, the yellow  icon displays when there is no event and the DVR is not recording.</p> <p>When the DVR is in the Pre-Event mode, the red  and  display when any event occurs and the DVR starts recording.</p> <p>When the DVR is in the Time & Event mode, the DVR follows the Time settings and the  icon displays. The DVR follows the Event settings and the  icon displays.</p>
Channels	Highlight the field under the Channels heading, and press $\left(\frac{\text{V}}{\text{H}}\right)$ to select which cameras record during that scheduled time.
Settings	Highlight the field under the Settings heading, and press $\left(\frac{\text{V}}{\text{H}}\right)$ to define the recording settings. You can set the ips and Quality of the recording for any modes you set up in the Mode column. If you do not set the ips and Quality in the Settings column, the DVR follows the default settings. See <i>Setting Recording Defaults</i> on page 74 for details.
✘	Highlight the field under the ✘ heading and press $\left(\frac{\text{V}}{\text{H}}\right)$ to delete the recording settings. You are asked to confirm that you want to delete the settings.
Default...	Highlight Default... and press $\left(\frac{\text{V}}{\text{H}}\right)$. The Default Setup screen appears.

Figure 3-48 Default Setup Screen



Setting Recording Defaults

1. Highlight the fields under **ips** and press $\left(\frac{\text{V}}{\text{H}}\right)$ to set the images per second for Time and Event recording. You can select from a range of **0.10** to **30.0** images per second.

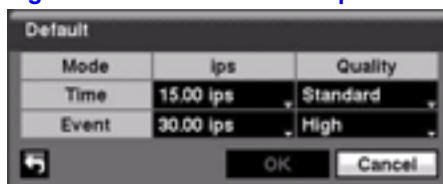
2. Highlight the fields under **Quality** and press $\left(\frac{1}{2}\right)$ to set the recorded image quality for Time and Event recording. You can select from: **Very High**, **High**, **Standard**, and **Basic**.
3. Select **OK** and press $\left(\frac{1}{2}\right)$ to load your default settings.
4. Save all of your changes to the schedule by highlighting **Save** and pressing $\left(\frac{1}{2}\right)$. Select **Cancel** to exit the screen without saving the changes.

Pre-Event Screen

Highlight **Pre-Event** in the Record menu and press $\left(\frac{1}{2}\right)$. The Pre-Event setup screen appears.

Figure 3-49 Pre-Event Setup Screen



If you do not have Event set up in the Record Schedule, an alert message displays.

When the DVR is in the Event Record mode, it is possible to have it record images before the event occurs. The Pre-Event screen allows you to define how to handle pre-event recording.

In the Pre-Event setup screen, you can do the following:

- Turn individual cameras **On** or **Off** for pre-event recording
- Set the image speed from a range of **0.10** to **30.00** ips (25.00 ips PAL)
- Set the image quality to **Very High**, **High**, **Standard**, or **Basic**.
- Set the amount of time to record prior to the event by adjusting the Dwell time
- Set the Dwell duration from a range of **5 seconds** to **30 minutes**. The maximum number of images per second is affected by Dwell time; the longer the Dwell is set, the fewer the maximum ips can be set.

Note When the DVR is in the Time or Time & Event mode, it ignores the pre-event settings and follows the time settings.

Save your changes by highlighting **Save** and pressing **↵**. Select **Cancel** to exit the screen without saving the changes.

Event Settings

Your DVR can be set to detect many different events. You can also determine how it reacts to these events.

The **Settings** tab for each of the events settings screen is different. But for each type of event setting, the **Actions 1** and **Actions 2** tab settings are the same.

On the **Actions 1** tab, you can choose which camera or cameras you want recorded with that event. You can set what the DVR does when an alarm output is detected, which can include an internal DVR buzzer. You can also set notification actions.

On the **Actions 2** tab, you can select PTZ (pan, tilt, zoom) presets for each camera and you can assign spot monitors to cameras.

Figure 3-50 Event Menu



Alarm-In Screen

The alarm terminal strip on the back of the DVR has inputs associated with each alarm. You can set up each input on the Alarm-In screen.

Highlight **Alarm-In** in the Event menu and press **↵**. The Alarm-In Settings Setup screen appears.

Figure 3-51 Alarm-In Settings Screen





In the Alarm-In Settings tab, you can:

- select which alarm-in devices are active
- name the individual alarm-in device
- change the settings for each input (**NO** or **NC**)
- select alarm input associated with panic recording



Initial settings

To turn each input **On** or **Off**, highlight the alarm number and press .

To give each input a title, highlight the desired **Title** field and press . A virtual keyboard appears with which you can enter a title name.

Each input can be set as **NO** (normally open) or **NC** (normally closed). Highlight the Type field, and press  to toggle between **On** and **Off**.

You can set the DVR to start panic recording whenever the DVR senses an input from one of the alarm input connectors.

1. Highlight the field beside Panic Record, and press . A list of alarm inputs appears.
2. Select which alarm input you want associated with panic recording by scrolling with the **UP** and **DOWN** arrows, then press .

Note If panic recording is triggered as a result of the settings from the Alarm-In menu, then the DVR continues recording until input on the selected alarm stops. You can also press **PANIC** on the DVR to stop panic recording.

Setting the DVR Actions in Response to Alarm Input

You can set the actions the DVR takes whenever it senses an input from the alarm input connectors.

In the **Alarm-In Actions 1** tab, you can choose the cameras, the Alarm-Out output connectors, and the notification actions for each Alarm-In input connectors.

In the **Alarm-In Actions 2** tab, you can choose PTZ camera preset positions and spot monitor actions.

Actions 1 Setup Screen

In the **Alarm-In Actions 1** tab, you can choose the cameras, the Alarm-Out output connectors, and the notification actions for each Alarm-In input connectors.

Highlight the **Actions 1** tab. The Actions 1 setup screens appear.

Figure 3-52 Alarm-In Actions 1 Setup Screen

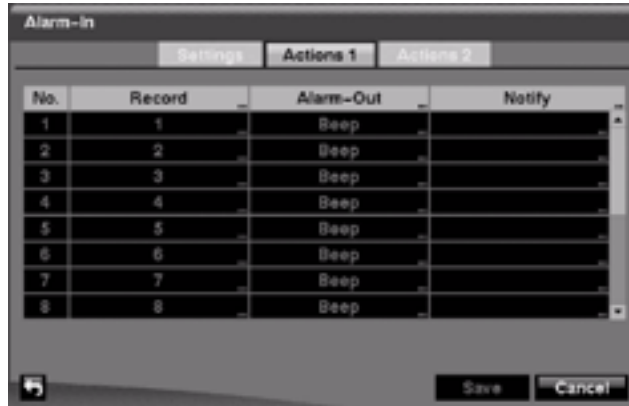

Selecting a Camera for Recording

1. Highlight the desired field under the **Record** heading, and press $\left(\frac{\triangleright}{\mu}\right)$. A list of cameras appears.
2. Select the cameras that you want the DVR to record when an associated alarm input is triggered.

Note For the Record action, the camera you select should be set to the **Event** or **Time & Event** recording mode in the Record Schedule setup screen.

Setting Alarm-Out Actions

1. Highlight the desired field under the **Alarm-Out** heading, and press $\left(\frac{\triangleright}{\mu}\right)$. The Alarm-In 1: Alarm-Out screen appears.
2. Select the Alarm Output connectors that you would like to activate whenever the DVR detects an input on the associated alarm input.
3. Turn **On** or **Off** the internal buzzer of the DVR. When set to **On**, the internal buzzer beeps when an event occurs.
4. Select **OK** and press $\left(\frac{\triangleright}{\mu}\right)$ to load the Alarm-Out Actions settings.

Note For the Alarm-Out action, the alarm output and beep you select should be set to the **Event** mode in the Alarm-Out setup screen (Schedule tab).

Setting Alarm-In Notifications

1. Highlight the desired field under the **Notify** heading, and press **F7**. The Alarm-In Notify menu appears.

Figure 3-53 Alarm-In Notify Menu

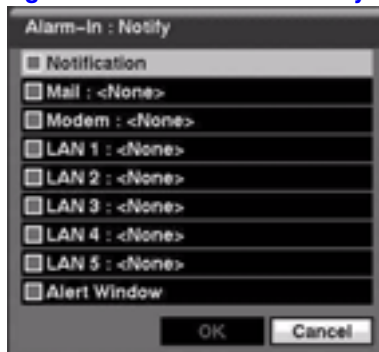

2. You can toggle the entire list **On** and **Off** by highlighting **Notification** and pressing **F7**.
You can toggle the individual items **On** and **Off** by highlighting them and pressing **F7**.
3. Highlight **OK** and press **F7** to accept your changes.

Note For the Notify action, the notify item you select should be enabled in the Notification setup screen, and the DVR should be registered in the RASplus (Remote Administration System).

Actions 2 Setup Screen

In the **Alarm-In Actions 2** tab, you can choose PTZ camera preset positions and spot monitor actions.

Highlight the **Actions 2** tab. The Alarm-In Actions 2 screen appears.

Figure 3-54 Alarm-In Actions 2 Screen



Selecting PTZ Presets

You can preset the position for each PTZ camera or where you want each PTZ camera to move whenever the DVR detects an input on the associated alarm input.

1. Highlight the desired field under the **PTZ** heading, and press \leftarrow/\rightarrow . A list of PTZ cameras appears.
2. Decide which camera you would like to associate with that Alarm-In input, and then set the preset by highlighting the field for that camera in the Preset column. Press \leftarrow/\rightarrow to open a list of Presets.
3. Scroll through the list using the **UP** and **DOWN** arrows, and then press \leftarrow/\rightarrow to select the preset.
4. Select the PTZ preset from the list.

Associating Spot Monitors with Cameras

A Spot monitor can be associated with a camera. The DVR displays the associated camera on the Spot monitor whenever it detects input on the associated alarm input.

1. Highlight the desired field under the **Spot Monitor** heading, and press \leftarrow/\rightarrow . A list of Spot monitors and cameras appears.
2. Select from the lists of spot monitors and cameras.
3. Select **OK** and press \leftarrow/\rightarrow to accept the changes.
4. Save your Alarm-In changes by highlighting **Save** and pressing \leftarrow/\rightarrow . Select **Cancel** to exit the screen without saving the changes.

Motion Detection Setup

Your DVR has built-in video motion detection. In the **Settings** tab, you can:

- adjust the sensitivity of the motion detection
- change the number of motion detection blocks
- watch how the DVR reacts to motion
- define the motion detection area
- set the daytime and nighttime ranges
- turn motion detection **On** and **Off** for each camera

In the **Motion Detection Actions 1** tab, you can choose the cameras, the Alarm-Out output connectors, and the notification actions for each Alarm-In input connectors.

In the **Motion Detection Actions 2** tab, you can choose PTZ camera preset positions and spot monitor actions.

Motion Detection Settings Tab

Highlight **Motion Detection** in the Event menu and press \odot . The Motion Detection setup screen appears.

Figure 3-55 Motion Detection Settings Screen

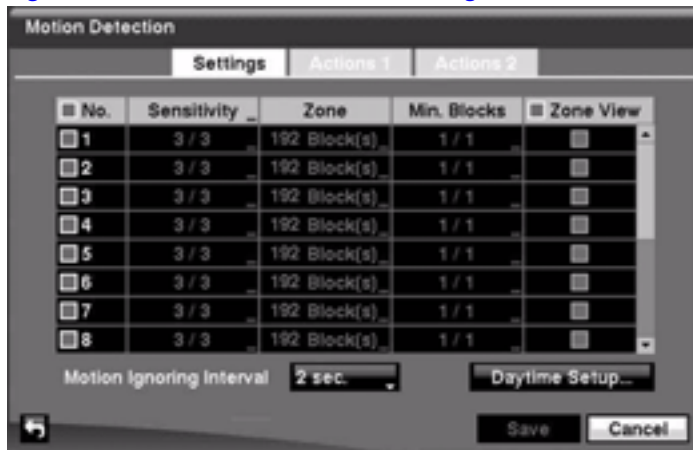

Adjusting the Sensitivity of the Motion Detection

You can independently adjust how sensitive the DVR is to motion for Daytime and Nighttime.

1. Highlight the field under the **Sensitivity** heading in the Motion Detection Settings screen and press \odot . The Motion Detection Sensitivity screen appears.

Figure 3-56 Motion Detection Sensitivity Screen

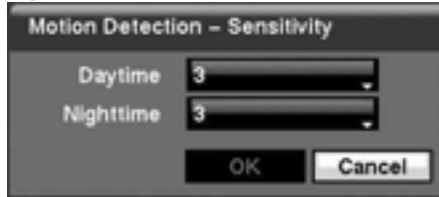

2. Choose a setting from the five settings. They range from **1** being the least sensitive to **5** being the most sensitive.

Defining the Motion Detection Area

You can define the area of the image where you want to detect motion. For example, you can choose to detect motion in and around a doorway.

1. Highlight the field under the **Zone** heading in the Motion Detection Settings screen, and press . The Motion Detection Zone screen appears.

Figure 3-57 Motion Detection Zone Screen

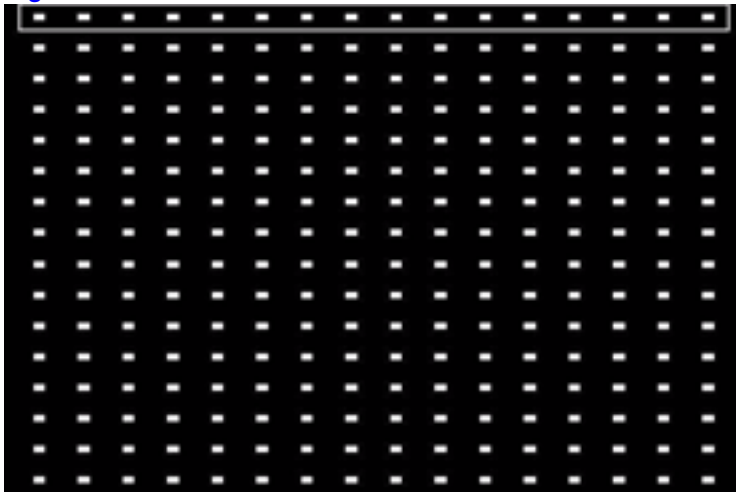

The Motion Detection Zone screen is laid over the video for the selected camera.

2. Select or clear blocks to set up the motion detection zones by pressing . The Motion Detection Zone Setup menu appears.

Figure 3-58 Motion Detection Zone Setup Menu



Note You can set up motion zones one block at a time in groups of 8 or 16 individual block groups (8- and 16-channel DVR respectively). Move a block group within the image area using the **UP** and **DOWN** arrows. Select and clear individual blocks within the block groups using the camera buttons.

Table 3-12 Motion Detection Zone Setup Screen Menu

Select	Activates highlighted blocks to detect motion.
Clear	Deactivates highlighted blocks so that they do not detect motion.
Reverse	Activates inactive highlighted blocks and deactivates active highlighted blocks.
Select All	Activates all blocks to detect motion.
Clear All	Deactivates all blocks so that they do not detect motion.
Reverse All	Activates inactive blocks and deactivates active blocks.
OK	Accepts changes and closes Zone setup.
Cancel	Exits Zone setup without saving changes.

Changing the Number of Motion Detection Blocks

You can adjust the minimum number of detection blocks that must be activated to trigger a motion alarm.

1. Highlight the field under the **Min. Blocks** heading in the Motion Detection Settings screen and press . The Motion Detection Min. Blocks screen appears.
2. Use the **UP** and **DOWN** arrows to independently adjust the minimum number of detection blocks for Daytime and Nighttime.

Smaller numbers provide greater sensitivity because fewer detection blocks must be activated.

Watching How the DVR Reacts to Motion

Turn Zone View **On** in the Motion Detection Settings screen to observe how the DVR reacts to motion. When in the motion viewing mode, any detected motion within the zone displays in red.

Adjusting the Motion Ignoring Interval

You can control excessive event logging and remote notification of motions detected after the motion dwell time by adjusting the motion ignoring intervals.

1. Highlight the field beside **Motion Ignoring Interval** in the Motion Detection Settings screen and press $\left(\frac{\uparrow}{\downarrow}\right)$. A list of intervals ranging from **1** to **10** seconds to **Never** appears.
2. Select a Motion Ignoring Interval from the list.
Now the DVR will not log and notify motion events that occurred during the preset interval range.

Setting Up Sensitivity Levels for the Daytime Range

1. Highlight the **Daytime Setup** field in the Motion Detection Settings screen and press $\left(\frac{\uparrow}{\downarrow}\right)$ to set up the Daytime range. The Daytime Setup Screen appears.

Figure 3-59 Daytime Setup Screen

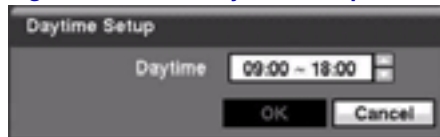

2. Highlight the field beside **Daytime** and press $\left(\frac{\uparrow}{\downarrow}\right)$.
3. Use the **UP** and **DOWN** arrows to set the Daytime range.
The DVR considers the remaining time range as the Nighttime.

Motion Detection Actions Tabs

Using the Actions 1 and Actions 2 tabs, you can set the DVR to react to motion detection differently for each camera. Each camera can:

- be associated with another camera
- trigger an Alarm-Out connector
- sound the internal buzzer of the DVR
- notify a number of different devices
- move PTZ cameras to preset positions
- and/or display a camera on a SPOT monitor

Actions 1 Tab settings

In the **Motion Detection Actions 1** tab, you can choose the cameras, the Alarm-Out output connectors, and the notification actions for each camera.

Highlight the **Actions 1** tab. The Motion Detection Actions 1 screen displays.

Figure 3-60 Motion Detection Actions 1 Screen

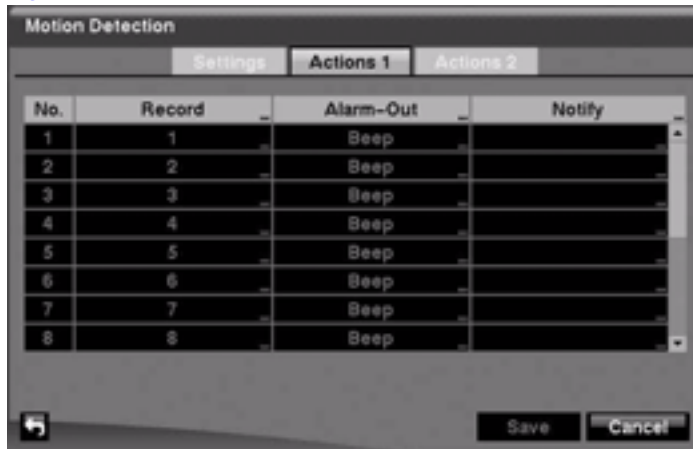

Note You can associate multiple cameras with a camera that detects motion.

Selecting a Camera or Cameras for Recording

1. Highlight the desired field under the **Record** heading, and press $\left(\frac{7}{H}\right)$. A list of cameras appears.
2. Select the cameras that you want the DVR to record when the DVR detects motion on the selected camera.

If the DVR detects motion on the selected camera, it starts recording video from all the associated cameras.

Note For the Record action, the camera you select should be set to the **Event** or **Time & Event** recording mode in the Record Schedule setup screen.

Setting Alarm-Out Actions

1. Highlight the desired field under the **Alarm-Out** heading, and press $\left(\frac{7}{H}\right)$. A list of Alarm Outputs and the toggle for the Beep appears.
2. Select the Alarm Output connectors that you would like to activate whenever the DVR detects motion on the selected camera.

You can also set the DVR internal buzzer to sound if motion is detected on the selected camera.

Note For the Alarm-Out action, the alarm output and beep you select should be set to the **Event** mode in the Alarm-Out setup screen (Schedule tab).

Setting Motion Detection Notifications

1. Highlight the desired field under the **Notify** heading, and press $\left(\frac{1}{2}\right)$. The Motion Detection Notify menu appears.
2. You can toggle the entire list **On** and **Off** by highlighting **Notification** and pressing $\left(\frac{1}{2}\right)$.
You can toggle the individual items **On** and **Off** by highlighting them and pressing $\left(\frac{1}{2}\right)$.
3. Highlight **OK** and press $\left(\frac{1}{2}\right)$ to accept your changes.

Note For the Notify action, the notify item you select should be enabled in the **Notification** setup screen and the DVR should be registered in the RASplus.

Actions 2 Tab settings

In the **Text-In Actions 2** tab, you can choose PTZ camera preset positions and spot monitor actions.

Highlight the **Actions 2** tab. The Motion Detection Actions 2 screen displays.

Figure 3-61 Motion Detection Actions 2 Screen



Selecting PTZ Presets

You can preset the position for each PTZ camera and to where you want each PTZ camera to move whenever the DVR detects motion on the selected camera.

1. Highlight the desired field under the **PTZ** heading, and press **↵**. The Motion Detection 1: PTZ setup screen appears.
2. Select the PTZ field next to the desired camera, and press **↵**. A list of PTZ presets appears.

Figure 3-62 PTZ Preset Screen



3. Select the PTZ preset from the list.
4. Select **OK** and press **↵** to load the settings.

Associating Spot Monitors with Cameras

A Spot monitor can be associated with a camera. The DVR displays the associated camera on the Spot monitor whenever it detects motion on the selected camera.

1. Highlight the desired field under the **Spot Monitor** heading, and press **↵**. A list of Spot monitors and cameras appears.
2. Select from the list of spot monitors and cameras.
3. Select **OK** and press **↵** to load the settings.

Save your Motion Detection changes by highlighting **Save** and pressing **↵**. Select **Cancel** to exit the screen without saving the changes.

Video Loss Screen

You can use the Video Loss function to see if anything is obscuring the camera.

The DVR can be set to react to video loss differently for each camera. Each camera can:

- be associated with other cameras
- trigger an Alarm-Out connector
- sound the DVR internal buzzer
- notify a number of different devices
- move PTZ cameras to preset positions
- and/or display a camera on a SPOT monitor

Setting the Sensitivity for Video Loss

1. Highlight **Video Loss** in the Event menu and press . The Video Loss setup screen appears.

Figure 3-63 Video Loss Settings Screen



2. Highlight the slider bar beside **Check Obscuration**, and use the **LEFT** and **RIGHT** arrows to adjust the setting. The sensitivity can be set from **Never** to **15** (extremely sensitive).

Actions 1 Tab settings

In the **Video Loss Actions 1** tab, you can choose the cameras, the Alarm-Out output connectors, and the notification actions for each camera.

Highlight the **Actions 1** tab. The Video Loss Actions 1 screen displays.

Figure 3-64 Video Loss Actions 1 Screen



Selecting a Camera or Cameras for Recording

You can set the DVR to start recording video from all the associated cameras if the DVR detects video loss on the selected camera.

1. Highlight the desired field under the **Record** heading, and press . A list of cameras appears.
2. Select the cameras that you want the DVR to record when video loss is detected. If the DVR detects video loss on the selected camera, it starts recording video from all the associated cameras.

Note For the Record action, the camera you select should be set to the **Event** or **Time & Event** recording mode in the Record Schedule setup screen (see [page 71](#)).

Setting Alarm-Out Actions

You can associate Alarm-Outs with a selected camera. When the DVR detects video loss on the selected camera, it triggers output signals on the associated Alarm-Out connectors. You can also have the DVR internal buzzer sound if video is lost on the selected camera.

1. Highlight the desired field under the **Alarm-Out** heading, and press . A list of Alarm Outputs appears.
2. Select the Alarm Output connectors that you would like to activate whenever the DVR detects video loss on the selected camera.
3. Select **OK** and press to accept the changes.

Note For the Alarm-Out action, the alarm output and beep you select should be set to the Event mode in the Alarm-Out setup screen (Schedule tab).

Setting Video Loss Notifications

1. Highlight the desired field under the **Notify** heading, and press $\left(\frac{1}{n}\right)$. The Video Loss Notify menu appears.

Figure 3-65 Video Loss Notify Menu

2. You can toggle the entire list **On** and **Off** by highlighting **Notification** and pressing $\left(\frac{1}{n}\right)$.
You can toggle the individual items **On** and **Off** by highlighting them and pressing $\left(\frac{1}{n}\right)$.
3. Highlight **OK** and press $\left(\frac{1}{n}\right)$ to accept your changes.

Note For the Notify action, the notify item you select should be enabled in the **Notification** setup screen and the DVR should be registered in the RASplus (Remote Administration System).

Actions 2 Tab settings

In the **Video Loss Actions 2** tab, you can choose PTZ camera preset positions and spot monitor actions.

Highlight the **Actions 2** tab. The Video Loss Actions 2 screen displays.

Figure 3-66 Video Loss Actions 2 Screen



Selecting PTZ Presets

You can preset the position for each PTZ camera and to where you want each PTZ camera to move whenever the DVR detects video loss on the selected camera.

1. Highlight the desired field under the **PTZ** heading, and press **F4**. A list of PTZ presets appears.
2. Select the PTZ preset from the list.

Associating Spot Monitors with Cameras

A Spot monitor can be associated with a camera. The DVR displays the associated camera on the Spot monitor whenever it detects video loss on the selected camera.

1. Highlight the desired field under the **Spot Monitor** heading, and press **F4**. A list of Spot monitors and cameras appears.
2. Select from the list of spot monitors and cameras.

Save your Video Loss changes by highlighting **Save** and pressing **F4**. Select **Cancel** to exit the screen without saving the changes.

Text-In Screen

Using the Text-In screen, the DVR can be set to react to text input from devices such as ATMs (Automated Teller Machines) and POS (Point of Sale; for example, cash registers). You can configure the DVR for each text-in device using this screen.

Highlight **Text-In** in the Event menu and press **F4**. The Text-In setup screen appears.

Figure 3-67 Text-In Settings Screen



Highlight the field under the **Setup** heading, and press **F4**. Selecting the **Setup** heading changes all the parameters, excluding Port settings, of all the text input channels.

Note The system performance can be affected when a large quantity of text inputs are detected from several channels at the same time.

Note VP Filter, Generic Text, and EPSON-POS devices are currently supported.

1. Highlight the field beside **Port** and press $\left(\frac{1}{2}\right)$. Select from **None**, **RS-232C**, **RS485**, and **USB-Serial (1~8)**. The Setup field becomes active.

Note If you have set the Port as **None**, you cannot make any changes to the screen.

Note When using the USB to serial text-in device, do *NOT* remove the USB cable from the port while the system is running.

2. Highlight **Setup...** and press $\left(\frac{1}{2}\right)$. The Port Setup screen appears.

Figure 3-68 Port Setup Screen



3. Use the ATM or POS manufacturer's recommended settings when configuring the RS-232C, RS485 or USB-Serial ports. You need to know the Baud Rate, Data Bit number, Stop Bit number, and Parity. Highlight **OK** and press $\left(\frac{1}{2}\right)$ to load the settings.
4. Highlight the field beside **Text-In Product** and press $\left(\frac{1}{2}\right)$. Select your device from the list.

Note The screen changes for different types of text input devices, so there are different parameter fields for you to enter information.

1. Highlight the field beside Virtual Port, and press $\left(\frac{?}{n}\right)$. Adjust the port number to use. This field is activate only when setting up the VP Filter device.
2. Highlight the field beside **Transaction Start** and press $\left(\frac{?}{n}\right)$. Use the virtual keyboard to enter the Transaction Start string. Refer to the device manufacturer's documentation for the text string that the device first sends when a transaction starts.
3. Turn on **Any Character** if you want the DVR to react to any character sent from the text input device. Highlight **Any Character** and press $\left(\frac{?}{n}\right)$ to toggle between **On** and **Off**.

Note If **Any Character** is turned **On**, you cannot enter any text in the Transaction Start field.

4. Highlight the field beside **Transaction End** and press $\left(\frac{?}{n}\right)$. Use the virtual keyboard to enter the Transaction End string. Refer to the device manufacturer's documentation for the text string that the device sends when a transaction ends.
5. Highlight the **more line(s)** field and press $\left(\frac{?}{n}\right)$. Select the number of additional lines of text that you want the DVR to record. You can choose from **0** to **10**.
6. Highlight the field beside **Line Delimiter** and press $\left(\frac{?}{n}\right)$. Use the virtual keyboard to enter the character(s) that the device uses to indicate the end of a line.
Special characters can be created using ^ and a capital letter: for example, ^J for NL (New Line), ^M for CR (Carriage Return). Refer to the device manufacturer's documentation for Line Delimiter character(s).
7. Highlight the field beside **Ignore String** and press $\left(\frac{?}{n}\right)$. Use the virtual keyboard to enter any strings of text that you want the DVR to ignore.
Refer to the device manufacturer's documentation for text strings that the device sends during transactions, so you know which ones you do not want recorded.
8. Highlight the **Case Sensitive** field and press $\left(\frac{?}{n}\right)$ to toggle between **On** and **Off**.
Refer to the device manufacturer's documentation to determine if the text strings are Case Sensitive. If the device distinguishes between upper and lower case letters, make certain the **Case Sensitive** field is turned **On**.
9. Highlight the field beside Time Out, and press $\left(\frac{?}{n}\right)$. Set the length of time to wait for the new text string. The DVR considers a transaction complete if no new text strings are entered between the last text input and the dwell time out. You can adjust the Time Out dwell from **5** seconds to **15** minutes.
10. Select **OK** and press $\left(\frac{?}{n}\right)$ to save settings.

Actions 1 Tab Settings

The DVR can be set to react to text input. Text input can:

- be associated with cameras
- trigger an Alarm-Out connector
- sound the internal buzzer of the DVR
- notify a number of different devices
- move PTZ cameras to preset positions
- and/or display a camera on a SPOT monitor.

Highlight the **Actions 1** tab. The Text-In Actions 1 screen displays.

Figure 3-69 Text-In Actions 1 Screen

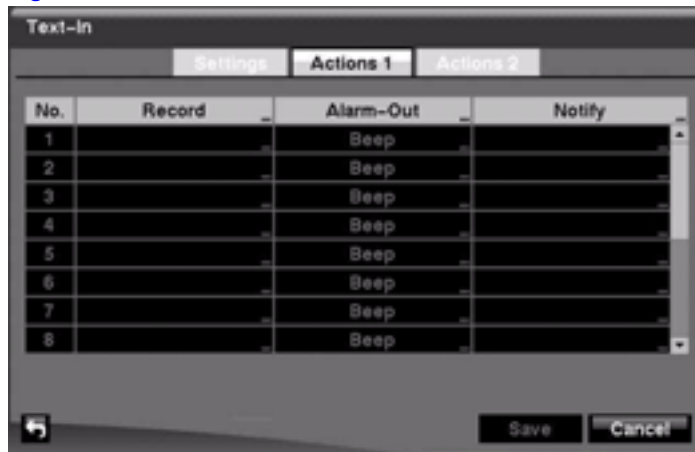

Selecting a Camera or Cameras for Recording

You can set the DVR to start recording video from all the associated cameras when the DVR detects text input on the selected cameras.

1. Highlight the desired field under the **Record** heading, and press . A list of cameras appears.
2. Select the cameras that you want the DVR to record when text input is detected.
If the DVR detects text input on the selected text-in device, it starts recording video from all the associated cameras.

Note For the Record action, the camera you select should be set to the **Event** or **Time & Event** recording mode in the Record Schedule setup screen.

Setting Alarm-Out Actions

You can associate Alarm-Outs with the Text Inputs. When the DVR detects text input on the selected text-in device, it triggers output signals on the associated Alarm-Out connectors. You can also have the DVR internal buzzer sound if text-input is detected.

1. Highlight the desired field under the **Alarm-Out** heading, and press $\left(\frac{1}{2}\right)$. A list of Alarm Outputs appears.
2. Select the Alarm Output connectors that you would like to activate whenever the DVR detects text input.

Note For the Alarm-Out action, the alarm output and beep you select should be set to the **Event** mode in the Alarm-Out setup screen (Schedule tab).

Setting Text-In Notifications

1. Highlight the desired field under the **Notify** heading, and press $\left(\frac{1}{2}\right)$. The Text-In Notify menu appears.
2. You can toggle the entire list **On** and **Off** by highlighting **Notification** and pressing $\left(\frac{1}{2}\right)$.
You can toggle the individual items **On** and **Off** by highlighting them and pressing $\left(\frac{1}{2}\right)$.
3. Highlight **OK** and press $\left(\frac{1}{2}\right)$ to accept your changes.

Note For the Notify action, the notify item you select should be enabled in the **Notification** setup screen and the DVR should be registered in the RASplus (Remote Administration System).

Actions 2 Tab Settings

In the **Alarm-In Actions 2** tab, you can choose PTZ camera preset positions and spot monitor actions.

Highlight the **Actions 2** tab. The Text-In Actions 2 screen displays.

Figure 3-70 Text-In Actions 2 Screen



Selecting PTZ Presets

You can preset the position for each PTZ camera and to where you want each PTZ camera to move whenever the DVR detects text input.

1. Highlight the desired field under the **PTZ** heading, and press $\left(\frac{1}{n}\right)$. A list of PTZ presets appears.
2. Select the PTZ preset from the list.

Associating Spot Monitors with Cameras

A Spot monitor can be associated with a camera. The DVR displays the associated camera on the Spot monitor whenever it detects text input.

1. Highlight the desired field under the **Spot Monitor** heading, and press $\left(\frac{1}{n}\right)$. A list of Spot monitors and cameras appears.
2. Select from the list of spot monitors and cameras.

Save your **Text-In** changes by highlighting **Save** and pressing $\left(\frac{1}{n}\right)$. Select **Cancel** to exit the screen without saving the changes.

System Event Screen

Using the System Event screen, the DVR can be configured to run self-diagnostics and report the results. You can set the DVR to check the system, recording, and Alarm-In activities.

Highlight **System Event** in the Event menu and press $\left(\frac{1}{n}\right)$. The System Event - Health Check setup screen appears.

Figure 3-71 Health Check Screen



Setting an Automatic System Self-Check Schedule

Using the **UP** and **DOWN** arrows, highlight the field beside System and press $\left(\frac{\uparrow}{\downarrow}\right)$. Select how often you want the DVR to self-check by selecting from the range of **1 hr.** to **30 days** or **Never**.

Setting an Automatic Recording Self-Check Schedule

1. Highlight **Setup...** beside **Check Recording** and press $\left(\frac{\uparrow}{\downarrow}\right)$. The Check Recording screen appears.

Figure 3-72 Check Recording Screen



2. Highlight **Schedule On** and press $\left(\frac{\uparrow}{\downarrow}\right)$ to toggle the schedule **On** and **Off**. When set to **On**, the rest of the Check Recording screen becomes active.
3. Select **+** to add a setting to the Check Recording schedule. A new schedule appears in the table.

You can set the day, time range, and interval that you want the DVR to run self-diagnostics on the recorder. The Interval ranges from **1 min.** to **7 days** or **Never**.

4. Select the Day field and press $\left(\frac{1}{11}\right)$ to change the day. A menu appears with choices from individual days from **Sunday to Saturday, Monday-Friday, Holidays**, and **All**. Scroll to choose the setting, and press $\left(\frac{1}{11}\right)$ to select.
5. Select the Range field and press $\left(\frac{1}{11}\right)$ to change the time range. The Range uses a 24-hour clock, and adjusts in 15 minute increments.
6. Highlight the Interval field, and press $\left(\frac{1}{11}\right)$ to change the interval that you want the DVR to run self-diagnostics on recording. A list appears from which you can select **1 hr. to 30 days** or **Never**.
7. Select **X** to delete a schedule.
8. Select **OK** and press $\left(\frac{1}{11}\right)$ to save the changes.

Setting an Automatic Alarm-In Check

Select the Alarm-In port you want to check by highlighting the corresponding field in the Interval column and pressing $\left(\frac{1}{11}\right)$. A list appears from which you can select **1 hr. to 30 days** or **Never**.

Setting Up Automatic Storage Check-Up

Highlight the **Storage** tab. The System Event Storage screen displays.

Figure 3-73 Storage Screen



Checking for Bad Sectors on the Disk

1. Highlight the field beside **Disk Bad Notify** and press $\left(\frac{1}{11}\right)$.
2. Select the percentage level of bad disk sectors at which you want the DVR to trigger an alert. Percentage levels range from **10% to 90%**.

Setting a Disk Almost Full Notification

1. Highlight the field beside **Disk Almost Full Notify** and press $\left(\frac{1}{11}\right)$.
2. Select the percentage level of disk usage at which you want the DVR to trigger an alert. Percentage levels range from **80% to 99%**.

Setting up Disk S.M.A.R.T. (Self-Monitoring Analysis and Reporting Technology)

1. Highlight the **Setup...** field beside Disk S.M.A.R.T., and press **F10**. The S.M.A.R.T. Setup screen appears.

Figure 3-74 S.M.A.R.T Setup Screen

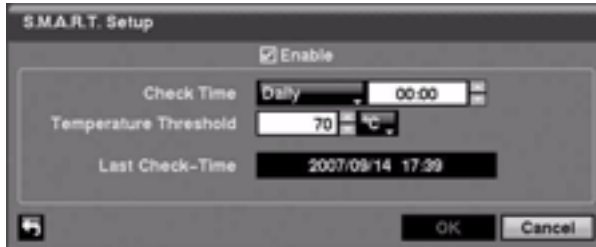

2. Highlight **Enable** and press **F10** to toggle between **On** and **Off**.

Note If Enable is turned **Off**, you are not be able to make changes to any of the fields.

3. Highlight the field beside **Check Time** and press **F10**. You can select from **Monthly**, **Weekly**, and **Daily**.
 If you select **Monthly**, you are asked to set the Day of the Month and the Time.
 If you select **Weekly**, you are asked to set the Day of the Week and the Time.
 If you select **Daily**, you are asked to set the Time.
4. Highlight the first field beside **Temperature Threshold** and press **F10**. Use the **UP** and **DOWN** arrows to scroll through the numbers. Refer to the hard disk drive manufacturer's documentation for the correct temperature setting.
 If the temperature of hard disk drive exceeds the defined threshold, the system triggers an alert.
5. Highlight the second field beside **Temperature Threshold** and press **F10**. Select either **°C** (Celsius) or **°F** (Fahrenheit), and press **F10**.
 The field beside **Last Check-Time** displays the Date and Time of the last S.M.A.R.T. check.
6. Highlight **OK** and press **F10** to accept the changes. Select **Cancel** to exit the screen without saving the changes.
7. Select **Save** and then press **F10** to save your changes.

Setting Up System Event Actions

The DVR can be set to react to system events. System events can:

- be associated with an Alarm-Out connector
- sound the DVR internal buzzer
- notify a number of different devices.

1. Highlight the **Actions** tab and the System Event Actions screen appears.

Figure 3-75 System Event Actions Screen



2. Highlight the **Alarm-Out** field beside the desired event (Check Recording, Check Alarm-In, Disk Almost Full, Disk Full, Disk Bad, Disk Temperature, or Disk S.M.A.R.T.), and press $\left(\frac{F}{N}\right)$. A list of Alarm Outputs appears.

You can associate as many Alarm-Outs with the Event as you wish.

If the DVR detects that event, it triggers output signals on all the associated Alarm-Out connectors. You can also have the DVR internal buzzer sound if an event is detected.

Note Alarm-Out action cannot be set to System and Panic Record events

3. Highlight the **Notify** field beside the desired event (System, Panic Record, Check Recording, Check Alarm-In, Disk Almost Full, Disk Full, Disk Bad, Disk Temperature, or Disk S.M.A.R.T.), and press $\left(\frac{F}{N}\right)$.
4. Turn the entire list **On** or **Off** by highlighting **Notification** and pressing $\left(\frac{F}{N}\right)$. Turn the individual items **On** or **Off** by highlighting them and pressing $\left(\frac{F}{N}\right)$.
5. Highlight **OK** and press $\left(\frac{F}{N}\right)$ to accept your changes.

Note **Mail Notify** is the only option available for the System event.

Note For the Notify action to work, the DVR should be registered in the RASplus (Remote Administration System).

- Save your System Event changes by highlighting **Save** and pressing **F10**. Select **Cancel** to exit the screen without saving the changes.

Event Status Screen

The Event Status screen displays the status of the DVR systems and inputs. Events are highlighted, and related channels or events flicker for five seconds when detected.

Highlight **Event Status** in the Event menu and press **F10**. The Event Status screen appears.

Figure 3-76 Event Status Screen



Alarm-In, **Motion**, **Video Loss** and **Text-In** highlight when each event is detected based on the settings you made in the Alarm-In, Motion Detection and Text-In setup screens on the Event menu.

Check Alarm-In and **Check Recording** highlight when each event is detected based on the settings you made in the System Event setup screen on the Event menu.

Panic Record highlights while the DVR is in the panic recording mode.

Disk Almost Full highlights when the DVR is not in the Recycle mode and the level of disk usage reaches the Disk Almost Full percentage you made in the System Event setup screen on the Event menu. **Disk Full** highlights when the DVR is not in the Recycle mode and all available storage space has been used.

Highlight the **Storage** tab to display the hard disk drive status. [Storage Screen](#) on page 42 for details.

4

Operation

Note This chapter assumes your DVR has been installed and configured. If it has not, please see *Chapter 2, Installation* and *Chapter 3, Configuration*.

The DVR controls are similar to a VCR. As with a VCR, the main functions are recording and playing back video. However, you have much greater control over recording and playing back video. You can establish recording schedules based on time of day and day of the week. The DVR allows you to search through the recorded video using much more sophisticated tools than those available with VCRs. Additional DVR features that are not available with VCRs are remote control and viewing, and recording video at the same time you are watching previously recorded video.

Figure 4-1 DVR Front Panel and Controls

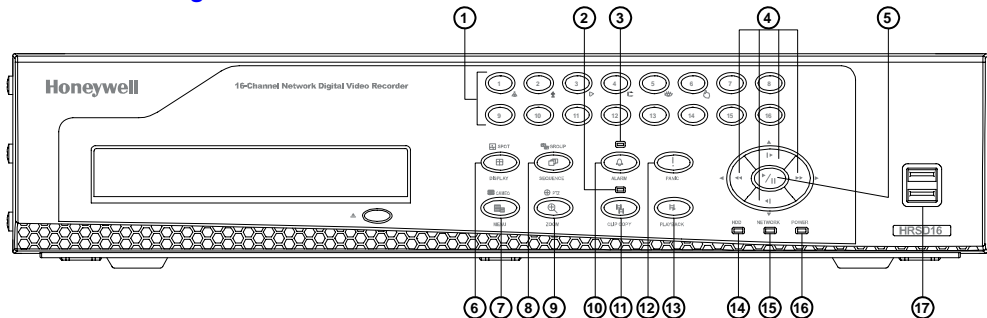

Table 4-1 Front Panel Controls

#	Function	#	Function	#	Function
1	Camera buttons (1-16)	2	Clip Copy LED	3	Alarm Out LED
4	Arrow Buttons	5	PLAY/PAUSE Button	6	DISPLAY/SPOT Button
7	MENU/CAMEO Button	8	GROUP/SEQUENCE Button	9	ZOOM/PTZ Button

Table 4-1 Front Panel Controls

#	Function	#	Function	#	Function
10	ALARM Button	11	CLIP COPY Button	12	PANIC Button
13	PLAYBACK Button	14	HDD LED	15	Network LED
16	Power LED	17	USB Connectors		

Turning on the Power

After installing the DVR (see *Chapter 2, Installation*), press **POWER** on the front panel to start recording video.

Live Monitoring

As soon as the DVR completes its initialization process, live video shows on the attached monitor. The default mode is to display all connected cameras at once.

To display live video full screen, press that camera button. The input of the chosen camera displays until you enter another mode.

To cycle the DVR through the different display formats, press **DISPLAY**.

The DVR can be set to display full-screen video for a preset dwell time when an Event occurs. Video from the lowest numbered camera associated with the event sensor is displayed. The DVR returns to the previous screen format after the event monitoring dwell time expires. While the event monitoring is activated, the monitoring for all other subsequent events are ignored.

To release the current event monitoring and display the selected camera or to return to the previous screen format, press individual camera buttons or **DISPLAY** during event monitoring.

Using PIP Mode

To display a Picture-in-Picture, press **DISPLAY** in the single-screen mode. You can change the location of the PIP counterclockwise and clockwise by pressing the **UP** and **DOWN** arrows. You can change the PIP size by pressing the **LEFT** and **RIGHT** arrows.

Active Cameo Mode

Turning On the Active Cameo Mode

There are two ways you can enter the Active Cameo mode:

- Press and hold **CAMEO** for two seconds or longer in any multi-view format.
OR
- Select **Edit Group** in the Mouse display menu.
A yellow outline appears around the video indicating the Active Cameo mode. To move the active cameo frame, press the arrow buttons.

Exiting the Active Cameo mode

There are two ways to exit the Active Cameo mode:



- Press  (Play/Pause).
OR
- Press **CAMEO** again, and then select **Exit Edit Group** in the cameo menu.
The active cameo mode remains in effect for 15 seconds if there is no further operation.

Changing the Screen Layout in Active Cameo Mode

1. Enter the Active Cameo mode.
2. Press the button for the camera you want to display in the active cameo. After setting the camera number to active cameo, the DVR moves the active cameo to the next cameo.

If...	Then...
The camera number exists on the current screen	The active cameo is changed with the existing camera number
The camera number does not exist on the current screen	The active cameo is replaced by the camera number

Freeze Mode

To freeze the current image on screen, press  (Play/Pause). This image remains on the screen until you press the button again. While in the Freeze mode, the  icon displays in the bottom-left corner if **Freeze** is selected in the Display setup screen (OSD tab).

Zoom Mode

You can enlarge an area of the video by pressing **ZOOM**. The  icon displays if **Zoom** is selected in the Display setup screen (OSD tab).

Selecting the Zoom Area

Press **ZOOM**. A rectangle displays on the screen for a few seconds. This rectangle selects the area to be enlarged.

Changing the Zoom Area

To change the zoom area, move the rectangle around using the arrow buttons. To enlarge the zoom area in the Zoom mode, press . To exit the Zoom mode, press **ZOOM** again.

Adjusting the Image

Note It is important that cameras and monitors are correctly installed and adjusted prior to making any image adjustments using the DVR controls.

If you have Color Control authority and are logged into the system, you can adjust brightness, contrast, hue and saturation for each camera.

Adjusting a Camera Image

1. Press and hold a camera button for a few seconds to display an image adjustment dialog.

2. Adjust the image using the arrows.
3. Load settings by selecting **OK** and pressing .

Note Any image adjustments you make are applied to both the live video on the monitors and the recorded video.

Browsing with Sequence Mode

Using the Sequence mode, you can browse through a series of single-view or multi-view formats, depending on which format you have chosen.

Entering the Sequence Mode

Press and hold **SEQUENCE** for two seconds or longer to display the cameras sequentially.

If you choose...	After you've pressed SEQUENCE , the DVR...
Full Sequence	Goes through predefined screen layouts
Cameo Sequence	Displays live cameras sequentially in the bottom right screen
One of the multi-view formats	Goes to the next page

For example, if you press **SEQUENCE** while in the 2x2 format, the DVR changes pages in the following pattern:

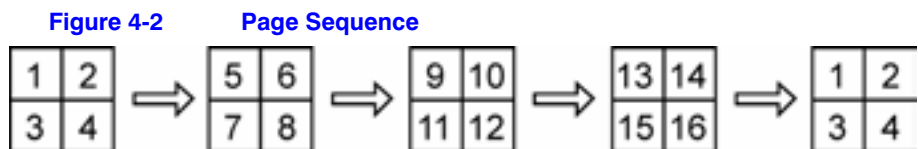

If all the cameras in a page are **Off**, have lost video, or are set to **Covert** (unless the user has authority to view covert cameras), then that page is excluded from the sequence.

Note In the Display setup screen (Sequence tab), select **Full Sequence** for full sequence monitoring or **Cameo Sequence** for cameo sequence monitoring.

Exiting Sequence Mode

Press **SEQUENCE** for two seconds or longer to exit the Sequence mode.

Using a Mouse During Live Monitoring

You can use a mouse instead of the front panel buttons to perform many of the DVR functions. The following operations are supported when using a mouse during live monitoring.

Table 4-2 Mouse Functions

Mouse Tool	Action
Left mouse button	When in one of the multi-view formats (for example, PIP, 2x2, 3x3 or 4x4), clicking this mouse button on a camera image switches that camera to full screen. Clicking the mouse button again returns to the previous multi-view format.
Mouse wheel	When in one of the multi-view formats, scrolling the mouse wheel up and down operates the same as pressing the DISPLAY button by switching the screen format between PIP, 2x2, 3x3 and 4x4.
Right mouse button	Clicking the right mouse button displays the menu seen in <i>Figure 4-3</i> .

Figure 4-3 Mouse Menu



Table 4-3 Right Mouse Button Menu Functions

Option	Function
Freeze	Freezes the image.
PTZ...	Allows you to control cameras with Pan, Tilt, and Zoom capabilities.

Table 4-3 Right Mouse Button Menu Functions

Option	Function
Spot Monitor...	Allows you to select which cameras display on the spot monitor.
Zoom...	Zoom in on the live image. While in the zoom mode, there are two ways to move around the enlarged portion of the video (which is indicated by a rectangle): <ul style="list-style-type: none"> • Click inside the rectangle to move to another area of the image you want enlarged. • Click and hold the mouse button on the enlarged video and drag the video.
Display	Displays the Mouse Display menu, seen below in <i>Figure 4-4</i>

Figure 4-4 Mouse Display Menu

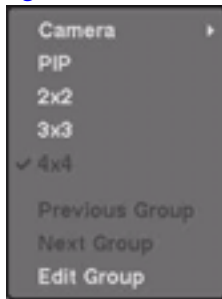

Table 4-4 Mouse Display Menu Functions

Option	Function
Camera	Clicking Camera and selecting the camera number is the same as pressing the individual camera buttons on the front panel display the selected camera full screen. When in the PIP display mode, click the right mouse button and then select PIP to change the location and the size of the PIP.
PIP, 2x2, 3x3, 4x4	Select PIP , 2x2 , 3x3 , and 4x4 to display the cameras in the selected multi-view screen mode.
Previous Group	Click Previous Group to move to the previous page.
Next Group	Clicking Next Group is the same as pressing the GROUP button on the front panel which moves to the next page.
Edit Group	Selecting Edit Group supports the active cameo function. Select Edit Group and choose a camera that you want to change display position (for example, Camera A). Then, click the right mouse button to display the menu. If you select another camera in the menu (for example, Camera B), the screen displays Camera B instead of Camera A. When in the 4x4 format, Camera A and Camera B switch positions.

Event Monitoring

When an event occurs, if **Event Monitoring On** is selected in the **Display** setup screen (see *Display OSD Screen*, page 67), then the DVR displays the camera associated with the event.

The number of cameras associated with the event affects how the cameras are displayed.

If...	Then the DVR displays...
One camera is associated with the event	The camera full screen
Two to four cameras are associated with the event	The cameras on a 2x2 screen
Five to nine cameras are associated with the event	The cameras on a 3x3 screen
10 or more cameras are associated with the event	The cameras on a 4x4 screen

Event monitoring lasts for the dwell time set for event recording. After the dwell time has elapsed, the monitor returns to the previous screen unless another event has occurred.

Returning to Live Monitoring Mode

If you want to return to the live monitoring mode before the dwell time has elapsed, press **DISPLAY** or one of the camera buttons.

Covert Camera Settings

If a camera is set to **Covert 1** in the Camera setup screen (Settings tab), that camera does not display unless a user with Covert Camera View authority logs into the system. However, the camera title and status icons are displayed on the monitor.

If a camera is set to **Covert 2** in the Camera setup screen (Settings tab), that camera appears to be **Off** unless a user with Covert Camera View authority logs into the system. The camera title is grayed out and status icons are not displayed on the monitor.

Note When a camera is set to **Covert 1**, the DVR displays the camera title and status icons on the covert video. When set up as Covert 2, the DVR displays only the camera title on the covert video.

Viewing Images from Covert Cameras

The only users who can view video from cameras set to Covert 1 or Covert 2 including the camera titles and status icons are those users who have Covert Camera View authority and who have logged into the system.

Spot Monitoring

When the Spot Monitor is in the sequence mode, you can set the camera's display dwell time. See *Display Screen* on page 66 in *Chapter 3, Configuration* for more details.

Selecting the Camera to Display on a Spot Monitor

1. On the front panel, press and hold **SPOT** for two seconds or longer. The Sequence menu displays.

Figure 4-5 Sequence Menu



2. Select the camera to be displayed on the Spot Monitor.
OR
Select **Sequence** from the menu to sequentially display more than one camera on a Spot Monitor.
3. Select **Sequence** again to stop sequencing on the Spot Monitor.

Note Any cameras that are **Off**, have lost video, or are set to **Covert** (unless the user has authority to view covert cameras) are excluded from the sequence.

PTZ Mode

Note The only users who can control PTZ cameras are those who have PTZ Control authority and who have logged into the system. The DVR will control cameras with Pan, Tilt, and Zoom capabilities.

Entering the PTZ Mode

1. Press and hold **PTZ** for two seconds or longer. The PTZ camera menu displays.

Figure 4-6 PTZ Select Camera Menu

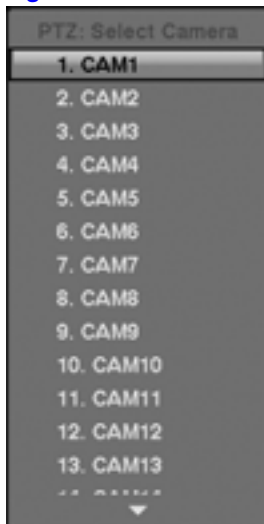

2. Select the PTZ camera you wish to control. The **PTZ** icon flickers on the PTZ camera screen.

Controlling the PTZ Cameras

You can control the cameras in four ways:

- Using front panel control buttons
- Setting up and loading presets
- Selecting the expanded PTZ features
- Using a mouse

Positioning the PTZ Cameras Using the Front Panel Buttons



- Press the **LEFT** and **RIGHT** arrow buttons to pan left and right.
- Press the **UP** and **DOWN** arrow buttons to tilt the camera up and down.
- Press camera button **1** to zoom in.
- Press camera button **2** to zoom out.
- Use camera buttons **3** and **4** to focus the image.
- Use camera button **6** to establish Presets.
- Use camera button **5** to quickly view an established camera Preset position.

Saving Camera Position Settings as Presets

After positioning the camera using the front panel buttons, you can save camera position settings as presets so that you can go quickly and directly to desired views.

Figure 4-7 PTZ Preset Screen





1. Press . The PTZ Preset dialog box appears.
2. Select the number you want to assign to the preset and then press .
3. Use the virtual keyboard to enter the preset name.

Loading a Preset

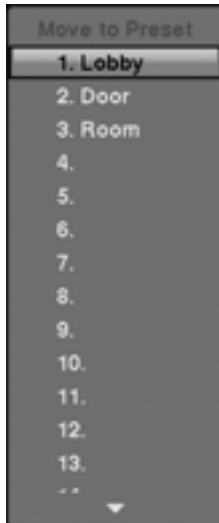
Figure 4-8 Preset View Screen



1. Press  to load the PTZ preset. The Preset View dialog box appears.
2. Select the desired preset and then press  to load the preset.

Using a Mouse for Convenient PTZ Control

Position the mouse pointer at the bottom of the screen, and the following PTZ toolbar displays.

Figure 4-9 PTZ Toolbar



Table 4-5 PTZ Toolbar Tools





Icons	Action
	Zoom In / Out
	Focus Near / Far
	Iris Open / Close
	Set / Load Preset
Arrows	Pan or tilt

Table 4-5 PTZ Toolbar Tools

Icons	Action
✘	Exit the toolbar
Click the empty space under ✘ and drag the toolbar to where you want it located.	
To re-display the toolbar, position the mouse pointer at the bottom of the screen.	

Exiting the PTZ Mode

Press **PTZ** to exit the PTZ mode.

Recording

Recording Video

After you have installed the DVR following the instructions in *Chapter 2, Installation*, it is ready to record. The DVR starts recording based on the settings you made in the Record setup screen. See *Chapter 3, Configuration*.

Recycle On or Recycle Off

The DVR records over the oldest video once the hard disk is full. The factory default is Recycle On. Setting the DVR to Recycle Off causes it to stop recording once the hard disk is full.

Standard or High

When set to Standard (factory default), the DVR has a maximum recording speed of 120 ips. When set to High, the DVR has a maximum recording speed of 60 ips.

Panic Recording

Pressing **PANIC** starts panic recording of all cameras, and pressing the button again stops panic recording. If you set the Panic Recording Duration in the Record Screen, panic recording stops automatically according to the preset duration as long as **PANIC** is not pressed.

Note When the DVR is not in the Recycle mode and all available storage space has been used, panic recording will not operate.

Although you are able to record without changing the unit from its original factory settings, you may want to take advantage of the many tools on the DVR. See *Chapter 3, Configuration* for detailed descriptions of the recording mode options.

Recording Audio

If the DVR was set up to record audio, it records audio from up to two inputs when video is recording. The DVR does not record audio when the recording speed is set to less than 1 ips.

Note Ensure that you comply with all local and federal laws and regulations when recording audio.

Playing Recorded Video

If users who have Search authority log into the system, they can view recorded images. After video has been recorded, you can view it by pressing **PLAYBACK**. When playing video for the first time, the DVR displays the most recent image. When playing video subsequent times, the DVR starts playing video from the last recalled image. Recorded audio will be played when the DVR displays a camera with recorded audio in full screen mode.

Note While recording video, the playback speed might decrease.

Note Only the administrator and users with Covert Camera View authority can view video from covert cameras. The covert cameras in the playback mode are determined by the current camera settings.

Table 4-6 Playback Button Functions

Button	Function
Camera Buttons (1 to 16)	Press the individual camera buttons to display a camera full screen.
Arrow Buttons	<p>Press to play video backward at high speed. Pressing that button again increases the playback speed from , and . Press to play video forward at high speed. Press that button again to increase the playback speed from , and .</p> <p>When in pause mode, press to move to the next image. Similarly, press to move to the previous image.</p>
PLAY/PAUSE	Press to play back images at regular speed or pause playing video.
CAMEO	<p>Press and hold CAMEO for two seconds or longer to enter the Active Cameo mode. The yellow outline surrounding the video indicates the Active Cameo mode. Press the arrow buttons to move the Active Cameo mode.</p> <p>Press the desired camera button in the Active Cameo mode to edit the cameo and to display the video of selected camera.</p> <p>Press (Play/Pause) to exit the Active Cameo mode.</p> <p>Select Exit Group Edit in the Active Cameo mode menu displayed when pressing the MENU/CAMEO button also exits the Active Cameo mode.</p>
Note	A cameo is defined as any cell within multi-screen display. The cameo mode allows you to change the screen layout by editing the cameo.
PLAYBACK	<p>Press PLAYBACK to enter the playback mode. Press it again to exit the playback mode. When entering the playback mode, video is paused.</p> <p>Press to play video back at regular speed. The screen displays when the DVR is in the Pause mode and the screen displays when the DVR is playing back video.</p>

Table 4-6 Playback Button Functions

Button	Function
ZOOM	Press ZOOM to enlarge the current image on the screen. Use the arrows to navigate.
DISPLAY/SPOT	Press DISPLAY/SPOT to toggle different display formats. The available formats are: 2x2, 3x3 and 4x4. Press and hold the DISPLAY/SPOT button for two seconds or longer to select which cameras display on the Spot monitor.
GROUP	Press the GROUP button changes the screen from the current camera group to the next camera group, and the screen displays page number.

Using the Mouse for Playback









You can use a mouse for convenient playback control. Position the mouse pointer on the playback screen, and the following playback toolbar appears.

Figure 4-10 Playback Toolbar



The individual controls on the toolbar perform the following functions:

Table 4-7 Playback Toolbar Functions

	Go to the first image
	Fast backward play
	Go to the previous image
	Play
	Go to the next image
	Fast forward play
	Go to the last image
	Exit the toolbar

Click the empty space under **X** and drag the toolbar to where you want it located.

To re-display the toolbar, position the mouse pointer at the bottom of the screen.

Searching Video

Press **MENU** or click the right mouse button while in the Playback mode to display the Search Menu.

Figure 4-11 Search Menu

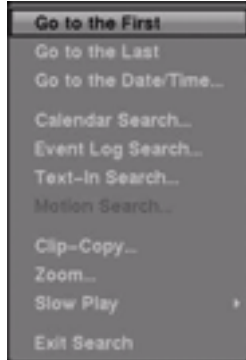

Use the Search Menu functions to find specific sections of the recorded video.

Table 4-8 Search Menu Options

Option	Function
Go to the First	Displays the first recorded image
Go to the Last	Displays the last recorded image
Go to the Date/Time...	Searches by date and time (see <i>Go to the Date/Time</i> on page 120 for more details)
Calendar Search...	Searches using a calendar (see <i>Calendar Search</i> on page 120 for more details)
Event Log Search...	Selects video from the event log (see <i>Event Log Search</i> on page 121 for more details)
Text-In Search...	Searches text input strings (see <i>Text-In Search</i> on page 124 for more details)
Motion Search...	Searches motion events (see <i>Motion Search</i> on page 127 for more details)
Clip-Copy...	Clips a video segment and saves it (see below for more details)
Zoom...	Zooms the current playback image
Slow Play...	Plays video at low speed (x1/2, x1/3, x1/4, x1/6 and x1/8)
Exit Search	Exits the Search Menu

Note While recording video, the speed at which searched data is played back might decrease.

Go to the Date/Time

Use the **Go to the Date/Time...** search function when you know the date and time when the desired video was recorded.

1. Select **Go to the Date/Time...** from the Search menu. The Go to the Date/Time screen appears.

Figure 4-12 Go to the Date/Time Screen

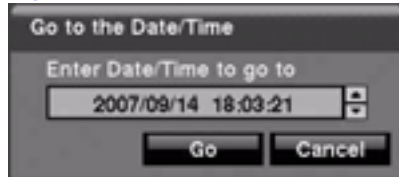

2. Move the cursor over the date and time and then press \odot/P (Play/Pause). Use the Left and Right arrow buttons to highlight the year, month, day, hours, minutes and seconds. Use the Up and Down arrow buttons to change to the date and time for which you want to search for video.
3. Press \odot/P again after you have set the date and time you want.
4. Highlight **Go** and press \odot/P . The video for the selected date and time appears.
If no video was recorded during the selected time, a message appears alerting you that no image was recorded at that time. You can now use \odot/P and the arrow buttons to review the video before and after the selected section of video.

Calendar Search

Use the **Calendar Search** function when you want to see on what days video was recorded, or to search certain days (for example, a weekend) for video.

1. Select **Calendar Search** from the Search menu. The Calendar Search screen appears.

Figure 4-13 Calendar Search Screen





Days with recorded video display on the calendar with white numbers.

2. Highlight the day with recorded video you want to view by using the arrow buttons.
3. Press  (Play/Pause) to select the highlighted day. A time bar displays at the bottom of the calendar. Hours in which video was recorded are highlighted with blue.
4. Use the **UP** and **DOWN** arrows to highlight the time bar.
5. Select a specific time by using the **LEFT** and **RIGHT** arrows to navigate the highlighted time bar.

Note The time bar is in one-hour segments. If a segment is highlighted, it means that some video was recorded during that hour. However, it does NOT mean video was recorded for the entire hour.

6. If the DVR time and date have been reset to a time that is earlier than some recorded video, it is possible for the DVR to have more than one video stream in the same time range. Navigate to **Select a Segment**, and select the video stream you want to search. See *Appendix D, Time Overlap* for further information on searching time-overlapped video streams.

Note The lower number of the Segment indicates the latest recorded video.

7. Highlight **GO** and then press  after you have set the date and time you want to search. The selected date and time displays. You can now use the  button and arrows to review the surrounding video.

Note In the event that no recorded image displays on the current screen, press **DISPLAY** and change the screen mode to 4x4. You can now easily see the camera that recorded video during target time.

Event Log Search

The DVR maintains a log of each time the Alarm Input port is activated. The Event Log Search screen displays this list. There is no determined user authority to display the Event Log Search screen. However, the event video does not play unless a user with Search authority logs into the system

To access the Event Log Search screen:

1. Select **Event Log Search** from the Search menu. The Event Log Search screen appears.
OR
Press **ALARM** (unless there is an alarm).

Figure 4-14 Event Log Search Screen

Time	Type	Title
2007/08/28 11:52:13	Alarm-In 5	
2007/08/28 11:52:10	Motion 11	CAM11
2007/08/28 11:52:09	Alarm-In 7	
2007/08/28 11:52:08	Alarm-In 11	
2007/08/28 11:52:08	Video Loss 11	CAM11
2007/08/28 11:52:07	Video Loss 6	CAM6
2007/08/28 11:51:45	Text-In 1	
2007/08/28 11:51:40	Motion 6	CAM6
2007/08/28 11:51:39	Alarm-In 1	
2007/08/28 11:51:38	Motion 2	CAM2

The screenshot shows a screen titled "Event Log Search" with a table of event logs. Below the table are buttons for "Option...", "Close", and navigation arrows.

2. Use the arrows to highlight the event for which you would like to see video.
3. Press **(P)** (Play/Pause) to extract the event video and display the first image of the event.
4. Press **(P)** to play the event video segment.
5. Press **PLAYBACK** to return to live monitoring.

Note In the event that no recorded image displays on the current screen, press **DISPLAY** and change the screen mode to 4x4. Now you can see easily the camera that recorded video during target time.

Narrowing Your Event Search Using Option

You can also narrow your event search by selecting **Option...** and setting up the new search condition.

1. Select **Option** in the Event Log Search screen. The Event Log Search Option screen appears.

Figure 4-15 Event Log Search Option Screen



You can search video from the first to last recorded images, or you can set the start and stop times and dates.

2. Select your search options.

Table 4-9 Event Log Search Options









Option	Action
From	Highlight the box beside From and then press  to toggle between On and Off . When set to Off , you can enter a specific Date and Time. When set to On , the DVR finds the first recorded image.
To	Highlight the box beside To and then press  to toggle between On and Off . When set to Off , you can enter a specific Date and Time. When set to On , the DVR finds the last recorded image.
Check Time Overlap	Highlight the box beside Check Time Overlap and then press  to toggles between On and Off . You can only turn the Check Time Overlap on or off if a user-defined date and time is set in the From and To fields. If the DVR date and time have been reset, it is possible for the DVR to have more than one overlapping start and stop times. When set to On , you are asked to select one of the overlapping start and stop time. When set to Off , the DVR displays search results from all start times to all stop times.
Alarm-In	Highlight the field beside Alarm-In and then press  . You can select the alarm inputs that you want to include in your search.
Motion	Highlight the field beside Motion and press  . You can select the cameras for which you want any reports of motion detection.

Table 4-9 Event Log Search Options

Option	Action
Video Loss	Highlight the field beside Video Loss and press  . You can select the cameras for which you want any reports of lost video.
Text-In	Highlight the field beside Text-In and press  . You can select the text-in devices which you want any report of text input.
Record Channels	Highlight the field beside Record Channels and press  . You can select the cameras that you want to search for any reports of event recorded data. The DVR displays the events (not the camera channels) that occurred and that also are recorded on the camera channel that you selected. If you do not select a camera channel in this field, the DVR searches events that are not associated with cameras.

You can also activate self-diagnostic events as part of your search.

Table 4-10 Self-Diagnostic Events

Setting	Event
Panic Record	Searches for Panic recording events
Check Recording	Searches for Check Recording events
Check Alarm-In	Searches for Alarm-In events
Disk Almost Full	Searches for Disk Almost Full events
Disk Bad	Searches for Disk Bad events
Disk Temperature	Searches for Disk Temperatures events
Disk S.M.A.R.T.	Searches for S.M.A.R.T. events

3. Highlight **Search** and press  to display the search results in the Event Log Search screen when you set your desired search conditions. Select **Cancel** to exit the screen without saving the changes.

Text-In Search

The DVR maintains a log of each time there is Text Input. The Text-In Search screen displays this list.

1. Select **Text-In Search** from the Search menu. The Text-In Search screen appears.

Figure 4-16 Text-In Search Screen

Time	Transaction
2007/08/28 11:57:03	=====
2007/08/28 11:57:03	Thank you~~
2007/08/28 11:57:02	total : \$ 8.30
2007/08/28 11:57:01	=====
2007/08/28 11:57:00	Garlic bread \$ 1.15 1(s) \$ 1.15
2007/08/28 11:57:00	Pan cake \$ 3.15 1(s) \$ 3.15
2007/08/28 11:56:59	7 Up \$ 1.80 1(s) \$ 1.80
2007/08/28 11:56:58	Coke \$ 2.20 1(s) \$ 2.20
2007/08/28 11:56:57	=====
2007/08/28 11:56:57	Item Unit price Qty amount

Option... [Up Arrow] [Down Arrow] Close

2. Use the arrows to highlight the event for which you would like to see video.
3. Press **(F1)** to extract the video associated with the Text Input and to display the first image of the event.
4. Press **(F2)** to play the event video segment.
5. Press **PLAYBACK** to return to live monitoring.

Note In the event that no recorded image displays on the current screen, press **DISPLAY** and change the screen mode to 4x4. Now you can easily see the camera have recorded video during target time.

Note Text Input information is overlaid on the image while the recorded video is played at regular speed.

Narrowing Your Text-In Search Using Option

You can also narrow your Text-In Search by selecting **Option...** and setting up the new search condition.

1. Select **Option** in the Text-In Search screen. The Text-In Search Option screen appears.

Figure 4-17 Text-In Search Option Screen

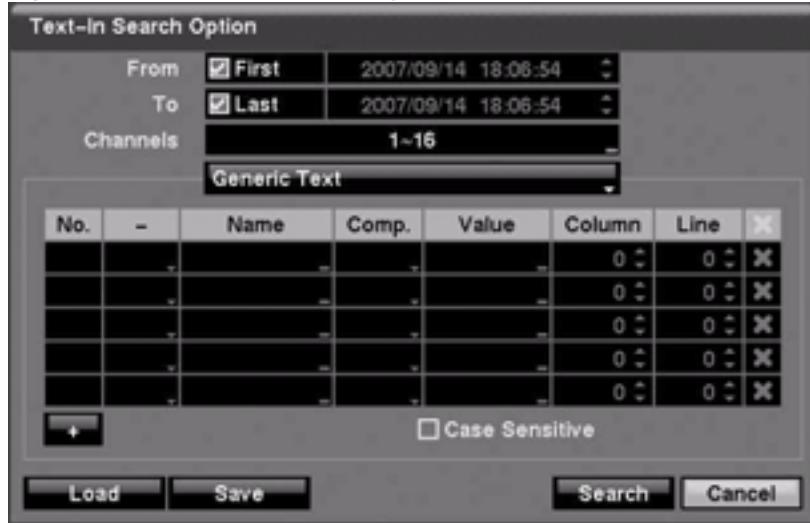

You can search video from the first to last recorded images, or you can set the start and stop times and dates.

2. Select your search options.

Table 4-11 Text-In Search Options

Option	Action
From	Highlight the box beside From and then press $\left(\frac{1}{n}\right)$ to toggle between On and Off . When set to Off , you can enter a specific Date and Time. When set to On , the DVR searches from the first recorded image.
To	Highlight the box beside To and then press $\left(\frac{1}{n}\right)$ to toggle between On and Off . When set to Off , you can enter a specific Date and Time. When set to On , the DVR searches from the last recorded image.
Channel	Highlight the Channel and then press $\left(\frac{1}{n}\right)$. Select the text-in devices that you want to search for text input.
Text Input Device	Highlight the Text Input Device box and then press $\left(\frac{1}{n}\right)$. Select your Text Input Device from the list. Select from Any Text-in Product , Generic Text , VP Filter , and Epson .
+	Highlight the + and press $\left(\frac{1}{n}\right)$ to add a new set of search parameters. See <i>Appendix B, Text-In Query Examples</i> for more information on setting up search parameters.
X	Use this column to delete a set of search parameters or entire sets of search parameters.
No.	You can search for up to five text strings at a time. Highlight the number box and then press $\left(\frac{1}{n}\right)$. This makes the Name , Comp , Value , Column , and Line fields active. You can use all those fields to define your search parameters.
Name	Highlight the Name field and then press $\left(\frac{1}{n}\right)$. A virtual keyboard appears with which you can enter a word or text string for which you want to search.

Table 4-11 Text-In Search Options

Option	Action
Comp	Highlight this field and press F7 . A drop-down menu appears from which you can select <, <=, =, >=, and >. This field defines comparisons for your search.
Value	Highlight the Value field and then press F7 . A virtual keyboard appears with which you can enter a word or text string for which you want to search.
Column	Select from 0 to 256 .
Line	Select from 1 to 5 lines.
Case Sensitive	Highlight Case Sensitive and then press F7 to toggle between On and Off. When this feature is On , the search finds only those text strings in which the case matches.

3. Highlight **Load** and press **F7** to load saved search option settings.
4. Highlight **Save** and press **F7** to save the current search option settings. A virtual keyboard appears that you can use to enter the search option name.
5. Highlight **Search** and then press **F7** to display the search results in the Text-In Search screen once you have set your desired search conditions.
6. Select **Cancel** to exit the screen without saving the changes.

Motion Search

1. Select **Motion Search...** from the Search menu while the DVR displays the camera full screen to display a list of motion events. The Motion Search screen appears.

Figure 4-18 Motion Search Screen



2. Use the arrow buttons to highlight the event for which you would like to see video and then press **⏮** (Play/Pause) to display the video associated with the selected event on the small search screen.
3. Highlight **Close** and then press **⏮** to extract the video associated with the Motion event and to display the first image of the event.
4. Press **⏮** to play the event video segment.
5. Press **PLAYBACK** to return to live monitoring.

You can also narrow your event search by selecting **Option...** and setting up the new search condition.

1. Select **Option...** in the Motion Search screen. The Motion Search Option screen appears.

Figure 4-19 Motion Search Option Screen

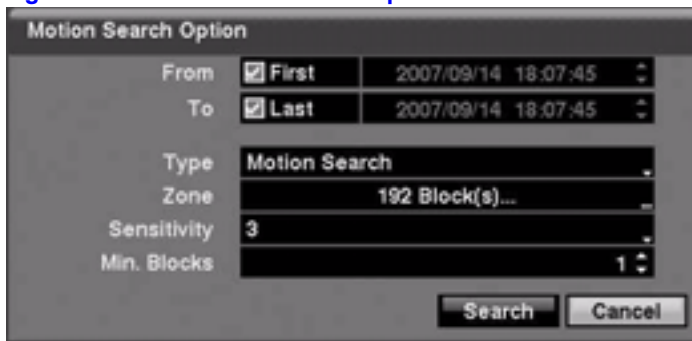



You can search video from the first to last recorded images, or you can set the start and stop times and dates.

2. Select your search options.

Table 4-12 Motion Search Options

Option	Action
From	Highlight the box beside From and then press ⏮ to toggle between On and Off . When set to Off , you can enter a specific Date and Time. When set to On , the DVR searches from the first recorded image.
To	Highlight the box beside To and then press ⏮ to toggle between On and Off . When set to Off , you can enter a specific Date and Time. When set to On , the DVR searches from the last recorded image.
Type	Highlight the field beside Type and then press ⏮ . You can select between Motion Search and Museum Search . Motion Search detects motion in the defined area. Museum Search detects if a defined object has moved.
Zone	Highlight the field beside Zone and then press ⏮ . An image from the video appears overlaid with a grid. You can turn sensor blocks On and Off to define the area of the picture in which you want to search for motion. The zone should be placed or focused on the centre or, at least, within the outline of the targeted object.

Table 4-12 Motion Search Options

Option	Action
Note	Defining the area of the image in which you want to search for motion is nearly identical to setting up the DVR for Motion Detection. Please see <i>Motion Detection Setup</i> on page 81 in <i>Chapter 3, Configuration</i> for more detailed instructions on setting up the detection blocks.
Note	When setting the Museum Search Zone, the zone should be placed inside the border line of the target object. If the selected block is placed on the border line, the sensitivity of the Museum Search may decrease.
Sensitivity	Highlight the field beside Sensitivity and then press  . You are now able to select from 1 (low sensitivity) to 5 (high sensitivity).
Min. Blocks	Highlight the field beside Min. Blocks and then press  . You are now able to set the number of sensor blocks that must be activated. You can set the Min. Blocks only if Motion Search is selected.

3. Highlight **Search** and then press  to display the search results in the Motion Search screen once you set your desired search conditions.
4. Select **Cancel** to exit the screen without saving the changes.

When you search for motion events from another camera, you are asked whether or not you want to delete the previous search results from the list.

Copying Video Clips Using the Clip-Copy Screen

Use the Clip-Copy screen to copy video clips to an internal CD-RW drive, an external USB hard disk, a CD-RW, or a flash drive. The copied video clips can be viewed on computers running Microsoft® Windows 98, ME, 2000, XP, or Vista. See *Appendix A, USB Hard Disk Drive Preparation* for information on preparing the external drive for clip copy. The clip copy can be done simply by pressing **CLIP COPY** on the front of the DVR.

Table 4-13 Using the Clip-Copy Function

If you press the Clip Copy button...	Then...
While in the Live monitoring mode	The Clip-Copy screen appears to allow clip copy setup.
During playback	A starting point is set for copying the video clip. The  icon displays at the bottom-left corner of the screen. Press the CLIP COPY button again to set the ending point of the video to be clip copied.
For more than two seconds while in the Playback mode or Live Monitoring mode	The One-Touch Clip Copy function initiates. The last recorded image will be the ending point of video to be clip copied, and the system will automatically begin to calculate the possible video data size that the selected storage media can handle.

1. From the Search menu, select **Clip-Copy....** The Clip-Copy screen appears.

Figure 4-20 Clip-Copy Screen

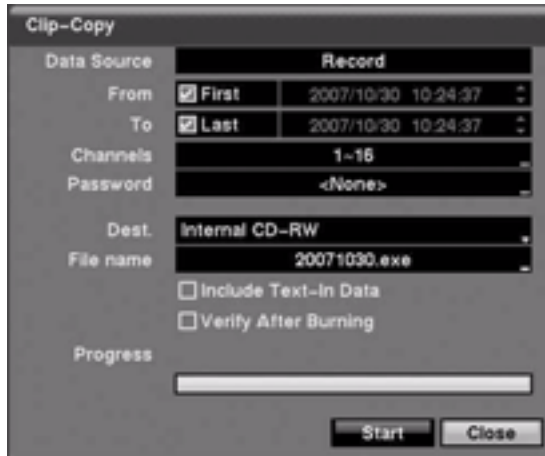

2. Select from the options on the Clip-Copy screen.

Table 4-14 Clip Copy Options

Option	Action
From	Highlight the box beside From and then press $\left(\frac{1}{2}\right)$ to toggle between On and Off . When set to Off , you can enter a specific Date and Time. When set to On , the DVR searches from the first recorded image.
To	Highlight the box beside To and then press $\left(\frac{1}{2}\right)$ to toggle between On and Off . When set to Off , you can enter a specific Date and Time. When set to On , the DVR searches from the last recorded image.
Channels	Highlight the field beside Channels and then press $\left(\frac{1}{2}\right)$. You can select the cameras that you would like to include in your video clip.
Password	Highlight the field beside Password and then press $\left(\frac{1}{2}\right)$. A virtual keyboard appears allowing you to enter the password for reviewing the video clips.
Dest.	Highlight the field beside Dest. and then press $\left(\frac{1}{2}\right)$. You can select the storage device on which you would like to record the video clip. You can choose from Internal CD-RW , USB Storage , and USB CD-RW .
File name	Highlight the field beside File name and then press $\left(\frac{1}{2}\right)$. A virtual keyboard appears allowing you to enter the file name for the video clip.
Include Text-In Data	Highlight Include Text-In Data and press $\left(\frac{1}{2}\right)$ to toggle between On and Off . When this feature is On , you can include text-in data when copying video if the video was recorded with text-in data.
Verify After Burning	Highlight Verify After Burning and press $\left(\frac{1}{2}\right)$ to toggle between On and Off . When this feature is On , you can verify that the data was written on the CD-RW properly.

Caution The USB device for clip copy must be FAT 16 or FAT 32 format.



Note While copying video clips on the CD-RW, the recording speed might decrease.

Naming a Video Clip File

The DVR automatically assigns a file name to the video clip. However, you can give the video clip file a different name.

1. Highlight the field beside **File Name** and then press . A virtual keyboard appears.
2. Enter a file name for the video you are backing up and then select **Close**. The DVR automatically adds the camera number (for example, 01) and .exe to the file name. If you want to save the file in a specific folder, enter the folder name followed by a /. For example: fo1der/fi1ename

Note When naming a file, you cannot use the following characters: \, /, :, *, ?, ", <, >, |.

3. Highlight **Start** and then press  after you have given the video clip a file name. The confirmation screen displaying data size appears. When the storage device does not have enough space, the DVR asks if you want to copy as much of the video clip as possible in the available space.
4. Highlight **Continue** and then press  to continue clip copy.
5. After the clip copy starts, select **Cancel** to cancel it or **Close** to hide the screen. When selecting **Close**, Clip Copy continues and a confirmation screen displays when complete.

Note The file size for clip copy is limited to 2 GB.

Using the DVR While Backing Up Video

You can use other functions on the DVR while video is being backed up.

Highlight **Close** and then press . You can return to the Clip-Copy screen at any time to check the progress.

See [Appendix C, Reviewing Video Clips](#) for instructions on how to review video clips you have copied. You do not need to install any special software on your personal computer to review the video clips.

Note During Clip Copy, you cannot shut the system down, clear data on the storage device, or format the storage device.

Caution Do *NOT* disconnect the USB cable or the power from the external drive while copying video clips. If the external drive is shut down or the USB cable is disconnected while copying video clips, then **THE DVR SYSTEM MAY NOT WORK NORMALLY OR THE EXTERNAL DRIVE COULD BE DAMAGED**. You will get an error message the next time you try to copy video clips. You will need to power down the DVR and restart it to get rid of the error message.

If the file system of the USB-IDE hard disk drive has been corrupted, then this error message cannot be dismissed. Even after restarting the DVR it may automatically restart while preparing to clip copy. You must recover the file system using the recovery program, or you must reformat the hard disk drive.

A

USB Hard Disk Drive Preparation

Preparing the USB-IDE hard disk drive in Windows 2000

Note Preparing a USB-IDE hard disk drive under Windows XP is almost identical to Windows 2000.

6. Connect the USB-IDE hard disk drive to your computer using the USB Cable.
7. Turn on your computer.
8. The USB device icon should display on the Taskbar.
9. If the USB-IDE hard disk drive is partitioned or has data, it shows up in My Computer as a hard disk drive icon. Check the file system by right clicking on the icon and checking under **Properties > General > File System**. If the file system is *NOT* FAT32 format, format the USB-IDE hard disk drive using the FAT32 format.
10. If the USB-IDE hard disk drive is not partitioned, go to **Administrative Tools** in Control Panel and launch **Computer Management**. Open **Disk Management** in Storage and right click an unallocated region of the USB-IDE hard disk drive. Then, click **Create Partition**.
11. In the Create Partition wizard, click **Next** then **Primary Partition**, and follow the instructions on the screen. Make sure that the FAT32 is selected for the file system.

Note The partition size should be less than 32GB because of Microsoft® limitations.

After formatting is complete, the USB-IDE hard disk drive is added to My Computer.

12. Connect the USB-IDE hard disk drive to the DVR.

Preparing the USB-IDE hard disk drive in Windows 98

Note Preparing a USB-IDE hard disk drive under Windows ME is almost identical to Windows 98.

1. Connect the USB-IDE hard disk drive to your computer using the USB Cable.
2. Turn on your computer. The Add New Hardware wizard window appears.
3. Install the device driver for the USB backup device following the instructions provided with your USB hard disk drive.
4. If the USB-IDE hard disk drive is partitioned or contains data, it shows up in My Computer as a hard disk drive icon. Check the file system in **Properties > General > File System**. If the file system is NOT FAT32 format, format the USB-IDE hard disk drive with FAT32 format.
5. Run the FDISK utility by clicking **Start** then **RUN**. Type `fdisk` and click **OK**.
6. When the MS-DOS command prompt appears, type `Y` and press **Enter**.
7. In the FDISK Option menu, choose **5. Change current fixed disk drive**.
8. Choose the appropriate letter corresponding to the USB-IDE hard disk drive.
9. In the FDISK Option menu, choose **1. Create DOS partition or Logical DOS Drive**.
10. In the Create DOS Partition or Logical DOS Drive menu, choose **1. Create Primary DOS Partition**. And Type `Y` to use all available space and press **Enter**. Press **ESC** to exit the screen after the USB-IDE hard disk drive partition is created.
11. Restart your computer and verify the newly created drive is in My Computer.
12. Right click the newly created hard disk drive icon and select **Format**.
13. In the Format Screen, select **Full** as the Format type and press **Start**.
14. After formatting is complete, connect the USB-IDE hard disk drive to the DVR.

B

Text-In Query Examples

Query Example I

```

          1          2          3          4          5          6
123456789012345678901234567890123456789012345678901234567890

      Item          Unit price          Qty          amount

=====

Coke          | $    2.20 |    1(s) |    $    2.20
Fanta         | $    2.20 |    1(s) |    $    2.20
Hotdog        | $    3.50 |    3(s) |    $   10.50
Pepsi         | $    1.95 |    1(s) |    $    1.95

=====

                                          total : $    16.85

Thank you~~
    
```

In the above text-in data, you can find that the comparison value is located at 17th (Unit price, \$ mark will be ignored automatically), 28th (Qty) and 40th (amount) characters (including spaces) from the left. In this case, you can enter 17, 28, and 40 in each Column field.

For example, if you want to search for Coke with a **Qty** (Quantity) of more than 1 and Hotdog with an **amount** totaling over \$8, the following search condition can be set.

Figure B-1 Query Example 1



Query Example II

1 2 3 4 5 6
 123456789012345678901234567890123456789012345678901234567890

Item	Unit price	Qty	amount
Coke	\$ 2.20	1(s)	\$ 2.20
Fanta	\$ 2.20	1(s)	\$ 2.20
Hotdog	\$ 3.50	3(s)	\$ 10.50
Pepsi	\$ 1.95	1(s)	\$ 1.95
total :			\$ 16.85

Thank you~~

In the above text-in data, you can find that the comparison value is located at 17th (Unit price, \$ mark will be ignored automatically), 28th (Qty) and 40th (amount) characters (including spaces) from the left, but the value of amount category is located on a different line from Item. In this case, you can enter 17, 28, and 40 in each Column field and enter 1 in the Line field for the next line.

For example, if you want to search for Coke with a **Qty** (Quantity) of more than 1 and Hotdog with an **amount** totaling over \$8, the following search condition can be set.

Figure B-2 Query example 2

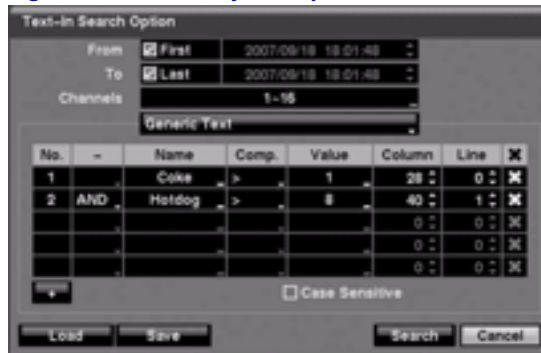

C

Reviewing Video Clips

You do not need to install any special software on your personal computer to review the video clips. The copied video clip contains the ClipPlayer program.

If you used a USB device, disconnect either the external USB-IDE hard disk drive or USB flash drive from the DVR, and connect it to your PC. If you used a recordable CD, insert the CD in your computer's CD drive. Double-clicking the target clip file starts the ClipPlayer program.

Note It is suggested that the computer used for the ClipPlayer program has at least an 800MHz Pentium III. If your CPU is slower than this, video clips recorded at maximum speed with very high image quality play back slowly. Also DirectX 8.0 or higher is required to run Clip Player, and a VGA card with 16MB or more video RAM is recommended for proper operation.

Figure C-1 ClipPlayer Screen



The ClipPlayer Screen displays the clip images.











Note The display settings of your PC affect the image display.





If you are experiencing display problems, click the right mouse button on the background screen and select **Properties>Settings** then set the Color quality to **32 bit**. Then select **Advanced>Troubleshoot** and set Hardware Acceleration to **Full**.

Ensure sure that DirectX version 8.0 or higher has been installed if the display problem continues to occur. To check the version of DirectX, click **Start>RUN** and type `dxdia` and press **Enter**. The DirectX Diagnostic Tool dialog box displays.

Then move to the Display tab and ensure DirectDraw Acceleration is set to **Enabled**. Test the DirectDraw by selecting the DirectDraw Test button. After changing the settings, update the driver version of the VGA card.

If you still have display problems after changing all display settings as described above, try replacing the video card. Video cards with an ATI chipset are recommended..

Option	ClipPlayer Function
	Exit the Player program.
	Go to the beginning of the video clip.
	Play the video clip in fast reverse.
	Go back one frame of the video clip.
	Play the video clip.
	Go forward one frame of the video clip.
	Play the video clip in fast forward.
	Go to the end of the video clip.
	Show the previous page.
	Cycle through the screen layouts: 2x2, 3x3, and 4x4.
	Show the next page.

Option	ClipPlayer Function
	<p>Select from Save, Print, Info, Image Processing, Video Formats, and Show Text In.</p> <p>Select Save to save the current image in a bitmap file format on the local hard disk drive or floppy disk.</p> <p>Select Print to print the current image on the printer connected to your computer.</p> <p>Select Info. to display Channel, Title, Time, Type, Size and Resolution information about the image.</p> <p>Select Image Processing to control brightness, blur and sharpen for playback images.</p> <p>Select Video Format to find appropriate display environments that can be varied depending on the type of graphics card installed in your PC. Use the Video Format option when you are experiencing poor image display.</p> <p>Select Show Text In to display video with text-in data if the video was recorded with text-in data.</p>
	<p>Select from Normal and Double screen views. Click the left mouse button on the enlarged image to move its position.</p>
Note	<p>Image Processing works only in the single-screen layout and also in the pause mode.</p>
Note	<p>If you are not sure about the appropriate Video Format option, try each option until the image displays properly.</p>
	<p>Displays the image full screen.</p>
	<p>An encryption icon which appears in the bottom right corner indicating that the clip file has not been tampered with.</p>
	<p>An encryption icon which appears in the bottom right corner indicating that the system has detected tampering.</p>
Note	<p>If the VGA card or monitor for your PC does not support 640x480 video resolution, Full Screen might not display properly when selected. If this happens, press ESC on your PC to return to the normal screen mode.</p>

Click the slider bar and move it left or right to move through the video clip.

Place the mouse cursor on an image and clicking to display that image in the full frame.

Reviewing Video Clips

D

Time Overlap

If the time and date have been reset to a time that is earlier than the existing recorded video, then it is possible for the DVR to have more than one video stream in the same time range. In this case, you can search overlapping video streams individually by selecting a specific segment.

For example, when the DVR has recorded video from one to five o'clock and the user changes the time backward from five to three o'clock and then continues recording until six o'clock, there will be two video streams and segments from three to five o'clock.

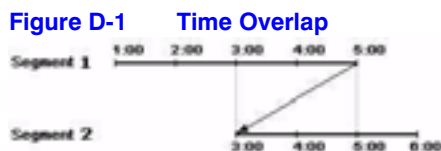

You can search overlapping video streams by selecting a specific time or time range. If you want to search recorded video at four o'clock during the overlapping time range, you can use **Go to the Date/Time**. You are given a choice of overlapping time segments. Select the segment you want to search.

Figure D-2 Time Overlap Segment Selection

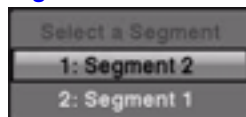

If you want to search recorded video from four to five o'clock during the overlapping time range using a search method such as **Event Log Search**, **Text-In Search**, or **Motion Search**, it is possible for the DVR to have two overlapping start and stop times. You are asked to select one of the overlapping start and stop times from the search time ranges as follows:



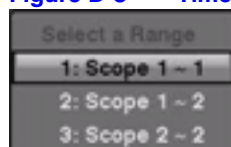

- From four o'clock of the first segment to five o'clock of the first segment
- From four o'clock of the first segment to five o'clock of the second segment
- From four o'clock of the second segment to five o'clock of the second segment

Figure D-3 Time Overlap Start/Stop Time Selection



E

Troubleshooting

Problem	Possible Solution
No Power	<ul style="list-style-type: none"> • Check power cord connections. • Confirm that there is power at the outlet.
No Live Video	<ul style="list-style-type: none"> • Check camera video cable and connections. • Check monitor video cable and connections. • Confirm that the camera has power. • Check camera lens settings.
Live Video Very Bright	If a cable is attached to the Loop connector, make certain it is connected to a properly terminated device.
DVR has stopped recording	If hard disk drive is full, you will either need to delete video or set the DVR to the Overwrite Mode.
The icon  displays, however, the DVR is not recording.	When the DVR is in the Pre-Event recording mode, the yellow  and  display when there is no event, and the DVR is not recording. The red  and  display when any event occurs and the DVR starts recording.

F

Connector Pinouts

Figure F-1 I/O Connector Pinouts

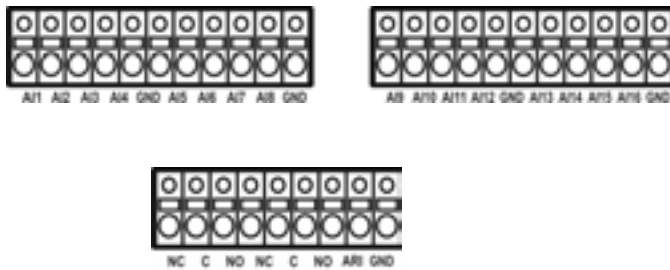

AI (1 to 16)	Alarm Inputs 1 to 16
GND	Chassis Ground (5 connectors)
NC	Relay Alarm Outputs (Normally Closed)
C	Relay Common
NO	Relay Alarm Outputs (Normally Open)
ARI	Alarm Reset In

Figure F-2 RS485 Connector Pinouts



Master Unit		Slave Unit	
RX-/TX-	→ To	→	TX-/RX-
RX+/TX+	→ To	→	TX+/RX+

Map of Screens

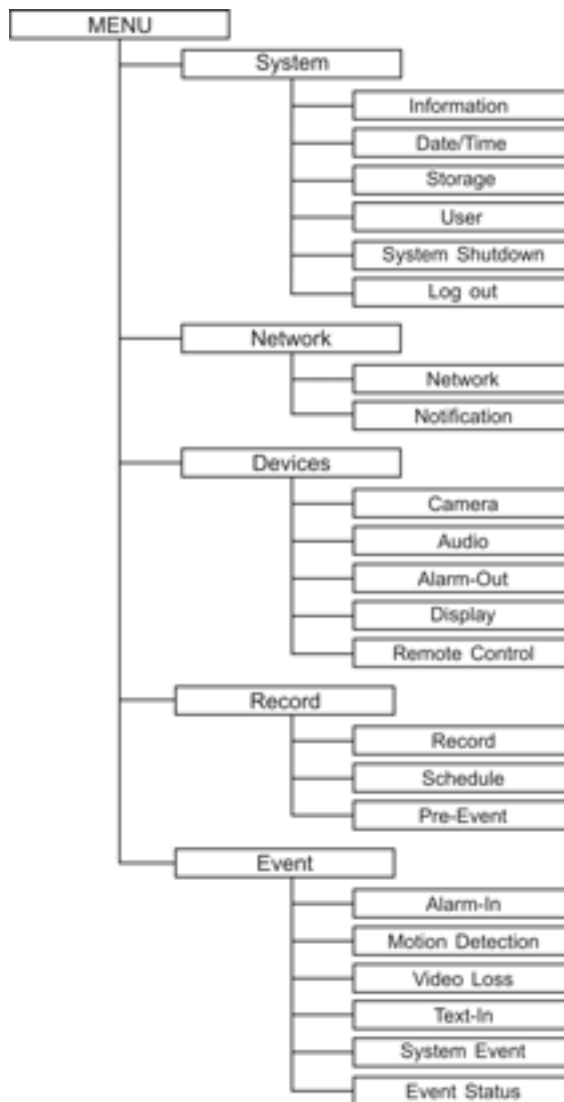

Map of Screens



System Log Notices

Boot Up	Setup Exported
Shutdown	Setup Export Failure
Restart	Setup Export Cancel
Upgrade	Schedule On
Upgrade Fail	Schedule Off
Power Failure	Panic On
Time Change	Panic Off
Time Zone Change	Clear All Data
Time Sync	Clear Disk
Time Sync Fail	Format Disk
Disk Bad	Disk Full
Login	Auto Deletion
Logout	Search Begin
Setup Begin	Search End
Setup End	Clip-Copy Begin
Remote Setup Change	Clip-Copy End
Remote Setup Fail	Clip-Copy Cancel
Setup Imported	Clip-Copy Fail
Setup Import Failure	Callback Fail



Error Code Notices

System Upgrade Related

Number	Description
0	Unknown error
1	File version error
2	Operating system version error
3	Software version error
4	Kernel version error
100	Upgrade device mounting failed
101	Package is not found
102	Extracting package failed
103	LILO failed
104	Rebooting failed
105	Invalid package
106	ODD firmware upgrade failed
300	Remote connection failed
301	Remote network error
302	Remote upgrade is not authorized
303	Saving remote package failed
304	Remote upgrade is cancelled by the user
400	USB device mounting failed

Number	Description
401	Reading upgrade package on the USB device failed
402	Copying upgrade package on the USB device failed
500	System is busy clip copying

Clip Copy Related

Number	Description
0	Unknown error
1	Device error
2	Mounting failed
3	No media
4	Invalid media
5	File already existed
6	Not enough space
7	Creating temporary file failed
8	Opening disk failed
9	Formatting disk failed
10	Database has been changed
11	Appending failed
12	Bad sector
13	No executable file
14	Opening executable file failed
15	Writing executable file failed
16	Creating image failed
17	Burning failed
18	Burning is out of time
22	Verify failed

Specifications

Video specifications	
Signal Format	NTSC or PAL (Auto Detect)
Video Input	Composite: 8 or 16 looping inputs, 1 Vp-p, auto-terminating, 75 Ohms
Monitor Outputs	Composite: 1 BNC, 1 Vp-p, 75 Ohms SPOT: 1 BNC, 1 Vp-p, 75 Ohms VGA: 1
Video Resolution	Composite: 720x480 (NTSC), 720x576 (PAL) VGA: 800x600 @ 60Hz
Record Speed (images per second)	Up to 120ips (NTSC)/100ips (PAL)
Inputs/Outputs	
Alarm Input	8 or 16 TTL, programmable as NC or NO, 4.3V threshold
Alarm Output	2 relay outputs, terminal blocks, programmable as NC or NO, 0.5A@125VAC, 1A@30VDC
Alarm Reset Input	1 TTL, terminal block
Internal Buzzer	80dB at 10cm
Network Connectivity	10/100 Mbps Ethernet (RJ-45), RS-232C for external modem
Audio Input	RCA Input: 2, Line In
Audio Output	RCA Output: 1, Line Out
Text Input	8 serial text strings (max) interface via USB. RS232 port accepts single data stream with multiplexed data from up to 8 or 16 terminals.

Connectors

Video Input	Composite: 8 or 16 BNC
Video Loop	Composite: 8 or 16 BNC (Auto Terminating)
Monitor Output	Composite: 1 BNC VGA: 1 VGA SPOT (Composite): 1 BNC
Audio In	2 RCA connector
Audio Out	1 RCA connector
Alarm Input/Output	Terminal blocks
Ethernet Port	RJ-45
RS-232C Serial Port	DB9 (P)
RS485 Serial Port	Two-connector terminal block
USB Port	2 (USB 2.0)

Storage

Primary Storage	EIDE hard disk drive
Clip Copy*	Built-in CD-RW drive USB hard disk drive, CD-RW drive or flash drive

* When installing an internal CD-RW drive, set the jumper to Master and connect to the Secondary IDE channel.

General

Dimensions (W x H x D)	16.9" x 3.5" x 16.3" (430mm x 88mm x 414mm)
Unit Weight	16.1 lbs. (7.3kg)
Shipping Weight	27.1 lbs. (12.3kg)
Operating Temperature	41°F to 104°F (5°C to 40°C)
Operating Humidity	0% to 90%
Power	100 to 240 VAC, 2 A, 60/50Hz
Power Consumption	90W
Approvals	FCC, UL, CE

Specifications are subject to change without notice.

Index

A

- Active Cameo mode [105](#)
- admin password [35](#)
- Alarm-in event action (Alarm-out) setup [78](#)
- Alarm-in event action (Notify) setup [79](#)
- Alarm-in event action PTZ cameras [80](#)
- Alarm-in event action spot monitors [80](#)
- alarm-in, setting [76](#)
- Alarm-out screen [65](#)
- alarm-out, schedule [65](#)
- alarm-out, setting [64](#)
- alarms, connecting [27](#)
- audio
 - assigning a camera [63](#)
 - connecting [25](#)

B

- backing up See [Clip-Copy](#)

C

- Calendar search [120](#)
- cameo mode [117](#)
- cameras
 - adding to PTZ list [62](#)
 - assigning numbers [61](#)
 - assigning titles [61](#)
 - associating with motion detection [85](#), [87](#)
 - cameo setting [117](#)
 - covert [61](#)
 - spot monitor sequencing [69](#)
- clear all data [44](#)
- Clip-Copy [129](#)
 - clip-copy screen [130](#)
 - including text-in data [130](#)
 - naming clips [131](#)
 - verify [130](#)

- configuring devices [61](#)
 - alarms [64](#)
 - audio [63](#)
 - cameras [61](#)
 - display [66](#)
 - remote control [70](#)
 - video [61](#)
- connections
 - alarm [27](#)
 - audio [25](#)
 - Network port [26](#)
 - RS232 port [26](#)
 - RS485 port [27](#)
 - spot monitor [25](#)
 - USB ports [28](#)
 - VGA [25](#)
 - video input [24](#)
 - video out [26](#)
- Covert camera
 - settings [110](#)
 - viewing images from a [111](#)

D

- date/time
 - setting holidays [41](#)
 - setting the [40](#)
- default settings [34](#)
- devices, configuring [61](#)
- display dwell time [69](#)
- DVRNS setup [56](#)
- dwell time, event monitoring [110](#)
- dwell time, live monitoring [104](#)

E

- Event log search [121](#)
- event monitoring [110](#)
- event recording
 - setting alarm-in [76](#)
 - setting up [76](#)

event status screen [101](#)

F

factory reset [28](#)

Freeze mode [106](#)

front panel controls [31](#), [103](#)

G

Go to the Date/Time search [120](#)

group setup

- adding a group [47](#)

- authority levels [48](#)

- changing the authority level [46](#)

- deleting a group [47](#)

H

health check screen [97](#)

holidays, adding [41](#)

I

I/O connector pinouts [145](#)

image adjustment [106](#)

initial setup [34](#)

L

LAN (ADSL) setup [54](#)

LAN (DHCP) setup [54](#)

LAN (Manual) setup [52](#)

Live monitoring [104](#)

- Active cameo mode [105](#)

- adjusting the image [106](#)

- Freeze mode [106](#)

- picture in picture mode [105](#)

- PTZ mode [112](#)

- Zoom mode [106](#)

logging in [35](#)

logout [50](#)

M

main monitor

- defining screen layout [69](#)

- display dwell time [69](#)

- display sequence [68](#)

- settings [68](#)

menus

- Devices [61](#)

- Event [76](#)

- Network [50](#)

- Record [71](#)

- Search Video [119](#)

- Sequence [111](#)

- System [35](#)

modem, setup [55](#)

motion detection

- adjusting the sensitivity [81](#)

- alarm-out notifications [86](#)

- associating cameras [85](#)

- defining the detection zone [82](#)

- ignoring motion interval [83](#)

- selecting PTZ cameras [87](#)

- setting the internal alarm [85](#)

- setting the sensitivity [84](#)

- setup [81](#)

- triggering spot monitors [87](#)

- zone view [83](#)

Motion search [127](#)

mouse

- controlling a PTZ camera using a [114](#)

- display menu [109](#)

- live monitoring button functions [108](#)

- playback button functions [118](#)

N

network

- configuring [51](#)

- setting up [51](#)

- setting up LAN [52](#)

Network port

- connecting [26](#)

notification

- setting callback [59](#)

- setup [58](#)

- setup for mail [58](#)

O

on-screen display (OSD) [66](#)

overview, technical [20](#)

P

panic recording [72](#)

password [35](#)

Picture-in-Picture mode [105](#)

pinouts

- I/O connector [145](#)

- RS485 [145](#)

- playback [116](#)
 - using front panel buttons for [117](#)
 - using the mouse for [118](#)
- Port numbers setup screen [53](#)
- ports
 - network [26](#)
 - RS-232C [26](#)
 - RS485 [27](#)
 - USB [28](#)
- power cord, connecting [29](#)
- power, turning on [34](#), [104](#)
- pre-event recording, setting up [75](#)
- PTZ cameras
 - adding to the list [62](#)
 - assigning an ID [63](#)
 - configuring the port settings for [63](#)
 - selecting a camera [62](#)
- PTZ mode [112](#)
 - controlling PTZ cameras [112](#)
 - controlling PTZ cameras with a mouse [114](#)
 - entering the PTZ mode [112](#)
 - loading a PTZ preset [114](#)
 - positioning PTZ cameras [113](#)
 - setting cameras for motion detection [87](#)
 - setting PTZ camera presets [113](#)

R

- rear panel [23](#)
- recording [115](#)
 - formatting a device for [43](#)
 - panic recording [115](#)
 - record menu [71](#)
 - recording audio [116](#)
 - scheduling recording times [73](#)
 - selecting motion detection cameras [85](#)
 - setting a recording self-check [97](#)
 - setting up [71](#)
 - settings [71](#)
- remote control, setting [70](#)
- return to default settings [34](#)
- RS-232C port, connecting [26](#)
- RS485 port
 - connecting [27](#)
 - connector pinouts [145](#)

S

- S.M.A.R.T. setup [99](#)
- safety precautions [14–17](#)
- screen layout [69](#)

- searching video [118](#)
 - Calendar search [120](#)
 - Event log search [121](#)
 - Go to the Date/Time [120](#)
 - Motion search [127](#)
 - Search menu [119](#)
 - Text-in search [124](#)
 - Text-in search options [126](#)
- Sequence mode [107](#)
- settings
 - exporting current dvr settings [38](#)
 - importing saved dvr settings [38](#)
- setup
 - alarm-out [64](#)
 - audio setup [63](#)
 - DVRNS [56](#)
 - event recording [76](#)
 - initial [34](#)
 - LAN [52](#)
 - LAN using DHCP [53](#)
 - mail notification [58](#)
 - modem [55](#)
 - motion detection [81](#)
 - network [51](#)
 - notification callback [59](#)
 - pre-event recording [75](#)
 - recording [71](#)
 - remote control [70](#)
 - S.M.A.R.T. [99](#)
 - setup screen [35](#)
 - system events [99](#)
 - text-in screen [91](#)
 - user setup screen [46](#)
- shutting down the DVR [50](#)
- specifications [153](#)
- spot monitor
 - associating with motion detection [87](#)
 - displaying cameras sequentially [69](#)
 - selecting the display camera for [111](#)
- spot monitoring [111](#)
- Standard Time Server, synchronizing with [42](#)
- storage
 - disk almost full warning [98](#)
 - setting up an automatic self-check [98](#)
 - storage status [44](#)
- Storage screen
 - formatting a device for recording [43](#)
 - information on the [42](#)

system

- automatic port check [98](#)
- automatic storage check-up [98](#)
- checking for bad disk sectors [98](#)
- notify when disk almost full [98](#)
- recording self-check [97](#)
- system self-check [97](#)

system event actions

- alarm [100](#)
- notify [100](#)
- setup [99](#)

System Event screen [96](#)

system event, health check screen [96](#)

system log, viewing the [39](#)

system software, upgrading the [37](#)

T

technical overview [20](#)

text-in data, including [130](#)

text-in event actions

- alarm settings [95](#)
- associating a spot monitor [96](#)
- camera settings [94](#)
- notification settings [95](#)
- PTZ settings [96](#)

text-in screen, setup [91](#)

Text-in search [124](#)

time overlap [141](#)

U

USB ports, connecting [28](#)

user setup

- adding a user [49](#)
- auto login [49](#)
- auto logout [50](#)
- deleting a user [47](#)
- setting passwords [47](#)
- user setup screen [46](#)

V

video

- backing up using Clip-Copy [129](#)

video clip, naming of [131](#)

video loss

- selecting a substitute camera [89](#)
- setting alarm [89](#)
- setting remote site notification [90](#)
- setting the sensitivity [88](#)

Z

Zoom [106](#)

Honeywell

**www.honeywellvideo.com
+1.800.796.CCTV (North America only)
HVSsupport@honeywell.com**

Document 800-00918 – Rev F – 02/08

© 2007 Honeywell International Inc. All rights reserved. No part of this publication may be reproduced by any means without written permission from Honeywell Video Systems. The information in this publication is believed to be accurate in all respects. However, Honeywell Video Systems cannot assume responsibility for any consequences resulting from the use thereof. The information contained herein is subject to change without notice. Revisions or new editions to this publication may be issued to incorporate such changes.