

---

## *Programmable Thermostat* OWNER'S GUIDE

Congratulations! You made a smart choice when you purchased your new programmable thermostat. It's the smart thermostat that:

- *Keeps you comfortable* by automatically calculating exactly when the furnace or air conditioning should go on to have the house at the desired comfort temperature at the time you want.
- *Saves the maximum amount of energy and money* by remembering to automatically set back the heat or air conditioning when you leave home or sleep.
- *Provides the ultimate in comfort and convenience.* It comes already programmed, so it's your choice—use the pre-programmed schedule or set your own.

This thermostat model (designed for single transformer systems) includes STAGE 1 and STAGE 2 cooling LEDs near the bottom center of the subbase. The STAGE 1 (green) LED lights when the first stage compressor comes on. The STAGE 2 (yellow) LED lights when the second stage compressor comes on.

The LEDs will not be lit simultaneously; if both compressors are running, only the STAGE 2 LED will be lit.

S.M.  
1-90

Form Number 69-0568

# Features

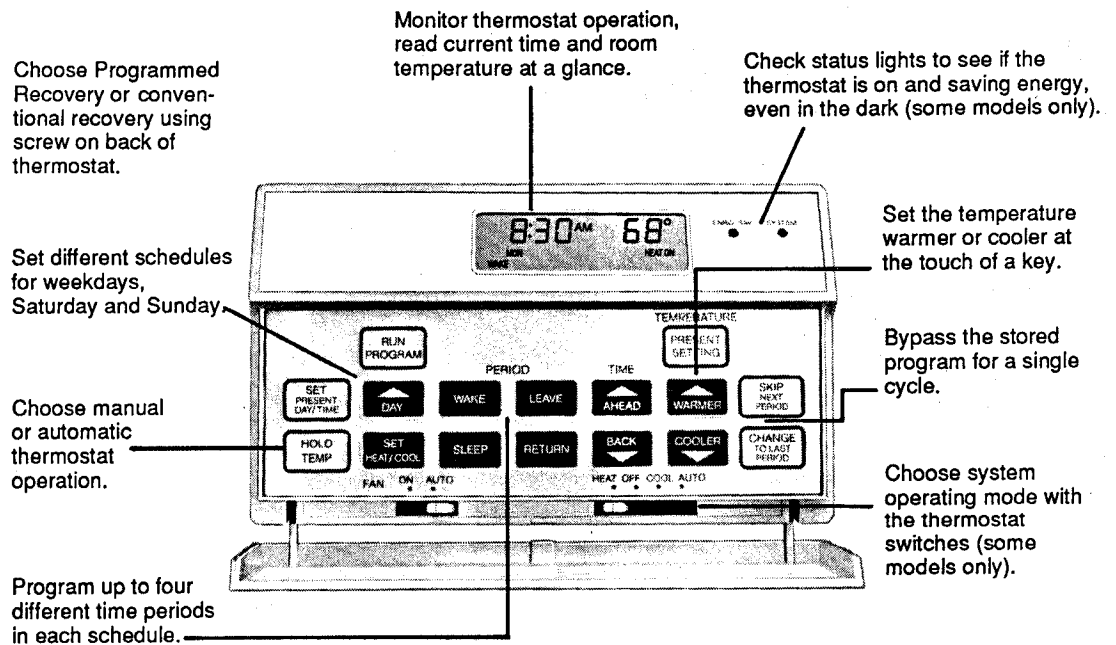

## Simple Four-Step Programming

Of course, you can use the schedule preprogrammed into your new thermostat (see glossary, page 35). But it's an easy matter to program the thermostat to fit your lifestyle.

**1** Set the current time and day. See page 7.

**2** Set the program schedule and heating temperatures. See page 8.

**3** Set the cooling temperatures, if you have air conditioning. See page 15.

**4** Set the system and fan switches, if your thermostat has them. See page 21.

## TABLE OF CONTENTS

Programmed Recovery .....	1-4	Checking the current temperature setting .....	29
Recovery Setting .....	5-6	Maintaining Your Thermostat .....	31-34
Programming Your Thermostat .....	7-22	Removing the thermostat .....	31
Set the current day and time .....	7	Replacing the thermostat .....	32
Set the program schedule and heating temperatures .....	8	Replacing the batteries .....	33
Set the cooling temperatures, if you have air conditioning .....	15	Power outages .....	34
Set the system and fan switches, if your thermostat has them .....	21	Glossary .....	35-37
Operating Your Thermostat .....	23-29	Your Personal Program .....	39-40
Temporarily changing the program .....	23	Troubleshooting Guide .....	41-42
Permanently changing the program .....	25	Typical Questions .....	43-46
Operating the thermostat manually .....	26	Typical Energy Savings .....	47-48
Canceling program settings .....	27	Quick Reference to the Keys .....	49-50
Checking the program times and temperatures .....	29	Index .....	51-52

# PROGRAMMED RECOVERY

**PROGRAMMED RECOVERY—  
BREAKTHROUGH TECHNOLOGY  
SENSES TEMPERATURE MORE  
LIKE YOU DO**

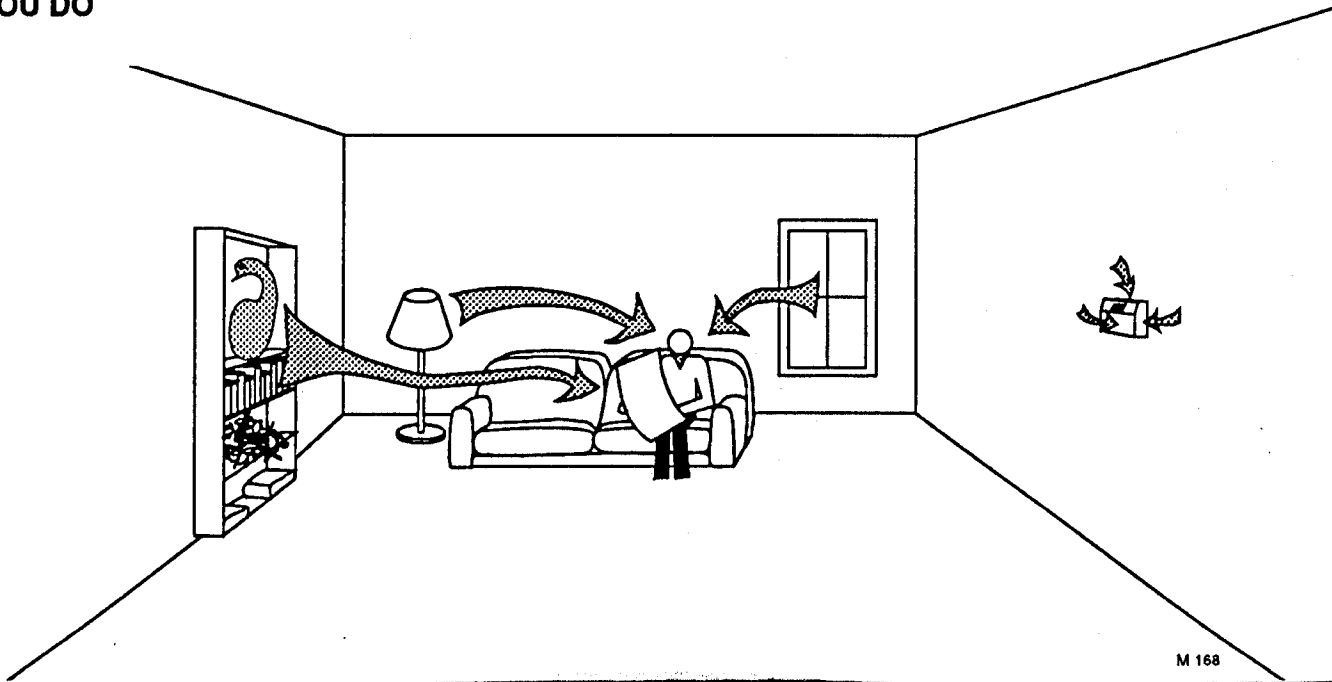

**Your new thermostat is so smart,  
it's almost human.**

- *Your body perceives temperature* from a variety of sources, not only from the air in the room, but also from your surroundings—walls, windows and furnishings.
- *Human beings feel differences* in temperature as slight as two degrees Fahrenheit.
- *Common household thermometers and standard thermostats* sense only air temperature, which may or may not reflect how hot or cold the room actually *feels* to a human being.
- *Your new thermostat* reads the temperature of the wall as well as the air—and responds to temperature changes as little as one degree Fahrenheit—so room temperature is more likely to “feel right” to you and your family.

# PROGRAMMED RECOVERY

## THE OPTIMUM COMFORT AND ENERGY SAVINGS SOLUTION

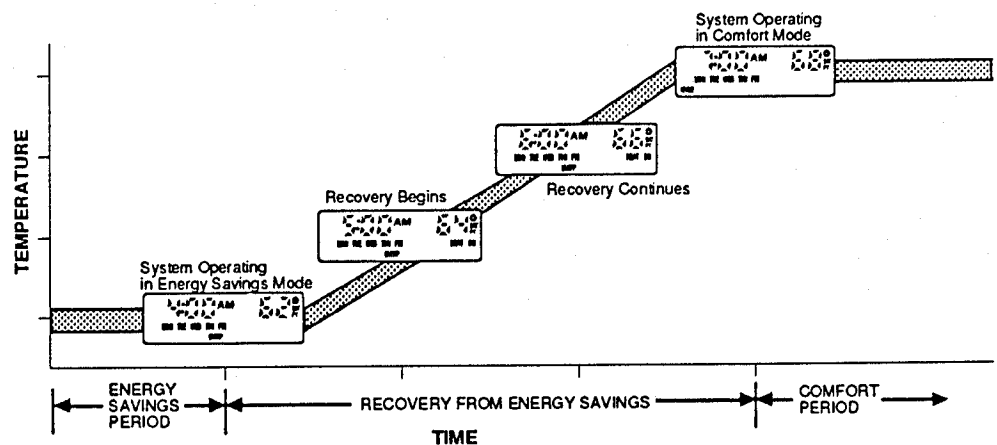

THE THERMOSTAT USES THE SAME SCHEME TO RETURN GRADUALLY TO LOWER COMFORT TEMPERATURE DURING THE COOLING SEASON.

M 171

- *This thermostat is actually a small but powerful computer.* When calculating the exact time to turn on your furnace or air conditioner, it considers (1) air temperature, (2) the temperature of the wall and (3) when you want the comfort temperature established.

3

- *During Programmed Recovery the thermostat increases the control temperature gradually and turns the equipment on and off several times to save energy by avoiding "overshooting" the comfort temperature.* You can see the current control temperature anytime during recovery by pressing the PRESENT SETTING key. On some models, both the SYSTEM and ENRG SAV lights may be lit at the same time during recovery.
- *This "smart" control learns from experience.* Each day it checks how closely it "hit the target" and adjusts the recovery start time accordingly.

It typically takes four to eight days after installation for this thermostat to adjust to the weather, your life style, home construction and heating/cooling system. The thermostat calculates the LEAVE/RETURN recovery separately from the SLEEP/WAKE recovery.

- *With this thermostat you can choose whether you want to use Programmed Recovery or conventional recovery.* Use Programmed Recovery if you want to choose the exact time that the room reaches your *comfort* temperature. Use conventional recovery if you prefer to choose the exact time your furnace or air conditioner *comes on* to start recovery.

4

# RECOVERY SETTING

Your thermostat includes a screw on the back marked "3A", allowing for the Programmed Recovery/conventional recovery choice.

Your thermostat was shipped from the factory with the screw positioned for Programmed Recovery. Your installer may have left the screw in this position, or may have changed it to conventional recovery. Before programming, you must know for which recovery method your thermostat has been set.

RECOVERY SELECTION	3A
PROGRAMMED	IN (FACTORY SETTING)
CONVENTIONAL	OUT 1/2 TO 1 TURN

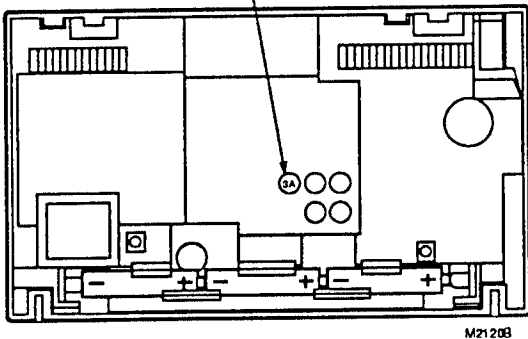

- With Programmed Recovery, the dwelling will reach the comfort temperature at the exact time you have programmed into the thermostat. See pages 1-4 for detailed explanation of Programmed Recovery.
- With conventional recovery, the programmed time will mark the start of recovery; therefore, you should program the start time to be earlier than the desired comfort time. It may require some trial and error to arrive at the best starting time, and the best starting time will vary as the seasons change.

5



To determine which type of recovery is set into your thermostat, make sure thermostat is powered with fresh batteries, or is mounted and powered on the wall (see page 32).

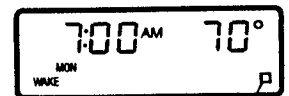

Press key. Check thermostat display.



INDICATES THERMOSTAT IS SET FOR CONVENTIONAL RECOVERY

- If the  shows in the lower right-hand corner (see illustration), the thermostat is set for conventional recovery. If you would rather have Programmed Recovery, remove thermostat from wallplate, turn screw 3A (on back of thermostat) clockwise  until it bottoms. DO NOT OVERTIGHTEN.
- If the  does not show, the thermostat is set for Programmed Recovery. If you would rather have conventional recovery, remove thermostat from wallplate, turn screw 3A (on back of thermostat) out  1/2 to 1 turn.

RECOVERY SETTING

6

# PROGRAMMING YOUR THERMOSTAT

## STEP 1 SET THE CURRENT DAY AND TIME

You can program this thermostat either on the wall or in your hand. SEE PAGE 31 TO FIND OUT HOW TO REMOVE THE THERMOSTAT FROM THE WALL.

Always press the keys with your fingertip or similar blunt tool. Sharp instruments like a pen or pencil point can damage the keyboard.

NOTE: Check the glossary, page 35, for definitions of unfamiliar words.



Press and release. The display shows 1:00 PM Mon.

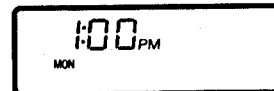

Press and hold until the current day appears in the display.



Press and hold until the current time appears in the display. Be sure AM or PM appears as desired.



You have programmed the current day and time. Go on to Step 2.

7

## IMPORTANT

Before you begin STEP 2, determine if your thermostat is set for Programmed Recovery or conventional recovery. See pages 5-6.

If set for Programmed Recovery, program the times for when you want your home comfortable. The thermostat will decide how early to begin the temperature changes.

If set for conventional recovery, program the times earlier, allowing your home to reach the comfort temperature by the time you get home or wake up. Some trial and error may be required to arrive at the best starting times.

The schedule form on page 39 provides an opportunity to plan your schedule.

## STEP 2 SET THE PROGRAM SCHEDULE AND HEATING TEMPERATURES

Start by programming the WAKE time and temperature for weekdays.

The thermostat requires a program for WAKE. You can program LEAVE, RETURN and SLEEP or not, as you please.



Press and release. Note that the display shows WAKE and the preprogrammed time and temperature.



If you have air conditioning and the display reads COOL, press and release to switch to HEAT.



8

# PROGRAMMING YOUR THERMOSTAT

NOTE: The display shows Programmed Recovery setting in the following instructions.



If display reads SAT or SUN, press and hold until MON TUE WED THU FRI appears.

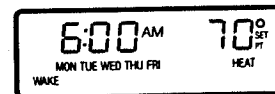

Press and hold until the display shows the desired starting time.



Press and hold until the display shows the desired temperature.



If the display starts to blink while you are holding down TEMPERATURE WARMER or COOLER, you have reached the setting limit. If your thermostat can switch automatically between heating and cooling, the heating temperature must be at least 3

degrees below the air conditioning temperature. For example, if the cooling setting is 75° F, the maximum heating setting is 72° F.

Program the LEAVE time and temperature, if desired.



Press and release. The display shows LEAVE, but no time or temperature.

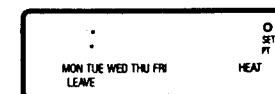

NOTE: You can cancel the LEAVE, RETURN or SLEEP program by holding down the period key until the time and temperature disappear from the display.



Press and hold until the display shows the desired starting time.



Press and hold until the display shows the desired temperature.





# PROGRAMMING YOUR THERMOSTAT

Program the RETURN time and temperature, if desired.

**RETURN**

Press and release. The display shows RETURN, but no time or temperature.



**AHEAD**

**BACK**

Press and hold until the display shows the desired starting time.

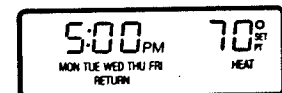

**WARMER**

**COOLER**

Press and hold until the display shows the desired temperature.



11

Program the SLEEP time and temperature, if desired.

**SLEEP**

Press and release. The display shows SLEEP and the preprogrammed time and temperature.

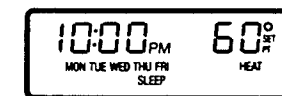

**AHEAD**

**BACK**

Press and hold until the display shows the desired starting time.

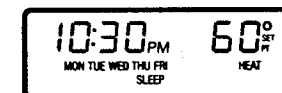

**WARMER**

**COOLER**

Press and hold until the display shows the desired temperature.



12

# PROGRAMMING YOUR THERMOSTAT

Set the SATURDAY schedule. Use the same procedure as for weekdays.



Press and hold until SAT appears on the display.

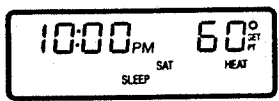

Press WAKE, LEAVE, RETURN or SLEEP to select the time period.



Use the AHEAD/BACK keys to set the time and the WARMER/COOLER keys to set the temperature.



Set the SUNDAY schedule. Use the same procedure as for weekdays.



Press and hold until SUN appears on the display.



Press WAKE, LEAVE, RETURN or SLEEP to select the time period.



Use the AHEAD/BACK keys to set the time and the WARMER/COOLER keys to set the temperature.



You have completed setting the program schedule and heating temperatures. If you have air conditioning, go to Step 3.



NOTE: Some models will show -AC, indicating the thermostat is operating on backup batteries until the thermostat is mounted on the wallplate and the system is powered.



If you do not have air conditioning, press and release to start the program. Go to Step 4.



# PROGRAMMING YOUR THERMOSTAT

## STEP 3 SET THE COOLING TEMPERATURES, IF YOU HAVE AIR CONDITIONING

The program times are the same for both heating and cooling. Only the cooling temperatures need to be programmed if you have already programmed for heating. To set times as you program the cooling temperatures, use the TIME AHEAD and BACK keys as described in Step 2.

First program the WAKE temperature for weekdays.



Press and release. The display shows WAKE and the time and temperature you programmed for heating.

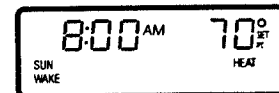

Press and release so COOL shows on the display, along with the preprogrammed cooling temperature.

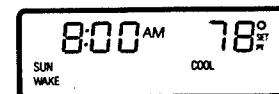

If display reads SAT or SUN, press and hold until MON TUE WED THU FRI appears.

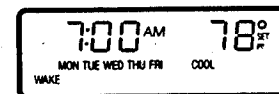

Press and hold until the display shows the desired temperature.



If the display blinks while you hold down TEMPERATURE WARMER or COOLER, you have reached the setting limit. If your thermostat can switch automatically between heating and cooling, the cooling temperature must be at least 3 degrees higher than the corresponding heating temperature. For example, if the heating setting is 70° F, the minimum cooling setting is 73° F.

If you desire a lower cooling setting, the heating setting must first be lowered accordingly.

# PROGRAMMING YOUR THERMOSTAT

Program the LEAVE temperature, if desired.

LEAVE

Press and release. The display shows LEAVE, the time programmed for heating, and 78° F.



↑  
WARMER

↓  
COOLER

Press and hold until the display shows the desired temperature.



Program the RETURN temperature, if desired.

RETURN

Press and release. The display shows RETURN, the time programmed for heating, and 78° F.



↑  
WARMER

↓  
COOLER

Press and hold until the display shows the desired temperature.



17

Program the SLEEP temperature, if desired.

SLEEP

Press and release.

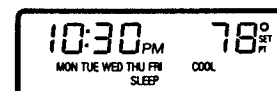

↑  
WARMER

↓  
COOLER

Press and hold until the display shows the desired temperature.



Set the cooling temperatures for the SATURDAY schedule. Use the same procedure as for weekdays.

↑  
DAY

Press and hold until SAT appears on the display.



WAKE

SLEEP

Press WAKE, LEAVE, RETURN or SLEEP to select the time period.

LEAVE

RETURN

18

# PROGRAMMING YOUR THERMOSTAT



Use the WARMER/COOLER keys to set the temperature.



Set the cooling temperatures for the SUNDAY schedule. Use the same procedure as for weekdays.



Press and hold until SUN appears on the display.



Press WAKE, LEAVE, RETURN or SLEEP to select the time period.



19



Use the WARMER/COOLER keys to set the temperature. You have completed programming the cooling temperatures.

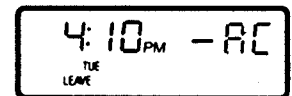

NOTE: Some models will show -AC, indicating the thermostat is operating on backup batteries until the thermostat is mounted on the wallplate and the system is powered.



Press and release to start the program. Go to Step 4.

20

# PROGRAMMING YOUR THERMOSTAT

## STEP 4 SET THE SYSTEM AND FAN SWITCHES, IF YOUR THERMOSTAT HAS THEM.

Depending on thermostat model, some or all of the switch positions shown may be available to you. Note the positions provided on your thermostat, then set the switch(es) as desired.

First set the fan switch.

**FAN ON:** The fan runs continuously. Use for improved air circulation during special occasions or for more efficient electronic air cleaning.

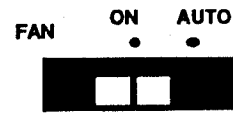

**FAN AUTO:** Normal setting for most homes. The fan goes on and off with the air conditioner in summer. In winter, the fan on most systems starts a few minutes after the furnace comes on. It stops a few minutes after the furnace goes off. The fan starts and stops with the furnace in some electric heat systems.

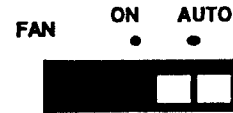

21

Then set the system switch.

**HEAT:** The thermostat controls your heating system.



**OFF:** Both the heating and cooling systems are off.

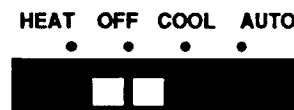

**COOL:** The thermostat controls your air conditioning system.

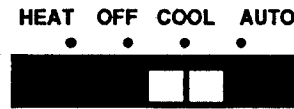

**AUTO:** The thermostat controls either your heating or air conditioning system, depending on room temperature. You have finished programming your thermostat.



Now, while you enjoy precision temperature control, read on to learn about the operating flexibility that makes this thermostat THE SMART CHOICE.

If you removed it from the wall to program, replace it following the procedure on page 32.

22

# OPERATING YOUR THERMOSTAT

## TEMPORARILY CHANGING THE PROGRAM

These features let you custom-tailor the program for those times when someone comes home early, or you're staying up late, or you plan to be out for the evening.

To keep the current temperature through the next program period:



Press and release. The name of the period to be skipped will flash in the display until the next regularly scheduled period starts.

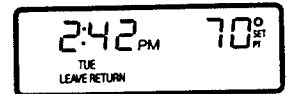

To go back to the temperature of the previous program period:



Press and release. The display will show the name of the previous period and flash "temporary" until the next regularly scheduled period starts.



23

To temporarily raise or lower the temperature for the current period only:



Press and hold until the desired temperature is reached. The display will flash "temporary" until the next programmed time period starts.



If you change your mind:



Press and release to cancel any of the temporary settings.

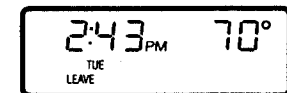

# OPERATING YOUR THERMOSTAT

## PERMANENTLY CHANGING THE PROGRAM

If your schedule changes or you want a different temperature, you can update any setting without affecting the rest of the program.



Press and release the desired period key.



Press and hold until the desired schedule day shows on the display.



Press and hold the Time or Temperature keys until the display shows the desired new program.



Press and release to return to normal operation.

## OPERATING THE THERMOSTAT MANUALLY

This feature is particularly useful when you go on vacation or other extended absence. It does not cancel your program.



Press and release.

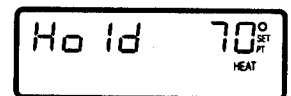

Press and hold to change the temperature setting. After a few seconds the display will show the current temperature.

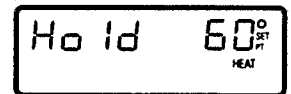

Press and release to check the temperature setting.



Press and release to cancel manual control.

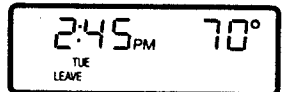

NOTE: Moving the system switch also cancels hold.



# OPERATING YOUR THERMOSTAT

## CANCELING PROGRAM SETTINGS

The thermostat requires time and temperature settings in the WAKE period, but any of the others can be canceled. Week-day, Saturday and Sunday settings are canceled separately.

SLEEP

LEAVE

RETURN

Press and hold the desired period key until the time and temperature clear from the display (about 3 seconds).

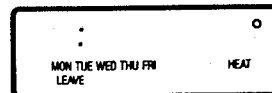

RUN PROGRAM

Press and release to return to normal operation.

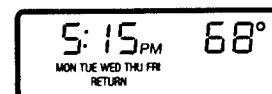

27

## CHECKING THE PROGRAM TIMES AND TEMPERATURES

You can check all the stored settings without affecting the permanent program.

WAKE

SLEEP

LEAVE

RETURN

Press and release the desired period key. The start time and temperature setting will appear on the display.

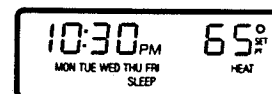

DAY

Press and release to display the next daily time and temperature for that period.

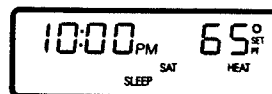

RUN PROGRAM

Press and release to return to normal operation.

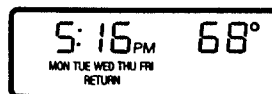

28

# OPERATING YOUR THERMOSTAT

## CHECKING THE CURRENT TEMPERATURE SETTING

Press a single key to compare current room temperature to the settings at any time.

PRESENT  
SETTING

Press and release. The display will show the current temperature setting for several seconds, then revert to the room temperature.



Applicable if thermostat is set for Programmed Recovery. During recovery from energy savings, the setting displayed will not match the programmed setting. This is because the thermostat gradually changes the temperature setting during recovery to provide most efficient use of the heating or cooling equipment.

# MAINTAINING YOUR THERMOSTAT

## REMOVING THE THERMOSTAT

- 1 Loosen the two captive screws at the bottom corners of the case.
- 2 Pull the thermostat out from the bottom.
- 3 Lift the thermostat up and off the base.

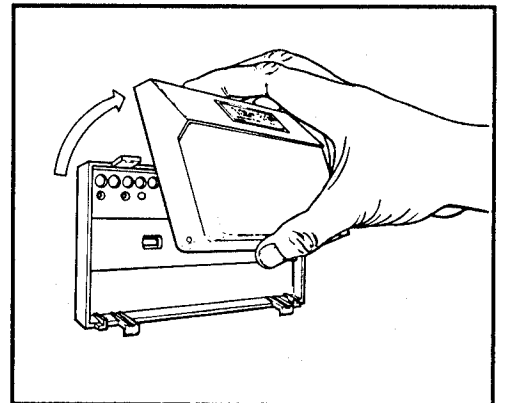
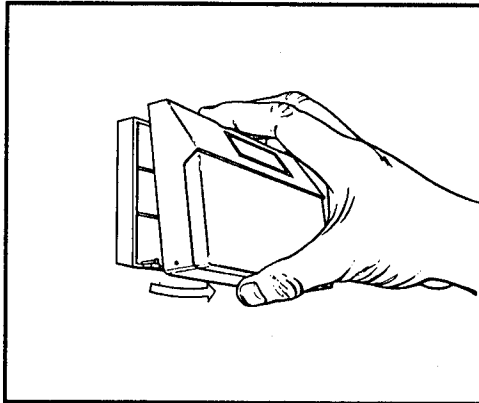
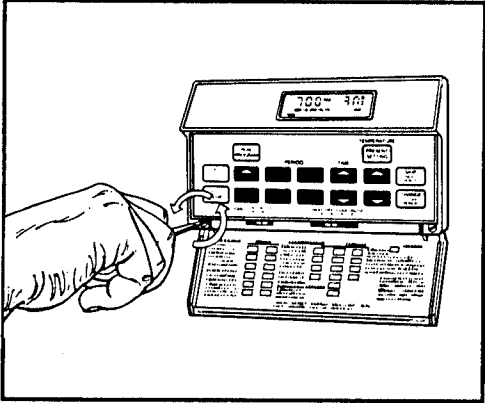

31

## REPLACING THE THERMOSTAT

- 1 Hang the thermostat on the tabs at the top of the base.
- 2 Swing down and press on lower edge until thermostat snaps in place.
- 3 Tighten the captive screws.

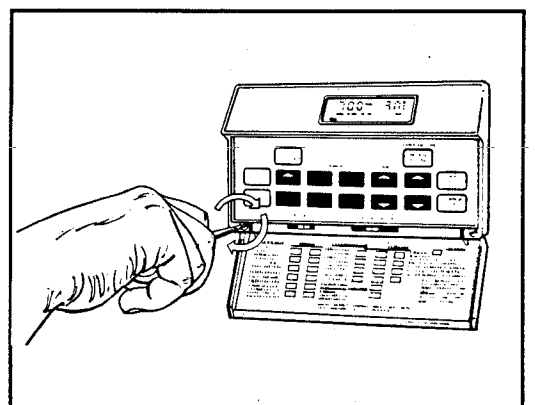
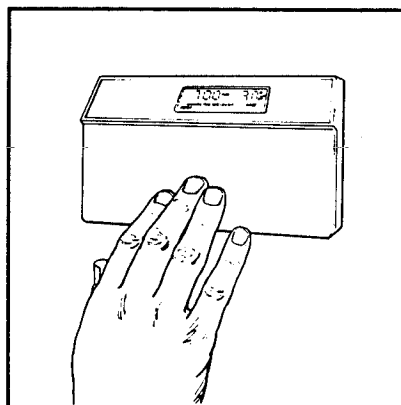
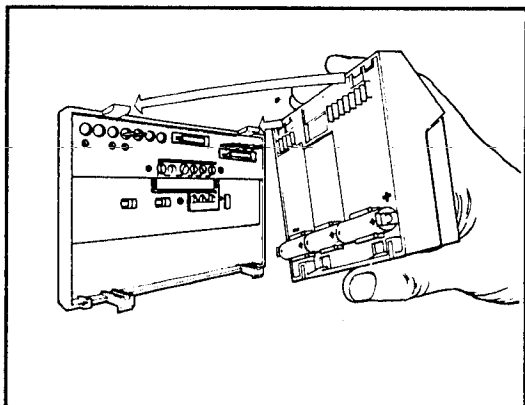

# MAINTAINING YOUR THERMOSTAT

## REPLACING THE BATTERIES

Your thermostat uses three AA or AAA alkaline batteries, depending on model: See the instructions inside the thermostat door to determine the size. The display will flash "REPL BAT" when the batteries get low. Unless the display is blank (indicating the batteries are dead) when you start, you won't have to reprogram the thermostat if you can insert the new batteries within 20-30 seconds of taking out the old ones.

### To replace:

- If your thermostat has a system switch, set it to OFF.
- Remove the thermostat from the wall. See page 31.
- Lift the batteries out of the holder.
- Insert the new batteries, making sure the positive (+) terminals all face toward the right.
- Replace the thermostat on the wall. See page 32.
- Reprogram, if necessary.

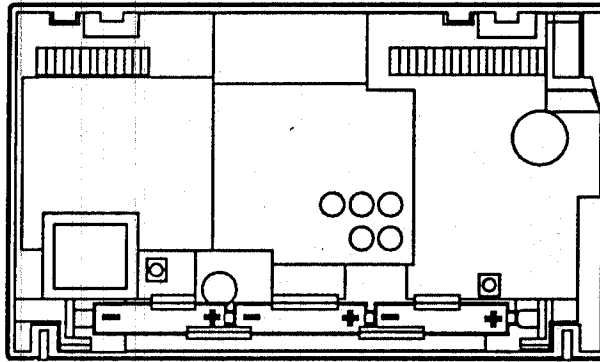

M 466

33

## POWER OUTAGES

Backup batteries will hold the programming and keep the display on during most power outages. Once the power is restored, the system will resume normal operation.

If the display goes off when power is lost, either the backup batteries need to be replaced or are not installed. When power is restored, the display will flash 1:00 PM to remind you to reprogram.

34

# GLOSSARY

## Comfort temperature

The temperature you want in the morning and evening when you're home.

## Conventional Recovery

Recovery starts at the time programmed into the thermostat; house reaches comfort temperature shortly thereafter.

## Energy-saving temperature

The lower (heating) or higher (cooling) temperature that lets you save on heating and cooling costs when you're asleep or away. Also called the setback (heating) or setup setback (heating) or setup (cooling) temperature.

## Program

The times and temperatures you set to define the comfort and energy savings periods for each schedule (weekdays, Saturday, Sunday).

## Programmed Recovery

Recovery automatically starts early enough so your house is at the comfort setting by the time you've chosen.

## Set point

The temperature you set on the thermostat. The thermostat turns the heating or cooling equipment on and off to maintain this temperature at the thermostat location until another temperature setting goes into effect.

## Setup

Raising the temperature in the house for a set period every day in summer for energy savings. The higher temperature is the energy saving temperature.

## Period key

One of the four keys—WAKE, LEAVE, RETURN, or SLEEP—that you press to check or program the start time and temperature for a time period.

## Preprogrammed schedule

This is the schedule programmed into your thermostat at the factory. It sets a night program that provides energy savings if you don't set your own program, or if your personal program is lost for any reason. The program, which is the same for all days of the week, is:

Period	Start Time	Temperature	
		Heating	Cooling
WAKE	6:00 AM	70° F	78° F
LEAVE	-----	No program	-----
RETURN	-----	No program	-----
SLEEP	10:00 PM	60° F	78° F

## Recovery

The time when the thermostat operates the heating or air conditioning equipment to return the house from the energy savings to the comfort temperature. If thermostat is set for Programmed Recovery, the thermostat starts the recovery period early so the house will be at the comfort setting by the time you've chosen.

## Saturday program schedule

The schedule of WAKE, LEAVE, RETURN and SLEEP period start times and temperatures that you program to run on Saturdays.

## Setback

Reducing the temperature in the house for a set period every day in winter for energy savings. The lower temperature is the energy savings temperature.

**Status lights**—Lights on some models that show system operating mode.

**ENRG SAV light**—This light glows during the LEAVE and SLEEP periods.

**SYSTEM light**—This light glows whenever the thermostat is calling for heating or air conditioning.

## Sunday program schedule

The schedule of WAKE, LEAVE, RETURN and SLEEP period start times and temperatures that you program to run on Sundays.

## GLOSSARY

### **Time period**

One of four program periods; WAKE, LEAVE, RETURN and SLEEP available with the thermostat. One period begins when the previous period ends.

**WAKE**—For conventional recovery, the time the recovery to the comfortable temperature begins; for Programmed Recovery, the time period when you want the house at a comfortable temperature while the family gets up and gets ready to leave for work or school. This is the only period that must contain a time and temperature.

**LEAVE**—The time period when you can set back (winter) or up (summer) the temperature for energy savings because the family is usually away from home.

**RETURN**—For conventional recovery, the time the recovery to the comfortable temperature begins; for Programmed Recovery, the time period when you want the house at a comfortable temperature for family activities in the evening before bedtime.

**SLEEP**—The time period when you can set back (winter) or up (summer) the temperature for energy savings because the family is sleeping. Set it to start at your family's normal bedtime.

Often the SLEEP program is set only for the heating season so family members can sleep cool in summer.

### **Weekday program schedule**

The schedule of WAKE, LEAVE, RETURN and SLEEP period start times and temperatures that you program to run Monday through Friday.

# YOUR PERSONAL PROGRAM

You can use the tables below to plan your schedule before you begin programming. If you choose not to program a daytime energy savings period, leave the LEAVE and RETURN periods blank.

## Weekday Program

PERIOD	START TIME	HEATING TEMPERATURE	COOLING TEMPERATURE
WAKE	_____	_____	_____
LEAVE	_____	_____	_____
RETURN	_____	_____	_____
SLEEP	_____	_____	_____

## Saturday Program

PERIOD	START TIME	HEATING TEMPERATURE	COOLING TEMPERATURE
WAKE	_____	_____	_____
LEAVE	_____	_____	_____
RETURN	_____	_____	_____
SLEEP	_____	_____	_____

39

## Sunday Program

PERIOD	START TIME	HEATING TEMPERATURE	COOLING TEMPERATURE
WAKE	_____	_____	_____
LEAVE	_____	_____	_____
RETURN	_____	_____	_____
SLEEP	_____	_____	_____

# TROUBLESHOOTING GUIDE

## *IF...*

Display will not come on.

## *THEN...*

- Check that heat or cool system power is on. If you use batteries, replace with fresh ones.
- Make sure thermostat is correctly mounted on base.

Display flashes during programming.

- You have reached the temperature setting limit. The setting range is 45° F to 88° F. In models with automatic heat-cool changeover, the COOL temperature setting must be at least 3° F above the HEAT temperature setting.

Display flashes during operation.

- Programming has been lost because of a power outage. You must reprogram.

Program is lost due to power outage.

- Check that backup batteries are installed correctly. Replace if necessary. Reprogram the thermostat.

Temperature change occurs at the wrong times.

- Check the program times for the period in question. Be sure that AM and PM indications are correct. Make sure the current day and time are correct. Reprogram if necessary.
- If using Programmed Recovery, remember that the furnace or air conditioner comes on before the WAKE and RETURN start times so the house will be at the desired temperature when the period starts.

41

Heating will not come on.

- Check the fuse or circuit breaker and replace or reset if necessary. If display is blank or says REPL BAT, install fresh batteries.
- Check that switch on thermostat is set to HEAT or AUTO.
- If temperature setting is higher than current temperature, and display says HEAT ON, contact your heating and air conditioning contractor.

Cooling will not come on.

- Check the fuse or circuit breaker and replace or reset if necessary. If display is blank or says REPL BAT, install fresh batteries.
- Check that switch on thermostat is set to COOL or AUTO.
- The thermostat has a built-in time delay on cooling to protect the compressor. Allow up to 10 minutes after changing the setting before the air conditioner starts.
- If temperature setting is lower than current temperature, and display says COOL ON, contact your heating and air conditioning contractor.

The house is too warm or too cool.

- Press PRESENT SETTING to check the current temperature setting.
- If desired, change the time or temperature setting. See page 25.

Display says HEAT ON or system light is on, but no heat is coming from the registers.

- Allow time for the furnace to heat up and the fan to come on before checking for heat at the register.



## TYPICAL QUESTIONS

1. Why do some models of this thermostat have lights?

Battery-operated thermostats do not have indicator lights to conserve battery power. Others may have one or two indicator lights, depending upon the exact model and application.

2. The temperature displayed on the thermostat doesn't always match the room temperature on another thermostat located right next to it. Why?

First, the thermostat is a *very* accurate instrument designed to sense both air temperature and wall temperature, much as your body does. It gives an *average* reading over a period of time. Second, it is self-adjusting, and will take a few days after installation to adapt to your home.

3. Can I control when the furnace comes on in the morning?

When the thermostat is set for Programmed Recovery, it will turn on the furnace as early as necessary to reach your desired comfort temperature at the programmed time. The earliest it will be is 24 minutes per degree setback ahead of your WAKE time, but it will vary depending on your system, the weather and how much the temperature dropped in your house at night.

If you want to control the start time yourself, just switch the thermostat to conventional recovery following the directions on page 6. This way, the furnace won't come on until your programmed WAKE time, but of course it will take a little while for your house to heat up to the comfort temperature.

43

4. What does the HOLD key do?

Remember, whichever way you set your thermostat, if it is so cold outside that your house drops to your sleep temperature, the furnace will turn on and off at night to control the temperature at that setting.

It bypasses *all* program settings and *holds* the temperature at the present setting. To increase or decrease the temperature while on HOLD, use the WARMER-COOLER keys. Touching RUN PROGRAM will return the device to programmed operations.

5. How long does the HOLD key hold?

Forever! The HOLD button will hold the temperature indefinitely. The only way to release it is to push the RUN PROGRAM button or change the system switch positions if applicable. For a *temporary* temperature change, simply press WARMER or COOLER key. This temporary setting will last until the next scheduled program begins.

6. How can this thermostat save energy when it comes on and off so many times early in the morning hours?

Two ways. First, it *saves* energy (and money) by setting back the temperature for *blocks* of time during the day or night. Second, it *conserves* energy by *recovering gradually* to the desired temperature. This prevents *overshooting* your comfort set point (and wasting energy) or *undershooting* the comfort set point (and forcing you to change the thermostat setting, also wasting energy).

## TYPICAL QUESTIONS

**7. My thermostat has ENRG SAV and SYSTEM lights. Why do they both go on at the same time? (For example: during the sleep period.)**

During Programmed Recovery, when you recover *gradually* to a next set point, you will stay in the energy-saving mode until the next programmed time is reached. But the system will operate intermittently to *gradually* raise the temperature to your desired comfort level before the time you've set as your WAKE time. You will always be saving energy until the next period's *actual* set point is reached.

**8. Why don't all thermostat models have AUTO (automatic) changeover from heating to cooling?**

Most parts of the country don't have wide temperature swings during a 24-hour period, so it is not necessary. Desert climates, such as Phoenix, are the exception, because of wide variations in temperature which may require both the air conditioner and furnace to run during different times within a given 24-hour period.

45

**9. Sometimes my thermostat doesn't allow the house temperature to drop to my SLEEP setting before it starts bringing the furnace on. Why?**

When you start your SLEEP period, the thermostat will turn off your furnace and your house temperature will start to fall. After that, the thermostat is out of the picture until the house temperature falls all the way to your SLEEP temperature setting or until recovery starts.





In mild weather or with good insulation, your house temperature may not fall all the way to your SLEEP temperature setting and the thermostat won't turn on your furnace until the time to recover back up to your comfort setting.

46





# TYPICAL ENERGY SAVINGS

## PERCENTAGE OF HEATING ENERGY YOU CAN SAVE

ONE 10° F ENERGY SAVINGS PERIOD\*  
70° TO 60° F; 8 HRS./DAY

-  9% TO 11%
-  12% TO 13%
-  14% TO 15%
-  16% TO 18%

TWO 10° F ENERGY SAVINGS PERIODS\*  
70° TO 60° F; 8 HRS./DAY, 8 HRS./NIGHT

-  18% TO 24%
-  23% TO 25%
-  25% TO 29%
-  UP TO 30%

\* Savings for a 5° F, heating setback are at least 1/2 of savings for a 10° F setback.  
Actual savings depend on your home, geographic location, number of energy saving periods and energy savings temperature.  
If you have a heat pump, your heating savings may be greater than those shown.

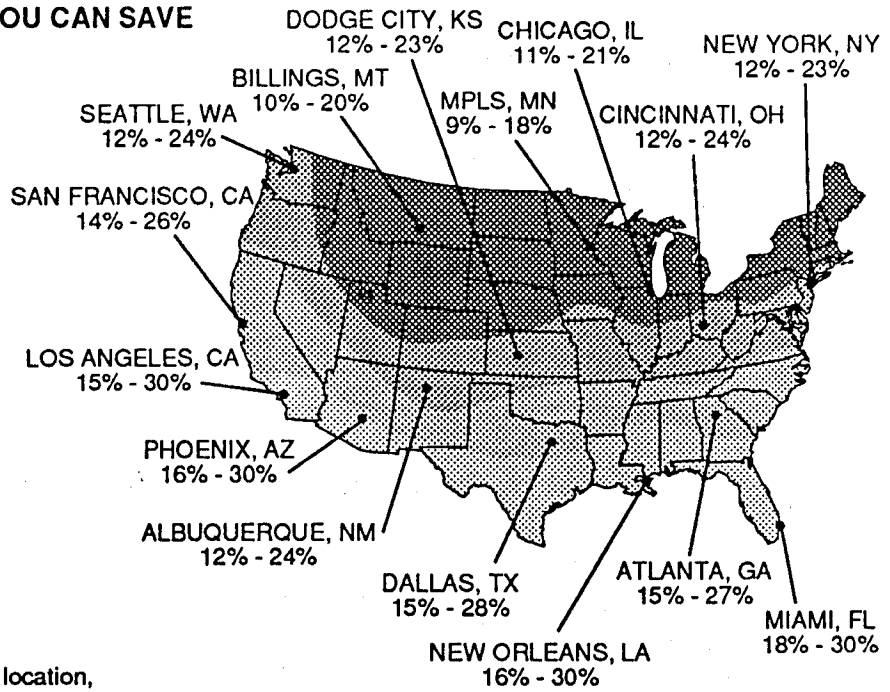





M 167





47

## PERCENTAGE OF COOLING ENERGY YOU CAN SAVE

ONE 5° F ENERGY SAVINGS PERIOD\*  
75° TO 80° F; 8 HRS./DAY

-  7% TO 9%
-  10% TO 11%
-  12% TO 14%
-  15% TO 18%

TWO 5° F ENERGY SAVINGS PERIODS\*  
75° TO 80° F; 9 HRS./DAY, 7 HRS./NIGHT

-  11% TO 15%
-  16% TO 18%
-  19% TO 22%
-  23% TO 33%

\* Actual savings depend on your home, geographic location, number of energy saving periods and energy savings temperature.

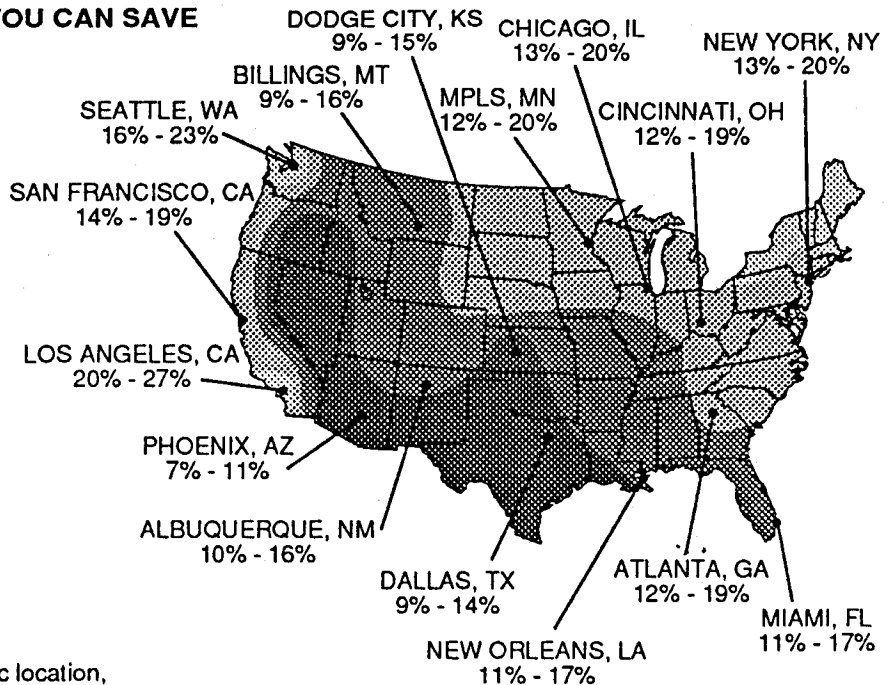

M 211

# QUICK REFERENCE TO THE KEYS

Press these keys to:



Begin the current day or time programming.



Set the day of the week and select the program day during programming.



Select the time period to program or review. Comfort times depend on selection of Programmed Recovery or conventional recovery.



Switch between heat and cool modes during programming or when reviewing the program.



Set the time ahead and back. Hold either key down to change the setting faster.



49



Set the temperature while programming and temporarily change the temperature during operation. Hold either key down to change the setting faster.



Hold any temperature you desire for an extended period.



Change the temperature to the set point of the previous period.



Maintain the current temperature through the next program period.



Start your programmed schedule, cancel temporary program changes.



See the current temperature setting. Setting may not match programmed setting during recovery from energy savings.

REFERENCE TO KEYS

50

# INDEX

Automatic Changeover .....	9, 16	Lights .....	* , 36	Set fan switch .....	21
Batteries, replacement .....	33	Maintenance .....	31	Set heating temperatures .....	8
Blinking display .....	41	Manual operation .....	26	Set program schedule .....	8
Canceling programs .....	27	Operation .....	23	Set system switch .....	22
Change temperature .....	25	Period keys .....	36	Setback .....	36
Checking present setting .....	29	Personal program .....	39	Setting limits .....	9, 16
Checking programs .....	28	Power outage .....	34	Setup .....	35
Clock display .....	* , 7	Preprogrammed schedule .....	36	Skip .....	23
Conventional Recovery .....	5	Present setting .....	29	Sunday program .....	14, 19, 36
Cooling temperatures .....	15	Program schedule .....	39	Switch, fan .....	21
Day .....	7	Programmed recovery .....	1		
Display .....	* , 7	Programming overview .....	*		

51

Energy Savings, Typical .....	47	Programming steps .....	7	Switch, system .....	22
Energy-saving temperature .....	35	Quick reference to the keys .....	49	SYSTEM light .....	36
ENRG SAV light .....	36	RETURN .....	37, 49	System switch .....	22
Fan switch .....	21	Removing thermostat .....	31	Table of Contents .....	i
Features .....	*	Replacing batteries .....	33	Temporary program changes .....	23
Flashing display .....	41	SLEEP .....	37, 49	Time .....	7
Glossary .....	35	Saturday program .....	13, 18, 36	Time period .....	37
Heating temperatures .....	8	Set cooling temperatures .....	15	Troubleshooting .....	41
Hold temperature .....	26	Set current day .....	7	WAKE .....	37, 49
Keys .....	49	Set current time .....	7	Weekday program .....	8, 15, 37
LEAVE .....	37, 47				

\*See the product features inside the front cover.

This equipment is a Class B digital apparatus which complies with Canadian Radio Interference Regulations, CRC c. 1374.

S.M.  
Rev. 1-90

Printed in Taiwan R.O.C.

Form Number 69-0397—1