

CANDY



MAINTENANCE AND USER'S GUIDE

EN

EN 02-19

GUIDE D'ENTRETIEN ET D'UTILISATION

FR

FR 20-40

GUIDA PER L'USO E LA MANUTENZIONE

IT

IT 41-62

GUÍA DE MANTENIMIENTO Y DEL USUARIO

ES

ES 63-82

MANUAL DE INSTRUÇÕES DO FRIGORÍFICO 4 PORTAS CHG

PT

PT 83-101

Contents

Safety and warning information	2	Using your appliance.....	13
Scrapping old appliance	5	Helpful hints and tips.....	15
Installing your new appliance.....	9	Cleaning and care.....	16
Description of the appliance.....	11	Troubleshooting.....	17
Display controls.....	12		

 This appliance is in accordance with the following EU guidelines: 2006/95/EC and 2004/108/EC and 2009/125/EC and EC.643/2009 and 2002/96/EC



Safety and warning information

For your safety and correct usage, before installing and first using the appliance, read this user manual carefully, including its hints and warnings. To avoid unnecessary mistakes and accidents, it is important to make sure that all people using the appliance are thoroughly familiar with its operation and safety features. Save these instructions and be sure that they remain with the appliance if it is moved or sold, so that anyone using it, throughout its life, will be properly informed on its usage and safety notices. For the safety of life and property, keep the precautions of these user's

instructions as the manufacturer is not responsible for damages caused by omission.

Safety for children and others who are vulnerable people

- This appliance can be used by children aged from 8 years and above and persons with reduced physical, sensory or mental capabilities or lack of experience and knowledge if they have been given supervision or instruction concerning use of the appliance in a safe way and understand the hazards involved. Children shall not play with the appliance. Cleaning and user maintenance shall not be made by children without supervision.
- Keep all packaging away

from children as there is risk of suffocation.

- If you are discarding the appliance, pull the plug out of the socket, cut the connection cable (as close to the appliance as you can) and remove the door to prevent children playing from suffering an electric shock or from closing themselves inside it.
- If this appliance, featuring a magnetic door seals, is to replace an older appliance having a spring lock (latch) on the door or lid, be sure to make the spring lock unusable before you discard the old appliance. This will prevent it from becoming a death trap for a child.

General safety



- **WARNING** — This appliance is intended to be used in household and similar applications such as
 - staff kitchen areas in shops, offices and other working environments;
 - farm houses and by clients in hotels, motels and other residential type environments;
 - bed and breakfast type

environments;
-catering and similar non-retail applications

- **WARNING** — Do not store explosive substances such as aerosol cans with a flammable propellant in this appliance.
- **WARNING** — If the supply cord is damaged, it must be replaced by the manufacturer, its service agent or similarly qualified persons in order to avoid a hazard.
- **WARNING** — Keep ventilation openings, in the appliance enclosure or in the built-in structure, clear of obstruction.
- **WARNING** — Do not use mechanical devices or other means to accelerate the defrosting process, other than those recommended by the manufacturer.
- **WARNING** — Do not damage the refrigerant circuit.
- **WARNING** — Do not use electrical appliances inside the food storage compartments of the appliance, unless they are of the type recommended by the manufacturer.

- **WARNING** — The refrigerant and insulation blowing gas are flammable. When disposing of the appliance, do so only at an authorized waste disposal centre. Do not expose to flame.

Refrigerant

The refrigerant isobutene (R600a) is contained within the refrigerant circuit of the appliance, a natural gas with a high level of environmental compatibility, which is nevertheless flammable. During transportation and installation of the appliance, ensure that none of the components of the refrigerant circuit becomes damaged. The refrigerant (R600a) is flammable.



Caution: risk of fire

If the refrigerant circuit should be damaged:

- Avoid opening flames and sources of ignition.
- Thoroughly ventilate the room in which the appliance is situated.

It is dangerous to alter the specifications or modify this product in any way.

Any damage to the cord may cause a shortcircuit, fire, and/or electric shock.



Electrical safety

1. The power cord must not be lengthened.
2. Make sure that the power plug is not crushed or damaged. A crushed or damaged power plug may overheat and cause a fire.
3. Make sure that you can access the main plug of the appliance.
4. Do not pull the main cable.
5. If the power plug socket is loose, do not insert the power plug. There is a risk of electric shock or fire.
6. You must not operate the appliance without the interior lighting lamp cover.
7. The fridge is only applied with power supply of single phase alternating current of 220~240V/50Hz. If fluctuation of voltage in the district of user is so large that the voltage exceeds the above scope, for safety sake, be sure to apply A.C. Automatic voltage regulator of more than 350W to the fridge. The fridge must

employ a special power socket instead of common one with other electric

appliances. Its plug must match the socket with ground wire.

SCRAPPING OLD APPLIANCE



By ensuring that this product is properly disposed of, you will help prevent potential negative consequences for the environment and human health, which could otherwise arise due to inappropriate waste handling of this product on reaching the end of its working life.

With proper disposal of the appliance, it is possible to recover valuable raw materials! This appliance is marked as conforming to the European Directive 2012/19/EU on Waste of Electrical and Electronic Equipment (WEEE).

The symbol on the product indicates that this appliance may not be treated as normal household waste; it must, instead, be delivered over to the nearest collection point for the recycling of electrical and electronic equipment. Disposal must be effectuated in accordance with the environmental regulations in force for waste disposal.

For more detailed information about treatment, recovery and recycling of this product, contact the competent public office (Department of Ecology and Environment), your home household waste disposal service, or the shop where you purchased the product.

Cut and dispose of the power cord with the plug.

Up until appropriate disposal, do not damage the tubing because they contain the refrigerant gas.

For the disposal of packing materials, follow local regulations. WEEE contains both polluting substances (which can cause negative consequences for the environment) and basic components (which can be re-used).

It is important to have WEEE subjected to specific treatments, in order to remove and dispose properly all pollutants, and recover and recycle all materials.

Individuals can play an important role in ensuring that WEEE does not become an environmental issue; it is essential to follow some basic rules:

-WEEE should not be treated as household waste.

-WEEE should be handed over to the relevant collection points managed by the municipality or by registered companies.

In many countries, for large WEEE, home collection could be present.
- when you buy a new appliance, the old one may be returned to the retailer who has to collect it free of charge on a one-to-one basis, as long as the equipment is of equivalent type and has the same functions as the supplied equipment.

Conformity

CE This equipment, in the parts intended to come into contact with food products, is in conformity with the requirements of EC Regulation No. CE 1935/2004. Apparatus conforms with European Directive 2004/108/EC, 2006/95/EC and successive amendments.

Daily use

- Do not store flammable gas or liquids in the appliance, There is a risk of an explosion.
- Do not operate any electrical appliances in the appliance (e.g. electric ice cream makers, mixers etc.).
- When unplugging always pull the plug from the mains socket, do not pull on the cable.
- Do not place hot items near the plastic components of this appliance.
- Do not place food products directly against the air outlet on the rear wall.
- Store pre-packed frozen food in accordance with the frozen food manufacturer's instructions.
- The appliances manufacturer's storage recommendations should be strictly adhered to. Refer to relevant instructions for storage.
- Do not place carbonated or fizzy drinks in the freeze compartment as it creates pressure on the container, which may cause it to explode, resulting in damage to the appliance.
- Frozen food can cause frost burns if consumed straight from the freezer compartment.
- Do not place the appliance in direct sunlight.
- Keep burning candles, lamps and other items with naked flames away from the appliance so that do not set the appliance on fire.
- The appliance is intended for keeping food stuff and/or beverages in normal household as explained in this instruction booklet The appliance is heavy. Care should be taken when moving it.
- Do not remove nor touch items from the freezer compartment if your hands are damp/wet, as this could cause skin abrasions or frost/freezer burns.
- Never use the base,

- drawers, doors etc. to stand on or as supports.
- Frozen food must not be refrozen once it has been thawed out.
 - Do not consume ice popsicles or ice cubes straight from the freezer as this can cause freezer burn to the mouth and lips.
 - To avoid items falling and causing injury or damage to the appliance, do not overload the door racks or put too much food in the crisper drawers.

caution!

Care and cleaning

- Before maintenance, switch off the appliance and disconnect the mains plug from the mains socket.
- Do not clean the appliance with metal objects, steam cleaner, ethereal oils, organic solvents or abrasive cleansers.
- Do not use sharp objects to remove frost from the appliance. Use a plastic scraper.

Installation Important!

- For electrical connection carefully, follow the instructions given in this manual.

- Unpack the appliance and check if there are damages on it. Do not connect the appliance if it is damaged. Report possible damages immediately to the place you bought it. In this case retain packing.
- It is advisable to wait at least four hours before connecting the appliance to allow the oil to flow back in the compressor.
- Adequate air circulation should be around the appliance, lacking this leads to overheating. To achieve sufficient ventilation, follow the instructions relevant to installation.
- Wherever possible the back of the product should not be too close to a wall to avoid touching or catching warm parts (compressor, condenser) to prevent the risk of a fire, follow the instructions relevant to installation.
- The appliance must not be located close to radiators or cookers.
- Make sure that the mains plug is accessible after the installation of the appliance.

Service

- Any electrical work required to do the servicing of the appliance should be carried out by qualified electrician or competent person.
- This product must be

serviced by an authorized Service Center, and only genuine spare parts must be used.

- 1) If the appliance is Frost Free.
- 2) If the appliance contains freezer compartment.

Installing your new appliance

Before using the appliance for the first time, you should be informed of the following tips.

Ventilation of appliance



In order to improve efficiency of the cooling system and save energy, it is necessary to maintain good ventilation around the appliance for the dissipation of heat. For this reason, sufficient clear space should be available around the refrigerator. Suggest :It is advisable for there to be at least 75mm of space from the back to the wall, at least 100mm from its top, at least 100mm from its side to the wall and a clear space upfront to allow the doors to open 132° . See in follow diagrams.

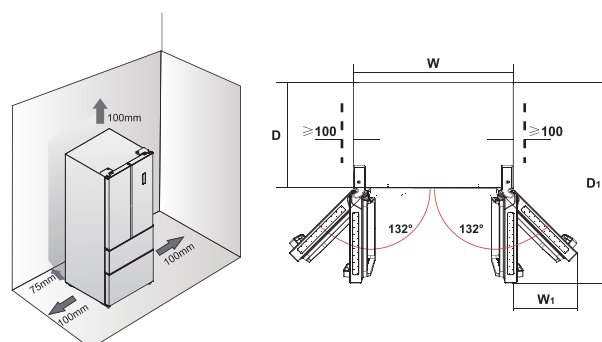

Relevant information

Constant	W	W1	D	D1
mm	700	264	650	1018

Note!

- This appliance performs well in the below climate class. It may not work properly if being left at a temperature above or below the indicated range for a long period.

Climate class	Ambient temperature
SN	+10°C to +32°C
N	+16°C to +32°C
ST	+16°C to +38°C
T	+16°C to +43°C

- Stand your appliance in a dry place to avoid high moisture.
- Keep the appliance out of direct sunlight, rain or frost. Stand the appliance away from heat sources such as stoves, fires or heaters.

Leveling of appliance

- For sufficient leveling and air circulating in the lower rear section of the appliance, the bottom feet may need to be adjusted. You can adjust them by your fingers or a suitable spanner.
- To allow the doors to self-close, tilt back the top backwards for about 10mm or 0.5° by turning the adjustable feet.

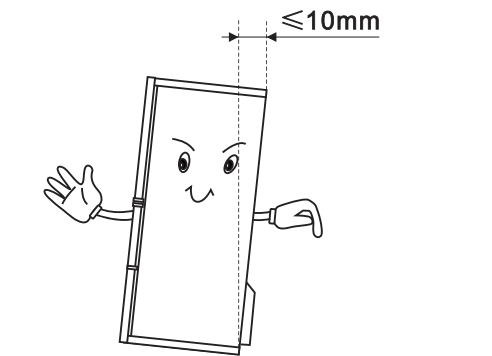

●Whenever you want to move the appliance, remember to turn the feet back up so that the appliance can roll freely. Reinstall the appliance when relocating.

Caution! The rollers, which are not castors, should be only used for forward or backward movement. Moving the refrigerator sideways may damage your floor and the rollers.

Flipper clapboard

● Before closing the fridge door, the flipper clapboard should be correctly in position to allow the door to close properly. See pictures below:

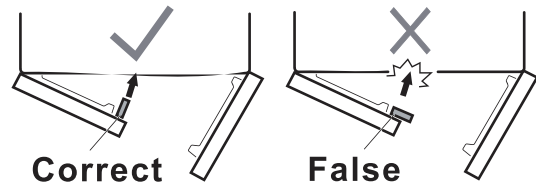

Note: It is normal that the flipper clapboard feels hot as there is a heater installed inside the clapboard to prevent dewing.

Description of the appliance

- 1.Cabinet
- 2.LED light
- 3.Covered dairy rack
- 4.Middle rack
- 5.fridge door seal
- 6.Folded shelf
- 7.Flipper clapboard
- 8.Bottle rack

- 9.Crisper cover
- 10.Fruits and vegetables Crisper
- 11.Bottom rack
- 12.Upper freezer drawer
- 13.Upper freezer salver
- 14.Lower freezer drawer
- 15.Ice cube tray
- 16.Adjustable bottom feet



Note: Due to unceasing modification of our products, your refrigerator may be slightly different from this Instruction Manual, but its functions and using methods remain the same.

Display controls



Use your appliance according to the following control regulations, your appliance has the corresponding functions and modes as the control panels showed in the pictures below. When the appliance is powered on for the first time, the backlighting of the icons on display panel starts working. If no buttons have been pressed and the doors are closed, the backlighting will turn off.



Controlling the temperature

We recommend that when you start your refrigerator for the first time, the temperature for the refrigerator is set to 3°C and the freezer to -18°C. If you want to change the temperature, follow the instructions below.

Caution! When you set a temperature, you set an average temperature for the whole refrigerator cabinet. Temperatures inside each compartment may vary from the temperature values displayed on the panel, depending on how much food you store and where you place them. Ambient temperature may also affect the actual temperature inside the appliance.

All the buttons are locked if the icon “” is illuminated, press the “Mode/  5s” button for 5 seconds to unlock them.

1. Room

You can activate Fridge OR Freezer compartment temperature setting by pressing “Room” button.

2. Temp

After fridge temperature setting is activated, press “Temp.” button to set fridge temperature between 8°C and 2°C as needed. And the control panel will display corresponding value according to the following sequence.



After freezer temperature setting is activated, press “Temp.” button to set fridge temperature between -15°C and -25°C as needed. And the control panel will display

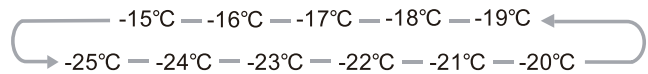

corresponding value according to the following sequence.

3. Mode/ 5s

You can select different modes by pressing the “Mode/  5s” button. When certain mode is selected, wait for the corresponding icon flashing for 10 seconds. Buzzer will sound two times afterwards and the icon will be illuminated, which means the setting is completed.

4. Super cool

Super Cool can refrigerate your food much faster, keeping food fresh for a longer period

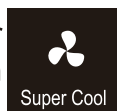

- When the super cool function is activated, the corresponding icon will be illuminated.
- Super cool automatically switches off after 6 hours and the refrigerator temperature setting displays 2°C.

5. Super Freeze

Super Freeze can quickly lower frozen temperature and freeze your food much faster than usual.

This can lock the vitamin and nutrition of food as fresh as you bought it and keep your food much longer.

1. Press "Super Freeze" button to activate the super freeze function. The light is taken on. Super freeze automatically switches off after 32 hours and the freezer temperature setting displays -24°C .

2. In case of the maximum amount of food to be frozen, please wait about 24h after pressing the super freezer button and then press "Super Freeze" button twice, in the meantime, maximum amount of food can be put into the freezer. Super freeze automatically switches off 32 hours after the second pressing.

3. When super freeze function is on you can switch off super freeze function by pressing "Super Freeze" or "Freezer" button and the freezer temperature setting will back to the previous.

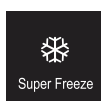

6. Holiday

If you are going to be away for a long period of time, holiday function will be your best choice.



● When the holiday function is activated, the temperature of the refrigerator is automatically switched to 15°C to minimize the energy consumption.

Important! Do not store any food in the fridge during this time.

7. Energy saving

With energy saving function, the temperature of refrigerator is automatically switched to 8°C and the temperature of freezer is automatically switched to -18°C .



8. Artificial intelligence

When this function is activated, the temperature of the appliance is automatically adjusted.



Note: If you want to switch off the mode you have selected, simply press the "Room" button and set the temperature of corresponding compartment as you need.

9. Door alarm

If the door of fridge or freezer is open for over 1 minutes, the door alarm will sound and the fridge or freezer will display "■" on the control panel. In case of door alarm, buzzer will sound 3 times every 1 minute and will automatically stop alarming 10 minutes later.

● To save energy, please avoid keeping the door open for a long time when using the appliance. The door alarm can be cleared by closing the door.

Using your appliance

1. Using your refrigerator compartment

The refrigerator compartment is suitable for storage of vegetables and fruit. Food inside shall be packed to store in order to avoid losing moisture or flavor permeating into other foods.

Caution! Never close the refrigerator door while the shelves, crisper and/or telescopic slides are extended. It may damage both them and the refrigerator.

Door racks

● The door racks consisting of covered dairy racks, middle racks, wine racks and bottom racks are suitable for the storage of eggs, canned liquid, bottled drinks and packed food.

● The middle door rack can be placed at different heights according to your need. Before you lift up the door shelf vertically, please take the food out.



Note: All the door racks and covers are completely removable for cleaning.

Shelves

- There are two removable glass shelves (upper and lower shelves) and one folded shelf (middle shelf) in the refrigerator compartment.
- When you remove the removable shelves, gently pull them forward until the shelf comes clear of the shelf guides. Make sure there is no obstacle behind and gently push the shelf back into the position when you return the shelves.

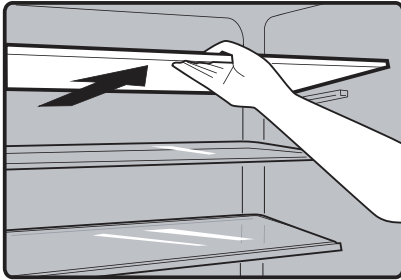

- Folded shelf can be adjusted and folded to achieve different storage volumes according to your need.
 1. If you want the storage space to be separated, please split the front and back shelves of the folded shelf (See picture above).
 2. If you lift up the front shelf and push it inside, you can store large size food in the front and small size food at the back.

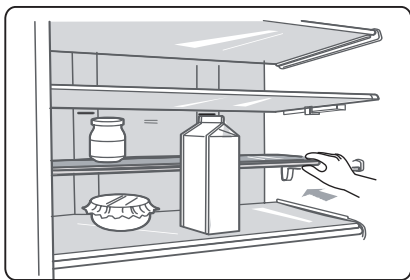

3. After the front shelf is completely pushed inside, fold the shelf to achieve larger volume.

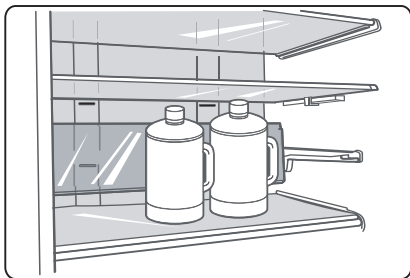

Fresh 0 cool

- The temperature there is about 2-3°C lower than that in the refrigerator chamber.
- It is used to store fish, meat and other erodible food.

Note: It may not be available according to the model.

Wine rack

- It is your optional choice to store eggs or wine.

Note: It may not be available according to the model.



Crispers

- The crisper, mounted on telescopic extension slides, is for storing vegetables and fruits.
- When you remove the crispers, pull them forward, then separate the crisper from the slides. Remember to empty food in the crisper firstly. Once you have removed the drawers, ensure the slides are pushed back fully.

Crisper cover

- It is for controlling the temperature of the crisper and avoiding the vegetable losing moisture. You can adjust the humidity inside the crisper by using the sliding block.

2. Using your freezer drawer

- The freezer drawers are suitable for storage of foods required to be frozen, such as meat, ice cream and others.

The drawers

- The drawers are mounted on telescopic extension slides and can be removed in the same way as removing the crispers in the refrigerator compartment.

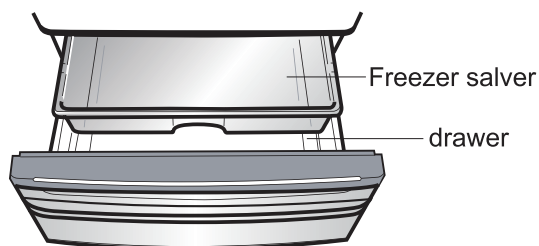

Freezer salver

- The freezer salver is suitable for the storage of small size food required to be frozen.
- If you want to remove it to save space, please lift it up by applying force on its two sides and pull it out. To return it, just do the opposite.

Caution! Ensure that bottles are not stored in the freezer as freezing may cause the bottle to break.

Ice cube tray

- It is used to make ice cubes. To make ice cubes, please fill water into the ice cube trays and the water level shall not exceed the top line (ideally eighty percent of the ice tray volume). Place the tray into the lower freezer drawer and wait at least two hours for the ice cubes to be formed. After the cubes are formed, gently twist the tray to separate the cubes and trays.

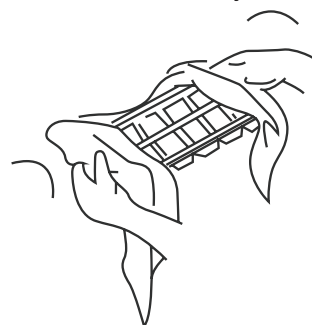

Helpful hints and tips

Energy saving tips

We recommend that you follow the tips below to save energy.

- Try to avoid keeping the door open for long periods in order to conserve energy. Ensure the appliance is away from any sources of heat (Direct sunlight, electric oven or cooker etc)
- Don't set the temperature colder than necessary.
- Don't store warm food or evaporating liquid in the appliance.
- Place the appliance in a well ventilated, humidity free, room. Please refer to Installing your new appliance chapter.
- If the diagram shows the correct combination for the drawers, crisper and shelves, do not adjust the combination as this is designed to be the most energy efficient configuration.

Hints for fresh food refrigeration

- Don't place hot food directly into the refrigerator or freezer, the internal temperature will increase resulting in the compressor to work harder and will consume more energy.
- Do cover or wrap the food, particularly if it has a strong flavor.
- Place food properly so that air can circulate freely around it.

Hints for refrigeration

- Meat (All Types) Wrap in polythene food: wrap and place on the glass shelf above the vegetable drawer. Always follow food storage times and use by dates suggested by manufacturers.
- Cooked food, cold dishes, etc.: They should be covered and may be placed on any shelf.
- Fruit and vegetables: They should be stored in the special drawer provided.

- Butter and cheese:

Should be wrapped in airtight foil or plastic film wrap.

- Milk bottles:

Should have a lid and be stored in the door racks.

Hints for freezing

- When first starting-up or after a period out of use, let the appliance run at least 2 hours on the higher settings before putting food in the compartment.

- Prepare food in small portions to enable it to be rapidly and completely frozen and to make it possible to subsequently thaw only the quantity required.

- Wrap up the food in aluminum foil or polyethylene food wraps which are airtight.

- Do not allow fresh, unfrozen food to touch the food which is already frozen to avoid temperature rise of the latter.

- Iced products, if consumed immediately after removal from the freezer

compartment, will probably cause frost burns to the skin.

- It is recommended to label and date each frozen package in order to keep track of the storage time.

Hints for the storage of frozen food

- Ensure that frozen food has been stored correctly by the food retailer

- Once defrosted, food will deteriorate rapidly and should not be re-frozen. Do not exceed the storage period indicated by the food manufacturer.

Switching off your appliance

If the appliance needs to be switched off for an extended period, the following steps should be taken prevent mould on the appliance.

1. Remove all food.
2. Remove the power plug from the mains socket.
3. Clean and dry the interior thoroughly.
4. Ensure that all the doors are wedged open slightly to allow air to circulate.

Cleaning and care

For hygienic reasons the appliance (including exterior and interior accessories) should be cleaned regularly at least every two months.

Caution! The appliance must not be connected to the mains during cleaning. Danger of electrical shock! Before cleaning switch the appliance off and remove the plug from the mains socket.

Exterior cleaning

To maintain good appearance of your appliance, you should clean it regularly.

- Wipe the digital panel and display panel with a clean, soft cloth.

- Spray water onto the cleaning cloth instead of spraying directly on the surface of the appliance. This helps ensure an even distribution of moisture to the surface.

- Clean the doors, handles and cabinet surfaces with a mild detergent and then wiped dry with a soft cloth.

Caution!

- Do not use sharp objects as they are likely to scratch the surface.

- Do not use Thinner, Car detergent, Clorox, ethereal oil, abrasive cleansers or organic solvent such as Benzene for cleaning. They may damage the surface of the appliance and may cause fire.

Interior cleaning

You should clean the appliance interior regularly. It will be easier to clean when food stocks are low. Wipe the inside of the fridge freezer with a weak solution of bicarbonate of soda, and then rinse with warm water using a wrung-out sponge or cloth. Wipe

completely dry before replacing the shelves and baskets. Thoroughly dry all surfaces and removable parts.

Although this appliance automatically defrosts, a layer of frost may occur on the freezer compartment's interior walls if the freezer door is opened frequently or kept open too long. If the frost is too thick, choose a time when the supply of food stocks are low and proceed as follows:

1. Remove existing food and accessories baskets, unplug the appliance from the mains power and leave the doors open. Ventilate the room thoroughly to accelerate the thawing process.
2. When defrosting is completed, clean your freezer as described above.

Door seals cleaning

Take care to keep door seals clean. Sticky food and drinks can cause seals to stick to the cabinet and tear when you open the door. Wash seal with a mild detergent and warm water. Rinse and dry it thoroughly after cleaning.

Caution! Only after the door seals are completely dry should the appliance be powered on.

Replacing the LED light

Warning: The LED light must not be replaced by the user! If the LED light is damaged, consult a qualified, registered electrician for assistance.

Troubleshooting

If you experience a problem with your appliance or are concerned that the appliance is not functioning correctly, you can carry out some easy checks before calling for service, please see below.

Warning! Do not try to repair the appliance yourself. If the problem persists after you have made the checks mentioned below, contact a qualified electrician, authorized service engineer or the shop where you purchased the product.

Problem	Possible cause & Solution
Appliance is not working correctly	Check whether the power cord is plugged into the power outlet properly.
	Check the fuse or circuit of your power supply, replace if necessary.
	The ambient temperature is too low. Try setting the chamber temperature to a colder level to solve this problem.
	It is normal that the freezer is not operating during the automatic defrost cycle, or for a short time after the appliance is switched on to protect the compressor.
Odours from the compartments	The interior may need to be cleaned.
	Some food, containers or wrapping cause odours.
Noise from the appliance	<p>The sounds below are quite normal:</p> <ul style="list-style-type: none"> ● Compressor running noises. ● Air movement noise from the small fan motor in the freezer compartment or other compartments. ● Gurgling sound similar to water boiling. ● Popping noise during automatic defrosting. ● Clicking noise before the compressor starts.
	<p>Other unusual noises are due to the reasons below and may need you to check and take action:</p> <p>The cabinet is not level.</p> <p>The back of appliance touches the wall.</p> <p>Bottles or containers fallen or rolling.</p>
The motor runs continuously	<p>It is normal to frequently hear the sound of the motor, it will need to run more when in following circumstances:</p> <ul style="list-style-type: none"> ● Temperature setting is set colder than necessary ● Large quantity of warm food has recently been stored within the appliance. ● The temperature outside the appliance is too high. ● Doors are kept open too long or too often. ● After your installing the appliance or it has been switched off for a long time.
A layer of frost occurs in the compartment	Check that the air outlets are not blocked by food and ensure food is placed within the appliance to allow sufficient ventilation. Ensure that door is fully closed. To remove the frost, please refer to cleaning and care chapter.
Temperature inside is too warm	You may have left the doors open too long or too frequently; or the doors are kept open by some obstacle; or the appliance is located with insufficient clearance at the sides, back and top.
Temperature inside is too cold	Increase the temperature by following the “Display controls” chapter.

Problem	Possible cause & Solution
Doors can't be closed easily	Check whether the top of the refrigerator is tilted back by 10-15mm to allow the doors to self close, or if something inside is preventing the doors from closing.
Water drips on the floor	The water pan (located at the rear bottom of the cabinet) may not be properly leveled, or the draining spout (located underneath the top of the compressor depot) may not be properly positioned to direct water into this pan, or the water spout is blocked. You may need to pull the refrigerator away from the wall to check the pan and spout.
The light is not working	<ul style="list-style-type: none">● The LED light may be damaged. Consult a qualified, registered electrician in this case.● The control system has disabled the lights due to the door being kept open too long, close and reopens the door to reactivate the lights.