



HOOVER

EN

NO FROST COMBI REFRIGERATOR Freezer - Fridge

User manual

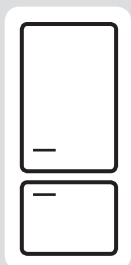

**HVN 6182W5K
HVN 6182X5K**

Index

BEFORE USING THE APPLIANCE.....	3
General warnings.....	3
Safety warnings	7
Installing and operating your fridge.....	8
Before Using your Fridge.....	9
Information about New Generation Cooling Technology	10
THE PARTS OF THE APPLIANCE AND THE COMPARTMENTS	11
THE VARIOUS FUNCTION AND POSSIBILITIES	13
Display and control panel	13
Operating your fridge.....	13
Cooler temperature settings	13
Super cool mode	14
Economy mode	14
Warnings about Temperature Adjustments	14
Accessories	15
Freezer box.....	15
Chiller Shelf	16
Humidity Controller.....	16
Adjustable Door Shelf.....	17
Adjustable Glass Shelf.....	17
CLEANING AND MAINTENANCE.....	18
Defrosting	19
ARRANGING FOOD IN THE APPLIANCE.....	20
Refrigerator compartment.....	20
Freezer compartment	21
TRANSPORTATION AND CHANGING OF INSTALLATION POSITION.....	26
Repositioning the door.....	26
BEFORE CALLING YOUR AFTER SALES SERVICE... 	27
ENERGY SAVING	30

Thank you for purchasing this product.

Before using your refrigerator, please carefully read this instruction manual in order to maximize its performance. Store all documentation for subsequent use or for other owners.

This appliance must be used only for purposes of storage of food, any other use is considered dangerous and the manufacturer will not be responsible for any omissions. Also, it is recommended that you take note of the warranty conditions.

General warnings

WARNING: Keep ventilation openings, in the appliance enclosure or in the built-in structure, clear of obstruction.

WARNING: Do not use mechanical devices or other means to accelerate the defrosting process, other than those recommended by the manufacturer.

WARNING: Do not use electrical appliances inside the food storage compartments of the appliance, unless they are of the type recommended by the manufacturer.

WARNING: Do not damage the refrigerant circuit.

WARNING: In order to avoid any hazards resulting from the instability of the appliance, it must be fixed in accordance with the following instructions:

- If your appliance uses R600a as a refrigerant (this information will be provided on the label of the cooler) you should take care during transportation and installation to prevent the cooler elements from being damaged. R600a is an environmentally friendly and natural gas, but it is explosive. In the event of a leak due to damage of the cooler elements, move your fridge away from open flames or heat sources and ventilate the room where the appliance is located for a few minutes.

BEFORE USING THE APPLIANCE

- While carrying and positioning the fridge, do not damage the cooler gas circuit.
- Do not store explosive substances such as aerosol cans with a flammable propellant in this appliance.
- This appliance is intended to be used in household and domestic applications such as:
 - staff kitchen areas in shops, offices and other working environments.
 - farm houses and by clients in hotels, motels and other residential type environments.
 - bed and breakfast type environments;
 - catering and similar non-retail applications.
- If the socket does not match the refrigerator plug, it must be replaced by the manufacturer, a service agent or similarly qualified persons in order to avoid a hazard.
- A specially grounded plug has been connected to the power cable of your refrigerator. This plug should be used with a specially grounded socket of 16 amperes. If there is no such socket in your house, please have one installed by an authorised electrician.
- This appliance can be used by children aged from 8 years and above and persons with reduced physical, sensory or mental capabilities or lack of experience and knowledge if they have been given supervision or instruction concerning use of the appliance in a safe way and understand the hazards involved. Children shall not play with the appliance. Cleaning and user maintenance shall not be made by children without supervision.

- If the supply cord is damaged, it must be replaced by the manufacturer, an authorised service agent or similar qualified persons, in order to avoid a hazard.
- This appliance is not intended for use at altitudes exceeding 2000 m.
- The refrigerator contains a refrigerant gas (R600a: isobutane) and insulating gas (cyclo/isopentane), with high compatibility with the environment, that are, however, inflammable.
- We recommend that you follow the following regulations so as to avoid situations dangerous to you:
 - Before performing any operation, unplug the power cord from the power socket.
 - The refrigeration system positioned behind and inside the Wine Coolers contains refrigerant. Therefore, avoid damaging the tubes.
 - If in the refrigeration system a leak is noted, do not touch the wall outlet and do not use open flames. Open the window and let air into the room. Then call a service centre to ask for repair.
 - Do not scrape with a knife or sharp object to remove frost or ice that occurs. With these, the refrigerant circuit can be damaged, the spill from which can cause a fire or damage your eyes.
 - Do not install the appliance in humid, oily or dusty places, nor expose it to direct sunlight and to water.
 - Do not install the appliance near heaters or inflammable materials.
 - Do not use extension cords or adapters.

BEFORE USING THE APPLIANCE

- Do not excessively pull or fold the power cord or touch the plug with wet hands.
- Do not damage the plug and/or the power cord; this could cause electrical shocks or fires.
- It is recommended to keep the plug clean, any excessive dust residues on the plug can be the cause fire.
- Absolutely avoid the use of open flame or electrical equipment, such as heaters, steam cleaners, candles, oil lamps and the like in order to speed up the defrosting phase.
- Do not store medicine or research materials in the Wine Coolers. When the material that requires a strict control of storage temperatures is to be stored, it is possible that it will deteriorate or an uncontrolled reaction may occur that can cause risks.
- Maintain the ventilation openings in the appliance enclosure or in the built-in structure, free of obstruction.
- Do not place objects and/or containers filled with water on the top of the appliance.
- Do not perform repairs on this Wine Coolers. All interventions must be performed solely by qualified personnel.

Notes:

- Please read the instruction manual carefully before installing and using your appliance. **We are not responsible for the damage occurred due to misuse.**
- Follow all instructions on your appliance and instruction manual, and keep this manual in a safe place to resolve the problems that may occur in the future.
- This appliance is produced to be used in homes and it can only be used in domestic environments and for the specified purposes. It is not suitable for commercial or common use. Such use will cause the guarantee of the appliance to be cancelled and our company will not be responsible for losses incurred.
- This appliance is produced to be used in houses and it is only suitable for cooling / storing food. It is not suitable for commercial or common use and/or for storing substances except for food. Our company is not responsible for losses to be incurred in the contrary case.

Safety warnings

- Do not connect your Fridge Freezer to the mains electricity supply using an extension lead.
- Do not plug in damaged, torn or old plugs.
- Do not pull, bend or damage the cord.



- This appliance is designed for use by adults, do not allow children to play with the appliance or let them hang off the door.
- Never touch the power cord/plug with wet hands as this could cause a short circuit or electric shock.
- Do not place glass bottles or beverage cans in the ice-making compartment as they can burst as the contents freeze.
- Do not place explosive or flammable material in your fridge. Place drinks with high alcohol content vertically in

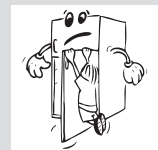
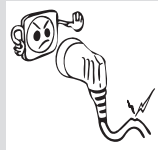

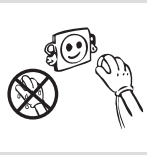

the fridge compartment and make sure that their tops are tightly closed.

- When removing ice from the ice-making compartment, do not touch it. Ice may cause frost burns and/or cuts.
- Do not touch frozen goods with wet hands. Do not eat ice-cream or ice cubes immediately after you have taken them out of the ice-making compartment.
- Do not re-freeze frozen goods after they have melted. This may cause health issues such as food poisoning.
- Do not cover the body or top of fridge with lace. This affects the performance of your fridge.
- Secure any accessories in the fridge during transportation to prevent damage to the accessories.

Installing and operating your fridge

Before using your fridge, you should pay attention to the following points:

- The operating voltage for your fridge is 220-240 V at 50Hz.
- We do not accept responsibility for any damages that occur due to ungrounded usage.
- Place your fridge where it will not be exposed to direct sunlight.
- Your appliance should be at least 50 cm away from stoves, gas ovens and heater cores, and at least 5 cm away from electrical ovens.
- Your fridge should never be used outdoors or exposed to rain.
- When your fridge is placed next to a deep freezer, there should be at least 2 cm between them to prevent humidity forming on the outer surface.
- Do not place anything on your fridge, and install your fridge in a suitable place so that at least 15 cm of free space is available above it.
- Use the adjustable front legs to make sure your appliance is level and stable. You can adjust the legs by turning them in either direction. This should be done before placing food in the fridge.

- Before using your fridge, wipe all parts with a solution of warm water and a teaspoon of sodium bicarbonate, then rinse with clean water and dry. Place all parts in the fridge after cleaning.
- Install the plastic distance guide (the part with black vanes at the rear) by turning it 90° (as shown in the figure) to prevent the condenser from touching the wall.
- The refrigerator should be placed against a wall with a free space not exceeding 75 mm.

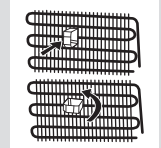

Before Using your Fridge

- When using your fridge for the first time, or after transportation, keep it in an upright position for at least 3 hours before plugging into the mains. This allows efficient operation and prevents damage to the compressor.
- Your fridge may have a smell when it is operated for the first time. This is normal and the smell will fade away when your fridge starts to cool.

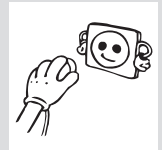

Information about New Generation Cooling Technology

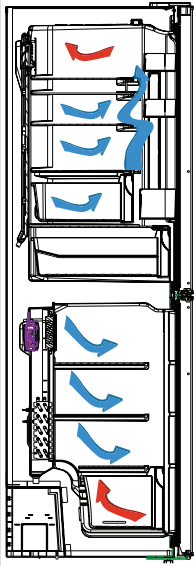

Fridges with new generation cooling technology have a different working system than static fridges. In normal fridges, humid air that enters into fridge and the water vapor that comes out from the foods, accumulates frost formation in freezer compartment. In order to melt this frost, in other words defrost, the fridge has to be stopped. During the stopping period, to keep the foods cold, user has to extract the food to outside of fridge and user has to clear the ice during this period.

In the fridges with new generation cooling technology, situation in the freezer compartment is completely different. With the aid of fan, cold and dry air is blown out through many points into the freezer compartment. As a result of the homogenously blown cold air, even in the spaces between shelves, foods are frozen equally and correctly. On the other hand there will be no frost formation.

In the refrigerator compartment, there will be nearly same configuration with freezer compartment. Air, that is emitted with the fan, located at the top of refrigerator compartment, is cooled while passing through the gap behind the air duct. At the same time, air is blown out through the holes on the air duct so that cooling process is successfully completed in the refrigerator compartment. Holes on the air duct are designed such that the air distribution becomes homogenous in this compartment.

As there is no air passage between freezer and refrigerator compartment, there will be no odor mixing.

As a result of these, your fridge with new generation cooling technology, gives you, ease of use beside the huge volume and esthetic appearance.

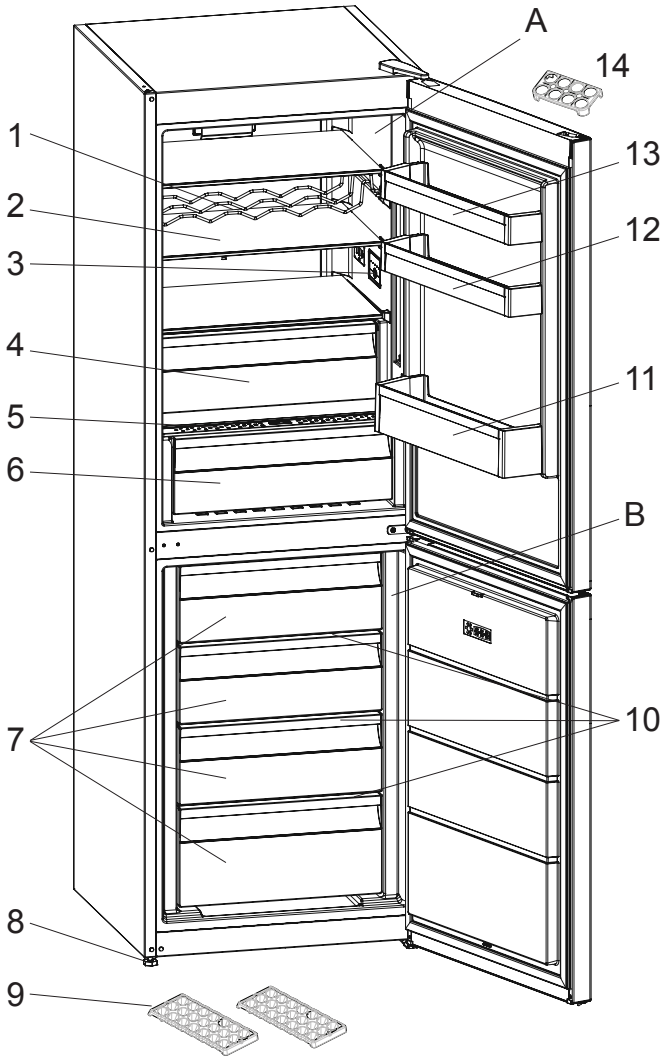

This presentation is only for information about the parts of the appliance. Parts may vary according to the appliance model.

- A) Fridge compartment
- B) Freezer compartment

- 1) Wine rack *
- 2) Fridge shelves
- 3) Interior display / In room control
- 4) Chiller *
- 5) Crisper cover
- 6) Crisper
- 7) Freezer baskets
- 8) Leveling feet
- 9) Ice trays
- 10) Freezer glass shelves *
- 10) Bottle shelf
- 11) Adjustable door shelf * / Door shelf
- 12) Door shelf
- 13) Egg holder

* In some models

This presentation is only for information about the parts of the appliance. Parts may vary according to the appliance model.

Display and control panel

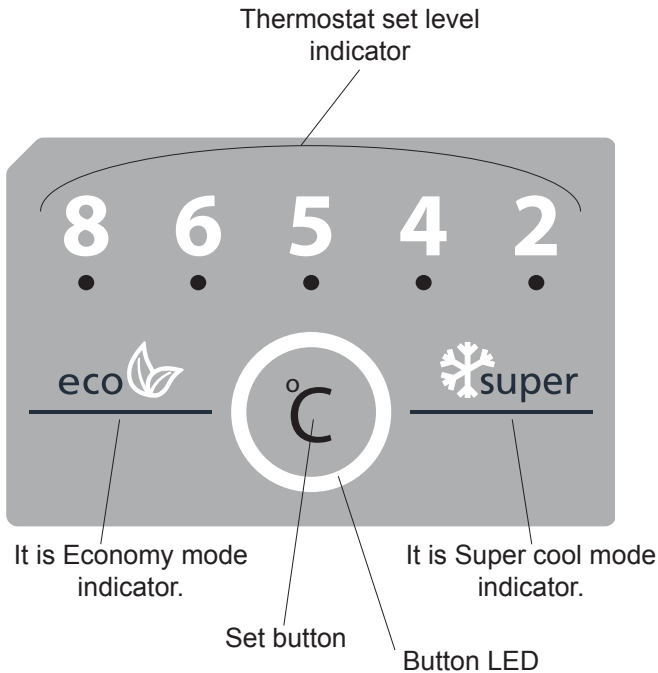

Operating your fridge

Cooler temperature settings

- Initial temperature value for Cooler Setting Indicator is 6 °C.
- Press set button once, the set value will start to blink.
- If you keep pressing set button, lower temperatures will be selected. (8, 6, 5, 4, 2, super and eco)
- If no button is pressed for 1 second, your choice will be set, it will blink 3 times. Buzzer will sound beep beep.
- The temperature value selected before Super Cool Mode or Economy Mode is activated will remain the same when the mode is over or cancelled. The appliance continues to operate with this temperature value.

Super cool mode

How would it be used?

Press set button until super cool symbol will be seen on the screen. Buzzer will sound beep beep. Mode will be set.

During this mode:

- Economy mode can not be selected.
- Super cool mode can be cancelled by the same operation of selecting.

Economy mode

How would it be used?

Press set button until eco symbol will be seen on the screen. Buzzer will sound beep beep. Mode will be set.

During this mode:

- Super cool can be selected. Economy mode is automatically cancelled and the selected mode is activated.
- Eco mode can be cancelled by the same operation of selecting.

Warnings about Temperature Adjustments

- Temperature adjustments should be made according to the frequency of door openings and the quantity of food kept inside the fridge.
- Do not pass to another adjustment before completing an adjustment.
- Your fridge should be operated up to 24 hours according to the ambient temperature without interruption after being plugged in to be completely cooled. Do not open doors of your fridge frequently and do not place much food inside it in this period.
- A 5 minute delaying function is applied to prevent damage to the compressor of your fridge, when you take the plug off and then plug it on again to operate it or when an energy breakdown occurs. Your fridge will start to operate normally after 5 minutes.
- Your fridge is designed to operate in the ambient temperature intervals stated in the standards, according to the climate class stated in the information label. We do not recommend operating your fridge out of stated temperatures value limits in terms of cooling effectiveness.

- This appliance is designed for use at an ambient temperature within the 10°C - 43°C range.

Climate Class	Ambient Temperature °C
T	Between 16 and 43 (°C)
ST	Between 16 and 38 (°C)
N	Between 16 and 32 (°C)
SN	Between 10 and 32 (°C)

Accessories

Freezer box

The freezer box allows foods are maintained more regularly.

Removing The freezer box;

- Pull the box out as far as possible
 - Pull the front of box up and out.
- ! Make the inverse of the same operation for the resetting the sliding compartment.

Note: Always Keep the handle of box while removing the box.

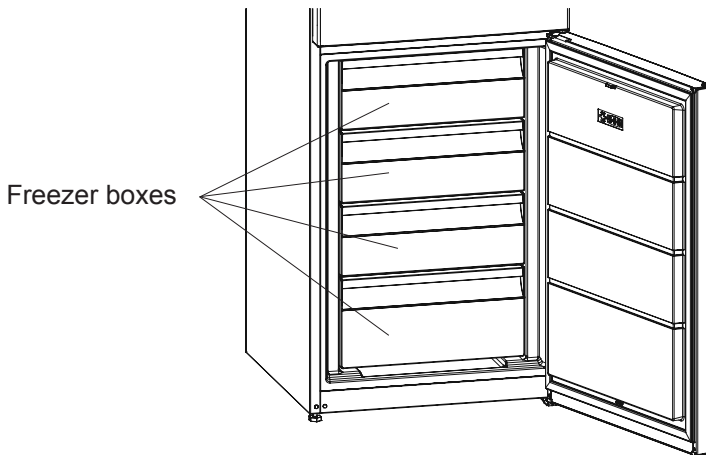

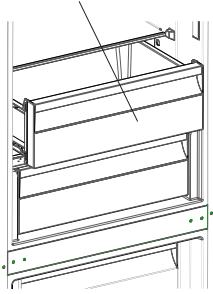
Chiller Shelf (In some models)

Keeping food in the Chiller compartment instead of the freezer or refrigerator compartment allows food retain freshness and flavour longer, while preserving its fresh appearance. When chiller tray becomes dirty, remove it and wash it with water.

(Water freezes at 0°C, but foods containing salt or sugar freeze at temperature lower than that)

Normally people use the chiller compartment for raw fish, lightly pickled, rice, etc...

Do not put foods you want to freeze or ice trays in order to make ice.

Removing the Chiller shelf (In some models)

- Pull the chiller shelf out toward you by sliding on rails.
- Pull the chiller shelf up from rail to remove.

Humidity Controler

When the humidity controler in the closed position, it allows fresh fruit and vegetables to be stored longer.

In case of the crisper is totally full, the fresh dial is located in front of crisper, should be opened. By means of this the air in the crisper and humidity rate will be controlled and endurance life will be increased.

If you see any condensation on glass shelf, humidity control should be taken into the open positions.

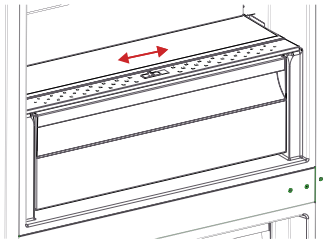

Adjustable Door Shelf (In some models)

Six different height adjustments can be made to provide storage areas that you need by adjustable door shelf.

To change the position of adjustable door shelf ;

Hold the bottom of the shelf and pull the buttons on the side of the door shelf direction of arrow (Fig.1).

Position door shelf the height you need by moving up and down. After you get the position that you want the door shelf, release the buttons on the side of the door shelf (Fig.2) Before releasing the door shelf, move up down and make sure the door shelf is fixed.

Note: Before moving door shelf is loaded, you must hold the shelf by supporting the bottom. Otherwise, door shelf could fall off the rails due to the weight. So damage may occur on the door shelf or rails.

Adjustable Glass Shelf (In some models)

Adjustable glass shelf mechanism provides higher storage spaces with a simple movement. To cover the glass shelf, push it.

You can load your food as you want in the resulting extra space. To bring the shelf in its original position, pull it toward you.

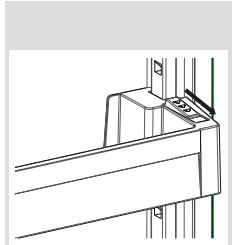

Figure -1

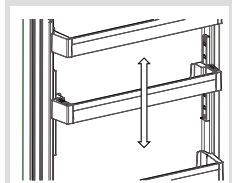

Figure -2



Figure -1

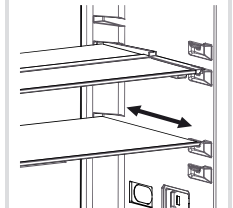
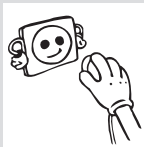
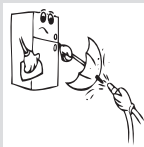

Figure -2

Visual and text descriptions on the accessories section may vary according to the model of your appliance.



- **Disconnect the unit from the power supply before cleaning.**



- Do not clean the appliance by pouring water.
- Make sure that no water enters the lamp housing and other electrical components.

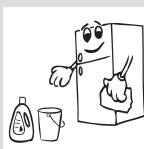

- The refrigerator should be cleaned periodically using a solution of bicarbonate of soda and lukewarm water.

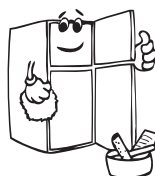

- Clean the accessories separately with soap and water. Do not clean them in the dishwasher.

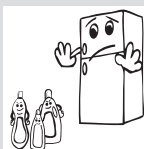

- Do not use abrasive products, detergents or soaps. After washing, rinse with clean water and dry carefully. When you have finished cleaning, reconnect the plug to the mains supply with dry hands.

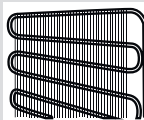

- Clean the condenser with a broom at least twice a year. This will help you to save on energy costs and increase productivity.

THE POWER SUPPLY MUST BE DISCONNECTED.

Defrosting

Your refrigerator has fully automatic defrosting. The water formed as a result of defrosting passes through the water collection spout, flows into the vaporisation container below the condenser and evaporates there.

- Make sure you have disconnected the plug of your refrigerator before cleaning the vaporization container.
- Remove the vaporization container from its position by unscrewing the screws as indicated. Clean it with soapy water at specific time intervals. Thus, the odor formation will have been prevented.

Replacing LED Lighting

If your refrigerator has LED lighting contact the help desk as this should be changed by authorized personnel only.

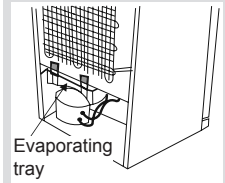

Refrigerator compartment

- For normal operating conditions, adjusting the temperature value of the cooler partition of the fridge to 4°C will be enough.
- To reduce humidity and consequent increase of frost never place liquids in unsealed containers in the refrigerator. Frost tends to concentrate in the coldest parts of the evaporator and in time will require more frequent defrosting.
- Never place warm food in the refrigerator. Warm food should be allowed to cool at room temperature and should be arranged to ensure adequate air circulation in the refrigerator compartment.
- Nothing should touch on the back wall as it will cause frost and the packages can stick on the back wall. Do not open the refrigerator door too frequently.
- Arrange the meat and cleaned fish(wrapped in packages or sheets of plastic) which you will use in 1-2 days,in the bottom section of the refrigerator compartment(that is above the crisper) as this is the coldest section and will ensure the best storing conditions.
- You can put the fruits and vegetables into crisper without packing.

Some recommendations have been specified below for the placement and storage of your food in the cooling compartment.

Food	Maximum Storing time	Where to place in the fridge compartment
Vegetables and fruits	1 week	Vegetable bin
Meat and fish	2 - 3 Days	Wrapped in plastic foil or bags or in a meat container (on the glass shelf)
Fresh cheese	3 - 4 Days	In special door shelf
Butter and margarine	1 week	In special door shelf
Bottled products milk and yoghurt	Until the expiry date recommended by the producer	In special door shelf
Eggs	1 month	In the egg shelf
Cooked food		All shelves

NOTE: Potatoes, onions and garlic should not be stored in the refrigerator.

Freezer compartment

- Please use the deep freeze compartment of your refrigerator for storing the frozen food for a long time and for producing ice.
- To get maximum capacity for freezer compartment, please just use glass shelves for upper and middle section. For bottom section, please use lower basket.
- For optimum appliance performance to reach maximum freezing capacity, Set the refrigerator at 4 °C for 24 hours before placing fresh food into the freezer.
- After placing fresh food into the freezer, change the setting to 2 °C for 24 hours is generally sufficient. After 24 hours, you can reduce the setting if required.
- Please do not place the food you shall newly freeze nearby the already frozen food.
- You should freeze the food to be frozen (meat, minced meat, fish, etc.) by dividing them into portions in such a way that they can be consumed once.
- Please do not refreeze the frozen food once they are thawed. It may pose a danger for your health since it might cause problems such as food poisoning.
- Do not place the hot meals in your deep freeze before they become cold. You would cause the other food frozen beforehand in the deep freeze to become putrefied.
- When you buy frozen food, makes sure that they were frozen under appropriate conditions and the package is not torn.
- While storing the frozen food, the storage conditions on the package should certainly be observed. If there is not any explanation, the food must be consumed within the shortest time possible.
- If there had been humidification in the frozen food package and it has a foul smell, the food might have been stored under unsuitable conditions previously and gone rotten. Do not purchase this type of foods!
- The storage durations of frozen food change depending on the ambient temperature, the frequent opening and closing of the doors, thermostat settings, food type and the time elapsed from the purchase time of the food to the time it is placed into the freezer. Always abide by the instructions on the package and never exceed the indicated storage duration.

ARRANGING FOOD IN THE APPLIANCE

- During long lasting power failures, please do not open the door of the deep freeze compartment. During longer power failures, do not refreeze your food and consume them as soon as possible.

Not that; if you want to open again immediately after closing the freezer door, it will not be opened easily. It's quite normal! After reaching equilibrium condition, the door will be opened easily.

Important note:

- *Frozen foods, when thawed, should be cooked just like fresh foods. If they are not cooked after being thawed they must NEVER be re-frozen.*
- The taste of some spices found in cooked dishes (anise, basilica, watercress, vinegar, assorted spices, ginger, garlic, onion, mustard, thyme, marjoram, black pepper, etc.) changes and they assume a strong taste when they are stored for a long period. Therefore, the frozen food should be added little amount of spices or the desired spice should be added after the food has been thawed.
- The storage period of food is dependent on the oil used. The suitable oils are margarine, calf fat, olive oil and butter and the unsuitable oils are peanut oil and pig fat.
- The food in liquid form should be frozen in plastic cups and the other food should be frozen in plastic folios or bags.

Some recommendations have been specified on pages 23, 24 and 25 for the placement and storage of your food in the deep freeze compartment.

Meat and fish	Preparation	Maximum Storing time (month)
Steak	Wrapping in a foil	6 - 8
Lamb meat	Wrapping in a foil	6 - 8
Veal roast	Wrapping in a foil	6 - 8
Veal cubes	In small pieces	6 - 8
Lamb cubes	In pieces	4 - 8
Minced meat	In packages without using spices	1 - 3
GIBLETS (pieces)	In pieces	1 - 3
Bologna sausage/ salami	Should be packaged even if it has membrane	
Chicken and turkey	Wrapping in a foil	4 - 6
Goose and Duck	Wrapping in a foil	4 - 6
Deer, Rabbit, Wild Boar	In 2.5 kg portions and as fillets	6 - 8
Freshwater fishes (Salmon, Carp, Crane, Siluroidea)	After cleaning the bowels and scales of the fish, wash and dry it; and if necessary, cut off the tail and head.	2
Lean fish; bass, turbot, flounder		4
Fatty fishes (Tunny, Mackarel, bluefish, anchovy)		2 - 4
Shellfish	Cleaned and in bags	4 - 6
Caviar	In its package, aluminium or plastic container	2 - 3
Snails	In salty water, aluminum or plastic container	3

Note: Frozen meat should be cooked as fresh meat after being thawed. If the meat is not cooked after being thawed, it must not be re-frozen.

Vegetables and Fruits	Preparation	Maximum Storing time (months)
String beans and beans	Wash and cut into small pieces and boil in water	10 - 13
Beans	Hull and wash and boil in water	12
Cabbage	Cleaned and boil in water	6 - 8
Carrot	Clean and cut to slices and boil in water	12
Pepper	Cut the stem, cut into two pieces, remove the core and boil in water	8 - 10
Spinach	Washed and boil in water	6 - 9
Cauliflower	Take the leaves apart, cut the heart into pieces, and leave it in water with a little lemon juice for a while	10 - 12
Eggplant	Cut to pieces of 2cm after washing	10 - 12
Corn	Clean and pack with its stem or as sweet corn	12
Apple and pear	Peel and slice	8 - 10
Apricot and Peach	Cut into two pieces and remove the stone	4 - 6
Strawberry and Blackberry	Wash and hull	8 - 12
Cooked fruits	Adding 10 % of sugar in the container	12
Plum, cherry, sourberry	Wash and hull the stems	8 - 12

Dairy Products	Preparation	Maximum Storing time (months)	Storing Conditions
Packet (Homogenize) Milk	In its own packet	2 - 3	Pure Milk – In its own packet
Cheese-excluding white cheese	In slices	6 - 8	Original package may be used for short storing period. It should be wrapped in foil for longer periods.
Butter, margarine	In its package	6	

	Maximum Storing time (months)	Thawing time in room temperature (hours)	Thawing time in oven (minutes)
Bread	4 - 6	2 - 3	4-5 (220-225 °C)
Biscuits	3 - 6	1 - 1,5	5-8 (190-200 °C)
Pastry	1 - 3	2 - 3	5-10 (200-225 °C)
Pie	1 - 1,5	3 - 4	5-8 (190-200 °C)
Phyllo dough	2 - 3	1 - 1,5	5-8 (190-200 °C)
Pizza	2 - 3	2 - 4	15-20 (200 °C)

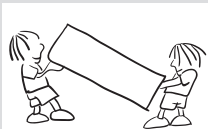

Transportation and Changing of Installation Position

- The original packages and foamed polystyrene (PS) can be retained if required.
- During transportation, the appliance should be secured with a wide string or a strong rope. The instructions written on the corrugated box must be followed while transporting.
- Before transporting or changing the installation position, all the moving objects (ie,shelves,crisper...) should be taken out or fixed with bands in order to prevent them from getting damaged.

Repositioning the door

- It is not possible to change the opening direction of your refrigerator door, if the door handle on your refrigerator is installed from the front surface of the door.
- It is possible to change the opening direction of the door on models without any handles.
- If the door opening direction of your refrigerator may be changed, you should contact the nearest Authorised Service Agent to have the opening direction changed.

Check Warnings;

Your fridge warns you if there is/are some part(s) out of order. In this case, LED around the button will blink and buzzer will sound beep.

ERROR TYPE	MEANING	WHY	WHAT TO DO
SR	"Failure Warning"	There is/are some part(s) Out of order	Call Service for assistance as soon as possible.

If your fridge-freezer is not operating;

- Is there a power failure?
- Is the plug connected to the socket correctly?
- Is the fuse of the socket to which the plug is connected or the main fuse blown?
- Is there any failure at the socket? To check this, plug your refrigerator to a socket this is surely operating.

If your fridge-freezer is not cooling enough;

- Is the temperature adjustment right?
- Are the doors of your fridge-freezer opened frequently and left open for a long while?
- Are the doors of fridge-freezer closed properly?
- Did you put a dish or food on your fridge-freezer so that it contacts the rear wall of your fridge-freezer so as to prevent the air circulation?
- Is your fridge-freezer filled excessively?
- Is there adequate distance between your fridge-freezer and the rear and side walls?
- Is the ambient temperature within the range of values specified in the operating manual?

If the food in your refrigerator compartment is over cooled

- Is the temperature adjustment right?
- Are there many food recently put inside the freezer compartment? If so, your fridge-freezer may over cool the food inside the fridge compartment as it will operate longer to cool these food.

If your fridge-freezer is operating too loudly;

To maintain the set cooling level, compressor may be activated from time to time. Noises from your fridge-freezer at this time are normal and

due to its function. When the required cooling level is reached, noises will be decreased automatically. If the noises persist;

- Is your appliance stable? Are the legs adjusted?
- Is there anything behind your fridge-freezer?
- Are the shelves or dishes on the shelves vibrating? Re-place the shelves and/or dishes if this is the case.
- Are the items placed on your fridge-freezer vibrating?

Normal Noises;

Cracking (Ice cracking) Noise:

- During automatic defrosting.
- When the appliance is cooled or warmed (due to expansion of appliance material).

Short cracking: Heard when the thermostat switches the compressor on/off.

Compressor noise (Normal motor noise): This noise means that the compressor operates normally. Compressor may cause more noise for a short time when it is activated.

Bubbling noise and splash: This noise is caused by the flow of the refrigerant in the tubes of the system.

Water flow noise: Normal flow noise of water flowing to the evaporation container during defrosting. This noise can be heard during defrosting.

Air Blowing Noise (Normal fan noise): This noise can be heard in No-Frost refrigerator during normal operation of the system due to the circulation of air.

If humidity builds up inside the fridge-freezer;

- Are all food packed properly? Are the containers dried before placing them in the fridge-freezer?
- Are the fridge-freezer doors opened frequently? Humidity of the room gets in the fridge-freezer when the doors are opened. Humidity build up will be faster when you open the doors more frequently, especially if the humidity of the room is high.

If the doors are not opened and closed properly;

- Do the food packages prevent closing of the door?
- Are the door compartments, shelves and drawers placed properly?
- Are door gaskets broken or torn?
- Is your fridge-freezer on a level surface?

If the edges of fridge cabinet that the door joint contact are warm;

Especially in summer (hot weather), the surfaces that the joint contact may get warmer during the operation of the compressor, this is normal.

IMPORTANT NOTES:

- Compressor protection function will be activated after sudden power breakdowns or after unplugging the appliance, because the gas in the cooling system is not stabilized yet. Your fridge-freezer will start after 5 minutes, there is nothing to worry about.
- If you will not use your fridge-freezer for a long time (e.g. in summer holidays) unplug it. Clean your fridge-freezer according to Part 4 and leave the door open to prevent humidity and smell.
- If the problem persists after you have followed all the instructions above, please consult to the nearest authorized service.
- The appliance you bought is designed for home type use and can be used only at home and for the stated purposes. It is not suitable for commercial or common use. If the consumer use the appliance in a way that does not comply with these features, we emphasize that the producer and the dealer shall not be responsible for any repair and failure within the guarantee period.

ENERGY SAVING

- For better energy saving we suggest :
- Installing the appliance away from heat sources and not exposed to direct sunlight and in a well ventilated room.
- Avoid putting hot food into the refrigerator to avoid increasing the internal temperature and therefore causing continuous functioning of the compressor.
- Do not excessively stuff foods so as to ensure proper air circulation.
- Defrost the appliance in case there is ice to facilitate the transfer of cold.
- In case of absence of electrical energy, it is advisable to keep the refrigerator door closed.
- Open or keep the doors of the appliance open as little as possible
- Avoid adjusting the setting to temperatures too cold.
- Remove dust present on the rear of the appliance



This appliance is marked according to the European directive 2012/19/EU on Waste Electrical and Electronic Equipment (WEEE).

WEEE contains both polluting substances (which can cause negative consequences for the environment) and basic components (which can be re-used). It is important to have WEEE subjected to specific treatments, in order to remove and dispose properly all pollutants, and recover and recycle all materials.

Individuals can play an important role in ensuring that WEEE does not become an environmental issue; it is essential to follow some basic rules:

- WEEE should not be treated as household waste;
- WEEE should be handed over to the relevant collection points managed by the municipality or by registered companies. In many countries, for large WEEE, home collection could be present.

In many countries, when you buy a new appliance, the old one may be returned to the retailer who has to collect it free of charge on a one-to-one basis, as long as the equipment is of equivalent type and has the same functions as the supplied equipment.

Conformity

By placing the **CE** mark on this product, we are confirming compliance to all relevant European safety, health and environmental requirements which are applicable in legislation for this product.

52235975