



# HOVER



## INSTRUCTION BOOK

### Vented Tumble Dryer

English 2

VISIONTECH

<b>Introduction</b>	3
Delivery Information	3
<b>Safety Reminders</b>	3
Use	4
Installation	5
The Laundry	5
<b>Ventilation</b>	6
Environmental Issues	7
Gas Service	7
<b>Installation</b>	7
Electrical Requirements	7
Adjusting the Feet	7
Installation of the Discharge Hose	8
<b>Preparing the Load</b>	8
Clothes Preparation	8
Drying Guide	9
Do Not Tumble Dry	9
Energy Saving	9
Sorting the Load	9
<b>Controls and Indicators</b>	10
<b>Selecting the Programme</b>	11
<b>Door and Filter</b>	12
Opening the Door	12
Filter	12
Filter Care Indicator	12
<b>Operation</b>	12
Delay Start Function	13
Cancelling and Resetting the Programme	13
<b>Cleaning and Routine Maintenance</b>	13
Cleaning the Dryer	13
Technical Specifications	13
<b>Troubleshooting</b>	14
<b>Customer Service</b>	14
Spares	14
Gas Service	14

# INTRODUCTION

Please read and follow these instructions carefully and operate the machine accordingly. This booklet provides important guidelines for safe use, installation, maintenance and some useful advice for best results when using your machine.

Keep all documentation in a safe place for future reference or for any future owners.

## Delivery Information

Please check that the following items are delivered with the appliance:

- Instruction manual
- Guarantee card
- Vent kit and instructions
- Energy label

 Check that no damage has occurred to the machine during transit. If it has, call for service by GIAS.

 Failure to comply with the above can compromise the safety of the appliance. You may be charged for a service call if a problem with your machine is caused by misuse.

## SAFETY REMINDERS

### Use

- This appliance can be used by children aged from 8 years and above and persons with reduced physical, sensory or mental capabilities or lack of experience and knowledge if they have been given supervision or instruction concerning use of the appliance in a safe way and understand the hazards involved. Children shall not play with the appliance. Cleaning and user maintenance shall not be made by children without supervision. Children of less than 3 years should be kept away unless continuously supervised.

- **WARNING** Misuse of a tumble dryer may create a fire hazard.

- This appliances is intended to be used in household and similar applications such as:

- Staff kitchen areas in shops , offices and other working environments;
- Farm houses
- By clients in hotels, motels and other residential type environments;
- Bed and breakfast type environments"

A different use of this appliance from household environment or from typical housekeeping functions, as commercial use by expert or trained users, is excluded even in the above applications.

If the appliance is used in a manner inconsistent with this it may reduce the life of the appliance and may void the manufacturer's warranty. Any damage to the appliance or other damage or loss arising through use that is not consistent with domestic or household use ( even if located in a domestic or household environment) shall not be accepted by the manufacturer to the fullest extent permitted by law."

## SAFETY REMINDERS

### Use

- This machine should only be used for its intended purpose as described in this manual. Ensure that the instructions for installation and use are fully understood before operating the appliance.
- Do not touch the appliance when hands or feet are damp or wet.
- Do not lean on the door when loading the machine or use the door to lift or move the machine.
- Do not allow children to play with the machine or its controls.
- **WARNING** Do not use the product if the fluff filter is not in position or is damaged; fluff could be ignited.
- **WARNING** Where the hot surface symbol  is located the temperature rise during operation of the tumble dryer may be in excess of 60 degrees C.
- Remove the plug from the electricity supply. Always remove the plug before cleaning the appliance.
- Do not continue to use this machine if it appears to be faulty.
- Lint and fluff must not be allowed to collect on the floor around the outside of the machine.
- The final part of a tumble dryer cycle occurs without heat (cool down cycle) to ensure that the items are left at a temperature that ensures that the items will not be damaged.
- Maximum load drying weight : see energy label.
- The tumble dryer is not to be used if industrial chemicals have been used for cleaning.
- **WARNING:** Never stop a tumble dryer before the end of the drying cycle unless all items are quickly removed and spread out so that the heat is dissipated.

## SAFETY REMINDERS

### Installation

- Check that the product has no visible signs of damage before use. If damaged do not use and please call GIAS Service.
- Do not use adapters, multiple connectors and/or extensions.
- Never install the dryer against curtains and be sure to prevent items from falling or collecting behind the dryer.
- The appliance must not be installed behind a lockable door, a sliding door or a door with a hinge on the opposite side to that of the tumble dryer.

### The Laundry

- Do not dry unwashed items in the tumble dryer.
- **WARNING** Do not tumble dry fabrics treated with dry cleaning fluids.
- **WARNING** Foam rubber materials can, under certain circumstances, when heated become ignited by spontaneous combustion. Items such as foam rubber (latex foam), shower caps, waterproof textiles, rubber backed articles and clothes or pillows fitted with foam rubber pads **MUST NOT** be dried in the tumble dryer.
- Always refer to the laundry care labels for directions on suitability for drying.

- Clothes should be spin dried or thoroughly wrung before they are put into the tumble dryer. Clothes that are dripping wet should not be put into the dryer.
- Lighters and matches must not be left in pockets and **NEVER** use flammable liquids near the machine.
- Glass fibre curtains should **NEVER** be put in this machine. Skin irritation may occur if other garments are contaminated with the glass fibres.
- Items that have been soiled with substances such as cooking oil, acetone, alcohol, petrol, kerosene, spot removers, turpentine, waxes and wax removers should be washed in hot water with an extra amount of detergent before being dried in the tumble dryer.
- Fabric softeners, or similar products, should be used as specified by the fabric softener instructions.

## SAFETY REMINDERS

### Ventilation

- Adequate ventilation must be provided in the room where the tumble dryer is located to prevent gases from appliances burning other fuels, including open fires, being drawn into the room during operation of the tumble dryer.
- Installing the rear of the appliance close to a wall or vertical surface.
- There should be a gap of at least 12 mm between the machine and any obstructions. The inlet and outlet should be kept clear of obstruction. To ensure adequate ventilation the space between the bottom of the machine and the floor must not be obstructed.
- Check regularly that the air flowing through the dryer is not restricted.
- Check frequently the fluff filter after use, and clean, if necessary.
- Prevent items from falling or collecting behind the dryer as these may obstruct the air inlet and outlet
- NEVER install the dryer up against curtains.
- In cases where the dryer is installed on top of a washing machine, a suitable stacking kit must be used according to the follow configuration.
  - Stacking kit Mod 35100019: for minimum washing machine depth 49 cm
  - Stacking kit Mod 35900120: for minimum washing machine depth 51 cm.

The stacking kit shall be one of that above, obtainable from our spare service.

The instructions for installation and any fixing attachments, are provided with the staking kit.

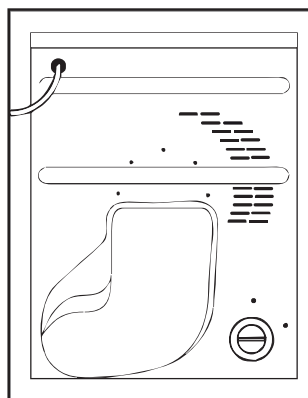

**⚠** Do not plug the machine in and switch it on at the mains until the installation is completed. For your safety, this dryer must be correctly installed. If there is any doubt about installation, call GIAS Service for advice.

# INSTALLATION

## Environmental Issues

- All packaging materials used are environmentally-friendly and recyclable. Please help dispose of the packaging via environmentally-friendly means. Your local council will be able to give you details of current means of disposal.
- To ensure safety when disposing of an old tumble dryer disconnect the mains plug from the socket, cut the mains power cable and destroy this together with the plug. To prevent children shutting themselves in the machine break the door hinges or the door lock.

## European Directive 2012/19/EC

This appliance is marked according to the European directive 2012/19/EU on Waste Electrical and Electronic Equipment (WEEE).



WEEE contains both polluting substances (which can cause negative consequences for the environment) and basic components (which can be re-used). It is important to have WEEE subjected to specific treatments, in order to remove and dispose properly all pollutants, and recover and recycle all materials.

Individuals can play an important role in ensuring that WEEE does not become an environmental issue; it is essential to follow some basic rules:

- WEEE should not be treated as household waste.
- WEEE should be handed over to the relevant collection points managed by the municipality or by registered companies. In many countries, for large WEEE, home collection could be present.

In many countries, when you buy a new appliance, the old one may be returned to the retailer who has to collect it free of charge on a one-to-one basis, as long as the equipment is of equivalent type and has the same functions as the supplied equipment.

## GIAS Service

- To ensure the continued safe and efficient operation of this appliance we recommend that any servicing or repairs are only carried out by an authorised GIAS service engineer.

## Electrical Requirements

Tumble dryers are supplied to operate at a voltage of 220-240V, 50 Hz single phase. Check that the supply circuit is rated to at least 13A.

- **Electricity can be extremely dangerous.**
- **This appliance must be earthed.**
- **The socket outlet and the plug on the appliance must be of the same type.**
- **Do not use multiple adapters and/or extension leads.**
- **The plug should be accessible for disconnection after the appliance has been installed.**

CE Appliance complies with European Directive 2004/108/EC, 2006/95/EC and subsequent amendments.

 You may be charged for a service call if a problem with your machine is caused by incorrect installation.

 If the mains cord on this appliance is damaged, it must be replaced by a special cord which is **ONLY** obtainable from the spares service. It must be installed by a competent person.

 If the appliance is not running properly or breaks down, switch it off and disconnect the plug from the socket. Consult GIAS Service for possible repair.

## Adjusting the Feet

Once the machine is in place the feet should be adjusted to ensure that the machine is level.

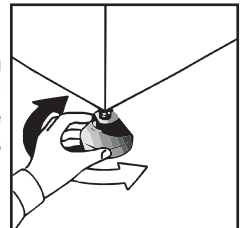

# VENTILATION

## Installation of the Discharge Hose

It is essential to use a venting hose to carry the hot moist air away from the dryer unless the dryer is situated in a open space with a good air flow around it. Recirculation of the moist air will prevent the efficient operation of the dryer.

The hose is assembled to the machine as shown. The hose may be fitted through a wall or through an open door or window. The hose is 110mm in diameter and will extend 1.8 meters.

The following guidelines should be followed when installing the discharge hose.

- Do not use two hoses joined together as the drying performance will be reduced.
- Do not restrict the flow of air through the hose e.g. by kinking it or fitting a smaller diameter connector to mount to a wall opening.
- Avoid the hose making U shaped curves as this will restrict the flow of air and increase the chance that water will collect in the hose.
- Check the hose regularly to remove any build-up of fluff or water that may have collected in it.

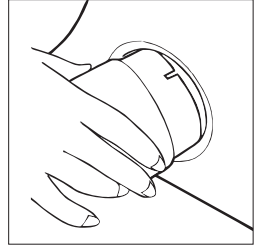

The following diagrams give examples of good and bad installations.

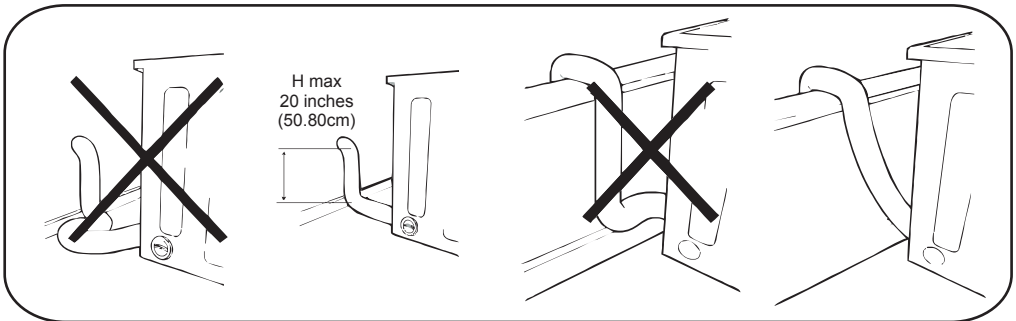

## PREPARING THE LOAD

Before using the tumble dryer for the first time:

- Please read this instruction book thoroughly.
- Remove all items packed inside drum.
- Wipe the inside of the drum and door with a damp cloth to remove any dust which may have settled in transit.

## Clothes Preparation

Make sure that the laundry you are going to dry is suitable for drying in a tumble dryer, as shown by the care symbols on each item.

Check that all fastenings are closed and that pockets are empty. Turn the articles inside out. Place clothes loosely in the drum to make sure that they don't get tangled.

# PREPARING THE LOAD

## Do Not Tumble Dry:

Woolens, silk, delicate fabrics, nylon stockings, delicate embroidery, fabrics with metallic decorations, garments with PVC or leather trimmings, training shoes, bulky items such as sleeping bags, etc.

**⚠ IMPORTANT:** Do not dry articles which have been treated with a dry cleaning fluid or rubber clothes (danger of fire or explosion).

During the last 15 minutes the load is always tumbled in cool air.

## Energy Saving

Only put into the tumble dryer laundry which has been thoroughly wrung or spin-dried. The drier the laundry the shorter the drying time thus saving electricity.

### ALWAYS

- Try to dry the maximum weight of laundry, this will save time and electricity.

- Check that the filter is clean before every drying cycle.

### NEVER

- Exceed the maximum weight, this will waste time and electricity.

- Put dripping wet items into the tumble dryer, this may damage the appliance.

**⚠** Do not overload the drum, large items when wet can exceed the maximum admissible clothes load (for example: sleeping bags, duvets).

## Maximum Drying Weight

Cottons	Max.	9 Kg	8 Kg	7 Kg	6 Kg
Synthetics	Max.	4 Kg	4 Kg	3,5 Kg	3 Kg

## Sort the Load as Follows

### •By care symbols

These can be found on the collar or inside seam:



Suitable for tumble drying.



Tumble drying at high temperature.



Tumble drying at low temperature only.



Do not tumble dry.

If the item does not have a care label it must be assumed that it is not suitable for tumble drying.

### •By amount and thickness

Whenever the load is bigger than the dryer capacity, separate clothes according to thickness (e.g. towels from thin underwear).

### •By type of fabric

**Cottons/linen:** Towels, cotton jersey, bed and table linen.

**Synthetics:** Blouses, shirts, overalls, etc. made of polyester or polyamid, as well as for cotton/synthetic mixes.

### •By drying level

Sort into: iron dry, cupboard dry, etc. For delicate articles press the Delicados button to select low drying temperature.

## Drying Guide

The standard cycle CUPBOARD DRY (☐) is the most energy efficient and best suited for drying normal wet cotton laundry.

The table in last page shows the approximate time and energy consumption of the main drying programmes.

Capacity (as energy label)	6 kg / 7 kg	8 kg / 9 kg
Power consumption of off-mode	0,25 W	0,20 W
Power consumption of on-mode	0,80 W	0,80 W

# CONTROLS AND INDICATORS

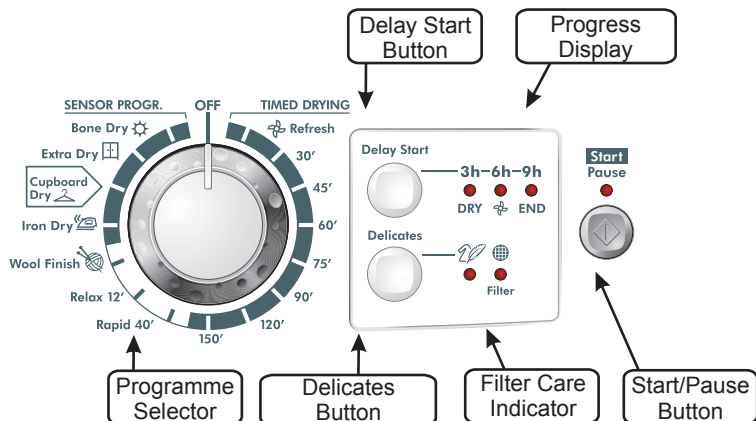

## Control Panel and Indicator Lights

**Programme Selector** – Select the required programme

**Delay Start button** – Allows the user to delay the start of the drying cycle (see details of Operation on page 10)

**Start/Pause button** – Press to commence the selected drying programme

**Delicates button**  – Press to reduce the heat level for delicate items, the indicator above the button will light up. To change the heat setting the programme must be reset

**Low Heat** – Indicator light **ON**

**High Heat** – Indicator light **OFF**

**Filter Care indicator**  – Lights when the filter needs cleaning

## Progress display

**DRY** – When the programme is selected the **DRY** indicator will flash, when the programme starts the **DRY** indicator will light up.

 – Indicator lights when there is a short time left until completion of the programme. At this stage of the drying cycle the machine enters the Cool Down phase.

The length of the Cool Down phase varies between 10 and 15 minutes depending on the programme.

**END** – Indicator lights when the programme is finished.

## SELECTING THE PROGRAMME

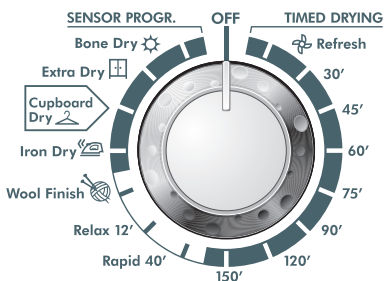

The Sensor Dry machine gives many options for drying the laundry to suit all circumstances. The table on the next page lists the programmes and the function of each programme.





**Note:** The sensor may not detect a small load of small articles. For small loads and separate items or pre-dried fabrics with low moisture content, use the timed programmes.

Set the programme between 30 and 75 minutes depending on the load size and dryness required, and select high or low heat depending upon the fabric type.

If the sensor does not detect the item the dryer will only operate for 10 minutes before going into cooldown.

If the load is too large or too wet to tumble dry the dryer will automatically go into cooldown after approximately 3 hours.

## SELECTING THE PROGRAMME

PROGRAMME	DESCRIPTION
<b>Bone Dry</b> 	Select the degree of dryness that you require. This ranges from Bone Dry cycle for bath towels and bathrobes, Extra Dry cycle through for items that will be put away without ironing, to the programme that leaves the laundry suitable for ironing.
<b>Extra Dry</b> 	
<b>Cupboard Dry</b> 	
<b>Iron Dry</b> 	
<b>Wool Finish</b> 	A gentle programme specially created to get woollens softer after air-drying. This delicate warm air cycle, lasting 12 minutes, can also be used to get woollens 'refreshed' after being stored in the wardrobe.
<b>Relax 12</b>	The programme provides a conditioning and antcrease function. The dryer will heat the load for 9 minutes followed by a 3 minute cool down period and is especially good for garments which may have been left for some time prior to ironing, in a linen basket for example. Garments may also become stiffened when dried outside on a washing line or inside on radiators. This programme relaxes the creases in the fabric making ironing quicker and easier.
<b>Rapid 40</b>	The 40' Rapid programme allows a drying cycle to be completed quickly. This is an ideal programme for having dry, refreshed and ready-to-wear clothes in less than 40'. This special programme constantly monitors the dryness and temperature in the drum thanks to the sensor using, using the exact time and energy you need! The machine finishes the cycle when the cupboard dry level is reached. The stated cycle length could vary according to fabric types, load size and residual moisture in the garments. The maximum load is 2kg and the programme is suitable for all types of fabric where tumble drying is appropriate.
<b>150'</b>	150' minutes of drying
<b>120'</b>	120' minutes of drying
<b>90'</b>	90' minutes of drying
<b>75'</b>	75' minutes of drying
<b>60'</b>	60' minutes of drying
<b>45'</b>	45' minutes of drying
<b>30'</b>	30' minutes of drying
<b>Refresh</b>	Tumbling the laundry in cool air for 20 minutes

# DOOR and FILTER

## Opening the Door

Pull on handle to open the door.

To restart the dryer, close the door and press Start/Pause button .

**⚠ WARNING!** When the tumble dryer is in use the drum and door may be VERY HOT. Never stop a tumble dryer before the end of the drying cycle unless all items are quickly removed and spread out so that the heat is dissipated.

## Filter

**IMPORTANT:** To maintain the efficiency of the dryer check that the fluff filter is clean before each drying cycle.

1. Pull the filter upwards.

2. Open filter as shown.

3. Gently remove lint using a soft brush or your fingertips.

4. Snap the filter together and push back into place.

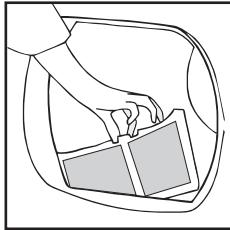

## Filter Care Indicator

**⊕** Lights when the filter needs cleaning.

If the laundry is not drying check that the filter is not clogged. The indicator will also light when the venting hose is blocked or kinked.

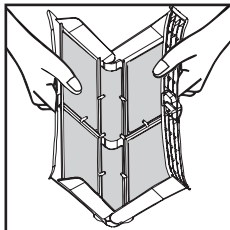

## OPERATION

1. Open the door and load the drum with laundry. Ensure that garments do not hinder closure of the door.

2. Gently close the door pushing it slowly until you hear the door 'click' shut.

3. Turn the Programme Selector dial to select the required drying programme (see Programme Guide).

4. If drying synthetics, acrylics or delicate items, Press the Delicates button to reduce the heat level.

The light next to the push button will light up when the machine is in low heat setting. To deselect in the first few minutes of the programme, press the Delicates button, after this time reset the machine to change the setting.

5. Press the Start/Pause button. The dryer will start automatically and the DRY indicator will be continuously lit.

6. If the door is opened during the programme to check the laundry, it is necessary to press Start/Pause to recommence drying after the door has been closed.

7. When the cycle is nearing completion the machine will enter the cool down phase, the clothes will be tumbled in cool air allowing the load to cool down.

8. When the programme is complete the END indicator will light.

9. Following the completion of the cycle the drum will rotate intermittently to minimize creasing. This will continue until the machine is switched OFF or the door is Opened.

**⚠ DO NOT USE WATER TO CLEAN THE FILTER.**

## Delay Start Function

The Delay Start Function allows the user to delay the start of the drying cycle by 3, 6 or 9 hours.

When the function is first selected the display will show a delay of 3 hours, subsequent presses of the button will increase the delay to 6 or 9 hours.

To commence the programme press Start/Pause and the appliance will complete the drying cycle at the end of this time. The 3, 6 or 9 hour indicator light will flash to indicate that the start delay is in progress.

## Cancelling and Resetting the Programme

To cancel a programme press the Start/Pause button for 3 seconds. The DRY light will flash to indicate that it has been reset.

## CLEANING AND ROUTINE MAINTENANCE

### Cleaning the Dryer

- Clean the filter every drying cycle.
- Regularly clean the condenser.
- After each period of use, wipe the inside of the drum and leave the door open for a while to allow circulation of air to dry it.
- Wipe the outside of the machine and the door with a soft cloth.
- DO NOT use abrasive pads or cleaning agents.
- To prevent the door sticking or the build up of fluff, clean the inner door and gasket with a damp cloth after every drying cycle.

### Information for Test Laboratory

#### EN 61121 Programme

-DRY COTTON  
-IRON DRY COTTON  
-EASY-CARE TEXTILE

#### Programme to Use

-CUPBOARD DRY  
-IRON DRY  
-CUPBOARD DRY+SYNTHETIC

### Technical Specifications

Drum capacity	115
Maximum load	See energy label
Height	85 cm
Width	60 cm
Depth	60 cm
Energy class	See energy label

 **IMPORTANT** Always switch off and remove the plug from the electricity supply before cleaning this appliance.

 **WARNING!** The Drum, door and load may be very hot.

 For electrical data refer to the rating label on the front of the dryer cabinet (with the door open).

# TROUBLESHOOTING

## What Might be the Cause of...

### Defects you can remedy yourself

Before calling GIAS Service for technical advice please run through the following checklist. A charge will be made if the machine is found to be working or has been installed incorrectly or used incorrectly.

If the problem persists after completing the recommended checks, please call GIAS Service, they may be able to assist you over the telephone.

### Drying time is too long/clothes are not dry enough...

- Have you selected the correct drying time/programme?
- Were the clothes too wet? Were the clothes thoroughly wrung or spindried?
- Does the filter need cleaning?
- Is the dryer overloaded?
- Is the venting hose kinked or blocked?
- Has the Delicates option been selected from a previous cycle?

### The dryer does not operate...

- Is there a working electricity supply to the dryer? Check using another appliance such as a table lamp.
- Is the plug properly connected to the mains supply?
- Is there a power failure?
- Has the fuse blown?
- Is the door fully closed?
- Is the dryer switched on, both at the mains supply and at the machine?
- Has the drying time or the programme been selected?
- Has the machine been switched on again after opening the door?

### The dryer is noisy...

- Switch off the dryer and contact GIAS Service for advice.

### The filter Indicator is on...

- Does the filter need cleaning?
- Is the venting hose kinked or blocked?

## CUSTOMER SERVICE

Should there still be a problem with your dryer after completing all the recommended checks, please call GIAS Service for advice.

They may be able to assist you over the telephone or arrange for a suitable appointment for an engineer to call under the terms of your guarantee. However, a charge may be made if any of the following applies to your machine:

- Is found to be in working order.
- Has not been installed in accordance with the installation instructions.
- Has been used incorrectly.

 If the supply cord on this appliance is damaged, it must be replaced by a special cord which is only available from GIAS Service or an authorised Hoover Dealer.

## Spares

Always use genuine spares, available direct from GIAS Service.

Spares Service Tel: 08443 712758

## GIAS Service

For service and repairs call your local GIAS Service engineer.

**Phone GIAS on 08444 995599**

**Eire – 0818 2000021**

**The manufacturer declines all responsibility in the event of any printing mistakes in this booklet. The manufacturer also reserves the right to make appropriate modifications to its products without changing the essential characteristics.**



Energy

Capacity

Time



	<b>Capacity (kg)</b>		<b>6</b>	<b>7</b>	<b>8</b>	<b>9</b>	<b>7</b>
	<b>Class</b>		<b>C</b>	<b>C</b>	<b>C</b>	<b>C</b>	<b>B</b>
	Energy	kWh	4,75	5,38	6,00	6,69	4,93
	Time	Min.	155	177	195	200	200
	Energy	kWh	4,29	4,86	5,42	6,05	4,45
	Time	Min.	139	158	177	180	177
	Energy	kWh	3,80	4,30	4,80	5,35	3,94
	Time	Min.	115	131	147	157	147
	Energy	kWh	2,12	2,43	2,70	2,90	2,04
	Time	Min.	70	76	82	89	87
	Energy	kWh	3,04	3,44	3,84	4,28	3,15
	Time	Min.	95	108	121	129	121



40009221