



HOVER

OVENS
USER INSTRUCTIONS

EN **02**

Safety Indications

- **WARNING:** the appliance and accessible parts become hot during use. Be careful not to touch any hot parts.
- **WARNING:** the accessible parts can become hot when the grill is in use. Children should be kept at a safe distance.
- **WARNING:** ensure that the appliance is switched off before replacing the bulb, to avoid the possibility of electric shocks.
- **WARNING:** in order to avoid any danger caused by the accidental resetting of the thermal interruption device, the appliance should not be powered by an external switching device, such as a timer, or be connected to a circuit that is regularly switched on and off.
- Children under 8 should be kept at a safe distance from the appliance if not continuously supervised.
- Children should not play with the appliance. The appliance can be used by those aged 8 or over and by those with limited physical, sensorial or mental capacities, without experience or knowledge of the product, only if supervised or provided with instruction as to the operation of the appliance, in a safe way with awareness of the possible risks.
- Cleaning and maintenance should not be carried out by unsupervised children.
- Do not use rough or abrasive materials or sharp metal scrapers to clean the oven door glasses, as they can scratch the surface and cause the glass to shatter.
- The oven must be switched off before removing the removable parts and, after cleaning, reassemble them according the instructions.
- Do not use a steam cleaner.
- Put the plug into a socket equipped with a third contact which corresponds to the earth and which must be connected and in operation. For models without a plug, attach a standard plug to the cable that is able to bear the load indicated on the tag. The earth conductor is yellow-green in colour. This operation should be carried out by a suitably qualified professional. In case of incompatibility between the socket and the appliance plug, ask a qualified electrician to substitute the socket with another suitable type. Connection to the power source can also be made by placing an omnipolar breaker between the appliance and the power source that can bear the maximum connected load and that is in line with current legislation. The yellow-green earth cable should not be interrupted by the breaker. The socket or omnipolar breaker used for the connection should be easily accessible when the appliance is installed.
- If the power cable is damaged, it should be substituted with a cable or special bundle available from the manufacturer or by contacting the customer service department.
If the cable is damaged, replace it promptly in accordance with the following instructions:
 - open the cover of the terminal block;
 - remove the power cable and substitute it with a similar cable which is compatible with the appliance (type H05VV-F, H05V2V2-F).
- This operation should be carried out by a suitably qualified professional. The earth conductor (yellow-green) must be approximately 10 mm longer than the other conductors. For any repairs, refer only to the Customer Care Department and request the use of original spare parts.
- Failure to comply with the above can compromise the safety of the appliance and invalidate the guarantee.
- Any excess of spilled material should be removed before cleaning.
- A long power supply failure during an occurring cooking phase may cause a malfunction of the monitor. In this case contact customer service.

General Instructions

4

- 1.1 Safety indications
- 1.2 Electrical safety
- 1.3 Recommendations
- 1.4 Installation
- 1.5 Waste management and environmental protection
- 1.6 Declaration of compliance

Product Description

5

- 2.1 Overview
- 2.2 Accessories

Use of the Oven

5

- 3.1 User interface description
- 3.2 Product setting
- 3.3 First use
- 3.4 Operating in manual mode
- 3.5 Home page - Main functions
- 3.6 Cooking modes

Simply-Fi

9

- 4. One-Fi

Oven Cleaning and Maintenance

10

- 5.1 General notes on cleaning
- 5.2 Maintenance
 - Removal and cleaning of the side racks
 - Cleaning of the interior glass door only
 - Changing the lamp bulb

1. General Instructions

We thank you for choosing one of our products. For the best results with your oven, you should read this manual carefully and retain it for future reference. Before installing the oven, take note of the serial number so that you can give it to customer service staff if any repairs are required. Having removed

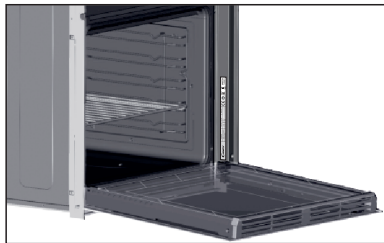

the oven from its packaging, check that it has not been damaged during transportation. If you have doubts, do not use the oven and refer to a qualified technician for advice. Keep all of the packaging material (plastic bags, polystyrene, nails) out of the reach of children. When the oven is switched on for the first time, strong smelling smoke can develop, which is caused by the glue on the insulation panels surrounding the oven heating for the first time. This is absolutely normal and, if it occurs, you should wait for the smoke to dissipate before putting food in the oven. The manufacturer accepts no responsibility in cases where the instructions contained in this document are not observed.

NOTE: the oven functions, properties and accessories cited in this manual will vary, depending on the model you have purchased.

1.1 Safety Indications

Only use the oven for its intended purpose, that is only for the cooking of foods; any other use, for example as a heat source, is considered improper and therefore dangerous. The manufacturer cannot be held responsible for any damage resulting from improper, incorrect or unreasonable usage.

The use of any electrical appliance implies the observance of some fundamental rules:

- do not pull on the power cable to disconnect the plug from the socket;
- do not touch the appliance with wet or damp hands or feet;
- in general the use of adaptors, multiple sockets and extension cables is not recommended;
- in case of malfunction and/or poor operation, switch off the appliance and do not tamper with it.

1.2 Electrical Safety

ENSURE THAT AN ELECTRICIAN OR QUALIFIED TECHNICIAN MAKES THE ELECTRICAL CONNECTIONS.

The power supply to which the oven is connected must conform with the laws in force in the country of installation. The manufacturer accepts no responsibility for any damage caused by the failure to observe these instructions. The oven must be connected to an electrical supply with an earthed wall outlet or a disconnector with multiple poles, depending on the laws in force in the country of installation. The electrical supply should be protected with suitable fuses and the cables used must have a transverse section that can ensure correct supply to the oven.

CONNECTION

The oven is supplied with a power cable that should only be connected to an electrical supply with 220-240 Vac 50 Hz power between the phases or between the phase and neutral. Before the oven is connected to the electrical supply, it is important to check:

- power voltage indicated on the gauge;
- the setting of the disconnector.

The grounding wire connected to the oven's earth terminal must be connected to the earth terminal of the power supply.

WARNING

Before connecting the oven to the power supply, ask a qualified electrician to check the continuity of the power supply's earth terminal. The manufacturer accepts no responsibility for any accidents or other problems caused by failure to connect the oven to the earth terminal or by an earth connection that has defective continuity.

NOTE: as the oven could require maintenance work, it is advisable to keep another wall socket available so that the oven can be connected to this if it is removed from the space in which it is installed. The power cable must only be substituted by technical service staff or by technicians with equivalent qualifications.

A low light around the central main switch could be present when the oven is off. This is a normal behavior. It can be removed just turning the plug upside down or swapping the supply terminals.

1.3 Recommendations

After each use of the oven, a minimum of cleaning will help keep the oven perfectly clean.

Do not line the oven walls with aluminium foil or single-use protection available from stores. Aluminium foil or any other protection, in direct contact with the hot enamel, risks melting and deteriorating the enamel of the insides. In order to prevent excessive dirtying of your oven and the resulting strong smokey smells, we recommend not using the oven at very high temperature. It is better to extend the cooking time and lower the temperature a little. In addition to the accessories supplied with the oven, we advise you only use dishes and baking moulds resistant to very high temperatures.

1.4 Installation

The manufacturers have no obligation to carry this out. If the assistance of the manufacturer is required to rectify faults arising from incorrect installation, this assistance is not covered by the guarantee. The installation instructions for professionally qualified personnel must be followed. Incorrect installation may cause harm or injury to people, animals or belongings. The manufacturer cannot be held responsible for such harm or injury.

The oven can only be located high in a column. Before fixing, you must ensure good ventilation in the oven space to allow proper circulation of the fresh air required for cooling and protecting the internal parts. Make the openings specified on last page according to the type of fitting.

1.5 Waste management and environmental protection



This appliance is labelled in accordance with European Directive 2012/19/EU regarding electric and electronic appliances (WEEE). The WEEE contain both polluting substances (that can have a negative effect on the environment) and base elements (that can be reused). It is important that the WEEE undergo specific treatments to correctly remove and dispose of the pollutants and recover all the materials. Individuals can play an important role in ensuring that the WEEE do not

become an environmental problem; it is essential to follow a few basic rules:

- the WEEE should not be treated as domestic waste;
- the WEEE should be taken to dedicated collection areas managed by the town council or a registered company.

In many countries, domestic collections may be available for large WEEEs. When you buy a new appliance, the old one can be returned to the vendor who must accept it free of charge as a one-off, as long as the appliance is of an equivalent type and has the same functions as the purchased appliance.

SAVING AND RESPECTING THE ENVIRONMENT

Where possible, avoid pre-heating the oven and always try to fill it. Open the oven door as infrequently as possible, because heat from the cavity disperses every time it is opened. For a significant energy saving, switch off the oven between 5 and 10 minutes before the planned end of the cooking time, and use the residual heat that the oven continues to generate. Keep the seals clean and in order, to avoid any heat dispersal outside of the cavity. If you have an electric contract with an hourly tariff, the "delayed cooking" programme makes energy saving more simple, moving the cooking process to start at the reduced tariff time slot.

1.6 Declaration of compliance

• By placing the  mark on this product, we are confirming compliance to all relevant European safety, health and environmental requirements which are applicable in legislation for this product.

• With this the Candy Hoover Group, declares that this appliance marked with  complies with the essential requirements of the Directive 2014/53/EU.

To receive a copy of the declaration of conformity, please contact the manufacturer at: www.candy-group.com.

2. Product Description

2.1 Overview

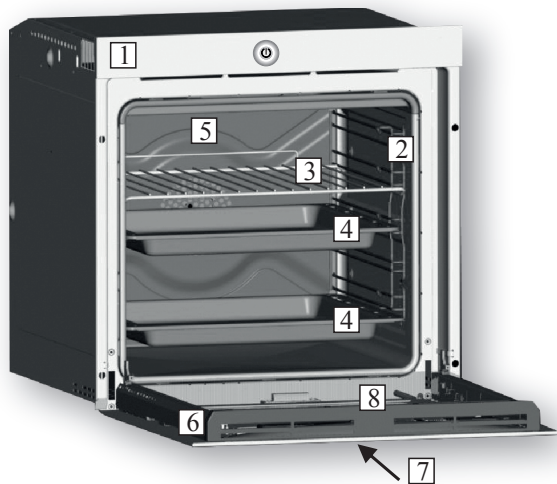

1. Control panel
2. Shelf positions (lateral wire grid if included)
3. Metal grill
4. Drip pan
5. Fan (behind the steel plate)
6. Oven door
7. Touch control panel on the door
8. Camera

2.2 Accessories (According to model)

1 Metal grill

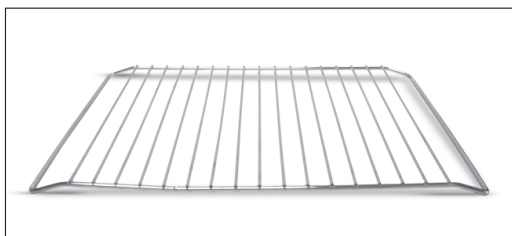

Holds baking trays and plates.

2 Drip pan

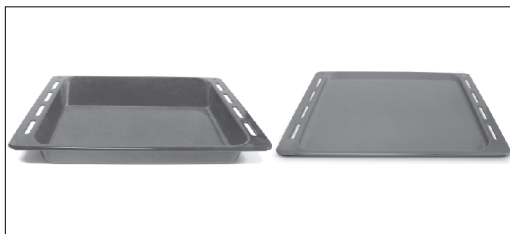

Collects the residues that drip during the cooking of foods on the grills.

3. Use of the Oven

3.1 User interface description

1. Main switch on/off
2. LCD touch interface



3.2 Product Setting

- At first launch you need to follow an installation process to be able to use the oven. Press START to go ahead.
- Select the language from the drop down menu. Press NEXT to go ahead.
- Set the date from the calendar. Set the time from the clock. Press NEXT to go ahead.
- Select your home network from the drop down menu. Insert the password related to your home network. Press NEXT to go ahead and wait the loading or connection.
- NB: The oven works even if not connected to the network. It's possible to enroll the oven to the network at a later time.
- The enrollment has been completed successfully. Press NEXT to go ahead to the last step.
- The installation process is completed. Press GO TO HOME PAGE to start to use the oven.

For more details see quick guide.

WIRELESS PARAMETERS DOOR DEVICE

Parameter	Specifications
Wireless Standard	802.11 b/g/n
Frequency Range	2,400 GHz. – 2,497 GHz
Max Trasmit Power	802.11b (11Mbps) +16 ± 2 dBm 802.11g (54Mbps) +13 ± 2 dBm 802.11n (HT20, MCS7) +13 ± 2 dBm
Minimum Receiving Sensitivity	802.11b (11Mbps) - 86 ± 2 dBm 802.11g (54Mbps) - 70 ± 2 dBm 802.11n (HT20, MCS7) - 66 ± 2 dBm
Channel	13

3.3 First Use

PRELIMINARY CLEANING

Clean the oven before using for the first time. Wipe over external surfaces with a damp soft cloth. Wash all accessories and wipe inside the oven with a solution of hot water and washing up liquid. Set the empty oven to the maximum temperature and leave on for about 1 hour, this will remove any lingering smells of newness.

3.4 Operating In Manual Mode

- Press the Manual Mode tab to set a cooking in 3 simple steps.
 - Swipe and select the desired cooking function. Press NEXT to go ahead
 - Swipe to select the desired temperature. Press NEXT to go ahead or BACK to return to the cooking functions selection.
 - Swipe to select the cooking time. Press START to begin the cooking or BACK to return to the temperature setting.
- In this screen it is possible to:
- exclude pre heating (setted by default)
 - set delayed start
- When a cooking is running you can:
- change the temperature
 - change the cooking time
 - press the webcam icon to watch inside the oven cavity
 - press STOP to finish the cooking

3.5 Home Page - Main Functions

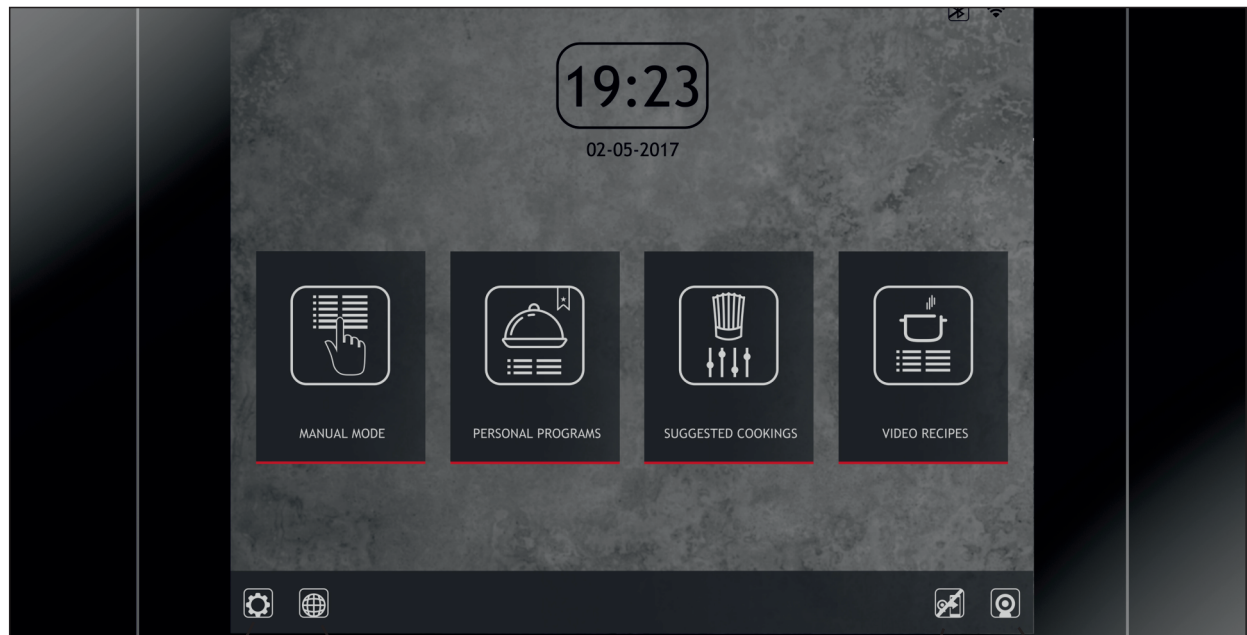

SETTINGS

Entering in this screen it will be possible to set:

- language
- date and time
- wifi
- bluetooth audio
- screen options

WEB BROWSER

Entering in this screen it will be possible to surf on internet within a list of authorized websites.

WEBCAM

Pressing the webcam icon you can watch inside the oven to monitor the cooking progress.

OVEN-DEVICE CONNECTION (ONEFi)













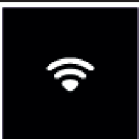

The oven is sending all the data to the connected device













The oven is not sending the data to the device

NB: If this option is activated, the oven is driven only by the connected device.

FUNCTION	WHAT IS DOES
	<p>MANUAL MODE: In this mode it is possible to chose cooking functions, temperature and cooking duration, by 3 simple steps. In this mode it is also possible to set a cooking delay. NOTE: By default the preheating option is active: to turn it off click on the  symbol</p>
	<p>PERSONAL PROGRAMS: In this mode it is possible to save and, in a second time, to select, customized cooking programs.</p>
	<p>SUGGESTED COOKING: In this mode it is possible to select a suggested cooking program. During the cooking fase, it is possible to change temperature and cooking duration.</p>
	<p>VIDEO RECIPES: In this mode it is possible to select some tutorial about how to prepare several recipes. At the end of the video it is possible to start cooking. It is not possible to change the cooking parametrs.</p>
 	<p>INTERNET CONNECTION: If the icon is active the oven door is connect to the net.</p>
	<p>SETTINGS: Selecting this icon it will be possible to set language, date and time, wi-fi, bluetooth, camera brightness setting. Supported bluetooth devices are audio speakers only. Supported bluetooth standars are: 2.1, 3.0, 4.0</p>
	<p>WEB BROWSER: Selecting this icon it will be possible to surf on the internet within a list of authorized websites.</p>
 	<p>OVEN DEVICE CONNECTION (ONE-FI): On the first use, with a long press on the icon you enroll the oven on the net. With a short press on the icon, the remote control of the oven it activated. If this option is activated the oven is driven ONLY by the connected device. To control again the oven directly on the door screen click again on the icon. To see webcam streaming on the external device (APP WIZARD), the door must be connected to the net. (THE INTERNET CONNECTION ICON MUST BE ACTIVATED)</p>
	<p>WEBCAM: Pressing the webcam icon you can watch inside the oven to monitor the cooking progress. To protect the camera, the system puts it in stand-by after 1 minute (5 minutes in case of grill function). To restart it, press the button again. Do not keep it switched on for too long. In case of cooking at high temperature, if the camera stays on for a long time, its colours might change. This is a standard phenomenon and disappears when the camera and/or the oven are cooled down.</p>
	<p>HOME PAGE: Touching this icon you go back to home page</p>

3.6 Cooking Modes

Function Dial	Function <i>(Depends on the oven model)</i>
	LAMP: Turns on the oven light.
	DEFROST: When the dial is set to this position. The fan circulates air at 40°C around the frozen food so that it defrosts in a few minutes without the protein content of the food being changed or altered.
	KEEP WARM: This is recommended to reheat precooked foodstuff, positioning the shelf on the second level from top, or to defrost bread pizza or pastry by positioning the shelf on the lower level. The temperature is preset in 60°C constant, no regulation is possible.
 	FAN COOKING: We recommend you use this method for poultry, pastries, fish and vegetables. Heat penetrates into the food better and both the cooking and preheating times are reduced. You can cook different foods at the same time with or without the same preparation in one or more positions. This cooking method gives even heat distribution and the smells are not mixed. Allow about ten minutes extra when cooking foods at the same time.
* 	CONVENTIONAL COOKING: Both top and bottom heating elements are used. Preheat the oven for about ten minutes. This method is ideal for all traditional roasting and baking. For seizing red meats, roast beef, leg of lamb, game, bread, foil wrapped food (papillotes), flaky pastry. Place the food and its dish on a shelf in mid position.
	FAN + LOWER ELEMENT: The bottom heating element is used with the fan circulating the air inside the oven. This method is ideal for juicy fruit flans, tarts, quiches and pâté. It prevents food from drying and encourages rising in cakes, bread dough and other bottom-cooked food. Place the shelf in the bottom position.
* 	FAN ASSISTED GRILL: Use the turbo-grill with the door closed. The top heating element is used with the fan circulating the air inside the oven. Preheating is necessary for red meats but not for white meats. Ideal for cooking thick food items, whole pieces such as roast pork, poultry, etc. Place the food to be grilled directly on the shelf centrally, at the middle level. Slide the drip tray under the shelf to collect the juices. Make sure that the food is not too close to the grill. Turn the food over halfway through cooking.
	GRILL: Use the grill with the door closed. The top heating element is used alone and you can adjust the temperature. Five minutes preheating is required to get the elements hot. Success is guaranteed for grills, kebabs and gratin dishes. White meats should be put at a distance from the grill; the cooking time is longer, but the meat will be tastier. You can put red meats and fish fillets on the shelf with the drip tray underneath.
	PIZZA: With this function hot air circulated in the oven to ensure perfect result for dishes such as pizza or cake.
	BOTTOM: Using the lower element. Ideal for cooking all pastry based dishes. Use this for flans, quiches, tarts, pate and any cooking that needs more heat from below.

*Tested in accordance with the CENELEC EN 60350-1 used for definition of energy class for ventilated function.

4. One-fi oven enrollment

Installing the appliance

Install the appliance in accordance to the installation guide within this instruction book.

Once this step has been completed, ensure the appliance is working by controlling the appliance directly using the control panel. Please take the time to read the program guides and functions as this will help you to take full advantage of the features of your new appliance.

Please ensure that the clock time is set before trying to enrol an oven.

Locating your Wi-Fi Password

Locate the Wi-Fi Password (WPA/WEP Key) which is normally found on the back of your Wi-Fi router.

If you are having trouble locating the Wi-Fi Password, please contact your Internet Provider.

Take a note for later use

Once you have your Wi-Fi Password, please take a note of it here below as you will need this later on whilst connecting the appliance to the App.

Router name _____

Password (WPA/WEP Key) _____

Connect your device to the same Wi-Fi router ready to install the App

Downloading the App

Download the Hoover wizard App from the App store relevant to your device.

Note – The App is suitable for iOS (version 8 and greater) and Android (version 4.4 and greater). App Name – Hoover wizard.

Locating your product code

Locate the product code of your appliance with the help of the image below.

Take note of the serial number

The illustration shows the format of the appliance information. Write your product serial number here below:

Serial number (16 digits)

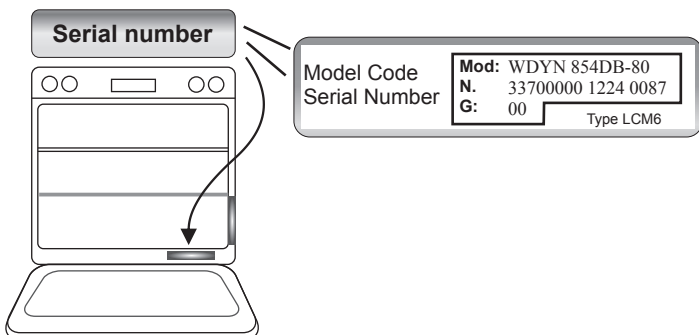

- Step 1:

Open the App Hoover wizard. Create your account by tapping on "Sign-Up". Accept the privacy policy and complete the fields.

Note – You can explore all the features of the full one-Fi range by tapping on "Demo".

- Step 2:

In the homepage, tap on the appliance that you want to connect and tap on "Ok".

- Step 3:

Insert the 16 digits serial number that you wrote down above and tap on "Next".

Check that the product details are correct and then tap on "Confirm".

- Step 4:

Once your appliance has been recognized, tap on "Next".

Then, you have 5 minutes to complete the process; otherwise, you will need to start it again.

- Step 5:

Long press the icon  to enroll the appliance.

- Step 6:

Exit the Hoover wizard app. Go to your device Wi-Fi settings.

- Step 7:

In the list of available Wi-Fi networks, select "WIFIOVEN-xyzk". If you do not find it, wait few more seconds or do a new scan.

- Step 8:

Exit from the settings of your device. Return to the Hoover wizard App and wait for the App to detect the appliance. Once the "Wi-Fi Network is active" screen appears, tap on "Next"

- Step 9:

Your home Wi-Fi Network will be automatically set by the App. (If not, enter the name of your home Wi-Fi network, paying attention to lowercase and uppercase letters). Insert the Wi-Fi Password (WPA/WEP Key), then tap on "Confirm".

- Step 10:

For more advantages, you can Register your product by tapping the dedicated button.

Tap on "Start" to return in the App Homepage.

- Remote control mode

With a short press on the icon  the oven can be remotely controlled.

To control again the oven directly on the door screen do a short press on the icon 

To see webcam streaming on the external device (APP WIZARD), the door must be connected to the net.

- If the set up does not complete

It's important that there is a good Wi-Fi signal strength from the home router to the appliance: low Wi-Fi signal strength would cause the final stage of the set up to fail. To establish if this is the case, start the connection process again from Step 1; once at Step 8, place with your device (smartphone or tablet) next to the router and search for "WIFIOVEN-xyzk" net generated by the machine. If this does not come up as an option, this means the router cannot see the appliance. In this case, we recommend to bring the router near to the machine (if possible) or contact your internet provider and require the assistance to purchase a compatible "Wi-Fi Range Extender" to increase the signal strength.

WIRELESS PARAMETERS MAIN BOARD

Parameter	Specifications
Wireless Standard	802.11 b/g/n
Frequency Range	2,412 GHz. – 2,484 GHz
Max Trasmit Power	802.11b (11Mbps) +16 ± 2 dBm
	802.11g (54Mbps) +14 ± 2 dBm
	802.11n (HT20, MCS7) +13 ± 2 dBm
Minimum Receiving Sensitivity	802.11b (11Mbps) - 93 dBm
	802.11g (54Mbps) - 85 dBm
	802.11n (HT20, MCS7) - 82 dBm
Channel	11

5. Oven cleaning and maintenance

5.1 General notes on cleaning

The lifecycle of the appliance can be extended through regular cleaning. Wait for the oven to cool before carrying out manual cleaning operations. Never use abrasive detergents, steel wool or sharp objects for cleaning, so as to not irreparably damage the enamelled parts. Use only water, soap or bleach-based detergents (ammonia).

GLASS PARTS

It is advisable to clean the glass window with absorbent kitchen towel after every use of the oven. To remove more obstinate stains, you can use a detergent-soaked sponge, well wrung out, and then rinse with water.

OVEN WINDOW SEAL

If dirty, the seal can be cleaned with a slightly damp sponge.

ACCESSORIES

Clean accessories with a wet, soapy sponge before rinsing and drying them: avoid using abrasive detergents.

DRIP PAN

After using the grill, remove the pan from the oven. Pour the hot fat into a container and wash the pan in hot water, using a sponge and washing-up liquid.

If greasy residues remain, immerse the pan in water and detergent. Alternatively, you can wash the pan in the dishwasher or use a commercial oven detergent. Never put a dirty pan back into the oven.

5.2 Maintenance

REMOVAL AND CLEANING OF THE SIDE RACKS

1- Remove the wire racks by pulling them in the direction of the arrows (see below)

2- To clean the wire racks either put them in the dishwasher or use a wet sponge, ensuring that they are dried afterwards.

3- After the cleaning process install the wire racks in reverse order.

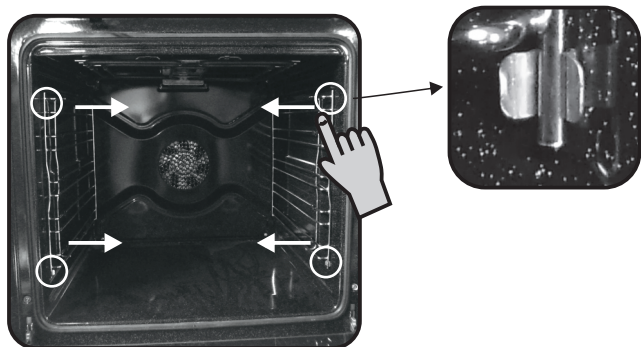

CLEANING OF THE INTERIOR GLASS DOOR ONLY

1. Open the oven door.

2.3.4. Lock the hinges, remove the screws and remove the upper metal cover by pulling it upwards.

5.6. Remove the glass, carefully extracting it from the oven door (NB: don't remove any other glass or component).

7. At the end of cleaning or substitution, reassemble the parts in reverse order.

On all glass, the indication "Low-E" must be legible and positioned on the left side of the door, close to the left-hand lateral hinge. In this way, the printed label of the first glass will be inside the door.

1.



2.

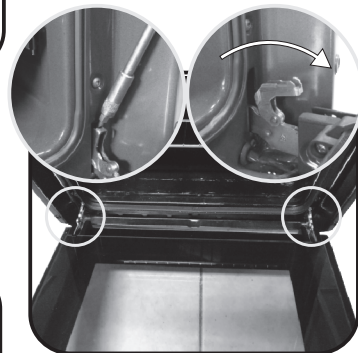

3.

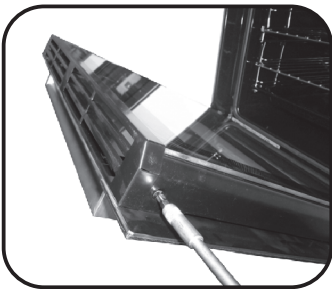

4.

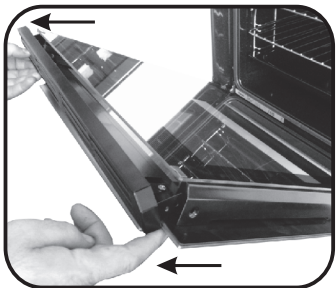

5.

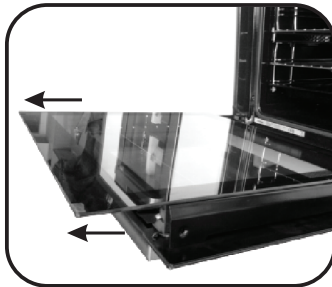

6.

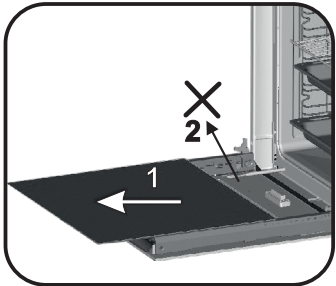

7.

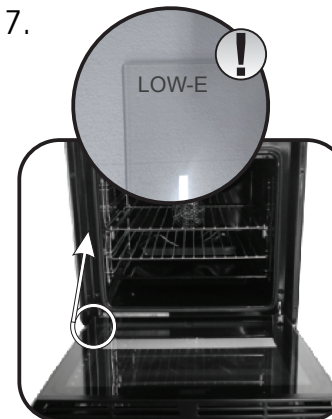

CHANGING THE LAMP BULB

1. Disconnect the oven from the mains supply.
2. Undo the glass cover, unscrew the bulb and replace it with a new bulb of the same type.
3. Once the defective bulb is replaced, replace the glass cover.

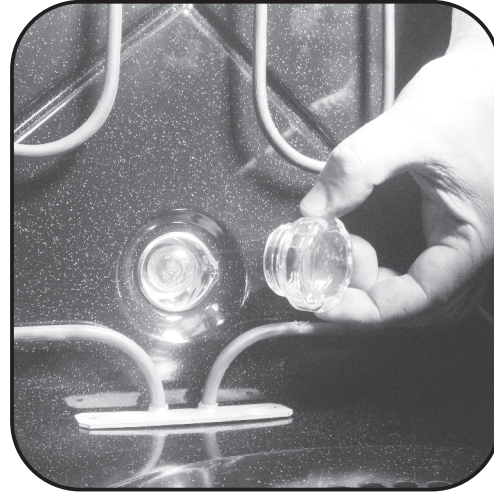

NOTE:

For any issue with the led light system present in the door contact customer service.

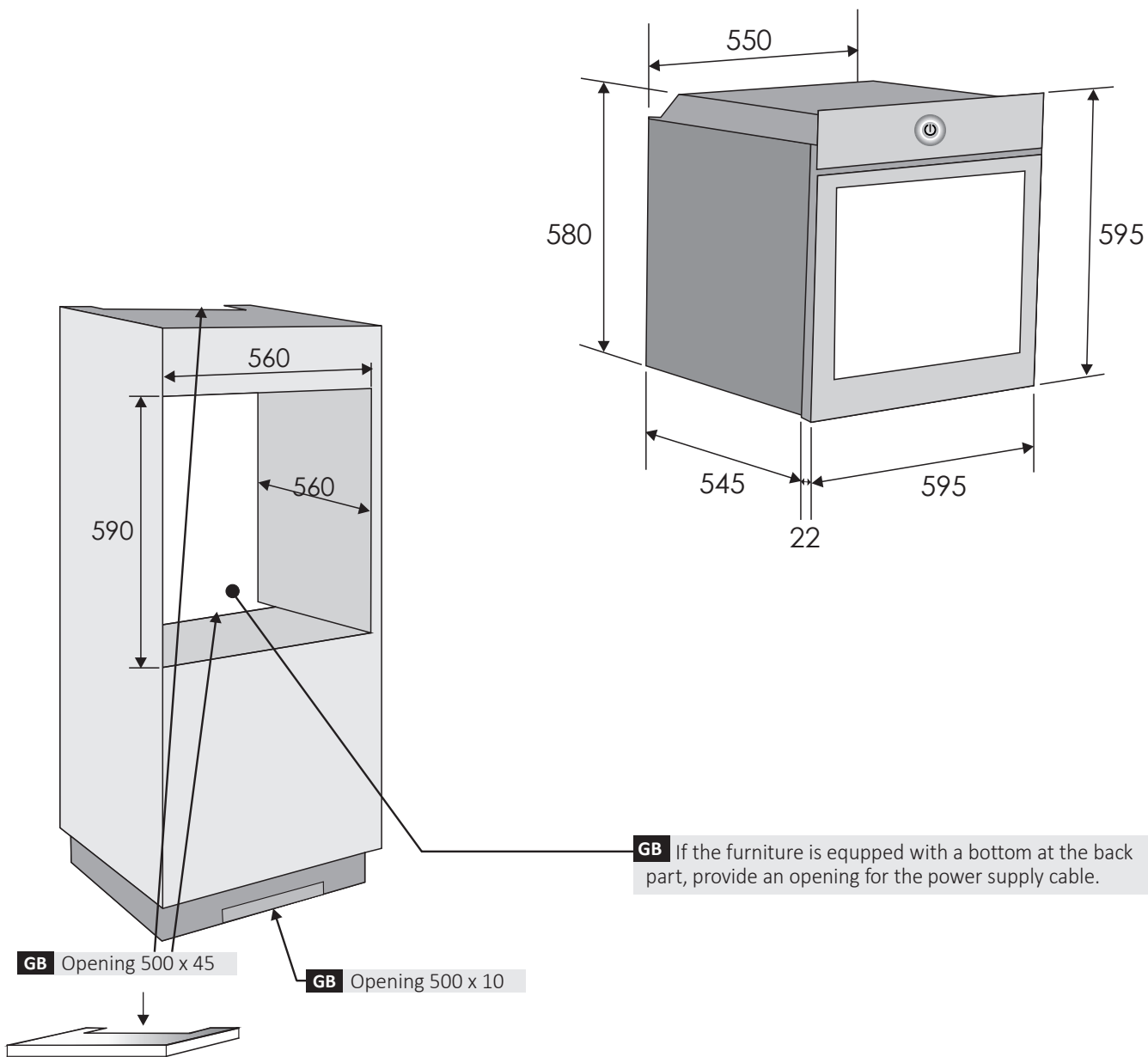

GB NOTE: This product can be installed in column position only.

