

XS3

**3-Channel, 6-Model Memory
Synthesized FM Computer
Racing System**



JR RACING

JR RACING
SYNTHESIZED 3 CHANNEL 6 MODEL MEMORY
FM MODULATION COMPUTER RACE SYSTEM **XS3**

Table of Contents

Introduction	2	Accessing the System Mode	13
XS3 Quick Start Setup	3	Model Select	14
Direct Trim Access	5	Synthesized Channel Select	14
Servo Trim Adjustment	5	Model Name Entry	15
System Features	6	Frame Rate Select	16
Transmitter	6	Channel 3 Function Select	17
Receiver	6	Grip Button C Function Select	18
Servos	6	Data Reset	19
System Specifications	6	Copy Model Data	19
Components	6	Accessing the Function Mode	20
Transmitter	6	Throttle Deadband	21
Receiver	6	Exponential	22
Servos	6	End-Point Adjustment	23
Control Identification and Location	7	Programmable Mixing	25
RC Safety Precautions	8	Lap-Timer	26
Steering Tension Adjustment	8	Sub-Trim	27
Charging Jack	8	Servo Reversing	28
Receiver/Servo Connections and Installation	9	Accessing the Direct Trim Mode	29
Operating Your Model	10	Steering Trim	30
Servo Layout	11	Throttle Trim	30
Key Input and Display	11	Grip Lever B: Steering Dual-Rate Trim Adjustment	31
Display Screens	12	Grip Lever A: Brake End-Point Adjustment	32
Normal Display	12	Auxiliary Channel 3 Access	32
Up-Timer	12	XS3 Data Sheets	33
Low-Battery	12	Frequency Chart	36
Lithium Battery	12	Warranty and Service Information	37
Memory Backup	12		

Introduction

Thank you for purchasing the JR Racing XS3 Synthesized FM 3-Channel Radio system. You have likely chosen the XS3 radio system for its synthesized PLL channel select capabilities found on both the transmitter and the receiver, eliminating the need for crystals and providing you with access to virtually all available channels on 27MHz or 75MHz.

This system has been designed to provide RC racers with a high quality, user-friendly radio system that can be relied upon year after year, race after race. The XS3's grip dial accessible auxiliary third channel is ideal for use as a mixture channel in gas boats or as a transmission shifter for vehicles such as the Traxxas T-Maxx. It is important that you carefully read this manual before attempting to operate your XS3 system.

For your convenience, blank data sheets have been included in the back of this manual. Once you have input all the necessary data for a particular model into your transmitter, we strongly recommend that you immediately write that information down on the data sheet provided. This will insure that in the rare case of a memory failure, you will not lose the models' setup data.

For those who would like to get out to the track quickly with just the basic radio setup, please refer to the Quick Start section that follows.

XS3 Quick Start Setup

Included in this manual are in-depth instructions detailing all the steps and procedures needed to correctly program each of the XS3's features. Quick Start covers the basic programming information necessary to get you to the track fast. Later, when you want to learn more about the specific features of the XS3, refer to the appropriate page(s) in this manual for more detailed programming information.

Note: If the Auxiliary Channel 3 is required, refer to the Auxiliary Channel 3 System Mode (page 19) for instructions.

Synthesized TX Channel Select

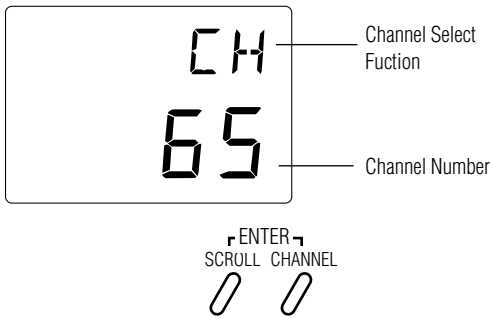

1. Press the *Scroll* and *Channel* keys at the same time and hold.

2. Turn the transmitter power switch on to enter System mode.



3. Press the *Scroll* key until "CH" appears on the screen.

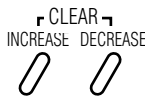

4. Press the *Increase* or *Decrease* key to select the desired transmitting channel number (1–6) on 27MHz or (61–90) on 75MHz.

Note: Your XS3 radio system will only operate either on 27MHz or 75MHz, depending on the model purchased, not both. While in System mode, there is no RF output being generated by the XS3, enabling you to safely make the appropriate channel selection. You must turn the transmitter off and then back on to enable RF output.

Synthesized RX Channel Select

1. Determine the frequency band and channels available marked next to the rotary dial matches the transmitter.
2. Set the channel on the RS300 receiver to match the XS3 transmitter by adjusting the ten position rotary switches using a small 1/8" flat blade screwdriver until they point to the corresponding channel numbers.
 - To set a 75MHz receiver to channel 78, rotate the first rotary switch to the "7" position and the second rotary switch to the "8" position.
 - 27MHz receivers will only have one rotary switch for accessing channels 1–6. Use this single switch to select the desired channel.

Servo Reversing

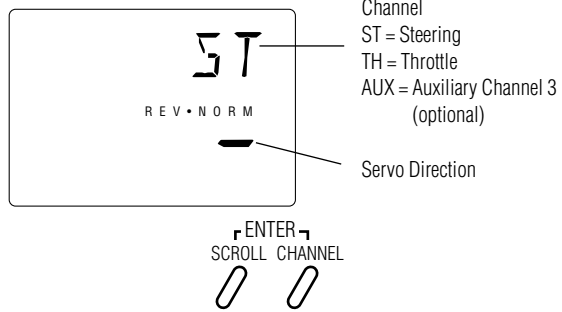

1. With the transmitter power switch on, press the *Scroll* key to enter the Function mode.



2. Press the *Scroll* key until "REV-NORM" appears on the screen. The "ST" indicates the steering servo reversing screen.

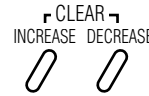

3. Press the *Increase* or *Decrease* key to move the cursor to the desired servo direction (REV-NORM).



4. Press the *Channel* key once to access the throttle servo reversing screen.

5. To select the direction of the throttle servo, repeat Step 3 above.

6. Repeat Steps 2 and 3 to adjust Auxiliary Channel 3 if needed.

XS3 Quick Start Continued

End-Point (Travel) Adjustment

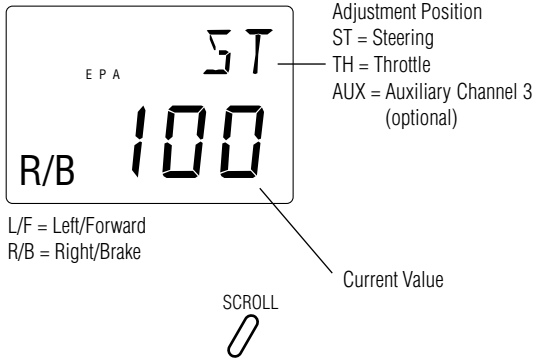

1. From the Servo Reverse function, press the *Scroll* key three times to access the End-Point (Travel) Adjustment function (the EPA screen with "ST" will appear).

Steering Adjustment

2. Rotate the steering wheel in the desired direction (left or right) to be adjusted.

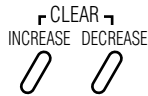

3. Press the *Increase* or *Decrease* keys to select the desired travel value.

Throttle Adjustment

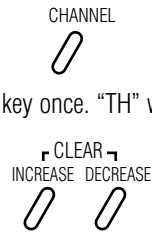

4. Press the *Channel* key once. "TH" will appear on the screen.

5. Pull the trigger forward or push the trigger for brake adjustment.

6. Press the *Increase* or *Decrease* keys to select the desired travel value.

Auxiliary Channel 3 Adjustment

If a third channel is not required, proceed to Step 9.

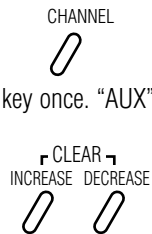

7. Press the *Channel* key once. "AUX" will appear on the screen.

8. Press the *Increase* or *Decrease* keys to select the desired travel value.

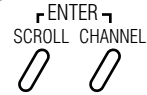

9. Press the *Scroll* and *Channel* keys at the same time to exit the function mode.

Direct Trim Access

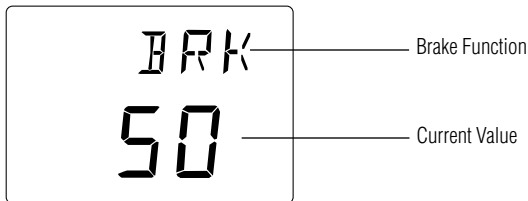
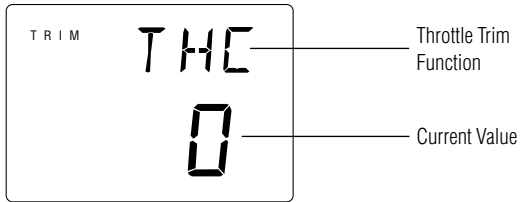
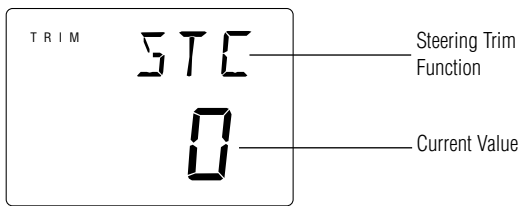

Servo Trim Adjustment

Steering

1. With the transmitter power switch on, move the digital steering trim lever in the desired position to be adjusted. The steering trim value screen will appear automatically.

Throttle

2. With the transmitter power switch on, move the digital throttle trim lever in the desired position to be adjusted. The throttle trim value screen will appear automatically.

Auxiliary Channel 3 (If Active)

3. With the transmitter power switch on, move the digital grip lever A in the desired position to be adjusted. The Auxiliary Channel 3 value screen will appear automatically.

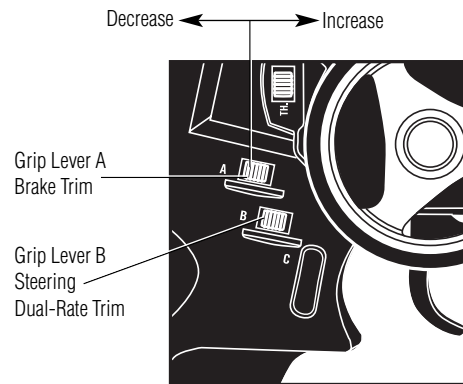
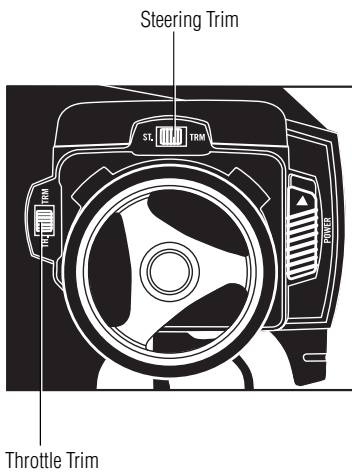

System Features

Transmitter

- 3 channels
- Synthesized PLL Channel Selection via software
- FM modulation
- Easy-to-read LCD graphics display
- 6-model memory
- 3-character model name entry
- Electronic digital trim levers for throttle and steering
- Two assignable electronic grip levers
- Auxiliary third channel accessible through Grip Lever A
- Direct display trim function
- Servo reversing
- Sub-trim
- Steering dual-rate
- Exponential (steering and throttle)
- Steering end-point adjustment (two points: left and right)
- Brake/throttle end-point adjustment
- Throttle deadband adjustment
- 50-lap timer
- Low-battery alarm
- Charge jack receptacle (rechargeable batteries not included; order JRPB958)

RS300 Receiver

- 3 channels
- Synthesized PLL Channel Selection
- FM modulation
- 27MHz/75MHz available
- Battery Eliminator Circuitry (BEC)
- Patented ABC&W interference technology

Z590M Servo

- Metal gears for durability
- Great high-torque car/buggy steering servo
- Indirect drive feedback potentiometer for additional vibration protection
- Surface Mount Technology (SMT)

Z270 Servo

- Low current drain
- Indirect drive feedback potentiometer for additional vibration protection
- Surface Mount Technology (SMT)
- Durable nylon gear train

System Specifications

Components

Transmitter	XS3
Receiver	RS300
Servos	Z590M x 1 Z270 x 1
Accessories	BEC switch harness with battery case, servo accessories (for each servo), instruction manual

XS3 Transmitter

Model number	XS3
Encoder	3-channel computer system
RF output	27MHz/75MHz synthesized
Modulation	FM
Output power	130 mW
Current Drain	180 mA
Power source	1.5V x 8 dry cell (1.2V x 8 Ni-Cd optional)
Output pulse	1000–2000 (1500 neutral)

RS300 Synthesized Receiver

Model number	RS300
Type	3-channel/FM ABC&W circuitry
Frequency	27MHz/75MHz
Sensitivity	5 qs minimum
Selectivity	8 KHz/50 dB
Weight	.9 ounces
Size (LxWxH)	1.75" x 1.25" x 0.63"
Receiver Antenna	20"
Power supply	4.8–6.0V DC
Channel selection	Rotary dial

Z270 Servo

Torque	49 ounce inch (@6.0V)
Speed	.19 sec/60° (@6.0V)
Weight	1.50 ounces
Size (WxLxH)	0.73" x 1.51" x 1.37"
Motor	3-pole ferrite
Gears	Nylon

Z590M Servo

Torque	85 ounce inch (@6.0V)
Speed	.15 sec/60° (@6.0V)
Weight	1.6 ounces
Size (WxLxH)	0.73" x 1.55" x 1.46"
Motor	3-pole ferrite
Gears	Metal

Control Identification and Location



*To remove battery cover, press down on the arrow and push the cover in the direction of the arrow. Remove the battery case and install 8 "AA" batteries in the direction shown as molded into the battery case. If transmitter voltage fails to register, check for correct battery installation and voltage.

RC Safety Precautions

1. Radio control models are not toys. They are capable of inflicting serious injury to people and property. Use caution at all times when operating your model.
2. You are responsible for the safe operation of your RC model. You must properly install, test and operate your model with a clear sense of that responsibility. Do not take risks that might endanger yourself or others.
3. Running an RC car in the streets is very dangerous to both drivers and models. Avoid running your model in areas occupied by full-size automobiles. To locate areas where you can safely operate your model, contact your local hobby shop for RC tracks or clubs in your area.
4. When running an RC boat, keep it away from any swimmers, full-size boats and wildlife. Also, watch carefully for fishing lines that may get tangled in the propeller.
5. Before operating your model, make sure your frequency is clear. If someone else is operating on the same frequency, both models will go out of control, possibly causing damage to the models, as well as others.
6. If at any time while operating your RC model you sense abnormal model functioning, end your operation immediately. Do not operate your model again until you are certain the problem has been corrected.

Caution: Control of your model is impossible without sufficient voltage for the transmitter and receiver. A weak transmitter battery will decrease your range of operation, and a weak receiver battery will slow servo movement and decrease your range of operation. Check your receiver pack voltage often to avoid losing control of your model. When using a model that operates both the electric motor and the receiver from the same battery (Battery Eliminating Circuitry or BEC), you should discontinue use when the top speed sharply decreases or you'll quickly lose control of your model. For safe and reliable performance of your RC model, please carefully read and follow the guidelines below.

Steering Tension Adjustment

Steering tension is adjustable via the recessed screw located beneath the steering wheel (see page 7 for exact location). Turning the screw clockwise increases the steering tension.

Charging Jack

Located on the left-hand side of the transmitter is the charging jack that accepts only JR wall chargers. Please do not attempt to use any other brand of wall charger, as it may be reverse polarity and can cause damage to your system. Only use the JR wall charger when the XS3 is equipped with Ni-Cd batteries (JRPB958, available separately).

JR TRANSMITTER CHARGE JACK POLARITY:



Charger Pigtail For Transmitter

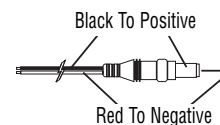

Receiver/Servo Connections and Installation

Your RS300 receiver is equipped with Battery Eliminator Circuitry (BEC). The receiver gets its power from the model's Ni-Cd battery pack, thus saving the weight of an additional receiver battery. Ni-Cd batteries from 4.8–8.4V (4–7 cells) can be used safely. Higher voltage packs may damage the receiver and servos.

Note: When using a separate receiver Ni-Cd as a power source, the operating voltage range is 4.8–6.0V (4- to 5-cell).

Attention: Make sure the male and female connectors have the correct polarity (+/-) before connecting. The servo lead and receiver case are molded so that the lead can only be inserted correctly. Be sure to orient the servo plug correctly for proper insertion.

You may use a separate receiver battery to power the receiver (such as for some electric boats or in gas-powered vehicles). A Ni-Cd pack plugged into the battery socket on your receiver will operate your receiver. You can also use alkaline batteries with the included battery box.

If you use a mechanical speed controller, please make sure it has the correct connector for a BEC system (red connector). See Figure A below for a typical setup. Most electronic speed controllers are set up for BEC operation and plug directly into your receiver (Figure B). See Figure B for a typical setup and check your speed controller's manual for correct installation.

Figure A – Connections to BEC receiver with mechanical speed controller. Ni-Cd battery and speed controller are not included in the radio set.

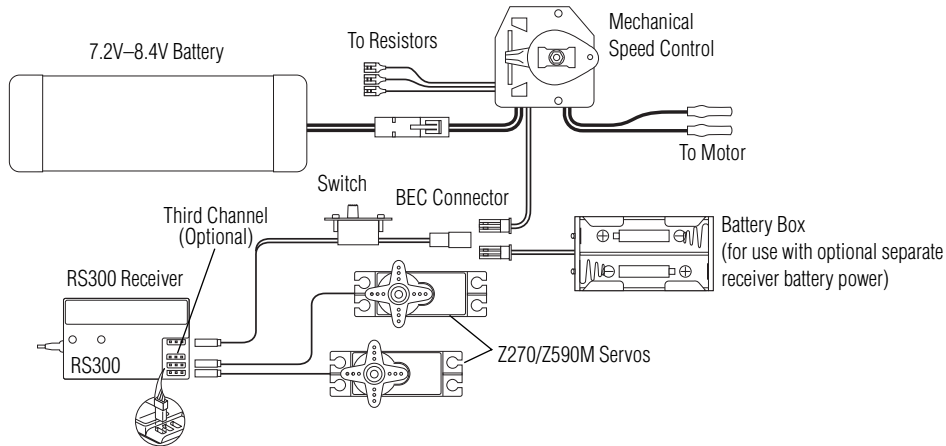
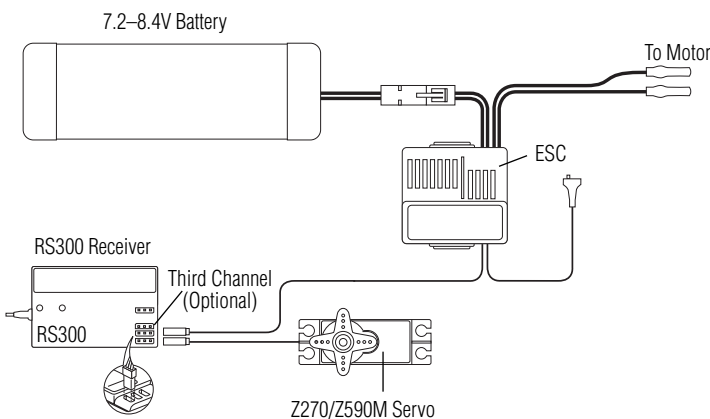
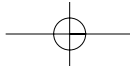

Figure B – Connections to BEC receiver with electronic speed controller. Ni-Cd battery and speed controller are not included in the radio set.





Receiver/Servo Connections and Installation

Your RS300 needs to be mounted so the receiver is isolated and floats to avoid damage from shock or vibration. Placement of the RS300's case should not come in direct contact with hard or rigid surfaces.

1. Mount the RS300 receiver with double-sided tape. (Use extra layers of double-sided tape, particularly if it is thin, until you build up a cushioning pillow layer.)

Do **not** use glue to mount the receiver!

2. Run the antenna wire up through a plastic antenna tube and let the excess wire hang out the top of the tube.
3. Do not cut, coil, or bundle excess antenna wire—range will be reduced!

Operating Your Model

It's important to learn the proper sequence for switching on/off your radio system.

Before Operation

Switch on the transmitter, then the receiver.

After Operation

Switch off the receiver, then the transmitter. This ensures that you will always have a signal to the receiver and that your RC model will not operate out of control when you turn off the transmitter.

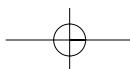
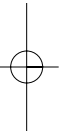
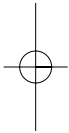

Servo Layout

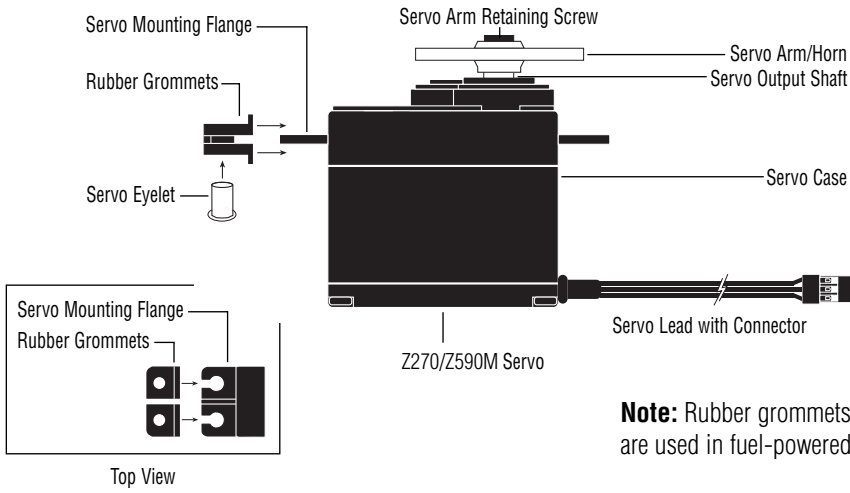

Note: Rubber grommets and (sometimes) eyelets are used in fuel-powered vehicles.

Key Input and Display

To enter the System mode, press the *Scroll* and *Channel* keys simultaneously and hold while turning on the transmitter.



To enter the Function mode, press the *Scroll* key while the transmitter is on.



Press the *Increase* and *Decrease* keys simultaneously to clear the screen or return to factory preset.

KEY	USE
SCROLL	Moves up through the available functions
CHANNEL	Selects the desired channel
INCREASE	Increases the value of the selected function
DECREASE	Decreases the value of the selected function

Display Screens

Normal Display

When the power switch is turned on, the LCD screen will display the channel selected for signal transmission and transmitter battery pack voltage as shown below. This screen is referred to as the Normal Display. Pressing the *Channel* key will switch the display between the transmitting channel and model name.

Note: If any of the electronic trim buttons are moved while in this screen, the screen will automatically change to display the trim in use. This is called the Direct Trim mode. For more information on the feature, please see page 29 of this manual.

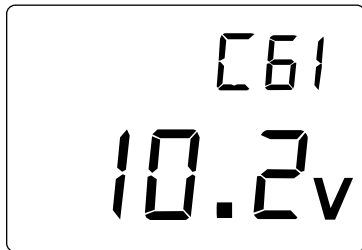

Low Battery/Lithium Battery Backup

When the voltage of the 8 "AA" batteries drops below 9.0V, the XS3's display screen will alternate between the Normal and Low-Battery screen (BAT), and a continuous beeping will occur, indicating that the batteries need to be replaced before further use. The Low-Battery screen is active during any operating modes.

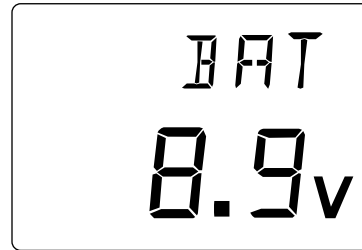

Lithium Battery

Your XS3 radio system is equipped with a five-year lithium battery backup system. This system is designed to protect and retain all radio programming in the event that the transmitter batteries drop below the required 9.0 volts, or the transmitter battery case is removed during battery changes. If after five years it becomes necessary to replace the lithium battery, return your system to the Horizon Service Center (see address, page 37) for repair.

Up-Timer

Note: If the Lap-Timer is enabled, an up-timer display may alternatively be selected over the normal display screen by pressing the *Channel* key. Pressing the *Channel* key again will scroll back through the channel select and model name screens. (For more information on this feature, please see page 26.)



Memory Backup

If the Memory Backup screen appears, this indicates the possibility of a ROM problem or the lithium battery is dead. If you switch the power off and on again, but the transmitter is in the default mode with all data lost, it is strongly suggested that the XS3 transmitter be returned to the Horizon Service Center for servicing (see Warranty Information, page 37).



System Mode

Accessing System Mode

To enter the System mode, press the *Scroll* and *Channel* keys simultaneously while turning on the transmitter power switch. By pressing the *Scroll* key, you can now choose Model Select, Channel Select, Model Name Input, Frame Rate, Auxiliary Channel 3 function, Grip button C function, Data Reset or the Model Copy function. Information for each function is located on the page number listed next to the function name on the flow chart.

To exit the System mode, press the *Scroll* and *Channel* keys simultaneously or simply turn off the transmitter.

Note: If you turn the transmitter off and immediately enter System mode again, you will be returned to the last System mode function used instead of the Model Select function. While in System mode, there is no RF output generated by the transmitter. Adjustments can be performed with reduced battery power consumption. If you exit System mode by pressing the *Scroll* and *Channel* key at the same time, RF output will not be enabled until you first turn off the transmitter.

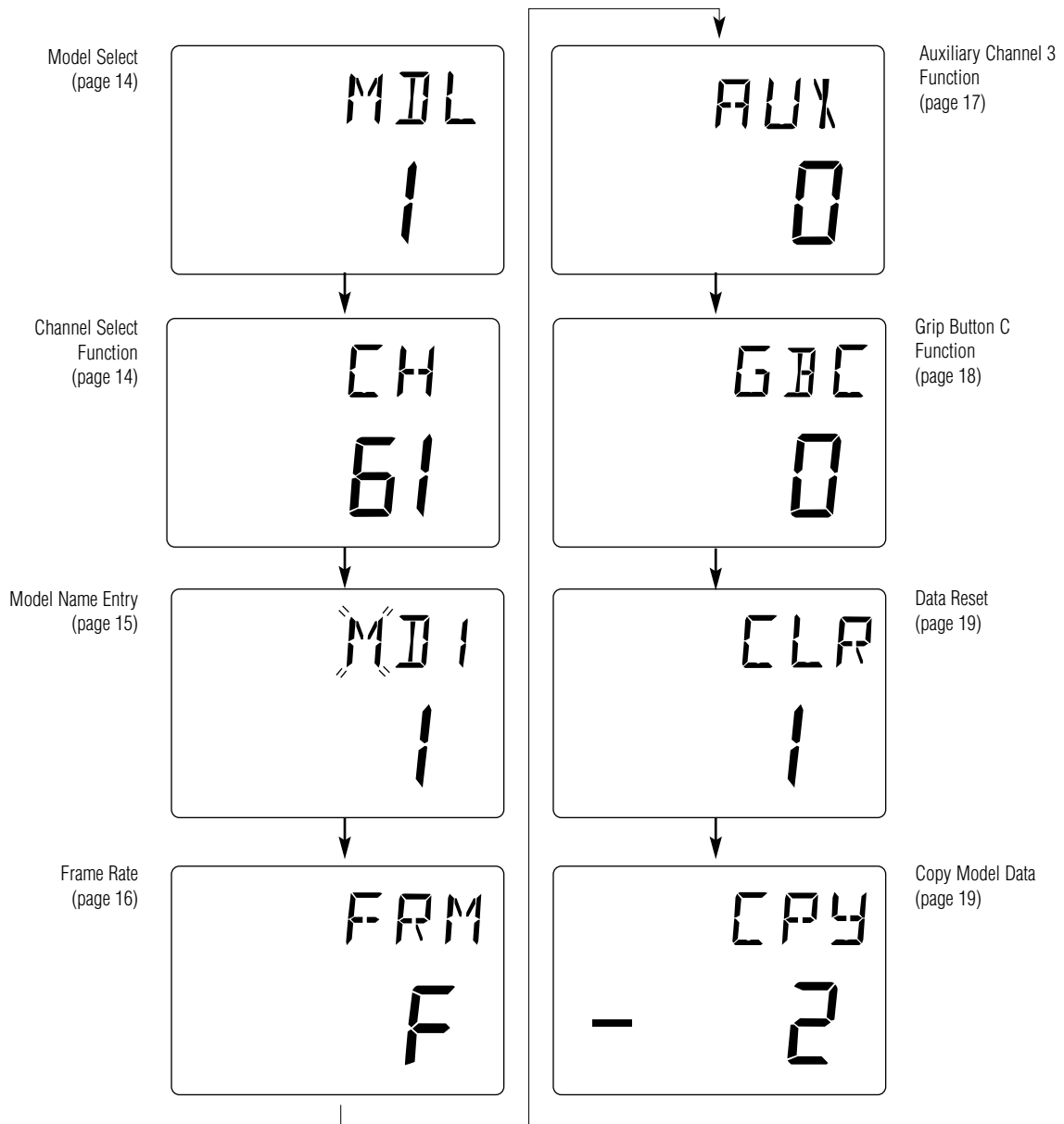

System Mode

Model Select

The XS3 has memory for six models. This feature allows for six different models to be operated with the same transmitter (additional receivers and servos must be purchased separately) or one model with six different race setups.

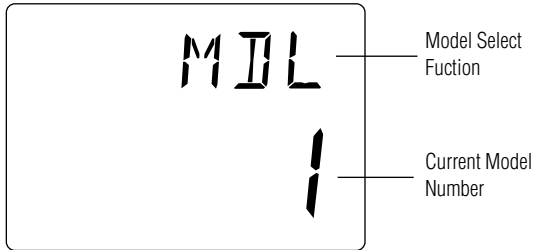

Accessing the Model Select Function

 Press and hold the *Scroll* and *Channel* keys at the same time while turning transmitter power switch on.

 Press the *Increase* or *Decrease* keys to select the desired model to be used (1, 2, 3, 4, 5 or 6).

1. Press the *Scroll* and *Channel* keys at the same time and hold.
2. Turn the transmitter power switch on to enter System mode.
3. If "MDL" does not appear on the screen, press the *Scroll* key until "MDL" appears.
4. Press the *Increase* or *Decrease* keys to select the desired model number (1, 2, 3, 4, 5 or 6).
5. Press the *Scroll* key to access the Channel Select function.
6. To exit System mode, either turn the transmitter power switch off or press the *Scroll* and *Channel* keys at the same time.

Synthesized Channel Select

One of the XS3 transmitter's most valued features is its ability to synthesize the frequency needed for operation on a single select channel without the need for replacing a crystal. Depending on the operating frequency band of your transmitter, the XS3 will either have 6 channels (1–6) on the 27MHz band or 30 channels (61–90) on the 75MHz band you can select from. (Please refer to the Frequency Chart on page 36 if you need to reference the exact frequency a particular channel is transmitting on.) When used in conjunction with the RS300 synthesized FM receiver, you will have access to virtually all available channels without needing to purchase any crystal sets!

Note: Your XS3 radio system will only operate either on 27MHz or 75MHz, not both. While in System mode, there is no RF output being generated by the XS3 enabling you to safely make the appropriate channel selection. You must turn the transmitter off and then back on to enable RF output.

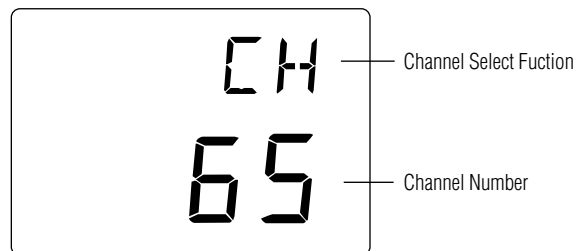

System Mode

Synthesized Channel Select cont.

Accessing the TX Channel Select Function



Press and hold the *Scroll* and *Channel* keys at the same time while turning transmitter power switch on. Next, press the *Scroll* key until "CH" appears.

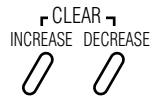

Press the *Increase* or *Decrease* key to select the desired channel for transmission.

1. Press the *Scroll* and *Channel* keys at the same time and hold.
2. Turn the transmitter power switch on to enter System mode.
3. Press the *Scroll* key until "CH" appears on the screen.
4. Press the *Increase* or *Decrease* key to select the desired channel number 1–6 (27MHz) or 61–90 (75MHz).
5. Press the *Scroll* key to access the Model Name Entry function.
6. To exit System mode, either turn the transmitter power switch off or press the *Scroll* and *Channel* keys at the same time.

Accessing the RS300 RX Channel Select

Determine the frequency band and channels available marked next to the rotary dial matches the transmitter. Set the channel on the RS300 receiver to match the XS3 transmitter by adjusting the ten position rotary switches using a small 1/8" flat blade screwdriver until they point to the corresponding channel numbers.

- To set a 75MHz receiver to channel 78, rotate the first rotary switch to the "7" position and the second rotary switch to the "8" position.
- 27MHz receivers will only have one rotary switch for accessing channels 1–6. Use this single switch to select the desired channel.

Model Name Entry

The XS3 allows a three-character name to be input for each of the six models available. The current model with name will then be displayed in the Normal display screen. This feature is useful to help identify different models, setups, etc.

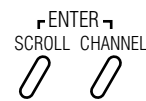
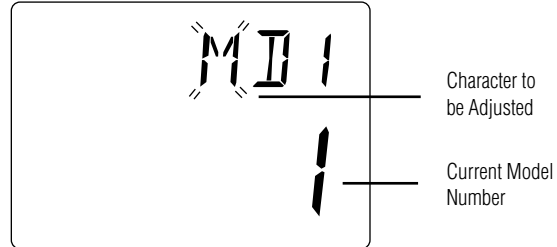

Press and hold the *Scroll* and *Channel* keys at the same time while turning transmitter power switch on. Next, press the *Scroll* key until the flashing "M" appears. Press the *Channel* key to select the character to be changed.

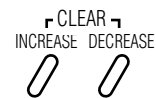

Press the *Increase* or *Decrease* keys to select the correct letter/number to be used.

Accessing the Model Name Entry Function

1. Press the *Scroll* and *Channel* keys at the same time and hold.
2. Turn on the transmitter power switch to enter the System mode.
3. Press the *Scroll* key until "MD1" appears on the screen with the first character flashing.
4. Press the *Increase* or *Decrease* keys to select the correct letter/number for the first character (flashing). To clear the character, pressing the *Increase* and *Decrease* keys at the same time.
5. To change the remaining two characters, press the *Channel* key until the desired character to be changed is flashing.
6. Press the *Scroll* key to access the Frame Rate function.
7. To exit the System mode, either turn the transmitter power switch off or press the *Scroll* and *Channel* keys at the same time.

System Mode

Frame Rate Select

The Frame Rate function allows you to select one of two transmitter frame rates available: Normal "N" - the default or Fast "F". The Normal Frame Rate should be selected if you are using only non-digital servos. The Fast Frame Rate may be selected if you are using at least one digital servo.

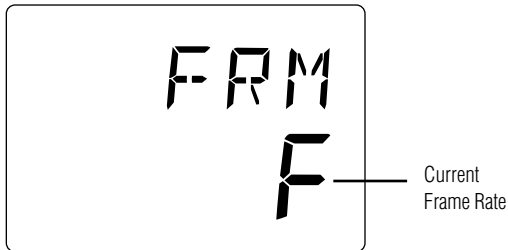

Note: The Frame Rate function offers quicker response times in the "F" or Fast mode. Some types of non-JR servos are not compatible in the "F" Fast mode and require the radio to be operated in the "N" Normal mode.

Accessing the Frame Rate Function



Press and hold the *Scroll* and *Channel* keys at the same time while turning the transmitter power switch on. Next, press the *Scroll* key until "FRM" appears.



Press the *Increase* or *Decrease* key to select the desired frame rate.

1. Press the *Scroll* and *Channel* keys at the same time and hold.
2. Turn on the transmitter power switch to enter the System mode.
3. Press the *Scroll* key until "FRM" appears on the screen.
4. Press the *Increase* or *Decrease* key to select the desired frame rate (N or F).
5. Press the *Scroll* key to access the Auxiliary Channel 3 function.
6. To exit the System mode, either turn the transmitter power switch off or press the *Scroll* and *Channel* keys at the same time.

System Mode

Auxiliary Channel 3 Function Select

The Auxiliary Channel 3 function of the XS3 allows you to select from two different types of Channel 3 servo travel movements or to inhibit the Auxiliary Channel 3 function. Use the information below to select the correct Auxiliary Channel 3 function type for your particular installation. It is suggested the 0 function be selected for most applications.

(Factory preset)

0 = The 0 or Inhibit function allows the Brake End-Point Adjustment function to be used. This function is designed to be used with most types of electric and gas-powered RC cars. This feature is extremely popular, as it allows the amount of panic braking accessible through the throttle trigger's braking position to be adjusted during operations for maximum effectiveness. When activated, the braking values will be visible via the Direct Trim function, page 29.

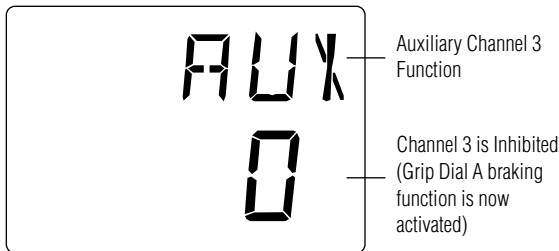

LN = The LN or linear servo travel function is designed to be used when an engine fuel mixture servo is required. This function is most commonly used with gas-powered RC racing boats and is accessible through Grip Dial A. In this function, the maximum travel of the servo is determined by the End-Point Adjustment function. The servo neutral position can be altered proportionally via the Grip Dial A for mixture adjustment. When activated, fuel mixture trim values are visible for the Direct Trim function, page 32.

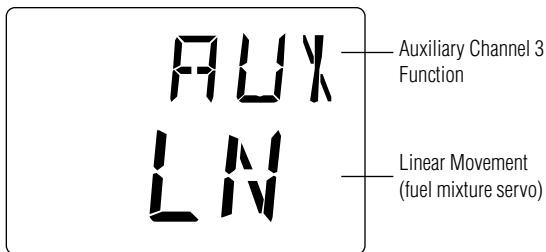

2P = The 2P or 2 position Servo Travel function is designed to be used as a transmission gear shift channel. This feature is designed for use with vehicles such as the Traxxas® T-Maxx. This function is accessible through Grip Button C or Grip Dial A if Grip Button C is occupied by another function. In this function, the servo's travel values are determined by the End-Point Adjustment function.

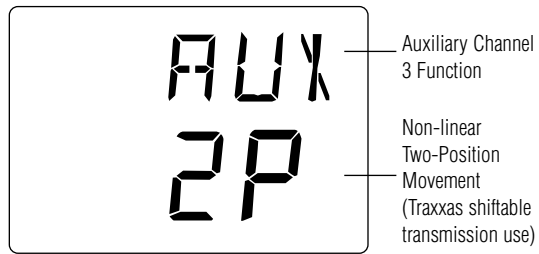

Accessing the Auxiliary Channel 3 Function

ENTER
SCROLL CHANNEL

Press and hold the *Scroll* and *Channel* keys at the same time to enter the System mode. Next Press the *Scroll* key until "AUX" appears.

CLEAR
INCREASE DECREASE

Press the *Increase* or *Decrease* key to select the desired Auxiliary channel 3 function type to be used.

0 = Inhibited (Grip Dial A braking is active)
LN = Linear servo movement
2P = 2-position servo movement

1. Press the *Scroll* and *Channel* keys at the same time and hold.
2. Turn on the transmitter power switch to enter System mode.
3. Press the *Scroll* key until "AUX" appears on the screen.
4. Press the *Increase* or *Decrease* key to select the correct Auxiliary Channel 3 function type to be used.
5. Press the *Scroll* key to access the Grip Button C Select function.
6. To exit the System mode, either turn the transmitter power switch off or press the *Scroll* and *Channel* keys at the same time.

System Mode

Grip Button C Function Select

The Grip Button C function of the XS3 allows you to select from 3 different functions available. Use the information below to select the correct Grip Button C assignment for your particular installation.

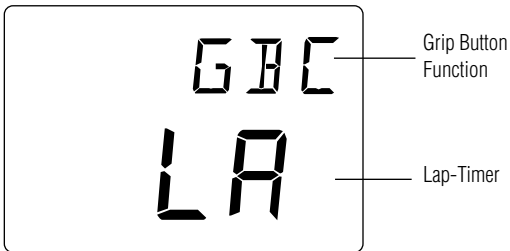

"0": Off. (Default) If "AUX" is "2P", then "2P" replaces "0" in this screen.
 "Eb": ESB (Emergency Steering Button.) To cancel the "STG" regulation for panic steering.
 "LA": Lap timer.

Note: If "LA" or "Eb" is selected and "2P" is assigned to the Auxiliary Channel 3 function, the Auxiliary Channel 3 function is moved to Grip Dial A.

(Factory preset)

0 = The 0, or off function, is the default setting and does not assign a function to Grip Button C. If the Auxiliary Channel 3 function is set to "2P" or 2-position, "2P" will appear in this screen in place of "0" and Grip Button C will function as the gear select button.

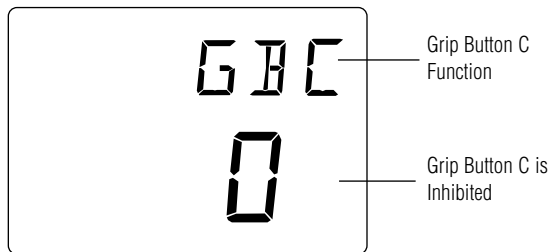

Eb = The Eb or Emergency Steering Button function is designed to override the value of Grip Dial B and provide 100% steering rate. This feature is useful if you have reduced the steering rate to make your vehicle easier to drive but need full steering in an emergency situation such as a collision.

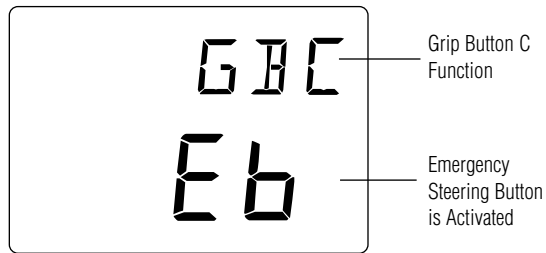

LA = The LA or Lap-Timer function is designed to be used when you want to enable the recording of individual lap time. The Lap-Timer function is described on page 26.

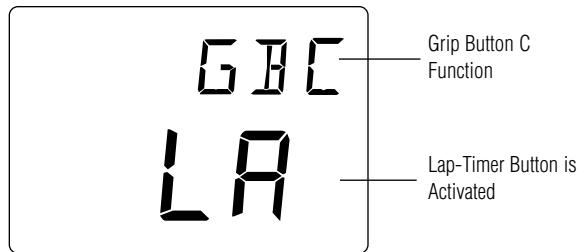

Accessing the Grip Button C Function

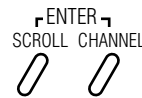

Press and hold the *Scroll* and *Channel* keys at the same time to enter the System Mode. Next Press the *Scroll* key until "GBC" appears.

0 = Inhibited
 Eb = Emergency Steering Button
 LA = Lap-Timer

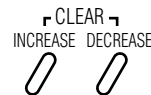

Press the *Increase* or *Decrease* key to select the desired Grip Button C function type to be used.

1. Press the *Scroll* and *Channel* keys at the same time and hold.
2. Turn on the transmitter power switch to enter System mode.
3. Press the *Scroll* key until "GBC" appears on the screen.
4. Press the *Increase* or *Decrease* key to select the correct Grip Button C function type to be used.
5. Press the *Scroll* key to access the Data Reset function.
6. To exit the System mode, either turn the transmitter power switch off or press the *Scroll* and *Channel* keys at the same time.

System Mode

Data Reset

The Data Reset function allows you to reset all the programming in the selected model (1, 2, 3, 4, 5 or 6) to the factory default settings. Before using the Data Reset function, it is important to enter the Model Select function and check to make sure the current model number indicated (1, 2, 3, 4, 5 or 6) is the model to which you want to reset to the factory default settings. The Model Select function is described on page 14.



Model to be Reset

Accessing the Data Reset Function



Press and hold the *Scroll* and *Channel* keys at the same time while turning the transmitter power switch on. Next, press the *Scroll* key until "CLR" appears.

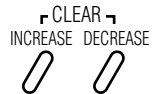

Press the *Increase* and *Decrease* keys at the same time to reset (clear) all settings for the selected model to the factory default settings.

1. Press the *Scroll* and *Channel* keys at the same time and hold.
2. Turn on the transmitter power switch to enter the System mode.
3. Press the *Scroll* key until "CLR" appears on the screen.
4. Press the *Increase* and *Decrease* keys at the same time to reset the data. To confirm that the selected model's programming has been reset, a beep will sound and the model number selected (1, 2, 3, 4, 5 or 6) will stop flashing.
5. Press the *Scroll* key to access the Copy Model Data function.
6. To exit the System mode, either turn the transmitter power switch off or press the *Scroll* and *Channel* keys at the same time.

Copy Model Data

Copy Model Data function allows you to copy the current model data into the model memory of the blinking model selected. Before using the Copy Model Data function, be sure you know what model number you want to copy the data to as all data in this selected model will be lost. If the current model being copied from uses the default name, the model name from the model being copied to will be retained.

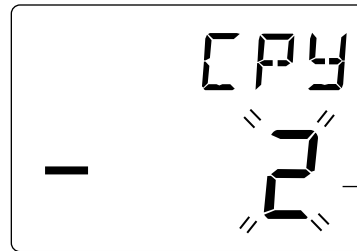

Model being copied to

Accessing the Copy Model Data Function

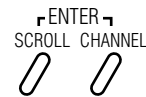

Press and hold the *Scroll* and *Channel* keys at the same time while turning the transmitter power switch on. Next, press the *Scroll* key until "CPY" appears.

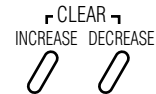

Press the *Increase* and *Decrease* keys at the same time to copy model data from the current model to the selected model.

1. Press the *Scroll* and *Channel* keys at the same time and hold.
2. Turn on the transmitter power switch to enter the System mode.
3. Press the *Scroll* key until "CPY" appears on the screen.
4. Press the *Increase* or *Decrease* key to select the desired model number you want the current model data copied to. This model number being select should be blinking.
5. Press the *Increase* and *Decrease* keys at the same time to copy the current model data into the selected model number. To confirm that the selected model has been copied to, a beep will sound and the model number selected (1, 2, 3, 4, 5 or 6) will stop flashing.
6. To exit the System mode, either turn the transmitter power switch off or press the *Scroll* and *Channel* keys at the same time.

Function Mode

Accessing the Function Mode

To enter the Function mode, turn on the transmitter. Press the *Scroll* key until a beep is heard. The display will change to show the first function listed on the Function Mode Flow Chart. Scroll down through the functions one by one. Once the desired function has been reached, use the *Channel*

key to select the appropriate channel (if applicable). To adjust the values of the function, press the *Increase (+)* or *Decrease (-)* keys until the desired value is displayed. To exit function mode, press the *Scroll* and *Channel* keys simultaneously. The next time you enter Function mode, you will be returned to the last function accessed.

Mode Key

Channel Key

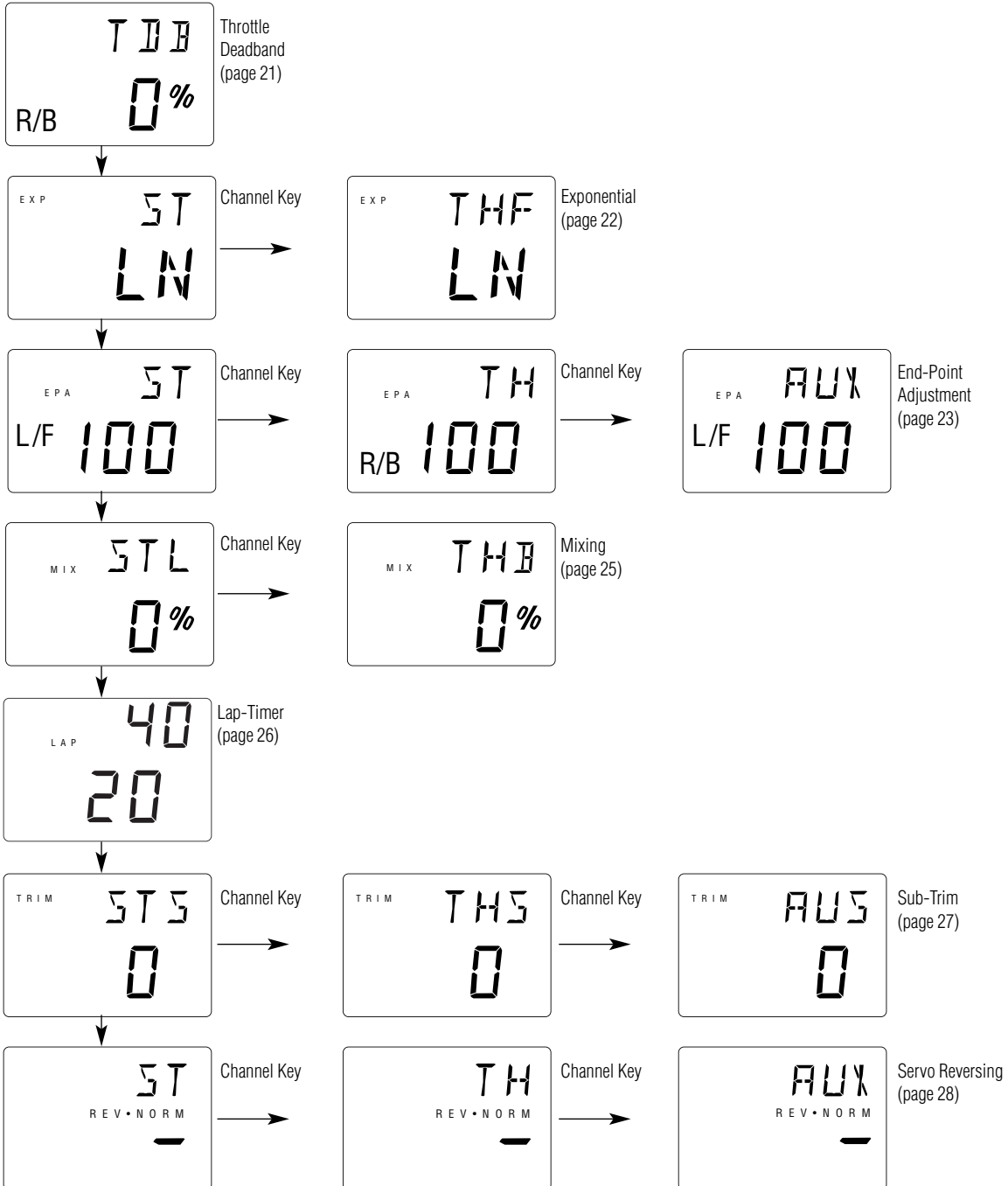

Function Mode

Throttle Deadband

The throttle deadband feature is used to reduce/eliminate the dead throttle area that exists at neutral to the starting point of throttle and from neutral to the starting point of braking. This area is sometime known as deadband. As more throttle trim (also known as static brake) is applied, more of the dead trigger area right off neutral exists. To eliminate the throttle deadband, adjust a forward value such that your vehicle's wheels just start to turn when the trigger is slightly squeezed. This provides the most accurate feel and eliminates the dead area in the throttle. To eliminate the braking deadband, adjust the brake value such that your vehicle starts to slow down when the trigger is slightly pushed. This provides the most accurate brake feel and eliminates the dead area when braking.

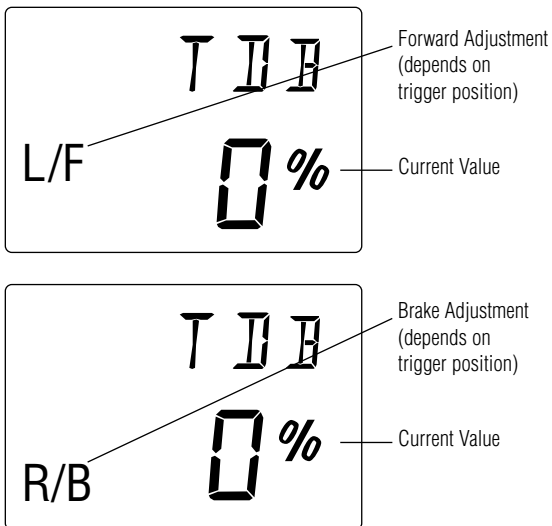

Values: 0% to 100%
Clear = 0%

Accessing the Throttle Deadband Function

ENTER
SCROLL CHANNEL Press the *Scroll* key until "TDB" appears on the screen.

CLEAR
INCREASE DECREASE Press the *Increase* or *Decrease* key to select the desired value necessary.

1. Turn the transmitter power switch on.
2. Press the *Scroll* key to access Function mode.
3. Press the *Scroll* key until "TDB" appears on the screen
4. Move the trigger accordingly to adjust the forward or braking deadband.
5. Press the *Increase* or *Decrease* key to select the desired value necessary to eliminate dead area.
6. Press the *Scroll* key to access the Exponential function.
7. To exit the Function mode, either turn off the transmitter power switch or press the *Scroll* and *Channel* keys at the same time.

Function Mode

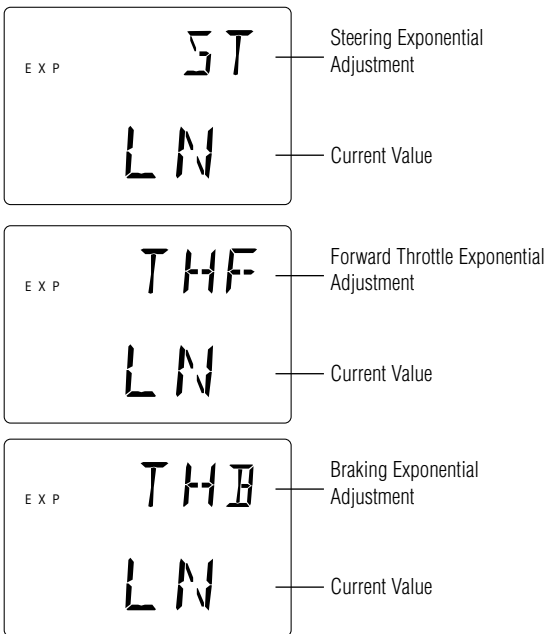

Exponential Function

The Exponential feature of the XS3 allows you to alter the response rate of the steering or throttle control around neutral without affecting the maximum amount of steering or throttle available. The adjustment range is from -100% to 0% (Linear) to +100%. Exponential is factory set to linear for both steering and throttle. Exponential is often used to settle down a car that is twitchy around center without giving up maximum steering response. The XS3 provides both positive (increase sensitivity at neutral) and negative (decrease sensitivity at neutral) exponential values.

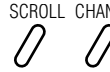

Accessing the Exponential Function

  Press the *Scroll* key until "EXP" appears on the screen.

  Press the *Increase* and *Decrease* keys to select the desired exponential value. Values: -100% to Linear (LN) to +100%.

1. Turn the transmitter power switch on.
2. Press the *Scroll* key to access the Function mode.
3. Press the *Scroll* key until "EXP" appears in small letters on the left side of the screen.
4. Press the *Increase* or *Decrease* keys to select the desired exponential value.
5. Press the *Scroll* key to access the travel End-Point Adjustment function.
6. To exit the Function mode, either turn off the transmitter power switch or press the *Scroll* and *Channel* keys at the same time.

Function Mode

End-Point Adjustment

The End-Point Adjustment feature of the XS3 allows the maximum travel of both the steering, throttle and Auxiliary Channel 3 (optional) servos to be increased or decreased in each direction to achieve the exact servo movement needed. The End-Point Adjustment range is from 0% to 125% and is factory set to 100% for both channels. The value displayed on the screen depends on the current position of the steering wheel, trigger, or trim lever to be adjusted. This feature is very useful either to maximize servo travel or to reduce servo over-travel to eliminate servo binding (servo moves further than control mechanism allows), without the need for mechanical linkage adjustment.

The screens below are accessed by turning the wheel to the desired direction to be adjusted (left or right), by moving the trigger to the forward or backward (brake) position, or by moving the Grip Lever A to the forward or back positions.

Steering Left End-Point Adjustment

Current Value
Values: 0 to 125
Clear = 100

Steering Right End-Point Adjustment

Current Value
Values: 0 to 125
Clear = 100

Forward Throttle End-Point Adjustment

Current Value
Values: 0 to 125
Clear = 100

Backward Throttle (Brake) End-Point Adjustment

Current Value
Values: 0 to 125
Clear = 100

Channel 3 Screens (Optional)

Functions **LN** & **2P**

Left/Right Travel Adjustment (function LN) or Forward Travel Adjustment (function 2P) accessible through Grip Button C

Current Value
Values: 0 to 190
Clear = 100

Functions **2P** only

Rearward Travel Adjustment (function 2P) accessible through Grip Button C

Current Value
Values: 0 to 190
Clear = 100

Function Mode

Accessing The End-Point Adjustment Function

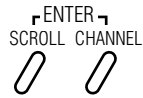

Press the *Scroll* key until "EPA" appears on the screen. Press the *Channel* key to select the channel to be adjusted.



Move the wheel, trigger or Grip Button C in the desired direction and press either the *Increase* or *Decrease* keys to achieve the desired travel value.

1. Turn on the transmitter power switch.
2. Press the *Scroll* key to enter Function mode.
3. Press the *Scroll* key until "EPA" appears in small letters on the left side of the screen.
4. Press the *Channel* key to select the desired channel to be adjusted.

Steering = ST R/B (steering right) or ST L/F (steering left)

Throttle = TH L/F (forward) or TH R/B
(braking or reverse)

Auxiliary Channel 3 (optional) = AUX L/F or AUX R/B
(function 2P only)

5. Move the steering wheel, trigger or Grip Button C in the desired direction for adjustment (left/right, forward/reverse or brake). Press the *Increase* or *Decrease* key to achieve the desired amount of travel. Move the wheel, trigger or Grip Button C in the opposite direction to adjust the travel in the opposite direction.

Note: For Auxiliary Channel 3 function, if LN is selected, only L/F is adjustable.

6. Press the *Scroll* key to access the Mixing Adjustment function.
7. To exit the Function mode, either turn off the transmitter power switch or press the *Scroll* and *Channel* keys at the same time.

Note: When setting the end point adjustment values for the steering function, it is suggested that, if possible, the maximum travel values be set to an equal value in both directions to maintain proper steering control.

Function Mode

Programmable Mixing

The XS3 offers two different mixing adjustments that allows for mixing one channel to another channel. The mixes available are Steering-to-Auxiliary Channel Mixing and Throttle-to-Auxiliary Channel Mixing. Each direction is independently adjustable. Popular use of this function includes 4-wheel steering and independent front and rear wheel brakes.



Steering-to-Auxiliary
Channel Mixing
Adjustment

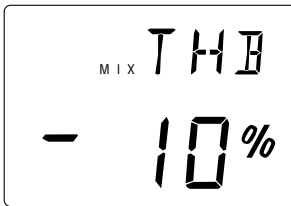

Throttle-to-Auxiliary
Channel Mixing
Adjustment

For example, Throttle-to-Auxiliary channel mixing can be used for independent front and rear wheel brakes. Each time the throttle/brakes is moved, the auxiliary channel will move in the direction and to the value input being given by the throttle channel. Mixing is proportional, so small inputs to the throttle will result in small output from the auxiliary channel. The adjustment range is from -125% to 0% to 125%. If the rate is negative, the channel is mixed in the opposite direction.

Both mixes share a single mixing "offset." The purpose of the mixing offset is to redefine the neutral position of the auxiliary channel, which can be set using Grip Lever A when "LN" is selected in the Auxiliary Channel 3 function. If the "LN" selection is turned off in the Auxiliary Channel 3 function with a offset value currently present, the value will continue to act as a mixing offset until the value is either cleared or changed. If a mix is not required, it is strongly suggested the mixing rate be set for 0%, which is the default.

Accessing The Mixing Adjustment Function

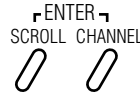

Press the *Scroll* key until "MIX" appears on the screen. Press the *Channel* key to select the desired mix.



Move the wheel or trigger in the desired direction and press either the *Increase* or *Decrease* keys to achieve the desired mixing value.

1. Turn on the transmitter power switch.
 2. Press the *Scroll* key to enter Function mode.
 3. Press the *Scroll* key until "MIX" appears in the screen.
 4. Press the *Channel* key to select the desired mix to be used.
- STL or STL = Steering-to-Auxiliary Channel 3 Mixing.
THF or THB = Throttle-to-Auxiliary Channel 3 Mixing.
5. Move the steering wheel or trigger in the desired direction for adjustment (left/right, forward/reverse or brake). Press the *Increase* or *Decrease* key to achieve the desired amount of mixing. Move the wheel or trigger in the opposite direction to adjust the mixing in the opposite direction.
 6. Press the *Scroll* key to access the Lap-Timer function (if enabled) or Sub-Trim function.
 7. To exit the Function mode, either turn off the transmitter power switch or press the *Scroll* and *Channel* keys at the same time.

Function Mode

Lap-Timer

The Lap-Timer function of the XS3 allows the recording of individual lap times based on a 999 second up-timer. Up to 50 laps and times from 3.0 to 99.9 seconds can be stored in memory for review at a later time. The Lap-Timer function will only be enabled and shown in Function mode if Grip Button C (System Mode) is set to "LA." With the Lap-Timer enabled, pressing the channel key will alternate between the Normal display screen and Up-Timer display screen.

The Lap-Timer is started by pressing Grip Button C. Once active, as shown by the blinking word "LAP," pressing Grip Button C again will begin recording the time of the next lap.

Note: A 3.0 second lap is the quickest lap allowed. This prevents accidental double pushing of Grip Button C when recording lap times. If more than 50 laps are recorded, each new lap will overwrite the oldest lap held in memory.)

To stop the Lap-Timer, press the *Increase* and *Decrease* keys at the same time. To restart the Lap-Timer, press Grip Button C. To reset the Up-Timer, press the *Channel* key to show the Up-Timer display screen. With the Up-Timer stopped, press the *Increase* and *Decrease* keys at the same time to reset.

To review or reset lap times you must be in the Lap-Timer function mode screen. Upon entering this function, the screen will always show the last lap time recorded. Use the *Increase* or *Decrease* keys to view the desired lap(s).

Note: If a recorded lap time is greater than 99.9 seconds, "OVR" will be displayed.)

To reset all lap times, press the *Increase* and *Decrease* keys at the same time.

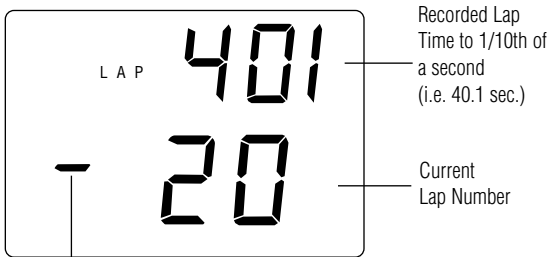

A minus sign indicates a pre-existing lap. Current lap times have no sign.

Accessing The Lap-Timer Function

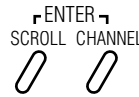
 Press the *Scroll* key until "LAP" appears on the screen.

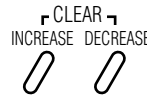
 Press the *Increase* or *Decrease* keys to view the desired lap time(s).

1. Turn on the transmitter power switch.
2. Press the *Scroll* key to enter Function mode.
3. Press the *Scroll* key until "LAP" appears in the screen.
4. Press the *Increase* or *Decrease* keys to view the desired lap time(s).
5. To reset all lap times press the *Increase* and *Decrease* keys at the same time.
6. Press the *Scroll* key to access the Sub-Trim function.
7. To exit the Function mode, either turn off the transmitter power switch or press the *Scroll* and *Channel* keys at the same time.

Function Mode

Sub-Trim

The Sub-Trim function of the XS3 is an electronic trimming feature that allows the neutral position of the servo on either the steering, throttle or auxiliary channel (optional) to be moved, while allowing the electronic trim lever for that channel to remain in the center position. This feature is very useful as it allows the servo arm/wheel position to be moved to help with control linkage installation, eliminating the need to make mechanical linkage adjustments.

Although the Sub-Trim function is a very useful feature, it is suggested that only small amounts of sub-trim be used so that no unwanted, non-equal servo travel is created. It is suggested that less than 30 points of Sub-Trim be used during adjustment. If more than 30 points of Sub-Trim are required, it is suggested that a mechanical linkage adjustment be performed.

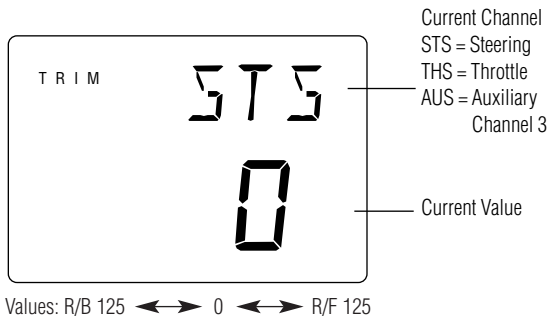

Accessing the Sub-Trim Function

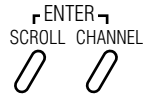

Press the *Scroll* key until "TRIM" appears on the screen. Press the *Channel* key to select the desired channel to be adjusted.

STS = Steering
 THS = Throttle
 AUS = Auxiliary Channel 3

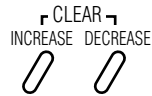

Press the *Increase* or *Decrease* keys to achieve the desired Sub-Trim Value.

1. Turn on the transmitter power switch.
2. Press the *Scroll* key to enter Function mode.
3. Press the *Scroll* key until "TRIM" appears in small letters to the left of the screen.
4. Press the *Channel* key to select the channel to be adjusted (Steering, Throttle or Auxiliary Channel 3).
5. Press the *Increase* or *Decrease* keys until the proper servo position is achieved.
6. Press the *Scroll* key to access the Servo Reversing function.
7. To exit the Function mode, either turn off the transmitter power switch or press the *Scroll* and *Channel* keys at the same time.

Function Mode

Servo Reversing

The Servo Reversing feature of the XS3 is a very convenient feature when setting up a new model. The purpose of the servo reversing function is to change the direction of the servo rotation in relation to the wheel/trigger movement. The Servo Reversing function is available for the steering, throttle and Auxiliary Channel 3 of the XS3.

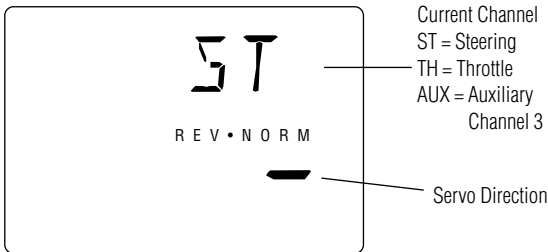

1. Turn the transmitter power switch on.
2. Press the *Scroll* key to access Function Mode.
3. Press the *Scroll* key until "REV:NORM" appears in small letters to the right of the screen.
4. Press the *Channel* key to select the channel to be changed (ST = Steering, TH = Throttle, AUX = Auxiliary Channel 3).
5. Press the *Increase or Decrease* keys to move the cursor to the desired direction.
6. To exit the Function mode, either turn off the transmitter power switch or press the *Scroll* and *Channel* keys at the same time.

Accessing the Servo Reversing Function



Press the *Mode* key until "REV. NORM" appears on the screen. Press the *Channel* key to select the desired channel to be adjusted.

STS = Steering
THS = Throttle
AUX = Auxiliary Channel 3

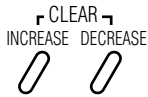

Press the *Increase or Decrease* keys to move the cursor to the desired servo direction.

Accessing the Direct Trim Mode

The Direct Mode function of the XS3 is accessible through the use of the electronic throttle or steering trim levers, as well as the two electronic grip levers (A&B) located on the upper portion of the grip handle. This function allows for quick trim adjustment of these controls.

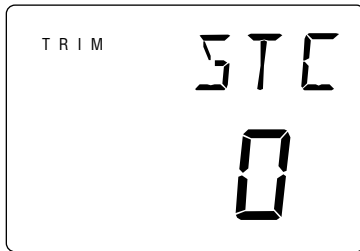

Steering Trim
(page 30)

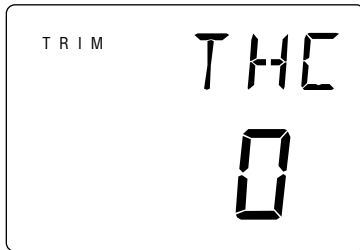

Throttle Trim
(page 30)

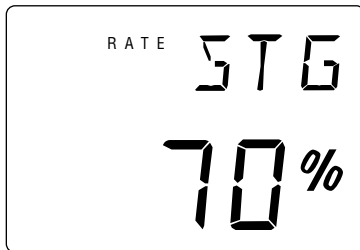

Steering Dual-Rate
(Grip Lever B)
(page 31)

To access the Direct Trim Mode function, turn on the transmitter power switch. Next, move the desired trim lever to be adjusted. The appropriate screen for the selected trim lever will be displayed. To adjust, simply move the trim lever in the desired direction until the correct amount of trim is achieved. Once the desired trim is achieved, the screen will return to the Normal display screen after approximately two seconds from the last trim input. If the *Increase* or *Decrease* keys are pressed any time during the two seconds, the system will return to the previous screen in use.

Only present when Aux. function "0" is selected

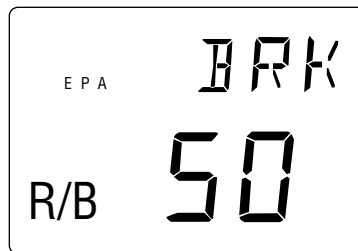

Brake Travel Adjustment
(Grip Lever A), (page 32)
(Only visible when the Auxiliary Channel 3 function "0" has been selected.) Refer to Auxiliary Channel 3 function, page 17, for clarification.

*

Only present when Auxiliary function "LN" is selected

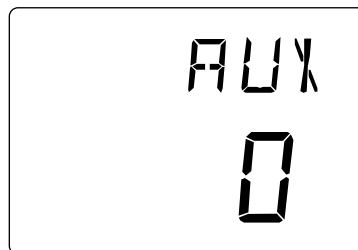

Auxiliary Channel 3
Trim Adjustment
(LN mode only)
Refer to Auxiliary
Channel 3 function,
page 32, for
clarification.

*

***Note:** When Auxiliary Channel 3 function 2P is selected, the two screens above are not present.

Steering Trim

The XS3 electronic Steering Trim lever, located above the steering wheel, allows the center position of the servo to move in either direction. Steering travel end-point adjustment values remain completely independent from the steering trim, unless the trim value exceeds the selected end-point values. (For example, if trim values are set at 30 and end-point values at 15, steering trim will over-ride/alter the end-point value.) Each click will provide 0.3° of trim to the center of the steering servo with a maximum of 12° allowed.

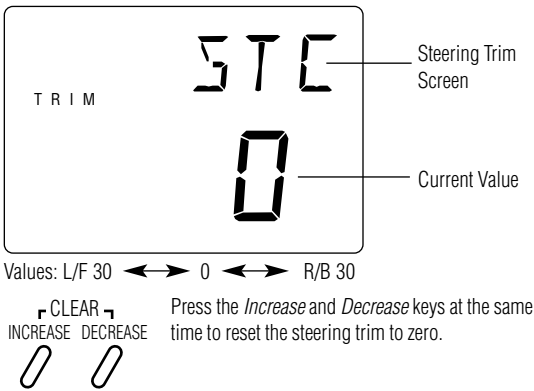

Note: Each click will not always result in a change of the value displayed.

To adjust the steering trim servo position, move the electronic Steering Trim lever left or right. As soon as the trim is moved, the “STC” Steering Trim screen will be displayed unless the trim lever is untouched for two seconds. To reset the trim value to 0, press the *Increase* and *Decrease* keys at the same time while the “STC” screen is displayed.

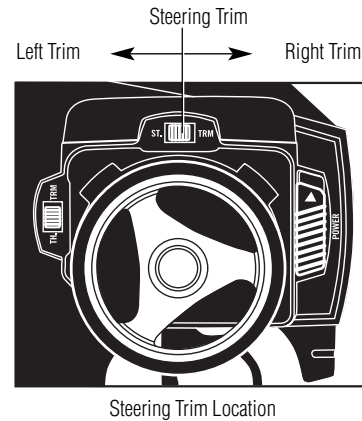

Throttle Trim

The XS3’s electronic Throttle Trim lever, located to the left of the steering wheel, allows the center position of the servo to move in either direction. Throttle end-point adjustment values remain completely independent from the throttle trim, unless the trim value exceeds the selected end-point values. (For example, if the trim value is set at 40 and the end-point values at 30, Throttle Trim will over-ride/alter the end-point value.)

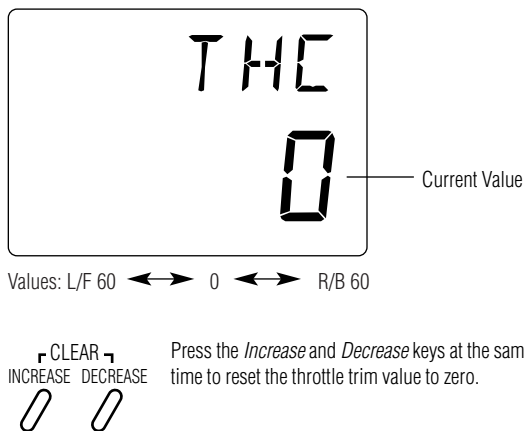

Each click will provide 0.3° of trim to the throttle servo with a maximum of 24° allowed.

Note: Each click will not always result in a change of the value displayed.

To adjust the Throttle Trim servo position, move the electronic steering trim lever either up or down. As soon as the trim is moved, the “THC” Throttle Trim screen will appear and will continue to be displayed unless the trim lever is untouched for a period of two seconds. To reset the trim value to zero, press the *Increase* and *Decrease* keys at the same time while the “THC” screen is displayed.

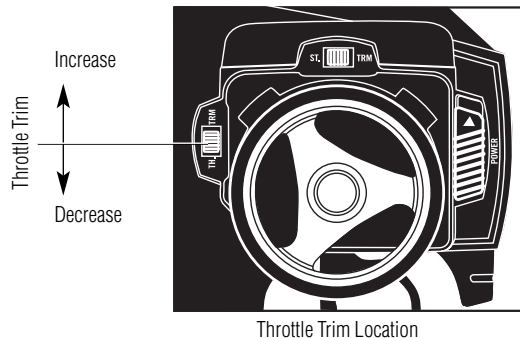

Grip Lever B: Steering Dual-Rate Trim Adjustment

The Steering Dual-Rate adjustment, located at Grip Lever B, allows the Dual-Rate value (maximum servo travel) to be increased or decreased within a range from 100% through 20% of the total end point value established in the steering EPA function. This function is very useful in race conditions as it allows you to custom tailor the steering radius and sensitivity for the current track conditions.

If the Emergency Steering button function (page 18) is active, pressing Grip Button C will restore the steering dual rate to 100% until the button is released.

To adjust the Steering Dual-Rate value, move the electronic Grip Lever B either left (-) or right (+). As soon as the trim is moved, the "STG" Steering Dual-Rate screen will appear and will continue to be displayed unless the Grip Lever B is untouched for a period of two seconds. To reset the trim value to the factory preset setting of 70%, press the *Increase* and *Decrease* keys at the same time while the "STG" screen is displayed.

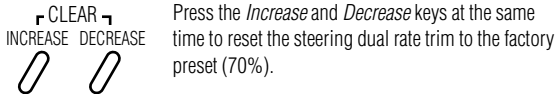
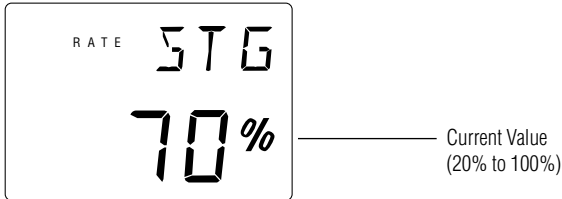

Please note that since the Dual-Rate value shown in the "STG" screen is the percentage of the end-point value established in the Steering EPA function, the value will not always increase or decrease each time Grip Lever B is moved.

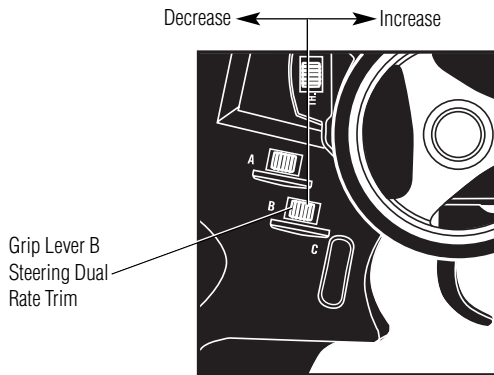

Grip Lever A: Brake End-Point Adjustment/Auxiliary Channel 3 Access

Brake End-Point Adjustment

The Brake End-Point Adjustment, located at Grip Lever A, allows the maximum servo travel on the braking side of the throttle trigger to be increased or decreased from 100% to 0% (off). This function is very useful in race conditions as it allows the racer to custom tailor the “panic” brake value to maximize the car’s braking power for the current track conditions. Please note that since the Brake End-Point value shown in the “BRK” screen is a percentage of the total braking value established in the End-Point Adjustment function (page 23), the value will not always increase or decrease each time the Grip Lever A is moved.

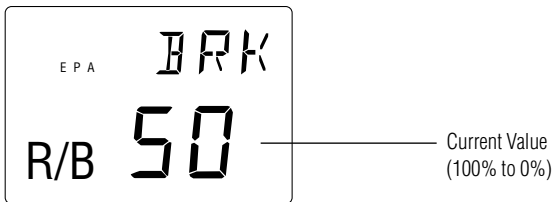

Note: If Grip Lever A is assigned an Auxiliary Channel 3 function by selecting “LN” or “2P” with Grip Button C in use, the Brake End-Point Adjustment will not be available.

To adjust the brake endpoint value, move the electronic Grip Lever A either left (-) or right (+). As soon as the grip lever is moved, the BRK End-Point Adjustment screen will appear and will continue to be displayed unless the Grip Lever A is untouched for a period of two seconds.

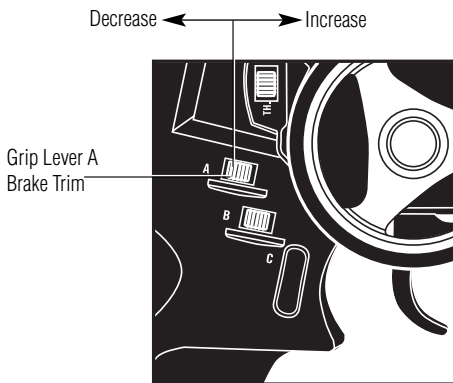

Move the grip lever A to the left or right to decrease or increase values.

Fuel Mixture

When selected, Grip Lever A can be used to access the Auxiliary Channel 3 function of the XS3 for use as a fuel mixture channel.

Auxiliary Channel 3 Fuel Mixture Control (LN selected)

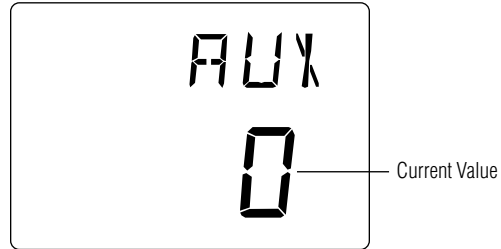

When the LN (linear) Auxiliary Channel 3 function is selected, Grip Lever A can be used to change the neutral position of the servo to lean or richen the engine’s fuel mixture. Once the desired fuel mixture has been achieved, the Grip Lever A value indicated on this screen can be transferred manually to the Sub-Trim function and the value of the AUX screen can be returned to zero. Please refer to diagram A to the right for proper grip lever operation.

Transmission Shift Selector

When the 2P Auxiliary Channel function is selected, the Grip Lever A can be used to move the Auxiliary 3 Channel servo to one of two positions (left/right or forward/reverse) when LA or Eb is selected for the Grip Button C function. Please refer to diagram A below for proper shifting procedures.

Note: The End-Point Adjustment function is used to set the forward and reverse gear servo travel positions.

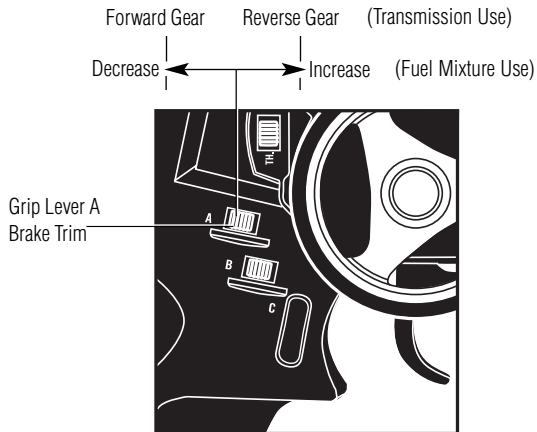

Diagram A

XS3 Data Sheet

System Mode

MODEL NUMBER	1 2 3 4 5 6
CHANNEL #	
MODEL NAME	
FRAME RATE	N/F
AUX FUNCTION	O/2P/LN
GRIP BUTTON C	O/Eb/LA

Function Mode

	STEERING	THROTTLE	AUX
THROTTLE DEADBAND		F _____% B _____%	
EXPONENTIAL	_____%	F _____% B _____%	
END-POINT ADJUSTMENT	L _____ R _____	F _____ B _____	L _____ R _____
MIXING	L _____% R _____%	F _____% B _____%	
SUB-TRIM			
SERVO REVERSING	REV/NORM	REV/NORM	REV/NORM

Direct Mode

TRIM VALUES	STEERING -/+	THROTTLE -/+	AUX. CHANNEL 3 -/+
GRIP LEVER B STEERING D/R	%		
GRIP LEVER A VALUES		BRAKE EPA %	AUX FUNCTION "LN"

System Mode

MODEL NUMBER	1 2 3 4 5 6
CHANNEL #	
MODEL NAME	
FRAME RATE	N/F
AUX FUNCTION	O/2P/LN
GRIP BUTTON C	O/Eb/LA

Function Mode

	STEERING	THROTTLE	AUX
THROTTLE DEADBAND		F _____% B _____%	
EXPONENTIAL	_____%	F _____% B _____%	
END-POINT ADJUSTMENT	L _____ R _____	F _____ B _____	L _____ R _____
MIXING	L _____% R _____%	F _____% B _____%	
SUB-TRIM			
SERVO REVERSING	REV/NORM	REV/NORM	REV/NORM

Direct Mode

TRIM VALUES	STEERING -/+	THROTTLE -/+	AUX. CHANNEL 3 -/+
GRIP LEVER B STEERING D/R	%		
GRIP LEVER A VALUES		BRAKE EPA %	AUX FUNCTION "LN"

XS3 Data Sheet

System Mode

MODEL NUMBER	1 2 3 4 5 6
CHANNEL #	
MODEL NAME	
FRAME RATE	N/F
AUX FUNCTION	O/2P/LN
GRIP BUTTON C	O/Eb/LA

Function Mode

	STEERING	THROTTLE	AUX
THROTTLE DEADBAND		F _____% B _____%	
EXPONENTIAL	_____%	F _____% B _____%	
END-POINT ADJUSTMENT	L _____ R _____	F _____ B _____	L _____ R _____
MIXING	L _____% R _____%	F _____% B _____%	
SUB-TRIM			
SERVO REVERSING	REV/NORM	REV/NORM	REV/NORM

Direct Mode

TRIM VALUES	STEERING -/+	THROTTLE -/+	AUX. CHANNEL 3 -/+
GRIP LEVER B STEERING D/R	%		
GRIP LEVER A VALUES		BRAKE EPA %	AUX FUNCTION "LN"

System Mode

MODEL NUMBER	1 2 3 4 5 6
CHANNEL #	
MODEL NAME	
FRAME RATE	N/F
AUX FUNCTION	O/2P/LN
GRIP BUTTON C	O/Eb/LA

Function Mode

	STEERING	THROTTLE	AUX
THROTTLE DEADBAND		F _____% B _____%	
EXPONENTIAL	_____%	F _____% B _____%	
END-POINT ADJUSTMENT	L _____ R _____	F _____ B _____	L _____ R _____
MIXING	L _____% R _____%	F _____% B _____%	
SUB-TRIM			
SERVO REVERSING	REV/NORM	REV/NORM	REV/NORM

Direct Mode

TRIM VALUES	STEERING -/+	THROTTLE -/+	AUX. CHANNEL 3 -/+
GRIP LEVER B STEERING D/R	%		
GRIP LEVER A VALUES		BRAKE EPA %	AUX FUNCTION "LN"

XS3 Data Sheet

System Mode

MODEL NUMBER	1 2 3 4 5 6
CHANNEL #	
MODEL NAME	
FRAME RATE	N/F
AUX FUNCTION	O/2P/LN
GRIP BUTTON C	O/Eb/LA

Function Mode

	STEERING	THROTTLE	AUX
THROTTLE DEADBAND		F _____% B _____%	
EXPONENTIAL	_____%	F _____% B _____%	
END-POINT ADJUSTMENT	L _____ R _____	F _____ B _____	L _____ R _____
MIXING	L _____% R _____%	F _____% B _____%	
SUB-TRIM			
SERVO REVERSING	REV/NORM	REV/NORM	REV/NORM

Direct Mode

TRIM VALUES	STEERING -/+	THROTTLE -/+	AUX. CHANNEL 3 -/+
GRIP LEVER B STEERING D/R	_____%		
GRIP LEVER A VALUES		BRAKE EPA _____%	AUX FUNCTION "LN"

System Mode

MODEL NUMBER	1 2 3 4 5 6
CHANNEL #	
MODEL NAME	
FRAME RATE	N/F
AUX FUNCTION	O/2P/LN
GRIP BUTTON C	O/Eb/LA

Function Mode

	STEERING	THROTTLE	AUX
THROTTLE DEADBAND		F _____% B _____%	
EXPONENTIAL	_____%	F _____% B _____%	
END-POINT ADJUSTMENT	L _____ R _____	F _____ B _____	L _____ R _____
MIXING	L _____% R _____%	F _____% B _____%	
SUB-TRIM			
SERVO REVERSING	REV/NORM	REV/NORM	REV/NORM

Direct Mode

TRIM VALUES	STEERING -/+	THROTTLE -/+	AUX. CHANNEL 3 -/+
GRIP LEVER B STEERING D/R	_____%		
GRIP LEVER A VALUES		BRAKE EPA _____%	AUX FUNCTION "LN"

Frequency Chart

FREQUENCY (MHz)	CHANNEL	FREQUENCY (MHz)	CHANNEL	FREQUENCY (MHz)	CHANNEL
26.995	1	75.530	67	75.770	79
27.045	2	75.550	68	75.790	80
27.095	3	75.570	69	75.810	81
27.145	4	75.590	70	75.830	82
27.195	5	75.610	71	75.850	83
27.255	6	75.630	72	75.870	84
75.410	61	75.650	73	75.890	85
75.430	62	75.670	74	75.910	86
75.450	63	75.690	75	75.930	87
75.470	64	75.710	76	75.950	88
75.490	65	75.730	77	75.970	89
75.510	66	75.750	78	75.990	90

Warranty and Service Information

Note: Be sure to keep your original dated sales receipt in a safe place as you will be required to provide proof of purchase date for the equipment to be serviced under warranty.

Warranty Coverage

Your new JR Remote Control Radio System is warranted to the original purchaser against manufacturer defects in material and workmanship for 3 years from the date of purchase. During this period, Horizon Service Center will repair or replace, at our discretion and at no cost to the purchaser, any component that is found to be factory defective. This warranty is limited to the original purchaser of the unit and is not transferable.

This warranty does not apply to any unit that has been improperly installed, mishandled, abused or damaged in a crash or to any unit that has been repaired or altered by any unauthorized agencies. Under no circumstances will the buyer be entitled to consequential or incidental damages. This limited warranty gives you specific legal rights; you also have other rights that may vary from state to state. As with all fine electronic equipment, do not subject your radio system to extreme temperatures, humidity or moisture. Do not leave it in direct sunlight for long periods of time.

Repair Service Directions

In the event that your JR radio needs service, please follow the instructions listed below.

1. Check all on/off switches to be sure they are off. This will speed the repair process of checking battery condition.
2. Return your system components only (transmitter, receiver, servos, etc.). Do not return your system installed in a model car, boat, etc.
3. Preferably, use the original carton/packaging (molded foam container) or equivalent to ship your system. Do not use the system carton itself as a shipping carton. You should package the system carton within a sturdy shipping container using additional packing material to safeguard against damage during transit. Include complete name and address information inside the carton, as well as clearly writing it on the outer label/return address area.
4. Include detailed information explaining your operation of the system and problem(s) encountered. Provide an itemized list of equipment enclosed and identify any particular area/function, which may better assist our technicians in addressing your concerns. Date your correspondence and be sure your complete name and address appear on this enclosure.
5. Include your name, mailing address and a phone number where you can be reached during the business day.
6. Within your letter, advise us of the payment method you prefer to use. The Horizon Service Center accepts only VISA or MasterCard. Please include your card number and expiration date.

Warranty Repairs

To receive warranty service, you must include your original dated sales receipt to verify your proof-of-purchase date. Providing that warranty conditions have been met, your radio will be repaired without charge.

Normal Non-Warranty Repairs

Should your repair cost exceed 50% of the retail purchase cost, you will be provided with an estimate advising you of your options. Ship your system to:

Horizon Service Center
4105 Fieldstone Road
Champaign, IL 61822
Phone: (217) 355-9511

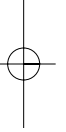
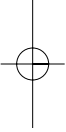
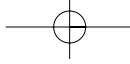

JRPM129

©Copyright 2002 Horizon Hobby, Inc.

