



Room Air Conditioner

# OPERATING INSTRUCTIONS

**HP21WC-Cooling Only**

**HP21WR-Reverse Cycle**

Thank you for selecting Hotpoint air conditioners.

Please read this manual carefully before operation and keep it for further reference.



# CONTENTS

Thank you for choosing a Hotpoint air conditioner. Our design is based on the best efficiency and the lowest noise operation and it can keep the room comfortable. Please read this operating manual carefully before operating the unit and keep it for consultation.

## Structure mechanism and Installation

Function	1
Operating condition	2
power requirement	2
Installation	3
Notes for installation	5

## Operation procedure

Part identification	6
Air direction adjustment	6
Main switch operation procedure	7
Operation of wireless remote control	8
Operation tips	14

## Care and maintenance

Caution	15
Care and maintenance	16
Trouble shooting guide	17
After service	18

Please read this operating manual carefully before operating the unit.

Note: All the pictures in this manual are just schematic diagrams. □ □  
The actual product is the standard.

## ● Function

### Introduction

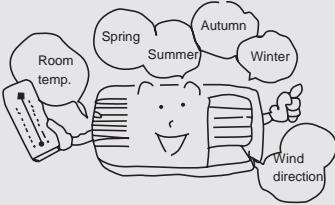

Window type room air conditioners of Hotpoint can regulate the room temperature and dry the room. It is convenient for your work, study and life. It can be widely used in residence, shop, hotel, office, library and laboratory, and so on.

### Cooling in summer

In hot summer, Air conditioner can cool down the room air by transferring heat out.

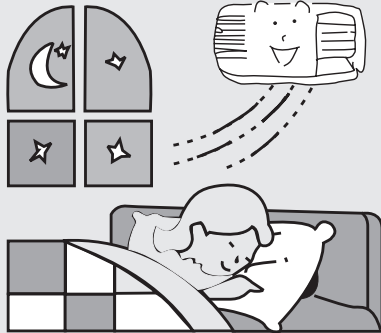

### Dehumidifying in rainy or humid season

Without reducing the room temp., air conditioner can dehumidify and make the room air dry and comfortable.

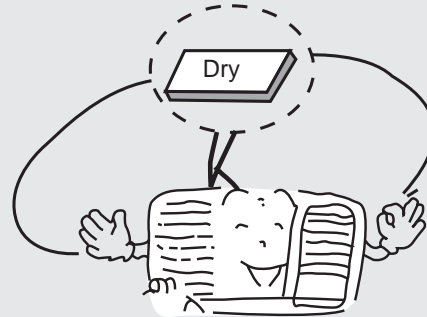

### Heating in winter (Only for heat unit)

In cold winter, Air conditioner can heat up room air.



### Exchange fresh air

Open storm door to keep the fresh air in the room.





## ● Operating Condition

- Please operate air conditioner in the correct conditions as follows.

COOL mode operation	DRY mode operation
<p>Outdoor temperature should be in range of 18°C to 43°C, otherwise it is possible for air conditioner to breakdown.</p> <p>Room humidity should be lower than 90%. Otherwise, it is possible for air conditioner to dew at air conditioner surface and even drop water after running for so much time. But this is normal.</p>	<p>Outdoor temperature should be in range of 18°C to 43°C, otherwise it is possible for air conditioner to breakdown.</p>

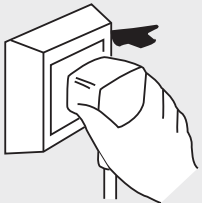
## Power requirement (15Amp/15Amp Circuit)

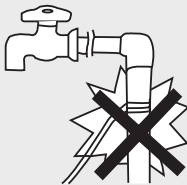
	<p>Rated voltage and voltage range: 230V ~ ± 10%</p> <p>* The electric components will be damaged when the voltage is too high. If the voltage is too low, the compressor will vibrate violently to damage the refrigerant system and easily cause the compressor and electric components not work.</p>	
	<p>The ground must be connected.</p> <p>* Special socket must be used. Furthermore, the socket and wiring must conform to Australian National Standards. And the earthing method must be reliable.</p> <p>* In fixed circuit, there must be electricity leakage protection switch of enough power capacity and air switch with enough space.</p>	
<p><b>Earth wire</b> To ensure the reliable earthing, please do not connect earth wire to the following places:</p>		
<p>Water pipe</p> 		

## ● Installation

### Installation precaution:

Window type conditioner is so valuable and the improper installation of it will cause a lot of damage! Please consult with a licenced technician to install the unit and don't install it by yourself. Hotpoint is not responsible for incorrect installation.



### Location:

- The condensation water must be drained away conveniently.
- Install air conditioner unit far away from TV set or radio etc. to avoid disturbing video or voice.
- In salt and coastal area or place where is near thermal springs and polluted by sulphurous gas, or other special areas, please contact the seller before use.
- Avoid a place where is possible for inflammable gas to leak out.
- Avoid other heat sources or direct sun light.
- Avoid a place where is easy for children to touch.
- Don't use the unit in the immediate surroundings of a laundry, a bath, a shower or a swimming pool.
- For window type air conditioner with remote control, install in a location away from strong electromagnetic disturbance, you should contact the seller in advance to avoid the malfunction in use.

### How to install:

- Choose a location where there are no any obstacle surrounding the unit, and the plug is accessible.
- Prepare the installation hole slightly bigger than unit size.
- Choose the installation space according to the following diagram.

The distance of obstructions from window unit inside should be upper 300mm, lower 1500mm, left 500mm, right 500mm, front 1500mm.

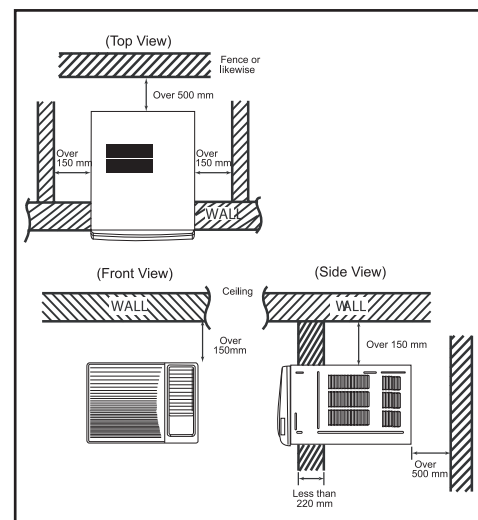

## Installation procedure:

- 1) Remove the sticker from the front panel.
- 2) Put the unit into the installation hole.
  - When installing the unit, it should be slanted down to the back to avoid the enlargement of noise or vibration. (Slant between 6-10mm.) (Shown at right figure.)
  - The installation place should be strong enough to avoid the enlargement of noise or vibration.
- 3) Fill up sews in the cabinet with sponge or foam.

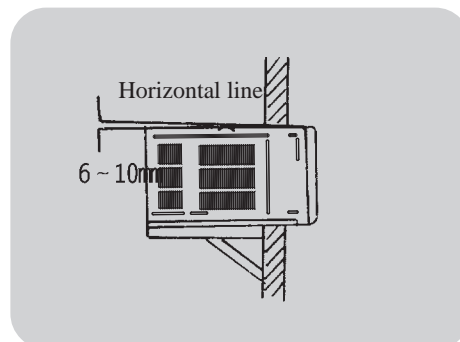

## Installation assistance:

- Use iron support  
The installation hole should be strong enough to support the air conditioner. If it cannot, iron support has to be used outdoors.  
Iron support should be fixed on the building (Shown at right figure.)
- Use sunshade board  
Air conditioner should avoid anything to be dropped into it and avoid direct sunshine. If there is no cover on it, you should contact the seller for installing the sunshade board. When installing the sunshade board, don't let it block the air inlet at the side grille.

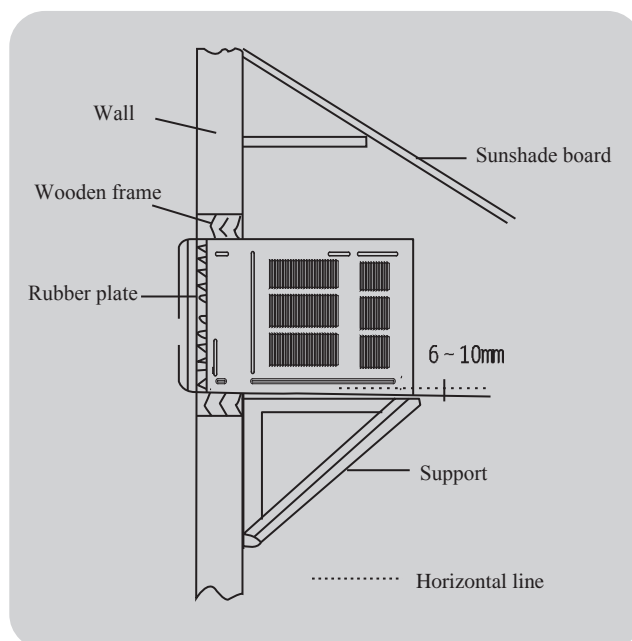

## Drain water:

To get the maximum cooling efficiency, the air conditioner is designed to splash the condensation water on the condenser coil.

To the cooling only unit, If the splashing sound annoys you, you can provide an outside drain by using the following procedure, which may however cause a small loss of performance.

1. Slide out the chassis from the cabinet.
2. Remove the rubber plug from the body base plate.
3. Install the drain pan to the corner of the cabinet with 2 screws.
4. Connect the drain hose to the outlet on the drain pan bottom.
5. Slide the chassis into its original place in the cabinet.

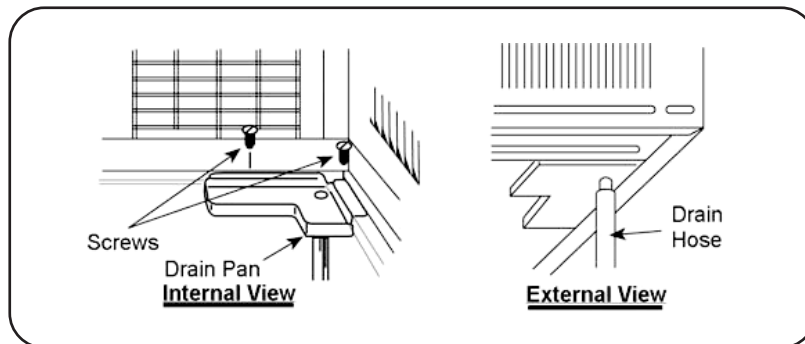

**Note:**

- Drain pan and drain hose must be installed before using reverse cycle models.
- Drain hose or tubing can be purchased locally to satisfy your particular needs.

## ● Notes for installation

### Remove

Before removing air conditioner to another place, you should contact the installer first. Then it must be done under the direction of a licenced technician. In addition, the charge of this must be paid.

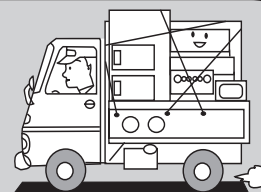

### Noise

- Install in a location that is firm enough to avoid the enlargement of noise and vibration.
- Don't put anything in front of the outlet of outdoor unit to avoid increasing noise.
- Be sure that hot air or noise will not inconvenience neighbors.
- Please contact the seller as soon as there is strange noise during operation.
- Please use the safety support.

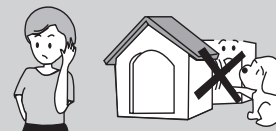

### Electric wiring

- Must connect with ground reliably.
- The exclusive circuit must be used. But removable socket can't be used because poor contact of it can cause over heat or fire.
- Don't pull the power cord strongly.
- In fixed circuit, there must be electricity leakage protection switch and leakage current is less than 30mA.
- Connecting method between air conditioners and power cord and interconnecting method of each individual element with one another should accord with wiring diagram on the unit. □ □
- The air conditioner should be installed in accordance with national wiring regulation.
- An all-pole disconnection switch having a contact separation of at least 3mm in all poles should be connected in fixed wiring
- Air switch (thermal-magnetic breaker) should be installed in the circuit.
- If the supply cord is damaged, it must be replaced by the manufacturer or your dealer or a qualified person to avoid a hazard.
- All The dectrical work must be done according to the local wiring regulations.
- In case necessary, please consult your supply authority for system impedance information.





## ● PART IDENTIFICATION

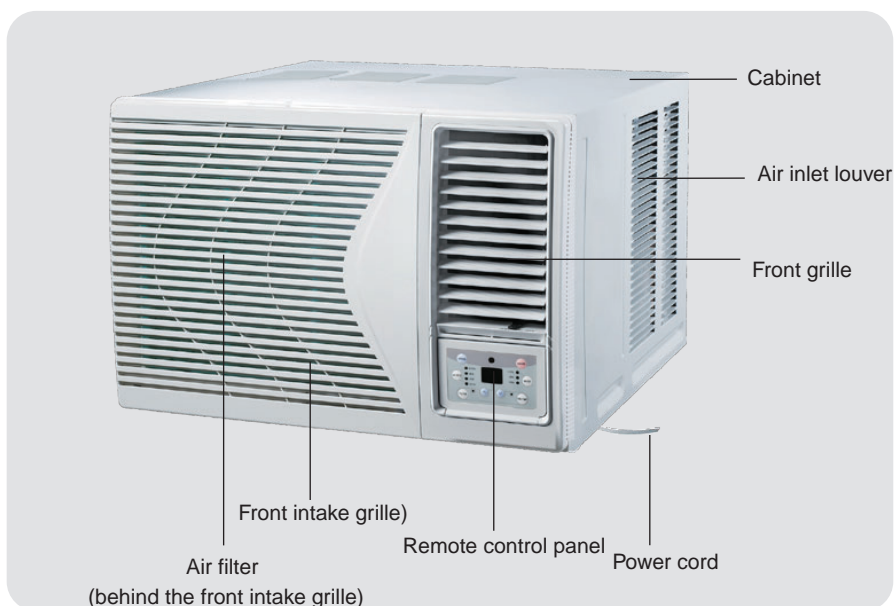
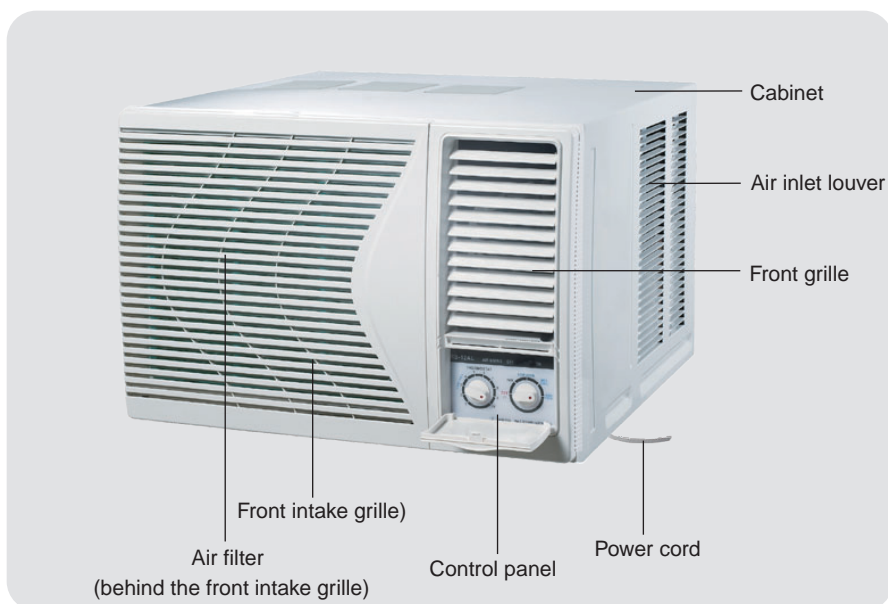

### Air direction adjustment

#### Vertical airflow direction vane

(Airflow direction adjustment up and down).

The vertical airflow direction vane is controlled by positioning the vane to discharge the air upwards, downwards or straight out.

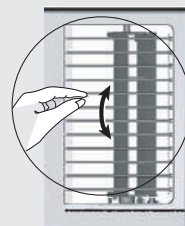

## ● Main switch operation procedure

### 1. Only Cooling

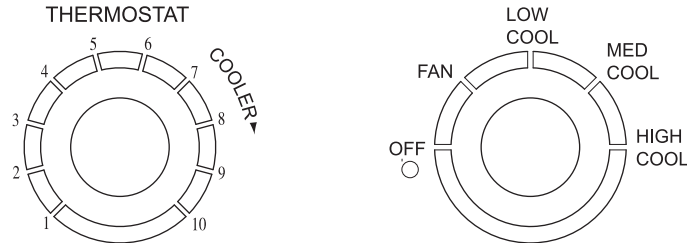

#### 1. Main Control Knob

Set to Low Cool, Med Cool or High Cool as desired (FAN setting operates the fan only.) □

CAUTION: If the main control knob is turned off or changed to a fan setting from a cooling operation setting, WAIT at least 3 minutes before resetting to cooling operation.

#### 2. Thermostat control Knob

Set the thermostat control knob to your desired setting (Usually 6-7 is recommended). If the room temperature is not as desired after a reasonable period, turn the thermostat. When the thermostat control knob is set to 10 moisture may freeze onto the evaporator fins by turning the thermostat control knob counter clockwise, This will quickly defrost the evaporator fins so that normal cooling can be resumed.

### 2. Cooling and Heating

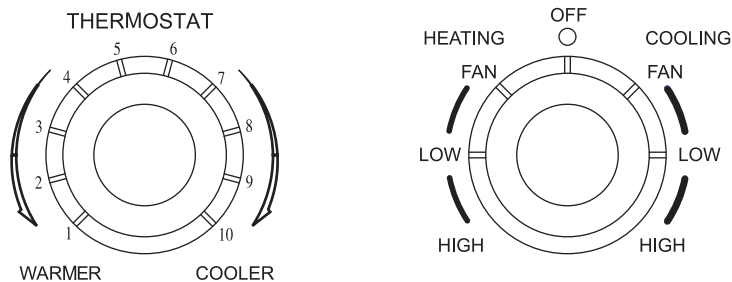

#### 1. Main Control Knob

Set either Low Cooling or High Cooling and Low Heating or High Heating as desired.

(FAN setting operates the fan only.) □

CAUTION: If the main control knob is turned off or changed to a fan setting from a cooling operation setting, WAIT at least 3 minutes before resetting to cooling operation.

#### 2. Thermostat control Knob

Set the thermostat control knob to your desired setting (Usually 4-5 is recommended setting for setting for heating and 6-7 for cooling). If the room temperature is not as desired after a reasonable period, turn the thermostat. When the thermostat control knob is set to 10 moisture may freeze onto evaporator fins by turning the thermostat control knob counter clockwise, This will quickly defrost the evaporator fins so that normal cooling can be resumed.



### 3. Air Swing Switch (Airflow direction adjustment Side-to Side)

To obtain a fix airflow direction, set the air swing switch to "ON" for the vanes to swing from side to side until the desired flow direction is reached, then switch it to "OFF".

For continuous side-to-side air circulation, set the air swing switch to "ON".

## ● Operation of wireless remote control

### ■ Name and function of wireless remote control

Note:

- Besure that there are no obstructions between receiver and remote controller; Don't drop or throw the remote control; Don't let any liquid in the remote control and put the remote control directly under the sunlight or any place where is very hot.

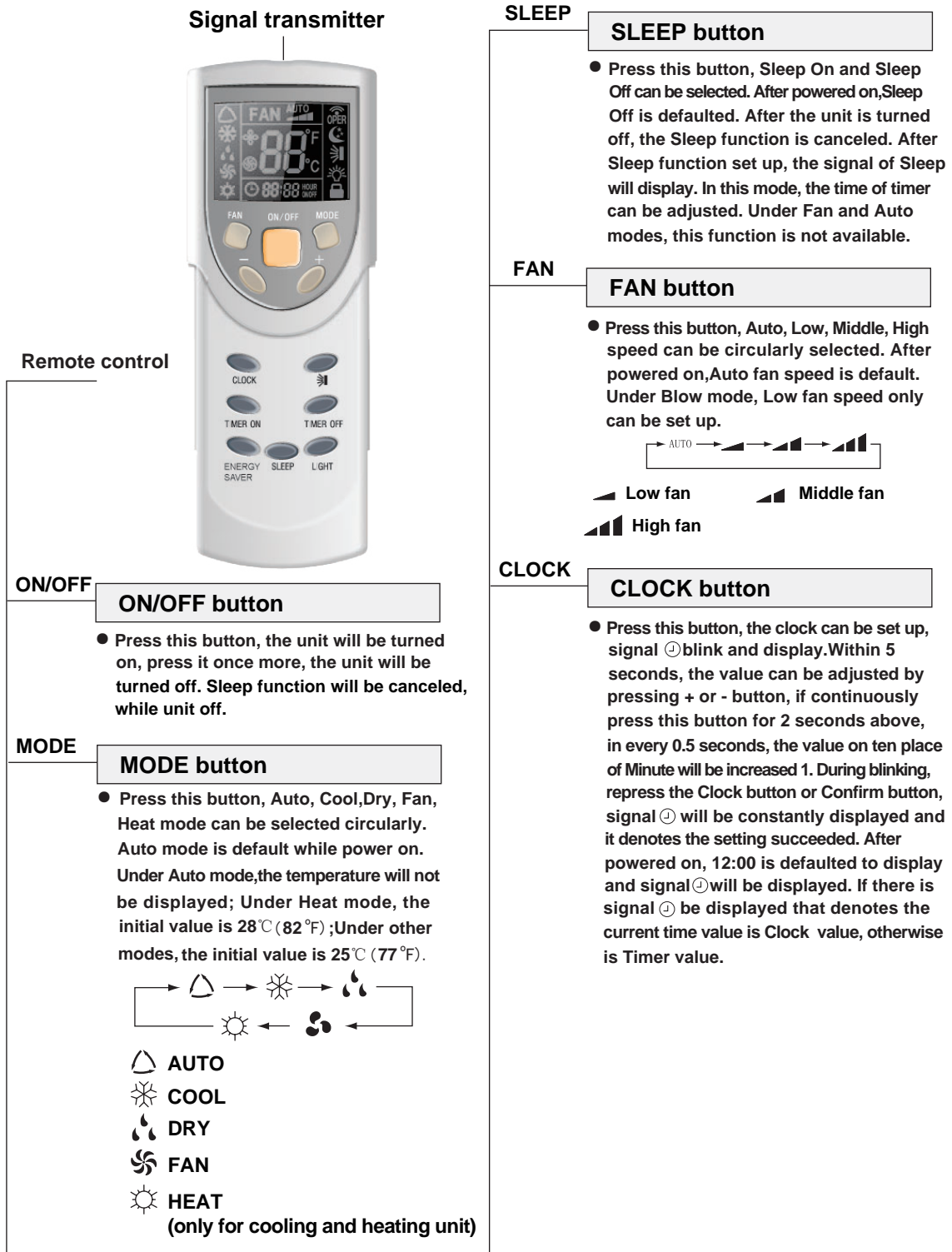

## ■ Name and function of wireless remote control

**Note:** ● This wireless remote control is universal, and it could be used for many units, some buttons of this control which are not available to this unit will not be described below.

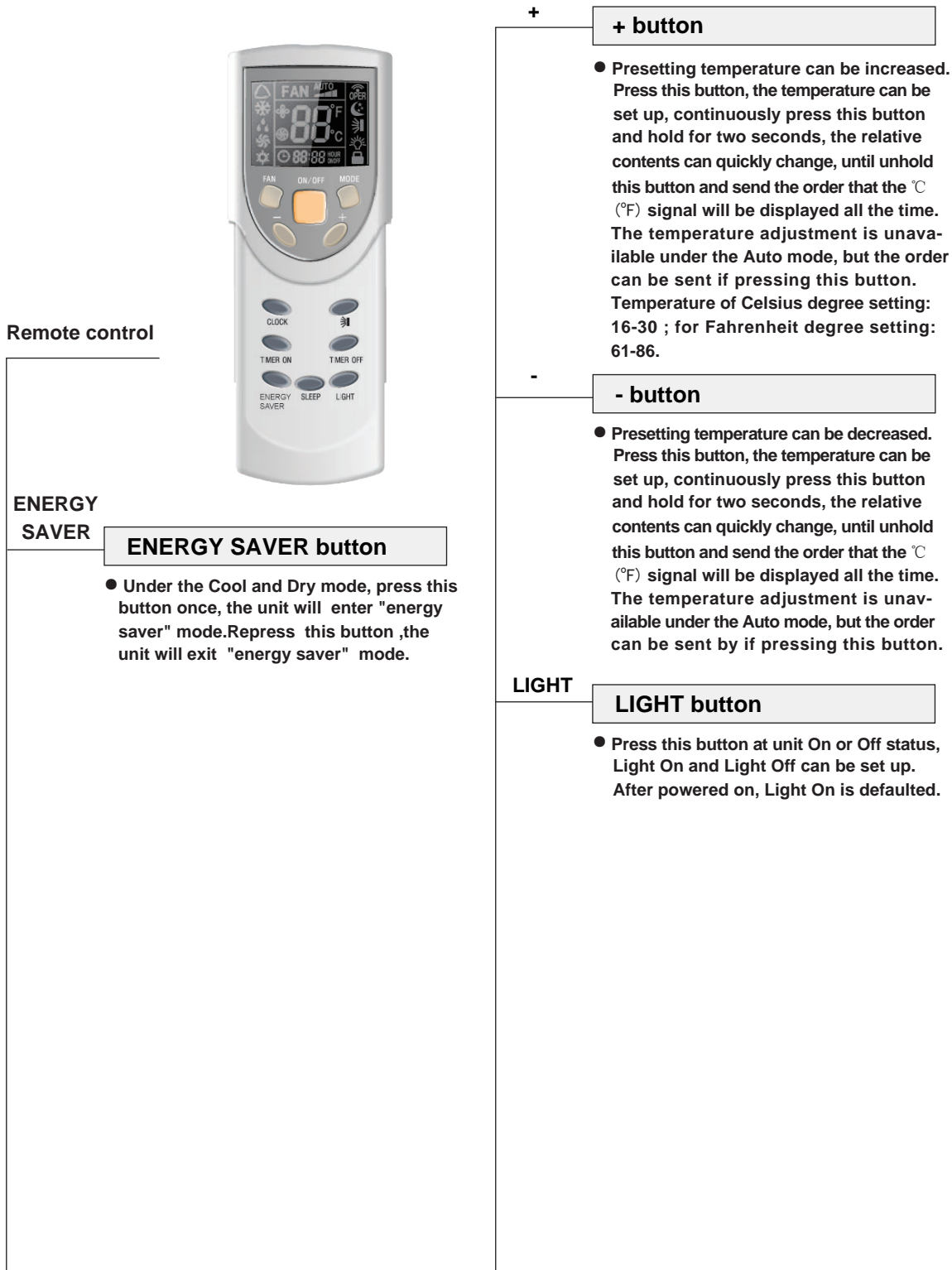

## ■ Name and function of wireless remote control

### Note:

- This wireless remote control is universal, and it could be used for many units, some buttons of this control which are not available to this unit will not be described below.

Remote control



### SWING BUTTON

- When it is pressed, the louvers start to rotate automatically and stop when repressed.

### TIMER ON

#### TIMER ON BUTTON

- At unit off, press Timer On button, "HOUR ON" will blink and display, signal  will be concealed, in the timer on setting. During 5 seconds blinking, the value can be adjusted by pressing + or - button, every press of this button, 0.5 hour will be increased or decreased, but continuously press the + or - button, 2 seconds later, the value will be changed quickly, 0.5 hour will be increased in every 0.25 second automatically by the remote controller. During blinking, press the Timer On button to confirm the time. After Timer On set up, when repressing the Timer On button, the Timer On setting will be canceled. After powered on, no Timer is defaulted, signal "HOUR ON (OFF)" will not display, and only the clock is displayed. After the timer reached, the relative contents with Timer will conceal. Before setting the Timer, please adjust the clock to the current actual time.

### TIMER OFF

#### TIMER OFF BUTTON

- At unit on, press Timer Off button to enter into Timer Off setting. The method of setting is the same as for TIMER ON.

## ■ Guide for operation- general operation

1. After powered on, press ON/OFF button, the unit will start to run.(Note: When it is powered off, the guide louver of main unit will close automatically.)
2. Press MODE button, select desired running mode, or press COOL or HEAT mode to enter into the corresponding operation directly.
3. Pressing + or - button, to set the desired temperature (It is unnecessary to set the temp. at AUTO mode.)
4. Pressing FAN button, set fan speed, can select AUTO FAN, LOW, MID and HIGH.
5. Pressing  button, to select the swing.

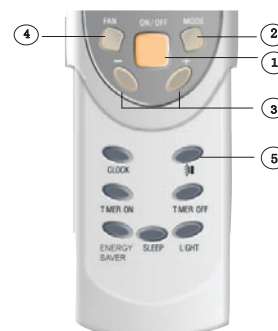

## ■ Guide for operation- Optional operation

1. Press SLEEP button, to set sleep.
2. Press TIMER ON and TIMER OFF button, can set the scheduled timer on or timer off.
3. Press LIGHT button, to control the on and off of the displaying part of the unit (This function may be not available for some units).
4. Press ENERGY SAVER button, can realize the ON and OFF of ENERGY SAVER function.

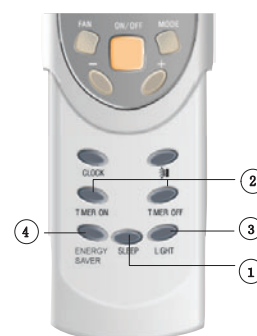

## ■ Introduction for special function



### ★ About AUTO RUN

When AUTO RUN mode is selected, the setting temperature will not be displayed on the LCD, the unit will be in accordance with the room temp. automatically to select the suitable running method and to make ambient comfortable.

### ★ About lock

Press + and - buttons simultaneously to lock or unlock the keyboard. If the remote controller is locked, the icon  will be displayed on it, in which case, press any button, the mark will flicker for three times. If the keyboard is unlocked, the mark will disappear.

### ★ About swing up and down

1. Press swing up and down button continuously more than 2s, the main unit will swing back and forth from up to down, and then loosen the button, the unit will stop swinging and present position of guide louver will be kept immediately.
2. Under swing up and down mode, when the status is switched from off to , if press this button again 2s later,  status will switch to off status directly; if press this button again within 2s, the change of swing status will also depend on the circulation sequence stated above.

### ★ About switch between Fahrenheit and Centigrade

Under status of unit off, press MODE and - buttons simultaneously to switch °C and °F.

### ★ About new function of defrosting

It indicates: after starting this function by remote controller and the unit has been under defrost status, If you turn off the unit by remote controller, the unit will not stop defrosting until it is finished; if changing the setting mode by remote controller, the function, which is set last time, won't be carried out until defrosting is finished.

Operation of this function on or off: If remote controller is under off status, press mode button and blow button simultaneously in order to enter or cancel this new function. If the unit is under defrost mode, dual eight position on remote controller will display H1. If switch to heat mode, the position will display H1, which flickers for 5s, in which case, press MODE/- button, H1 will disappear and setting temp. be displayed.

After remote controller is powered on, the new defrost function will be defaulted to be closed.

## ■ Changing batteries and notices

1. Slightly press the place with , along the arrowhead direction to push the back cover of wireless remote control. (As show in figure)
2. Take out the old batteries. (As show in figure)
3. Insert two new AAA1.5V dry batteries, and pay attention to the polarity. (As show in figure)
4. Attach the back cover of wireless remote control. (As show in figure)

### ★ NOTE:

- When changing the batteries, do not use the old or different batteries, otherwise, it can cause the malfunction of the wireless remote control.
- If the wireless remote control will not be used for a long time, please take them out, and don't let the leakage liquid damage the wireless remote control.
- The operation should be in its receiving range.
- It should be placed 1m away from the TV set or stereo sound sets.
- If the wireless remote control can not operate normally, please take them out, after 30s later and reinsert, if they cannot normally run, please change them.

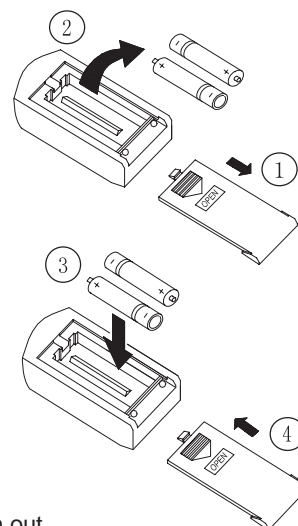

Sketch map for changing batteries

## Remote control panel

### Note:

If wireless remote controller is lost, open the surface panel and operate manually.

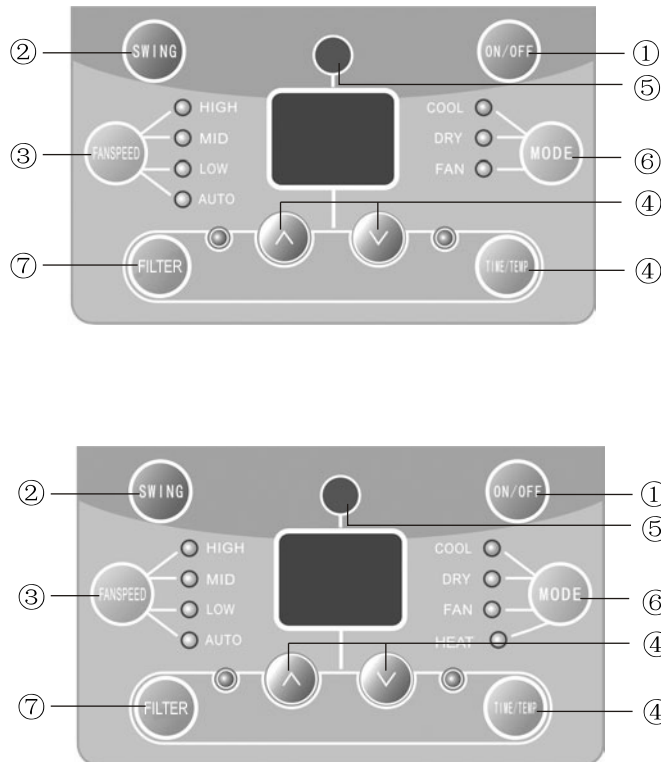

- |  |   |
|--|---|
| <p><b>1 POWER BUTTON</b><br/>Operation starts when pressing this button, and stops when pressing this button again.</p> <p><b>2 SWING BUTTON</b><br/>Activate the automatic air swing function.</p> <p><b>3 FAN SPEED BUTTON</b><br/>Select the fan speed HIGH, MID, LOW and AUTO in sequence.</p> <p><b>4 TEMP/TIMER BUTTON</b><br/>Press the ▲ keypad to increase the set (operating) temperature of the unit. and Press the ▼ keypad to decrease the set (operating) temperature of the unit. The temperature setting range is from 16~30°C<br/>Press the ▲ keypad also to increase the selected time in 1 hour increments, and Press the ▼ keypad to decrease the selected time in 1 hour decrements, The time setting range is from 0~24 hours.</p> | <p><b>5 SIGNAL RECEIVER</b></p> <p><b>6 MODE BUTTON</b><br/>Select the operation mode, AUTO, HEAT, COOL, FAN, DRY (for reverse cycle model) or AUTO, COOL, FAN, DRY (for cooling only model).</p> <p><b>7 FILTER BUTTON</b><br/>This feature is a reminder to clean the Air Filter (See Care and Cleaning) for more efficient operation and cooling. The LED (light) will illuminate after 250 hours of operation. To reset after cleaning the filter, press the "Check Filter" button and the light will go off. Before the LED(light) illuminate, press the "Check filter" button until after 3 seconds, the accumulated time of. Operation will be canceled.</p> |
|--|---|

### VENTILATION LEVER

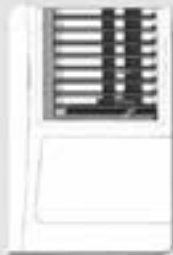

Ventilation Lever

When the slider at the:



- "OPEN" position, the ventilation door opens to allow air, smoke or odors to be expelled from the room.

When the slider at the:



- "CLOSE" position, the ventilation door is closed and the air will be circulated inside the room and conditioned.



## ● Operation Tips

Operation for comfort and economy

**Do not overcool the room temperature.** This is not good for health and wastes electricity.

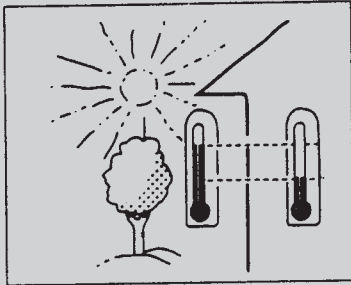

**Keep blind or curtains closed.** Do not let sunshine enter the room directly when the air condition is in operation.

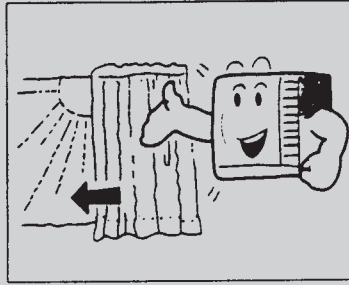

**Keep the room temp. uniform.** Adjust the vertical and horizontal airflow direction to ensure a uniform temperature in the room. Air can't be discharged to the direction of air-in.

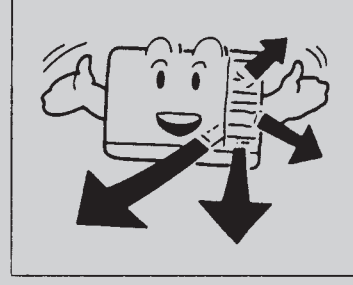

**Make sure that the doors and windows are tightly closed.** Avoid opening doors and windows as much as possible to keep air conditioning in the room.

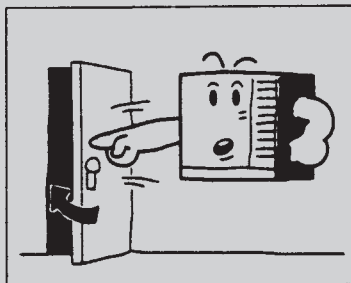

**Clean the air filter regularly.** Blockages in the air filter reduce dehumidifying effects. Clean the air filter at least once every two weeks.

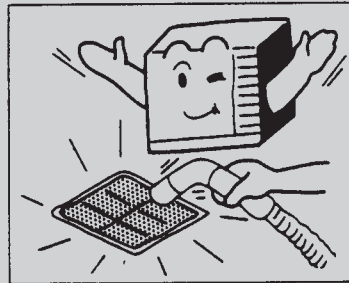

**Ventilate the room occasionally.** Since windows are kept closed, it is a good idea to open them and ventilate the room now and then. When starting the unit, curtains or windows should be closed to prevent the heat/cool leakage.

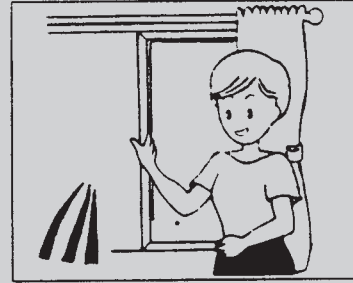

## ● Caution

### Operations for safety and health

- 1) The plug must be accessible after the appliance is positioned.
- 2) Do not use this appliance in the laundry.
- 3) If the power cord is damaged, it must be replaced by the manufacture or its service agent in void of hazard.

- Do not pull out the power cord.
- Damage to the cord may result in serious electric shocks.
- Do not use the air conditioner for other purposes except for cooling the room.
- Do not use the air conditioner for other purposes such as drying clothes, preserving foods, or cultivating vegetables.
- Do not block the air intake and outlet vents. This causes lowered performance and irregular operation.
- Do not insert sticks or other objects into these vents as it is dangerous to touch the electric components and the fan.

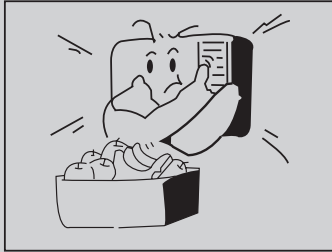
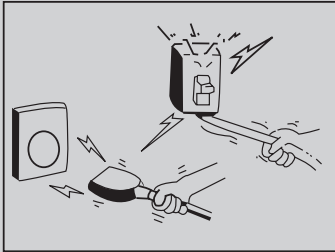

Select the most appropriate temperature. Pay attention to adjust the temperature to suit the conditions. Rooms occupied by infants, the elderly, or the sick should be kept at an appropriate temperature.

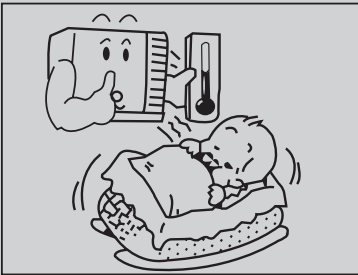

Do not use heating apparatuses in the vicinity. The air conditioner's plastic parts will melt if exposed to excessive heat.

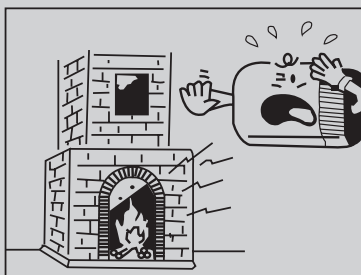

Avoid exposing the body directly to a continuous unidirectional air flow for long periods. This is not recommended for health reason.

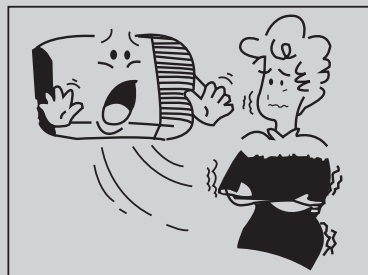

Always wait at least 3 minutes before switching the air conditioner on again after you have switched it off during cooling or heating.

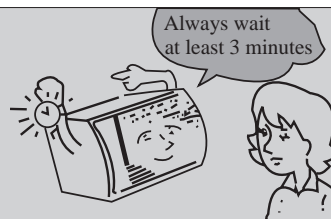

## ● Care and maintenance

Always turn off the air conditioner and main power supply before cleaning to ensure safety.

### Cleaning unit

1. Cut power off before cleaning.

Plug out only after air conditioner stops at all.

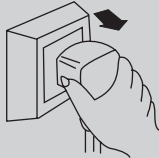

2. Use soft cloth when cleaning cabinet.

If the cabinet is very dirty, dip cloth into warm water below 40°C, dry the cloth and then rub off the dirt.



Dry the cloth by hands before cleaning.

3. Don't use gas, benzene, solvent, wash, chemical solvent, etc. for cleaning.



4. Do not splash water directly into indoor unit, in which there are micro-computer and circuit plate, they must not be drenched with water.



\* Check earth wire

Is it broken or loose?

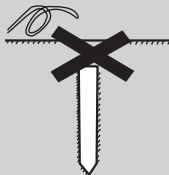

### Air filter

The air filter behind the intake grille should be washed at least once every two weeks or as often as it needs cleaning.

How to clean the air filter:

1. To remove the air intake grille, grasp the tab on the filter and pull to take out.

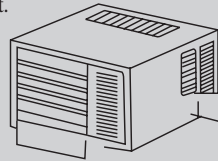

2. Vacuum the filter on the dusty side to remove light dust.



Vacuum cleaner

3. Wash the filter, cleaner side up under gently flowing water to wash out accumulated dust and lint.



4. If the filter is very dirty, use a mild household detergent in the wash water.



Let the filter dry thoroughly before reinstalling it. If necessary, please ask the professional personnel to clean it.





\* Check if air inlet and outlet of outdoor unit are blocked or not.

Air lock could result in bad efficiency.



## ● Trouble shooting guide

Please check the following items before asking for repair, it saves your time and money.

Fault phenomenon	Trouble-shooting
<p>Air conditioner does not operate at all.</p> 	<ul style="list-style-type: none"> <li>* Is there a power failure?</li> <li>* Is the plug out?</li> <li>* Is power fuse or switch off?</li> <li>* Whether the voltage is too high or too low?</li> </ul>
<p>Cool or heat efficiency is not good.</p> 	<ul style="list-style-type: none"> <li>* Is air inlet or outlet locking?</li> <li>* Is there any other heat/cool source in room?</li> <li>* Are air filters dirty very much?</li> <li>* Is indoor fan speed set at LOW?</li> <li>* Maybe the room is too hot/cool when the unit is started.</li> </ul>
<p>Foggy air flows out.</p> 	<ul style="list-style-type: none"> <li>* At COOL mode operation, sometimes there is foggy air flowing out of indoor unit, this is because the room humid air has been cooling rapidly.</li> <li>* The unit is normal while the indoor outlet is sending out some odor, because the inlet air may be mixed with the smell of furniture and smoke.</li> </ul>
<p>The air conditioner operation is noisy.</p> 	<ul style="list-style-type: none"> <li>* For a noise that sounds like water flowing: This is the sound of freon flowing inside the air conditioner unit.</li> <li>* For a noise that sounds like a shower: This is the sound of the dehumidifying water being processed inside the air conditioner unit.</li> </ul>
<p>It seems that condensation is leaking from air conditioner.</p>	<ul style="list-style-type: none"> <li>* Condensation occurs when the airflow from the air conditioner cools the warm room air.</li> </ul>
<p>Air conditioner does not operate for about 3 minutes when restart.</p>	<ul style="list-style-type: none"> <li>* This is to protect the mechanism.</li> <li>* Wait about three minutes and operation will begin.</li> </ul>

---

Immediately stop all operations and plug out, please contact your dealer in the following situations.

- \*Operation starts or stops abnormally;
- \*Power fuse or switch often breaks;
- \*Carelessly splash water or something into air conditioner;
- \*Electrical lines are much hot or lines cover breaks;
- \*Other strange situations.



## ● After service

- If your air conditioner has the questions of quality or anything else, please contact the Hotpoint National Service Department on 1300-303-929.



## WARRANTY RECORD

Please complete all details below should warranty service be required on your new Hotpoint air conditioner. This form must be completed by the customer and the installer.

Please retain this form and attach your receipt to it. Should you require any warranty service, please check the fault finding chart at the back of this manual first and then contact Hotpoint National Service Department on **1300-303-929** who will appoint an authorised Service Agent to assist you. **You must have your receipt to claim warranty.**

CUSTOMER NAME: \_\_\_\_\_

ADDRESS: \_\_\_\_\_

SUBURB: \_\_\_\_\_ STATE: \_\_\_\_\_ POSTCODE: \_\_\_\_\_

RETAILER NAME: \_\_\_\_\_

D.O.P.: \_\_\_\_\_ MODEL NO.: \_\_\_\_\_ SERIAL NO: \_\_\_\_\_

INSTALLER (to be completed by installer)

COMPANY or TRADING NAME: \_\_\_\_\_

LICENCE NO.: \_\_\_\_\_

CONTACT NAME: \_\_\_\_\_

PHONE NO: \_\_\_\_\_

DATE OF INSTALLATION: \_\_\_\_\_

### HOTPOINT WINDOW AIR CONDITIONER WARRANTY COVERAGE

- To guarantee operation of this unit correctly and safely, please read the operation manual carefully before using. Retain this manual for future reference.
- The air conditioning unit **MUST** be installed by a licensed installer to ensure safety and avoid warranty exclusions.
- Product which has had the serial no. removed, made illegible or original components have been altered or replaced will not be covered under warranty.
- Warranty does not cover any transportation costs.
- If outside the metropolitan area or more than 35 kilometres from a HOTPOINT authorised service centre a traveling time or mileage charge may be applicable.
- The normal warranty on this product in domestic use is TWO (2) years (parts & labour).
- Remote Control is covered for TWELVE (12) months only.
- If this product is used for other than domestic purposes then the warranty provisions do not apply and warranty is limited to TWELVE (12) months only (parts and labour).
- Should the product appear to be faulty, then first consult the fault finding chart as mentioned above. If the fault is due to installation, contact installer, otherwise contact Hotpoint for service. If a Hotpoint Service Technician is called and the fault is found to be a result of incorrect installation or if it is found that the customer is not using the air conditioner correctly and is causing the fault, then a callout fee will be charged to the customer.
- Service will not normally be provided to a unit installed more than TWO (2) meters above floor/ground level. If service is provided then a fee will be charged.
- The air conditioner must have easy access otherwise warranty may be voided or any equipment to be hired by Hotpoint to access the unit will be at the expense of the customer.

NATIONAL SERVICE NUMBER – 1300 303 929

Hotpoint (Aust) Pty Ltd

ABN 68 082 599 086



## **PROBLEMS THAT MAY NOT BE COVERED UNDER WARRANTY**

Hotpoint (Aust) Pty Ltd reserves the right to refuse warranty if reported problems arise from situations outside their control. For example:

1. Systems of inappropriate capacity for area(s) served, e.g. not sized by a method accepted as normal trade practice.
2. Systems of inappropriate 'type' for application concerned.
3. Systems with incorrect refrigerant charge, either from installation/commissioning stage or leakage from field-installed pipe-work or connections.
4. Systems with incorrect pipe-work sizes, as per installation manual.
5. Systems with excessive pipe-work length or vertical risers, as per installation manual.
6. Incomplete pipe-work insulation-gaps. i.e. not vapor sealed.
7. Poorly constructed condensate drains, under-sized tubing, lack of fall, ineffective 'trap' lack of support etc.....
8. Poorly mounted units causing:
  - Restricted access for repairs, e.g. indoor/outdoor unit mounted in a manner that prevents removal of top cover, as per installation manual.
  - Vibration or noise, e.g. equipment not mounted/installed by a method accepted as normal trade practice.
9. Inadequate electrical installation, wrong wiring sizes, e.g. not compliant with current Electrical Regulations and/or installation manual.
10. Equipment that has been modified without agreement with HOTPOINT.
11. Equipment not commissioned by person with adequate trade knowledge or experience. Costs related to visits made to this equipment will be invoiced to the dealer concerned.

