



Hardware Reference Guide

For Thin Clients

Document Part Number: 254241-001

July 2002

This book provides basic hardware information for this series of Compaq Thin Clients.

© 2002 Compaq Information Technologies Group, L.P.

Compaq, the Compaq logo, and Evo are trademarks of Compaq Information Technologies Group, L.P. in the U.S. and/or other countries.

Microsoft, MS-DOS, Windows, and Windows NT are trademarks of Microsoft Corporation in the U.S. and/or other countries.

All other product names mentioned herein may be trademarks of their respective companies.

Compaq shall not be liable for technical or editorial errors or omissions contained herein. The information is provided “as is” without warranty of any kind and is subject to change without notice. The warranties for Compaq products are set forth in the express limited warranty statements accompanying such products. Nothing herein should be construed as constituting an additional warranty.



WARNING: Text set off in this manner indicates that failure to follow directions could result in bodily harm or loss of life.



CAUTION: Text set off in this manner indicates that failure to follow directions could result in damage to equipment or loss of information.

Hardware Reference Guide
First Edition July 2002
Document Part Number: 254241-001

Contents

1 Product Features

Standard Thin Client Features	1-1
Rear Panel Components	1-2
T1010 Rear Panel Components	1-2
T20 Rear Panel Components	1-3
T30 Rear Panel Components	1-4
System Board Components	1-5
T1010 System Board Components	1-5
T20 System Board Components	1-6
T30 System Board Components	1-7
Using the Keyboard	1-8
Windows Logo Key	1-9
Special Mouse Functions	1-10
Serial Number Location	1-10

2 Hardware Upgrades

General Hardware Installation Sequence	2-1
Locating the Power On Switch	2-3
Gaining Access to the Thin Client System Board	2-4
Accessing the T20 System Board	2-4
Accessing the T30 System Board	2-5
Installing Thin Client Options	2-6
Flash Memory Installation	2-6
T20 Flash Memory Installation	2-6
T30 Flash Memory Installation	2-7
SODIMM Installation	2-9
PCMCIA Wireless Card Installation	2-10
Accessing the T1010 PCMCIA Slot	2-10
Accessing the T30 PCMCIA Slot	2-11

A Specifications

B Security Provisions

Securing the Thin Client B-1
 Securing a T20 Thin Client..... B-1
 Securing a T20 with a Security Bracket and Cable Lock B-1
 Securing a T30 Thin Client with a Cable Lock B-3

C Electrostatic Discharge

Preventing Electrostatic Damage C-1
Grounding Methods..... C-2

D Routine Thin Client Care and Shipping Preparation

Routine Thin Client Care D-1
Shipping Preparation..... D-2
Important Service Repair Information D-2

Product Features

Standard Thin Client Features

The Compaq Thin Clients T1010, *Evo*TM T20, and Evo T30 are Windows-based Terminals (WBTs) that connect over a network to a Windows NT Server running Windows 2000 or Windows NT Terminal Server Edition or either of these operating systems with Citrix MetaFrame software running atop the server operating system.

Thin Client features vary depending on your model. The following sections will review the individual features of each of these systems. For a complete listing of the hardware and software installed on your Thin Client visit <http://www.compaq.com/products/thinclients/index.html> and search for your specific Thin Client model.

The following features are common to all three Thin Clients:

- No moving parts
- No hard drives or floppy drives
- Limited expandability
- 15-minute setup time
- One-stop shopping for servers, clients, monitors, and peripherals
- Free firmware upgrades for the life of the device which enables IT managers to be current with the latest technology
- Central deployment and management with the Rapport Administrative Software for Compaq Thin Clients



Your purchase of a Compaq Thin Client entitles you to the Workgroup Edition of Rapport Administrative Software for Compaq Thin Clients. To order your CD, free of charge, visit the Compaq website at <http://www.compaq.com/products/thinclients/rapport> and follow the instructions.

Rear Panel Components

The rear panel components vary depending on the Thin Client model. See the appropriate sections that follow for information on your specific model.

T1010 Rear Panel Components

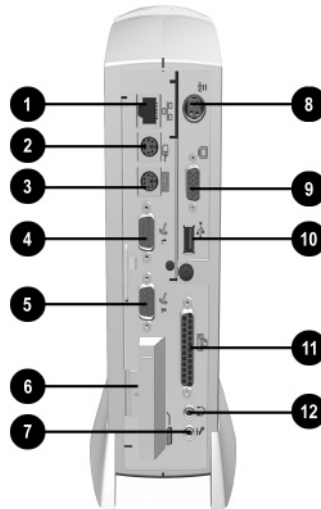

① Ethernet RJ-45 Connector	⑦ Line-in Audio Connector (Microphone)
② Mouse Connector	⑧ Power Cord Connector
③ Keyboard Connector	⑨ Monitor Connector
④ Serial Connector (COM1)	⑩ Universal Serial Bus (USB) Connector
⑤ Serial Connector (COM2)	⑪ Parallel Connector
⑥ PCMCIA Option Slot	⑫ Line-out Audio (Headphone) Connector

T20 Rear Panel Components

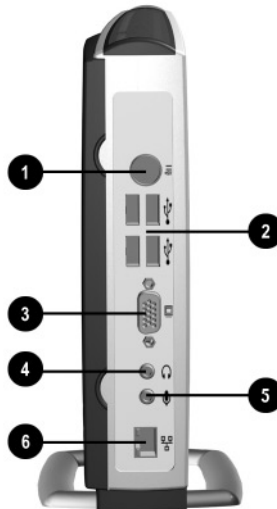

❶ Power Cord Connector	❷ Line-out Audio Connector
❸ Four USB Connectors	❹ Line-in Audio Connector
❺ Monitor Connector	❻ Ethernet RJ-45 Connector

T30 Rear Panel Components

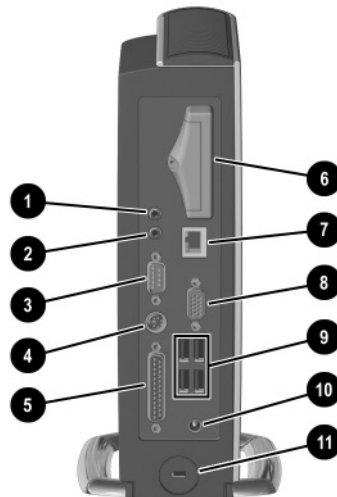

❶ Line-in Audio (Microphone) Connector	❷ Ethernet RJ-45 Connector
❸ Line-out Audio (Headphone) Connector	❸ Monitor Connector
❹ Serial Connector (COM1)	❹ USB Connectors
❺ Keyboard/Mouse Connector	❺ Power Cord Connector
❻ Parallel Connector	❻ Security Cable Lock Slot
❼ PCMCIA Option Slot	



CAUTION: The power cord connector is for use only with the supplied power adaptor. Replace only with the same or equivalent type as recommended by the manufacturer.

System Board Components

The system board components for Thin Clients will vary depending on your model. See the following sections for the system board information for your specific model.

T1010 System Board Components

The T1010 system board houses the SODIMM memory module ❶.

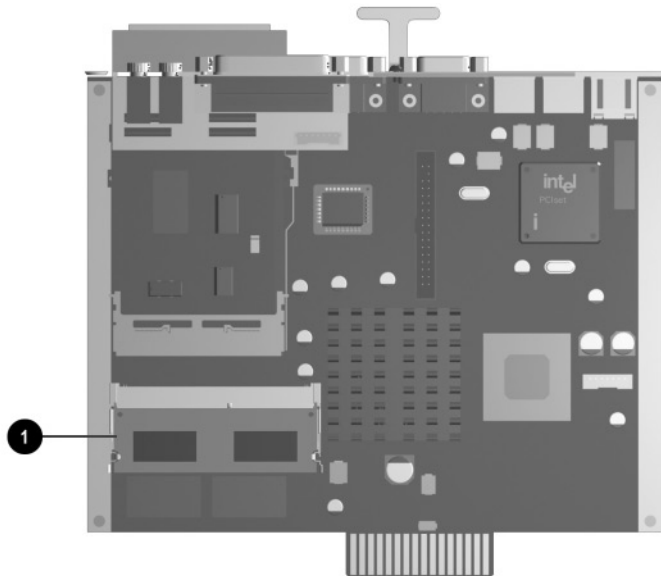

The T1010 Thin Client is not flash or DRAM memory upgradeable.

T20 System Board Components

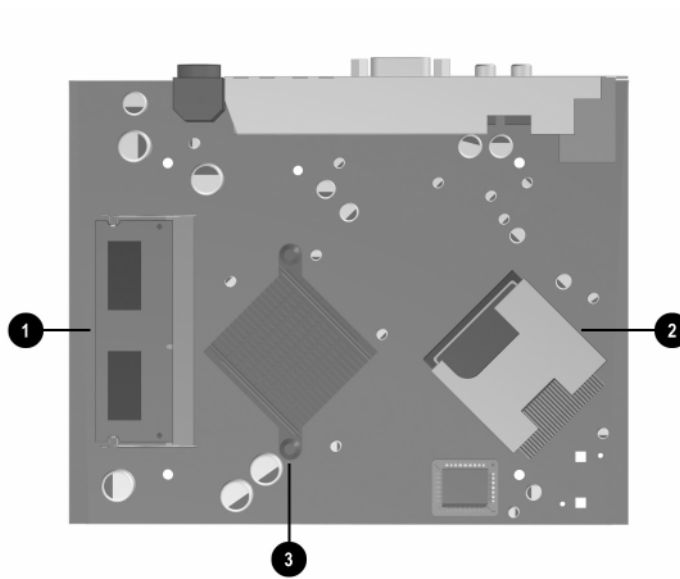

-
- | | |
|-----------------------|-------------|
| ❶ Memory | ❸ Processor |
| ❷ Flash Memory Module | |
-

T30 System Board Components

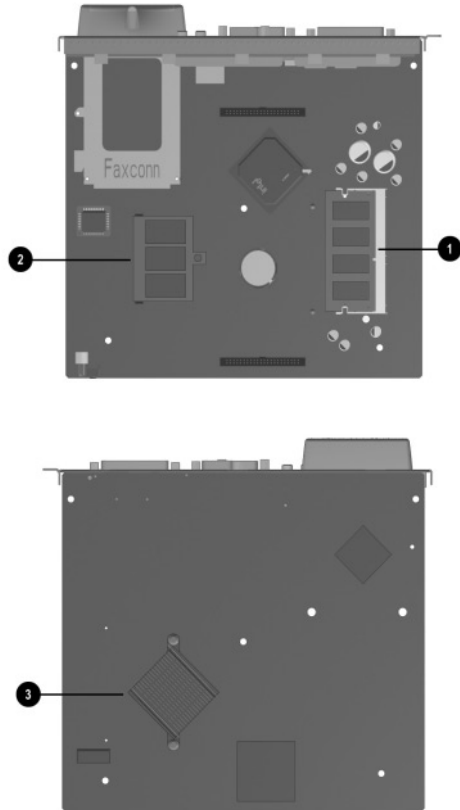

❶ SODIMM Memory

❸ Processor

❷ IDE Flash Memory
(may vary by model)

Using the Keyboard

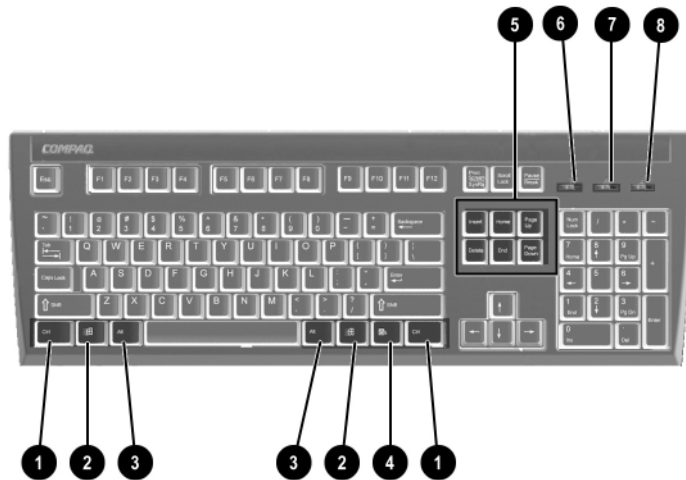

Compaq Enhanced Keyboard Components

- | | |
|---------------------|--|
| ❶ Ctrl Key | Used in combination with another key; its effect depends on the application software you are using. |
| ❷ Windows Logo Key* | Used to open the Start menu in Microsoft Windows. Used in combination with other keys to perform other functions. (See following section.) |
| ❸ Alt Key | Used in combination with another key; its effect depends on the application software you are using. |
| ❹ Application Key* | Used (like the right mouse button) to open pop-up menus in a Microsoft Office application. May perform other functions in other software applications. |

*Keys available in select geographic regions.

Compaq Enhanced Keyboard Components (*Continued*)

⑤ Editing Keys	Includes the following: Insert, Home, Page Up, Delete, End, and Page Down.
	 Holding down Ctrl and Alt while pressing Delete allows you to restart your Thin Client.
⑥ Num Lock light	Indicates whether the Num Lock feature is on or off.
⑦ Caps Lock light	Indicates whether the Caps Lock feature is on or off.
⑧ Scroll Lock light	Indicates whether the Scroll Lock feature is on or off.

Windows Logo Key

Use the Windows Logo Key in combination with other keys to perform certain functions available in the Windows operating systems.

Windows Logo Key + F1	Displays a pop-up menu for the selected object
Windows Logo Key + Tab	Activates the next Taskbar button
Windows Logo Key + e	Launches Explore My Computer
Windows Logo Key + f	Launches Find Document
Windows Logo Key + Ctrl + f	Launches Find Computer
Windows Logo Key + m	Minimizes all open applications
Shift + Windows Logo Key + m	Undoes Minimize All
Windows Logo Key + r	Displays the Run dialog box

Special Mouse Functions

Most software applications support the use of a mouse. The functions assigned to each mouse button depend on the software applications you are using.



Some models ship with a USB scroll mouse.

Serial Number Location

Each Thin Client has a unique serial number which is located on the bottom of the Thin Client. Keep this number available for use when contacting Compaq customer service for assistance.

Hardware Upgrades

General Hardware Installation Sequence

To ensure the proper installation of any Thin Client hardware option:

1. Back up any data if necessary.
2. If the Thin Client is on:
 - a. Shut the unit down.
 - b. Turn the unit and any other attached devices off. See the section “Locating the Power On Switch” later in this chapter to locate the power on/off switch on your Thin Client.
 - c. Disconnect the power cord from the wall outlet.
 - d. Disconnect any external devices or cables.



WARNING: To reduce the risk of personal injury from electrical shock and/or hot surfaces, be sure to disconnect the power cord from the wall outlet and allow the internal system components to cool before touching.



WARNING: To reduce the risk of electrical shock, fire, or damage to the equipment, do not plug telecommunications or telephone connectors into the network interface controller (NIC) receptacles.



CAUTION: Static electricity can damage the electronic components of the Thin Client or optional equipment. Before beginning these procedures, ensure that you are discharged of static electricity by briefly touching a grounded metal object. See Appendix C, “Electrostatic Discharge,” for more information.

3. Access the Thin Client system board.



See the section “Gaining Access to the Thin Client System Board” for more information on how to access the system board.

4. Remove, if necessary, any hardware that will be replaced.

5. Install any optional equipment.



Many of the instructions for installing Thin Client options can be found and downloaded from the Compaq website at <http://www.compaq.com>.

6. Replace the Thin Client’s side access cover.

7. Reconnect any external devices and power cords.

8. Turn on the monitor, the Thin Client, and any devices you want to test.

9. Load any necessary drivers.



Many of the drivers necessary for installing optional Thin Client hardware can be found and downloaded from the Compaq website at <http://www.compaq.com>.

10. Reconfigure the Thin Client, if necessary.

Locating the Power On Switch

The location of the power on switch varies according to your Thin Client model. See the following illustration for the location of the power on switch ❶ on your specific Thin Client.



WARNING: To reduce the risk of electrical shock, make sure your Thin Client is powered off and disconnected from the power outlet prior to installing any components.

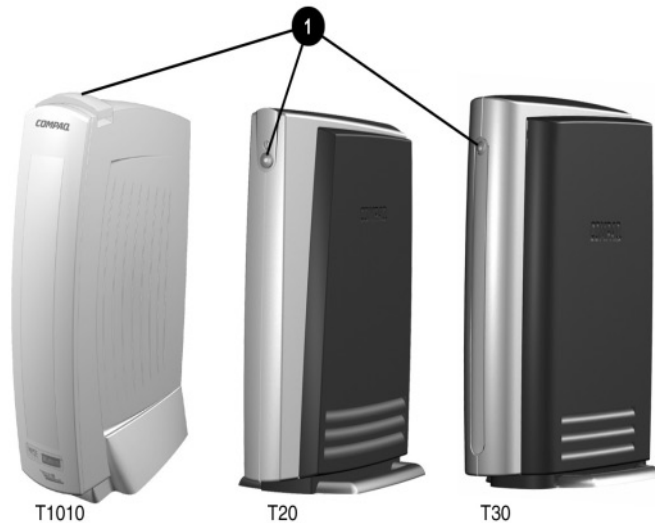

Power on switch location

Gaining Access to the Thin Client System Board

To install internal hardware options, the system board must be accessed. See the following sections to determine how to access the system board of your Thin Client.



WARNING: Before accessing the system board, ensure that the Thin Client is turned off and that the power cord is disconnected from the electrical outlet.



The T1010 Thin Client is not flash or DRAM memory upgradeable. So, under these circumstances you would not need to access the T1010 system board.

Accessing the T20 System Board



WARNING: Before removing the side access panel, ensure that the Thin Client is turned off and that the power cord is disconnected from the electrical outlet.

To gain access to the T20 system board:

1. Press outward on the thumb latches ❶.
2. Slide the panel back ❷, as shown in the following illustration.

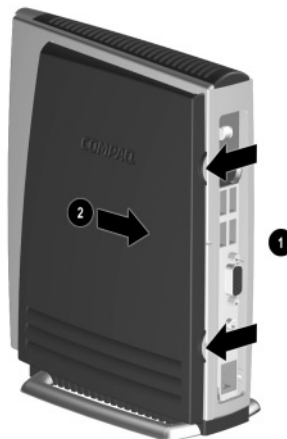

Removing the T20 Side Access Panel

Accessing the T30 System Board



WARNING: Before removing the side access panel, ensure that the Thin Client is turned off and that the power cord is disconnected from the electrical outlet.

To access the T30 system board:

1. Remove the security cable lock, if installed. See the security cable lock instructions for information on how to remove the lock.
2. Remove the screw ❶ from the back panel next to the PCMCIA slot cover.
3. Slide the side access panel straight back ❷ as shown in the following illustration.

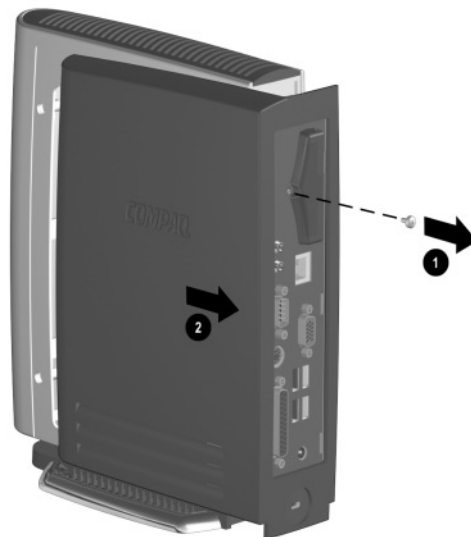

Removing the T30 Side Access Panel

Installing Thin Client Options

There are several options available for installation on Compaq Thin Clients such as flash memory, SODIMM, PCMCIA, and security hardware (see Appendix B for security hardware). Not all Thin Clients support the same options. Visit the Compaq website at <http://www.compaq.com/products/thinclients/options/index.html> to see what options are supported on your Thin Client, to order your available options, and to download the complete installation instructions for your options.

The following sections contain some general installation instructions for some of the available options. In all cases, see the specific installation instructions applicable to the Thin Client option.

Flash Memory Installation

If your Thin Client can be upgraded with the optional flash memory, use the following instructions as an overview of this procedure.



CAUTION: If necessary, back up any data before continuing the installation.



In addition to following these instructions, follow the detailed instructions that accompany the flash memory you have purchased. These instructions are available for download from the Compaq website.

T20 Flash Memory Installation

1. Follow the applicable instructions in the “General Hardware Installation Sequence” section at the beginning of this chapter.
2. Access the Thin Client system board.
3. Remove any existing flash memory if installed.

4. Insert the new flash memory with the membrane circuitry facing down as shown in the following illustration.

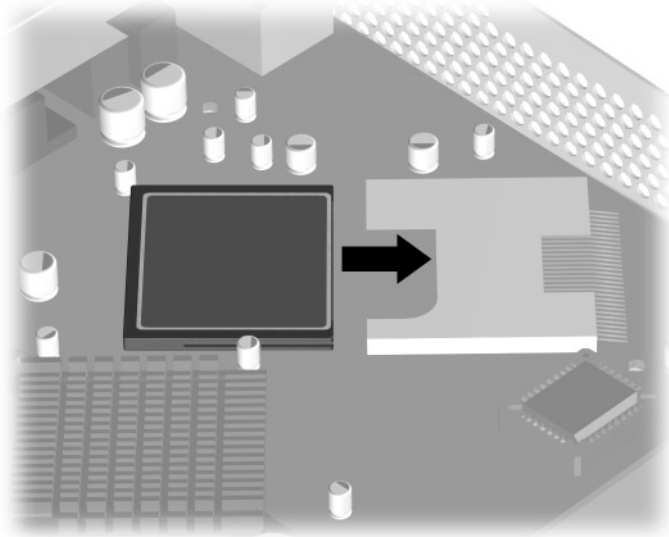

Installing optional flash memory (T20 model shown)

5. Attach the side access panel.
6. Power up the Thin Client.
7. Upgrade the Thin Client firmware if necessary.

T30 Flash Memory Installation

The T30 Thin Client can be upgraded with two physically different types of flash. Use these steps as a general installation overview. Refer to the documentation included in your flash memory option kit for detailed instructions on installing T30 flash memory.

1. Follow the applicable instructions in the “General Hardware Installation Sequence” section at the beginning of this chapter.
2. Access the Thin Client system board.
3. Remove any existing flash memory if installed.

4. Verify the location of pin 1 on your Flash Memory card and align it with the pin 1 marker shown on the system board.
5. Insert the new flash memory as shown in the following two illustrations.

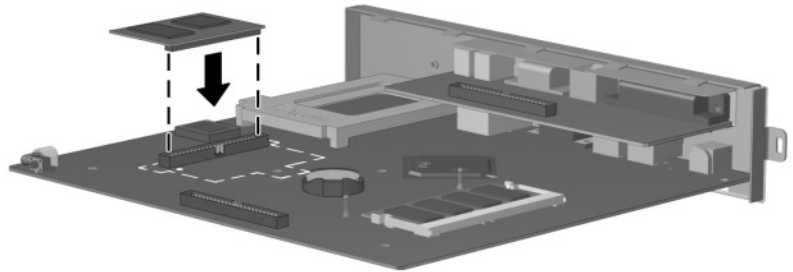

Type One

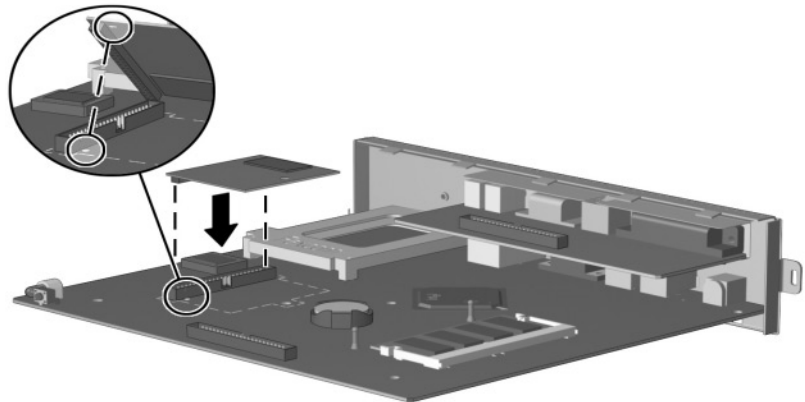

Type Two

6. Attach the side access panel.
7. Power up the Thin Client.
8. Upgrade the Thin Client firmware if necessary.

SODIMM Installation

If your Thin Client can be upgraded with optional SODIMM memory, use the following instructions for an overview of this procedure.



CAUTION: If necessary, back up any data before continuing the installation.



In addition to following these instructions, follow the instructions that are applicable to your specific Thin Client option.

1. Follow the applicable instructions in the “General Hardware Installation Sequence” section at the beginning of this chapter.
2. Access the Thin Client system board.
3. Remove any existing SODIMM if installed.
4. Install the module into the socket at a 45° angle **1** until it clicks, then snap the module **2** into position as shown.

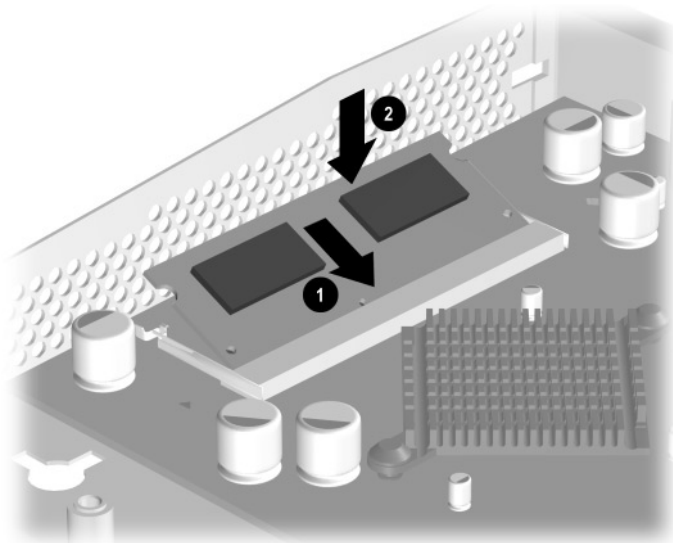

Installing an optional SODIMM (T20 model shown)

5. Attach the side access panel.
6. Power up the Thin Client.

PCMCIA Wireless Card Installation

If your Thin Client supports an optional PCMCIA wireless card, follow the Thin Client-related instructions included in the Compaq option kit. Compaq also supports several third-party wireless cards. Visit <http://www.compaq.com/support/thinclients> for installation instructions.

In order to use an optional PCMCIA wireless card, it is necessary to remove the PCMCIA slot cover located on the back of your Thin Client. See the following sections for the instructions applicable to your Thin Client.

Accessing the T1010 PCMCIA Slot

To access the T1010 PCMCIA slot, perform the following:

1. Remove the screw ❶ as shown in the following illustration.
2. Rotate the cover ❷ as shown.

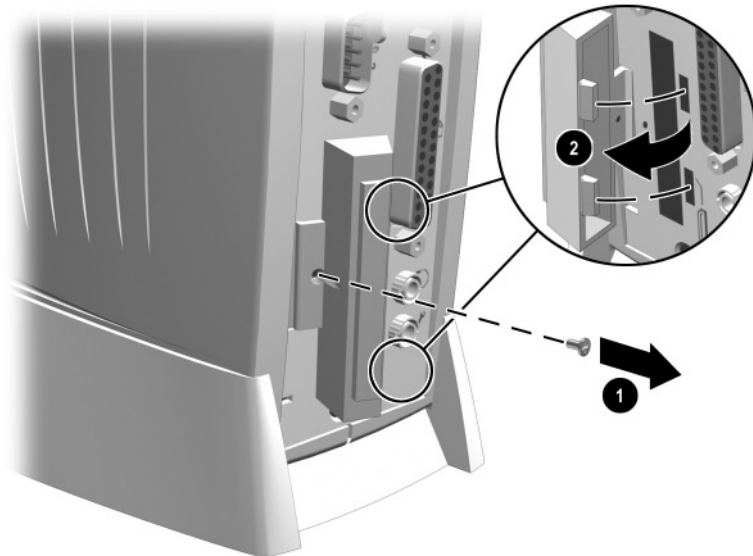

Accessing the T1010 PCMCIA slot



You will not be able to close the slot cover after a PCMCIA card is installed.

Accessing the T30 PCMCIA Slot

To access the T30 PCMCIA slot, perform the following:

1. Remove the screw ❶ as shown in the following illustration.



This screw must be removed in order to pry open the PCMCIA slot cover.

2. Remove the slot cover ❷ by prying it open with your fingers or a small flathead screwdriver until it pops loose.

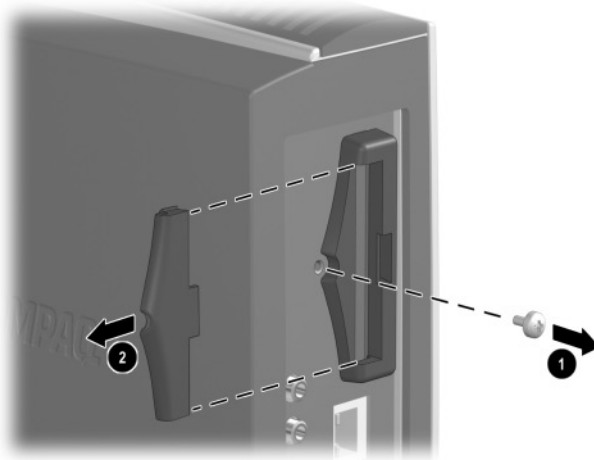

Accessing the T30 PCMCIA slot

Specifications

Compaq Thin Client T1010

Dimensions		
Height	8.9 in	22.6 cm
Width	3.9 in	9.9 cm
Depth	6.9 in	17.5 cm
<hr/>		
Approximate Weight	12.5 lb	5.5 kg
<hr/>		
Temperature Range (fanless design)		
Operating	32° to 104° F	0° to 40° C
Nonoperating	14° to 140° F	-10° to 60° C
<hr/>		
Relative Humidity (non-condensing)	20–80%	20–80%
<hr/>		
Maximum Altitude (unpressurized)		
Operating	10,000 ft	3048 m
Nonoperating	40,000 ft	12192 m
<hr/>		
Power Supply		
Operating Voltage Range	90–264 VAC	90–264 VAC
Rated Line Frequency	47–63 Hz	47–63 Hz
<hr/>		
Power Output (maximum)	20 W	20 W
<hr/>		
Rated Input Current (maximum)	4.0 A	4.0 A
<hr/>		
Heat Dissipation		
On	453.3 BTU/hr	114.2 kg-cal/hr
Suspend	444.3 BTU/hr	111.9 kg-cal/hr
Off	228.9 BTU/hr	57.7 kg-cal/hr

Compaq Evo Thin Client T20

Dimensions		
Height	8.4 in	21.3 cm
Width	3.6 in	9.1 cm
Depth	7.7 in	19.5 cm
Approximate Weight		
	3.0 lb	1.4 kg
Temperature Range		
Operating	32° to 104° F	0° to 40° C
Nonoperating	14° to 140° F	-10° to 60° C
Relative Humidity (noncondensing)		
Operating	10–90%	10–90%
Nonoperating	10–95%	10–95%
Maximum Altitude (unpressurized)		
Operating	10,000 ft	3048 m
Nonoperating	40,000 ft	12192 m
Power Supply		
Operating Voltage Range	90–265 VAC	90–265 VAC
Rated Line Frequency	47–63 Hz	47–63 Hz
Power Output (maximum)		
	18 W	18 W
Rated Input Current (maximum)		
	1.5 A	1.5 A
Heat Dissipation		
On	350.1 BTU/hr	88.2 kg-cal/hr
Suspend	345.6 BTU/hr	87.1 kg-cal/hr
Off	228.9 BTU/hr	27.7 kg-cal/hr

Compaq Evo Thin Client T30

Dimensions		
Height	10.2 in	26.0 cm
Width	2.7 in	7.0 cm
Width (foot/base)	4.6 in	11.75 cm
Depth	8.5 in	21.6 cm
<hr/>		
Approximate Weight	4.6 lb	2.1 kg
<hr/>		
Temperature Range		
Operating	32° to 104° F	0° to 40° C
Nonoperating	-40° to 140° F	-40° to 60° C
<hr/>		
Relative Humidity (noncondensing)		
Operating	10–90%	10–90%
Nonoperating	10–95%	10–95%
<hr/>		
Maximum Altitude (unpressurized)		
Operating	10,000 ft	3048 m
Nonoperating	40,000 ft	12192 m
<hr/>		
Power Supply		
Operating Voltage Range	90–132 VAC	180–265 VAC
Rated Voltage Range	100–120 VAC	200–240 VAC
Rated Line Frequency	50–60 Hz	50–60 Hz
<hr/>		
Power Output	40 W	40 W
<hr/>		
Rated Input Current (maximum)	1.5 A	1.0 A
<hr/>		
Heat Dissipation		
Maximum	136.6 BTU/hr	34.4 kg-cal/hr
Nominal	53.3 BTU/hr	13.4 kg-cal/hr

Security Provisions

Securing the Thin Client

The T20 and T30 Thin Clients are designed or can be set up to accept a security cable lock. See the following sections for instructions on securing your specific Thin Client.

Securing a T20 Thin Client

The T20 Thin Client can be secured in two ways:

- An optional bracket and cable lock can be added.
- The unit can be secured to a tabletop or counter.

Securing a T20 with a Security Bracket and Cable Lock

A separate security bracket option and cable lock option are available for the T20. This bracket, which attaches to the T20, combined with the cable lock, prevent the outside access panel from being removed. To order these options and to download the installation instructions for these options, visit the Compaq website at <http://www.compaq.com/products/thinclients/options/index.html>.

Securing a T20 to a Tabletop or Counter

The T20 Thin Client can be secured to a tabletop or workspace counter to prevent the unit from being moved. To secure the Thin Client:



This procedure requires you to remove the base screws from the T20 Thin Client and replace two of them with longer screws. Before beginning the procedure, locate two screws of the same thread as the screws you are replacing. These new screws should be long enough to go through the tabletop or counter, through the base, and back into the Thin Client.

1. Remove the base of the Thin Client by unscrewing the four screws at the bottom that secure the base to the unit.
2. Use the base of the Thin Client as a guide for pre-drilling two holes on the tabletop or counter as shown in the following illustration.

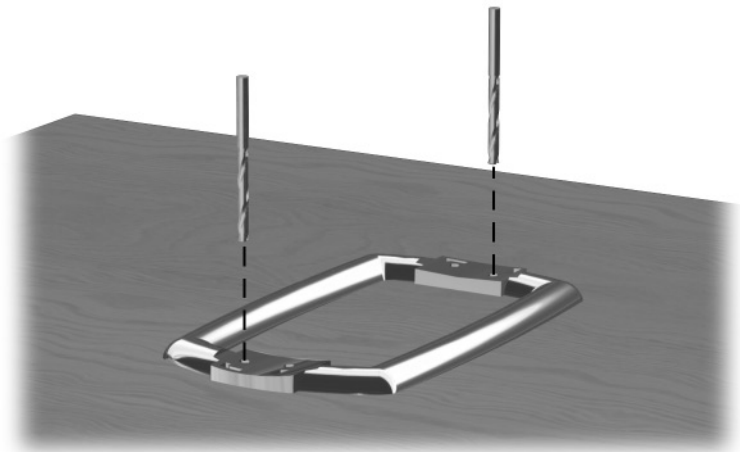

Pre-drilling the screw holes

3. Attach the base back to the Thin Client using only the two screws that will not be used in securing the unit to the table.
4. Using the two new screws (not included), attach the unit to the tabletop or counter as shown in the following illustration.

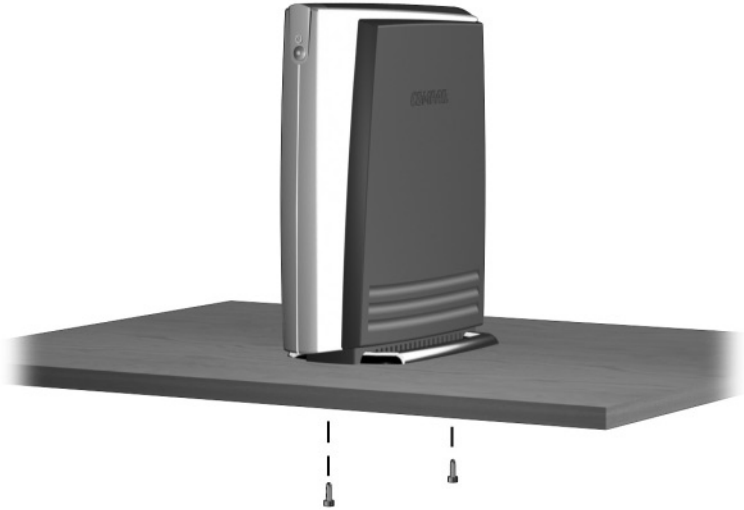

Attaching the T20 to a tabletop

Securing a T30 Thin Client with a Cable Lock

The rear of the T30 Thin Client is designed with a built-in cable lock slot. See Chapter 1, “Product Features,” for the location of this slot. The cable lock is available as an option. To order this option and to download the installation instructions for this option, visit the Compaq website at <http://www.compaq.com/products/thinclients/options/index.html>.

Electrostatic Discharge

A discharge of static electricity from a finger or other conductor may damage system boards or other static-sensitive devices. This type of damage may reduce the life expectancy of the device.

Preventing Electrostatic Damage

To prevent electrostatic damage, observe the following precautions:

- Avoid hand contact by transporting and storing products in static-safe containers.
- Keep electrostatic-sensitive parts in their containers until they arrive at static-free workstations.
- Place parts on a grounded surface before removing them from their containers.
- Avoid touching pins, leads, or circuitry.
- Always be properly grounded when touching a static-sensitive component or assembly.

Grounding Methods

There are several methods for grounding. Use one or more of the following methods when handling or installing electrostatic-sensitive parts:

- Use a wrist strap connected by a ground cord to a grounded Thin Client chassis. Wrist straps are flexible straps with a minimum of 1 megohm +/- 10 percent resistance in the ground cords. To provide proper grounding, wear the strap snug against the skin.
- Use heelstraps, toestraps, or bootstraps at standing workstations. Wear the straps on both feet when standing on conductive floors or dissipating floor mats.
- Use conductive field service tools.
- Use a portable field service kit with a folding static-dissipating work mat.

If you do not have any of the suggested equipment for proper grounding, contact your Compaq authorized dealer, reseller, or service provider.



For more information on static electricity, contact your Compaq authorized dealer, reseller, or service provider.

Routine Thin Client Care and Shipping Preparation

Routine Thin Client Care

Follow these suggestions to take care of your Thin Client:

- Operate the Thin Client on a sturdy, level surface. Leave a 3-inch (7.6-cm) clearance around the air vents to permit the required airflow.
- Never operate the Thin Client with the outside panel removed.
- Never restrict the airflow into the Thin Client by blocking the vents or air intake.
- Keep the Thin Client away from excessive moisture, direct sunlight, and extremes of heat and cold. For information about the recommended temperature and humidity ranges for your Thin Client, see Appendix A, “Specifications,” in this guide.
- Keep liquids away from the Thin Client and keyboard.
- Turn off the Thin Client before you do either of the following:
 - ❑ Wipe the exterior of the Thin Client with a soft, damp cloth as needed. Using cleaning products may discolor or damage the finish.
 - ❑ Occasionally clean the air vents of the Thin Client. Lint and other foreign matter can block the vents and limit the airflow.

Shipping Preparation

Follow these suggestions when preparing to ship your Thin Client:

1. Turn off the Thin Client and external devices.
2. Disconnect the power cord from the electrical outlet, then from the Thin Client.
3. Disconnect the system components and external devices from their power sources, then from the Thin Client.
4. Pack the system components and external devices in their original packing boxes or similar packaging with sufficient packing material to protect them.



For environmental nonoperating ranges, see Appendix A, “Specifications,” in this guide.

Important Service Repair Information

In all cases, remove and safeguard all external options before returning the Thin Client to Compaq for repair or exchange.

In countries that support customer mail-in repair by returning the same unit to the customer, Compaq makes every effort to return the repaired Thin Client with the same internal memory and flash modules that were sent.

In countries that do not support customer mail-in repair by returning the same unit to the customer, all internal options should be removed and safeguarded in addition to the external options. The Thin Client should be restored to the original configuration before returning it to Compaq for repair.