

Getting Started

The only warranties for Hewlett-Packard products and services are set forth in the express statements accompanying such products and services. Nothing herein should be construed as constituting an additional warranty. HP shall not be liable for technical or editorial errors or omissions contained herein.

HP assumes no responsibility for the use or reliability of its software on equipment that is not furnished by HP.

This document contains proprietary information that is protected by copyright. No part of this document may be photocopied, reproduced, or translated to another language without the prior written consent of HP.

Hewlett-Packard Company
P.O. Box 4010
Cupertino, CA 95015-4010
USA

Copyright © 2000–2006 Hewlett-Packard Development Company, L.P.

May be licensed in the United States by one or both of U.S. Patents Nos. 4,930,158 and 4,930,160 until August 28, 2008.

Microsoft and Windows Vista are U.S. registered trademarks of Microsoft Corporation.

The Windows logo and Windows Vista are trademarks or registered trademarks of Microsoft Corporation in the United States and/or other countries/regions.

HP supports lawful use of technology and does not endorse or encourage the use of our products for purposes other than those permitted by copyright law.

The information in this document is subject to change without notice.

Table of Contents

Setting Up Your Computer	1
Putting Your Computer Together	1
Placing the computer in the proper location	1
Using surge protection	2
Connecting to the computer	2
Connecting a Digital Camera (Photo or Video).....	8
Connecting Other Devices	9
Storing Documentation and Recovery Discs.....	10
Adjusting the Monitor.....	10
Setting Up a Local Area Network	10
Setting Up a Wired (Ethernet) Connection	12
Integrated Wireless Devices.....	12
Connecting the Wireless LAN Device.....	13
Checking the wireless LAN device installation	14
Using wireless security features	14
Connecting a Modem	15
Connecting Speakers or Microphone	17
Using Speakers	17
Sound Connector Types	18
Connecting a Microphone.....	20
Speaker Configurations.....	20
Speaker types	21
Connecting 2/2.1 (Two Speakers and a Subwoofer) Audio Speakers.....	22
Connecting 4.1 (Four Speakers and a Subwoofer) Audio Speakers	23
Connecting 5.1 (Five Speakers and a Subwoofer) Audio Speakers.....	24
Connecting 7.1 (Seven Speakers and a Subwoofer) Audio Speakers	26

Connecting the Computer to a Home Audio System	28
Y adapter cables	28
2.1 home stereo installation	29
5.1 home audio installation	30
5.1 home audio installation procedure	30
7.1 home audio installation	32
7.1 home audio installation procedure	33
Connecting Digital Audio	34
Connecting Headphones	36
Using a 2.1 speaker system with headphones	36
Using a 5.1 to 7.1 speaker system with headphones	36
Connecting Speakers Using the Creative Sound Blaster X-Fi Sound Card	36
Connecting the speakers	37
Connecting the FlexiJack connector	38
Getting Help	39
Finding Onscreen Guides	39
Finding Guides on the Web	39
Using the Onscreen Help and Support Center	40
Using the PC Help & Tools Folder	40
Using HP Connections or Compaq Connections	40
Getting messages	41
Turning off messages	41
Reactivating messages	42
Turning On Your Computer for the First Time	43
Using the Computer with Safety and Comfort	43
Protecting Your Computer	43
Using passwords	44
Using antivirus software	45
Using firewall software	46
Installing critical security updates	46
Turning On Your Computer for the First Time	47
Turning Off Your Computer	47
Using Shut Down	48
Using Lock	48
Using sleep mode	48
Using hibernate mode	49
Automatic sleep, hibernate, or away mode	50
Restarting the Computer	50
Connecting to the Internet	51
Signing Up for Software Updates	52
Setting Up User Accounts on Your New Computer	53
Creating passwords	53

Guidelines for Installing Software and Hardware Devices	54
Transferring Files and Settings from Your Old Computer to Your New Computer	55
Using HP Total Care Advisor Software	55
Using the Keyboard	57
Identifying Keyboard Features	57
Alphanumeric keys	57
Function keys	58
Edit keys	58
Arrow keys	58
Numeric keys	59
Keyboard indicators	59
Special keyboard buttons	60
Identifying Special Keyboard Buttons	60
Customizing the keyboard buttons	63
Keyboard Shortcuts	63
Using the Mouse	65
Using the Mouse Buttons	66
Scrolling	66
Autoscrolling	67
Panning	67
Switching Mouse Button Functions	67
Changing Mouse Pointer Speed	68
Using the Windows Media Center Remote Control	69
Remote Control Buttons Overview	70
About the Remote Control	72
Troubleshooting the remote control	73
Remote sensor is not receiving a signal from the remote control	73
Introducing Your Computer Software	75
Learning More About Software	75
Using the Desktop	75
Removing desktop icons	76
Retrieving desktop icons	76
Using the Windows Start Button Menu	76
Using the All Programs menu	76
Organizing your All Programs list	77
Using the Control Panel	77
Resizing Windows	78
Working with Digital Images	78
About the Internet	79

Using a Browser.....	80
Searching the Internet	80
Restricting Internet content.....	81
Using Antivirus Software	81
Configuring and registering Norton Internet Security software	82
Changing the virus scan time for your Norton Internet Security program	82
Sending and Receiving E-Mail.....	83
Using Windows Mail	83
Using the e-mail program provided by your ISP	83
Software Quick Reference Table.....	84
Managing Files	87
Organizing Files with Folders.....	87
Creating Folders.....	88
Moving Files	88
Finding Files	89
Renaming Files.....	89
Deleting Files	90
Retrieving Files from the Recycle Bin	90
Copying Files.....	90
Using a Printer	91
Using CD and DVD Media Drives	93
Using Your CD and DVD Drives	93
Handling CDs and DVDs	93
Inserting and removing CDs and DVDs.....	94
Compatibility Information	95
Disc Features and Compatibility Table	96
Optical Drive Quick Reference Table	97
Using the Memory Card Reader	99
Media Insertion Guide	100
Understanding the Activity Light	103
Formatting a Memory Card	103
Troubleshooting the Memory Card Reader.....	104
Using the HP Personal Media Drive and HP Pocket Media Drive	105
Connecting the Drive	106
Inserting the Drive into an HP drive bay.....	106
Connecting the Drive to a Computer Without a Drive Bay	107
Locating the Drive and Assigning a Drive Letter	108
Using the Drive	109
Transferring files to another computer manually	109
Disconnecting the Drive.....	110
Troubleshooting the HP Media Drive	111

Using Windows Media Center	113
Using Windows Media Center Features	114
The right music for the moment	115
Play Internet radio	115
Share your digital memories	115
Transform your living space into a theater.....	115
Setting Up Windows Media Center	116
Opening Windows Media Center with a mouse.....	116
Windows Media Center menu bars	116
Navigating Windows Media Center	117
Windows Media Center control menu	118
Using Windows Media Center Power Settings	119
Completing the setup wizard steps.....	119
Windows Media Center Start Menu.....	121
Windows Media Center Start menu items	122
Online Media	122
Changing Windows Media Center Settings	122
Windows Media Center Settings categories.....	123
Playing CDs, DVDs, or VCDs	125
Using Music.....	125
Using Music with Windows Media Center	126
Using the music library.....	127
Adding Music to music library.....	127
Adding music files from your hard disk drive.....	127
Adding music files from a CD.....	128
Deleting music files from the music library.....	128
Using supported music file types	129
Playing Music Files in Music	130
Changing the Visualization Settings	131
Playing an album in Music.....	131
Playing a song in Music	132
Creating a Queue in Music	132
Finding and Playing an Album in Music	133
Using Album Details.....	133
Using Search	134
Searching for Music Tracks and Files	134
Creating a Playlist in Music	134
Copying Music Files to CD in Music	136
Using more music	137
Using radio	138
Playing Music CDs	139
Playing CDs with Windows Media Player.....	139

Playing DVDs.....	139
Using country/region codes.....	140
Using DVDs in Windows Media Center.....	140
Playing DVD Movies in Windows Media Center	140
Changing the DVD Settings.....	141
Changing the DVD Movie Language.....	142
Changing DVD Remote Control Options	142
Changing DVD Closed Captioning	143
Changing DVD Audio Settings	144
Playing DVDs with Windows Media Player.....	144
Playing Video CDs (VCDs).....	145
Playing Video CDs (VCDs) with Windows Media Player.....	145
Creating Audio and Data Discs	147
Erasing Rewritable Discs Before Recording	148
Working with Audio CDs	148
Audio CD tips	149
Before you begin creating discs.....	149
Creating audio CDs.....	149
Creating jukebox discs.....	150
Creating video discs	150
Copying a disc	151
Creating data discs.....	152
Creating photo (slide show) discs	152
Making a disc label using LightScribe	153
Making a paper disc label.....	154
Working with Pictures and Videos	155
Working with Digital Images	155
Viewing Pictures in Windows Media Center	156
Adding Pictures in Windows Media Center	156
Adding picture files from your hard disk drive	156
Viewing Your Pictures in Windows Media Center.....	157
Viewing pictures as a slide show	158
Viewing a slide show with music	158
Using supported picture file types in Windows Media Center.....	159
Editing Pictures in Windows Media Center	159
Fixing red eye or contrast	159
Cropping pictures in Windows Media Center	160
Rotating pictures.....	161
Printing Pictures in Windows Media Center	161
Copying Pictures to CDs and DVDs in Windows Media Center	162

Playing Videos in Windows Media Center	162
Playing digital videos.....	163
Using supported video file types	163
Transferring and Recording Video Files	164
Recording analog and digital video files	164
Creating a CD/DVD from Video Files in Windows Media Center.....	164
Creating Movies by Using muvee autoProducer.....	165
Basic Steps to Make a Movie.....	165
Using muvee autoProducer	166
Getting started	166
Capturing video from a digital video camera	168
Adding videos.....	169
Adding pictures.....	170
Adding music.....	171
Selecting the style	171
Changing the settings.....	172
Adding an opening title and closing credits	173
Making the movie.....	173
Previewing the movie	174
Modifying the movie	174
Saving the movie project	175
Recording the movie project to disc	176
Upgrading muvee autoProducer	177
Index.....	179

Setting Up Your Computer



WARNING: The power supply is preset for the country/region in which you purchased your computer. If you move, please check the voltage requirements before plugging your computer into an AC power outlet.



WARNING: Please read “Safety Information” in the *Warranty and Support Guide* before installing and connecting your computer to the electrical power system.

Putting Your Computer Together

Follow the steps on the setup poster to set up your computer. Read the topics in this section to learn more about the location of components and connectors on your computer, and to learn about some setup alternatives.

Look in the computer box for printed details or updates regarding your computer.

Placing the computer in the proper location

When setting up your new computer, place it where ventilation openings are unobstructed. Make sure all connections are secure and all cabling is out of the way. Do not place cables in walkways or where it can be stepped on or damaged from placing furniture on it.

Using surge protection









Help protect your monitor, computer, and accessories by connecting all power cords for your computer and peripheral devices (such as a monitor, printer, or scanner) to a surge protection device such as a power strip with surge protection or an uninterruptible power supply (UPS). Many surge protection devices have surge protection inputs and outputs for modem or telephone lines. Telephone lines are a common path for lightning spikes to get into your system. Some surge protection devices have surge protection for television cable connections as well. Use those if your computer has a television tuner installed.





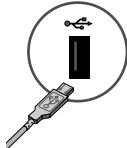

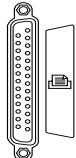





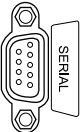

Not all power strips provide surge protection; the power strip must be specifically labeled as having this capability. Use a power strip whose manufacturer offers a damage replacement policy that replaces your equipment if surge protection fails.





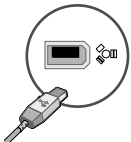



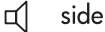





Connecting to the computer











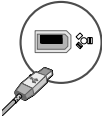

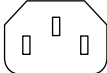
Connect your main hardware devices, such as the monitor, keyboard, and mouse, to the back of the computer. Other peripheral devices, such as a printer, scanner, or camera, also plug into connectors on the back of your computer. Some computers also have connectors on the front of the computer. The table shows some, but not all, connectors.



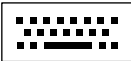
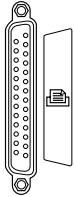

NOTE: The location, availability, and number of connectors on your computer may vary.

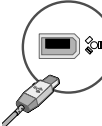







Connector	Icon/label	Description and function
		Mouse (PS/2 connector)
		Keyboard (PS/2 connector)
		Universal Serial Bus (USB) for mouse, keyboard, digital cameras, or other devices with USB connectors
		Printer (parallel)

Connector	Icon/label	Description and function <i>(continued)</i>
		Monitor
	Serial	Serial port for some digital cameras or other serial devices
		Audio Line Out (powered speakers)
		Audio Line In
		Headphones
		Microphone
		FireWire® (IEEE 1394) for video cameras or other devices with very fast transfer rates
	digital audio in out	Digital audio in and digital audio out
		Side speaker out

Connector	Icon/label	Description and function <i>(continued)</i>
	 rear	Rear speaker out
	 c/sub	Center/subwoofer
	S-Video 2	Secondary S-video connector to connect your VCR, video camera, or other analog source to the computer.
	Composite Video 2	Secondary Composite video connector (yellow) to connect to a VCR, video camera, or other analog source to the computer.
	A/V In Audio 2 L	Secondary Left audio input connector (white). NOTE: This Audio In connector is connected to the TV tuner. You must use the Audio In connector, which is connected to the motherboard and located on the back of the computer, to record audio only. (Select models only.)
	A/V In Audio 2 R	Secondary Right audio input connector (red). NOTE: This Audio In connector is connected to the TV tuner. You must use the Audio In connector, which is connected to the motherboard and located on the back of the computer, to record audio only. (Select models only.)
		Headphones Out connector (green) to connect to headphones.
		Microphone In connector (pink) to connect to a microphone.
		Universal Serial Bus (USB) 2.0 connector to connect to a mouse, keyboard, digital camera, or another device with a USB connector.

Connector	Icon/label	Description and function <i>(continued)</i>
		<p>FireWire (IEEE 1394) connector to connect video cameras and other devices with very fast transfer rates.</p> <p>NOTE: You must use a 6-pin FireWire (IEEE 1394) transfer cable with this 6-pin connector.</p>
		Power connector
		Mouse connector to connect a mouse.
		Keyboard connector to connect a keyboard.
		Printer (parallel) connector to connect a parallel printer. (Select models only.)
		Universal Serial Bus (USB) 2.0 connector to connect a mouse, keyboard, digital camera, or another device with a USB connector.
		<p>FireWire (IEEE 1394) connector to connect video cameras and other devices with very fast transfer rates.</p> <p>NOTE: You must use a 6-pin FireWire (IEEE 1394) transfer cable with this 6-pin connector.</p>
	ETHERNET	<p>Ethernet LAN connector is a network interface adapter (also called a network interface card, or NIC) which connects to an Ethernet (10BaseT) or Fast Ethernet (100BaseT) network hub. Connect this adapter in your computer to your local area network (LAN) hub or any broadband connection.</p> <p>The green LED indicates a valid connection.</p>

Connector	Icon/label	Description and function <i>(continued)</i>
		Digital video output connector to connect a TV or monitor. (Select models only.) See the documentation that came with your display device.
		Microphone In (Mic) (pink) to connect to a microphone. The Mic connector also functions as a center/subwoofer Line Out when a multichannel audio configuration is activated.
		Audio Line Out (green) to connect front speakers.
		Audio Line In (blue) connector to connect to an analog audio device such as a CD player for input into computer. The Audio Line In connector also functions as rear Line Out when a multichannel audio configuration is activated.
	Center	Line C/Sub (gold) connector to connect Center/Subwoofer speakers in a multichannel audio configuration.
	Rear	Line Rear (black) connector to connect rear speakers in a multichannel audio configuration.
	Side	Line Side (gray) connector to connect side speakers in an eight-speaker system (7.1).
	S-Video	S-video In connector to connect from a set-top box output connector.
	Composite Video	Composite Video In connector (yellow) to connect to a TV set-top box.
	A/V In Audio 1 L	Primary left audio input from set-top box connector (white). NOTE: Audio can be recorded by using this Audio In connector, which is connected to the motherboard. Some computers include this primary left audio input connector on the front of the computer. (Select models only.)

Connector	Icon/label	Description and function <i>(continued)</i>
	A/V In Audio 1 R	<p>Primary right audio input from set-top box connector (red).</p> <p>NOTE: Audio can be recorded by using this Audio In connector which is connected to the motherboard. Some computers include this primary right audio input connector on the front of the computer. (Select models only.)</p>
	TV/Cable Ant	TV In (TV antenna or cable input from wall outlet with no set-top box.)
	FM Ant	<p>FM In (radio antenna input) connects to the FM antenna cable.</p> <p>Plug the FM radio antenna cable into the FM In port on the back of the computer on the TV tuner card. You may want to extend the ends of the cable to improve your FM radio signal reception.</p>
		<p>Modem (Line In RJ-11) (select models only).</p> <p>Plug the modem cable (provided in the computer box) into the computer modem connector on the back of the computer. Plug the other end to your telephone line wall jack connector.</p>
	Analog Video	Analog Video Out: S-video or composite video (select models only) connects to a TV.
	VGA	Monitor/VGA (blue) display output connector connects to a VGA monitor.
	digital audio in out	<p>Digital audio input (white) connects to a digital audio device with digital input (such as a home audio receiver/amplifier) or digital speakers (select models only).</p> <p>Digital audio output (red) connects to a digital audio device with digital output (select models only).</p>
	Digital Audio Out	Digital Out (orange) connects to a digital audio device with digital input (such as a home audio receiver/amplifier) or digital speakers (select models only).

Connecting a Digital Camera (Photo or Video)

The following instructions apply only to digital photo cameras and digital video cameras.

NOTE: When connecting an analog video camera to the computer, use the Video and Audio In connectors on the front or back of the computer.

Refer to the documentation that came with your digital photo camera or digital video camera.

To connect a digital photo camera or a digital video camera:

- 1 Turn on the computer, and wait for Microsoft® Windows Vista™ operating system to start.

NOTE: If a Digital Video Device Auto Play window appears when you connect your camera, click **Cancel**.

- 2 Connect the 6-pin video camera transfer cable into the camera and then into an open port on the front or back of the computer. Most digital video cameras use either the FireWire (IEEE 1394) port or the USB port.

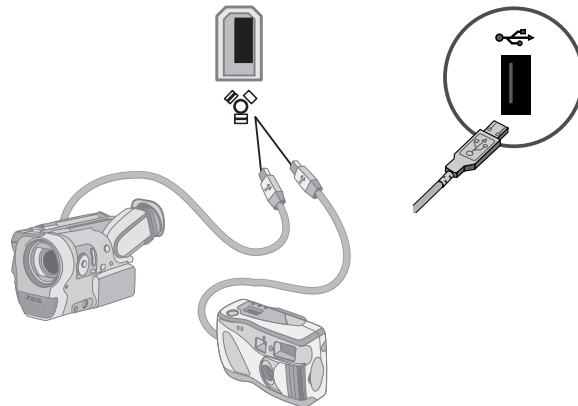

- 3 A *Found New Hardware* message appears. Wait 2 or 3 minutes for Windows Vista to make the necessary settings for the new device. When installation is complete, a message appears indicating the camera is ready to use.

If the computer does not recognize the digital photo camera or the digital video camera:

- 1 Click the **Windows Start Button**[®] on the taskbar, and then click **Control Panel**.
- 2 Click **System and Maintenance**, and then click **System**.
- 3 Click **Device Manager**.
- 4 Click the plus sign (+) next to the camera port. If the name of the camera appears, the device is ready. If the name is not there, try the following:
 - Click **Action**, and then click **Scan for hardware changes**. Look in Device Manager for a new addition under the port.
 - Unplug the video camera transfer cable from the computer, and plug it into a different port. Look in Device Manager for a new addition under the port.



Connecting Other Devices

Other peripheral devices can be connected to the front or back of your computer by using USB or FireWire (IEEE 1394) ports. These peripheral devices include printers, scanners, video cameras, digital photo cameras, memory card readers, and PDAs (personal digital assistant) or handheld computers. Refer to the documentation that came with your device.

NOTE: Some peripheral devices are not included with the computer.

NOTE: You must use a 6-pin (not a 4-pin) FireWire (IEEE 1394) cable with the 6-pin FireWire (IEEE 1394) connector on your computer.

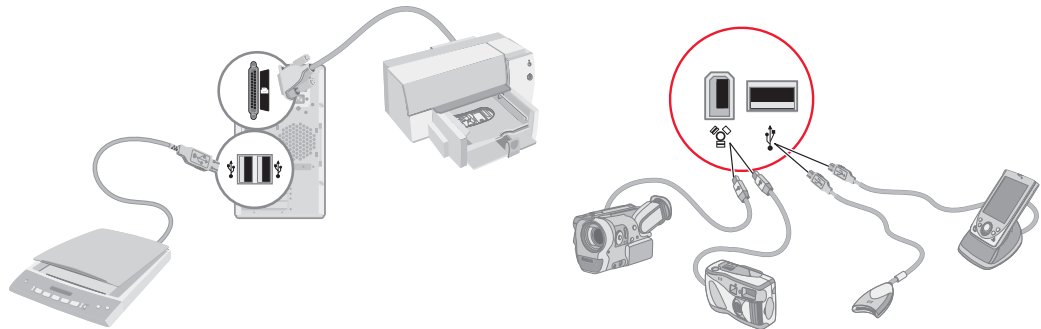

Storing Documentation and Recovery Discs

Store all computer user manuals and warranty information in an easy-to-find, safe location. It is a good idea to store your system recovery discs with your documentation. This allows easy access to all important computer documents and files.

Adjusting the Monitor

To change the screen resolution:

- 1 Right-click an empty area of the desktop, and then click **Personalize**.
- 2 Click the **Display Settings**.
- 3 If necessary, select the monitor, and then adjust the screen resolution.
- 4 Click **Apply**.
- 5 Click **Yes**, if it is present.
- 6 Click **OK**.

NOTE: You can connect more than one display device (CRT monitor, flat panel monitor, TV, and so on) to the computer at a time (select models only). You can quickly change which device displays the computer desktop by pressing Alt+F5. Each time you press Alt+F5, the computer desktop appears on the next device. If pressing Alt+F5 does not work, restart the computer and try again.

Setting Up a Local Area Network

Your home local area network (LAN) may consist of a wired or a wireless network that you can use to connect your computer to other devices on the network, included other computers. The network components may include a hub or a switch, which can connect multiple devices to the network, or a router, which can connect computers or a broadband Internet connection to the network. This network connection also enables you to share data, and printers or other devices among your computers. The network connection to the Internet is usually through a dial-up or cable modem.

A *wired network* uses Ethernet cables to connect the devices on the network. For example, the Ethernet cable plugs into your computer network interface adapter and the router.

A *wireless network* uses radio waves to connect the devices on the network. For example, both your computer and the router have an antenna and adapter that use the same Wi-Fi industry standard: 802.11b, 802.11g, or 802.11a.

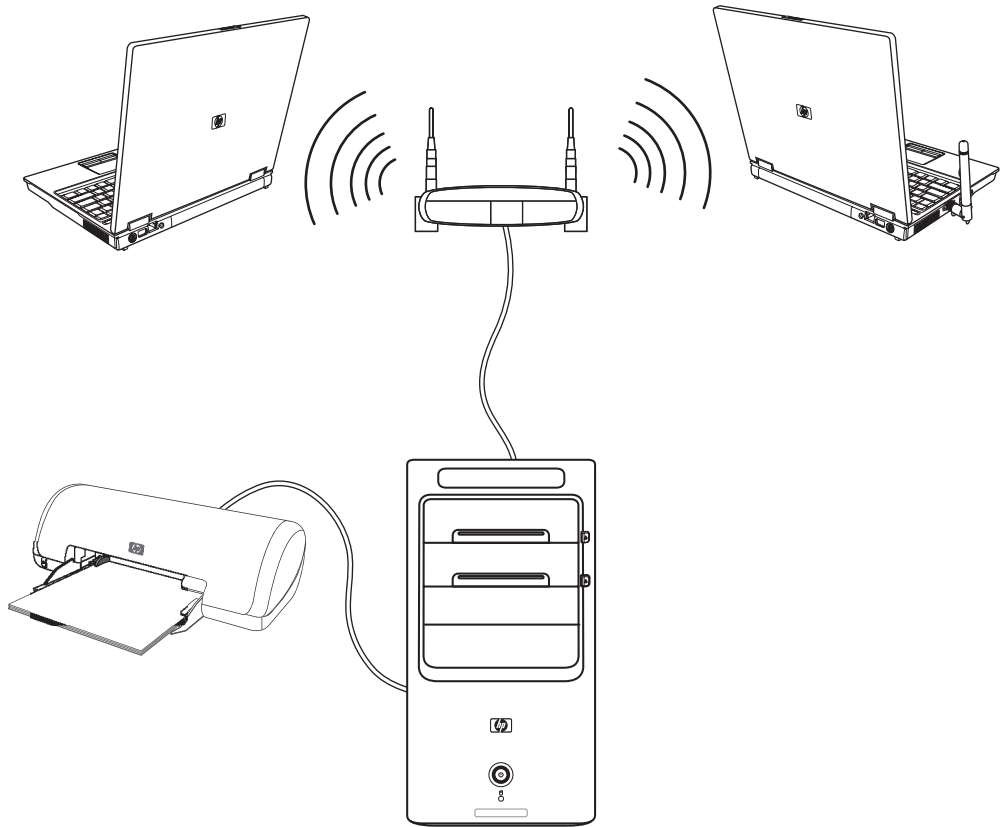

The preceding illustration shows a home LAN. The desktop computer has a wired connection to a wireless router. The desktop computer also has a printer that it shares with the other computers on the network. Each notebook computer has a wireless connection to the network router.

Setting Up a Wired (Ethernet) Connection

The *Ethernet* connection, which may be called network interface adapter, Network Interface Card, or NIC, provides a high-speed or broadband connection to an Ethernet (10BaseT) or Fast Ethernet (100BaseT) network. After you connect this interface to a network, such as a LAN, you can connect to the Internet through the network.

- 1 Connect an Ethernet cable to the Ethernet connector (**A**) on the back of the computer, and to the network router or LAN device.

NOTE: Your computer may not come with an Ethernet connector.

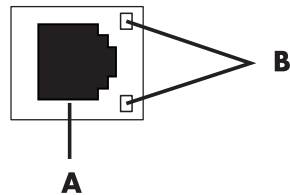

A Ethernet connector (RJ-45 port)

B Ethernet indicator lights

- 2 With the computer turned on, check the indicator lights (**B**) next to the Ethernet connector for the status:
 - **ACTIVITY** — Lit yellow during network data transfer activity
 - **LINK** — Lit green when there is a valid network connection

NOTE: Your Ethernet connector may have only one indicator light.

Integrated Wireless Devices

Wireless technology transfers data across radio waves instead of wires. Your computer may be equipped with one or more of the following integrated wireless devices:

- **Wireless local area network (WLAN) devices** connect the computer to wireless local area networks (commonly referred to as wireless networks, wireless LANs, or WLANs) in corporate offices, your home, and public areas such as airports and restaurants. In a WLAN, each mobile wireless device communicates with a wireless access point, which can be several hundred feet away.

Computers with WLAN devices may support one or more of the three IEEE physical layer industry standards: 802.11b, 802.11g, or 802.11a.

- **Bluetooth devices** create a personal area network (PAN) to connect other Bluetooth-enabled devices such as computers, phones, printers, headsets, speakers, and cameras. In a PAN, each device communicates directly with the other devices, and the devices must be relatively close together — within 33 feet (10 meters) of each other.

- **Wireless wide area networks (WWAN) devices** provide access to information anytime and anywhere you have cellular (data) coverage. In a WWAN, each mobile device communicates to a public carrier's base station. Public carriers install networks of base stations (similar to cell phone towers) throughout large geographic areas, effectively providing coverage across entire states, or even entire countries/regions.

For more information about wireless technology, go to:
<http://www.hp.com/go/techcenter/wireless>

Connecting the Wireless LAN Device

(Select models only)

You can connect the computer to an 802.11b or 802.11g wireless network by using the external antenna that was included with your system. This device enables you to establish a wireless network using your computer as a wireless access point, or you can use your computer as a wireless client (Station Mode) if you already have a wireless network running.

You need an existing wireless LAN with an Internet connection (consult your Internet Service Provider [ISP] for further information). An external antenna is supplied with your system; you must connect it to the 802.11 module to increase the range and sensitivity of the radio.

To connect the wireless LAN antenna:

- 1 Screw the wireless LAN antenna cable into the wireless LAN connector on the back of the computer.
- 2 For the best wireless performance, place the antenna on the computer or in an elevated and open area.

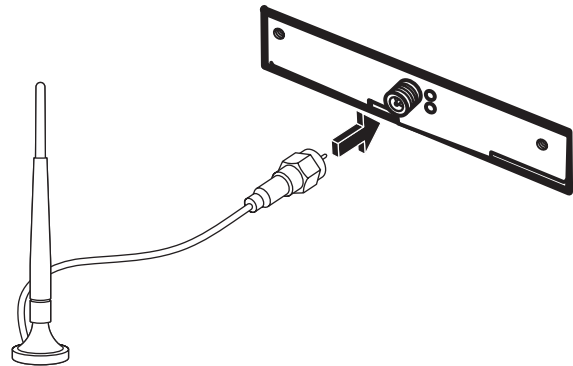

NOTE: The appearance of your wireless antenna may vary.

Checking the wireless LAN device installation

To set up your wireless network, verify that the integrated WLAN device is installed on your computer correctly.

- 1 Click the **Windows Start Button** on the taskbar.
- 2 Type *Device Manager* into the Search box, and then click **Device Manager** to open the Device Manager window.
- 3 Click **Network adapters**. Your WLAN device should be listed here. The WLAN device may include the term *wireless*, *wireless LAN*, or *802.11*.

NOTE: If no WLAN device is listed, either your computer does not have an integrated WLAN device, or the driver for the device is not properly installed.

- 4 Click the **Windows Start Button** on the taskbar.
- 5 Type *Network and Sharing Center* into the Search box, and then click **Network and Sharing Center** to open the Network and Sharing Center window.
- 6 Click **Add a device to the network** and follow any onscreen instructions.

For more information about setting up a wireless network:

- Click the **Windows Start Button** on the taskbar, click **Help and Support**, and then type *Setting up a wireless network* into the Search Help box.
- Go to: <http://www.hp.com/go/techcenter/wireless>

Using wireless security features

When you set up a home WLAN or access an existing public WLAN, always enable security features to protect your network from unauthorized access. The most common security levels are Wi-Fi Protected Access Personal (WPA-Personal) and Wired Equivalent Privacy (WEP).

When setting up a network, you should use one or more of the following security measures:

- Enable WPA-Personal or WEP security encryption on the router.
- Change the default network name (SSID) and password.
- Use a firewall.
- Set security on your Web browser.

For more information about setting up wireless security features, go to: <http://www.hp.com/go/techcenter/wireless>

Connecting a Modem

For information on connecting to the Internet, see “Connecting to the Internet” in this guide.

The modem is used for connecting to an ISP that provides a telephone dial-up connection to the Internet.

NOTE: Your computer may not come with a modem.

Before you can use telephone dial-up to connect to the Internet and send or receive e-mail and faxes, you must connect your telephone service line to the modem (**A**), which is on the back of the computer (**B**). The setup poster shows you how to plug a modem/telephone cable into the computer modem connector and into your telephone service line wall jack connector.

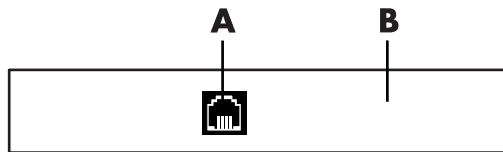

A Modem connector

B Back of computer

Connecting Speakers or Microphone

NOTE: For cross-references, see “Configuring Speaker and Sound Options” in your product information on the HP Support Web site, go to:
<http://www.hp.com/support>

Using Speakers

Speakers are included with the monitor (select models only) or are sold separately. For details on connecting stereo speakers to the computer, see the setup poster.

NOTE: Speakers may be passive (no power button and no power cord) or active (power button or power cord). Your computer supports only active (powered) speaker systems; the speaker system must have its own power cord.

A *stereo speaker set* is a left-right, two-channel speaker system. A *multichannel audio speaker system* is a system with more than two channels, and it may include a subwoofer. For example, 5.1 channels, referred to as a six-speaker mode, uses two front speakers (left-right), two rear speakers (left-right), a center speaker, and a subwoofer.

If your computer has multichannel audio speaker capacity (select models only), you can connect four channels for four-speaker output or six channels for 5.1 speaker output.

Connect your speaker system to the computer and then configure the audio software for sound output.

Sound Connector Types

Your model may include one of three analog sound connector types on the back of your computer:

- Three connectors
- Six connectors
- Sound card

The connectors are 1/8-inch (3.5 mm) stereo mini-jacks that connect from the back of the computer to speakers and microphones.

Your system may also have a separate Digital Out connection (select models only).

Software configuration is different for each connector type, as noted in the instructions.

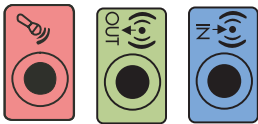
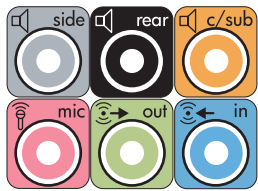
Sound Connector		Illustration	Type
Three connectors	Your computer model may include three sound connectors. You can connect up to a 5.1 audio system to the computer.		3
Six connectors	Your computer model may include six sound connectors on the back of your computer. You can connect up to a 7.1 audio system to the computer.		6
Sound card connector	Your computer may include a sound card. You can connect up to a 5.1 audio system (7.1 audio system for select models) or digital speakers to the sound card on the computer.	See the following illustration.	S



















NOTE:

- Type 3 is three connectors.
- Type 6 is six connectors.
- Type S is sound card.

Use the sound connectors that match your computer model when installing cables, as shown in the installation procedure steps.

The following table shows the sound connectors on the back panel of computer systems.

Sound connector			
Type 3	Type 6	Type S	Description
			Line Side (gray) for side speakers in an eight-speaker system (7.1).
		A 	Line C/Sub (gold) for center/subwoofer speakers in a multichannel audio configuration.
		B 	Line Rear (black) for rear speakers in a multichannel audio configuration.
		C 	Line Out (lime green) for front speakers.
		D 	Mic (pink) connects to microphone. (Type 3 also functions as center/subwoofer Line Out when a multichannel audio configuration is activated.)
		E 	Line In (light blue) connects to an analog audio device such as a CD player for input into computer. (Type 3 also functions as rear Line Out when a multichannel audio configuration is activated.)
		F 	Digital Out (orange) connects to a digital audio device with digital input (such as a home audio receiver/amplifier) or digital speakers (select models only).

NOTE:

- Type 3 is three connectors.
- Type 6 is six connectors.
- Type S is sound card.

Connecting a Microphone

Your computer comes with one microphone connector in the back of the computer. Some models have a second microphone connector in the front of the computer. Only one microphone connector works at a time, and the back connector is ready to use unless you have the multichannel audio speakers option. For computers with the multichannel audio speakers option, the microphone connector in the front of the computer, if present, is ready to use.

To use a microphone connected to the front of your computer (select models only), select the working microphone. See "Selecting a Microphone."

HP computers support many different audio options, sound connections, and speaker configurations. You may set up your computer for two stereo speakers or for multichannel audio speaker systems. Connect your speaker system to the computer, and then configure the audio software for sound output. For more details about connecting stereo speakers to the computer, see the setup poster.

This chapter describes the most typical options. Your system may have different components.

Speakers are included with the monitor (select models only) or are sold separately.

NOTE: For additional information on connecting the speakers, refer to the setup poster that came with the computer and the documentation that came with your speakers.

Speaker Configurations

You may set up your computer for the following supported configurations:

Name	Speaker system	See
Headphones	None, muted.	"Using Headphones"
2 (stereo)	Left speaker, right speaker.	"Connecting 2/2.1 (Two Speakers and a Subwoofer) Audio Speakers"
2.1	Left speaker, right speaker, and a subwoofer.	"Connecting 2/2.1 (Two Speakers and a Subwoofer) Audio Speakers"
4.1	Two front speakers, two rear speakers, and a subwoofer.	"Connecting 4.1 (Four Speakers and a Subwoofer) Audio Speakers"
6/5.1	Two front speakers, two rear speakers, a center speaker, and a subwoofer.	"Connecting 5.1 (Five Speakers and a Subwoofer) Audio Speakers"

Name	Speaker system	See <i>(continued)</i>
8/7.1	Two front speakers, two rear speakers, two side speakers, a center speaker, and a subwoofer (select models only).	"Connecting 7.1 (Seven Speakers and a Subwoofer) Audio Speakers"
Home audio system	Home stereo or home theater audio system with passive speakers.	"Connecting the Computer to a Home Audio System"
Digital audio	Digital speakers or digital input connector on audio system.	"Connecting Digital Audio"
Multi-streaming audio	Two front speakers, two rear speakers, two side speakers, a center speaker, and a subwoofer (select models only).	"Configuring Multi-streaming Audio"

Speaker types

Speakers may be included with the monitor (select models only) or are sold separately. Refer to the product documentation for your speakers.

Your computer supports only an active (powered) speaker system. An active speaker system must have its own power cord. A home audio system does not require active speakers, because the receiver provides amplification.

A stereo speaker set is a left-right, two-channel speaker system. A multichannel audio speaker system has a left-right front and left-right rear channel, and it may include a subwoofer and a center speaker. Side speakers are included in more advanced systems. A subwoofer provides enhanced bass sounds.

".1" indicates a subwoofer. For example, 7.1 channels refers to an eight-speaker mode and uses two front speakers (left-right), two side speakers (left-right), two rear speakers (left-right), a center speaker, and a subwoofer.

Connecting 2/2.1 (Two Speakers and a Subwoofer) Audio Speakers

To connect simple left/right stereo active speakers or two speakers and a subwoofer for two-channel (2.1 speaker) output:

- 1 Turn off the computer.
- 2 Connect the speaker cable to the lime green Audio Line Out connector that matches the back of your computer.



NOTE:

- Type 3 is three connectors.
- Type 6 is six connectors.
- Type S is sound card.

-
- 3 Connect the cable to the audio system. For 2.1 speakers that were shipped with your computer (select models only), connect the Audio Line Out connector to the subwoofer.
 - 4 Connect the left and right speakers to the subwoofer. Refer to the speaker documentation.
 - 5 Turn on the computer.

NOTE: Always turn on the computer before you turn on the speaker system.

-
- 6 Plug in the speaker system power.
 - 7 Turn on the speaker system.

Step 8 is optional for a two-speaker setup.

- 8 After the speakers are connected to the computer, configure the audio software for sound output for your computer model. See "Connecting Speakers or Microphone."
 - Type 3: See "Configuring Audio Output with Multichannel Sound Manager."
 - Type 6: See "Configuring Audio Output with Sound Effect Manager."
 - Sound card: See "Configuring Audio Output with a Sound Card."

The following diagram shows a typical 2.1 audio installation:

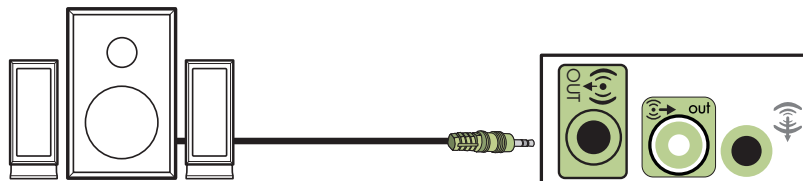

Connecting 4.1 (Four Speakers and a Subwoofer) Audio Speakers

To connect two front speakers, two rear speakers, and a subwoofer for four-channel (4.1 speaker) output:

- 1 Turn off the computer.
- 2 Connect the front speaker cable to the lime green Audio Line Out connector that matches the back of your computer.



NOTE:

- Type 3 is three connectors.
- Type 6 is six connectors.
- Type S is sound card.

- 3 Connect the rear speaker cable to the black connector that matches the back of your computer.



For type 3-connector systems, the blue Audio Line In connector functions as a Rear Line Out when a multichannel audio configuration is activated.

- 4 Connect the cables to the audio system.
- 5 Connect the front and rear speakers to the subwoofer. Refer to the speaker documentation.
- 6 Turn on the computer.

NOTE: Always turn on the computer before you turn on the speaker system.

- 7 Plug in the speaker system power.
- 8 Turn on the speaker system.
- 9 After the speakers are connected to the computer, configure the audio software for sound output for your computer model. See “Configuring Speaker and Sound Options.”
 - Type 3: See “Configuring Audio Output with Multichannel Sound Manager.”
 - Type 6: See “Configuring Audio Output with Sound Effect Manager.”
 - Sound card: See “Configuring Audio Output with a Sound Card.”

The following diagram shows a typical 4.1 audio installation:

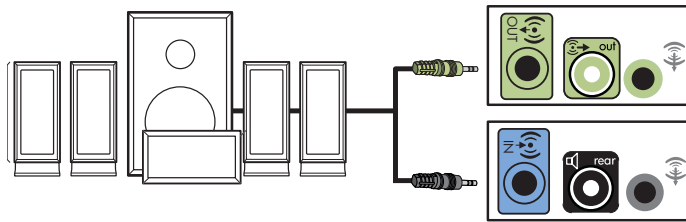

Connecting 5.1 (Five Speakers and a Subwoofer) Audio Speakers

To connect two front speakers, two rear speakers, a center speaker, and a subwoofer for six-channel (5.1 speaker) output:

- 1 Turn off the computer.
- 2 Connect the front speaker cable to the lime green Audio Line Out connector that matches the back of your computer.



NOTE:

- Type 3 is three connectors.
 - Type 6 is six connectors.
 - Type S is sound card.
-

- 3 Connect the rear speaker cable to the black connector that matches the back of your computer.



For type 3-connector systems, the blue Audio Line In connector functions as a Rear Line Out when a multichannel audio configuration is activated.

- 4 Connect the center/subwoofer speaker cable to the gold (or pink Mic) connector that matches the back of your computer.



For type 3-connector systems, the pink Mic connector functions as a center/subwoofer speaker Line Out when a multichannel audio configuration is activated.

- 5 Connect the cables to the audio system.
- 6 Connect the front, rear, and center speakers to the subwoofer. Refer to the speaker documentation.
- 7 Turn on the computer.

NOTE: Always turn on the computer before you turn on the speaker system.

- 8 Plug in the speaker system power.
- 9 Turn on the speaker system.
- 10 After the speakers are connected to the computer, configure the audio software for sound output for your computer model. See "Configuring Speaker and Sound Options."
 - Type 3: See "Configuring Audio Output with Multichannel Sound Manager."
 - Type 6: See "Configuring Audio Output with Sound Effect Manager."
 - Type 6 – multi-streaming: See "Configuring Audio Output with Sound Effect Manager."
 - Sound card: See "Configuring Audio Output with a Sound Card."

The following diagram shows a typical 5.1 audio installation:

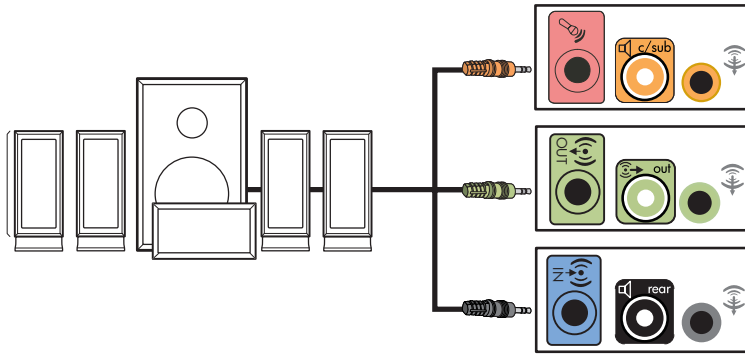

Connecting 7.1 (Seven Speakers and a Subwoofer) Audio Speakers

(Select models only)

To connect two front speakers, two side speakers, two rear speakers, a center speaker, and a subwoofer for eight-channel (7.1 speaker) output:

- 1 Turn off the computer.
- 2 Connect the front speaker cable to the lime green Audio Line Out connector on the back of your computer.



- 3 Connect the rear speaker cable to the black connector on the back of your computer.



- 4 For type 6 connectors only, connect the side speaker cable to the gray connector on the back of your computer.



- 5 Connect the center speaker and subwoofer speaker cable to the gold connector on the back of your computer.



- 6 Connect the cables to the audio system.
- 7 Connect the front, rear, side, and center speakers to the subwoofer. Refer to the speaker documentation.
- 8 Turn on the computer.

NOTE: Always turn on the computer before you turn on the speaker system.

- 9 Plug in the speaker system power.
- 10 Turn on the speaker system.
- 11 After the speakers are connected to the computer, configure the audio software for sound output for your computer model. See “Configuring Speaker and Sound Options.”
 - Type 6: See “Configuring Audio Output with Sound Effect Manager.”
 - Type 6 – multi-streaming: See “Configuring Audio Output with Realtek HD Sound Effect Manager.”

The following diagram shows a typical 7.1 audio installation:

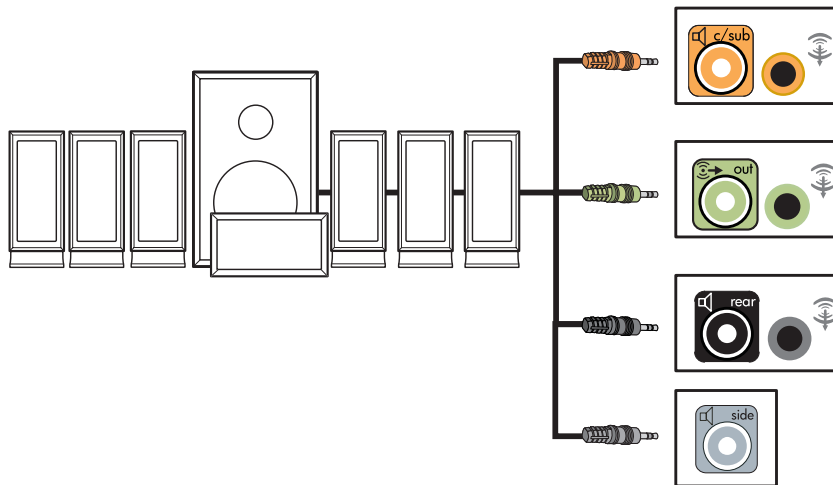

Connecting the Computer to a Home Audio System

You can connect your computer to your home stereo or home theater multichannel audio receiver/amplifiers by using your existing speakers.

For examples, see “2.1 home stereo installation” or “5.1 home audio installation.”

Y adapter cables

Most home receiver/amplifiers have RCA-type input connectors. You may need to connect Y adapter cables between your computer and your receiver/amplifier. Y adapter cables have one 1/8-inch (3.5 mm) stereo mini-jack on one end and two RCA connectors on the other end. These cables are purchased separately.

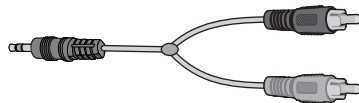

The number of Y adapter cables you need to connect to your home stereo system depends on the number of speakers you install:

- 2/2.1 speaker system: One Y adapter cable
- 4/4.1 speaker system: Two Y adapter cables
- 6/5.1 speaker system: Three Y adapter cables
- 8/7.1 speaker system: Four Y adapter cables

Connecting a home stereo to a computer typically requires audio cables that are long enough to connect from the computer to the stereo. You may also need to purchase RCA or mini-extension cables.

NOTE: Y adapter and extension cables are purchased separately.

2.1 home stereo installation

The following diagram shows a typical two-channel (2.1 speaker) installation that uses passive stereo speakers and plugs into a home stereo standard left and right input.

This is only a suggested configuration. Your system may be different.

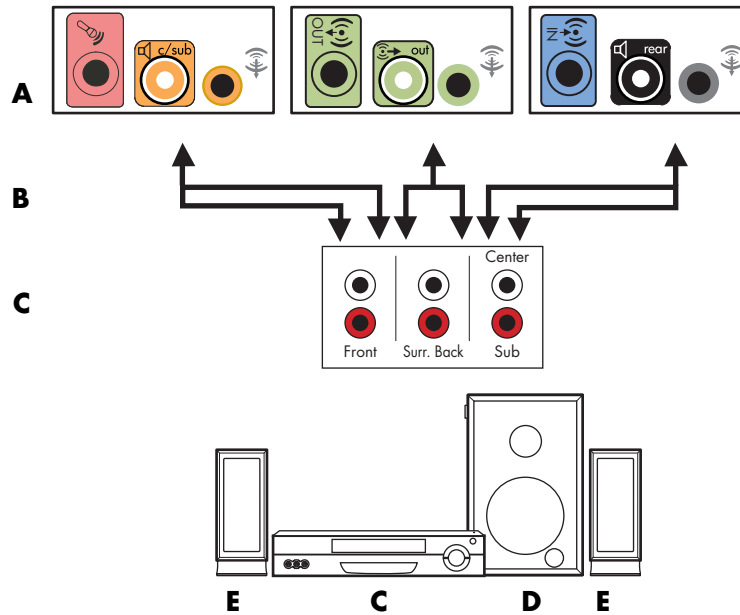

Computer to 2.1 multichannel audio system connection

- A Computer back-panel connectors (type 3, type 6, or sound card)
- B Y adapter cables
- C Receiver/amplifier (audio input jacks)
- D Subwoofer
- E Front speakers (left and right)

5.1 home audio installation

The following diagram shows a typical advanced home theater audio six-channel (6/5.1 speaker) installation that requires multichannel inputs on a receiver/amplifier.

This is only a suggested configuration. Your system may be different.

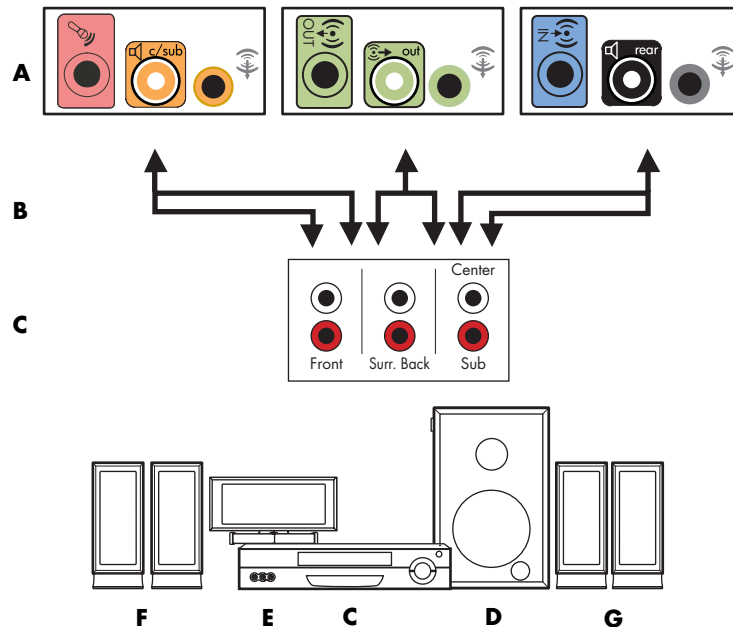

Computer to 5.1 multichannel audio system connection

- A** Computer back-panel connectors (type 3, type 6, or sound card)
- B** Y adapter cables
- C** Receiver/amplifier (audio input jacks)
- D** Subwoofer
- E** Center speaker
- F** Front speakers (left and right)
- G** Rear speakers (left and right)

5.1 home audio installation procedure

To connect a six-channel (5.1 speaker) home audio system to the computer:

- 1** Turn off the computer.
- 2** Turn off the receiver/amplifier.

- 3 Connect the front stereo mini-jack end of a Y adapter cable into the lime green Audio Line Out connector that matches the back of your computer.



NOTE:

- Type 3 is three connectors.
 - Type 6 is six connectors.
 - Type S is sound card.
-

NOTE: Receiver/amplifier input connectors may be labeled Surround, 5.1 Channel inputs, 6 Channel inputs, CD, DVD, or DVD In.

Connect the left and right ends of the Y adapter cable into the front left (L) and right (R) inputs on the back of the receiver/amplifier.

- 4 If you have rear speakers, connect the rear stereo mini-jack end of a Y adapter cable into the Audio Line In (blue) or the Rear Speaker Out (black) connector that matches the back of your computer.



- Connect the left and right ends of the Y adapter cable into the rear left (L) and right (R) inputs on the back of the receiver/amplifier.
- 5 If you have a center/subwoofer speaker, connect the stereo mini-jack of a Y adapter cable into the microphone (pink) connector or the center speaker/subwoofer (gold) connector that matches the back of your computer.



- Connect the left and right ends of the Y adapter cable into the center/subwoofer inputs on the back of the receiver/amplifier (6/5.1 or higher-channel system).
 - Plug the Y adapter cable into the subwoofer connector on the back of the receiver even if a subwoofer is not used.
- 6 Turn on the receiver/amplifier.
- 7 Select the receiver/amplifier input that the Y adapter cables are plugged into.

- 8 Turn on the computer.
- 9 After the audio system is connected to the computer, configure the audio software for sound output for your computer model. See "Connecting Speakers or Microphone."
 - Type 3: See "Configuring Audio Output with Multichannel Sound Manager."
 - Type 6: See "Configuring Audio Output with Sound Effect Manager."
 - Sound card: See "Configuring Audio Output with a Sound Card."

7.1 home audio installation

The following diagram shows a typical advanced home theater audio eight-channel 8/7.1 speaker installation that requires multichannel inputs on a receiver/amplifier.

This is only a suggested configuration. Your system may be different.

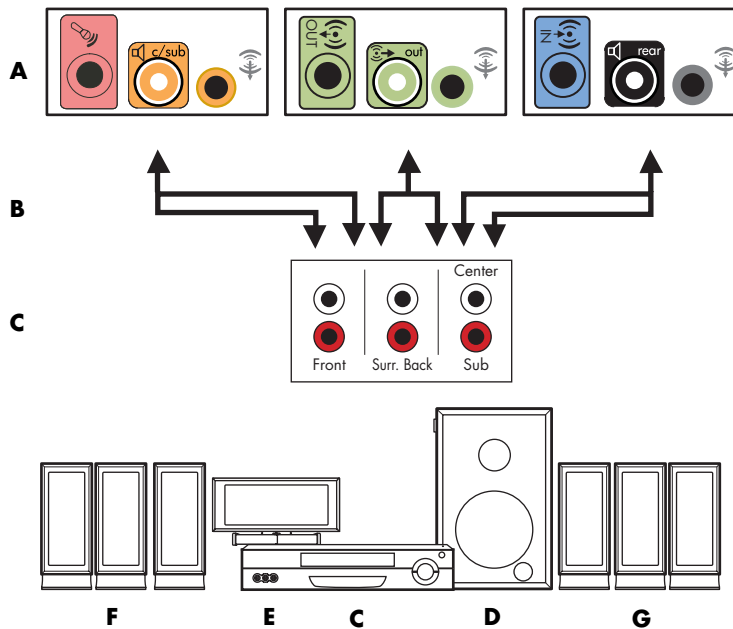

Computer to 7.1 multichannel audio system connection

- A Computer back-panel connectors (type 3, type 6, or sound card)
- B Y adapter cables
- C Receiver/amplifier (audio input jacks)
- D Subwoofer
- E Center speaker
- F Front speakers (left and right)
- G Rear speakers (left and right)

7.1 home audio installation procedure

To connect an eight-channel (7.1 speaker) home audio system to the computer:

- 1 Turn off the computer.
- 2 Turn off the receiver/amplifier.
- 3 Connect the front stereo mini-jack end of a Y adapter cable into the lime green Audio Line Out connector that matches the back of your computer.



NOTE:

- Type 3 is three connectors.
- Type 6 is six connectors.
- Type S is sound card.

NOTE: Receiver/amplifier input connectors may be labeled Surround, 7.1 Channel inputs, 6 Channel inputs, CD, DVD, or DVD In.

Connect the left and right ends of the Y adapter cable into the front left (L) and right (R) inputs on the back of the receiver/amplifier.

- 4 If you have rear speakers, connect the rear stereo mini-jack end of a Y adapter cable into the Audio Line In (blue) or the Rear Speaker Out (black) connector that matches the back of your computer.



- Connect the left and right ends of the Y adapter cable into the rear left (L) and right (R) inputs on the back of the receiver/amplifier.

- 5 If you have a center/subwoofer speaker, connect the stereo mini-jack of a Y adapter cable into the microphone (pink) connector or the center speaker/subwoofer (gold) connector that matches the back of your computer.



- Connect the left and right ends of the Y adapter cable into the center/subwoofer inputs on the back of the receiver/amplifier (8/7.1 or higher-channel system).
 - Plug the Y adapter cable into the subwoofer connector on the back of the receiver even if a subwoofer is not used.
- 6 Turn on the receiver/amplifier.
- 7 Select the receiver/amplifier input that the Y adapter cables are plugged into.
- 8 Turn on the computer.
- 9 After the audio system is connected to the computer, configure the audio software for sound output for your computer model. See “Connecting Speakers or Microphone.”
- Type 3: See “Configuring Audio Output with Multichannel Sound Manager.”
 - Type 6: See “Configuring Audio Output with Sound Effect Manager.”
 - Sound card: See “Configuring Audio Output with a Sound Card.”

Connecting Digital Audio

(Select models only)

If you have a sound card and you are connecting your home stereo AV receiver via digital out, plug the 3.5 mm stereo plug into the Digital Out connector on the sound card. Connect the red RCA stereo plug on the 3.5 mm Y adapter cable to the AV receiver’s digital input connector. If the red RCA stereo plug does not work, try the white stereo plug. One of the connectors is not used.

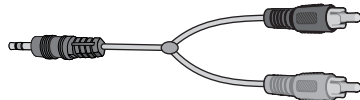

To connect digital audio, your computer must include a digital out connector on the sound card or on the back panel. You do not need to connect multichannel speaker outputs if you connect the digital output.

To connect digital audio speakers:

- 1 Turn off the computer.
- 2 Connect the Digital Out connector on the back panel of your computer to the digital input (S/PDIF) on digital speakers or a digital audio system.



NOTE:

- Type 3 is three connectors.
- Type 6 is six connectors.
- Type S is sound card.

-
- 3 Turn on the computer.

NOTE: Always turn on the computer before you turn on the speaker system.

- 4 Plug in the speaker system power.
- 5 Turn on the speaker system.
- 6 After the speakers are connected to the computer, configure the audio software for sound output for your computer model. See "Configuring Speaker and Sound Options."
 - Audio card with digital output and type 3 connectors: See "Configuring Audio Output with Multichannel Sound Manager." Follow the instructions to enable digital audio output.
 - Audio card with digital output and type 6 connectors: See "Configuring Audio Output with Sound Effect Manager." Digital audio output is already enabled as the default.
 - Sound card: See "Configuring Audio Output with a Sound Card." Follow the instructions to enable digital audio output.

Connecting Headphones

Your computer comes with a headphones connector (lime green) on the front of the computer. The headphones connector is labeled with a headphones icon.



You can also connect headphones to the Line Out connector (lime green) on the back of your computer.



Using a 2.1 speaker system with headphones

For select models with the 2.1 speaker system, look for the headphones connector on the right side of the main speaker. When headphones are plugged in, the sound to the speakers and the subwoofer is muted.

Using a 5.1 to 7.1 speaker system with headphones

For select models that include a 5.1 or higher speaker system, a headphones connector is located on the right side of the control tower.

If the control tower displays *HP* (for headphones), the headphones are enabled; the sound to the speakers and the subwoofer is muted.





- Push and hold the On button on the control tower for several seconds to enable sound from the speakers.
- Press the On button briefly to enable the headphones.

Connecting Speakers Using the Creative Sound Blaster X-Fi Sound Card

This section provides an overview of connecting to the Creative Sound Blaster X-Fi sound card.

NOTE: For additional information on connecting the speakers, refer to the documentation that came with your speakers.

Connecting the speakers

Connector	Description
	AD-Link for AD_Link X-Fi I/O Console (the X-Fi console is sold separately)
	Line Out_3 (orange or yellow) 5.1 audio setup: Front center, subwoofer 6.1 audio setup: Front center, subwoofer, and rear center 7.1 audio setup: Front center, subwoofer, and side left
	Line Out_2 (black) 4.1, 5.1, 6.1 audio setup: Rear left and right 7.1 audio setup: Rear left, rear right, and side right
	Line Out_1 (lime green) 2/2.1 audio setup: Front left and right
	FlexiJack (white) for Line In, Microphone, Digital In/Out The FlexiJack supports three functions. You must select the function in the Creative Console Launcher. See “Connecting the FlexiJack connector.”

To connect the X-Fi sound card to your speakers:

- 1 Use the audio connection table to connect your audio system to the sound card.
- 2 Turn on the computer.
- 3 Plug in and turn on the speaker system power.

After connecting the speaker system to the sound card, follow the steps in “Connecting the FlexiJack connector” to configure the speaker settings in the Creative Sound Blaster X-Fi software.

Connecting the FlexiJack connector

The FlexiJack connector performs three functions:

- Digital Input/Output
- Line In
- Microphone

You must select the function in the Creative Console Launcher.

NOTE: If you are using the FlexiJack as your Digital In connection and you want to connect digital speakers as your output device, you will need a special connector from Creative.

Finding Onscreen Guides

Onscreen guides are available in the User's Guides folder (select models only).

- 1 Click the **Windows Start Button** on the taskbar.
- 2 Click **All Programs**.
- 3 Click **User Guides**.
- 4 Click an item to view it or use it.

NOTE: If there are no guide titles listed in the folder, your computer has no onscreen guides.

Finding Guides on the Web

You can find guides and information for your computer by using the Internet to access the Support Web site.

- 1 Go to **<http://www.hp.com/support>** in your Web browser.
- 2 Select your country/region and language.
- 3 Click **Support and Drivers**.
- 4 Click **See support and troubleshooting information**, enter the model number of your computer, and then click **Search** .
- 5 Click **Manuals**.
- 6 Locate the manual you want, and then do one of the following:
 - Click the title to display the file in Adobe Acrobat Reader (which you can download from the Manuals page if it is not currently installed on your computer).
 - Right-click the title, click **Save Target As**, specify a location on your computer where you want to save the file, rename the file (retaining the .pdf extension), and then click **Save**.

Using the Onscreen Help and Support Center

Information about your computer is in the onscreen Help and Support Center (select models only). Here you can find links to driver updates, access to technical support options, and information about commonly asked questions.

To open the Help and Support Center:

- Press the Help button (select models only) on your keyboard.

Or

- Click the **Windows Start Button** on the taskbar, and then click **Help and Support**.

Using the PC Help & Tools Folder

The PC Help & Tools folder contains special utilities for computer owners, such as support information and programs.

To see the items in the PC Help & Tools folder:

- 1 Click the **Windows Start Button** on the taskbar.
- 2 Click **All Programs**.
- 3 Click **PC Help & Tools**.
- 4 Click an item to view it or use it.

Using HP Connections or Compaq Connections

HP Connections or Compaq Connections (select models only) is an Internet-based service provided by HP to bring you important information for your computer:

- Product notices
- Tips
- Special offers for your computer

Messages arrive while you're connected to the Internet, and display an alert or a notice on your desktop. Messages may also display within the HP Total Care Advisor. You can view messages as they arrive or read them later.

Most support updates that HP Connections or Compaq Connections messages deliver are also available to you through the support Web site under the information for your computer model.

Getting messages

After you view or close a message, it does not automatically display again.

To read a previously received message, open HP Connections or Compaq Connections:

- 1 Click the **Windows Start Button** on the taskbar.
- 2 Click **All Programs**.
- 3 Click **PC Help & Tools**.
- 4 Click **HP Connections** or **Compaq Connections**. HP Connections or Compaq Connections window opens.
 - If HP Connections or Compaq Connections has been activated on your system, click **View messages** to view a list of previously received messages. To read a message, double-click the message title in the window. You can exit this window, and HP Connections or Compaq Connections remains active.
 - If HP Connections or Compaq Connections has not been activated on your system, the screen contains an **Activate** button to activate the service. Click **Activate** to start the service and view a list of messages that may have been received previously.

Turning off messages

NOTE: You cannot receive HP Connections or Compaq Connections messages, including important information that may be critical to the operation of your computer, while the service is off.

To turn off the HP Connections or Compaq Connections service:

- 1 Click the **Windows Start Button** on the taskbar.
- 2 Click **All Programs**.
- 3 Click **PC Help & Tools**.
- 4 Click **HP Connections** or **Compaq Connections**. HP Connections or Compaq Connections window opens.
- 5 Click **Choose preferences**, and then click **Deactivate** to deactivate the service. The service is turned off until you reactivate it.

Reactivating messages

When you reactivate the HP Connections or Compaq Connections service, the service runs whenever you are connected to the Internet, and you automatically receive messages as they become available.

To turn on the service:

- 1 Click the **Windows Start Button** on the taskbar.
- 2 Click **All Programs**.
- 3 Click **PC Help & Tools**.
- 4 Click **HP Connections** or **Compaq Connections**. HP Connections or Compaq Connections displays.
- 5 Click **Activate** to reactivate the service.

Turning On Your Computer for the First Time

Using the Computer with Safety and Comfort



WARNING: To reduce the risk of serious injury, read the *Safety & Comfort Guide*. It describes proper workstation setup, posture, and health and work habits for computer users. It also provides important electrical and mechanical safety information.

Before you begin using the computer, arrange the computer and your work area to maintain your comfort and productivity. Refer to the *Safety & Comfort Guide* for important ergonomic information:

- Click the **Windows Start Button** on the taskbar, click **All Programs**, click **User Guides**, and then click **Safety & Comfort Guide**.

Or

- Type <http://www.hp.com/ergo> into your Web browser address box, and then press Enter on the keyboard.

Protecting Your Computer

Protect your computer, personal settings, and data from a variety of risks by using:

- Passwords.
- Antivirus software.
- Firewall software.
- Critical security updates.

NOTE: Security solutions are designed to act as deterrents, but they may not be able to prevent software attacks or to prevent the computer from being mishandled or stolen.

Computer risk	Security feature
Unauthorized use of the computer or user account	User password
Computer viruses	Norton Internet Security software (antivirus program)
Unauthorized access to data	<ul style="list-style-type: none"> ■ Norton Internet Security software (firewall program) ■ Windows Vista updates
Unauthorized access to Setup Utility, BIOS settings, and other system identification information	Administrator password
Ongoing or future threats to the computer	Critical security updates from Microsoft

Using passwords

A *password* is a group of characters that you choose to secure your computer information. Several types of passwords can be set, depending on how you want to control access to your information. Passwords can be set in Microsoft Windows Vista on the computer.



CAUTION: To avoid being locked out of the computer, record each password you set. Because passwords are not displayed as they are set, changed, or deleted, it is essential to record each password immediately and store it in a secure place.

You can use the same password for more than one Windows Vista security feature.

Use the following guidelines when setting a password:

- A password can have any combination of up to eight letters and numbers, and it is not case sensitive.
- A password must be set and entered with the same keys. For example, if you set your password with number keys on the keyboard, your password is not recognized if you subsequently try to enter it with the embedded numeric keypad.

NOTE: Select models include a separate numeric keypad, which functions exactly like the keyboard number keys, except in the case of passwords.

- A password set in Windows Vista must be entered at a Windows Vista prompt.

The following are some tips for creating and saving passwords:

- When creating passwords, follow the requirements set by the program.
- Write down your passwords and store them in a secure place away from the computer.

- Do not store passwords in a file on the computer.
- Do not use your name or other personal information that could be easily discovered by an outsider.

The following table lists the Windows Vista passwords and describes their functions. For information on how to set passwords, see “Creating passwords.” For additional information on Windows Vista passwords, such as screen saver passwords, type *passwords* into the Search box in the Help and Support Center.

Password	Function
Windows Vista Administrator password	Protects administrator-level access to computer contents.
Windows Vista User password	Protects access to a Windows Vista user account and the computer contents. It must be entered when you resume from sleep or away mode.



CAUTION: If you forget your Administrator password, you cannot access Setup Utility.

Using antivirus software

When you use the computer for e-mail, network, or Internet access, you expose it to computer viruses. Computer viruses can disable the operating system, software programs, or utilities, or cause them to function abnormally.

Antivirus software can detect most viruses, destroy them, and in most cases repair any damage that viruses may have caused. To provide ongoing protection against newly discovered viruses, antivirus software must be kept up to date.

Norton Internet Security, which is preinstalled on the computer, includes an antivirus program. The software includes a free update period. It is strongly recommended that you protect the computer against new viruses beyond the free period by purchasing extended update service. Instructions for using and updating Norton Internet Security software, and for purchasing extended update service, are provided within the program.

To open and access Norton Internet Security:

- 1 Click the **Windows Start Button** on the taskbar.
- 2 Click **All Programs**.
- 3 Click **Norton Internet Security**, and then click **Norton Internet Security** again.

For more information about computer viruses, type *viruses* into the Search box in the Help and Support Center.

Using firewall software

When you use the computer for e-mail, network, or Internet access, unauthorized persons may be able to gain access to information about you, the computer, and your data. To protect your privacy, use firewall software. Microsoft Windows Vista includes firewall software preinstalled on the computer. Also, Norton Internet Security, which is preinstalled on the computer, includes a firewall program.

Firewall features include logging, reporting, and automatic alarms to monitor all incoming and outgoing communications.

To open and access Norton Internet Security:

- 1 Click the **Windows Start Button** on the taskbar.
- 2 Click **All Programs**.
- 3 Click **Norton Internet Security**, and then click **Norton Internet Security** again.

Under some circumstances, a firewall can block access to Internet games, interfere with printer or file sharing on a network, or block authorized e-mail attachments. To temporarily solve the problem, disable the firewall, perform the task that you want to perform, and then enable the firewall again. To permanently resolve the problem, reconfigure the firewall.

Installing critical security updates



CAUTION: To reduce the risk of information damage or loss from security breaches and computer viruses, install all critical updates from Microsoft as soon as you receive an alert.

Additional updates to the operating system and other software may have become available after the computer was shipped. Download all available updates and install them onto your computer. To get the latest updates for your computer, click the **Windows Start Button** on the taskbar, click **Help and Support**, and then click **Software, drivers, and BIOS updates**.

Updates to Microsoft Windows Vista and other Microsoft programs are released periodically. You can obtain updates, as they are released, from the Microsoft Web site. You should also run Windows Vista Update monthly to install the latest software from Microsoft.

Turning On Your Computer for the First Time

After you have completed the steps on the setup poster, you are ready to turn on your computer.

- 1 Press the Power button on the monitor.
- 2 Press the On button on the front of the computer.
- 3 Turn on the speakers, if they are present.
- 4 Set up your computer by following the onscreen instructions. If prompted, select the country/region where you are physically located and wait while the computer makes preparations. (When you select an alternate language, it may take up to 30 minutes for this one-time language setup on the computer.)
- 5 Set up Microsoft Windows Vista by following the onscreen instructions.
- 6 Follow the onscreen instructions to register with HP or Compaq, sign up for updates, and get online. If you do not want to set up an Internet connection at this time, you can do so later by manually starting Easy Internet Services. See "Connecting to the Internet."
- 7 Norton Internet Security automatically opens. Follow the onscreen instructions to set up this tool to protect your computer and your privacy.

NOTE: If you stop the setup procedure, when you are ready to finish, double-click the **Easy Setup** icon on the desktop to run the first-time wizard.

Turning Off Your Computer

For best results, when using Microsoft Windows Vista, do not shut down your computer, except when you must turn off the power for safety reasons, such as to make repairs, install new hardware or cards in the computer chassis, or change a battery.

As an alternative to shutting down the computer, you can lock it or put it into either sleep or hibernate mode, if they are available. You can set the power management timers to put the computer automatically into sleep or hibernate mode.

Sleep and hibernate are power states. Sleep mode saves your work to memory so you can resume quickly, saves your work to the hard disk, and then goes to a reduced-power state. During sleep mode, your computer hardware light remains on, and your computer is ready to wake quickly and resume your work where you were. Hibernate mode saves your system memory to a temporary file on the hard disk and then turns off the hardware.

Some computers also have a reduced-power state called away mode. Away mode turns off the display and mutes the audio, but otherwise keeps the computer operational. During away mode, the computer can perform task such as recording a scheduled TV program or streaming video and music files to a remote location.

Using Shut Down

For best results, when using Windows Vista, turn off the computer without pressing any buttons on the computer chassis.

NOTE: For information on the **Windows Start Button**, see “Using the Windows Start Button Menu.”

- 1 Close any open software programs by clicking the **X** at the upper-right corner of each program window.
- 2 Click the **Windows Start Button** on the taskbar.
- 3 Click the **Arrow** button next to the Lock button.
- 4 Click **Shut Down**.
- 5 Turn off the monitor.

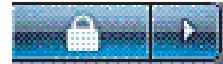

To turn on the computer after a shut down:

- 1 Press the Power button on the monitor.
- 2 Press the On button on the front of the computer.

Using Lock

If you lock the computer, only you or your administrator can log on to it.

- 1 Click the **Windows Start Button** on the taskbar.
- 2 Click the **Lock** button.

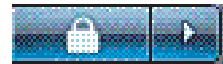

Using sleep mode

When the computer is in sleep mode, it goes into a reduced-power state. The monitor is blank, as if it is turned off. By using sleep mode:

- You save time, because you do not have to wait for the computer to go through the normal startup routine when you wake it again. The next time you use the computer, any programs, folders, and documents that were open before you put the computer into sleep mode are available.
- Your computer can receive faxes, if you set it to do so.
- Your computer can retrieve e-mail messages and download information from the Internet automatically, if you set it to do so.

To put the computer into sleep mode manually:

- Press the Sleep button on the keyboard, if it is present.

Or

- 1 Click the **Windows Start Button** on the taskbar.
- 2 Click the **Power** button.

Or

- 1 Click the **Windows Start Button** on the taskbar.
- 2 Click the **Arrow** button next to the Lock button.
- 3 Click **Sleep**.



To wake the computer from sleep mode:

- Press the Sleep button on the keyboard.

Or

- Quickly press the On button on the front of the computer.

If the computer does not work properly when you wake it from sleep mode, restart the computer.

- 1 Click the **Windows Start Button** on the taskbar.
- 2 Click the **Arrow** button next to the Lock button.
- 3 Click **Restart**.

Or

Quickly press the On button on the front of the computer.



Using hibernate mode

Hibernate mode is available as an advanced power setting. When the computer is in hibernate mode, it saves to the hard disk drive everything that is in computer memory, turns off the monitor and the hard disk drive, and then turns itself off. When you turn on the computer again, your programs, folders, and documents are restored to the screen.

To put the computer into hibernate mode manually:

- 1 Click the **Windows Start Button** on the taskbar.
- 2 Click the **Arrow** button next to the Lock button.
- 3 Click **Hibernate**, if it is present.



NOTE: If Hibernate is not present, you can set up your computer to go into hibernate mode automatically; see “Automatic sleep, hibernate, or away mode.”

To wake the computer from hibernate mode, press the On button on the front of the computer.

If the computer does not work properly when you wake it from hibernate mode, restart the computer.

- 1 Click the **Windows Start Button** on the taskbar.
- 2 Click the **Arrow** button next to the Lock button.
- 3 Click **Restart**.

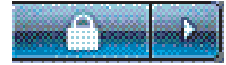

Automatic sleep, hibernate, or away mode

You can set your computer to go into sleep, hibernate, or away modes automatically when it is idle for a specified number of minutes. To put the computer into a mode automatically, modify the power management settings.

- 1 Click the **Windows Start Button** on the taskbar.
- 2 Click **Control Panel**.
- 3 Click **System and Maintenance**.
- 4 Click **Power Options**.
- 5 Click **Change when the computer sleeps**.
- 6 For sleep or away modes, select an option from the *Put the computer to sleep* drop-down menu, and click **Save changes**.

Or

For hibernate or away mode:

- a Click **Change advanced power settings**.
- b Click the plus sign (+) next to Sleep.
- c Click an item and make selections, and then click **Apply**.
- d Click **OK**.

Restarting the Computer

When you restart the computer, the computer clears some settings and starts over using the operating system and software in its memory. Restarting is the easiest and most effective way to solve many software issues for your computer.

Also, you may want to install additional software programs or hardware devices onto your computer, and doing so may require that you restart the computer after installation.

- 1 Click the **Windows Start Button** on the taskbar.
- 2 Click the **Arrow** button next to the Lock button.
- 3 Click **Restart**.

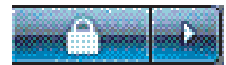

Or

Quickly press the On button on the front of the computer.

Connecting to the Internet

Your computer can connect to the Internet through the telephone modem. There are other ways to connect to the Internet that do not use the telephone modem, such as a LAN (local area network) or DSL (digital subscriber line). Check with your ISP for specific information on your connection.

Refer to the “Setting Up Your Computer” of this guide to make the hardware connections: for a modem see “Connecting a Modem” and for a network see “Setting Up a Local Area Network.”

To connect to the Internet you must have:

- A computer.
- A dial-up modem or cable modem, or a DSL modem for high-speed broadband connections. Contact your ISP for any specific software and hardware you may need.
- Internet service with an ISP.
- A Web browser.

To connect to the Internet:

- 1 Sign up with an ISP. If you already have an account with an ISP, skip this step and follow the instructions provided by the ISP.
- 2 If you did not set up for Internet service during the initial setup of the computer, set it up now by using Easy Internet Services.
 - a Click the **Windows Start Button** on the taskbar.
 - b Click **All Programs**.
 - c Click **Easy Internet Services**.
 - d Follow the onscreen instructions to select an ISP and set up Internet service.

NOTE: Easy Internet Services provides a list of ISPs; however, you may choose another ISP or transfer an existing account to this computer. To transfer existing accounts, follow the instructions provided by the ISP.

- 3 Connect to the Internet. You must connect through your ISP.
 - Double-click the ISP-provided icon on the desktop, and log in.
- 4 Open your Web browser and browse the Internet.

You can use any Web browser; most computers have Internet Explorer. To open Internet Explore:

- a Click the **Windows Start Button** on the taskbar.
- b Click **All Programs**.
- c Click **Internet Explorer**.

NOTE: If you have questions, contact your ISP directly.

Signing Up for Software Updates

Microsoft continually updates the Windows Vista operating system. It is recommended that you check for, download, and install these updates at least once a month. One way to keep the operating system up to date is to use the Automatic Updates feature. When you are connected to the Internet, Windows Vista Update automatically notifies you through a pop-up message or icon in the notification area when critical updates are available. When you see the Windows Vista Update message, allow the updates to download to your system. If you update the system weekly, or even monthly, the time required for download is minimal.

To configure Automatic Updates:

- 1 Click the **Windows Start Button** on the taskbar.
- 2 Click **Control Panel**.
- 3 Click **Security**.
- 4 Click **Windows Updates**.
- 5 Click **Change Settings**.
- 6 Select the desired configuration:
 - **Automatic (recommended)** — This is the default setting, and it enables you to specify a day and time to automatically download and install recommended updates.
 - **Download updates, but let me choose whether to install them**
 - **Check for updates but let me choose whether to download or install them**
 - **Never check for updates** — This option makes the computer more vulnerable and is not recommended.
- 7 Click **OK**.

Setting Up User Accounts on Your New Computer

User accounts enable you to set the privileges for each user of your computer. For example, you can set the software programs that each user is allowed to access.

Windows Vista provides three types of user accounts:

- **Administrative**
Allowed to change account types for other users, change passwords, change system-wide settings, and install Windows Vista-compatible software and drivers.
- **Limited**
Not allowed to change other user settings or passwords. A Limited account may not be able to install or run some software.
Allowed to change the limited account picture, and to create, edit, or delete the account password.
- **Guest**
Not allowed to change other user settings or passwords.
Users who log on to the computer using the guest account do not have access to password-protected files, folders, and settings.

Creating multiple user accounts on the same computer has certain advantages, as well as some drawbacks.

- **Advantages to multiple user accounts:**
 - Ability to create individual user settings
 - Ability to limit access to software for certain users
- **Drawbacks to multiple user accounts:**
 - More memory (RAM) usage
 - Multiple Temporary Internet Files folders to remove during Disk Cleanup
 - More data to back up
 - Longer time to complete virus scan

Creating passwords

Passwords help protect your computer from unauthorized access, and they help ensure that information on the computer stays private and secure. Use the following list as a basic guide when choosing your password:

- Choose a password that is easy for you to remember but difficult for others to guess.
- Choose a long password (minimum of six characters).
- Use a combination of uppercase and lowercase letters, numbers, and symbols.
- Don't use personal information that others can easily figure out, such as your birthday, child's name, or phone number.
- Don't write down passwords unless you store them in a secure place away from the computer.

Guidelines for Installing Software and Hardware Devices

After you set up the computer, you may want to install additional software programs or hardware devices. Keep in mind the following important guidelines:

- Before installation, make a restore point by using the Microsoft System Restore program.
 - a Click the **Windows Start Button** on the taskbar.
 - b Click **Control Panel**.
 - c Click **System and Maintenance**.
 - d Click **Backup and Restore Center**.
 - e Click **Create restore point or change settings**.
 - f In the System Property window, on the System Protection tab, click **create**. Follow the onscreen instructions.

The *restore point* is a snapshot of your computer settings. By using System Restore, you ensure that you have a stable set of settings to use. For information on System Restore, go to the Microsoft Web site at:

<http://www.microsoft.com/worldwide>

- Choose software that is compatible with your computer — check the operating system, memory, and other requirements listed for the new software.
- Install the new software according to the directions provided by the software manufacturer. If you need help, check the manufacturer's documentation or customer service information.
- For antivirus software, uninstall the existing software program before reinstalling it or installing a new antivirus program.

NOTE: Use only licensed original software. Installing copied software may be illegal, or it may result in an unstable installation or infect your computer with a virus.

Transferring Files and Settings from Your Old Computer to Your New Computer

You can copy files from the old computer to your new computer by using media such as CDs or DVDs, memory sticks, or personal media drives. You can also copy certain settings such as Web browser Favorites and address books by using Windows Easy Transfer software.

For more information:

- 1 Click the **Windows Start Button** on the taskbar.
- 2 Click **Help and Support**.
- 3 Type *transfer files* into the Search box.
- 4 Click the overview article, **Transfer files and settings from another computer**. This article describes a Microsoft solution for moving your files onto your new computer.

Using HP Total Care Advisor Software

HP Total Care Advisor is a desktop tool you use to monitor and access system health information about key areas of your computer. HP Total Care Advisor has four major areas:

- PC Health & Security provides a dashboard view of the status of key areas of your computer.
- PC Action Center receives messages and alerts that inform you of changes in the status of your computer health.
- PC Help provides simple access to help and support information for your computer.
- Products Showcase provides a listing of products and services available for your computer, and presents comparison shopping information about those items.

To open HP Total Care Advisor:

- 1 Click the **Windows Start Button** on the taskbar.
- 2 Click **All Programs**.
- 3 Click **HP Total Care Advisor**.

Using the Keyboard

Your computer may include a standard keyboard or a wireless keyboard. The keyboard is the primary way you enter text and commands for the computer.

A standard keyboard connects to the keyboard connector in the back of the computer.

A wireless keyboard (select models only) uses a receiver/transmitter, instead of a connector cable, to communicate with your computer. A light on the receiver indicates receiver activity.

Identifying Keyboard Features

The keyboard contains an arrangement of standard keys, indicator lights, and special buttons (select models only). Your keyboard may vary from the illustrations that follow.

Alphanumeric keys

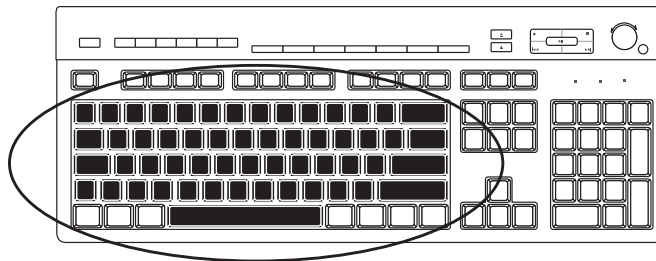

The alphanumeric keys are the main keys found on a standard typewriter.

Function keys

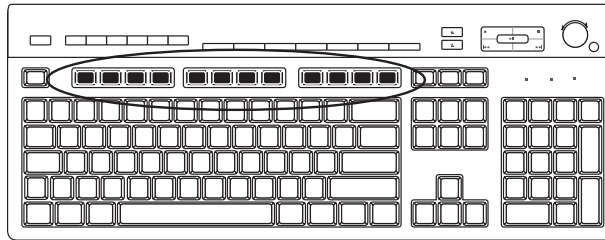

The function keys, located above the main keys, are labeled F1 through F12. Most function key operations vary by software program. F1 and F3 are available at all times:

- Pressing F1 displays a Help window for the software program being used.
- Pressing F3 displays a search window.

Edit keys

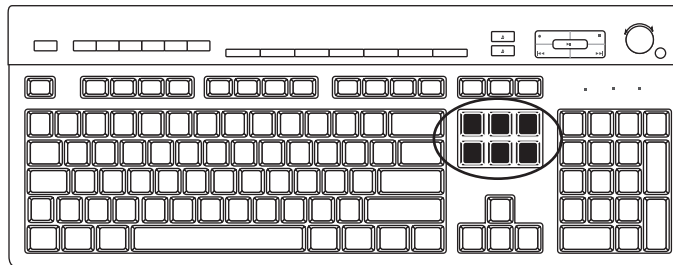

The edit keys are Insert, Home, Page Up, Delete, End, and Page Down. Use these keys to insert and delete text, and to quickly move the cursor on the screen. The edit keys function differently with some software programs.

Arrow keys

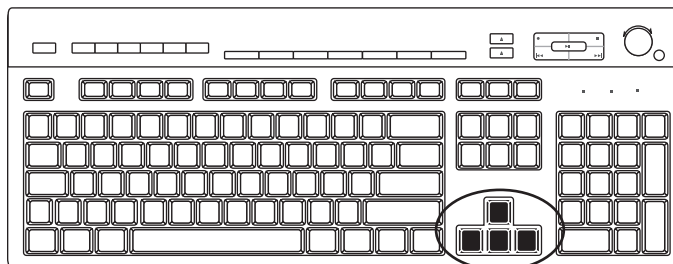

The arrow keys are controls for moving up, down, right, and left. You can use these keys instead of the mouse to move the cursor for navigation on a Web page, in a document, or in a game.

Numeric keys

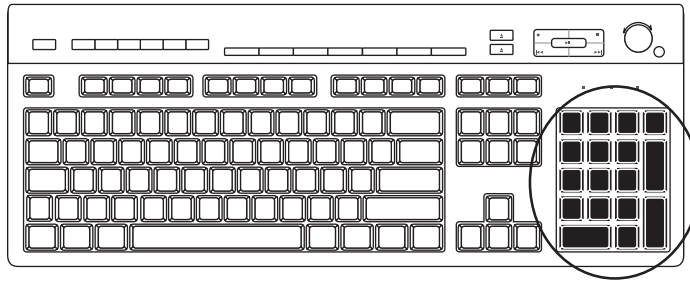

Press the Num Lock key to lock and unlock the numeric key functions:

- When the Num Lock light on the keyboard is on, the numeric keys work in the same way as the number keys and arithmetic functions found on a basic calculator.
- When the Num Lock light on the keyboard is off, the numeric keys are directional keys used to move the cursor or play games.

Keyboard indicators

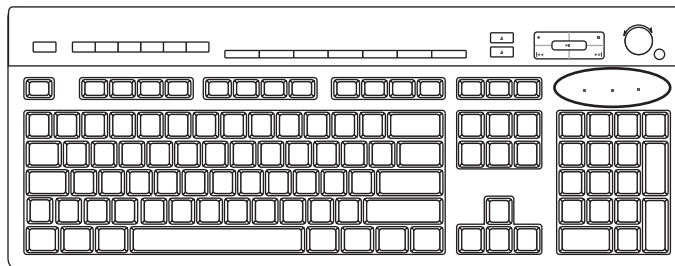

Each keyboard indicator is a light labeled with the name or with an icon for its status:

Icon	Name	Description
1	Num Lock	When lit, numeric keys are locked as numbers keys and arithmetic functions.
A	Caps Lock	When lit, alphanumeric keys are locked to uppercase.
↓	Scroll Lock	When lit, scroll function is locked.

Special keyboard buttons

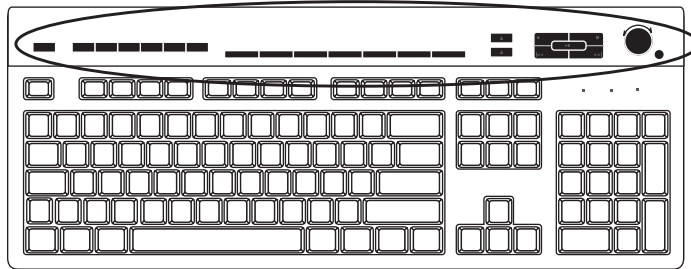









There are special buttons (select models only) at the top of the keyboard. These buttons operate a CD or DVD player, control speaker volume, connect you to the Internet, or provide quick access to specific functions. (Some keyboard models have some of these special buttons to the left side of the main keys, some do not have the Internet buttons, and some use a different layout on the top right.)



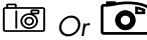









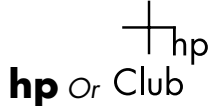
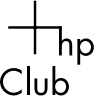









Identifying Special Keyboard Buttons

Your keyboard may not include some of the buttons listed.

NOTE: The number, location, and labeling of buttons vary by keyboard model.

Access buttons

Icon	Feature	Description
	Sleep	Puts computer into or out of power-saving mode. It may take 10–30 seconds before screen reappears.
	User	Switches between computer users.
	Information	Opens Help and Support Center.
 Or 	Pictures (Photos)	Opens imaging software program. Can be reconfigured.
 Or 	Music	Opens music software program. Can be reconfigured.
	Video	Opens video software program. Can be reconfigured.
	Internet	Opens your Internet browser. Can be reconfigured to open any Web site or software program.

Icon	Feature	Description <i>(continued)</i>
	Search	Opens page designed to search the Internet. Can be reconfigured to open any Web site or software program.
 Or 	E-mail	Opens e-mail program. Can be reconfigured to open any Web site or software program.
 Or 	HP Club	Links to HP Web site.
 Or 	Compaq My Presario	Links to Compaq Web site.
  Or 	Shopping	
 Or 	Sports	
 Or 	Finance	
  Or 	Connect to Internet	Goes to popular Web sites. Can be reconfigured to open a site or software program.
  Or 	Search	
 Or 	Chat	
	Entertainment	
	Offers	
	Calculator	Opens calculator. Can be reconfigured.

Media control or playback buttons

Icon	Label	Description
	Eject 1 and Eject 2	Opens or closes upper and lower optical drive trays.
	Rec	Starts recording to selected media.
	Stop	Stops media.
	Play/Pause	Plays or pauses media.
	Prev	Rewinds media.
	Next	Fast-forwards media.
 <i>Or</i> <i>Or</i> 	Volume	<p>Volume knob controls speaker volume: Turn clockwise to increase speaker volume and counterclockwise to decrease volume.</p> <p>NOTE: The Volume knob can continue to be turned, even after maximum volume has been reached.</p> <p>Volume Up and Down buttons controls speaker volume: Press the Volume Up button to increase volume and the Volume Down button to decrease volume.</p>
 <i>Or</i> 	Mute	Turns speaker sound on and off.

Customizing the keyboard buttons

You can customize some of the special buttons on the keyboard (select models only) to open different programs or files, or go to favorite Web sites.

- 1 Click the **Windows Start Button** on the taskbar.
- 2 Click **Control Panel**.
- 3 Click **Hardware and Sound**, if it is present.
- 4 Click **Keyboard**.
- 5 Click the **Buttons** tab, and then double-click the button you want to change.
- 6 For the button configuration, click the **Down arrow** to the right of the list and choose the button capability, such as **Complex remote page with label** or **Simple local file with label**.
- 7 Enter a display label and the address information. For a Web page, enter the URL.
- 8 Click **OK**.
- 9 On the Buttons tab, click **Apply**.
- 10 Repeat steps 5 through 9 for each button you want to customize.
- 11 Click **OK** to finish.

NOTE: Click the **Restore Defaults** button on the Buttons tab to restore all of the buttons to the factory settings.

Keyboard Shortcuts

Keyboard shortcuts are combinations of keys that you press simultaneously to perform specific actions. For example, from the Windows Vista desktop, press the Alt (alternate) key, the Ctrl (control) key, and the S key (the letter S) to display support information for the computer (including the model number, serial number, and service ID). You will see this combination of keys represented as Alt+Ctrl+S. In Windows Vista, press Ctrl+C to copy an item you've highlighted or selected, Ctrl+V to paste a copied item, or Ctrl+Z to undo the previous action. These shortcuts perform the same actions you can perform through menus, but save you time and mouse clicks.

Using the Mouse

Your computer includes a mouse for directing the cursor (pointer) on the Windows Vista desktop. The mouse uses a roller ball or optics (a light and sensor) to sense movement and cause the cursor on the screen to move. Use the mouse on a flat surface.

NOTE: The optical mouse cannot work on a glass, translucent, or reflective surface.

A *wireless mouse* (select models only) is an optical mouse that uses a receiver/transmitter, instead of a connector cable, to communicate with your computer. A light on the receiver indicates receiver activity.

NOTE: The wireless mouse goes into a sleep or suspend mode after 20 minutes of inactivity. Click a button on the mouse to wake it. (Moving the wireless mouse does not wake it.)

Using the Mouse Buttons

The mouse has two or three buttons on the top:

- Click the left mouse button (**A**) to position the cursor or select an item.
- Click the right mouse button (**C**) to display a menu of commands for the item you clicked.
- On select models, use the scroll wheel button (**B**) in the center for scrolling and panning.

NOTE: Your mouse may look different from the one shown here.

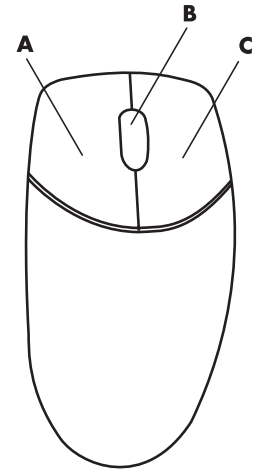

You see these terms for using the mouse:

- *Click* means to press and release the left mouse button once.
- *Double-click* means to click the left mouse button and then quickly click it again.
- *Right-click* means to press and release the right button once.

To select an item, click it.

To select sequential items in a list or group, click the first item in the list, and then press and hold the Shift key on the keyboard while you click the last item.

To select non-sequential items, click the first item, and then press and hold the Ctrl key on the keyboard while you click the additional items.

You can switch the function of the left and right buttons for left-handed use. See “Switching Mouse Button Functions.”

Scrolling

Click the left mouse button to place the cursor in a document, and then:

- To scroll toward the beginning of the document, roll the scroll wheel button up (away from you).
- To scroll toward the end of the document, roll the scroll wheel button down (toward you).

Autoscrolling

- 1 Place the cursor anywhere in the document, and then press the scroll wheel button once. An autoscroll icon appears.
- 2 Move the mouse in the direction you want to scroll. The farther you move the mouse from the starting point, the faster the document scrolls.
- 3 To stop autoscrolling, press the scroll wheel button again.



NOTE: Autoscrolling does not work with some software programs.

Panning

- 1 Place the cursor anywhere in the document, and then press and hold down the scroll wheel button.
- 2 Slowly move the mouse in the direction you want to pan. The farther you move the mouse from the starting point, the faster the document pans.
- 3 To stop panning, release the scroll wheel button.

NOTE: Panning works only if the horizontal scroll bar in the window is active. Panning does not work with some software programs.

Switching Mouse Button Functions

To switch the functions of the right and left mouse buttons for left-handed use:

- 1 Click the **Windows Start Button** on the taskbar.
- 2 Click **Control Panel**.
- 3 Click **Hardware and Sound**, if it is present.
- 4 Click **Mouse**.
- 5 Click the **Buttons** tab, and check **Switch primary and secondary buttons**.
- 6 Click **Apply** (using the new primary button) and then **OK**.

Changing Mouse Pointer Speed

To change the speed of the cursor on the screen relative to the motion of the mouse:

- 1 Click the **Windows Start Button** on the taskbar.
- 2 Click **Control Panel**.
- 3 Click **Hardware and Sound**, if it is present.
- 4 Click **Mouse**.
- 5 Click the **Pointer Options** tab.
- 6 In the *Motion* area, use the slider to adjust the pointer speed.
- 7 Click **Apply** and then **OK**.

Using the Windows Media Center Remote Control

(Select models only)

NOTE: The remote control is included with select models only. Features and location may vary.

The remote control is designed to work with Windows Media Center. You can use your remote control with Windows Media Center to play CDs and DVDs, view pictures, and much more.

This remote control helps you navigate the Windows Media Center windows on your computer just as a TV remote control helps you navigate cable TV options or control the playback of a movie in a VCR or DVD player.

The remote control can:

- Navigate and control all Windows Media Center windows.
- Control the video display.
- Place the computer in and out of sleep mode.
- Shut down or restart the computer.
- Log off from Windows Media Center or switch users.

The remote control cannot:

- Navigate the Windows desktop or control other computer programs outside of Windows Media Center.
- Be used as a VCR, DVD player, or stereo remote control.
- Turn on or off a TV that is connected to your computer (select models only).
- Turn on the computer.

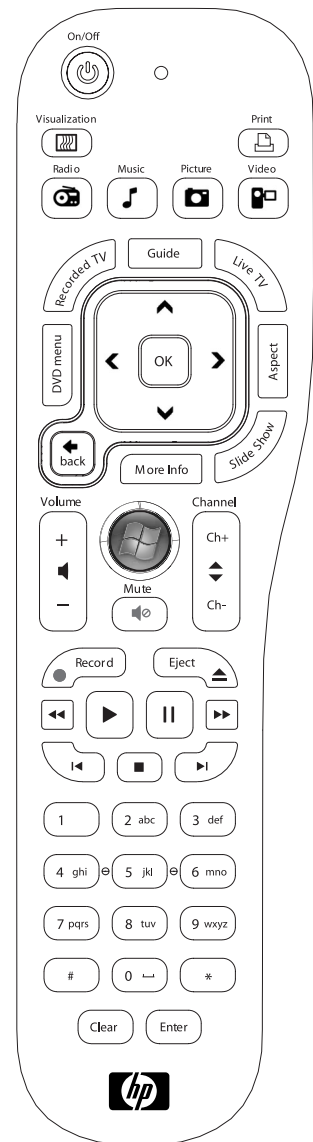

Remote Control Buttons Overview

- 1 **On/Off (Sleep)** — Puts the computer into and out of a power-reduced sleep mode. It does not turn the computer off.

- 2 **Visualization** — Displays visual imagery that is synchronized to the sound of your music tracks.

- 3 **Music** — Opens the Music Library window in Windows Media Center.

- 4 **Radio** — Opens the FM Radio window in Windows Media Center.

- 5 **Guide** — Opens the Television Program Guide.

- 6 **Recorded TV** — Opens the Recorded TV window where recorded TV programs are listed.

- 7 **Arrows** — Moves the cursor to navigate and select actions within all Windows Media Center windows.

- 8 **DVD Menu** — Opens the Play DVD window in Windows Media Center or opens the main menu of a DVD movie, if available.

- 9 **Back** — Returns to the previous window within Windows Media Center.

- 10 **i (More information)** — Displays available information about a selected media file and displays other menus.

- 11 **Start** — Opens the Windows Media Center main menu.

- 12 **Volume** — Increases (+) and decreases (–) volume.

- 13 **Mute** — Turns computer sound off. The word *Mute* is displayed when Mute is turned on.

- 14 **Record** — Records a selected television program and stores it on the hard disk drive.

- 15 **Play** — Plays the selected media.

- 16 **Rewind** — Moves the media backward at three speeds.

- 17 **Skip Backward** — Moves media backward 7 seconds, or to the beginning of a music track or a DVD chapter.

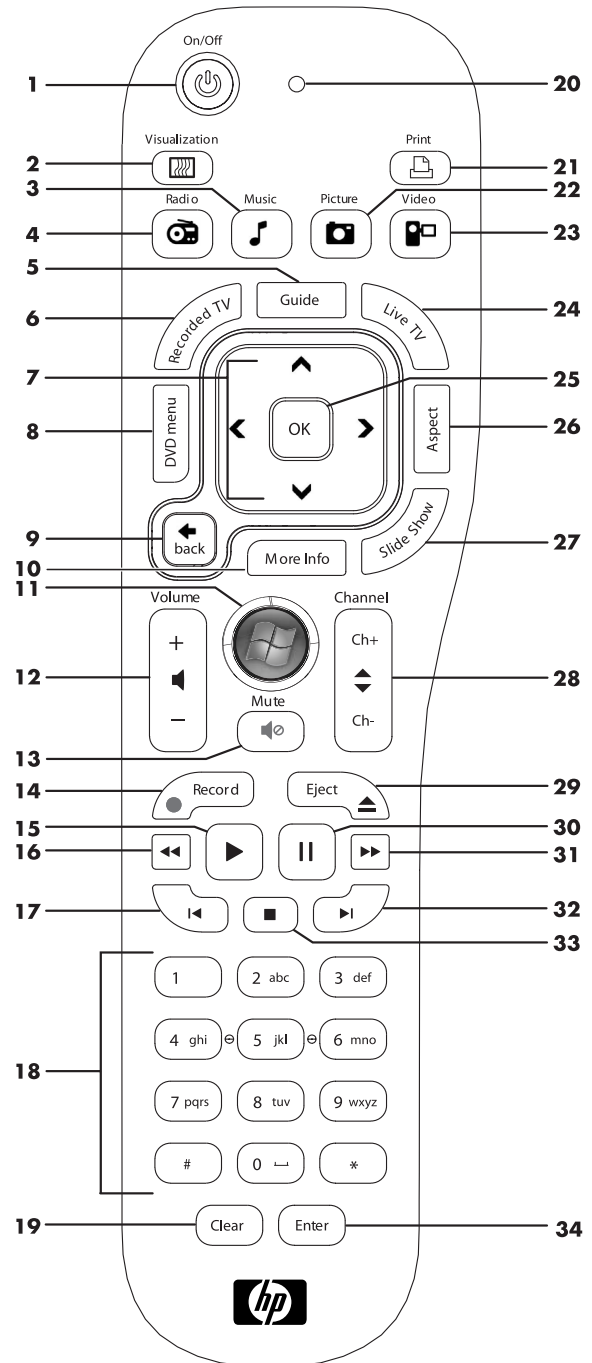

-
- 18 0 to 9, #, *** – Enters text and numbers into a Windows Media Center search or text box. Each time you press a number button, a different character appears. Press the Enter button to select a character.
-
- 19 Clear** – Deletes the last character entered.
-
- 20 LED** – Activity indicator light. The LED tells you that the remote control is emitting a signal when you press a button.
-
- 21 Print** – Prints an item in Windows Media Center.
-
- 22 Picture** – Opens the Pictures Library window in Windows Media Center.
-
- 23 Video** – Opens the Videos Library window in Windows Media Center.
-
- 24 Live TV** – Displays the full-screen view of live TV. Moves a TV program forward to the end of the pause buffer and resumes playing live TV.
-
- 25 OK** – Selects the desired action or window option and acts as the Enter key.
-
- 26 Aspect** – Changes the aspect ratio of the display. Zooms in on the picture three times then returns to the full-screen aspect ratio.
-
- 27 Slide Show** – Plays a slide show of all the pictures on your hard disk drive.
-
- 28 CH/PG up (+) and down (-)** – Changes the TV channels or moves pages up and down, depending on available options. Moves to the next DVD chapter.
-
- 29 Eject** – Ejects CD or DVD drive.
-
- 30 Pause** – Pauses audio and video tracks and live or recorded TV programs.
-
- 31 Fast Forward** – Moves media forward at three speeds.
-
- 32 Skip Forward** – Moves media forward 30 seconds in videos and live TV, one music track, or one DVD chapter.
-
- 33 Stop** – Stops the media currently playing.
-
- 34 Enter** – Selects the desired action, menu, or window option.
-

NOTE: The remote control requires two AA batteries. The remote control operates up to 8 meters (26 feet) away from the remote sensor. Make sure there is nothing blocking the pathway between your remote control and the remote sensor.

NOTE: Make sure you turn off the monitor and turn down or mute the volume, for example, if you have a scheduled recording in the middle of the night and do not want to be disturbed. The computer does not automatically go into sleep mode if Windows Media Center is open. It is recommended that you close Windows Media Center before you manually place the computer in sleep mode.

NOTE: If the computer model does not include a TV tuner, some remote control buttons are inactive.

About the Remote Control

Use the remote control to open the Windows Media Center program, and use it to view TV, record TV programs, play previously recorded TV programs, and play music, movies, or video.

To open Windows Media Center using the remote control, simply point it at the remote sensor, and press the Windows Media Center Start button. 

Use the remote control at a maximum distance of 8 meters (26 feet) from the remote sensor and at a maximum of 22.5 degrees (45 degrees total) from the center of the remote sensor.

NOTE: Use alkaline batteries in the remote control.

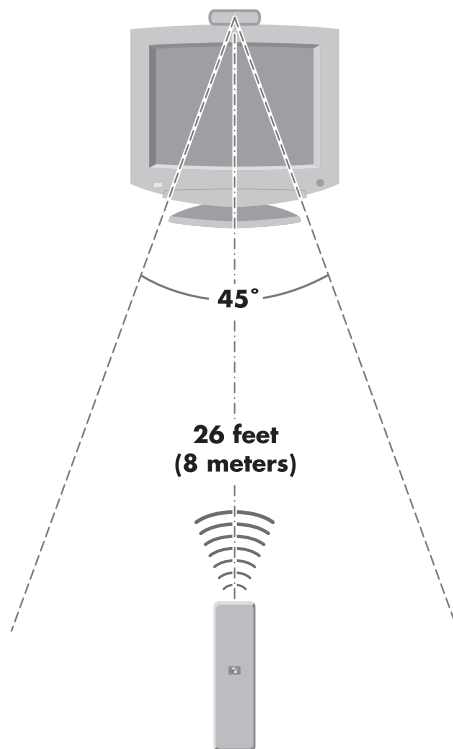

Troubleshooting the remote control

If your remote doesn't work:

- Make sure that the batteries for the remote control are charged and installed correctly.
- Make sure the front of the remote sensor (IR receiver) is not blocked.
- Point the remote control within a 45-degree angle range and less than 8 meters (26 feet) away.
- If a pressed key repeats itself or sticks, unplug the remote sensor from the USB connector, wait 1 minute, and plug the remote sensor back in. Try altering the lighting conditions in the room or moving the location of the remote sensor if this continues.
- Press the Enter button on the remote control after changing a channel.
- Point the remote control toward the remote sensor, and press a button. A faint red light should appear on the remote sensor. If the light appears, then the problem is probably in the Windows Media Center software. Close Windows Media Center, restart the computer, and then open Windows Media Center again.
- If the remote control works in Windows Media Center but not when changing channels, you need to reconfigure the Windows Media Center software settings for the cable set-top box or satellite receiver.

Remote sensor is not receiving a signal from the remote control

If a faint red light doesn't appear when you point the remote control at the remote sensor and press the OK button, try the following:

- 1 Click **Windows Start Button** on the taskbar, right-click **Computer**, and then select **Properties**.
- 2 Click **Device Manager**.
- 3 Click the plus (+) sign next to Universal Serial Bus Controllers.
- 4 If the *eHome Infrared Receiver* is listed under Universal Serial Bus Controllers, Windows is properly detecting the IR Receiver. If it is not listed, go to the next step.
- 5 Unplug the end of the USB cable on the remote sensor from the computer, and plug it into the same USB port.
- 6 Disconnect all other USB devices, leave the remote sensor plugged in, and then restart the computer. Plug in other USB devices after the remote sensor appears in the Device Manager window.

Introducing Your Computer Software

The operation of your computer is controlled by two kinds of software:

- The Microsoft Windows Vista operating system, which displays the desktop on the monitor and controls your computer's hardware, peripherals, and software programs.
- Software programs that perform specific functions, such as word processing.

The software programs included with the computer may vary by model and by country/region.

Learning More About Software

You can find information on using software, and on the Microsoft Windows Vista operating system in this guide and the onscreen Help. For Microsoft Windows Vista, you can also open the built-in Help and Support Center.

- Press the Help button (labeled with a question mark icon) on your keyboard (select models only).

Or

- Click the **Windows Start Button** on the taskbar, and then click **Help and Support**.

For help with specific software, refer to the onscreen Help within the program.

Using the Desktop

The *desktop* is the work area that appears on the monitor screen. It includes the taskbar along one edge, and shortcut icons that make it easy to find the things you need.

The taskbar shows the Windows Start Button, a button for each open window so you can switch between programs, and the notification area that includes the time.

A *shortcut icon* is a small picture that you click to open a folder or start a program. One icon on the desktop that performs a special function is for the Recycle Bin, which collects files or shortcuts that you delete. When you empty the Recycle Bin, the files or shortcuts are permanently deleted. You can retrieve items from the Recycle Bin until you empty it.

Removing desktop icons

You can remove most desktop icons by deleting them.

To delete a desktop icon:

- 1 Right-click the icon.
- 2 Click **Delete**.

Retrieving desktop icons

- 1 Open the **Recycle Bin** on your desktop.
- 2 Drag the icon onto the desktop.

Using the Windows Start Button Menu

Click the **Windows Start Button** on the taskbar to open the Start menu. From the Start menu, you can:

- Open programs or documents.
- Open the Help and Support Center.
- Start a search.
- Run a program.
- Open the Control Panel to view or change settings.

Using the All Programs menu

To find the software programs on your computer:

- 1 Click the **Windows Start Button** on the taskbar.
- 2 Click **All Programs**.

The All Programs menu displays a list of folders organized according to task (select models only).

A folder contains a list of items. Each item is actually a shortcut, or link, to a program, a document, or another folder. The Music folder, for example, contains shortcuts to the programs you use to play music CDs.

Organizing your All Programs list

To change the name of an item:

- 1 Right-click the item.
- 2 Click **Rename**.
- 3 Type the new name, and then press Enter on the keyboard.
- 4 Click **Yes** in the message that appears.

To copy an item:

- 1 Right-click the item.
- 2 Click **Copy**.
- 3 Go to the desktop or folder, right-click an empty area, and then click **Paste**.

If you use Add or Remove Programs in the Control Panel to delete a software program, the shortcut in All Programs may not be removed. To remove a shortcut:

- 1 Click the **Windows Start Button** on the taskbar.
- 2 Click **All Programs**.
- 3 Click the folder.
- 4 Right-click the shortcut, and then click **Delete**.

Using the Control Panel

The Control Panel is where you can set up or change properties and settings for the monitor, the keyboard, the mouse, the modem, a network connection, and other components and features of the computer. The Control Panel also provides tools for changing system performance, adding hardware, adding or removing programs, and other tasks.







To open the Control Panel:

- 1 Click the **Windows Start Button** on the taskbar.
- 2 Click **Control Panel**.

Resizing Windows

All windows have three buttons in the upper-right corner. The middle button is either the Maximize button or the Restore Down button, depending on the state of the window.



Feature	Name	Description
	Minimize	Collapses the window to the taskbar (but does not close it). To bring the window back up, click the taskbar button with the name of the window.
	Maximize	Expands the window to the full-screen size.
	Restore Down	Reduces the window from full-screen size so it covers only a portion of the screen.
	Close	Closes the window and stops the program or task.
	Resize	Resizes a window (not available when window is maximized). Move your mouse cursor over any window border until the cursor becomes a double-headed arrow. Click and hold down the left mouse button. Drag the border to the left or right to change the width. Drag the border up or down to change the height.
	Scroll bar	A scroll bar appears in a window when the information does not fit on one screen. Clicking and dragging a vertical scroll bar moves the screen up and down. Clicking and dragging a horizontal scroll bar moves the screen left and right.

Working with Digital Images

You can connect a digital image source, such as a digital camera or a digital video camera, to the computer either directly or through a docking station. Digital picture files you copy or download from the device appear in the Pictures folder.

Digital cameras and other digital imaging devices use memory cards, or media, to store digital picture files. You can copy digital picture files from the memory cards used by digital cameras and other digital imaging devices by using the memory card reader (select models only).

About the Internet

This section describes connecting to and using the Internet, including how to use a Web browser and electronic mail (e-mail).

Use the Internet to search for information or services on the Web, or to retrieve, read, or send e-mail messages.

The *Internet* is a group of computers that communicate with each other through telephone lines, digital services, or cable lines. Each Internet computer is independent, and its operators choose which files to make available to users of the Internet. To connect your computer to the Internet and use the information and services available there, you need an Internet Service Provider (ISP).

ISPs are businesses that give you access to the Internet, and most of them provide e-mail service. ISPs usually charge a monthly fee for their services. When your computer connects to the Internet, it is actually communicating with the Internet computer belonging to the ISP. The ISP verifies your account and then provides you access to the Internet. You use a Web browser program to search for and display Web site information. Some ISPs allow you to choose a browser program, while others provide their own browser.

Your connection to an ISP may be through a traditional telephone dial-up modem, a local area network (LAN), cable modem, digital subscriber line (DSL), or asymmetric digital subscriber line (ADSL). (DSL, ADSL, and cable ISPs are not available in all countries/regions.)

The *World Wide Web* (WWW), also called the *Web*, is a public part of the Internet used by individuals, companies, governments, and organizations. These individuals and groups have created millions of Web sites in support of their activities. A Web site consists of one or more Web pages. A *Web page* is a file or group of files that a user can access by entering the file location, or Uniform Resource Locator (URL).

The *URL* identifies a Web site location, typically in the form *http://www.name.extension* (for example, **http://www.hp.com**). The URL may include the path to a specific file within that site. Each period, or dot, in the URL separates elements within the address. For example, you will see the URL extension *.com* used by companies. When you enter the URL into your browser address box and press the Enter key on your keyboard, the browser contacts that location and displays the Web page for you.

Imagine you are reading a newspaper. On page 1, you may read something like *For more details, see page 3, column 2*. You turn the page for more information. A *hyperlink* on a Web page works the same way, except that you move to the new page by clicking the hyperlink. The way that a hyperlink links files together is what gives the Web its name, because the Web weaves together and connects ideas from all over the world.

Your *e-mail address* identifies the electronic post office box where people can send you electronic mail. E-mail addresses have the form *name@domain.extension*. The domain is usually the name of the ISP or organization. The extension usually identifies the type of organization. For example, if your name is Jane Jones, and XYZ is your ISP, your e-mail address might be *JaneJones@xyz.com*, with the extension *.com* indicating that XYZ is a company. For information on using e-mail, see "Sending and Receiving E-Mail."

Using a Browser

A Web browser program searches for and displays Web site information. How you explore the Internet depends on whether your ISP provides the browser or allows you to choose your own.

Once you are connected to the Internet, your browser displays the home Web page. You can go to a different Web site by entering its address (such as **http://www.hp.com**) into the address box in the browser, and pressing Enter on your keyboard. Or you can use the browser search feature to search for references to a specific word or phrase on the Web.

Searching the Internet

Most Web browser programs include a search feature. You may need to click a button or select a menu option to display the search feature, depending on the type of browser program. Type a question, or a word that describes the information you want to find, into the Search box, and then press Enter.

The Windows search feature includes direct use of Internet Explorer Search.

NOTE: If your ISP provides the browser, you may not be able to use Internet Explorer to search the Internet.

To begin a search:

- 1 Click the **Windows Start Button** on the taskbar.
- 2 Type a word or question; what you type automatically appears in the Search box. As you type, the search results appear in the left pane.
- 3 Do one of the following:
 - Click a result to open it.
 - Click the **X** to clear the results of the search and return to the main list of programs.
 - Click **Search the computer** to show the results in a folder for advanced options.
 - Click **Search the Internet** to search the Internet by opening your browser.

Restricting Internet content

The Internet provides you with a wide variety of information, but some information may not be suitable for every viewer. With Content Advisor (a feature of Internet Explorer), you can:

- Set up a password.
- Control Internet access.
- Set up a list of Web sites that people who use your computer cannot view.
- Adjust the type of content people can view with and without your permission.

Once you set up restricted rating levels in Content Advisor, users can view Web sites and other pages that you have specified under the rating setup. However, to view unrated Web sites or pages, they must enter the Content Advisor password that you have set. This means that any unrated page, even Help and Support or Internet Explorer, is not viewable if the user does not know the password. To allow access to an unrated site or page you approve of, open it and, when the password window appears, select the **always allow viewing** or **allow viewing only this time** option.

To enable Content Advisor:

- 1 Click the **Windows Start Button** on the taskbar.
- 2 Click **All Programs**.
- 3 Click **Internet Explorer**.
- 4 Click **Tools**, and then click **Internet Options**.
- 5 Click the **Content** tab.
- 6 In the *Content Advisor* area, click **Enable**.
- 7 Click the **General** tab, click **Create Password**, and type a password.
- 8 Click **OK**, and then click **OK** again.

Using Antivirus Software

When you use the computer for e-mail, network, or Internet access, you expose it to computer viruses. Computer viruses can disable or damage your operating system, software programs, or computer utilities.

Antivirus software can detect most viruses, destroy them, and, in most cases, repair any damage viruses may have caused. To provide ongoing protection against newly discovered viruses, antivirus software must be kept up to date.

Norton Internet Security, an antivirus software program, is preinstalled on your computer and includes a free trial subscription of protection updates. You can enable Symantec's LiveUpdate™ to obtain protection updates automatically whenever you are online. HP strongly recommends that you protect the computer against new viruses beyond the trial period by purchasing an extended update service.

Configuring and registering Norton Internet Security software

When you first set up the computer, Norton Internet Security helps you to configure and register your copy of Norton Internet Security.

Be sure to set up Norton Internet Security before you start surfing the Internet.

- 1 Double-click the **Norton Internet Security** icon on the desktop.

Or

Click the **Windows Start Button** on the taskbar, click **All Programs**, click **Norton Internet Security**, and then click **Norton Internet Security** again.

- 2 Click **Next** and follow the onscreen instructions if prompted.

For information about using and updating the Norton Internet Security software, you can click the **Windows Start Button** on the taskbar, click **Help and Support**, and then type *virus* into the Search Help box.



Changing the virus scan time for your Norton Internet Security program

To change the Norton Internet Security scan time:

- 1 Double-click the **Norton Internet Security** icon on the desktop.

- 2 At the top of the main window, click the **Norton Internet Security** tab.

- 3 Click the **Tasks** bar.

- 4 Click **Run a Scan**.

- 5 Click **Run Custom Scan**.

- 6 In the Scans dialog box, next to the custom scan you want to schedule, click **Schedule**.

- 7 In the Schedule dialog box, if *Show multiple schedules* is checked, click **New** to turn on the scheduling fields. If it is not checked, the fields are already enabled.

- 8 Set the frequency and time you want the scan to run.

- 9 When you are done, click **OK**.

NOTE: If the computer is in sleep mode, the Norton Internet Security program does not perform a scheduled antivirus scan.



Sending and Receiving E-Mail

E-mail enables you to send and receive letters, pictures, postcards, and even music and video clips.

NOTE: E-mail may contain a virus in the message itself or as an attachment. To protect your computer, do not open any message that originates from an unfamiliar source or that appears suspect to you. Instead, delete such messages.

Your computer comes with an e-mail program from Microsoft called Windows Mail (select models only). You may also use e-mail programs from other vendors. Some ISPs provide their own e-mail programs. You use an e-mail program to send, receive, and organize your messages. You can organize, read, and create new messages even when you are offline (not connected to the Internet).

Using Windows Mail

To set up Windows Mail, you first need some information from your ISP: your e-mail address, user name, password, the names of your incoming and outgoing e-mail servers, and perhaps some other details.

The first time you start Windows Mail, make sure the computer is connected to the Internet, and follow the wizard to set up your account.

- 1 Click the **Windows Start Button** on the taskbar.
- 2 Click **All Programs**.
- 3 Click **Windows Mail**.

To add an account in Windows Mail:

- 1 Click the **Windows Start Button** on the taskbar.
- 2 Click **All Programs**.
- 3 Click **Windows Mail**.
- 4 Click **Tools**, and then click **Accounts**.
- 5 Click **Add e-mail Account**, and then click **Next**.
- 6 Follow the onscreen instructions to add your account.

Using the e-mail program provided by your ISP

Follow the instructions provided by your ISP to install its Web browser and e-mail program, and to set up and use your e-mail account. You will then be able to send and receive e-mail when your computer is connected to your ISP.

Software Quick Reference Table

(Select models only)



Your computer includes a number of software programs that:

- Record and play CDs.
- Record data CDs.
- Import and edit video files.
- Record video CDs and DVDs.
- Organize digital media files.

The following table describes the functionality specific to each of these programs. Use the table to determine which program to use to perform a task.

Note that some programs listed may not be included with your model, and that this is not a complete list of all included software.

To open any of these programs, click the **Windows Start Button** on the taskbar, choose **All Programs**, select the program folder (for example, **DVD Play**), and then click the program name to open the software.

With this program:	You can:
DVD Play (select models only) 	<ul style="list-style-type: none">■ Play DVD movies and video CDs (VCDs). (High Definition playback is supported.)■ Use the Zoom and Pan features.■ Create viewing bookmarks.
HP Photosmart Essential (select models only) 	<ul style="list-style-type: none">■ View, organize, and print your photos.■ Share your photos with friends and family.■ Create electronic photo albums.■ Edit your photos: crop, resize, flip, rotate, make black and white, change the contrast, and more. <p>To open this program, click the Windows Start Button, All Programs, HP, and then click HP Photosmart Essential.</p>

With this program: **You can:** *(continued)*

Real Rhapsody
(select models only)



- Play music CDs, .mp3s, and other audio files.
- Record music files.
- Record a copy of an existing music or data CD to use on the computer.
- Organize digital files into a library for recording or listening.

muvee autoProducer
(select models only)



- Add your own style to your movies with music, pictures, titles, scene transitions, and captions.
- Edit your home movies.
- Save and burn multiple movie files to DVD.
- Use the Magic Spot feature to control the motion effects applied to your pictures.

RealPlayer
(select models only)



- Play music CDs, .mp3s, and other audio files.
- Play DVD movies. (RealPlayer can play DVDs only if another DVD player program, such as DVD Play, is installed.)
- Play video CDs.
- Record music files.
- Organize digital files into a library for recording or listening.

Roxio Creator
(select models only)



- Record data and music files.
- Record a copy of an existing music or data CD to use on the computer.
- Create customized music CDs from CDs in your collection, or from .wav, .mp3, or .wma files. These CDs can be played in your home or car stereo.
- Copy and share data files.
- Create archive CDs or DVDs from files on your computer.
- Copy video files.
- Verify that the disc has been created without errors.

Roxio MyDVD
(select models only)



- Record movie files to create VCDs and DVDs that you can play on some DVD players.
- Copy and share video files.
- Capture video files.
- Edit video files.

With this program: **You can:** *(continued)*

Backup My PC
(select models only)

- Create computer backup files to protect your data and other important files on your computer.

NOTE: This software is included with the Personal Media Drive only.

HP Total Care Advisor
(select models only)

- Quickly organize the Web links you want to keep available to you on your desktop.
- Comparison-shop using the convenient shopping search engine.
- Get HP software and driver updates.
- Get important messages from HP.
- Access PC Health and Security and PC Help tools.

Microsoft Windows
Movie Maker
(select models only)



- Import audio, video, and other media files from videotape, audiotape, Web cameras, or television broadcasts.
- Record audio and video files to create a video project that becomes a Microsoft Windows Media source file with a .wmv extension.
- Edit and preview files.
- Send a movie in an e-mail or upload it to a Web server.
- Add music files (.mp3).
- Import audio files such as .mp3, .asf, or .wma; video files such as .wmv, .asf, .avi, or .mpg; or image files such as .jpg or .gif.
- Create .avi and .wmv (Windows Media Video) files.

NOTE: You may have a software update CD included with your computer. You may need to install this CD before using the DVD Writer/CD Writer drive. To do this, follow the installation instructions that came with the CD.

Managing Files

A *file* is any unit of information that is named and stored on your computer hard disk drive or other electronic storage media, such as a CD, diskette, or even in a digital camera. A file can be an application program, a picture, music or sounds, a document, or data. Almost everything you do on your computer involves working with files.

The computer can copy files to other storage media within component drives, such as diskettes, memory cards, CDs or DVDs, or it can send them to output devices, such as a printer.

Organizing Files with Folders

In Windows Vista, folders enable you to organize the files on your computer. Like paper folders within a filing cabinet, folders on your computer provide a way to group related files together.

A folder can contain any type of file, and it can even contain other folders. Each file within a folder must have a unique name, but two different folders can have files with the same name.

There are two methods for working with the files and folders on your computer:

- The Computer view enables you to quickly see all the files and folders within a specific folder on your computer. It also contains links to common tasks for managing your files, such as copying, moving, deleting, and renaming.

To open the Computer view, click the **Windows Start Button** on the taskbar, and then click **Computer**.

- Windows Explorer enables you to quickly see all the folders and files on your computer. It also makes it easy to move or copy files from one folder to another.

To open Windows Explorer, right-click **Windows Start Button** on the taskbar, and then click **Explore**.

To navigate the Computer and Windows Explorer views, double-click folders to open and display their contents. Click the **Back** arrow button to retrace your path through the opened folders.

Creating Folders

- 1 Click the **Windows Start Button** on the taskbar, and then click **Computer**.
Or
Right-click **Windows Start Button** on the taskbar, and then click **Explore**.
- 2 Navigate to the location where you want the new folder.
- 3 Click **Organize** and then **New folder**.
- 4 Type a name for the folder, and then press Enter on the keyboard.

Moving Files



CAUTION: Do not move any file that is part of an installed program. Doing so can cause the program to become unusable.

- 1 Click the **Windows Start Button** on the taskbar, and then click **Computer**.
Or
Right-click **Windows Start Button** on the taskbar, and then click **Explore**.
- 2 Find the file you want to move, and click to select it.
- 3 Click **Organize** and **Cut**.
- 4 Find and open the folder where you want to put the file.
- 5 Click **Organize** and **Paste**.

NOTE: You can also move files by dragging them into a new location. (You can have two or more Windows Explorer windows open at one time.) Select an item in Computer or in Windows Explorer, and then press and hold the right mouse button while moving the item into another folder. Release the mouse button and click **Move Here** to place the item in the new location.

Finding Files

To find a file, you can use the Search box at the top of every folder, or the search box on the Windows Start Button menu, which searches the whole computer.

To search from a folder Search box:

- 1 Click the **Windows Start Button** on the taskbar, and then click **Computer**.

Or

Right-click **Windows Start Button** on the taskbar, and then click **Explore**.

- 2 Find the folder you want to search. Search looks in the current folder and all subfolders.
- 3 Click into the search box at the top of the window and begin to type.

The Search box filters according to what you type. It displays files if your term matches the file name, tags, or other file properties. It displays text documents if the term occurs in any of the text inside the document file.

To search from the Windows Start Button menu:

- 1 Click the **Windows Start Button** on the taskbar.
- 2 Type a word or question; what you type automatically appears in the Search box. As you type, the search results appear in the left pane.
- 3 Do one of the following:
 - Click a result to open it.
 - Click the **X** to clear the results of the search and return to the main list of programs.
 - Click **See all results** to show the results in a folder for advanced options.
 - Click **Search the Internet** to search the Internet by opening your browser.

Renaming Files



CAUTION: Do not change the file name extension (the last three characters of a file name, after the period). Doing so could make the file unrecognizable to the computer.

- 1 Click the **Windows Start Button** on the taskbar, and click **Computer**.
Or
Right-click **Windows Start Button** on the taskbar, and click **Explore**.
 - 2 Find the file or folder you want to rename and click it to select it.
 - 3 Click **Organize** and **Rename**.
 - 4 Type the new name, and then press Enter on the keyboard.
-

NOTE: Another way to rename a file is to right-click the file and then click **Rename**.

Deleting Files



CAUTION: Do not delete any file that is part of an installed program. Doing so can cause the program to become unusable.

- 1 Find the file you want to delete, and click to select it.
- 2 Click **Organize** and **Delete**.
- 3 Click **Yes** to confirm the delete and send the file to the Recycle Bin.

If you make a mistake and need to retrieve the deleted file, see “Retrieving Files from the Recycle Bin.”

NOTE: Another way to delete a file is to right-click the file and then click **Delete**.

Retrieving Files from the Recycle Bin

If you discover that you need a file that you have deleted, you can usually retrieve it from the Recycle Bin. When a file is deleted, it goes to the Recycle Bin and stays there until the Recycle Bin is emptied manually or it is cleared to make room for more recently deleted files.

- 1 Double-click the **Recycle Bin** icon on your desktop.
- 2 Find the file you want to retrieve, and click to select it.
- 3 Click **Restore this item**.

The file is removed from the Recycle Bin and goes back to its previous location.

Copying Files

- 1 Click the **Windows Start Button** on the taskbar, and then click **Computer**.
Or
Right-click **Windows Start Button** on the taskbar, and then click **Explore**.
- 2 Find the file you want to copy, and click to select it.
- 3 Click **Organize** and **Copy**.
- 4 Find and open the folder where you want to put the file.
- 5 Click **Organize** and **Paste**.

NOTE: You can also copy files by dragging them into a new location. Select an item in Computer or in Windows Explorer and then press and hold the right mouse button while moving the item into another folder. Release the mouse button and select **Copy Here** to copy the item to the new location.

Using a Printer

For instructions on connecting and using the printer, refer to the user manual that came with your printer.

Printers receive instructions from your computer by means of software programs called printer drivers. In many cases your computer automatically finds the necessary printer driver for your particular printer to work with your computer. If it does not, follow instructions that come with your printer to install the specific printer driver manually.

You can print text and graphics from most software programs and Web sites if you have a printer connected to your computer, and if the computer has the necessary software installed for the printer.

To print:

- 1 Click **File** on the program menu bar, and click **Print**.
- 2 Select your printing options:
 - Select the printer.
 - Choose the page range (for example: all pages, current page, or range of pages).
 - Determine the number of copies.
 - Select all, odd, or even pages in a range.
- 3 Click **OK** or **Print**.

Using CD and DVD Media Drives

Using Your CD and DVD Drives

Your computer can come with several types of CD or DVD drives that allow you to do different tasks. What you can do depends on what kind of drive you have.

Allows you to:	CD-ROM	CD-RW	DVD-ROM	DVD+RW/+R
Read data from CDs	•	•	•	•
Play music CDs	•	•	•	•
Read DVDs			•	•
Record (burn) data or music to discs		•		•
Play DVD movies			•	•
Record (burn) DVD movies				•

The combination (combo) drive is available on select models only. It combines the functions of two drives into one: either a DVD+RW/+R drive (DVD writer) and a CD-RW drive (CD writer), or a DVD-ROM drive and a CD-RW drive.

Handling CDs and DVDs

To avoid damaging a disc, follow these guidelines:

- Return the disc to the case when you are finished using it.
- Handle the disc by its outside edges or center hole only.
- Do not touch the unlabeled side of a disc or place the unlabeled side down on your desk. Doing so could scratch the surface of the disc.
- Store discs at room temperature.

Inserting and removing CDs and DVDs



CAUTION: Use only standard-shaped (circular) discs in your drives. Using non-standard discs, such as heart-shaped discs or business-card discs, may damage your drive.

To insert a CD or DVD:

- 1 With your computer turned on, press the Eject button near the front of the drive to open the disc tray.

NOTE: On some computers, the drive is located behind a door on the front of the computer.

- 2 Remove the CD or DVD from its case, holding the disc edges or center hole only.
- 3 Gently place the disc in the tray with the label facing up.

NOTE: On a double-sided DVD, read the text around the center hole to determine which side (A versus B or Standard versus Widescreen) to play. Place the disc in the tray with the label facing up for the side you want to play.

- 4 Close the disc tray by:

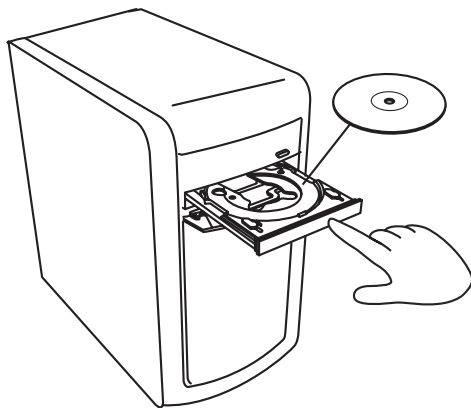

- Gently pushing the tray into the computer.

Or

- Clicking the open/close button on the control panel for the program that controls the drive.

Or

- Pressing the media control open/close button or Eject button on the keyboard (select models only).

Or

- Pressing the Eject button on the drive, if it is accessible.

To remove a CD or DVD:

- 1 With the computer turned on, open the disc tray by pressing the Eject button.
- 2 Holding on to the disc edges or center hole only, lift the CD or DVD out of the tray.
- 3 Place the disc in its case.
- 4 Close the disc tray by gently pushing the tray into the computer.

Compatibility Information

An important feature of a DVD Writer/CD Writer drive is its high level of compatibility with other optical drives and CD and DVD players:

- The CDs that you create play in most home and car stereos and in most computer DVD-ROM and CD-ROM drives.
- The DVDs that you create are compatible with some DVD video players and with most computer DVD-ROM drives.
- CD-R discs are more compatible with home and car stereos than CD-RW discs are.

Your DVD Writer/CD Writer drive is able to read from and record to almost every type of optical disc. Writing speed rates for the DVD Writer/CD Writer drive are fast, allowing quick recording times.

Disc Features and Compatibility Table

Disc	File type	Can be recorded onto	Plays in computer	Plays in home or car stereo	Plays in home DVD player
CD-ROM	Data	No	Yes	No	No
	Music	No	Yes	Yes	Varies by model
CD-R	Data	Yes	Yes	No	No
	Music	Yes	Yes	Varies by model	Varies by model
CD-RW	Data	Yes	Yes	No	No
	Music	Yes	Yes	Varies by model	Varies by model
DVD-ROM	Data	No	Yes	No	No
	DVD movie	No	Yes	No	Yes
DVD-RAM	Data	Yes	Varies by model	No	No
	DVD movie	Yes	Varies by model	No	Varies by model
DVD+R and DVD-R	Data	Yes	Yes	No	No
	DVD movie	Yes	Yes	No	Varies by model
Double-layer DVD+R/DVD-R	Data	Yes	Varies by model	No	Varies by model
	DVD movie	Yes	Varies by model	No	Varies by model
DVD+RW and DVD-RW	Data	Yes	Yes	No	No
	DVD movie	Yes	Yes	No	Varies by model
VCD	DVD movie	No	Yes	No	Varies by model

NOTE: Some computers come with the double-layer DVD Writer. It supports single-layer and double-layer DVD media. Double-layer technology gives you greater capacity and allows you to store up to 8 GB* of data on double-layer DVD+R or DVD-R media. Double-layer is a new technology. Double-layer media compatibility varies widely with some home DVD players and DVD-ROM drives. *1 GB is defined as 1 billion bytes. 1 GB = 1 billion bytes when referring to hard disk drive capacity. Actual formatted capacity is less.

For the latest disc compatibility information for your computer, go to the HP Support Web site at:
<http://www.hp.com/support>

NOTE: Double-layer DVD technology is supported by select models only.

NOTE: The Roxio Creator recording programs support the double-layer technology.

Optical Drive Quick Reference Table

Optical drive can:	CD-ROM	CD-RW	DVD-ROM	DVD-RAM	DVD+RW/+R DVD-RW/-R	Double-layer DVD	Combo CD-RW/DVD	LightScribe DVD+RW/+R
Read CDs, CD-Rs, and CD-RWs	Yes	Yes	Yes	Yes	Yes	Yes	Yes	Yes
Read DVDs	No	No	Yes	Yes	Yes	Yes	Yes	Yes
Read data on a CD	Yes	Yes	Yes	Yes	Yes	Yes	Yes	Yes
Play music	Yes	Yes	Yes	Yes	Yes	Yes	Yes	Yes
Record data or music to disc for storage or backup	No	Yes	No	Yes	Yes	Yes	Yes	Yes
View DVD movies	No	No	Yes	Yes	Yes	Yes	Yes	Yes
Record DVD movies	No	No	No	Yes	Yes	Yes	No	Yes
Play games	Yes	Yes	Yes	No	Yes	Yes	Yes	Yes
Create LightScribe label	No	No	No	No	No	No	No	Yes

Using the Memory Card Reader

Digital cameras and other digital imaging devices use memory cards, or *media*, to store digital picture files. The optional memory card reader (select models only) can read from and write to a variety of types of memory cards and the IBM Microdrive disk drive.

The card reader is accessible directly on the front of the computer. It has four or two horizontal card slots, which accept the memory cards and the Microdrive disk drive.

You can place media in one or more of the card slots and use each media independently. Place only one piece of media in a slot at one time.

Each card slot has its own drive letter and icon. When you insert media, the display label may change to the title of the media, if the title is present.

When you insert media, the Safely Remove Hardware window may appear. If it opens, or if you open the Safely Remove Hardware window by mistake, click **Close**.



CAUTION: Do not click *Stop* in the Safely Remove Hardware window with the USB Mass Storage Device selected. Doing so removes the operating system recognition of the memory card reader from your computer, and you must restart the computer to see your memory card reader again.

- 1 Insert the media into the card slot until it stops.

The activity light **(A)** on the memory card reader lights, and the computer automatically detects the media.

NOTE: You must insert media correctly. Note the direction of the notched corner on the media. For more information, see "Media Insertion Guide." CompactFlash and Microdrive are keyed and cannot be inserted incorrectly. Insert the receptacle edge (holes) of this media into the slot.

- 2 An Autoplay window opens. Select a program to access your files. The computer opens a program so you can access the media contents. You can copy files from or to the media.

Or

If the Autoplay window does not open, click **Windows Start Button** on the task bar, click **Computer**, and then double-click the **Memory Card** icon to display the files on the memory card.

- 3 When you are finished, right-click the drive icon, click **Eject**, check that the activity light is on but not blinking, and then remove the media. A steady activity light indicates that the computer is not reading or writing the media card.



CAUTION: Do not try to remove media when the activity light is blinking. Doing so may cause loss of data.

Media Insertion Guide

4-slot memory card reader (select models only)

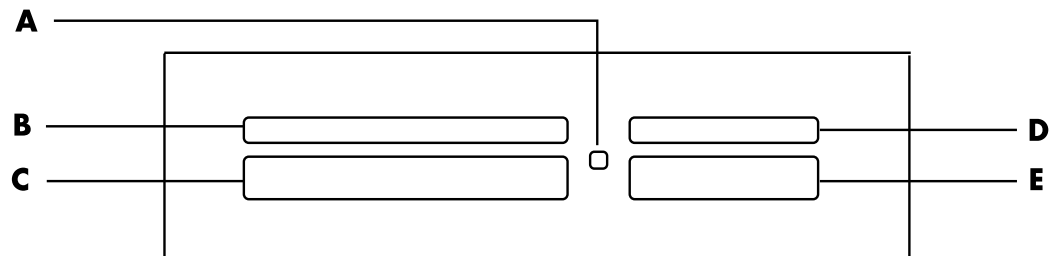

- A Activity light
- B Upper-left slot
- C Lower-left slot
- D Upper-right slot
- E Lower-right slot

Card	Insert the media	4-slot reader location
CompactFlash Type I media	Receptacle edge (holes)	C (lower-left)
CompactFlash Type II media	Receptacle edge (holes)	C (lower-left)
IBM Microdrive disk drive	Receptacle edge (holes)	C (lower-left)
Secure Digital (SD) memory card	Facing up	D (upper-right) 
Mini Secure Digital (MiniSD) Memory Card*	Facing up	D (upper-right) 
MultiMediaCard (MMC)	Facing up	D (upper-right) 
Reduced size MultiMediaCard (RSMMC)*	Facing up	D (upper-right) 
MultiMediaCard Plus (MMC +)*	Facing up	D (upper-right) 
MultiMediaCard Mobile (MMC Mobile)*	Facing up	D (upper-right) 
Memory Stick (MS) memory card	Facing up	E (lower-right) 
Memory Stick (MS-Pro) memory card	Facing up	E (lower-right) 
Memory Stick (MS-Pro Duo) memory card*	Facing up	E (lower-right) 
Memory Stick (MS-Duo) memory card*	Facing up	E (lower-right) 
SmartMedia (SM) memory card	Facing up	B (upper-left) 
xD media	Facing up	B (upper-left) 





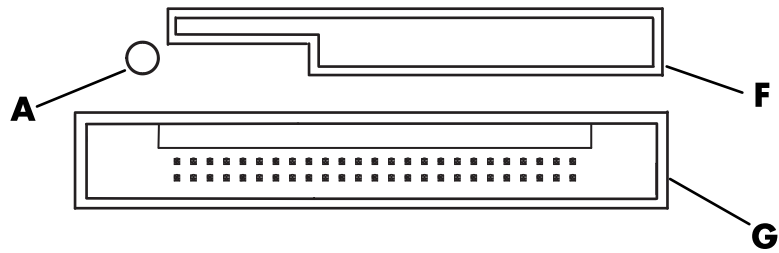

*Select models only. Not available in all countries/regions.

NOTE: Some memory cards, such as CF Ultra/III, are not compatible with the memory card reader that came with your computer.

2-slot memory card reader (select models only)



- A** Activity light
- F** Upper slot
- G** Lower slot

Card	Insert the media	2-slot reader location
Secure Digital (SD) Memory Card	Facing up (gold connector fingers down)	F (upper) 
MultiMediaCard (MMC)	Facing up (gold connector fingers down)	F (upper) 
Memory Stick (MS) Memory Card	Facing up (gold connector fingers down)	F (upper) 
Memory Stick (MS-Pro) Memory Card	Facing up (gold connector fingers down)	F (upper) 
SmartMedia (SM) Memory Card	Facing down (gold connector fingers up)	F (upper) 
xD media	Facing up (gold connector fingers down)	F (upper) 
IBM Microdrive disk drive	Receptacle edge (holes)	G (lower)
CompactFlash Type I media	Receptacle edge (holes)	G (lower)
CompactFlash Type II media	Receptacle edge (holes)	G (lower)

NOTE: Do not use SM and xD media in the memory card reader at the same time. Only the first one inserted is recognized by the memory card reader.

Understanding the Activity Light

The memory card reader activity light is off when there are no media cards plugged into the slots.

The light turns on when a media card is inserted into a slot.

The light blinks when data is being transferred between the card and the computer.

Formatting a Memory Card

If you have not used the memory card before, or if the card has become corrupted, you may need to format it before using it.

NOTE: Some memory cards have a lock position. To view or edit your photos, make sure the memory card is in the unlocked position.

- 1 Format your memory card in your digital camera. Follow the instructions that came with your digital camera.
Or
Insert the media into the correct card slot on the reader until it stops and locks into place. The activity light on the memory card reader lights, and the computer automatically detects the media.
- 2 Click the **Windows Start Button** on the taskbar, and then click **Computer**.
- 3 In the *Devices with Removable Storage* area, right-click the correct memory card icon.
- 4 Select **Format**, and then type a label name into the label box.
- 5 For best compatibility, select **FAT** as the file system settings.
- 6 Click **Start**.
- 7 Click **OK** in the Format Complete window, and then click **Close**.

Troubleshooting the Memory Card Reader

If you are having problems reading from or writing to a memory card, try the following:

- Some cards have a read/write or security switch on the card. Make sure the read/write switch is set to Write Enabled before attempting to write data to the card.
- Make sure the amount of data you want to store is not larger than the storage limit of the memory card.
- Make sure the memory card is one of the supported types: CompactFlash Type I and II, Microdrive, Memory Stick, Memory Stick Pro, MultiMediaCard, Secure Digital, SmartMedia, or xD media.
- Make sure the memory card is fully inserted into the correct slot.
- Remove the memory card when the activity light is not blinking, and shine a flashlight into the empty slot. If any of the pins are bent, replace the memory card reader, or have the computer serviced if a pin is touching another pin. To straighten slightly bent pins, use the tip of a fine-point retracted ballpoint pen with the computer off.
- Inspect the ends of the memory cards for anything that could be blocking a proper connection. Clean the contacts with a lint-free cloth and small amounts of alcohol. Replace the memory card, if necessary.
- The memory card reader is a device that uses the Safely Remove Hardware task. This appears as a taskbar icon next to the time. Do not click **Stop** in the Safely Remove Hardware window. Doing so disconnects the drive. If this happens, restart the computer.
- Do not insert or remove memory cards when the activity light is blinking. Doing so may cause data loss, or it may permanently damage the card reader.
- Format a memory card before you use it. See “Formatting a Memory Card.”

Using the HP Personal Media Drive and HP Pocket Media Drive

The HP Personal Media Drive and the HP Pocket Media Drive (HP Media Drives) can be used as internal or external USB hard disk drives designed to quickly and easily increase your storage capacity and to transfer media files such as digital photos, music, videos, and other important files. You can also use the HP Media Drives to back up other drives on your computer.

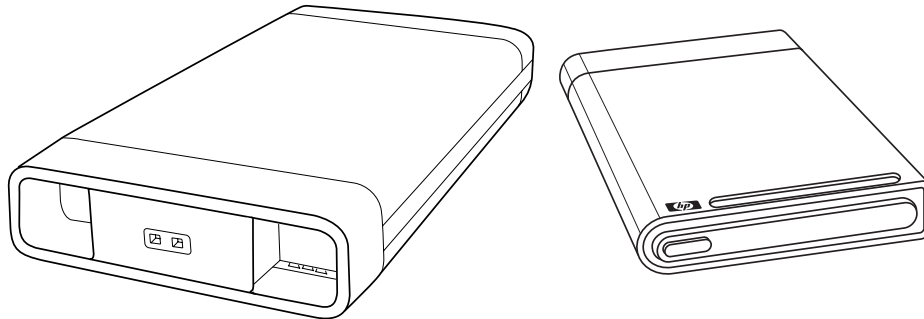

NOTE: The HP Personal Media Drive and the HP Pocket Media Drive are included with select models only. Both drives are sold separately.

The HP Media Drives are designed to:

- Work with computers that have a USB port.
- Store large media files and personal files from your digital cameras, digital video camcorders, and MP3 players.
- Quickly transfer files between PCs.
- Play media files.
- Back up your files. Perform system backups for added data security.

For more information about using your HP Media Drives with Windows Media Center, refer to the documentation on the HP Support Web site at:

<http://www.hp.com/support>

Connecting the Drive

Your HP Media Drive is designed to work with most computers as an external drive that is connected by using a USB cable, but it also can be inserted into specifically designed HP computers. These computers have a special horizontal or vertical drive bay that connects to the drive by using an internal USB connector. The drive can be easily inserted and removed from the hard disk drive bay without turning off the computer. This is sometimes referred to as *warm-swappable*.

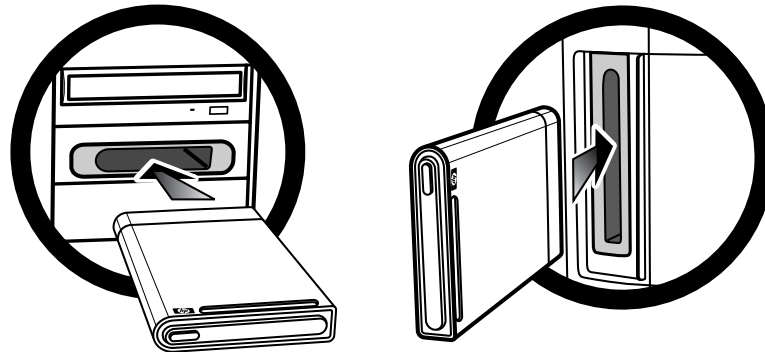

The drive turns on when it is plugged into an active USB port. If the computer is turned on with the drive connected, the drive automatically turns on. When the USB cable for the drive is not plugged in or when the USB power from the computer is turned off, the drive automatically turns off. When the computer is in sleep mode (a reduced power state), the drive remains turned on.



WARNING: Do not move the computer with the HP Media Drive inserted in the bay or connected to a USB port on the computer. This can cause both damage to the drive and data loss.

Inserting the Drive into an HP drive bay

- 1 Turn on the computer.
- 2 In the horizontal position, insert the drive with the HP logo facing up and the HP product name right-reading. In the vertical position, the drive's flat side is down, and the rounded side is up. Do not force the drive into the bay; it should slide easily into the bay.
- 3 Slide the drive all the way into the drive bay until the drive is firmly connected to the internal connections. With the computer turned on and the drive inserted correctly, the power LED (**B**, **D**) on the front of the drive is lit.

HP Media Drive fronts

- A** Drive activity indicator light
- B** Power on indicator light
- C** HP Personal Media Drive guide ridges
- D** Power/drive activity LED indicator

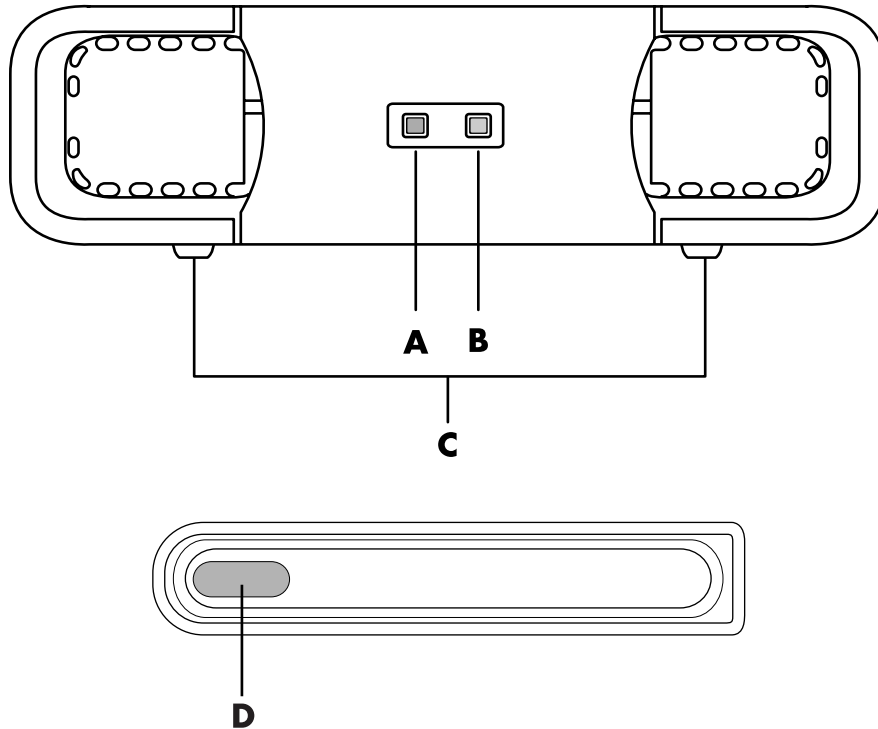

HP Personal Media Drive (**A, B, C**)

HP Pocket Media Drive (**D**)

Connecting the Drive to a Computer Without a Drive Bay

The HP Media Drives are designed to work with most computers as an external hard disk drive that you connect by using a USB 2.0 cable. If your computer has USB 1.1 ports, use two USB ports to insure that enough power is supplied. Most USB 2.0 ports can supply enough power so that only one USB connection is provided.

When connecting the drive to a computer without a drive bay, the HP Personal Media Drive requires a separate power supply in addition to a USB 2.0 connection. The HP Pocket Media Drive does not require a separate power supply because power is supplied through the USB 2.0 connection.

NOTE: The HP Personal Media Drive comes with a built-in fan; the HP Pocket Media Drive does not come with a fan.

To connect the drive:

- 1 Turn on the computer.
- 2 Plug the rectangular end of the USB 2.0 cable (**C**) into an available USB port on your computer. Plug the square end of the USB 2.0 cable (**D**) into the USB connector on the back of the HP Media Drive.

NOTE: USB 2.0 uses only one USB connector. USB 1.x systems use both USB connectors.

- 3 Install the software and drivers. Refer to the HP Media Drive documentation for more information.

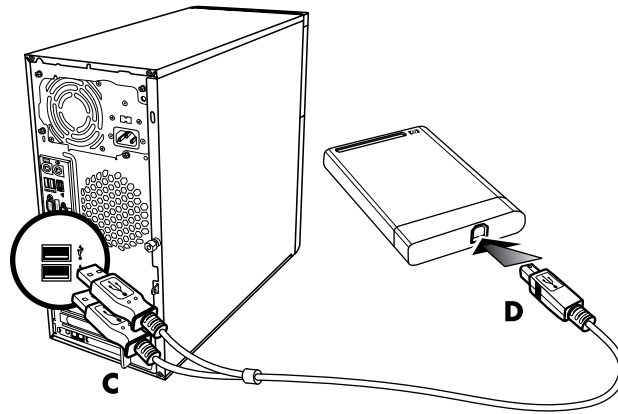

Locating the Drive and Assigning a Drive Letter

When you plug the drive into an USB 2.0 connector or insert it into an HP Media Drive bay, the operating system automatically assigns a letter to the hard disk drive. The assigned letter depends on other storage devices connected to your computer.

To locate the drive:

- 1 Click the **Windows Start Button** on the taskbar.
- 2 Click **Computer**.
- 3 Select the drive under Hard Disk Drives or Devices with Removable Storage. The default volume name of this drive is *HP Personal Media Drive* or *HP Pocket Media Drive*.

You can rename the drive in the Computer window by right-clicking the drive, selecting **Rename**, and then typing in a new name. HP recommends renaming a drive if you have more than one external hard disk drive.

You can permanently assign a drive letter to avoid the letter changing when you connect and disconnect this drive and other devices. Also, it is easier for a software program to locate the files on the HP Media Drive if a drive letter is assigned. Some programs may not be able to find files if the drive has a new drive letter.

It is always best to remove your drive safely to avoid errors. See “Disconnecting the Drive.”

To assign a drive letter:

- 1 Click the **Windows Start Button** on the taskbar.
- 2 Right-click **Computer**.
- 3 Select **Manage**.
- 4 Click **Disk Management**.
- 5 Right-click **HP Media Drive**.
- 6 Select **Change Drive Letter and Paths**.

NOTE: To avoid multiple hard disk drives from using the same drive letter when connecting and removing the drives, assign the letter Z.

- 7 Click **Change**.
- 8 Select a letter from the drop-down menu, and then apply the changes by clicking **OK**.

Using the Drive

When running for long periods of time, the aluminum case of the HP Media Drive may become very warm. This is part of the HP Media Drive’s advanced design and is completely normal.

The built-in, low-noise fan is designed to turn on automatically at pre-set temperatures. If you are using the HP Media Drive connected externally to your computer, place the drive in a well-ventilated area.

Transferring files to another computer manually

You can transfer your computer profile information, which includes how your computer looks, as well as the personal files such as photos, music, or video you have created.

To transfer your files manually:

- 1 Connect the drive to your computer.
- 2 Select your files, and then drag and drop them to the HP Media Drive in the Computer window.
- 3 Disconnect the drive and then connect it to another computer.
- 4 Select your files and then drag and drop them to the new computer’s hard disk drive.

Disconnecting the Drive



CAUTION: To avoid hardware damage and data loss, always disconnect your HP Media Drive safely when it is not saving or transferring files.

You can safely remove the drive when it is not active. When the amber activity light is blinking, the drive is active, saving or transferring data. Removing the drive while the light is blinking may cause data loss or damaged files.

To disconnect the HP Media Drive safely:

- 1 Close all programs that may be accessing your HP Media Drive. Make sure that the activity light on the drive is off.
- 2 Double-click the **Safely Remove Hardware** icon in the system tray at the bottom of the desktop. If this icon is hidden, click the arrows on the taskbar to display it. 

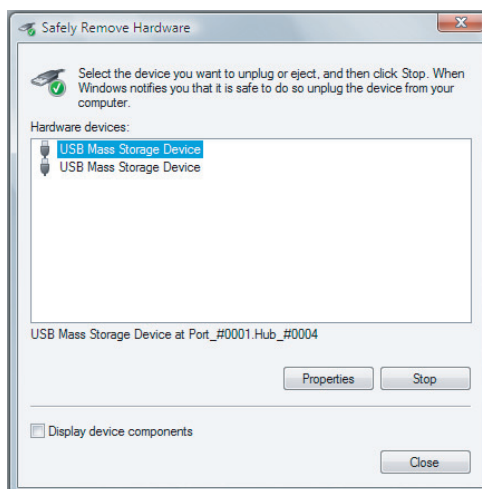

NOTE: For some computers, this may be called the Unplug Hardware or Eject Hardware icon.

- 3 Double-click **USB Mass Storage Device** to locate your HP Media Drive. USB Mass Storage Device may be listed twice. One may contain a memory card reader or other mass storage drive. Look for the label of this drive.

- 4 Select **HP Media Drive**, and then click **OK**. The name of the drive may be different if you renamed it, or it may appear as *Generic Volume* followed by the assigned drive letter.
A *Safe to Remove Hardware* message appears in the system tray, letting you know that the device is safe to disconnect.
- 5 Click **Stop** to make sure the HP Media Drive is not active, and then click **Close**.
- 6 Disconnect the drive from the computer.

Troubleshooting the HP Media Drive

Microsoft updates

Make sure you have the latest Microsoft operating system service packs and other Windows updates installed on your system before you try to troubleshoot a drive problem. These service packs are issued to fix bugs, add drivers, and enhance the security features of your system. See <http://support.microsoft.com> for details about how to install service packs and Windows updates in your system. Contact Microsoft Customer Service for information about obtaining these system enhancements if you do not have Internet access.

Drive does not appear on my computer

Try the following solutions in the order listed:

- 1 Check to see if the drive is on. The power LED on the front of the drive should be lit.
- 2 Check that the USB cable is securely and properly connected to the drive and the USB connector on the computer.
- 3 While the computer is turned on, unplug the USB cable. Wait 10 seconds, and then reconnect the USB cable.
- 4 See if the computer is recognizing the USB port you are using by checking in the Device Manager window. See the documentation that came with your computer for more information.

Data transfer rate seems slow with my USB 2.0 adapter card

Your HP Media Drive operates as fast as the host adapter card allows (up to the maximum burst rate of 480MB/sec.). If you are having performance issues, make sure that the USB 2.0 card drivers are the most current available and are installed properly.

HP Media Drive software has stopped working

Reinstall the software. Refer to the software and drivers installation instructions that came with your HP Media Drive.

Write Cache Enable does not stay enabled

For protection of your data, Write Cache Enable is turned off with the HP Pocket Media Drive. For more information, go to:

<http://www.hp.com/support>

Administrator privilege for installing software

Depending on your operating system, you may need to be logged on as the administrator to install software.

To change a user's account:

- 1 Click **Windows Start Button** on the taskbar.
- 2 Click **Control Panel, User Accounts and Family Safety**, and then click **User Accounts**.
- 3 Click **Manage another account**, and then click the account you want to change.
- 4 Click **Change the account type**, select the account type you want, and then click **Change Account Type**.

Using Windows Media Center

Microsoft Windows Media Center lets you do amazing things with your computer. With a full range of easy-to-use digital entertainment features, you can experience movies, music, and photos like never before.

Windows Media Center is simple and convenient to use. You can easily find and choose your media. You can play movies, listen to music, and view photos with a single remote control (select models only). Combine the powerful features of your computer with a home theater receiver to enjoy an even more dynamic entertainment experience.

Windows Media Center is optimized for wide-screen and high-definition displays. With the new onscreen layout of your photos, music and videos, you can now see up to three times more content on a wide-screen display than with previous versions of Media Center.

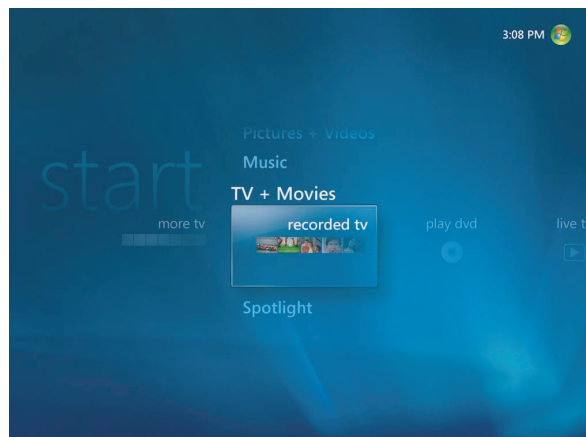

Using Windows Media Center Features

You can control the Windows Media Center functions and navigate Windows Media Center windows by using the remote control (select models only), the keyboard, or the mouse. You can easily switch back and forth between them by moving the mouse or by pressing a button on the remote control or the keyboard.

NOTE: Some of the Windows Media Center features listed are for select models only. Some of the components listed in the computer documentation, such as speakers and TV tuners, are optional or sold separately.

You can run Windows Media Center side-by-side with other Windows software programs. It is possible to browse through your pictures, watch videos, and play music while using other Windows programs.

With Windows Media Center, you can:

- Play back your digital videos.
- View your digital pictures or play them as a slide show with music. Easily print your photos.
- Browse, select, and play music CD files with full-screen visualizations.
- Record CD tracks to your media library.
- Play DVD movies. Resume playing your DVDs where you left off.

NOTE: If your computer came with a rewritable DVD drive, the drive is able to read and record to DVD+/-R/-RW media.

- Listen to Internet radio stations.
- Access streaming music and video subscription services. Some music and video subscription services may not be available in all countries/regions.
- Open specific windows in Windows Media Center by using the shortcut buttons on the remote control.
- Easily back up your media files to CD, DVD, or another hard disk drive such as the HP Personal Media Drive and HP Pocket Media Drive (sold separately).
- Use the Optimization setting to keep your computer running smoothly.
- Use Sleep mode to save power when the computer is not in use, and then you can display the computer desktop instantly by touching a keyboard key or a remote control button.

The right music for the moment

In the Music section, you can quickly browse your entire music library by artist, song, or album title, as well as by genre, composer, or year. Windows Media Center automatically downloads thumbnails of album art giving you a very visual way to find the albums you want to hear. You can shuffle and repeat your music, create playlists, apply visualizations, and burn playlists to CD or DVD with the push of a button.

You can also start a picture slide show directly from your music library when you are selecting or playing your music. If you subscribe to music services, you can now add this option directly to the Start menu, next to your Music Library.

It is easy to search for and add music to your library from another Windows computer in your home.

Play Internet radio

Windows Media Center can also play Internet radio. You can access various Internet radio Web sites.

Share your digital memories

With Windows Media Center, you can turn your simple photo collection into a cinematic slide show that can be shared on the computer or the television in the living room. The Play All option on the Start menu enables a full slide show of photos at the click of a button, and you can even enjoy your slide show with music from your music collection for a truly memorable experience.

If you want to create a slide show with a soundtrack, you can easily create a playlist of photos and music to burn to DVD.

In the Picture Library, you can navigate easily through your photos by folder or by the date they were taken, with thumbnails and highlighting that help you quickly identify the specific images or folders you want to see. You can also perform basic editing functions, such as rotating or touching up pictures, either from within the Picture Library or during a slide show.

Transform your living space into a theater

In the Videos Library, you can easily play any of your home movies that have been imported from your video recorder. Windows Media Center has built-in support for high-definition video.

Whether you are watching a DVD movie or your own home videos, Windows Media Center delivers a rich viewing experience with a high-quality digital sound system. Sit back and enjoy the show.

Setting Up Windows Media Center

The first time you start Windows Media Center on your computer, a Windows Media Center setup wizard opens. You should complete each step in the setup wizard to be able to use all the features in Windows Media Center. The Windows Media Center setup wizard may take several minutes to complete. If there are steps you still need to complete, you can go to the Settings menu to do so. See “Completing the setup wizard steps.”

NOTE: For more information about setting up your computer, refer to the setup poster or the *Start Here* guide.

Opening Windows Media Center with a mouse

You can use either your remote control or your mouse to open and navigate Windows Media Center.

To use your mouse:

- 1 Click the **Windows Start Button** on the taskbar, and then click **Windows Media Center**.
- 2 Move your mouse over the Windows Media Center Start menu items, and click an item to open it. Select an option by clicking it. To scroll the list of Start menu items, move the mouse pointer over the list until an item is selected, then continue moving the pointer down the list to see the items that are not displayed.
- 3 Move the mouse to display the Media Center menu bar, and then click the **back arrow** at the top of the window to go to a previous window.
- 4 Click the Windows Media Center **Start** icon at the top of the Windows Media Center window to return to the Windows Media Center Start menu.

Windows Media Center menu bars

When you move the mouse, the Windows Media Center menu bars appear. These menu bars allow you to access:

- Media controls (play, fast-forward, rewind, stop, and others)
- Back arrow
- Window control icons (minimize, maximize, and close)
- Windows Media Center icon that takes you to the main Windows Media Center menu.

If you use the remote control, or if you stop using the mouse (after 5 seconds), the Windows Media Center menu bars become hidden.

NOTE: You can use the Minimize and Resize buttons to switch to the desktop or to run Windows Media Center side-by-side with another program.

Navigating Windows Media Center

You can control the Windows Media Center functions and navigate Windows Media Center windows by using the remote control, the keyboard, or a mouse.

In the Windows Media Center windows, a selected item such as a folder, file, or menu item is either highlighted or moves to a zoomed in position.



To select items in Windows Media Center, use the arrow keys on the keyboard (with Numbers Lock off) or use the arrow buttons on the remote control, and then press the Enter key on the keyboard or press the OK button on the remote control to enter your selection.

If you have media playing, such as music or a slide show, it appears in an inset window in the lower-left corner. To switch from watching your media in the inset window to watching it in full-screen mode, use the arrow buttons on the remote control or use the arrow keys on the keyboard to select it, and then press OK on the remote control or press the Enter key on the keyboard.

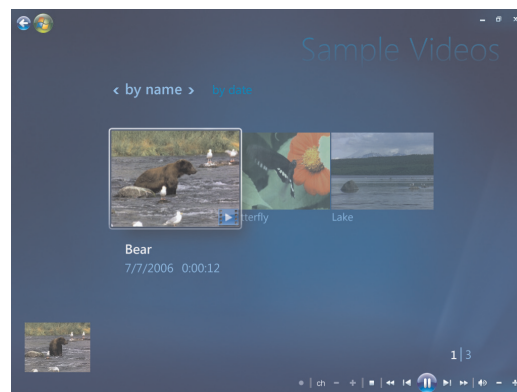

Inset Window

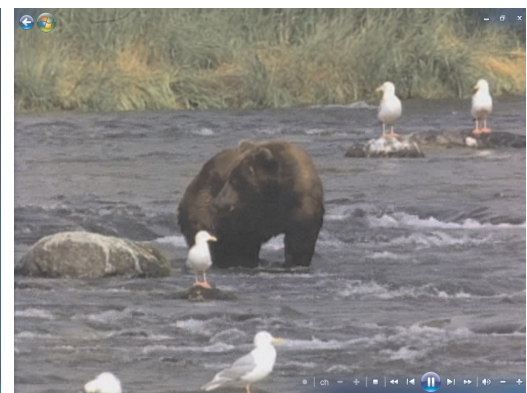

Full-Screen Mode

Windows Media Center control menu

To access the control menu in Windows Media Center, move the mouse to display the menu bars:

- 1 Click the **Windows Start Button** on the taskbar, and then click **Windows Media Center**.
- 2 From the Tasks menu, click **Shutdown**. Use your arrow keys on your remote control or your keyboard to scroll to the right or left of the screen to select the other options.



Icon	Action
A square icon with a red background and a white 'X' symbol in the center.	Close Windows Media Center.
A square icon with a blue background and a white key symbol in the center.	Log off and end your Windows Media Center session and switch users.
A square icon with a red background and a white power button symbol (a circle with a vertical line through it) in the center.	Shut down the computer.
A square icon with a blue background and a white circular arrow symbol in the center.	Restart the computer.
A square icon with a blue background and a white power button symbol (a circle with a vertical line through it) in the center.	Put the computer in a power-reduced or Sleep mode.
A square icon with a blue background, a white play button symbol (a triangle pointing right) in the center, and a small white lock icon in the bottom right corner.	Put the computer in Media Only mode, which gives you access to Windows Media Center but not the rest of your computer.

Using Windows Media Center Power Settings

When your computer is in Sleep mode it appears off, but you can actually still perform tasks such as recording TV programs or music files. Sleep mode turns off the display and mutes the audio.

NOTE: The audio or video of TV recordings is not affected when the computer is in Sleep mode.

You can activate Sleep mode by pressing the Sleep button on your computer, keyboard, or remote control.



You can return to your desktop almost instantly by pressing any Sleep button again, by pressing any key on the keyboard, by moving the mouse, or by pressing any button on the remote control. See the following procedure.

To change your computer power settings:

- 1 Click the **Windows Start Button** on the taskbar, and then click **Control Panel**.
- 2 Click **System and Maintenance**.
- 3 Click **Power Options**.
- 4 Select the **Balanced**, **Power saver**, or **High performance** option.
- 5 Click **Change plan settings**.
- 6 Next to turn off the display, click the drop-down arrow to select a time span to turn off the display.
- 7 Next to put the computer to sleep, click the drop-down arrow to select a time span for putting the computer to sleep.
- 8 Click **Save Changes**.

Completing the setup wizard steps

If you did not complete the Windows Media Center setup wizard steps the first time through, you can complete or change your selections by using the following procedure. You need to complete all of the required setup steps to access all of the Windows Media Center features.

- 1 Press the Windows Media Center Start Button  on the remote control, or, with your mouse, click the **Windows Start Button** on the taskbar, and then click **Windows Media Center**.
- 2 From the Tasks menu, select **settings**. Use the arrow keys on the keyboard or on the remote control to scroll right and left to see all the menu items.

- 3 Select **General, Windows Media Center Setup**, and then **Run Setup Again**. Follow the onscreen instructions to complete the wizard.

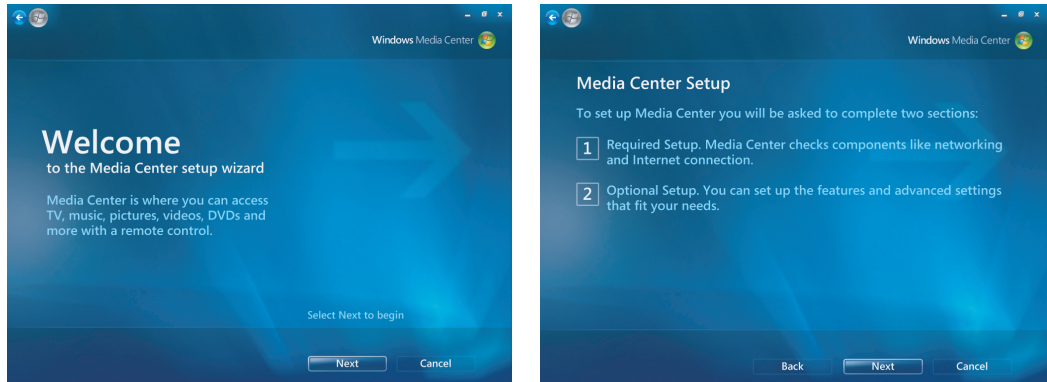

NOTE: You can change your Windows Media Center settings in the Settings menu.

Following are some of the items included in the setup wizard:

- **Check for your Internet connection.** An Internet connection allows you to access media links, display information about your music CDs and DVDs, and download the Television Program Guide if your computer came with a TV tuner.

NOTE: You must subscribe with an Internet Service Provider (ISP) to have an Internet connection.

- **Optimize how Windows Media Center looks on your display. You can:**
 - Change display settings such as brightness, contrast, color, and centering.
 - Test and adjust the display settings of your monitor, TV, or other display.
 - Use the Windows Media Center video to help you change onscreen centering, sizing, aspect ratio (shape), brightness, contrast, color, and sharpness of the display with your TV remote control or your monitor controls.
- **Set up your speakers.** Select how many speakers you have and test them. Speakers are sold separately for some models.
- **Set up your Music, Pictures, and Videos Libraries.** Set up Windows Media Center to scan your Music, Pictures, and Videos folders for new media files. Windows Media Center can then automatically add these files to your media libraries. You can tell Windows Media Center to scan other folders or stop scanning a folder.

Windows Media Center Start Menu

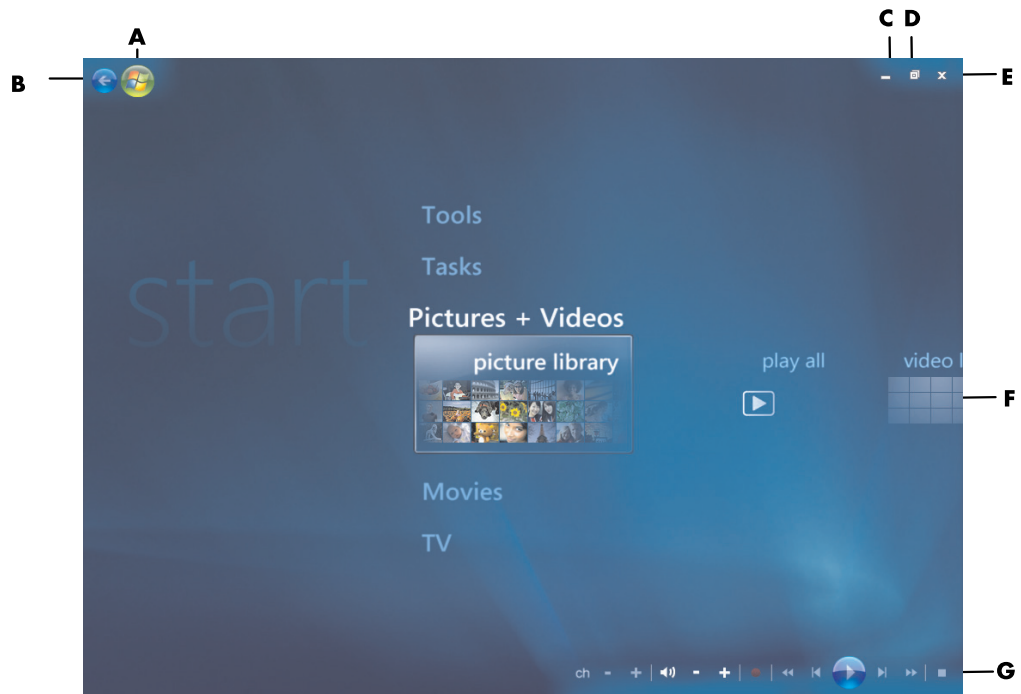

- A** Open the Windows Media Center Start menu.
- B** Go back one screen.
- C** Minimize the Windows Media Center window.
- D** Resize the Windows Media Center window.
- E** Close the Windows Media Center window.
- F** Use arrow keys to scroll left and right through the sub-menu items.
- G** Use media playback controls: Play, Stop, Pause, Skip, Fast-Forward, Replay, Rewind, Record, Volume Up/Down, Mute, and Channel Up/Down.

Windows Media Center Start menu items

- **Play DVD** — See “Using DVDs in Windows Media Center.”
- **Online Media** — Access to various photo, video, TV and other media providers.
- **Pictures + Videos** — View digital pictures, play a slide show, or print photos. Watch your home videos. See “Playing Video CDs (VCDs) with Windows Media Player.”
- **Music** — Play music files or music CDs, create and edit playlists, and record music files to CD. See “Using Music with Windows Media Center” and “Copying Music Files to CD in Music.” Play Internet radio stations.
- **Tasks** — Change program settings. See “Changing Windows Media Center Settings” below. Add a Windows Media Center Extender device. Sync content from another device to your computer. Burn CDs and DVDs, see “Copying Music Files to CD in Music.” Find utilities and programs.
- **Shutdown** — Access to Shutdown, Restart, Sleep, Close, Log Off, and the Media Only menus. Media Only mode gives you access to Windows Media Center but not to the rest of your computer. See “Windows Media Center control menu.”

NOTE: Some of the features and programs listed are for select models only.

Online Media

Online Media is a link to various media providers where you can find various media offers and services. The Online Media window is periodically updated by Microsoft. Some of the services listed may not be available in certain countries/regions.

Your computer must be connected to the Internet to access the Online Media Web sites.

Changing Windows Media Center Settings

In the Windows Media Center Settings window, you can change settings for viewing your pictures and slide shows, and for controlling sound and the display of all the Windows Media Center windows.

To change your Windows Media Center settings:

- 1 Press the Windows Media Center Start Button  on the remote control, or, with your mouse, click the **Windows Start Button** on the taskbar, and then click **Windows Media Center**.
- 2 From the Tasks menu, select **settings**.
- 3 Select a category.
- 4 Select one of the settings listed. Then use the arrow keys on the keyboard or the arrow buttons on the remote control to select an option or follow the onscreen instructions.
- 5 Select **Save** to save your changes.

Windows Media Center Settings categories

- **General**
 - **Startup and Window behavior.**
 - **Visual and Sound Effects** to set transition animations, sounds, and background colors when navigating in Windows Media Center.
 - **Program Library Options** to allow programs in the Program Library to control the media experience and access media information in Windows Media Center. Also you can hide Internet security warnings.
 - **Windows Media Center Setup** to configure your Internet connection and speakers, run Windows Media Center setup again and configure your TV or monitor.
 - **Automatic Downloads Options** to get media information about CDs, DVDs, and movies from the Internet.
 - **Optimization** to keep your computer running smoothly by performing various tasks on a regularly scheduled basis. The Optimization setting closes and then opens Windows Media Center at a specific time each day that you determine.
- **Pictures** to set slide show settings.
- **Music** to select visualizations or song information to display when playing a song.
- **DVD** to select a language for subtitles, audio tracks, and menus of your DVDs, program the Skip and Replay buttons on the remote control for your DVDs, and select closed captioning. You can also access audio settings for your speakers.
- **Library Setup** to have Windows Media Center watch specified computer folders for media files.

To view information for your computer, go to the Support Web address listed in the *Warranty and Support Guide*, and search for your model's name and number. The product model is on the lower front of the computer.

To find the online documentation for your product, search for your model number, and then click **Manuals**.

NOTE: Information and guides are associated with specific computer model numbers. Some models do not have guides or manuals available on the Web site.

Playing CDs, DVDs, or VCDs

This section describes how to play CDs, VCDs, or DVDs by using Windows Media Center, Windows Media Player, or other audio and video programs.

This section also describes using Music, radio, changing DVD and audio settings.

Using Music

The Music area in Windows Media Center is a great way to play, organize, and back up your music files. It is designed to work with the Windows Media Player program.

With Music, you can find and play your favorite music files and CDs you have added to the music library and the Windows Media Player music library. In addition, you can listen to various Internet radio stations.

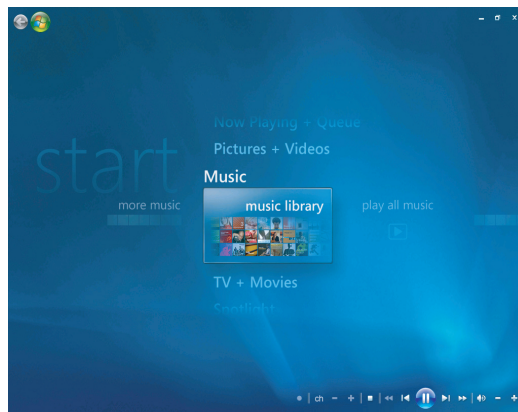

The music library menu in Windows Media Center

In Music there are several menus you can choose from:

- more music
- music library
- play all music
- radio
- search

All these menu options are described in detail in this section.

Using Music with Windows Media Center

You can copy digital music files and organize a music library by using music library in the Windows Media Center or by using the Windows Media Player program.

Music files that are added to music library in the Windows Media Center and in the Windows Media Player are accessible from within Windows Media Center and the Windows Media Player.

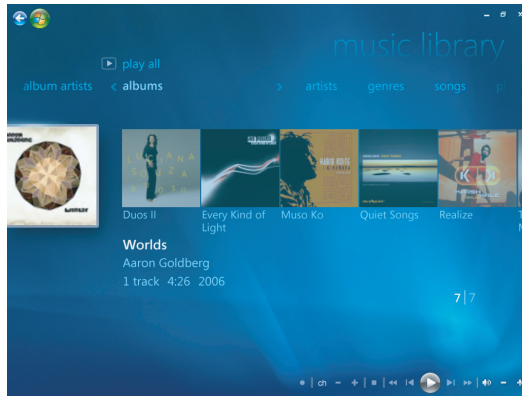

In Music you can:

- Play CDs or selected music tracks from your created music library in the Windows Media Center or the Windows Media Player.
- Select and edit a personalized list of songs in the *playlist* from the music library.
- Delete songs from a music library or a queue list.
- Burn your favorite songs to CDs.
- Back up your music tracks to a DVD or to an HP Personal Media Drive.
- Listen to Internet Radio.
- Search music tracks and files.
- Organize your genres of artists, albums, songs, composers, etc.

Using the music library

Adding Music to music library

When you add music files to your music library, they are placed into the music library in the Windows Media Center and the Windows Media Player. The added music files can immediately be found and played back using Music in Windows Media Center or the Windows Media Player.

You can also add music files to your music library from within the Windows Media Player program. For more information about adding and deleting music files to the library, use the Windows Media Player Help menu.

Adding music files from your hard disk drive

- 1 Press the Windows Media Center Start button  on the remote control, or, with your mouse, click the **Windows Start Button** on the taskbar, and then click **Windows Media Center**.

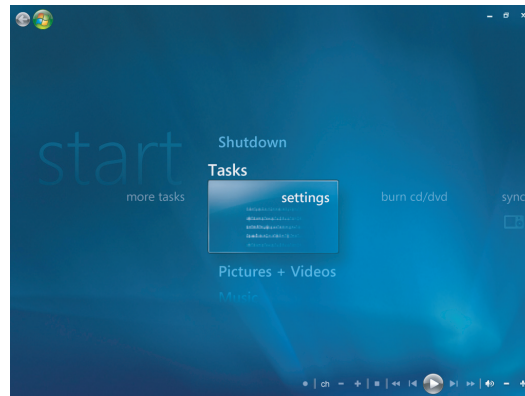

- 2 From the Tasks menu, click **settings**.
- 3 Click **Library Setup**.
- 4 Select **Add folder to watch**, and then select **Next**.
- 5 Select **Add folders on this computer**, and then select **Next**.

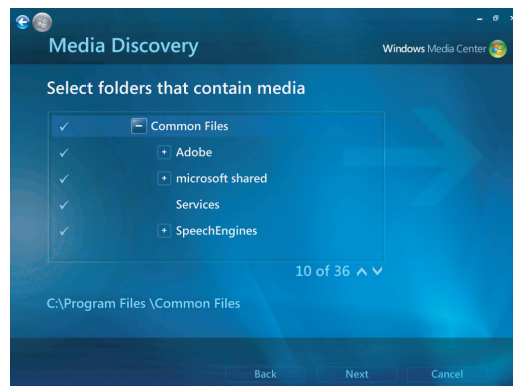

- 6 Use the arrow buttons on the keyboard or the remote control to select a location. When you find the folder that contains your music folder, select it by making sure an arrow appears next to the folder. Repeat this step to add additional folders, and select **Next** and then **Finish**.
- 7 Select **OK**.

Adding music files from a CD

To add the CD tracks to your Windows Media Center music library:

- 1 Press the Windows Media Center Start button  on the remote control, or, with your mouse, click the **Windows Start Button** on the taskbar, and then click **Windows Media Center**.
- 2 Select **Music**.
- 3 Select **music library**.
- 4 Insert a CD into the CD drive.
- 5 Select **Albums**.
- 6 Select the Album CD you want to add to your music library.
- 7 Select **Copy CD**. The first time you copy a music CD you must select your copy-protection option and then follow any onscreen instructions. After selecting your choices for copy options in the next few windows, click **Next**.
- 8 Select **Yes** to begin copying tracks to your music library. This process may take several minutes, depending on the length of your music tracks.
- 9 Click **OK**.

NOTE: You can select *Play Album*, *Add to Queue*, *Burn CD/DVD*, *Edit Info*, and *Delete* in the *album details* window from any of these options by clicking on any album.

Deleting music files from the music library

- 1 Press the Windows Media Center Start button  on the remote control, or, with your mouse, click the **Windows Start Button** on the taskbar, and then click **Windows Media Center**.
- 2 Select **Music**.
- 3 Select **music library**.
- 4 Select **albums**.
- 5 Select the album you would like to delete and select **Delete**.
- 6 Select **Yes** when the Confirm Delete window is displayed.

NOTE: To delete individual songs click on **songs**, select the song and right-click while the cursor is on the song to select **Delete**.

Using supported music file types

You can play the following types of digital audio files in Music. Refer to Windows Media Player Help for more information about supported file types.

File extension	File type
.cda	CD audio file
.au, .snd	Audio file
.aif, .aifc, .aiff	AIFF audio file
.wav	Windows audio file
.mp3, .m3u	MP3 file
.wax, .wma	Windows Media Audio file
.asf, .asx, .wm, .wma, .wmv, .wmp, .wmx, .wpl, .wm, .wmd, .wmz	Windows Media file

NOTE: For more information about music file formats, use Windows Media Center Help and Windows Media Player Help.

Only supported audio file types are displayed in the Music window. Unsupported file types won't play.

Playing Music Files in Music

When you first open Windows Media Center, select **Music** and click on **music library**, you will find a few music albums and tracks listed in your Windows Media Center and Windows Media Player music library.

To play music, click on one or more songs and then click **play**. You can also click **play all music** to hear all the tracks stored in Music.

NOTE: You may not find any audio files when you click **playlists** for the first time unless you have already added audio files to your Windows Media Center and Windows Media Player music library.

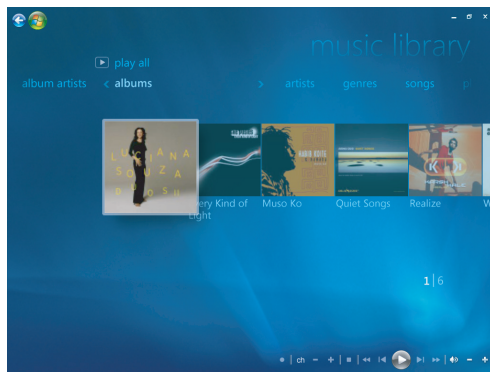

When you copy music files using Windows Media Center or Windows Media Player, the CD information is copied and displayed in Windows Media Center and in the Windows Media Player music library.

NOTE: You can place all your music files into the Music folder or into other folders on your hard disk drive, but you need to add those files to the Windows Media Center or Windows Media Player music library for either option to be able to find and play them.

If you insert a music CD when Windows Media Center is not open, a message appears asking what you want to do. You can select the Audio CD options using the Windows Media Center or Windows Media Player. If you have another program set as the default audio player, Windows opens the program and begins playing the CD. You can set the AutoPlay defaults in the Control Panel.



Changing the Visualization Settings

You can change the visualization settings such as the alchemy, bars and waves, and battery settings. You can also set the visualization options to start visualizations when the music plays at the beginning of the song, always, or never.

Press the Windows Media Center Start button  on the remote control, or, with your mouse, click the **Windows Start Button** on the taskbar, and then click **Windows Media Center**.

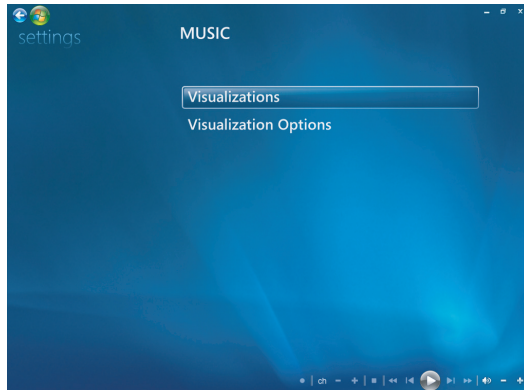

- 1 From the Tasks menu, click **settings**, then click **Music**.
- 2 Click **Visualizations** or **Visualization Options**.
- 3 After making the changes, click **Save**.

Playing an album in Music

- 1 Press the Windows Media Center Start button  on the remote control, or, with your mouse, click the **Windows Start Button** on the taskbar, and then click **Windows Media Center**.
- 2 Click **Music**.
- 3 Click **music library**.
- 4 Insert a music CD into the CD drive.
- 5 Click **Albums**.
- 6 Select the album you want to play.
- 7 Click **Play Album**.

Playing a song in Music

You can play a song from anywhere in Music. You can select it from the *songs* list, or from the *albums*, *artists*, *genres*, *composers* and other lists. You can also play a single song from a playlist:

- 1 Press the Windows Media Center Start button  on the remote control, or, with your mouse, click the **Windows Start Button** on the taskbar, and then click **Windows Media Center**.
- 2 Click **Music**.
- 3 Click **music library**.
- 4 Click **Songs**. The list displays all the songs in your library.
- 5 Use the arrow buttons on the remote control or the arrow keys on the keyboard or select a song by moving the mouse and clicking on the song. Click **Play Song** to play it.

NOTE: You can select *View Queue*, *Visualize*, *Play Slide Show*, *Shuffle*, *Repeat* and *Buy Music* in the Now Playing window from any of these options while you play a music track.

You can select *Add to Queue*, *Buy Music*, *Edit Info*, and *Delete* in the *song details* window from any of these options while you play a song.

Creating a Queue in Music

A *Queue* is a temporary list of songs that is created in Music as you select songs, albums, or playlists to play. You can continue to add songs or you can delete songs from your *Queue*.

You can create a *Queue* and save it as a playlist that you can access in Windows Media Center or the Windows Media Player.

- 1 From the Music window:
 - Select **music library** then select **songs**, use the arrow keys to select a song you want, or move the mouse over the songs. Click on the song you would like to add to the queue and then select **Add to Queue**.

Or

 - Select **albums** or **playlists**, select an album or a playlist, and then select **Add to Queue** to add the entire album or playlist to the queue.
- 2 Use the Back button on the remote control or the Backspace key on the keyboard  to go back to the songs, albums, or playlists menus if you want to select more songs to add to your queue list. Repeat step 1. Or click the mouse on the left arrow on the top left of your screen to go back.
- 3 After you add the last song for your queue list, select **Play All**. All songs in your queue list are played in the order you have selected them.

- 4 While the Queue is being played you can view the queue by selecting **View Queue**.
- 5 You can edit or clear a queue, save it as a playlist or burn a queue list on a CD or a DVD.

Finding and Playing an Album in Music

- 1 From Windows Media Center click **Music**, and then click **music library**.
- 2 Use the arrow buttons on the remote control or the arrow keys on the keyboard or the mouse to select an album, and then press OK on the remote control. Press the Enter key on the keyboard or click the album to select the album and see the album details.

Using Album Details

In the album details window you can select from:

- **Play Album** to play the album.
 - **Add to Queue** to add to a queue list.
 - **Burn** to burn the tracks on a CD or a DVD.
 - **Edit Info** to edit the information of the album.
 - **Delete** to delete the album.
- 1 Click **Play Album** to play the album from the Album Details window.
 - 2 The Now Playing window opens, and the album starts playing.
 - 3 In the Now Playing window, you can also select:
 - **View Queue** to view an ordered list of all tracks that will be played on the album.
 - **Visualize** to view a moving picture while listening to a song.
 - **Play Slide Show** to play a slide show while the album is playing.
 - **Shuffle** to rearrange the play order.
 - **Repeat** to play the album again.
 - **Buy Music** to connect to the Internet, find CD information, and buy music CDs.
 - To go back to Windows Media Center, press Start on the remote control, or click the left arrow on the top left of the screen.
 - 4 To return to the previous window, press Back on the remote control or the Backspace key on the keyboard, or click on the left arrow on the top left of your screen to go back. 

Using Search

Searching for Music Tracks and Files

You can search for music files if you cannot locate them.

Press the Windows Media Center Start button  on the remote control, or, with your mouse, click the **Windows Start Button** on the taskbar, and then click **Windows Media Center**.

- 1 Click **Music**, and then select **search**.

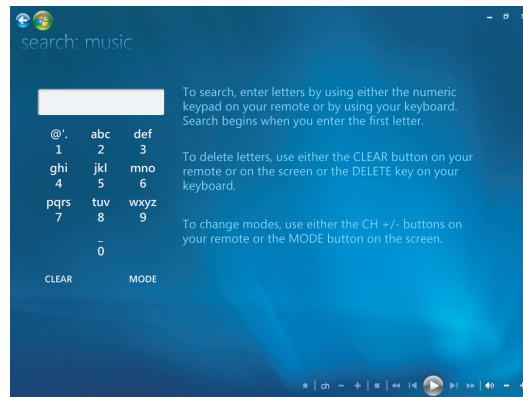

- 2 To search, enter letters by using either the alphanumeric keypad on your remote or your keyboard.
- 3 The search begins when you enter the first letter.

Creating a Playlist in Music

A *playlist* is a customized list of songs you can keep to play later or record to CD. Using playlists, you can group various digital music files together and determine the order in which you want the files to play.

You can create a playlist that includes several tracks from various CDs or even a playlist that contains background music for a slide show.

You can create playlists in Windows Media Center or the Windows Media Player.

To create a playlist:

- 1 Select **Music**, select **music library**, and then select either **albums**, **artists**, **playlists**, **songs**, or **genres**.
- 2 Use the arrow buttons on the remote control, or the arrow keys on the keyboard, or use the mouse to navigate to the music you want to add to your playlist.



- 3 Press OK on the remote control, or press the Enter key on the keyboard, or click on the selection to select a song.
- 4 Select **Add To Queue** to add the music to the list of music in the queue.

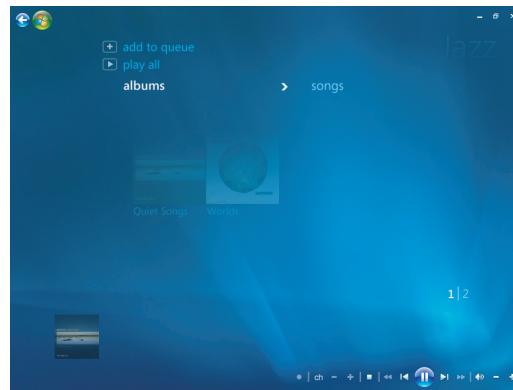

- 5 Go back to the Windows Media Center. Press Start on the remote control, or click the mouse on the left arrow on the top left of your screen to go back to Windows Media Center.



- 6 Select **play all**.
- 7 Select **View Queue**.
- 8 Select **Save As Playlist** and give the playlist a name.
- 9 Use the alphanumeric keypad to enter a name for the playlist, and then select **Save**.

NOTE: If your computer is connected to the Internet, the CD track titles and cover art appear in Windows Media Center.

Copying Music Files to CD in Music

To copy your music files to CD:

- 1 Press the Windows Media Center Start button  on the remote control, or, with your mouse, click the **Windows Start Button** on the taskbar, and then click **Windows Media Center**.

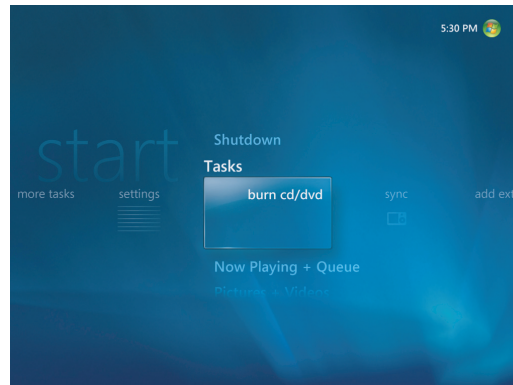

- 2 Select **Tasks** and click **burn cd/dvd**.
- 3 A message displays asking you to insert media. Insert a blank CD-R disc.
- 4 Select a disc format: **Audio CD** or **Data CD**, and then click **Next**.

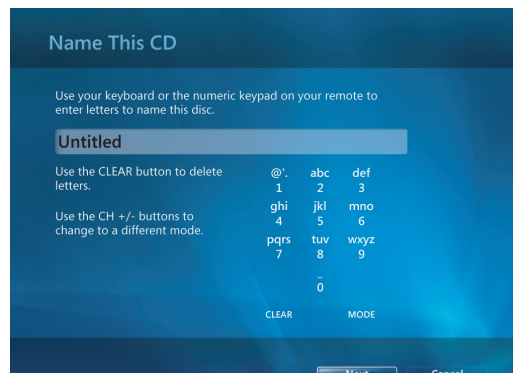

- 5 Use the arrow buttons on the remote control or the arrow keys on the keyboard to select the **Untitled** text box.
- 6 Use the alphanumeric keypad buttons on the remote control or the keyboard to enter a name for your CD, and then click **Next**.
- 7 This will take you to the Choose Music Window.
- 8 Select the music files to record. A check mark appears next to the song when it is selected. Use the Back button on the remote control or the Backspace key on the keyboard or click on **Add More** in the **Review & Edit List** to select more songs from different menus. You can also change the name of the CD by clicking **Change Name**, and clear all selections by clicking **Clear All** in this window.
- 9 Click **Burn CD**.

- 10 Click **Yes**.
- 11 Click **OK**.
- 12 Follow the onscreen instructions.

IMPORTANT: HP supports the lawful use of technology and does not endorse or encourage the use of our products for purposes other than those permitted by copyright law.

NOTE: For more information about writable media, refer to the other documentation that came with your computer.

Using more music

In **more music** you can play and listen to various online radio stations.

- 1 From the Windows Media Center, click **Music**, and then click **more music**.

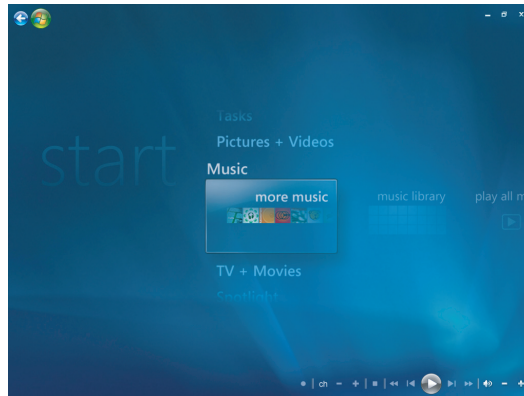

- 2 Click the right mouse button to see a menu to select: *Internet Security* information, *More Info* or the *Settings* menu.

- 3 Click the right mouse button for the icons to appear that take you to the previous menu.



Using radio

In **radio** you can play, listen, and preset various online radio stations.

- 1 From the Windows Media Center, click **Music**, and then click **radio**.
- 2 Click **presets** to preset and organize your favorite radio stations.
- 3 By clicking **sources** you can access the **Music and Radio** menu.

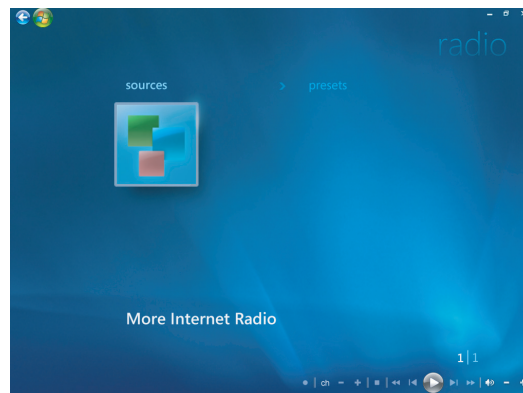

- 4 Click the right mouse button to view list and to go to the settings menu.
- 5 Click the right mouse button for the icons to appear to go to the previous menu.

Playing Music CDs

To play music CDs, you must have either a CD or DVD drive.

- 1 Insert the music CD into your CD or DVD drive.

The default audio program opens. If the Audio CD wizard window opens, choose the program you want to use from the list. You may have to scroll down in the window to see all available programs.

- 2 The music CD automatically begins to play.

Playing CDs with Windows Media Player

Your computer must have a DVD drive to play DVD movies.

NOTE: Some commercial music CDs are copy-protected and cannot be played with Windows Media Player. Such CDs come with their own (built-in) player that must be used.

- 1 Insert the music CD or DVD movie into the drive.

- The Windows Media Player window opens. If the wizard window opens, select **Windows Media Player** from the list. You may have to scroll down in the window to see Windows Media Player.

Or

- If the Windows Media Player window does not automatically open, click the **Windows Start Button** on the taskbar, choose **All Programs**, and then click **Windows Media Player**.

- 2 To play the CD or DVD, click the **Now Playing** tab on the Player taskbar. You can also control playback by using the media control buttons on the keyboard (select models).

For more information on using Windows Media Player, click a tab on the Player taskbar and then click **Help**.

Playing DVDs

To play a DVD, you must have a DVD drive.

- 1 Insert the DVD into your DVD drive.

The default DVD program opens. If the DVD wizard window opens, choose the program you want to use from the list. You may have to scroll down in the window to see all available programs.

- 2 Use the controls in the DVD program to play the DVD.

Using country/region codes

Most DVD discs have country/region codes embedded in the disc data that limit where the DVD movie can be played.

The country/region number is usually placed over a world globe printed on the DVD packaging and disc. DVDs without country/region codes play on any player or drive in any country/region.



WARNING: You can change countries/regions only five times before the country/region code locks and becomes permanent. Once the code locks, you can play DVDs from that country/region only. If the country/region code locks and you need help, contact Support.

Using DVDs in Windows Media Center

Watching DVDs in Windows Media Center allows you to control the playback with your remote control. If you play your DVD in another program outside of Windows Media Center, you will not be able to use the remote control.

Playing DVD Movies in Windows Media Center

- 1 Press the Windows Media Center Start button  on the remote control, or, with your mouse, click the **Windows Start Button** on the taskbar, and then click **Windows Media Center**.
- 2 Insert the DVD into the drive. If you have other media playing, Windows Media Center asks if you want to play the DVD. Select **play dvd**. If you don't select an option, the DVD automatically plays in full-screen mode after a few seconds.

NOTE: To view more information about a DVD that you are watching, such as the DVD title, chapter title, genre, parental rating, length, and current position, press the *i* (More information) button on the remote control.

Or

If the DVD is already in the drive, select **play dvd**. The DVD movie begins playing in full-screen mode.

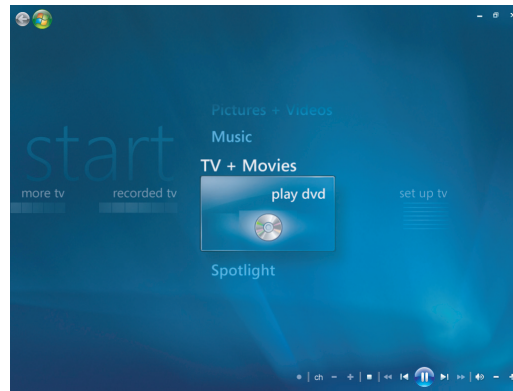

- 3 If a DVD menu appears, use the remote control or the mouse to select the DVD menu items and control the DVD movie playback.
- 4 To stop playing the DVD, press Stop on the remote control or move the mouse to display the media controls, and then click the Stop button.
- 5 Move the mouse for other icons to appear.

NOTE: To view additional controls, click the right mouse button and a window pops up displaying additional options such as: *zoom, movie details, title menu, eject* and *settings*.

Changing the DVD Settings

You can change the DVD settings such as the DVD language, closed captioning and remote control options.

Press the Windows Media Center Start button  on the remote control, or, with your mouse, click the **Windows Start Button** on the taskbar, and then click **Windows Media Center**.

- 1 From the Tasks menu, click **settings**.
- 2 In the Settings window, select **DVD**.

Changing the DVD Movie Language

To select DVD language settings for subtitles, audio track and menu:

- 1 Press the Windows Media Center Start button  on the remote control, or, with your mouse, click the **Windows Start Button** on the taskbar, and then click **Windows Media Center**.
- 2 From the Tasks menu, click **settings**.
- 3 In the Settings window, click **DVD**.
- 4 In the DVD Settings window, click **DVD Language**.

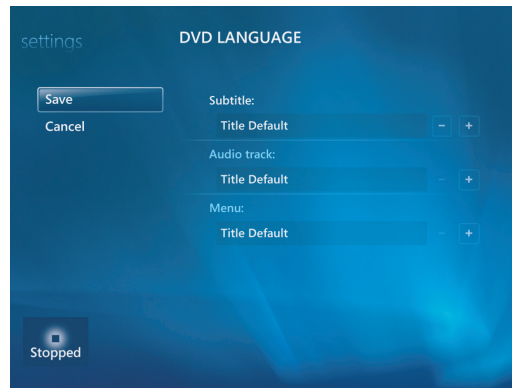

- 5 Use the arrow buttons on the remote control or the arrow keys on the keyboard to select **(+)** or **(-)**. Press OK on the remote control or press the Enter key on the keyboard to scroll through the languages available.
- 6 When you find the one you want, click **Save**, and then press OK on the remote control or the Enter key on the keyboard.
- 7 To return to the main Settings window, press the Backspace key on the keyboard  or press the Back button on the remote control, or click the left arrow on the top left of your screen.

Changing DVD Remote Control Options

To change the DVD remote control options:

- 1 Press the Windows Media Center Start button  on the remote control, or, with your mouse, click the **Windows Start Button** on the taskbar, and then click **Windows Media Center**.
- 2 From the Tasks menu, click **settings**.
- 3 In the Settings window, click **DVD**.

- 4 In the DVD Settings window, click **Remote Control Options**.

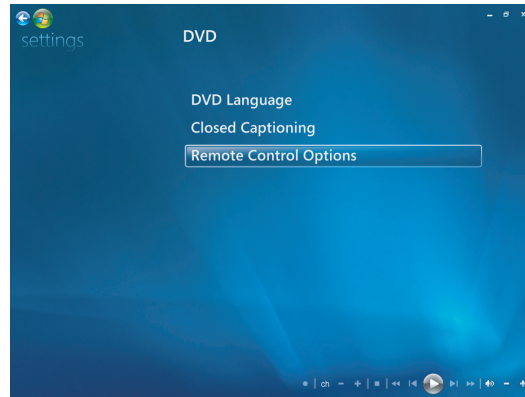

- 5 After making the changes, click **Save**.

Changing DVD Closed Captioning

You can change the DVD closed captioning options.

- 1 Press the Windows Media Center Start button  on the remote control, or, with your mouse, click the **Windows Start Button** on the taskbar, and then click **Windows Media Center**.
- 2 From the Tasks menu, click **settings**.
- 3 In the Settings window, click **DVD**.
- 4 In the DVD Settings window, click **Closed Captioning**.

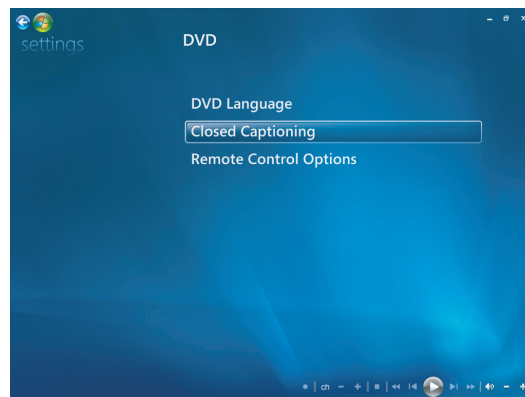

- 5 After making the changes, click **Save**.

Changing DVD Audio Settings

To select DVD audio settings for viewing the DVD:

- 1 Press the Windows Media Center Start button  on the remote control, or, with your mouse, click the **Windows Start Button** on the taskbar, and then click **Windows Media Center**.
- 2 From the Tasks menu, click **Settings**.
- 3 Click **TV**.
- 4 Click **Audio**. The Audio Properties window opens.

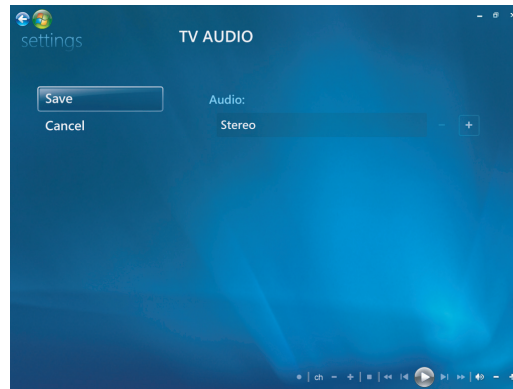

- 5 Select your speaker and sound options. Select your speaker output and your channel mode, if applicable. Select **Save**.

Playing DVDs with Windows Media Player

Your computer must have a DVD drive to play DVD movies.

- 1 Insert the music DVD movie into the drive.
 - The Windows Media Player window opens. If the wizard window opens, select **Windows Media Player** from the list. You may have to scroll down in the window to see Windows Media Player.

Or

 - If the Windows Media Player window does not automatically open, click the **Windows Start Button** on the taskbar, choose **All Programs**, and then click **Windows Media Player**.
- 2 To play the DVD, click the **Now Playing** tab on the Player taskbar. You can also control playback by using the media control buttons on the keyboard (select models). For more information on using Windows Media Player, click a tab on the Player taskbar and then click **Help**.
- 3 In the List Pane, click a DVD title or chapter name.

Playing Video CDs (VCDs)

To play a VCD you must have either a CD or DVD drive.

- 1 Insert the video CD into your CD or DVD drive.

The default video CD program opens. If the Video CD wizard window opens, choose the program you want to use from the list. You may have to scroll down in the window to see all available programs.

- 2 Use the controls in the video CD program to play the video CD.

Playing Video CDs (VCDs) with Windows Media Player

To play Video CDs (VCDs) with Windows Media Player you must have either a CD or DVD drive.

- 1 Insert your video CD (VCD) into the DVD or CD drive.
- 2 Select **Play using Windows Media Player**, and click **OK**.

Or

If the program doesn't open, click the **Windows Start Button**, choose **All Programs**, and then click **Windows Media Player**.

- 3 To play the VCD, click the **Now Playing** tab on the Player taskbar. You can also control playback by using the media control buttons on the keyboard (select models).

For more information on using Windows Media Player, click a tab on the Player taskbar and then click **Help**.

- 4 In the List Pane, double-click a VCD segment.

Creating Audio and Data Discs

This chapter contains the procedures you must perform to record (or *burn*) files to recordable CD and DVD discs. It also includes information about labeling your discs by using the LightScribe labeling technology available on select models or by creating a paper label.

Your computer includes one or more CD, DVD, or combination optical drives capable of recording. Additionally, your computer may include the following software programs for recording to CDs or DVDs:

- Windows Media Player
- Real Rhapsody (select models only)
- Roxio Creator (select models only)
- Roxio MyDVD Plus (select models only)
- Windows Vista

These programs include features that enable you to copy, archive, and manage music, video, image, and data files and then record the files to CDs or DVDs. You can also use Windows Media Player to download and copy music files to a portable device or memory card.

IMPORTANT: HP supports the lawful use of technology and does not endorse or encourage the use of our products for purposes other than those permitted by copyright law.

NOTE: *Burn* is an Industry term used to describe the recording of information onto a DVD or CD. Optical recording uses a laser beam to place information onto the disc, thus the term *burning*.

Erasing Rewritable Discs Before Recording

Previously recorded files on rewritable discs (CD-RW, DVD-RW, or DVD+RW) must be erased before recording new files. CD-R, DVD-R, and DVD+R discs cannot be erased.

To erase a rewritable disc in Roxio Creator:

- 1 Open the Roxio Creator program by clicking **Start, All Programs, Roxio, Creator**.
- 2 Click **Tools** and then **Erase Disc**.
- 3 Insert the rewritable disc you want to erase.
- 4 Click the **Quick Erase** or **Full Erase** option, and then click the **Erase Disc** icon.

Working with Audio CDs

You can create audio CDs that play in your car or home CD player, and on computers. You can create two main types of music CDs:

- **Uncompressed** — Typical CD format like you would purchase on a commercial CD. This type of CD holds 10 to 20 songs depending on their length.

Uncompressed files can be burned on CD-Rs (which play in most home and car stereos, DVD players, and computers) or CD-RWs (which play only in some stereos, DVD players, and computers).

The procedure for creating this type of CD is described in “Creating audio CDs.”

- **Compressed** — Files are burned to a disc using a compressed file format (.mp3, .wma, or .m4a). The smaller file format enables you to fit approximately ten times as many songs onto the disc (depending on length and format).

Compressed files can be burned to CD-Rs, CD-RWs, DVDs, DVD-RWs, or DVD+RWs (select models only). Compressed files can only be played on computers, CD players, or DVD players that support the *file format* you use to create the disc (.mp3 is most commonly supported). For file format compatibility, check the documentation for the device where you intend to play the disc. You may hear a slight loss of sound quality using compressed audio files.

The procedure for creating this type of CD is described in “Creating jukebox discs.”

For more compatibility information, see “Disc Features and Compatibility Table.”

Roxio Creator creates *closed-session* music CDs, which means you must record all music files on one CD in one recording session. Music files can be recorded repeatedly on a rewritable CD-RW disc, but all previously recorded files must be erased first. CD-R discs cannot be erased.

IMPORTANT: HP supports the lawful use of technology and does not endorse or encourage the use of our products for purposes other than those permitted by copyright law.

Audio CD tips

When recording music files, it is important to note that:

- As you add music files in the recording session, the software calculates and displays the amount of recording time available to record additional music files. If you try to record more than a standard CD can hold, a message displays warning you that all the tracks may not fit on your disc.
- If your recording fails, manually select a slower recording speed, if available, each time you make a recording. Refer to the Help menu in your selected software program for more information about selecting a slower recording speed.

NOTE: HP supports the lawful use of technology and does not endorse or encourage the use of our products for purposes other than those permitted by copyright law.

Before you begin creating discs

- Save all work and close all open programs.
- Turn off your screen saver.

Creating audio CDs

This section provides instructions for burning an audio CD that can be played in most home and car CD players. For instructions on creating a compressed, jukebox CD, see “Creating jukebox discs.”

To create an audio CD:

- 1 Insert a writable CD into the disc-burning drive.
CD-R discs play in most home and car stereos, DVD players, and computers. CD-RW discs play only in some stereos, DVD players, and computers.
- 2 Open the Roxio Creator program by clicking the **Windows Start Button, All Programs, Roxio**, and then click **Creator**.
- 3 Click the **Audio** tab.
- 4 Click **Audio CD**.
- 5 Click **Add Music**, and add audio files from the computer hard disk drive.
- 6 When done adding files, click the **Burn** button.

When the process is complete, you are prompted to create a disc label. For more information on creating a disc label, refer to “Making a disc label using LightScribe,” or “Making a paper disc label.”

For more help using Roxio Creator, refer to the Help menu in the program.



Creating jukebox discs

This section provides instructions for burning a jukebox disc with compressed audio files. Since files are burned directly to the disc without conversion into the standard audio format, jukebox discs are actually data discs. Only certain CD players can play these CDs. For instructions on creating an audio CD that plays in most car and home CD players, see “Creating audio CDs.”

To create a jukebox disc:

- 1 Insert a writable disc into the disc-burning drive.
- 2 Open the Roxio Creator program by clicking the **Windows Start Button, All Programs, Roxio**, and then click **Creator**.
- 3 Click the **Audio** tab.
- 4 Click **Jukebox Disc**.
- 5 Click **Add Music**, and add files from the computer hard disk drive.
- 6 When done adding files, click the **Burn** button.

When the process is complete, you are prompted to create a disc label. For more information on creating a disc label, refer to “Making a disc label using LightScribe,” or “Making a paper disc label.”

For more help using Roxio Creator refer to the Help menu in the program.

NOTE: DVD discs can store significantly more music files than a CD. Jukebox discs can only be played on computers, CD players, or DVD players that support the file format you use to create the disc (.mp3 is most commonly supported).

Creating video discs

This section provides instructions for creating a video disc. You can create a video disc from files on the computer hard disk drive or directly from a digital video camera.

- 1 Insert a writable disc into the disc-burning drive.
- 2 Open the Roxio Creator program by clicking the **Windows Start Button, All Programs, Roxio**, and then click **Creator**.
- 3 Click the **Video** tab.
- 4 Click **Create DVD**.
Roxio MyDVD opens.
- 5 In Roxio MyDVD, click **Add New Movie** to add a video file from the computer hard disk drive.
Or
Click **Capture/Import** to add a video file from a digital video camera.
- 6 If desired, use the tools available in the *Edit* area to make changes to your video.

7 Watch a preview of your video in the *Preview* area.

8 When ready to create the video disc, click **Burn**.

For more help using Roxio Creator and Roxio MyDVD, refer to the Help menu in the Roxio program.

Copying a disc

The following explains how to make a copy of an existing CD or DVD.

Copying a disc using two disc drives

If you have two disc drives, you can copy a CD or DVD directly from one drive to the other. To copy a DVD using this method, you must have two DVD drives. Otherwise, use the steps in the next section to copy the DVD. To copy a CD or DVD using two disc drives:

- 1 Insert a writable CD or DVD into a disc-burning drive.
- 2 Insert the disc you wish to copy into the other disc drive.
- 3 Open the Roxio Creator program by clicking the **Windows Start Button, All Programs, Roxio**, and then click **Creator**.
- 4 Click the **Copy** tab.
- 5 Click **Copy Disc**.
- 6 Ensure the correct disc drives are selected.
- 7 Click the **Copy** button.

When the process is complete, you are prompted to create a disc label. For more information on creating a disc label, refer to "Making a disc label using LightScribe," or "Making a paper disc label."

For more help using Roxio Creator, refer to the Help menu in the program.

Copying a disc using one disc drive

If you have only one disc drive, Roxio Creator stores an image file of the disc temporarily on the computer hard disk drive. Use these steps to copy a CD or DVD using one disc drive:

- 1 Insert the disc you wish to copy into the disc-burning drive.
- 2 Open the Roxio Creator program by clicking the **Windows Start Button, All Programs, Roxio**, and then click **Creator**.
- 3 Click the **Copy** tab.
- 4 Click **Copy Disc**.
- 5 Click the **Copy** button.

Roxio Creator creates an image file of the disc. This file is temporarily stored on the computer hard disk drive.

- 6 When prompted, insert a writable CD or DVD into the disc-burning drive and click **OK**.

When the process is complete, you are prompted to create a disc label. For more information on creating a disc label, refer to “Making a disc label using LightScribe,” or “Making a paper disc label.”

For more help using Roxio Creator, refer to the Help menu in the program.

Creating data discs

This section provides instructions for burning data files onto a disc. To create a data disc:

- 1 Insert a writable disc into the disc-burning drive.
- 2 Open the Roxio Creator program by clicking the **Windows Start Button, All Programs, Roxio**, and then click **Creator**.
- 3 Click the **Data** tab.
- 4 Click **Data Disc**.
- 5 Click **Add Data**, and add files from the computer hard disk drive.
- 6 When done adding files, click the **Burn** button.

When the process is complete, you are prompted to create a disc label. For more information on creating a disc label, refer to “Making a disc label using LightScribe,” or “Making a paper disc label.”

For more help using Roxio Creator, refer to the Help menu in the program.

Creating photo (slide show) discs

This section provides instructions for creating a slide show disc using photos on the computer hard disk drive. To create a slide show disc:

- 1 Insert a writable disc into the disc-burning drive.
- 2 Open the Roxio Creator program by clicking the **Windows Start Button, All Programs, Roxio**, and then click **Creator**.
- 3 Click the **Photo** tab.
- 4 Click **Slideshow**.
The Slideshow Assistant window opens.
- 5 In the *Add Content* area, click **Add Photos** and add picture files from the computer hard disk drive.
- 6 If desired, click **Add Background Audio** to add audio to the slide show.
- 7 When done adding photos, click **Next**.
- 8 Choose a transition style, and click **Next**.
- 9 Click **Burn To Disc**.

For more help using Roxio Creator and Slideshow Assistant, refer to the Help menu in the program.

Making a disc label using LightScribe

The following provides instructions for making a disc label using LightScribe technology. For instructions on making a paper label, refer to “Making a paper disc label.”

LightScribe requirements

Burning a label with LightScribe requires three things:

- A LightScribe-enabled disc drive (select models only), identified by the LightScribe logo.
- Labeling software that supports LightScribe.
- A writable LightScribe disc (sold separately).



Making a LightScribe label

To make a LightScribe label:

- 1** Place the disc into the disc drive with the top of the disc facing down. The top is the gold non-reflective side of the disc, opposite of the side that you record data onto.
- 2** Close the drive.
- 3** Open Roxio Express Labeler by clicking the **Windows Start Button, All Programs, Roxio**, and then click **Express Labeler**.
- 4** Under *Step 1: Select Project*, select **Disc Label**.
- 5** Under *Step 2: Edit*, design the disc label.
 - a** Click **Disc Titles** to set the disc title and subtitle.
 - b** Click **Tracks** to add song titles or file names.
 - c** Click the arrows to the left and right of **Layout** to view the different label layouts available.

You can also use the mouse to drag the title, subtitle, and track names around the label.
 - d** Click the arrows to the left and right of **Background** to view the different label backgrounds available.

To use an image from your computer hard disk drive, click **Background**, and then click **Import Background**. Then navigate to an image on the hard disk drive and click **Open**.
- 6** When you are ready to create the LightScribe label, click **Print**.
- 7** Under *Disc Label*, select **12 cm LightScribe Disc**.
- 8** Click **OK** to create the LightScribe label. The estimated time to complete the label displays, along with a progress bar. It is possible to continue to work on the computer while the LightScribe label is created.

For more help using Roxio Express Labeler, refer to the Help menu in the Roxio Express Labeler program.

Making a paper disc label

The following provides instructions for creating a paper label for your disc. To create a LightScribe label, refer to “Making a disc label using LightScribe.”

- 1** Load the printer with adhesive label paper. You can purchase label paper at most office supply stores.
- 2** Open Roxio Express Labeler by clicking the **Windows Start Button, All Programs, Roxio**, and then click **Express Labeler**.
- 3** Under *Step 1: Select Project*, select **Disc Label**.
- 4** Under *Step 2: Edit*, design the disc label:
 - a** Click **Disc Titles** to set the disc title and subtitle.
 - b** Click **Tracks** to add song titles or file names.
 - c** Click the arrows to the left and right of **Layout** to view the different label layouts available.

You can also use the mouse to drag the title, subtitle, and track names around the label.
 - d** Click the arrows to the left and right of **Background** to view the different label backgrounds available.

To use an image from your computer hard disk drive, click **Background**, and then click **Import Background**. Then navigate to an image on the hard disk drive, and click **Open**.
- 5** When you are ready to create the label, click **Print**.
- 6** Select the **Disc Label** type, the **Printer**, and **Paper Source**.
- 7** Click **OK** to create the label. The estimated time to complete the label displays, along with a progress bar. It is possible to continue to work on the computer while the label is created.

For more help using Roxio Express Labeler, refer to the Help menu in the Roxio Express Labeler program.

Working with Pictures and Videos

You can view, copy, edit, print, and share digital images and videos by using the computer.

You can transfer digital images and videos to the computer by using the following methods:

- CD or DVD: Insert the disc into the CD or DVD drive.
- Digital camera or digital video camera: Connect the device to the computer with the transfer cable that came with the device. (Select models have a digital camera docking bay.)
- Memory card: Insert the memory card into the memory card reader (select models only).

Digital images that you copy or transfer to the computer may appear in the Pictures folder by default.

Working with Digital Images

You can connect a digital image source, such as a digital photo or video camera, directly to the computer or through a docking station. Most digital picture files you copy or download from the device appear in the Pictures folder.

NOTE: When transferring pictures from a digital photo camera to the computer, set the camera's USB setting to disk drive instead of digital camera.

Windows Vista detects your external device and displays a message asking if you want to view your images.

You can copy digital picture files from the memory cards used by digital cameras and other digital imaging devices by using the memory card reader (select models only).

Viewing Pictures in Windows Media Center

With Windows Media Center, you can view, sort, edit, print, and create a CD or DVD of your pictures from the folders you create in the Pictures directory in Windows Explorer.

Pictures is a folder on your hard disk drive in the Documents window, and it is also a Windows Media Center menu item that enables you to view and search for your digital images by using the remote control or the keyboard and mouse.

The Pictures + Videos menu in Windows Media Center provides all the tools you need for viewing, organizing, editing, printing, sharing, and protecting your digital images.

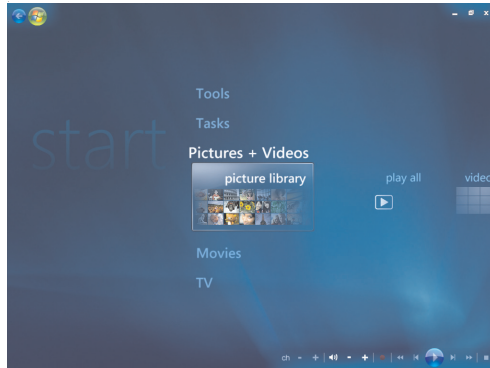

Adding Pictures in Windows Media Center

Adding picture files from your hard disk drive

- 1 Press the Windows Media Center Start button on the remote control, or, with your mouse, click the **Windows Start Button** on the taskbar, and then click **Windows Media Center**.
- 2 Select **Pictures + Videos**.
- 3 Select **picture library**.
- 4 Press Ctrl+D on the keyboard or the *i* (More information) button on the remote control, and then select **Library Setup**. ❗
- 5 Select **Add folder to watch**, and then select **Next**.
- 6 Select **Add folders on this computer**, and then select **Next**.
- 7 Use the arrow buttons on the remote control or the arrow keys on the keyboard (with Numbers Lock off) to select a location.
- 8 Press the OK button on the remote control or the Enter key on the keyboard to expand a folder.

- 9 When you find the folder that contains your picture folder, select it by making sure an arrow appears next to the folder. Repeat this step to add additional folders, and then select **Next**.
- 10 Select **Finish**.

Viewing Your Pictures in Windows Media Center

After you organize your pictures in the Pictures folder in Windows Explorer, open Windows Media Center to view your pictures:

- 1 Press the Windows Media Center Start button on the remote control, or, with your mouse, click the **Windows Start Button** on the taskbar, and then click **Windows Media Center**.
- 2 Select **Pictures + Videos** and click **picture library**. Select a folder, **tags** or **date taken**. The window shows a small picture image (thumbnail) of each photo.
- 3 Select **date taken** to view each photo with the date it was taken.
- 4 Select **folders** if you have organized your pictures into folders. Each folder icon displays a thumbnail of photos. The pictures are displayed just as you organized them in the Pictures folder in Windows Explorer.
- 5 Use the arrow keys on the keyboard or the arrow buttons on the remote control to move through your picture files and folder files, and select a picture.
- 6 Press the Enter key on the keyboard or the OK button on the remote control to select a picture or folder to view. The selected picture opens in full-screen mode.
- 7 Press the Enter key on the keyboard or the OK button on the remote control again to zoom to 150 percent; press it again to zoom to 225 percent. Use the remote control arrow buttons to pan across a picture. Press Enter or OK a third time to return the picture to its original size.

NOTE: While viewing a picture, you can press the *i* (More information) button on your remote control or Ctrl+D on the keyboard, select **Settings**, and then **Pictures**, to:

- Select a slide transition, a slide time delay, and a background color.
- Include picture folders you have created.
- Show captions.
- Display your pictures randomly.

Show song information during a slide show.

Viewing pictures as a slide show

- 1 Press the Windows Media Center Start button on the remote control, or, with your mouse, click the **Windows Start Button** on the taskbar, and then click **Windows Media Center**.
- 2 Select **Pictures + Videos**, and click **picture library**.
- 3 Select the folder of pictures you want to view as a slide show, and then press OK on the remote control or Enter on the keyboard.
- 4 Select **play slide show**, and then press OK on the remote control.
- 5 Press Ctrl+D on the keyboard or the *i* (More information) button on the remote control, and then select **Picture Details**. The picture name, location, last modification date, and resolution appear, if they are available. 
- 6 Press the Backspace key on the keyboard or the Back button on the remote control to go to a previous screen.
- 7 Use the arrow keys on the keyboard or the arrow buttons on the remote control to display the next or previous pictures.

If you do not select the pictures you want to view as a slide show, Windows Media Center uses the first folder listed. If you have picture files that are not stored in folders you created, Windows Media Center plays all files stored in the Pictures folder.

Viewing a slide show with music

- 1 Press the Windows Media Center Start Button on the remote control, or, with your mouse, click the **Windows Start Button** on the taskbar, and then click **Windows Media Center**.
- 2 Select **Music**, and click **music library**.
- 3 Select the music you want, and then press Enter on the keyboard or OK on the remote control.

NOTE: If the music does not start automatically, move the mouse to display the media Center menu bar, and then click the **Play** button, or press the Play button on the remote control.

- 4 Press the Back button on the remote control or the Backspace key on the keyboard until you are back to the Windows Media Center Start menu.
- 5 Select **Pictures + Videos**, and click **picture library**.
- 6 Select the folder of pictures you want to view as a slide show, and then press OK on the remote control or Enter on the keyboard.
- 7 Select **play slide show**, and then press the Enter key on the keyboard or the OK button on the remote control. When Windows Media Center switches to full-screen mode, the inset window disappears, but the music continues to play.

Using supported picture file types in Windows Media Center

You can view the following types of image files in Windows Media Center.

File extension	File type
.jpg, .jpeg	Joint Photographic Experts Group
.tif, .tiff	Tagged Image File Format
.gif	Graphics Interchange Format
.bmp	Bitmap
.wmf	Windows MetaFile
.png	Portable Network Graphics

- Only supported image file types are displayed in the *Pictures + Videos* area of Windows Media Center. Unsupported files are skipped in a slide show.

NOTE: If the message *Image cannot be displayed* appears, the file may be corrupted, or it may be an unsupported file type. You may need to edit your image with a photo editor and save it in a supported file format.

- Folder icons appear even if the images inside them cannot be displayed.
- Corrupted and unsupported image file types display a generic image icon but cannot be displayed.
- Some file types are supported only if appropriate filters and software are installed.

Editing Pictures in Windows Media Center

Fixing red eye or contrast

- 1 Press the Windows Media Center Start button on the remote control, or, with your mouse, click the **Windows Start Button** on the taskbar, and then click **Windows Media Center**.
- 2 Select **Pictures + Videos**, and click **picture library**.
- 3 Select a picture to edit.
- 4 Press the *i* (More information) button on the remote control or Ctrl+D on the keyboard, and then select **Picture Details**. 

5 Select **Touch Up**.

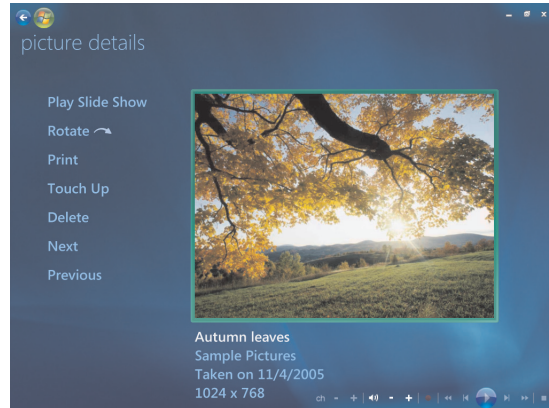

6 Select **Contrast** or **Red Eye**.

7 Select **Preview** to see the result.

8 After you select the options you want to fix, select **Save**. The picture displays with the new settings.

9 Select **Yes** to save changes and replace the original picture file.

Cropping pictures in Windows Media Center

1 Press the Windows Media Center Start button on the remote control, or, with your mouse, click the **Windows Start Button** on the taskbar, and then click **Windows Media Center**.

2 Select **Pictures + Videos**, and click **picture library**.

3 Select a picture to edit.

4 Press the *i* (More information) button on the remote control or Ctrl+D on the keyboard, and then select **Picture Details**. ❗

5 Select **Touch Up**.

6 Select **Crop**.



- 7 Use the mouse and keyboard to do one or more of the following:
 - Select the arrows under the picture to move the picture side to side, or up or down.
 - Select the magnifying glass tools to move the cropping tool in or out.
 - Select the rotate tool to move the cropping tool to a vertical or horizontal position.
- 8 After you select the settings you want to fix, select **Save**. Once you save the picture, you cannot revert to the original picture.
- 9 Select **Yes** to save changes and replace the original picture file.

Rotating pictures

If your picture appears horizontally or vertically, and you want to change the orientation, you can change it in Windows Media Center:

- 1 Press the Windows Media Center Start Button on the remote control, or, with your mouse, click the **Windows Start Button** on the taskbar, and then click **Windows Media Center**.
- 2 Select **Pictures + Videos**, and click **picture library**.
- 3 Select the picture you want to rotate.
- 4 Right-click the picture, or press the *i* (More information) button on the remote control, and then select **Rotate**. Rotation occurs in 90° increments. 

Printing Pictures in Windows Media Center

NOTE: You must set up your printer before you try to print from Windows Media Center; otherwise, by default, the file is saved to the Documents folder when you try to print the picture.

- 1 Press the Windows Media Center Start button on the remote control, or, with your mouse, click the **Windows Start Button** on the taskbar, and then click **Windows Media Center**.
- 2 Select **Pictures + Videos**, and click **picture library**.
- 3 Select the picture you want to print.
- 4 Press the Print button on the remote control.
Or
Press Ctrl+D on the keyboard or the *i* (More information) button on the remote control, and then select **Picture Details**. Select **Print**, and then select **Print** again. 
- 5 Follow any onscreen instructions.

Copying Pictures to CDs and DVDs in Windows Media Center

NOTE: In Windows Media Center, all pictures are copied to CDs as .jpg files.

- 1 Press the Windows Media Center Start button on the remote control, or click the **Windows Start Button** on the taskbar and then select **Windows Media Center**.
- 2 From the Tasks menu, select **burn cd/dvd**.
- 3 Insert writable media (CD-R, CD-RW, DVD+/-R, or DVD+/-RW) into the drive.
- 4 Select **Data CD/DVD**, and then select **Next**.

NOTE: If you are using a writable disc that contains data, you must select **Erase Disc** to continue.

- 5 Select the **Untitled** area, and enter the name of your disc by using the numeric keys on the keyboard or the remote control, and then select **Next**. Use the Backspace key on the keyboard or the Clear button on the remote control to delete letters.
- 6 Select **Picture Library**, and then select **Next**.
- 7 Select the pictures you want to copy, and then select **Next**. A check mark appears next to a picture when you select it.
- 8 Select **Add More** to add more pictures to your disc.
- 9 After you have selected all of your pictures, select **Burn CD**.
- 10 Select **Yes**. Windows Media Center displays a message if you need to insert an additional disc to complete your recording. Windows Media Center displays a message when your disc has been created.
- 11 Click **Done** when the disc has been created.

Playing Videos in Windows Media Center

The *Picture + Videos* area in Windows Media Center makes it easy to play home video files that you created or video files that you downloaded from the Internet.

In Videos you can:

- Play videos that are stored anywhere on your hard disk drive.
- Create a CD or DVD of your video files.
- View your videos in full-screen mode or from an inset window in Windows Media Center.
- View small thumbnail images and the titles of your video files.

Playing digital videos

After you organize your videos in the Videos folder or Shared Video folder in Windows Explorer, open Windows Media Center to watch them:

- 1 Press the Windows Media Center Start button on the remote control, or, with your mouse, the **Windows Start Button** on the taskbar, and then click **Windows Media Center**.
- 2 Select **Pictures + Videos**.
- 3 Select **video library**.
- 4 Select the video folder you want. The video folder opens, displaying a list of video files. You may need to use the scroll arrows at the bottom of the window to display all videos.

NOTE: Use the Mouse to select the up arrows and down arrows at the bottom of the window, to scroll to other pages of video files and folders.

- 5 Select the video file. The video plays in full-screen mode. Use the mouse to resize the window if you want to watch your video while doing something else on your desktop.
- 6 To exit full-screen mode and return to the previous window, press the Back button on the remote control or the Backspace key on the keyboard. Your video continues to play in the inset window.
- 7 When the video is finished, select **Restart** to replay the video or **Done** to close the file and return to the *Videos* area.

NOTE: You can maximize the media playing in the inset window by using the arrow buttons to select the inset window and then pressing OK on the remote control or Enter on the keyboard.

Using supported video file types

You can view the following types of video files in Windows Media Center. Other file types are supported if your computer has the correct software installed.

File extension	File type
.avi	Video file (Audio Video Interleaved)
.dvr-ms	Digital Video Recording — Microsoft (TV file format)
.mpeg, .mpg, .mpe, .m1v, .mp2, .mpv2	Movie file
.wm, .asf	Windows Media file
.wmv	Windows Media AV file

NOTE: For more information about supported video file types, refer to Help and Support. Click the **Windows Start Button** on the taskbar and then click **Help and Support**.

Transferring and Recording Video Files

Once you capture your video by using video capture and editing software, you can use Windows Media Center to find it and add it to your *Videos* area.

Recording analog and digital video files

Refer to *Help and Support* for more information about capturing and recording video files from analog and digital video cameras.

To find information in Help and Support:

- 1 Click the **Windows Start Button** on the taskbar and then click **Help and Support**.
- 2 Type in search words such as *recording video*.

Creating a CD/DVD from Video Files in Windows Media Center

- 1 Press the Windows Media Center Start button on the remote control, or, with your mouse, click the **Windows Start Button** on the taskbar, and then click **Windows Media Center**.
- 2 From the Tasks menu, select **burn cd/dvd**.
- 3 Insert writable media (CD-R, CD-RW, DVD+/-R, or DVD+/-RW) into the drive.
- 4 Select **Audio CD**, **Data CD** or **Video DVD**, and then select **Next**.

NOTE: If you are using a rewritable disc that contains data, you must select **Erase Disc** to continue.

- 5 Select the *Untitled* area, and enter the name of your disc by using the numeric keys on the keyboard or the remote control, and then select **Next**. Use the Backspace key on the keyboard or the Clear button on the remote control to delete letters.
- 6 Select **Video Library**, and then select **Next**.
- 7 Select the files you want to copy. A check mark appears next to a file when you select it. Then select **Next**.
- 8 Select **Add More** to add more files to your disc.
- 9 After you have selected all of your files, select **Burn CD**.
- 10 Select **Yes**. Windows Media Center displays a message if you need to insert an additional disc to complete your recording. Windows Media Center displays a message when your disc has been created.
- 11 Click **Done** when the disc has been created.

Creating Movies by Using muvee autoProducer

(Select models only)



Creating personalized and professional-looking video movies is simple with muvee autoProducer, a software program on your computer. This version of muvee autoProducer includes features such as video capture and disc recording.

Basic Steps to Make a Movie

The basic steps to produce a movie with muvee autoProducer are:

- 1 Capture digital video:** Capture live or recorded video to your hard disk drive directly from a compatible digital video (DV) camera.
- 2 Add videos and pictures:** Select video and picture files from your computer folders. You can easily add videos and still images to your movie production.

You can use the following video and still-image file types in your movie project:

File extension	File type
.dv	Digital Video
.avi	Audio Video Interleaved
.mpeg-1	Motion Picture Experts Group video playback
.mpeg-2	MPEG for DVD video playback
.mpeg-4	MPEG for high-quality video format (Web streaming, wireless devices, and so on)
.mov	QuickTime Movie
.wmv	Windows Media AV file (movie video)
.asf	Windows Media file (Advanced Streaming Format)
.jpg, .jpeg	Joint Photographic Experts Group, still image
.gif	Graphics Interchange Format, still image
.png	Portable Network Graphics, still image
.tif	Tagged Image File Format, still image
.bmp	Bitmap, still image

NOTE: If you upgrade muvee autoProducer, you can use DivX video format. See “Upgrading muvee autoProducer.”

- 3 Add music:** Select music files on your computer to add to your movie soundtrack. You can use the following music file types in your movie project:

File extension	File type
.aac	Advanced Audio Coding
.mp3	MPEG Layer 3
.m4a	MPEG-4 Audio layer (unprotected AAC)
.wav	Windows Audio
.wma	Windows Media Audio









- 4 Select a style:** Apply a movie style editing template for different effects and picture transitions in your movie.
- 5 Add captions:** Personalize your movie with opening titles and closing credits.
- 6 Make the movie:** Automatically analyze the videos, pictures, music, movie style, and captions that you added to your project, and save your project to your computer hard disk drive before recording to disc.
- 7 Modify the movie:** Make final changes before saving.
- 8 Burn to disc:** You can record a video to DVD, VCD, or SVCD.
- The following sections provide detailed instructions.

Using muvee autoProducer

Getting started

To open muvee autoProducer (select models only):

- 1 Click the **Windows Start Button** on the taskbar.
- 2 Click **All Programs, muvee Technologies, muvee autoProducer**, and then **Home movies made easy!** to open muvee autoProducer.
- 3 From the File menu, select either **New Project** to start a project, or **Open Project** to open an existing project.
- 4 Select one of the button options:

Button		Enables you to	See
Get Video from Camera		Open the muvee Video Capture window to capture (copy) live video or recorded video.	"Capturing video from a digital video camera."
Add Video		Open the Add Video window to add existing video files to your project.	"Adding videos."
Add Pictures		Open the Add Pictures window to add existing still-image files to your project.	"Adding pictures."
Add Music		Open the Add Music window to add existing music files to your project.	"Adding music."
Change Settings		Open the muvee Settings window to adjust audio and video production settings for your movie.	"Changing the settings."
Title/Credits		Open the muvee Title and Credits window to enter an opening title and closing credits for your movie.	"Adding an opening title and closing credits."
Make muvee		Open the Make muvee window to create and preview the movie automatically.	"Making the movie."
Save and share your muvee		Open the Listed muvee Files window to save the finished movie on your computer hard disk drive, or to record the finished movie to a disc.	<ul style="list-style-type: none"> ■ "Saving the movie project." ■ "Recording the movie project to disc."
Tweak muvee		Make quick final changes to your muvee before saving.	"Modifying the movie."

Capturing video from a digital video camera

You can use muvee autoProducer to capture (copy) digital video files to your hard disk drive in either of the following ways:

- **Live** (known as *camera mode*) by using a compatible digital video (DV) camera. See “Capturing live video from a DV camera.”
- **Recorded** (known as *VCR mode*) by using a recorded tape in your DV camera. See “Capturing video from a digital video camera.”

Captured video files are automatically added to your movie project. To remove the file from your movie project, select it in the list of captured video files, and then click the **trash can** icon.

When capturing video, it is important to be aware of the amount of free space available on your computer hard disk drive. Capturing video can use a large amount of disk space. The amount of free disk space displays in the Capture Video window in muvee autoProducer while you are capturing video.

Capturing live video from a DV camera

Capturing live video in camera mode enables you to create a video file without even having a tape in the camera.

To capture live video to your hard disk drive by using muvee autoProducer:

- 1 Connect your DV camera to the FireWire (IEEE 1394) port on your computer.
- 2 Turn on the camera and set it to VCR mode. Refer to the instructions in the manufacturer’s documentation.
- 3 Click the **Get Video from Camera** button.
- 4 Click **Start Capture** to begin capturing the live image directly to your hard disk drive.
- 5 Click **Stop Capture** to stop capturing.
- 6 Click **Capture Folder** to specify a folder for the captured video file.
- 7 Click **Filename** to specify a file name for the captured video file.
- 8 Click **Done** to add captured video files automatically to your movie project.



Capturing recorded video from a DV camera

For best results when using muvee autoProducer, capture only video footage that you are most interested in using in your movie project.

To capture (copy) recorded video to your hard disk drive:

- 1 Connect your DV camera to the FireWire (IEEE 1394) port on your computer.
- 2 Turn on the camera and set it to VCR mode. Refer to the instructions in the manufacturer's documentation.
- 3 Click the **Get Video from Camera** button. 
- 4 Click the **Play** button on the screen to begin viewing the video.
- 5 Click **Start Capture** when you see the start of the video footage you want to use in your movie project.
- 6 Click **Stop Capture** to stop capturing.
- 7 Repeat steps 5 and 6 to capture additional sections of video footage.
- 8 Click **Capture Folder** to specify a folder for the captured video file.
- 9 Click **Filename** to specify a file name for the captured video file.
- 10 Click **Done** to add captured video files automatically to your movie project.

Adding videos

To add video files to your movie production:

- 1 Click the **Add Video** button in the *Add Video/Pictures* area. The Add Videos window opens. 
- 2 Browse the folders on your hard disk drive to select existing video files for your movie:
 - Add up to three video files.
 - Select multiple video files by pressing and holding Ctrl on your keyboard while selecting the files.
- 3 Adjust the order of the video files by dragging and dropping the files.

NOTE: To remove a clip from the production, select it and then click the **trash can** icon.

- 4 You can use the magicMoments feature in muvee autoProducer to mark specific scenes in a video clip that you want to include in, or to leave out, of your final movie:
- Select a video file in the Select Video/Pictures window, and then click the **magicMoments** button. The magicMoments window opens. 
 - Click the **Play** button to start viewing the video.
 - Use the magicMoment controls to mark video scenes to include and exclude:



- Click and hold down the **green thumbs-up** button to mark scenes that must be included in the movie.
- Click and hold down the **red thumbs-down** button to mark scenes that must be left out of the movie.

NOTE: Press the Shift key on the keyboard, and then click the scene to undo scenes that were marked with the thumbs-up or thumbs-down buttons.

- Click and hold down the **gray thumb** button to undo one second of a selected scene.
- Click and hold down the **arrow** buttons to navigate backward and forward through the video footage.

Video footage left unmarked is still analyzed when you make the movie, and you can decide at that time to include it in the final version of the movie.

For best results when using the magicMoment feature:

- Keep each magicMoment to less than 10 seconds.
 - Keep the total duration of magicMoments to less than 50 percent of the duration of your movie. It is recommended that you select only a few scenes.
- d Click **OK** when you are done marking scenes. The window closes. Note that the video clip is marked on the lower-left side.

Adding pictures

To add still-image files to your movie production:

- Click the **Add Pictures** button in the *Add Video/Pictures* area. The Add Pictures window opens. 
- Browse the folders on your hard disk drive to select existing still-image files for your movie:
 - Add up to 50 still image picture files.
 - Select multiple picture files by pressing and holding Ctrl on your keyboard while selecting the files.

- 3 Adjust the order of the picture files by dragging and dropping the picture files.

NOTE: To remove a picture from the production, select it and then click the **trash can** icon.

- 4 Click the **Rotate Image Clockwise** button to rotate still images. 
- 5 You can use the magicSpot feature in muvee autoProducer to control the motion that is applied to your picture:

- a Click the **magicSpot** button to open the magicSpot window. 
- b Click the **Manual** button to display two overlapping frames over your picture.
- c Move the frames around to set the start and end points for motion. The arrow in the frames shows the direction of motion.

Adding music

To add music files to your movie production as a soundtrack:

- 1 Click the **Add Music** button in the *Music* area. The Add Music window opens. 
- 2 Browse the folders on your hard disk drive to select existing music files for your movie:
 - Add up to three music files.
 - Select multiple music files by pressing and holding Ctrl on your keyboard while selecting the files.
- 3 Adjust the order of the music files by dragging and dropping the files.

NOTE: To remove music from the production, select it and then click the **trash can** icon.

Selecting the style

The muvee autoProducer program comes with a set of style templates for setting the pace, scene transition effects, and caption fonts. The style you use also affects how muvee autoProducer combines the video, picture, and music files in your movie project to produce the final movie.

For example, using the Cinema style results in a movie that is moderately paced, color-enhanced, and in a wide-screen format.

To select a style, just click it in the list. A sample of the style displays in the Preview window.

Changing the settings

To adjust audio and video production settings for your movie:

- 1 Click the **Change Settings** button. The muvee Settings window opens. 
- 2 Click the **Duration** tab to set preferences and the length of your video production. Click one of the following duration settings:
 - **Fit to music.** The produced version may reuse or drop some video and pictures.
 - **Best fit for videos and pictures.** The produced version may repeat or trim music.
 - **User Defined.** Select the duration in minutes and seconds:
 - If the duration of your music is longer than the total duration of your video and picture files, place a check in the **Allow video and pictures to repeat** check box to repeat the video clips and pictures for the full duration of your music files.
 - If the total duration of your video and picture files is longer than the duration of your music, place a check in the **Allow music to repeat** check box to repeat the music for the full duration of your video clips.
- 3 Click the **Video** tab to set the video and still image preferences. Click one of the following settings:
 - **Style default.** Select this style to sequence still images and video clips.
 - **Keep shots in sequence.** Select this style to use the sequence of still images and video clips as they appear in the *Add Video/Pictures* area window.
 - **Shuffle shots.** Select this style to move the slider bar to determine the frequency of sequencing still images and video clips.
 - Place a check in the **Interleave pictures** check box to blend pictures with video at intervals.
- 4 Click the **Audio** tab to set the sound preferences. Click one of the following settings:
 - **Use all music.** Select this style to use the sequence of sound files in the Add Music window.
 - **smartJoin™ multiple music files.** Select this style to automatically remove silence between music tracks.
 - **Normalize music.** Select this style to automatically adjust audio playback volume to the same level.
 - **Sound mix level area.** Move the slider bar to adjust the sound mix level of the music you added and the original video soundtrack. You can use either or a blend of both.
- 5 Click **OK** when you are done adjusting the settings for your movie project.
Or
Click **Cancel** to undo any settings.

Adding an opening title and closing credits

You can personalize your movie project by adding an opening title and closing credits:

- 1 Click the **Title/Credits** button. The muvee Title and Credits window opens. 
- 2 Click the **Title** tab:
 - a Select a title effect in the drop-down list.
 - b In the *Enter your title here* box, type the text that you want to appear at the start of your movie.
 - c Click **Use font** to select the font, style, size, color, and effects from the Font window.
 - d Select a background image for the title.
- 3 Click the **Credits** tab:
 - a Select a credits effect in the drop-down list.
 - b In the *Enter your credits here* box, type the text that you want to appear at the end of your movie.
 - c Click **Use font** to select the font, style, size, color, and effects from the Font window.
 - d Select a background image for the ending credits.
- 4 Click **Apply**.
- 5 Click **OK** to close the muvee Title and Credits window.

Making the movie

After you have added at least one video or picture file to your movie project, you can have muvee autoProducer make the movie.

The muvee autoProducer program makes a movie by combining the video, picture, and music files you have selected, along with the style of movie, to produce a professional-looking movie in just a few steps.

- 1 Click the **make muvee** button.
- 2 Click **OK** as required.
- 3 After making a movie, you can preview the movie in the muvee autoProducer Preview window. Use the controls in the Preview window to play, pause, and stop the movie preview:
 - Each time you make a change to a movie project, you need to click the **make muvee** button again to add that change to your movie.
 - You can revise and preview the movie as often as you want, to experiment with different styles and the content of the movie.



Previewing the movie

After you have made the movie, you can preview how the movie looks and sounds, and take snapshots of frames in the movie.

- 1 Click the **Start Playback** button. The movie begins playing.
- 2 Use the **Stop** and **Previous Frame/Next Frame** buttons to navigate through the movie.
- 3 Click the **Take Snapshot** button to save the current frame as a picture file (.jpeg, .bmp, or .gif format).
- 4 Click the **Locate Shot** button to open the magicMoments window. See “Adding videos” for more information about using magicMoments.



Modifying the movie

After you have created the movie, muvee autoProducer allows you to make some quick final changes to your project before saving it. muvee autoProducer can automatically replace shots with other similar or contrasting ones. Alternatively, you can manually choose your replacement shots.

To modify a movie:

- 1 Click the **Tweak muvee** button. The Tweak muvee window opens.
- 2 Click the **Start Playback** button. The movie begins playing. You can click the **Pause Playback** button to stop the movie at any time. You can also click on the seek bar or drag the slider to move to a particular point in the movie.
- 3 Use the controls in the Tweak muvee window to modify the movie project:



NOTE: In the Tweak muvee window, you can only replace a video segment with another video segment from the original footage, and pictures with other pictures. You cannot expand the duration of the selected clip or the replacement clip.

- Click the **Auto-replace with similar** button to automatically replace a picture or video segment with another similar picture or video segment.
- Click the **Auto-replace with different** button to automatically replace a picture or video segment with a completely different picture or video segment.
- Click the **Manually replace** button to replace a picture or video segment with a picture or video segment of your choice.
- Click the **Undo** or **Redo** button as needed.





- 4 When you are done modifying the movie project, click **OK** to save your changes and close the Tweak muvee window.

Or

To exit the Tweak muvee window without saving your changes, click **Cancel**.

Saving the movie project

After you are satisfied with the look of your movie project, you are ready to save the movie as a file on your hard disk drive:

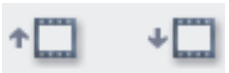
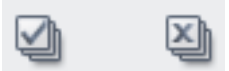
- 1 Click the **Save and share your muvee** button. The Listed muvee Files window opens, with all your muvee Files listed. 
- 2 Remove the check mark next to any muvee files you do not want to save.
- 3 Edit the muvee files before saving:
 - Click the **Rename** button to change the name of the selected muvee file. 
 - Click the **Move up** or **Move down** button to change the order of the muvee files in the list. 
 - Press the **Select all** or **Deselect all** button to save all muvee files or to save none of the muvee files. 
 - Select a muvee file and click the **trash can** icon to delete the file.
- 4 The **TV System** area shows the current TV format (NTSC or PAL). To change the format, click the name of the current format, and then select the correct format in the window that opens.
- 5 Click **Save Now**. The Save muvee window opens.
- 6 Choose where you want to play the movie (**PC**, **TV**, or **Mobile Devices**) and the file format. The following table lists the format types available in each category:



PC	TV	Mobile Devices
Computer playback	DV camera	Mobile phone
E-mail	DVD	Pocket computer
Web streaming	VCD	
AVI	SVCD	

- 7 Click the **Change Settings** button to change the video and audio settings of the movie file type, as required (advanced users only). 
- 8 Click **Browse** to choose a location on the hard disk drive to save the movie.
- 9 Click **Save**. You can watch the preview as it saves.

- 10 When saving is complete, you can click **Play muvees** to watch the files you saved or **Open output folder** to view the folder where you saved the files.
- 11 Click **Close** when you are done.

Recording the movie project to disc

To create a DVD, VCD, or SVCD disc of your movie project:

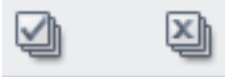
- 1 Click the **Save and share your muvee** button. The Listed muvee files window opens with all your muvee files listed. 
- 2 Remove the check mark next to any muvee files you do not want to save.
- 3 Edit the muvee files before saving:
 - Click the **Rename** button to change the name of the selected muvee file. 
 - Click the **Move up** or **Move down** button to change the order of the muvee files in the list. 
 - Press the **Select all** or **Deselect all** button to save all muvee files or to save none of the muvee files. 
 - Select a muvee file and click the **trash can** icon to delete the file.
- 4 Click the check box next to **Burn source files to disc** to create copies of all of the picture and video files used to create the muvee file.
- 5 The TV System area shows the current TV format (NTSC or PAL). To change the format, click the name of the current format, and then select the correct format in the window that opens.
- 6 Click **Burn Now**. The muvee Burner window opens.
- 7 Under *Disc title*, type a title for your disc.
- 8 Select the disc menu theme in the drop-down list. You can preview the different themes in the window.
- 9 Select the **CD** or **DVD** burner drive.
- 10 Select the type of video disc to create: **DVD**, **VCD**, or **SVCD**. The window shows the disc capacity, disc capacity used, and available disc space.
- 11 If you wish to create more than one disc by using the same muvee file, use these steps:
 - a Click **Options** and then **Number of copies**.
 - b Select the number of copies to burn, and then click **OK**.
- 12 Click **Burn Now** to begin burning your movie to disc.

Or

To save the current settings for future use, click **Burn Later**.
- 13 Click **OK** when the recording is complete.
- 14 Close the muvee Burner window.

Upgrading muvee autoProducer

You can purchase an upgraded version of muvee autoProducer. The upgraded version enables you to use unlimited video clips, audio clips, and photos in your movie production. It also includes support for DivX file types, which enables you to import or create DivX format muvees. (Purchasing DivX videos from DivX services may require a subscription.)

To see muvee autoProducer offers for HP customers:

- 1 At the top of the muvee autoProducer window, click **Help**.
- 2 Click **Check for updates**. The program accesses the Internet and displays muvee autoProducer offers.

Index

A

- adding
 - CD tracks to the music library 128
 - music files to the music library
 - from the hard disk drive 127
- adjusting monitor 10
- antivirus, installing program 54
- audio connector 6
 - Audio Line Out 6
- Audio input
 - left and right connectors 4
- autoscroll 67

B

- batteries
 - installing in remote control 73
 - type for remote control 73
- Bluetooth devices 12
- burning
 - audio and data disc 148–152
 - CDs, DVDs 147–151
- buttons
 - media control or playback 62
 - Off, See turning off PC 48
 - remote control 70
- buttons, keyboard
 - customizing 63

C

- card reader, memory 99
- carpal tunnel syndrome 43
- CDs
 - creating a music CD in Music 136, 137
 - erasing rewritable 148
 - playing in Music 131, 133
- change the speed of the cursor 68

- Composite video connector 4, 6
- computer
 - transferring files 55
- Computer Playback 175
- connecting
 - devices 9
 - digital camera 8
 - digital video camera 8
 - headphones 36
 - peripherals 2
- connection
 - modem 15
 - wired network 12
- connector
 - Audio Line In 6
 - Audio Line Out 6
 - back panel 7
 - Composite Video In 6
 - computer 2
 - FireWire (IEEE 1394) 5
 - FM In 7
 - headphones 4
 - keyboard 5
 - Microphone In 4
 - modem 7
 - monitor 6
 - mouse 5
 - printer 5
 - S-video In 6
 - TV/Cable Ant 7
 - USB 4, 5
- country/region codes 140
- cursor speed 68
- customizing keyboard buttons 63

D

- desktop
 - switching from Media Center 116
- devices
 - connecting 9
- digital camera
 - connecting 8, 9
- digital images 155
- digital picture 99, 155
- digital video camera
 - connecting to a computer 8
 - recording videos 150, 168
 - troubleshooting 9
- digital video camera capture 168
- discs
 - drive compatibility 95
 - erasing rewritable 148
 - features and compatibility 96
- documentation, onscreen 39
- DV camera capture 168
- DVD movies
 - changing
 - audio settings 144
 - language 142
 - playing
 - in Media Center 140
- DVD Play, features 84
- DVDs
 - erasing rewritable 148

E

- erasing rewritable discs 148
- error messages
 - Image cannot be displayed 159
- errors
 - reducing recording speed 149
- Ethernet connection 12
- Ethernet network hub 5

F

- file type
 - music 129, 166
 - picture 159, 165
 - video 163, 165
- FireWire 168, 169
- FireWire (IEEE 1394) connector 5
- FM In connector 7

- FM radio antenna
 - connecting 7
- Found New Hardware* message,
 - connecting a digital camera 8

H

- headphones
 - connector 4
 - using 36
- Help and Support 40
- home stereo system
 - connecting to the PC 28
- home videos 150, 168
- HP Media Drive
 - inserting a drive 106
- HP Personal Media Drive 105
 - activity and power lights 106
 - automatic on and off feature 106
 - disconnecting the drive 110
 - location and drive letter 108
- HP Photosmart Essential 84
- HP Pocket Media Drive 105
- HP Total Care Advisor 55

I

- Internet Security 46, 81, 137

K

- keyboard
 - connector 5
 - customizing buttons 63
 - shortcuts 63
 - types of buttons 57
 - using 57

L

- LAN 10
- LAN antenna 13
- local area network (LAN) 10

M

- magicSpot 171
- manuals
 - storing 10

- Media Center
 - menu bars 116
 - navigating 117
 - opening with remote control 72
 - playing DVDs 140
 - resizing window 116
 - using with another program open 116
 - what you can do
 - in Music 125
- memory card reader 155
 - card types 99
 - in-use light 103
 - troubleshooting 104
 - using 99
- memory card, formatting 103
- microphone connector 4, 6
- mini-jack 18
- modem connection 15
- modem connector 7
- monitor
 - adjusting 10
- monitor connector 6
- mouse
 - autoscroll 67
 - cursor speed 68
 - panning 67
 - switching button functions 67
- mouse connector 5
- Music 125
 - copying music to CD 136, 137
 - creating a queue list 132
 - deleting music from the Music library 128
 - finding and playing an album 133
 - playing a song 132
 - playing an album 131, 133
 - playing music 130
 - supported file types 129
- music
 - playing with Windows Media Player 139, 144
- music library
 - adding CD tracks 128
 - creating 127
- Mute button 62
- muvee autoProducer
 - adding a title and credits 167
 - adding music 167
 - adding pictures 170
 - adding video 167, 169
 - allowing music to repeat 172
 - allowing video and pictures to repeat 172

- basic steps to create a movie 165
- changing settings 172
- copying a movie to disc 176
- features 85
- getting started 166
- getting video from a camera 167
- making a movie 173
- previewing a movie 174
- rotating images clockwise 171
- selecting style 171
- setting the duration of video 172
- upgrading 177
- using the magicMoments feature 170

My Music 125

- playing an album 133

N

- network interface adapter 5
- Network Interface Card (NIC) 12
- network name (SSID) 14
- Norton Internet Security
 - configuring 82
 - registering 82

O

- Off button, See turning off PC 48
- optical drive quick reference 97
- Optimization setting 114, 123

P

- panning with the mouse 67
- passwords
 - creating 53
- PC
 - front-panel connectors 2
 - Help & Tools 40
 - setting up 1
 - turning off 48
- peripherals 2
- pictures 155
 - copying pictures to CD 162
 - editing 159
 - image not displayed 159
 - printing 159
 - rotating 161
 - types of files it can display 159
 - viewing a slide show with music 158
- Pictures and Videos 155
- pictures, turning captions on or off 157
- pictures, viewing 157

- pictures, viewing pictures as a slide show 158
- playing
 - digital music files 130
 - digital videos 163
 - DVDs in Media Center 140
 - music CDs in Media Center 130
 - songs in Music 132
- playing music CDs 139, 145
- playing songs
 - Buy Music option 133
 - Visualize option 133
- playlist
 - creating in Music 134
- power connector 5
- printer
 - connecting 9
 - connector 5

Q

- queue list
 - creating in Music 132

R

- RealOne Player, features 85
- RealPlayer, features 85
- recording
 - videos from digital video camera 150, 168
- remote control
 - buttons 70
 - range 72
 - type of battery to use 73
 - using 72
- remote sensor 73
 - using 72
- repetitive strain injury (RSI), see *Safety & Comfort Guide*
- rewritable discs, erasing 148
- Roxio Creator
 - erasing discs 148

S

- Safety & Comfort Guide 43
- safety warnings 43
- scanner, connecting 9
- scrolling with the mouse 66
- setting up PC 1
- settings
 - for sound 122
 - general 122
 - Internet connections 122
 - remote control and remote sensor 73

- Shared Video folder 163
- shortcuts
 - keyboard 63
- shutting down PC 48
- sleep mode button 60
- slide show
 - displaying information about pictures 158
 - viewing pictures 158
 - viewing with music 158
- software programs
 - DVDPlay 84
 - Windows Movie Maker 86
- speaker systems 20
- speakers
 - connecting multichannel audio speakers to the PC 19, 22–35
- Start menu
 - Media Center 116
- stereo
 - connecting to the PC 28
- Support
 - messages 40
- surge protector 2
- SVCD 176
- S-video In connector 4, 6
- switching mouse button functions 67

T

- transferring information to your new computer 55
- troubleshooting
 - remote sensor 73
- turning off PC 48
- tweak muvee 174

U

- update, Windows Vista 52
- updates from Compaq Connections, using 40
- updates from HP Connections, using 40
- updating, system 52
- USB connector 4, 5
- user accounts
 - creating 53

V

- VCD 176
 - playing with Windows Media Player 145
- video capture
 - live 168
 - recorded video 168

- video editing
 - getting started with muvee autoProducer 166
- video movies
 - transferring 164
 - transferring and recording 164
- videos 162
 - creating a CD or DVD 164
 - playing 162
 - playing digital videos 163
 - transferring videos 164
 - working with home videos 8
- visualization settings 131
- volume
 - controls 62

W

- Web Streaming 175
- WEP 14
- Windows Media Center
 - playing videos 162
 - viewing your pictures 157
- Windows Media Player
 - play DVDs 144
 - play music CDs 139
 - playing video CDs 145
 - setting as default player 129
 - types of files 129
- Windows Movie Maker, features 86

- Windows Vista update 52
- wired network connection 12
- wireless devices 12
- wireless LAN 13
- wireless LAN connection
 - connection 13
- wireless local area network (WLAN) 12
- wireless network
 - name 14
 - security 14
- wireless network device
 - checking installation 14
- wireless wide area networks (WWAN) devices 13
- WLAN security 14
- working in comfort 43
- WPA 14

Y

- Y adapter cables 28

Part Number: 5991-6837