



HP LD4730 and LD4730G  
LCD Ultra-slim Bezel Digital Signage  
Displays

User Guide

© 2012 Hewlett-Packard Development Company, L.P. The information contained herein is subject to change without notice.

The only warranties for HP products and services are set forth in the express warranty statements accompanying such products and services. Nothing herein should be construed as constituting an additional warranty. HP shall not be liable for technical or editorial errors or omissions contained herein.

This document contains proprietary information that is protected by copyright. No part of this document may be photocopied, reproduced, or translated to another language without the prior written consent of Hewlett-Packard Company.

Microsoft®, Windows®, and Windows Vista™ are either trademarks or registered trademarks of Microsoft Corporation in the United States and/or other countries.

First Edition (January 2012)

Document Part Number: 658943-001

## About this guide

This guide provides information on setting up the display, installing drivers, using the On-Screen Display menu, troubleshooting, and technical specifications.

 **WARNING!** Text set off in this manner indicates that failure to follow directions could result in bodily harm or loss of life.

 **CAUTION:** Text set off in this manner indicates that failure to follow directions could result in damage to equipment or loss of information.

 **NOTE:** Text set off in this manner provides important supplemental information.

---



---

# Table of contents

<b>1 Product features</b>	<b>1</b>
HP Digital Signage Displays	1
Accessories	2
Optional accessories	2
<b>2 Safety and maintenance guidelines</b>	<b>3</b>
Important safety information	3
Maintenance guidelines	3
Cleaning the LD4730	5
Cleaning the LD4730G	5
Shipping the display	5
<b>3 Setting up the display</b>	<b>6</b>
Unpacking	6
Identifying display components	7
Connecting the speakers (sold separately)	8
Display control panel	9
Identifying remote control buttons	10
Setting up the remote control	11
Mounting a single display on a stand (Sold Separately)	12
Installing the HP LD4730 Frame System (Sold Separately)	12
Securing the display	15
Connecting cables	15
Connecting multiple displays to one player	22
Connecting multiple displays with Video Over Ethernet (VOE)	22
Connecting multiple displays with Tile Mode	24
Mounting the display	27
Mounting in portrait position	28
Considerations for wall mounting	28
Software and utilities	29
The information file	29
The image color matching file	29
Installing the driver, .INF and .ICM files	29
Installing from the CD	29
Downloading from the Web	30
Installing management software	30

<b>4 Operating the display .....</b>	<b>31</b>
Using the On-Screen Display menu .....	31
Controlling displays with IR Daisy Chain .....	32
Setting up IR Daisy Chain .....	32
Controlling displays with the IR remote control .....	32
Navigating with the infrared remote control .....	34
Navigating with the control panel .....	34
OSD menu selections .....	35
Power On Delay .....	44
Using Key Lock .....	44
Setting the backlight level .....	44
Preventing and fixing ghost images .....	44
Using Tile Mode .....	44
Optimizing analog images .....	46
Tuning color .....	47
<b>Appendix A Troubleshooting .....</b>	<b>52</b>
Solving common problems .....	52
Using Online Technical Support .....	53
Preparing to call technical support .....	54
<b>Appendix B Technical specifications .....</b>	<b>55</b>
HP Digital Signage Display .....	55
Recognizing preset display resolutions .....	57
Preset display modes .....	57
High definition video formats .....	58
Display quality and pixel policy .....	59
Power indicator .....	59
<b>Appendix C Agency regulatory notices .....</b>	<b>60</b>
Federal Communications Commission notice .....	60
Modifications .....	60
Cables .....	60
Declaration of Conformity for products marked with the FCC logo (United States only) .....	60
Canadian notice .....	61
Avis Canadien .....	61
European Union regulatory notice .....	61
German ergonomics notice .....	62
Japanese notice .....	62
Korean notice .....	62

Power cord set requirements .....	62
Japanese power cord requirements .....	62
Product environmental notices .....	63
Disposal of waste equipment by users in private households in the European Union .....	63
Chemical substances .....	63
HP recycling program .....	63
Restriction of Hazardous Substances (RoHS) .....	63
Turkey EEE regulation .....	64
Ukraine Restriction of Hazardous Substances .....	64





---

# 1 Product features

## HP Digital Signage Displays

The LD4730 and LD4730G digital signage displays have a wide-aspect active matrix thin-film transistor (TFT) panel. The displays' features include the following:

- 119 cm (47 inch) diagonal screen with 1366 x 768 native resolution
- Ultra-slim bezel for minimal visual distraction and near-seamless tiling
- Landscape and portrait wall mounting positions
- Video inputs for VGA, Video Over Ethernet, and DisplayPort
- Audio input jack and external speaker ports
- Infrared remote control
- Remote, centralized control with HP Network Sign Manager
- External IR Sensor for group or selected control of displays in a video wall
- Tiling for video walls
- Color matching and calibration for all displays in a video wall
- Mercury-free LED backlight
- Ambient light sensor and high brightness for energy savings and good visibility in any light
- Local dimming for enhanced contrast in dark areas of the image
- On-Screen Display (OSD) menu in several languages for ease of setup and screen optimization
- Screen adjustment buttons (Power On/Off, OSD Controls, MENU, and INPUT) on the back of the display
- Management software for stand-alone displays on or off a network
- DDC/CI interface to allow control of the display from an attached PC
- User controls to adjust Picture, Tile Mode, Timer, Energy Saving, Aspect Ratio, Audio, and additional setup options
- Plug and play capability if supported by the operating system
- Security cable provision on rear panel to lock down the display and help prevent theft
- High-bandwidth Digital Content Protection on the DisplayPort input
- Temperature Sensor
- Support VESA compliant mounting interface with choice of 400 x 200 mm (15.74 x 7.87 in) and 400 x 400 mm (15.74 x 15.74 in) hole patterns

In addition, the LD4730G model features a protective glass overlay with an easy-to-clean coating.

## Accessories

- Software and documentation CD
- Remote control
- Power cord
- DisplayPort cable
- RGB (VGA) cable
- External infrared sensor
- Infrared daisy chain cable

## Optional accessories

The following can be purchased separately:

- Stand kit
- Speakers kit
- HP LD4730 Frame System
- HP DreamColor Display Calibration Solution

---

## 2 Safety and maintenance guidelines

### Important safety information

A power cord is included with the display. If another cord is used, use only a power source and connection appropriate for this display. For information on the correct power cord set to use with the display, refer to the [Power cord set requirements on page 62](#).

---

**⚠ WARNING!** To reduce the risk of electric shock or damage to the equipment:

- Do not disable the power cord grounding feature. The grounding plug is an important safety feature.
- Plug the power cord in a grounded (earthed) outlet that is easily accessible at all times.
- Disconnect power from the product by unplugging the power cord from the electrical outlet.

For your safety, do not place anything on power cords or cables. Arrange them so that no one can accidentally step on or trip over them. Do not pull on a cord or cable. When unplugging from the electrical outlet, grasp the cord by the plug.

To reduce the risk of serious injury, read the *Safety and Comfort Guide*. It describes proper workstation, setup, posture, and health and work habits for computer users, and provides important electrical and mechanical safety information. This guide is located on the Web at [www.hp.com/ergo](http://www.hp.com/ergo) and/or on the documentation CD, if one is included with the display.

**⚠ CAUTION:** For the protection of the display, as well as the media player/computer, connect all power cords for the media player/computer and its peripheral devices (such as a display, printer, scanner) to some form of surge protection device such as a power strip or Uninterruptible Power Supply (UPS). Not all power strips provide surge protection; the power strips must be specifically labeled as having this ability. Use a power strip whose manufacturer offers a Damage Replacement Policy so you can replace the equipment, if surge protection fails.

---

Use the appropriate and correctly sized furniture designed to properly support your display.

**⚠ WARNING!** Displays that are inappropriately situated on dressers, bookcases, shelves, desks, speakers, chests, or carts can fall over and cause personal injury.

Care should be taken to route all cords and cables connected to the display so that they cannot be pulled, grabbed, or tripped over.

**⚠ CAUTION:** Do not place the device in a location where water may drip and/or splash on the device.

---

Do not place an object that contains water, such as a flower vase, on the device.

### Maintenance guidelines

To enhance the performance and extend the life of the display:

- Do not open the display cabinet or attempt to service this product yourself. Adjust only those controls that are covered in the operating instructions. If the display is not operating properly or has been dropped or damaged, contact an authorized HP dealer, reseller, or service provider.
- Use only a power source and connection appropriate for this display, as indicated on the label/back plate of the display.

- Be sure the total ampere rating of the products connected to the outlet does not exceed the current rating of the electrical outlet, and the total ampere rating of the products connected to the cord does not exceed the rating of the cord. Look on the power label to determine the ampere rating (AMPS or A) for each device.
- Install the display near an outlet that you can easily reach. Disconnect the display by grasping the plug firmly and pulling it from the outlet. Never disconnect the display by pulling the cord.
- Turn the display off when not in use. You can substantially increase the life expectancy of the display by using a screen saver program and turning off the display when not in use.

---

 **CAUTION:** Burn-in or image sticking might occur on displays which display the same static image on the screen for prolonged periods of time. To avoid burn-in or image sticking and to prolong the life of the display, you should activate one of the four ISM selections in the OSD, activate a screen-saver application, periodically cycle between static information and moving images, or turn off the display when it is not in use for prolonged periods of time.

---

- Slots and openings in the cabinet are provided for ventilation. These openings must not be blocked or covered. Never push objects of any kind into cabinet slots or other openings.
- Do not drop the display or place it on an unstable surface.
- Do not allow anything to rest on the power cord. Do not walk on the cord.
- Keep the display in a well-ventilated area, away from excessive light, heat or moisture.
- When removing the display base, you must lay the display face down on a soft area to prevent it from getting scratched, defaced, or broken.

## Cleaning the LD4730

1. Turn off the display and unplug the power cord from the back of the unit.
2. Dust the display by wiping the screen and the cabinet with a soft, clean antistatic cloth.
3. For more difficult situations such as removing fingerprints or other substances from the display screen, use a foam window cleaner with no petroleum derivatives or alternatively use a 50/50 mix of water and isopropyl alcohol sprayed onto a cloth to clean the screen surface. Make sure to protect against dripping any liquid under the bezel.

---

 **CAUTION:** Never spray the cleaner directly on the screen surface. It might seep behind the bezel and damage the electronics.

**CAUTION:** To clean the display screen or cabinet, do not use cleaners that contain any petroleum-based materials such as benzene or thinner or any volatile substance. These chemicals might damage the display.

---

## Cleaning the LD4730G

The protective glass on the LD4730G is extremely easy to clean. Most marks wipe off with a dry cloth. Use a foam window cleaner with no petroleum derivatives to remove more difficult substances. Avoid scrubbing with any abrasive materials or scraping, as this can scratch the glass.

## Shipping the display

Keep the original packing box in a storage area. You might need it later if you move or ship the display.

---

## 3 Setting up the display

The display offers multiple connections for video and audio input. Analog video is input through the VGA port, while digital video can be input through either Video Over Ethernet (VOE) or DisplayPort.

Sound can be transmitted with accompanying video through VOE or DisplayPort. To play sound accompanying VGA video, use the audio connection.

Control data, such as power-on or input-select, can be sent through the infrared remote control, an attached media player/computer via RS-232, a networked media player/computer via Ethernet (use the HP Network Sign Manager software), or using the control panel buttons on the back of the display.

The displays can be mounted on a stand or a wall. The stand allows good access to the control panel.

With wall mounting, you can control the display with the remote or through software running on a media player/computer. The HP Network Sign Manager is designed for this purpose.

Displays can be set up in a tiled array. See [Using Tile Mode on page 44](#) for details. The external IR sensor is particularly helpful for displays mounted in an array. Displays can be connected by their IR ports with the IR daisy chain Cable and be controlled either as a group or singularly using the remote control (See [Controlling displays with IR Daisy Chain on page 32](#) for more details).

## Unpacking

---

 **CAUTION:** Always use the handles on the back of the display to lift or move it. Avoid holding on to the bezel or frame.

---

Care must be taken to avoid breaking or scratching the glass surface of the LD4730G model display. Size and weight make it advisable for two people to unpack it together. When laying it flat, either lay it on its back or on a padded, flat surface. When handling the display, always use the four handles on the back of the display and avoid placing hands on the bezel or frame to lift or move the display.

# Identifying display components

The major components of the display and their functions are shown here.

**Figure 3-1** Display components

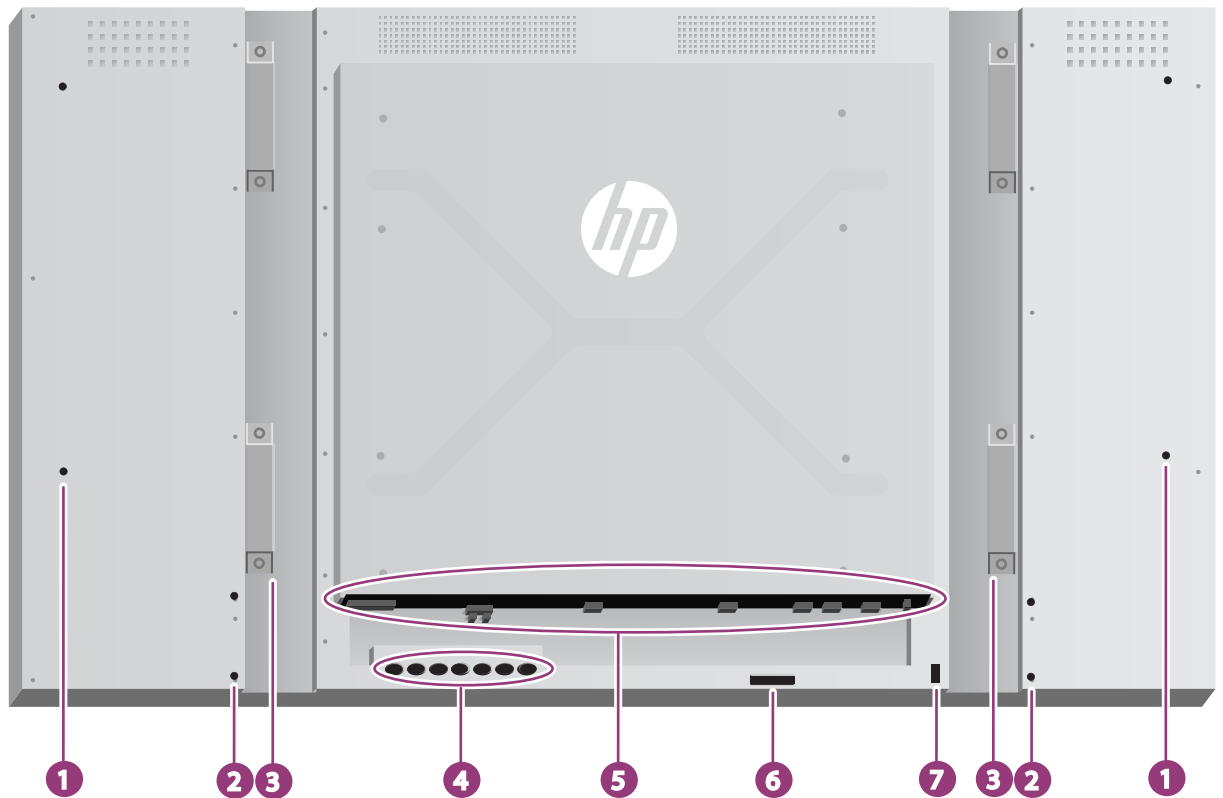

**Table 3-1** Major components

Component	Function
1	Speaker installation: 4 holes
2	Stand installation: 4 holes
3	Handles: 4
4	Control panel with power and OSD navigation buttons
5	Power and data connectors
6	Remote control sensor and ambient light sensor
7	Security cable provision

## Connecting the speakers (sold separately)

1. Mount the speakers onto the display.

**Figure 3-2** Mounting the speakers



2. Use the four Taptite D3 x 12 mm (0.47 in) screws to secure the speakers to the display.

**Figure 3-3** Securing the speakers to the display

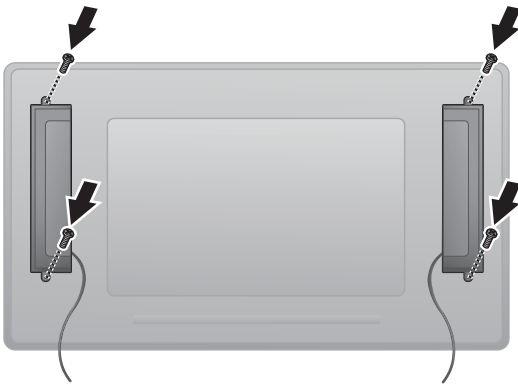

3. After installing the speakers, connect to the SPEAKER input terminal by connecting the proper color match for the left and right speakers.

**Figure 3-4** Connecting to the input terminal

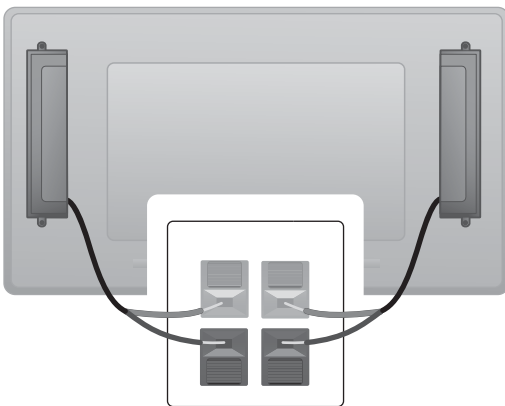



## Display control panel

This picture shows the controls on the back of the display. For details on using them, see [Navigating with the control panel on page 34](#).

**Figure 3-5** Controls

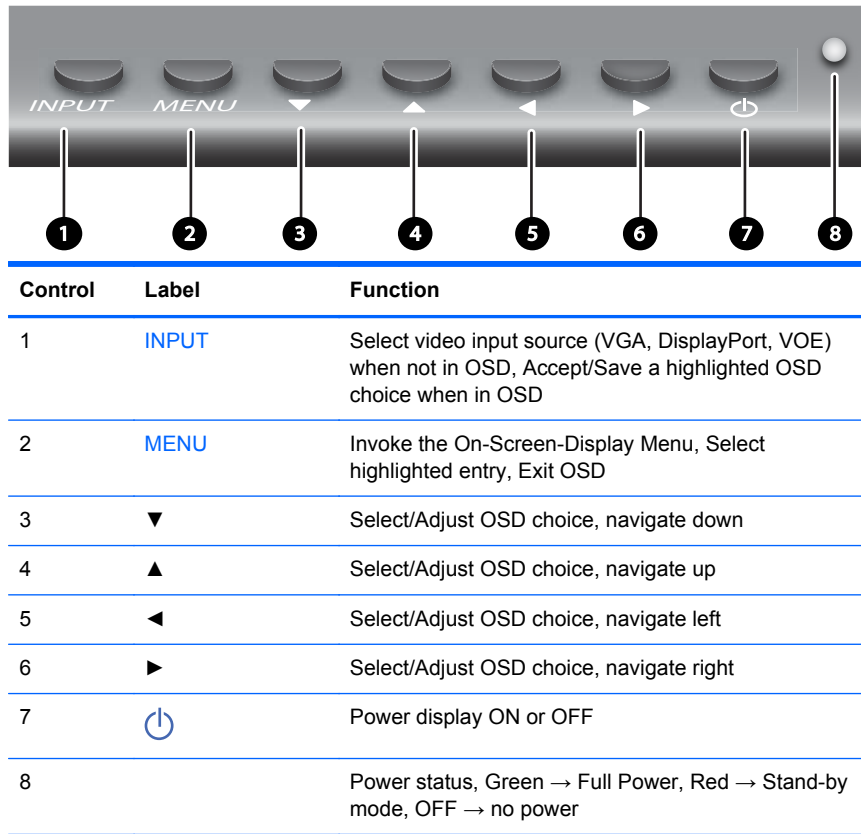

## Identifying remote control buttons

Figure 3-6 Remote control buttons



Label	Function	Description
MUTE	Sound mute	Turns the sound on or off
	Power on/off	Turns the display on or off.
1 – 9	Number	Press once to enter a number. Press repeatedly to enter a letter.
0	Zero or Space	Press once to enter zero, second time to enter a space.
.	Period	Decimal point or period.
	Back or Delete	Navigates backward, to the previous menu screen or delete text in text box.
DEL		
INPUT	Input	Select video source (VGA, DisplayPort, VOE).
EXIT	Exit	Exits the on-screen menu. Unsaved changes will be lost.
	Up/down/left/right arrows	Allows navigation of the On-Screen Display menus and adjustment of the system settings
VOL –	Volume down (-)	Adjusts the speaker volume down (when not in OSD)
VOL +	Volume up (+)	Adjusts the speaker volume up (when not in OSD)
ENTER	Enter	Accepts a highlighted selection or saves a setting.

Label	Function	Description
INFO	Information	Invokes the <b>Information</b> option of the OSD menu.
MENU	Menu/Select	Invokes the On-Screen-Display main menu, invokes submenus within the OSD.
VGA	VGA input select	Selects VGA video input source for viewing.
PSM	Picture submenu	Invokes the <b>Picture</b> menu of the OSD.
VOE	Video Over Ethernet input select	Selects VOE video input source for viewing.
DP	DisplayPort input select	Selects DisplayPort video input source for viewing.
TILE	Tile mode	Opens the <b>Tile Mode</b> submenu of the OSD.
Color CAL	Color calibration	Launches the color calibration process.

## Setting up the remote control

Insert the batteries into the remote control as follows:

**Figure 3-7** Inserting batteries

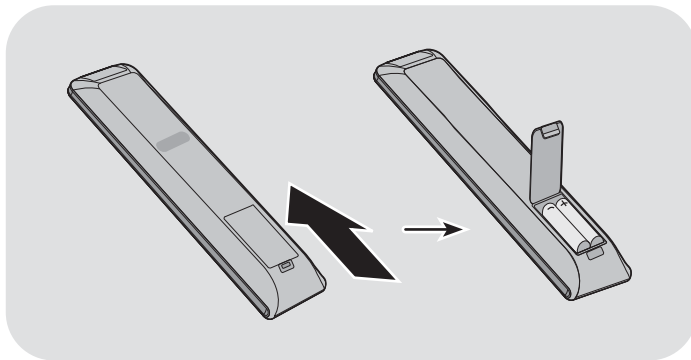

1. Slide off the battery cover.
2. Insert the batteries with correct polarity (+/-).
3. Close the battery cover.

 **NOTE:** To prevent environmental pollution, dispose of used batteries in accordance with your local recycling guidelines.

## Mounting a single display on a stand (Sold Separately)

The stand kit is an optional accessory available from HP. It allows you to mount a single display in landscape position. To mount the display on the stand:

1. Remove the four M4 x 32 mm (1.26 in) screws and stand from the box.

**Figure 3-8** Stand accessory contents

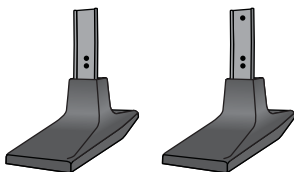

2. Place a soft cloth on the table and place the display with the screen facing downward. Connect the stand as shown in the following figure.

**Figure 3-9** Securing the stand to the display

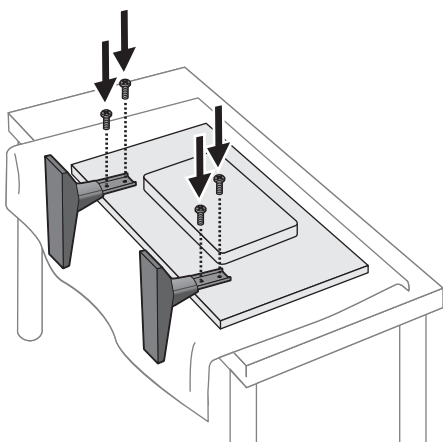

The long side of the foot should face forward when the screen is upright.

## Installing the HP LD4730 Frame System (Sold Separately)

The frame system creates a 10 mm border around one or more LD4730 displays, giving the edge a finished look. To frame a group of displays, you need as many kits as you have displays in a row or column, whichever is greater. For example, three kits will frame a 3 x 3 group, a 3 x 1 group, or a 1 x 3 group.

The frame kit includes four rails, one each for top, bottom, left and right. It also contains four interchangeable corner pieces and four interchangeable straight connectors.

The rails are labelled **TOP** for the top in landscape position, **BOTTOM** for the bottom in landscape position, **RIGHT** for your right side as you face the front of the screen, and **LEFT** for your left side as you face the front of the screen. All the screw holes match for the one rail that goes to each side; no force is needed. Attempting to attach the wrong rail could damage the bezel.

When you frame a single array, the numbers on the rails match at each corner:



To frame a single display, attach the top rail to the top of the display with three of the large (M4 x 10 mm) screws provided. The rail overlaps the bezel of the display. Attach the bottom, left, and right rails in the same manner, leaving the two small holes at each end open.

**Figure 3-10** Attaching rails

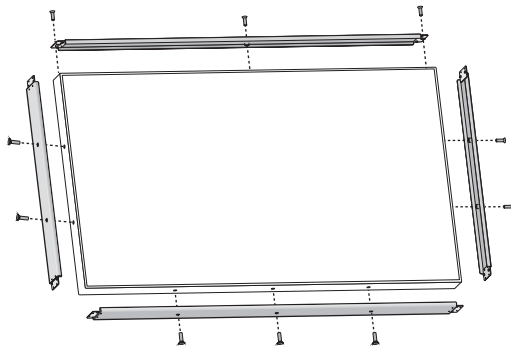

Attach the four corner pieces with four small (M3 x 5 mm) screws each. These overlap the rails and secure their ends.

**Figure 3-11** Attaching corners

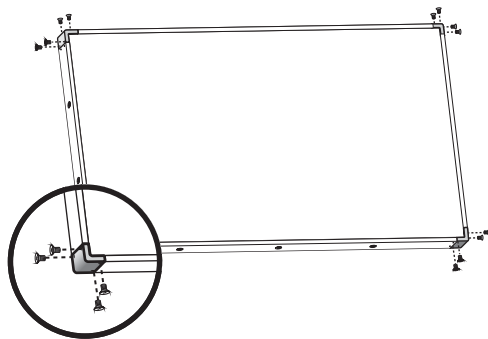

Framing a group of displays is similar to framing a single display except that you will use some of the straight connectors to cover the gap between adjacent displays.

**Figure 3-12** Framing an array

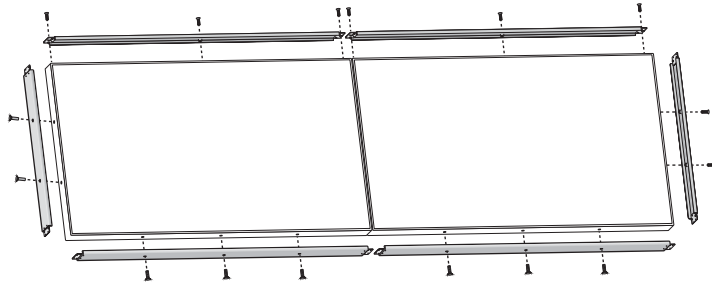

Attach corners and straight connectors after the rails are in place.

**Figure 3-13** Attaching corners and connectors

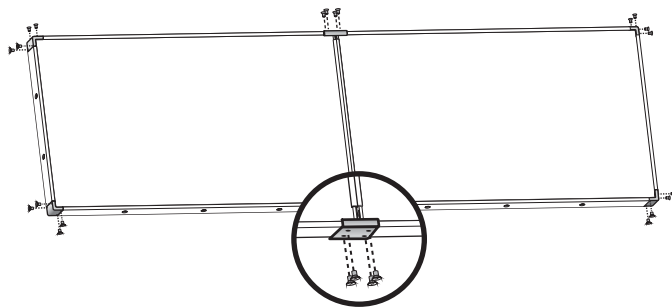

When you frame an array, the peripheral displays can no longer move independently. For this reason, the following tasks may best be done before framing:

- Color Calibration
- Attaching all cables
- Putting the main power switch in the ON (I) position
- Horizontal, vertical and depth adjustment of all displays

## Securing the display

**Security cable provision**—To help prevent theft, a security cable provision is available on the rear of the display. The cable and lock required to connect to the display are available separately and can be purchased from HP.

**Figure 3-14** Cable lock

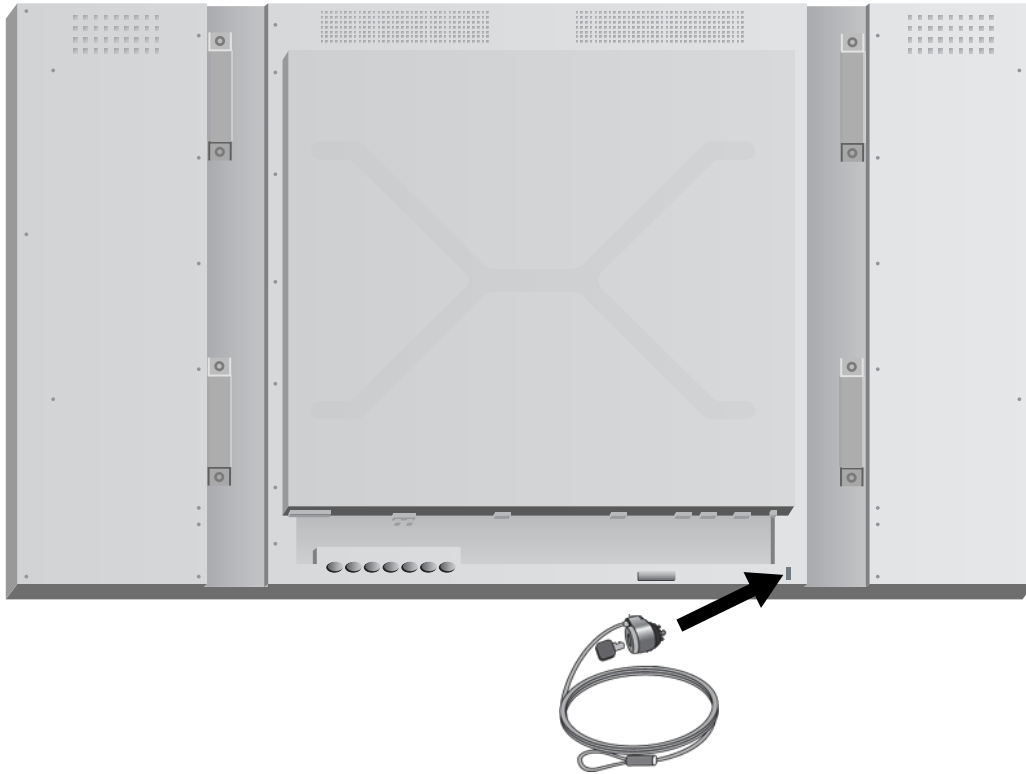

## Connecting cables

**Figure 3-15** Connectors

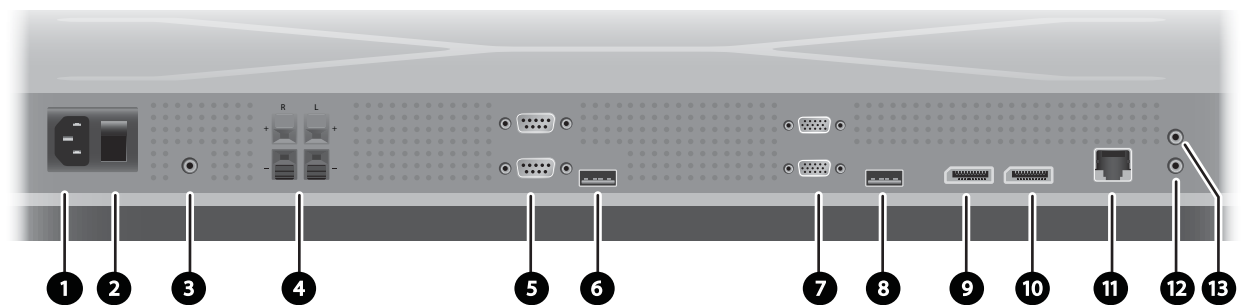

	Label	Function
1	AC-IN	Receives the power cord.
2	AC SWITCH	Turns off or on power to entire device, controller as well as screen.
3	LINE-IN	For an audio cable connected to the Line Out on a media player or computer sound card. The plug should be a standard-sized, TRS-type with stereo capability.
4	SPEAKER-OUT	Audio output for bare-wire speaker connection to external speakers (sold separately).
5	RS232-OUT, RS232-IN	Serial port for control of the display. Takes a 9-pin, null-modem RS-232 cable connected to a controlling media player/computer or another digital signage display.
6	USB	For a color-calibration device or firmware upgrade.
7	VGA-OUT, VGA-IN	VGA input connects to a media player/computer or another display to support analog video and command data. VGA output supports chaining with VGA cables from display to display. The plug should be a 15-pin, D-Sub type.
8	SERVICE PORT	Used by authorized service personnel only.
9	DP-IN	DisplayPort input for digital video from a media player/computer. Connects to a media player/computer or another display in a chain.
10	DP-OUT	To connect to the DisplayPort input of another display in a chain.
11	Ethernet	RJ45 connector for video and command data from a network. Takes an Ethernet cable connected to a LAN or WAN; a network router, hub or switch; or directly to a media player/computer.
12	IR-IN	Infrared input for the external IR sensor (included) or the output from the previous display in a daisy chain (Blue Connector).
13	IR-OUT	Infrared output to connect to the next display in a daisy chain, for control of all displays with a single IR remote control (Green Connector).

Follow these steps for connecting cables:

1. Connect the AC power cord to the receptacle on the rear of the display (1).

**Figure 3-16** Power



Read the power-cord safety precautions in [Important safety information on page 3](#), then plug the other end into an electrical outlet.

**Figure 3-17** Connecting the power cord





- Put the master power switch (2) into the ON (I) position.

**Figure 3-18** Turn On Power Switch

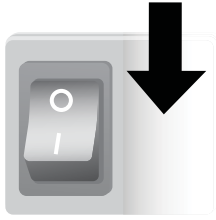

- If you will be using the VGA input for video, and you want to play the audio feed through the external speakers, connect one end of an audio cable (sold separately) to the Audio input jack (3) and the other end to the Line Out jack on the media player/computer.

**NOTE:** Before connecting to the AUDIO port on the display, verify what type of Audio Out connection is available on the media player/computer sound card. The Line Out on a media player/computer is used to connect to speakers, including a built-in amplifier (AMP). For additional instructions, refer to the sound card manual.

If the Audio Out on the media player/computer sound card has only Speaker Out, reduce the media player/computer volume before connecting to the AUDIO port on the display.

If the Audio Out on the media player/computer sound card supports both Speaker Out and Line Out, choose Line Out.

**Figure 3-19** Audio connection

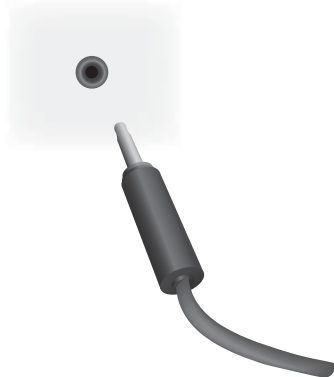

**NOTE:** The ferrite core can be used to reduce electromagnetic waves when connecting an audio cable. Fit the ferrite core to the audio cable. The ferrite core needs to be separated from the mold by 5 cm (2 in).

**Figure 3-20** Using the ferrite core

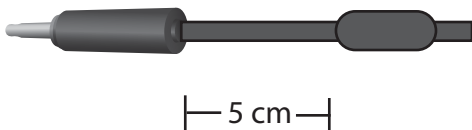

4. If you will be employing the HP external speakers, the bare speaker wire should be connected to the matching color coded speaker connector for the Right and Left speaker, as in [Connecting the speakers \(sold separately\) on page 8](#).

**Figure 3-21** External speaker connections

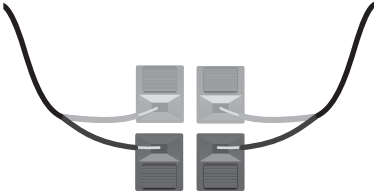

5. If you want to remotely control and manage the display with the RS-232 Serial interface, attach one end of an RS-232 cable to the RS-232 input (5) port (With the display lying on its face, the input port is below the output port) and connect the other end to the serial interface port of the media player/computer.

If you will be connecting more displays in a series (daisy chain), connect one end of a second RS-232 cable to the output (upper) port of the display and the other end of the RS-232 cable to the input port of the next display in the chain. (See [Connecting multiple displays to one player on page 22](#) for more details).

**Figure 3-22** RS-232



6. The USB port is for attaching a color-calibration device such as the HP DreamColor Display Calibration Solution and is also used in the event of a firmware upgrade. Neither USB device is plugged in until the time of use. However, if access to the USB port (6) will be limited once the display is mounted, you can attach a USB extension cable now.

**Figure 3-23** USB



7. If you will be using analog video, plug the VGA cable into the VGA input connector (7). Since the VGA connection does not transmit audio, you may need to connect an audio cable as described in Step 1 (input is the lower of the two VGA connectors with the display on its face) and plug the other end of the VGA cable into the VGA adaptor on the media player/computer.

If you will be connecting this display to another display via VGA (daisy chain), plug a one end of a second VGA cable into the Output (upper) VGA connector (7) on the display and plug the other end of the VGA cable into the Input (lower) VGA connector of the next display in the chain. (See [Connecting multiple displays to one player on page 22](#) for more details.)

**Figure 3-24** VGA connection



Plug the free end of the VGA cable into a media player/computer or the previous display in a chain of displays.

8. If you want to send video over the DisplayPort, connect the DisplayPort cable to the DP IN port on the display (9) and connect the other end of the DisplayPort cable to the DisplayPort adaptor of the media player/computer.

If you will be connecting this display to another display via DisplayPort (daisy chain), plug a one end of a second DisplayPort cable into the DP-Out connector (10) on the display and plug the other end of the DisplayPort cable into the DP-IN connector of the next display in the chain. (See [Connecting multiple displays to one player on page 22](#) for more details.)

**Figure 3-25** DisplayPort



Connect the free end of the DisplayPort cable to the DisplayPort OUT port on the media player/computer or previous display in a series.

---

**NOTE:** Since DisplayPort does not support RS-232 command data, you will also need to connect either an RS-232 cable between the display and media player/computer or an Ethernet connection to the network or media player/computer to use HP Network Sign Manager to manage and control the display remotely.

---

9. If you will be connecting the display to a network, plug your CAT-5 network cable into the Ethernet port (11).

**Figure 3-26** Ethernet



The Ethernet cable from the display can connect to a media player/computer, a router (switch), or an Intranet. A network connection enables the use of the Video Over Ethernet software to assign a media player to drive the display. The connection also allows the HP Network Sign Manager program, running on a networked media player/computer, to send command data.

Connect the Ethernet cable (not included) using one of the following connections:

- **Computer Direct Connection**—Connect the LAN cable to the LAN port on the display and to the LAN port on the media player/computer (1).
- **Router**—Connect the LAN cable to the LAN port on the display and to a LAN port on the router (2).
- **Intranet**—Connect the LAN cable to the LAN port on the display and to the Intranet network via an access point (3).

**Figure 3-27** Connecting the Ethernet cable

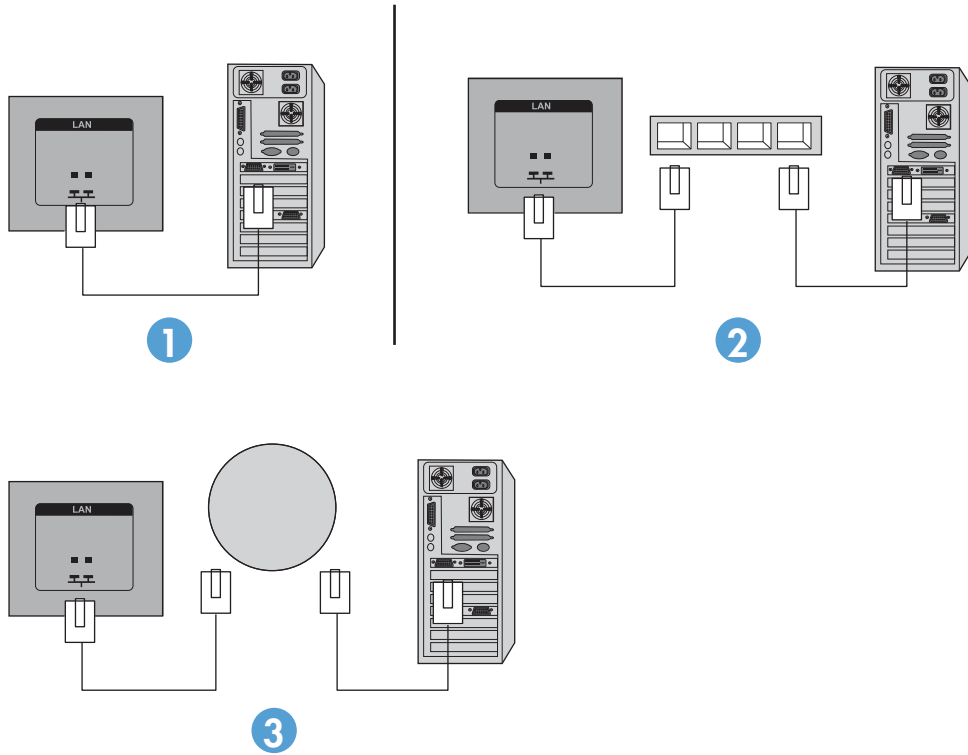

10. If you want to use the external IR sensor, plug it into the IR-IN jack (12). The external sensor makes using the remote easier, especially with displays mounted in a video wall.

**Figure 3-28** Infrared sensor connection

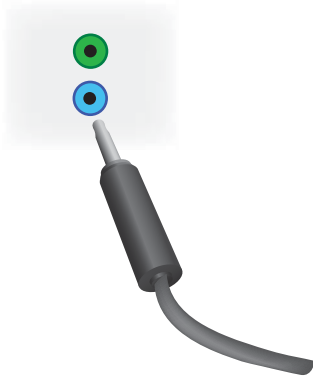

Place the IR sensor facing where you want the remote to be.

11. If you want to connect this display to another in an IR daisy chain, plug the included IR Daisy Chain cable into the IR-OUT jack (13). The free end will plug into the IR-IN of the next display in the chain.

**Figure 3-29** IR-OUT connection



## Connecting multiple displays to one player

Multiple displays may be connected to a single media player/computer two different ways, using Video Over Ethernet or using Tile Mode with VGA or DisplayPort video inputs.

### Connecting multiple displays with Video Over Ethernet (VOE)

To connect multiple displays to a single media player/computer, each display must be connected to the same network as the media player/computer. The input source of each display must be set to VOE. With VOE, displays are connected to media players/computer by establishing an Association between the media player/computer and one or more displays on the network with the VOE software that runs in the media player/computer. Up to 12 displays may be associated with a single media player/computer (See the *VOE Users Guide* for more detail). When multiple displays are associated with a single media player/computer, the displays may be mirrored (a single desktop image displays on all the displays simultaneously).

**Figure 3-30** Mirrored displays



The image may be extended across all the displays simultaneously using the View Span “Display Resolution” dialog box.

**Figure 3-31** Extended desktop

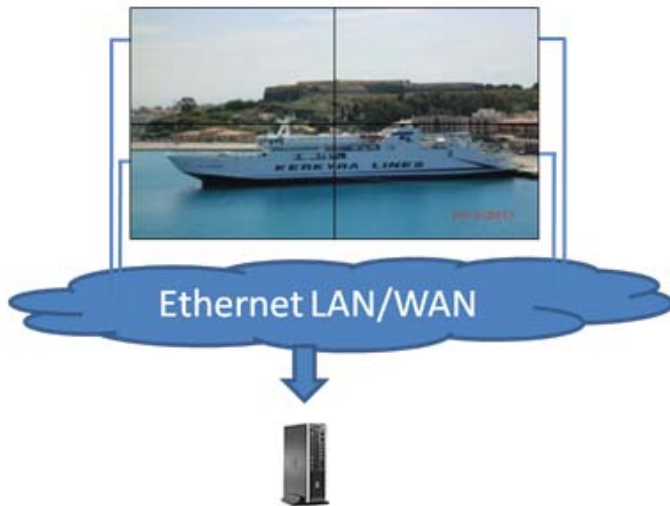

The displays may be treated by an application as though there were up to 12 individual displays connected to 12 graphic adaptor heads on the media player/computer.

**Figure 3-32** Multiple independent displays

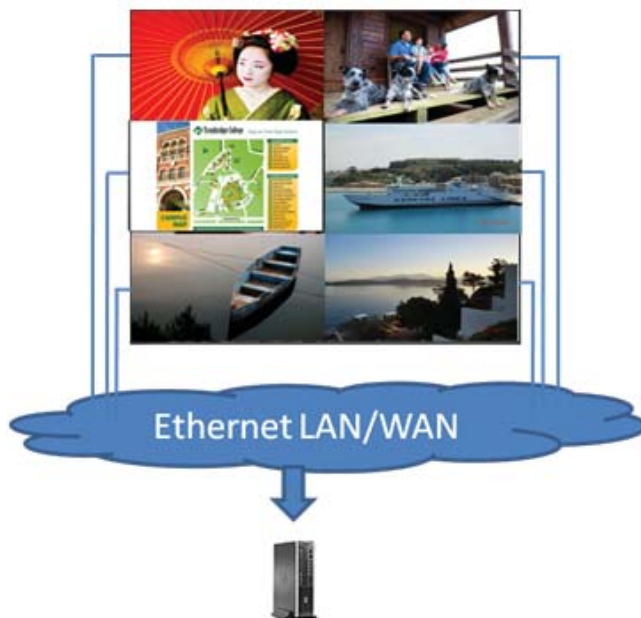

The association of up to 12 displays is the technical limit, and depending upon the complexity of the desktop image to be displayed (playing flash, or streaming video), the number of displays which can be associated with acceptable video performance may be less than 12 (See the *Video Over Ethernet User Guide* for more detail).

## Connecting multiple displays with Tile Mode

The recommended cable routing for daisy chain in Tile Mode is to start with the upper left display and connect across the upper tier of displays going from left to right to the last display in that tier. Then cable from the upper right display to the display just below it and connect across from right to left to the last display on the left. Continue this back and forth, top to bottom cable route for all the tiers in the wall as indicated in the next figure.

**Figure 3-33** Recommended cable routing for Tile Mode

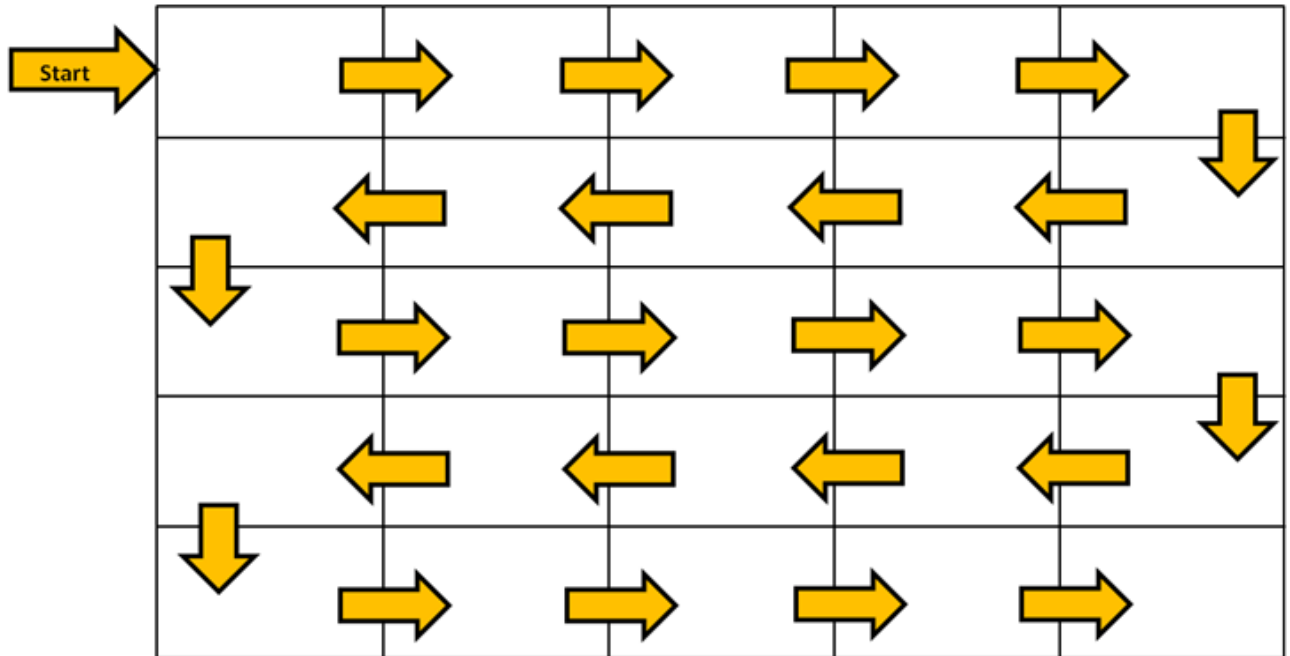

Multiple displays (up to 25) may be connected to a single media player/computer using Tile Mode. Multiple displays in Tile Mode are only supported with either DisplayPort or VGA video input sources. When connecting the multiple displays, the media player/computer is connected to the first display only with either a DisplayPort or VGA connection to the media player/computer. All the subsequent displays are connected to each other via daisy chain using either the DP OUT connector from one display to the DP IN connector of the next display ([Figure 3-35 Daisy chain connection – DisplayPort on page 25](#)), or using the VGA OUT connector from one display to the VGA IN connector of the next display ([Figure 3-36 Daisy chain connection -- VGA on page 25](#)). All displays must be connected with the same video source, either DisplayPort or VGA. When using Tile mode to connect multiple displays, only one desktop image may be displayed across all the tiled displays



**Figure 3-34** Multiple displays with tile mode



**Figure 3-35** Daisy chain connection – DisplayPort

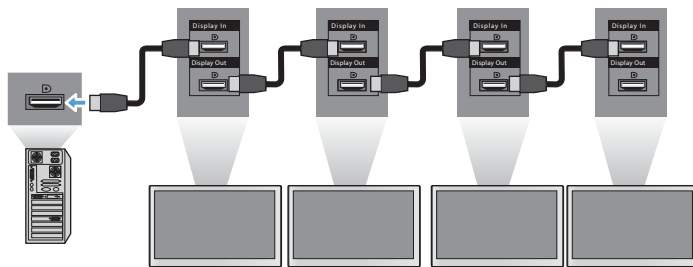

**Figure 3-36** Daisy chain connection -- VGA

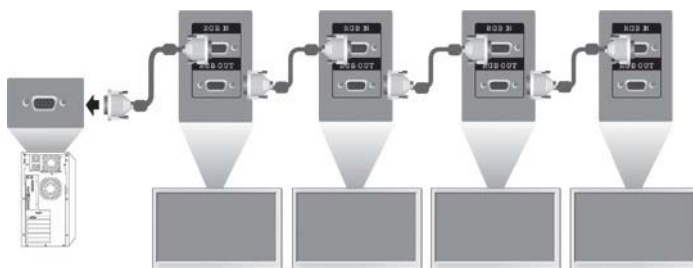

To remotely manage and control multiple displays in Tile Mode when using either VGA or DisplayPort video source, either a RS-232 or Network connection may be used with the HP Network Sign Manager.

If using the RS-232 interface, the displays must be daisy chained with RS-232 cables. Attach one end of a RS-232 cable to the RS-232 Input connector of the first display and connect to the serial connector of the media player/computer. Then attach one end of an RS-232 cable to the RS-232 Output connector and the other end to the RS-232 Input connector of the next display and continue to connect the RS-232 cables between each display in the tiled matrix as shown in [Figure 3-37 Daisy chain connection – RS232-C on page 26](#).

If using a Network connection, just attach each display to a network hub or access point using a CAT-5 cable, and HP Network Sign Manager will locate each network attached display. The HP Network Sign Manager will allow users to select any display or assigned group of displays to manage and control. If the display is already attached to the network for VOE, there is no further action required. The HP Network Sign Manager will detect the displays via its search function (See the *HP Network Sign Manager Users Guide* for more details).

**Figure 3-37** Daisy chain connection – RS232-C

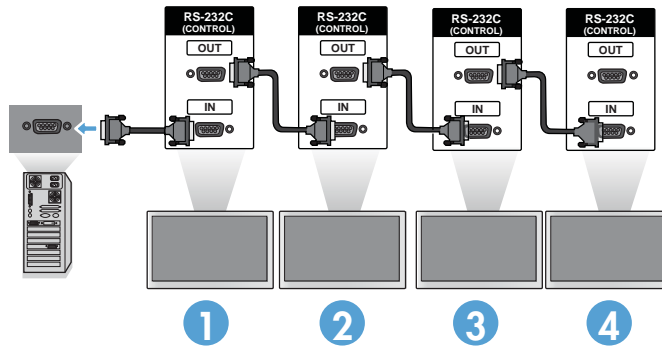

Multiple displays may also be controlled and managed with the IR Remote Control. Since the LD4730/LD4730G primary use is for video walls, use of the External IR Sensor is needed to provide the best IR remote control responsiveness. Connect the supplied External IR Sensor to the IR IN (Blue) jack. Take one end of the supplied IR Daisy Chain Cable and connect it to the IR OUT (Green) jack of the display and connect the other end of the cable to the IR IN jack of the next display as shown in [Figure 3-38 Daisy chain connection – External IR Sensor on page 26](#). Once all the displays are connected, the user can issue any OSD command with the IR Remote Control to all the displays at once (for example, turn the displays ON or OFF, set Picture Mode to VIVID, etc.), or the user can indicate a single display in the wall to control by selecting the ID of the appropriate display and then issuing any OSD command with the IR Remote Control. See [Navigating with the infrared remote control on page 34](#) for more detail.

**Figure 3-38** Daisy chain connection – External IR Sensor

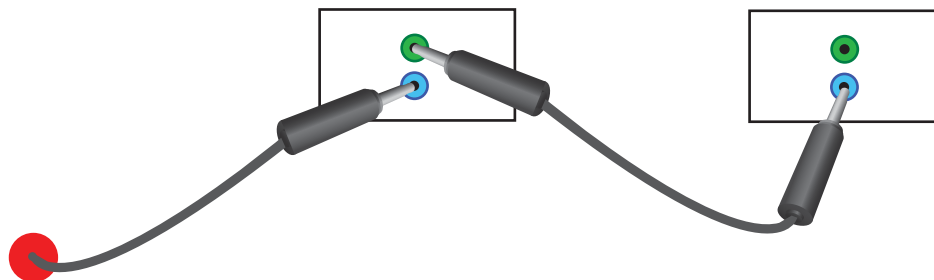

**NOTE:** The number of displays that can be connected by daisy chain to one media player/computer might vary depending on the signal status and cable loss. If the signal status is good, and there is no cable loss, it is possible to connect up to twenty-five displays in a daisy chain from one media player/computer.

If you are going to play video that is copy protected with High-bandwidth Digital Content Protection (HDCP), you must use DisplayPort as the video source, and you are limited to *a maximum of six* displays in the daisy chain which can support HDCP.

When using Tile Mode, the display ID can be set in the display OSD with the IR Remote Control, the display control panel, or for Network attached displays, the display ID can be set with the HP Network Sign Manager software (See [Using Tile Mode on page 44](#) and the *HP Network Sign Manager User Guide* for more details).

After installing the cables, ensure that the power switch on all displays is in the on position (I). Turning the Power Switch ON does not turn the display on. This is especially important if you will be mounting the displays where access to the power switches is difficult.

**Figure 3-39** Turn On Power Switch

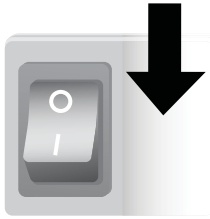

The last step, after all the cables are connected and making sure the Power Switch is turned ON, is to plug the AC power cord into a power source.

## Mounting the display

The display can be mounted on a wall or a stand. If the mounting hardware permits, it can be mounted in landscape or portrait orientation.

**CAUTION:** Always use the handles to lift the display, as the bezel is not meant to take its weight.

**CAUTION:** Two people are needed to safely mount the display.

This product supports a VESA FDMI (Video Electronics Standards Association Flat Display Mounting Interface)-compliant mounting device. The mounting devices can be purchased separately from HP. Two hole patterns are available, holes on 400 mm centers (1) and holes at 400 mm x 200 mm (2).

**Figure 3-40** VESA mounting holes



It is recommended that the 400 mm x 400 mm mounting pattern be used whenever possible.

The distances of each hole to the edges of the display are shown in [Technical specifications on page 55](#). The weight for your model can be found there as well; when mounting to a wall, ensure that the supporting structure is strong enough for the listed weight.

## Mounting in portrait position

When installing the display in the portrait position, rotate it clockwise based on its front. The display can be rotated in only one direction. Arrows on the back of the display indicate which side should be at the top in both portrait and landscape positions:

**Figure 3-41** Up arrows

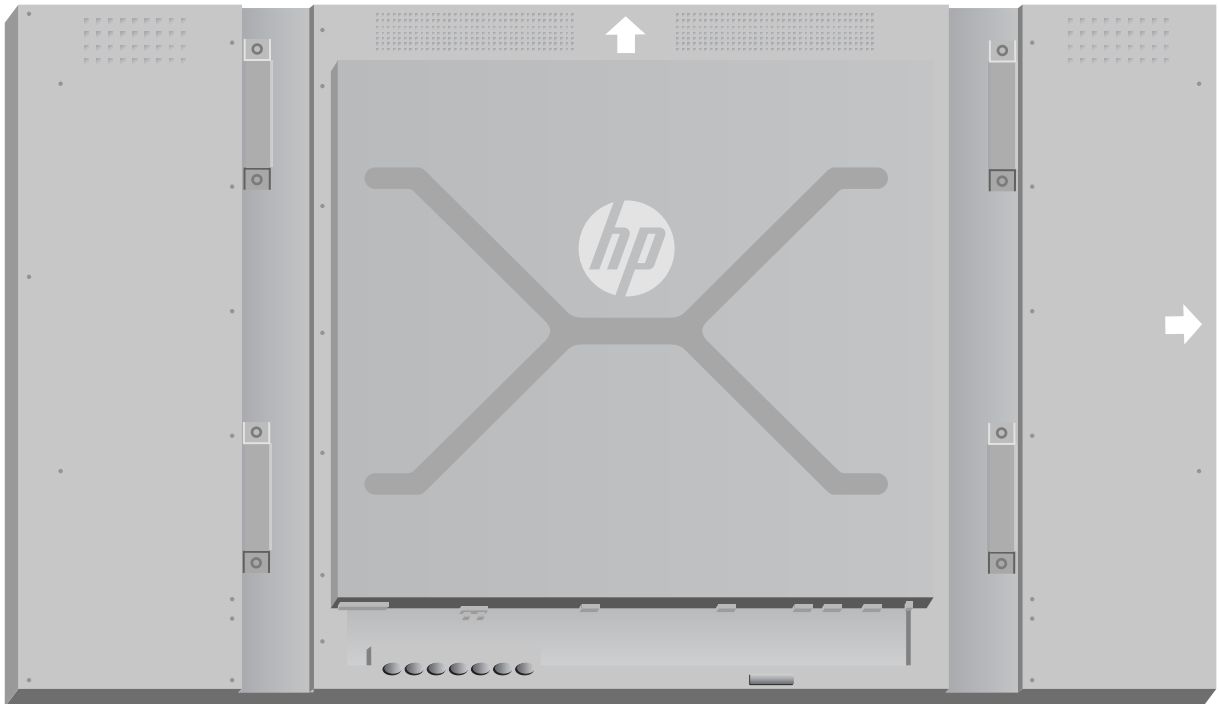

**Figure 3-42** Installing portrait

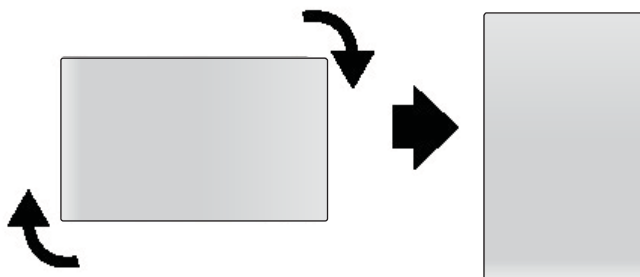

The cable connectors will be on your left as you face the screen.

## Considerations for wall mounting

When mounting displays in a video wall consider the following:

- If all the displays are on one electrical circuit, you can avoid overload at power up by using the Power On Delay option in the OSD menu (Option 2 → Time → Power On Delay).
- Care should be taken to make sure that the displays are mounted so that they are just touching and that there is no load bearing pressure between displays.

- If access to the back of the display will be difficult, you can attach all cables to each display before installation on the wall mount and turn the main power switch ON (I) before placing the display flush against the wall. You can perform any desired color calibration before mounting, or you can install a USB extension cable in the USB port to facilitate color calibration in the future.
- If you will be installing the HP LD4730 Framing System, do so after all displays have been mounted and adjusted.

## Software and utilities

HP displays are Plug-and-Play with Windows® XP, Windows Vista®, and Windows 7 operating systems, so you do not need to install the .INF file or the .ICM file for these operating systems. Software, utilities and documentation are provided on the CD that comes with the display. The most current versions of the following software and utilities can be downloaded from the following HP website for use with the displays as needed: [www.hp.com](http://www.hp.com).

- Display driver firmware
- Auto-adjustment Pattern Utility — Optimizes the display of VGA input.
- Supporting system files, .INF and .ICM
- HP Network Sign Manager — Remote management and control software. Allows you to select and control displays singly or in groups, remotely from a media player/computer connected by RS-232 or Ethernet.
- Video Over Ethernet — Software that runs on the media player/computer which lets you discover network connected displays, associate displays to any media player/computer attached to the network, and send video from the media player/computer to the associated display.

You can also install any of these from the CD that comes with the display.

### The information file

The setup information, or .INF file, defines display resources used by Microsoft® Windows operating systems to ensure display compatibility with the media player/computer's graphics adapter.

### The image color matching file

The image color matching, or .ICM file, is a color data file that is used in conjunction with graphics applications to provide consistent color matching from display screen to printer, or from scanner to the display screen. The .ICM file is only activated from within the graphics applications that support this feature.

### Installing the driver, .INF and .ICM files

The display driver firmware and the supporting system files are packaged together and installed with one download operation.

You can install the .INF and .ICM files from the CD or download them from the HP displays support website.

### Installing from the CD

To install the .INF and .ICM files on the media player/computer from the CD:

1. Insert the CD in the media player/computer CD-ROM drive. The CD menu appears.
2. View the **Display Driver Readme** file.

3. Select **Install display driver software**.
4. Follow the on-screen instructions.
5. Ensure that the proper resolution and refresh rates appear in the Windows Display control panel.



**NOTE:** You might need to install the digitally signed display .INF and .ICM files manually from the CD in the event of an installation error. Refer to the *Display Driver Readme* file on the CD for instructions (in English only).

---

## Downloading from the Web

To download the latest version of .INF and .ICM files from the HP displays support website:

1. Refer to [www.hp.com/support](http://www.hp.com/support) and select the country/region.
2. Follow the links for the display to the support page and download page.
3. Ensure the system meets the requirements.
4. Download the software by following the instructions.

## Installing management software

Two programs are provided to manage displays. **Video Over Ethernet** allows you to assign media players on a network to displays on the same network. The **HP Network Sign Manager** provides remote management and control of digital signage displays. You can select and control individual displays, or you can group displays so that commands will control multiple displays simultaneously.

Install these programs from the CD, if a CD is provided with your display, by choosing the installation option from the menu that appears when you insert the CD into the media player/computer on which you want to run the software and then following the instructions. Alternatively, you can download the programs from [www.hp.com/support](http://www.hp.com/support) and then install from the downloaded package.

For details on using the applications, refer to the *HP Network Sign Manager User Guide* and the *Video Over Ethernet User Guide* (both available only in English) included on the CD provided with the display.

---

## 4 Operating the display

The display can be operated with the infrared remote control, with the control panel buttons, or remotely by any network connected media player/computer using HP Network Sign Manager. The media player/computer running HP Network Sign Manager can be connected to the display directly with an Ethernet peer to peer connection or RS-232-C serial connection, or remotely via an intranet connection.

Operation with the remote or the control panel uses the On-Screen Display (OSD) menu. This chapter details the menu.

The display provides for more than one source of video input. It will scan the various inputs to find an active one and display that image. The default scan order is Video Over Ethernet, DisplayPort, VGA for any inputs that are connected to a video source. Using the OSD menu, you can prevent the display from switching inputs by disabling this function.

In order to send video over a network, you need to install the VOE software on the computer/media player which serves as the source. See the *Video Over Ethernet User Guide* for details.

If the display is not receiving any input, it will go into low power mode (“sleep”). You can send it into low-power mode using the power button on the back, the infrared remote control, or by scheduling sleep times. Scheduling is done through the OSD or management software. You can also prevent the display from sleeping.

### Using the On-Screen Display menu

The on-screen display menu (OSD) lets you set a variety of parameters to control the display. Not all settings are applicable to all video sources and these will be greyed out (unselectable) where they don't apply. Auto Configuration, Clock Frequency, and Clock Phase apply only to VGA input.

Other settings store three values, one each for Video Over Ethernet, VGA and DisplayPort. These settings are:

- Picture Mode
- Contrast
- Brightness
- Sharpness
- Backlight
- Resolution
- Color Temperature
- Speaker
- Aspect Ratio

All other OSD settings need only be set once in order for the new value to apply regardless of the video source.

You can operate the OSD using the infrared remote control or the control panel on the back of the display.

## Controlling displays with IR Daisy Chain

The LD4730/LD4730G provides the capability of using IR Daisy Chain to enable selectable control of the displays locally, using the IR Remote Control when the displays are mounted in a video wall. You may control one display at a time by selecting the ID of the display, or you may control all the displays simultaneously by selecting an ID of "00".

### Setting up IR Daisy Chain

The following describes how to set up the displays for IR Daisy Chain

1. Insert the External IR Sensor into the IR IN (blue) jack at the back of the display
2. Using the included IR Daisy Chain Cable, connect all the displays in the video wall. See [Connecting cables on page 15](#) for details.
3. Using the IR Remote Control or the display control buttons, go to MENU → OPTION 2 → SET MONITOR ID and set the unique ID number (number between 1 and 25) for each display in the video wall
4. Using the IR Remote Control or the display control buttons, go to MENU → OPTION 2 → IR OUT and chose ENABLE for each of the displays in the video wall
5. Using the double sided tape, locate the External IR Sensor away in a spot where it will be easy to point the IR Remote Control. It is recommended that the sensor be located at the top left or right of the video wall.

 **NOTE:** Care should be taken to avoid locating the sensor next to the bottom of any of the displays where the IR sensor of the display could sense the IR Remote Control or where the sensor might block the viewing area of any display.

### Controlling displays with the IR remote control

Point the IR remote control at the External IR Sensor and press the MENU button. The IR Daisy Chain home menu will appear on each display, with the Monitor ID displayed so you can easily identify the display you want to issue the command to ([Figure 4-1 IR Daisy Chain home menu screen on page 32](#)).

**Figure 4-1** IR Daisy Chain home menu screen

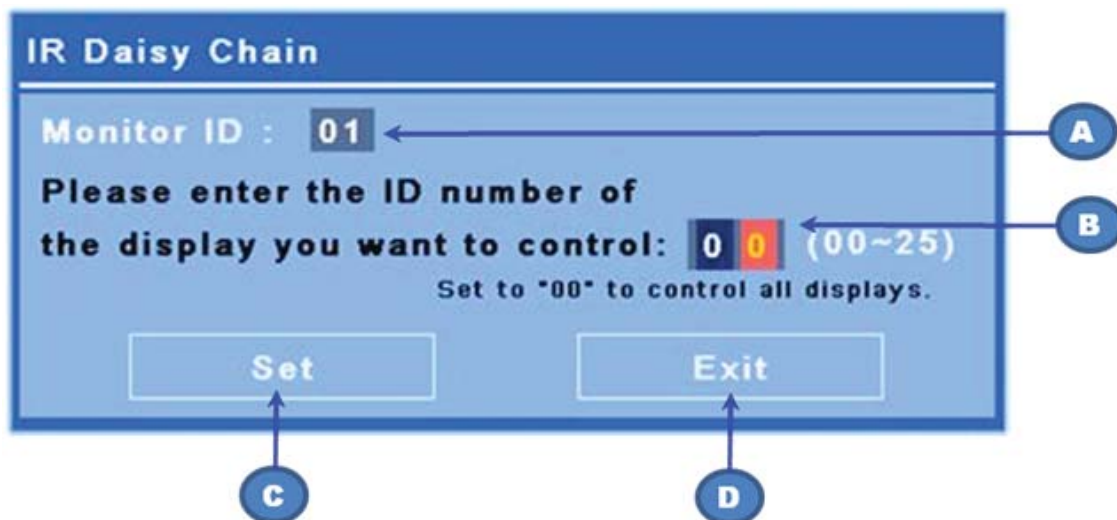



	Menu Setting	Function
A	Monitor ID	ID number assigned to the display in the SET MONITOR ID Dialog
B	IR Daisy Chain Monitor ID	Enter the ID number of the display you want to receive the IR commands or enter "00" to control all the displays simultaneously
C	Set Button	Sets the display ID of the display you want to control and will lock out all the other displays from receiving the commands
D	Exit Button	Exit the IR Daisy Chain dialog without setting the display ID to receive commands

Enter the ID number of the display in the two digit window (following figure). Entering "00" in this window will allow all the displays in the daisy chain to receive the command. This may be useful when turning the displays ON or OFF, or setting the time schedule for the video wall.

**Figure 4-2** Identify the display to control



Press the SET button to select the display ID number as the display you want to send commands. The LOCK message window will appear in all the other displays to indicate that they will not receive any commands from the IR remote control through the External IR Sensor ([Figure 4-3 IR Lock Message on page 33](#)). The On-Screen Display Menu will appear in the display selected. Any command, menu selection, or setting entered with the IR remote control will now be executed by the selected display.

**Figure 4-3** IR Lock Message



After a short period of time, the Lock message will disappear from the displays. At any time, you may press the INFO button on the IR remote control and the Lock message will reappear on the displays not selected to receive the IR commands:

**Figure 4-4** Lock message from INFO command



Pressing the MENU key on the IR remote control will exit the IR daisy chain mode and unlock all the displays.

## Navigating with the infrared remote control

The IR sensor is on the back of the display but will receive IR signals coming from the front. Point the remote control toward the bottom center of the screen. You can also use the external sensor provided, which makes the remote control very easy to use. This is especially true for displays in a video wall. If you have connected multiple displays with IR daisy chain, they will all respond to a key press of the remote. See [Controlling displays with IR Daisy Chain on page 32](#) for more details.

See [Identifying remote control buttons on page 10](#) for details on IR remote control buttons and their functions.

## Navigating with the control panel

If you have access to the control panel at the back of the display, you can use it to turn the screen on and off, and to open and navigate the OSD menu.

**Figure 4-5** Display control panel

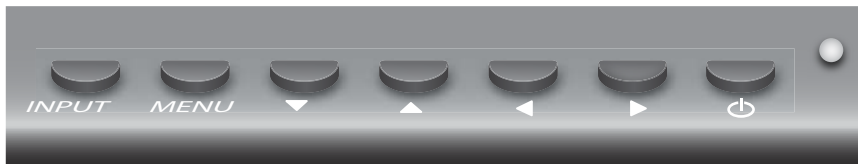

To change the video source, press the **INPUT** button, then select the desired source from the menu that opens on the screen.

To bring up the On-Screen Display menu, press the **MENU** button. Press it again to exit the OSD.

Once inside the menu,

- Use the arrow buttons to highlight your choice. Use them to adjust settings as well.
- To accept a highlighted selection or setting, press the **INPUT** button.

To put the display into low power mode, press the power (⏻) button. Press it again to restore full power.

The buttons can be disabled by pressing the left and right arrows buttons simultaneously and holding for 5 seconds. Repeat this procedure to enable the buttons again.

Single buttons can be disabled and enabled with the following 5-second key presses:

To enable/disable this:	Hold these buttons:
Power button	Right arrow and MENU buttons
IR remote control	Left arrow and MENU buttons
MENU button	Up and down arrows.





The LED indicates the power status:



- Green — full power
- Red — low power (the screen is dark but the controller is listening for commands)
- Off — no power

If the buttons remain untouched for 20 seconds after adjustments have been made but not saved, the current settings will be saved and the OSD menu will close. If the input source, resolution, aspect ratio or frequency changes while the OSD is active, the OSD will close without saving new settings.

## OSD menu selections

The OSD menu contains six main menus:

Icon	Menu	Function description
	<b>Picture</b>	Set or change video characteristics such as, brightness, contrast, and resolution.
	<b>Audio</b>	Set or change the audio options.
	<b>Option 1</b>	Set or change display options such as video source, aspect ratio, and network settings.
	<b>Option 2</b>	Set or change display options such as OSD language, schedule, and ISM method.

Icon	Menu	Function description
	<b>Color Calibration</b>	Launch the color calibration process.
	<b>Tile Mode</b>	Set or change the tiling options when this display is one of an array.

The following table lists the On-Screen Display (OSD) menu selections and their functional descriptions. Not all options apply to all types of input. For example, clock adjustment is only applicable to VGA input.

Level 1 Menu	Level 2 Menu	Level 3 Menu	Description
<b>Picture</b> 	<b>Picture Mode</b>		<p>The three preset modes set the picture submenu options for the following:</p> <ul style="list-style-type: none"> <li>• <b>Vivid</b> — For standard video.</li> <li>• <b>Standard</b> — For viewing images.</li> <li>• <b>Cinema</b> — For movies.</li> <li>• If you prefer to set the picture submenu options yourself, you will automatically switch to <b>Expert 1</b></li> </ul> <p>The default setting is Standard.</p>
	<b>Contrast</b>		<p>Increase or decrease the difference between the light and dark colors.</p> <p>Adjustable scale, 0 – 100 with 100 being high contrast.</p> <p>The default setting is 50.</p>
	<b>Brightness</b>		<p>0 — 100 scales adjusts the brightness of the screen.</p> <p>The default setting is 50.</p>
	<b>Sharpness</b>		<p>0 — 10 scale makes the image crisper or softer. When you change this setting, the change will show immediately so that you can judge where you want it to be.</p> <p>The default setting is 5.</p>
	<b>Backlight</b>		<p>Controls the brightness of the backlight, 0 – 100.</p> <p>The default setting is 90.</p>
	<b>Dynamic Contrast</b>		<p><b>On</b> — Allows the display to adjust the backlight for better contrast, depending on the image.</p> <p><b>Off</b> — Does not allow the display to change the backlight level depending on the image.</p> <p>The default setting is OFF.</p>

Level 1 Menu	Level 2 Menu	Level 3 Menu	Description
	<b>Resolution</b>		<p><b>Auto</b> — allows the display to choose any supported resolution that matches the input signal.</p> <p><b>1280 x 768</b> pixels</p> <p><b>1360 x 768</b> pixels</p> <p><b>1366 x 768</b> pixels</p> <p>The default setting is Auto.</p>
	<b>Color Temperature</b>		<p>Adjust the shade of white the display produces.</p> <p><b>9300 K</b> — Slightly purplish white.</p> <p><b>8000 K</b> — Slightly bluish white</p> <p><b>6500 K</b> — Standard paper-white.</p> <p><b>User</b> - Set the R, G, B gain values yourself</p> <p>The default setting is 9300.</p>
	<b>Energy Saving</b>		<p>Select from the following backlight brightness levels:</p> <ul style="list-style-type: none"> <li>• <b>Off</b> — 100% light</li> <li>• <b>Level 1</b> — 80% light</li> <li>• <b>Level 2</b> — 60% light</li> <li>• <b>Level 3</b> — 40% light</li> </ul> <p>The default setting is Off.</p>
	<b>Local Dimming</b>		<p><b>On</b> — Allows the display to dynamically change brightness in selected areas of the screen to enhance detail in both dark and bright parts of the image at once.</p> <p><b>Off</b> — No local dimming.</p> <p>The default setting is Off.</p>
<b>Audio</b>	<b>Volume</b>		<p>Adjust the volume from 0 to 100.</p> <p>The default setting is 50.</p>
			
	<b>Speaker</b>		<p><b>On</b> — Play sound through the attached speakers.</p> <p><b>Off</b> — Turn off attached speakers in order to use an external sound system.</p> <p>The default setting is On.</p>
	<b>Audio Source</b>		<p><b>Line-in</b> — With analog video, choose this option to play sound from the audio input at the back of the display.</p> <p><b>DisplayPort</b> — With digital video, choose this option to play the sound accompanying the video.</p> <p><b>VOE</b> — With VOE for video, choose VOE for sound as well.</p> <p>The default setting is VOE.</p>
	<b>Balance</b>		<p>Balances sound between the left and right speakers.</p> <p>The default setting is 50; range is 0 – 100, with 0 being all sound from the left speaker.</p>

Level 1 Menu	Level 2 Menu	Level 3 Menu	Description
	<b>Treble</b>		Adjust treble 0 – 100. The default setting is 50.
	<b>Bass</b>		Adjust bass 0–100. The default setting is 50.
	<b>Sound Mode</b>		<b>Standard</b> — Most natural audio. <b>Voice</b> — Differentiates the human sound range from other sounds, which helps to make the human voices easier to hear. The default setting is Standard.
<b>Option 1</b>	<b>Aspect Ratio</b>		Select from the following image proportions: <ul style="list-style-type: none"> <li>• <b>16:9</b> — Widescreen mode.</li> <li>• <b>1:1</b> — Picture format is 1:1 aspect ratio.</li> <li>• <b>Original</b> — Picture format is automatically set to 16:9 or 4:3 aspect ratio according to input signal.</li> <li>• <b>4:3</b> — Picture format is 4:3 aspect ratio.</li> <li>• <b>14:9</b> — Programs are viewed normally in 14:9 with black bars added to the top and bottom. If the input is 4:3, it will be stretched horizontally.</li> <li>• <b>Zoom</b> — 4:3 programs are magnified until they fill the 16:9 screen. The top and bottom will be cut off.</li> <li>• <b>Cinema Zoom</b> — Picture format is 2.35:1 aspect ratio, extending the picture horizontally with black bars added to the top and bottom.</li> </ul> The default setting is 16:9.
			
	<b>Source</b>		Select video source: <b>VGA</b> — Analog video through the VGA port. <b>DisplayPort</b> — Digital video through the DisplayPort <b>VOE</b> — Digital video through the Ethernet port The default setting is VOE.
	<b>Auto Configuration</b>		Automatically adjusts picture position and minimizes image instability (VGA input only)
	<b>Clock Frequency</b>		Adjusts the controller's clock frequency from 0 to Dynamic. See <a href="#">Optimizing analog images on page 46</a> for details.
	<b>Phase</b>		Adjusts the controller's clock phase from 0 to Dynamic. See <a href="#">Optimizing analog images on page 46</a> for details.
	<b>H.Position</b>		Adjustable scale, 0 to 100, moves the image right or left on the screen.
	<b>V.Position</b>		Adjustable scale, 0 to 100, moves the image up or down on the screen.



Level 1 Menu	Level 2 Menu	Level 3 Menu	Description
	<b>Ambient Light Sensor</b>		<p><b>High</b> — Frequently adjust the backlight based on input from the sensor.</p> <p><b>Low</b> — Periodically adjust the backlight based on input from the sensor.</p> <p><b>Off</b> — Do not adjust the backlight based on input from the sensor.</p> <p>The default setting is Off.</p>
	<b>Interface Select</b>		<p>If the display will be controlled by software on a media player/ computer, select the type of cable connecting it to that media player/computer:</p> <p><b>RS232</b> — for RS-232 cable.</p> <p><b>Network</b> — for Ethernet cable.</p> <p>The default setting is Network.</p>
	<b>Auto Detection</b>		<p><b>On</b> — Allows the display to automatically detect a signal on any input source and show the image.</p> <p><b>Off</b> — Video source must be selected manually.</p> <p>The default setting is On.</p>
	<b>NSM Network</b>		<p>If the display is controlled by software on a networked media player/computer, it needs settings that tell the media player/ computer where to send command data:</p>
		<b>DHCP</b>	<p>Dynamic Host Configuration Protocol</p> <p><b>Enable</b> — Allows the network host computer to assign an IP Address to the display when it comes on line.</p> <p><b>Disable</b> — Allows you to assign a permanent IP Address and Subnet Mask.</p> <p>The default setting is Enable.</p>
		<b>IP Address</b>	<p>The Internet Protocol address needed for a network connection.</p> <p>The default is 192.168.0.1</p>
		<b>Subnet Mask</b>	<p>A number specific to your network used in conjunction with the IP address.</p> <p>The default is 255.255.255.0</p>
		<b>WOL</b>	<p>Wake-up On Low power</p> <p><b>Enable</b> - Management software can change the display from low power ("sleep") to full power.</p> <p><b>Disable</b> - Management software cannot change the display from low power to full power.</p> <p>The default setting is Disable</p>
	<b>VOE Network</b>		<p>If the display receives video data from a networked media player/computer, it needs settings that tell the media player/ computer where to send video data:</p>

Level 1 Menu	Level 2 Menu	Level 3 Menu	Description
		<b>DHCP</b>	<p>Dynamic Host Configuration Protocol</p> <p><b>Enable</b> — Allows the network host computer to assign an IP Address to the display when it comes on line.</p> <p><b>Disable</b> — Allows you to assign a permanent IP Address and Subnet Mask.</p> <p>The default setting is Enable.</p>
		<b>IP Address</b>	<p>The Internet Protocol address needed for a network connection.</p> <p>The default is 192.168.0.2</p>
		<b>Subnet Mask</b>	<p>A number specific to your network used in conjunction with the IP address.</p> <p>The default is 255.255.255.0</p>
	<b>VOE Setup</b>		<p>These fields are recognized by the Video Over Ethernet software.</p> <p><b>Display Name</b> — Give this display a name up to 32 alphanumeric characters long for reference through the VOE software.</p> <p><b>Display Location</b> — Identify this display's physical location in a way meaningful to you. Use up to 32 alphanumeric characters.</p> <p><b>Product Name</b> — Automatically shows either LD4730 or LD4730G.</p> <p><b>Player Name</b> — The computer name of a computer/media player running VOE software whose output is to be played on this display. You can enter such a name. The VOE software will enter a name when it assigns a video source to this display.</p>
<b>Option 2</b>	<b>Language</b>		<p>Selects the language in which the OSD menu is displayed.</p> <p>The default setting is English.</p>
			
	<b>OSD Mode</b>		<p>Set the OSD orientation to match the display's orientation, portrait or landscape.</p> <p>The default setting is landscape.</p>
	<b>TIME</b>	<b>Clock</b>	<p>Set the current date and time so that scheduled events happen at the correct time.</p> <p><b>Year:</b> 2000 – 2099</p> <p><b>Month:</b> 1 – 12</p> <p><b>Day:</b> 1 – 31</p> <p><b>Hour:</b> 0 – 23</p> <p><b>Minute:</b> 0 – 59</p> <p><b>Daylight saving time:</b> ON/OFF</p> <p>The default setting is Off.</p>



Level 1 Menu	Level 2 Menu	Level 3 Menu	Description
		<b>Schedule</b>	<p>You can schedule up to 7 On/Off times for the display to enter low power mode (screen is dark) or come out of low power to full power:</p> <p><b>On</b> — Set a time for the display to turn on full power.</p> <p><b>Off</b> — Set a time for display to “sleep.”</p> <p><b>Input</b> — Choose the input source to play at the ON time.</p> <hr/> <p>Select the frequency for this event:</p> <p><b>Every Day</b> — Play this event every day at the scheduled time.</p> <p><b>Monday – Sunday</b> choices: Play this event on the selected days.</p> <p><b>Every Week</b> — If checked, the event will play on the selected days every week. If not checked, the event will play on the selected days for one week only.</p>
		<b>Power On Delay</b>	<p><b>Yes</b> — To stagger the power-up of multiple displays on an electrical circuit, turn this option on. Each display will choose a delay either randomly or based on its tiling number.</p> <p><b>No</b> — No delay on power up.</p> <p>The default setting is No.</p>
	<b>DPM Select</b>		<p>Display Power Management Select</p> <p><b>On</b> — The display will enter low power mode when there is no signal on the VGA and DP inputs.</p> <p><b>Off</b> — Prevents the display from entering low-power mode.</p> <p><b>VGA Only</b> — Equivalent to On when Auto Detect is on. When Auto Detect is off, will enter low power mode when VGA is the selected video source and there is no signal on the VGA input, but will not enter low power mode when another source is selected.</p> <p>The default setting is VGA Only.</p>
	<b>Key Lock</b>		<p><b>On</b> – Disable the buttons at the back of the display.</p> <p><b>Off</b> — Enable the buttons at the back of the display.</p> <p>The default setting is Off.</p>
	<b>Set Monitor ID</b>		<p>Assign a unique, two-digit number between 01 and 25 to this display. You will see this number if you have daisy chained the IR ports of several displays. HP Network Sign Manager also uses it to communicate directly with the display.</p> <p>The default setting is 01.</p>

Level 1 Menu	Level 2 Menu	Level 3 Menu	Description
	<b>ISM Method</b>		<p>To prevent the screen from retaining an image that remains static for a long period of time, choose one of these relief methods:</p> <ul style="list-style-type: none"> <li>• <b>Orbiter</b>— The image moves two pixels every two minutes. Direction of movement is right, left, up, and then down, in a continuous cycle.</li> <li>• <b>Inversion</b> — Inverts the colors every 30 minutes. This function can be used to fix a ghost or burned-in image.</li> <li>• <b>White wash</b> — Fills the screen with white. This function can be used to fix a ghost or burned-in image. Press any key on the remote control to exit the White Wash function and return the screen to normal.</li> <li>• <b>Dot wash</b> — Imposes black dots on the image, moving them every 5 seconds.</li> <li>• <b>OFF</b> — No remedy for image retention will be used.</li> </ul> <p>The default setting is Off.</p>
	<b>DDC/CI</b>		<p><b>On</b> — Allows an attached media player/computer to send control commands to the display.</p> <p><b>Off</b> — Control of the display must be done manually, with the infrared remote control or the buttons on the back of the display.</p> <p>The default setting is On.</p>
	<b>Factory Reset</b>		<p>Resets all OSD choices to their default factory settings.</p> <p>User modes will be erased from memory.</p>
	<b>Diagnostic</b>		<p>Shows the following information:</p> <p>Temperature in degrees Centigrade</p> <p>Ambient light level in Lux</p> <p>LED Failure: Yes/No</p> <p>Operating time in hours</p>
	<b>Information</b>		<p>Shows the following:</p> <p><b>Serial number</b></p> <p><b>SW Version (MNT)</b> — The version of the firmware driver running on the display.</p> <p><b>IP Address (VOE)</b> — The IP Address of the network connection handling video data to the display.</p> <p><b>MAC Address (VOE)</b> — The Media Access Control address of the network connection handling video data to the display.</p> <p><b>IP Address (NSM)</b> — The IP Address of the network connection handling control data to the display.</p> <p><b>MAC Address (NSM)</b> — The Media Access Control address of the network connection handling control data to the display.</p>

Level 1 Menu	Level 2 Menu	Level 3 Menu	Description
	IR out		<p><b>Enable</b> — Enable the external IR receiver and IR daisy-chain support.</p> <p><b>Disable</b> — Disable the external IR receiver and IR daisy-chain support.</p> <p>The default setting is Disable.</p>
	Firmware Update		<p><b>Current Ver.</b> — Shows the version number of firmware currently running on the display.</p> <p><b>Detected Ver.</b> — Shows the version number of firmware detected on a USB device plugged into the display.</p> <p><b>Yes/No</b> — Choose yes to upgrade firmware on this display.</p>
Color Calibration	Color Calibration		<p>Enter — Enter the color calibration process.</p> <p>Exit — Exit without calibrating color.</p> <p>See <a href="#">Tuning color on page 47</a> for details of the color calibration process.</p>
			
	Result		<p>When calibration is complete, the display measures the following parameters with the new correction:</p> <p>Luminance</p> <p>Color Temperature</p> <p>Gamma</p> <p>R, G, and B coordinates in CIE X,Y color space</p> <p>The number of hours since calibration is also shown. If the display has never been calibrated, that fact is shown.</p>
Tile Mode	H Monitors		<p>Enter the number of displays in a row of your array.</p> <p>The range is 1 — 5 and the default is 1.</p>
			
	V Monitors		<p>Enter the number of displays in a column of your array.</p> <p>The range is 1 — 5 and the default is 1.</p>
	H Position		<p>Enter this display's column number, counting left to right.</p> <p>The range is 1 — 5 and the default is 1.</p>
	V Position		<p>Enter this display's row number, counting top to bottom.</p> <p>The range is 1 — 5 and the default is 1.</p>
	Natural Mode		<p><b>On</b> — Image will overlap the bezel. The result is as though the composite image was projected onto the video wall.</p> <p><b>Off</b> — Image will be contained in the viewing area. The result is as though the composite picture was cut into separate pieces laid close to each other.</p> <p>See <a href="#">Using Tile Mode on page 44</a> for more detail.</p> <p>The default setting is Off.</p>
	Reset		<p>Returns all tile settings to their defaults.</p>

## Power On Delay

Power on delay lets you stagger the initial current draw of multiple displays on one electrical circuit. Each display will compute its own delay time. If its V Monitors setting in the Tiling submenu is 1, the delay will be a random number between 0.5 and 2.5 seconds. If V Monitors is anything else, its delay will be  $(0.5 * V \text{ Position})$  seconds.

## Using Key Lock

The buttons on the back of the panel can be disabled to prevent accidental changing of the settings. To do this, press the left and right arrows buttons simultaneously and hold for 5 seconds. The same procedure will enable the buttons again. If the buttons are not accessible, use the infrared remote control to enter the OSD menu, navigate to the Option 2 submenu, and turn the Key Lock option off or on.

## Setting the backlight level

The OSD offers two settings which change the backlight level. The Backlight setting is a scale from 0 to 100. The Energy Saving setting is a choice of four levels, given as percents. Energy Saving imposes a ceiling on the Backlight level. For example, if Energy Saving is set to Level 2 (60%), the Backlight scale is effectively reduced to 0 to 60, since any setting above 60 will function as 60.

## Preventing and fixing ghost images

Displaying a static image on the screen for a long time can result in “burn-in” or image retention. To avoid image retention, do not display a fixed image for long periods of time. Either turn the display off, use one of the image retention choices (ISM) in the OSD, or change the image. You can help to avoid or correct ghost images by using one of the ISM Method options:

1. Navigate to the Option 2 submenu and then to the ISM Method option.
2. Select one of the following menu options:
  - **Orbiter** — The image will move two pixels every two minutes, alternately moving left, right, up, and down. Orbiter will remain on until changed in the ISM Method menu.
  - **Inversion** — This function can be used to fix a ghost or burned-in image. It will invert the image colors every 30 minutes. The inversion function will remain on until changed in the ISM Method menu.
  - **White wash** — This function can also be used to fix a ghost or burned-in image. This function will fill the screen with solid white. This helps to remove permanent images burned into the screen. Pressing any key on the remote control will exit the **White Wash** function and return the screen to **Normal**.
  - **Dot wash** — Imposes a pattern of black dots on the image and moves them every 5 seconds.
  - **OFF** — Choose if you do not want the ISM function to be active. When the display is turned off, the ISM setting is lost and will be **OFF** when the display is next turned on.

## Using Tile Mode

**Tile Mode** lets you define an array of up to 25 displays showing a single image. The array need not have the same number of columns as rows, and the displays can be in landscape or portrait orientation. Tile mode is designed for use with daisy chained displays receiving VGA or DisplayPort input. If the input source is Video Over Ethernet, each display must be sent the same image for tile mode to work. (See the *Video Over Ethernet User Guide* for details).

Video signal strength will determine how many displays may be daisy chained together. Degradation of the video signal due to distance may limit the maximum number of displays to less than 25.

You can set up tiling through the OSD menu of each display in the array. That method is described here. You can also use HP Network Sign Manager for the same purpose. See the *HP Network Sign Manager User Guide* for details.

On each display, enter the OSD and navigate to the **Tile** submenu. Set **H Monitors** to the number of columns in the array and **V Monitors** to the number of rows. Set **H Position** to the column number for this display, counting from left to right. Set **V Position** to the row number, counting from top to bottom.

**Figure 4-6** Tile Mode numbering scheme

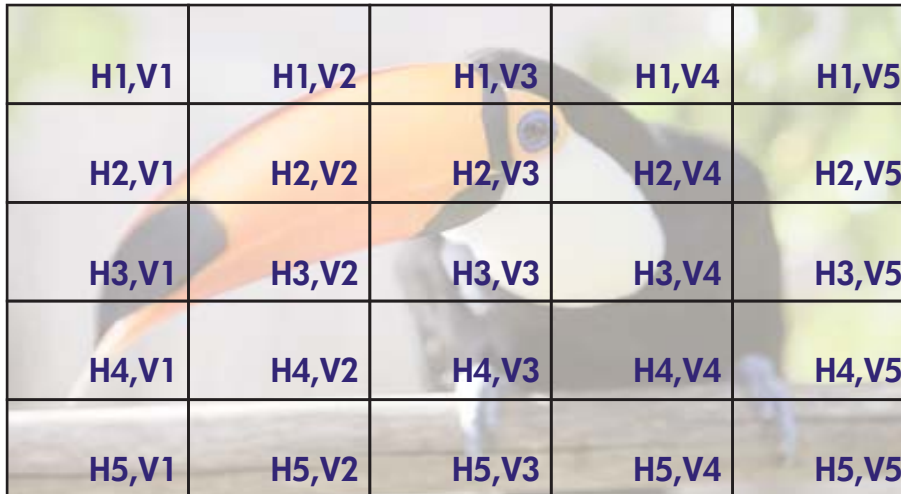

H1,V1	H1,V2	H1,V3	H1,V4	H1,V5
H2,V1	H2,V2	H2,V3	H2,V4	H2,V5
H3,V1	H3,V2	H3,V3	H3,V4	H3,V5
H4,V1	H4,V2	H4,V3	H4,V4	H4,V5
H5,V1	H5,V2	H5,V3	H5,V4	H5,V5

Each display in the tile mode array will receive the full image, but will display only its assigned part of the image based on its H Position and V Position.

Natural Mode allows the image to retain proportionality across the array by compensating for the width of the mullion (the distance between the active display area to the active display area of the adjacent display in the array). Set Natural Mode on or off, using the same setting for every display in the array.

If Natural Mode is off, the display shows the its entire portion of its assigned position within the active viewing area. If Natural Mode is on, each display will compensate for the mullion between the displays by eliminating that portion of its assigned image which would overlap the bezel. This results in a small part of the composite picture being invisible, as though blocked by the mullions between window panes.

Choose Natural Mode on if you want the composite to be correctly proportioned and off if you want every pixel visible. The difference can be seen in the following:

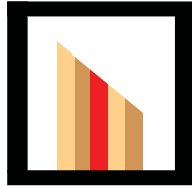

Original image



Tiled with Natural Mode on, the red bar is hidden and the slope is displayed correctly.

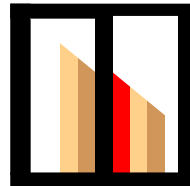

Tiled with Natural Mode off, all bars are visible and the slope is disjointed.

---

## Optimizing analog images

When using VGA as your video source, you can optimize the screen performance by using the Auto Configuration option in the OSD and the Auto-adjustment Pattern Utility software on the CD provided. (When the video source is one of the digital formats, the display adjusts itself and there is no user intervention.)

The procedure can correct the following image quality conditions:

- Fuzzy or unclear focus
- Ghosting, streaking or shadowing effects
- Faint vertical bars
- Thin, horizontal scrolling lines

Although the process will work with any image, it works best with the image in the Auto-adjustment Pattern Utility supplied on the CD that comes with the display.

To use the auto-adjustment feature:

1. Allow the display to warm up for 20 minutes before adjusting.
2. Insert the CD in the disc drive. The CD menu appears.
3. Select **Open auto-adjustment software**. The setup test pattern appears.
4. You can launch the display's auto configuration process in two ways: by pressing the down arrow on the back of the display while the OSD menu is **inactive**, or by selecting the **Auto Configuration** choice in the **Option 1** menu of the OSD. Either way, the display will adjust itself.

If the result is not satisfactory, continue with the procedure.

5. Navigate to **Clock Frequency** under the **Option 1** submenu of the OSD. Increase or decrease the value to minimize any vertical bars or stripes visible on the screen background.

**Figure 4-7** Adjust frequency



6. Navigate to **Phase**. Increase or decrease the value to minimize video flickering or blurring.

**Figure 4-8** Adjust phase

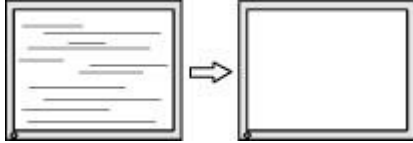

---

 **NOTE:** The frequency must be adjusted before the phase, since the phase setting is dependent on the frequency setting.

---

7. If the monitor images become distorted, continue adjusting the values until the distortion disappears. To restore the factory settings, select Yes from the Factory Reset menu in the on-screen display (this will reset all other OSD choices as well). When you are satisfied, exit the OSD menu.
8. Press the **ESC** key or any other key on the keyboard to exit the test pattern.

## Tuning color

The HP DreamColor Display Calibration Solution (purchased separately) can be used to calibrate the displays in a video wall to ensure that their output closely matches each other. This prevents visible differences in the composite image due to variations in color temperature, luminance, or gamut (the range of colors) among the displays. It can also be useful to calibrate displays that are not in a video wall but which should match each other, as when they are in the same room.

The HP LD4730 and LD4730G displays contain an internal color management engine and calibration processing hardware, allowing calibration without the use of an external computer; the colorimeter contained in the HP DreamColor Display Calibration Solution is all that is required.

Calibration is performed on each display in a video wall and can be done before or after the wall is assembled. It may be easier to calibrate the displays prior to wall assembly because the colorimeter must be connected to the USB port on the back of the display. Since you might want to recalibrate a video wall after it has been installed, HP recommends using scissor mounts or some other type that allows you to move each display out from the wall and access the USB port. For a permanent wall installation, a rack-mount USB extender facilitates access to the USB ports.

In preparing to calibrate a display or video wall, observe the following guidelines:

- Decide how bright you want the screen to be. During calibration, you will choose a target luminance. This value incorporates both the brightness of the backlight and of the LCD at full white. As with the brightness control of a conventional monitor, the most pleasing setting depends on the environmental lighting.

The maximum luminance depends on the color temperature, because temperature is adjusted by decreasing light of certain colors. If you choose 9300K as your target color temperature for calibration, you will be offered a luminance range from 200-500 cd/m<sup>2</sup>. If you set color temperature to 8000K, the offered range will be 200-450 cd/m<sup>2</sup>, and for color temperature 6500K it will be 200-400 cd/m<sup>2</sup>.

Total light output diminishes as a display ages. After one year of continuous use all day every day, the total light output an LD4730 or LD4730G is expected to have dropped by approximately 10%. With these considerations in mind, you will be able to choose a target luminance from the range offered.

- Warm up the display for at least one hour. This is required because the colorimetry of the image is not stable until the display has reached uniform operating temperature. Even when the effect of warm-up is not apparent, it can impact the calibration results.
- Ensure that there is no bright light shining directly onto the screen. Light reflecting off the display onto the measuring sensor of the colorimeter will result in an incorrect calibration. If necessary, cover the display surface and colorimeter with a light-blocking cloth.
- Clean the screen. Refer to [Cleaning the LD4730 on page 5](#) for specific instructions.
- Set Energy Saving, Picture mode, Contrast, Brightness, Sharpness, Backlight, and Ambient Light Sensor to their default values. Decide on the desired settings for Dynamic Contrast, Color Temperature and Local Dimming. Set these to the same value on every display in the video wall.
- When calibrating a video wall, use the same colorimeter for all displays in the wall. Otherwise, variation between colorimeters can jeopardize uniformity of the results.

To calibrate the display, follow these steps:

1. Plug the colorimeter into the USB port.

**Figure 4-9** Plugging in the colorimeter

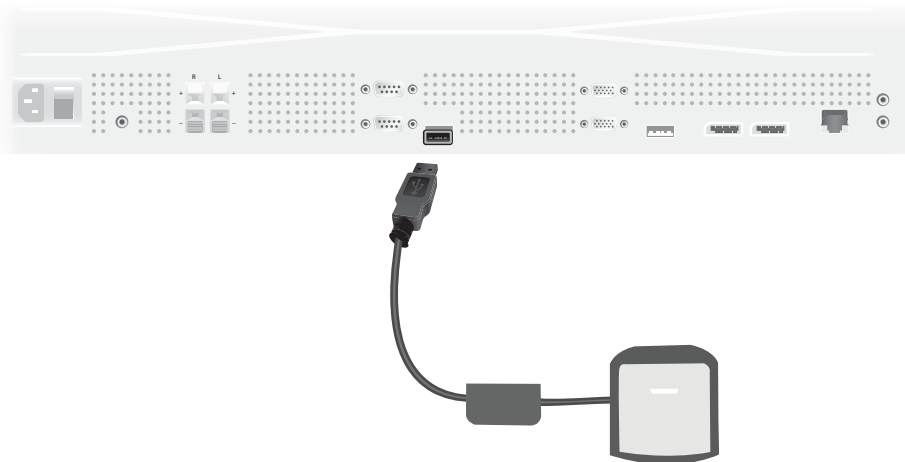

2. Navigate to the Color Calibration menu of the OSD. Use the **Color Calibration** option to **Enter** the calibration process.



3. The time since power-up will be shown. If the display has not yet warmed up for one hour, either wait for the display to complete the warm up or exit calibration menu and return later. If at least one hour has passed since the display was last powered on, proceed to the next step.
4. Choose the desired color temperature from the color temperature options provided. This setting must be the same for all displays in a video wall.

The native color temperature of the display is 9300° Kelvin (“9300K”). You can choose between 6500K, 8000K and 9300K. A lower color temperature results in a warmer picture, which may be more pleasing, depending on the environmental lighting in the area of the video wall. However, in order to lower the color temperature, blue light output must be restricted, which will reduce the maximum possible brightness.

After choosing a color temperature, click on Enter.

5. Choose the target luminance. The slider moves in increments of 10 cd/m<sup>2</sup>. Once you have set the luminance, click on Enter to move to the next option.

---

 **NOTE:** If the display cannot be calibrated to the target luminance, an error message will appear indicating the luminance that could be achieved. Use that or a lower value as the target for the video wall, to ensure equal light output across the wall.

---

6. Open the colorimeter by rotating the ambient light filter away from the lens. Do this by pulling up on the filter arm and then swinging it out of the way.

**Figure 4-10** Rotating the filter

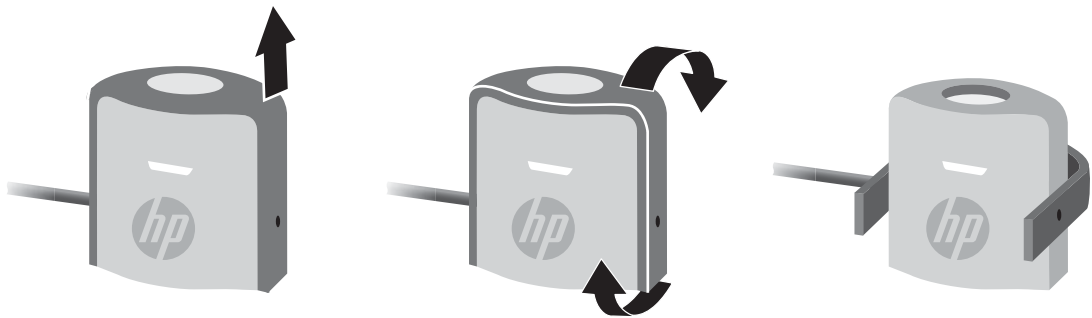

7. Hang the colorimeter over the top of the display and position it in the center of the target displayed on-screen. To do this, drape the USB cable over the top of the display so that the counterweight is in back and the colorimeter in front.

**Figure 4-11** Positioning the colorimeter



- Adjust the position of the counterweight so that the colorimeter is properly positioned and maintains its position when released. To adjust the position of the counterweight on the USB cable, squeeze the release button and slide the weight.

**Figure 4-12** Adjusting the counterweight

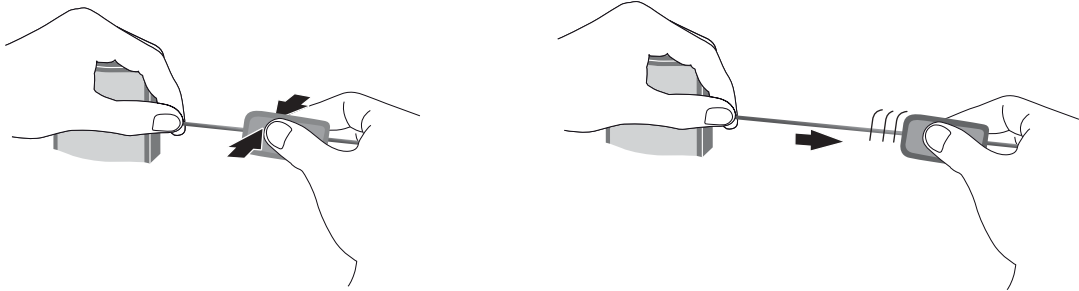

Alternatively, you can mount the colorimeter on a tripod and position it in front of the displayed target. If you use a tripod, position the colorimeter as close as possible to the screen and ensure that it is positioned perpendicular to the surface of the display.

- Click on Enter to begin the calibration process. The display will now begin calibrating itself. If the colorimeter is not connected to the USB port of the display, a “Device Connection Error” will appear. Connect the device and **Retry**.

If the colorimeter is not correctly aligned, a “Diffuser Position Error” will appear. Position the colorimeter perpendicular to the screen, with the lens (which was covered by the ambient light filter) against the screen, in the target being displayed. Then **Retry**.

Otherwise, you will see a message that the display is calibrating.

- If you are calibrating a video wall, repeat these steps for each display.

To achieve the color temperature and luminance you specify, the display and colorimeter interact to display and measure a series of colors. Needed corrections are written into a look-up table which the display uses in daily operation.

To gauge the success of this process, the devices set brightness and contrast to 50, adjust the backlight to produce the target luminance, and measure the following parameters:

- Luminance
- Color Temperature
- Gamma
- R, G, and B Primaries in CIE X,Y color space.

If any of their targets for these can not be achieved, a “Color Calibration Fail” message will appear listing those parameters from the list that could not be adjusted properly.

When the process is finished, you can view the results with the **Result** option in the Color Calibration submenu. In addition to the parameters listed, you will also see the number of hours since calibration.

Following calibration, changes to settings that affect brightness or color may prompt a warning that lets you know the displays may no longer be showing the target luminance and color temperature. To preserve uniformity, make any such changes to all displays in the video wall. Also, leave the ambient light sensor off.

Once a wall has been calibrated, the calibration should be valid for 9000 hours, which is equivalent to one year of continuous use (no off time). If an individual display is replaced during that time, it may only be necessary to calibrate the replacement display(s).

# A Troubleshooting

## Solving common problems

The following table lists possible problems, the possible cause of each problem, and the recommended solutions.

Problem	Possible cause	Solution
No image is displayed.	Power cord is not connected.	Be sure the power cord is properly connected to the outlet. <ul style="list-style-type: none"><li>• Verify that the outlet has power to it.</li><li>• Check that the fuse or breaker has not tripped or burned out.</li></ul> See if the power switch is turned on. Might need service.
Power is on, power indicator is green, but the screen appears extremely dark.	Screen needs adjustment.	Adjust brightness, backlight and contrast again. Backlight might need repair.
Power indicator is red.	Display is in power saving mode. No video signal is active.	Press power button (⏻) on the back of the display. Activate a signal source. Turn off equipment and then back on. Select an active input or set <b>Auto Detection</b> in the OSD menu to on.
<b>Out of Range</b> message appears.	Input signal is out of frequency range.	The signal from the media player/computer (video card) is out of the vertical or horizontal frequency range of the display. Adjust the frequency range. <b>NOTE: Vertical Frequency</b> — To enable the user to watch the display, the screen image should change multiple times every second like a fluorescent lamp. The vertical frequency or refresh rate is the number of times the image displays per second. The unit is measured in Hz. <b>Horizontal Frequency</b> — The horizontal interval is the time to display one vertical line. When 1 is divided by the horizontal interval, the number of horizontal lines displayed every second can be tabulated as the horizontal frequency. The unit is measured in kHz.
<b>Check video cable</b> message appears.	Signal cable is not connected.	The signal cable between the media player/computer and display is not connected. Make sure that the signal cable is properly connected.
<b>OSD Lockout</b> message appears when pressing the Menu button.	Key Lock function is turned on.	To unlock the menu, press the up and down arrows on the back of the display simultaneously and hold for 5 seconds.
The screen looks abnormal; screen position is wrong.	Screen is out of adjustment.	Adjust the position using the OSD menu options <b>H Position</b> and <b>V Position</b> in the <b>Option 1</b> menu. Check that the video card resolution and frequency are supported by the display. If the frequency is out of range, set to the recommended resolution in the <b>Control Panel</b> → <b>Display</b> → <b>Settings</b> of the operating system.

<b>Problem</b>	<b>Possible cause</b>	<b>Solution</b>
Lines appear on the background screen.	Screen is out of adjustment.	Adjust using the procedure described in <a href="#">Optimizing analog images on page 46</a> .
Horizontal noise appears or the characters look blurred.	Screen is out of adjustment.	Adjust using the procedure described in <a href="#">Optimizing analog images on page 46</a> .
The screen displays abnormally.	Using an incorrect input signal.	The proper input signal is not connected to the signal port. Connect the signal cable that matches with the source input signal.
An after image appears when the display is turned off.	Using a fixed image for too long a period of time.	If you used a fixed image for a long time, the pixels might be damaged. Use a screen-saver or one of the functions in the <b>ISM Method</b> option of the OSD menu.
No sound.	Audio cable not connected.	Check that the audio cable is properly connected. Adjust the volume. Check the Speaker and Audio Source settings in the OSD.
Sound is too dull.	Equalizer is not balanced.	Check the audio settings for Balance, Treble, Bass, and Sound Mode.
Sound is too low.	Sound needs adjusting.	Adjust the volume.
Screen has poor color resolution (16 colors).	Color is not set correctly.	Set the number of colors to more than 24 bit (true color). Select <b>Control Panel</b> → ( <b>Personalization</b> → <b>Display</b> → <b>Settings</b> → <b>Color quality</b> in the operating system.
Screen color is unstable or mono colored.	Signal cable or video card connection is loose.	Check the connection status of the signal cable, or reinsert the media player/computer video card.
Black spots appear on the screen.	Black spots are characteristics of the LCD panel.	Refer to <a href="#">Display quality and pixel policy on page 59</a> for more details.
The power is suddenly turned off.	Sleep timer setting is turned on, or power is interrupted.	Check the <b>Schedule</b> submenu of the OSD. Check the power control settings.
<b>Power Button Lockout</b> message appears.	The sleep button on the back of the display is disabled.	Press the MENU and right arrow buttons on the back of the display and hold for 5 seconds.

## Using Online Technical Support

For online access to technical support information, self-solve tools, online assistance, community forums of IT experts, broad multi-vendor knowledge base, monitoring and diagnostic tools, go to [www.hp.com/support](http://www.hp.com/support)

## Preparing to call technical support

If you cannot solve a problem using the troubleshooting tips in this section, you might need to call technical support. Contact your regional HP authorized service provider. Have the following information available when you call:

- Display model number
- Serial number for the display
- Purchase date on invoice
- Conditions under which the problem occurred
- Error messages received
- Hardware configuration
- Hardware and software you are using

# B Technical specifications

 **NOTE:** All performance specifications are provided by the component manufacturers. Performance specifications represent the highest specification of all HP's component manufacturers' typical level specifications for performance; actual performance might vary either higher or lower.

## HP Digital Signage Display

**Table B-1 Specifications**

		HP LD4730	HP LD4730G
<b>Display</b>	<b>Size</b>	120.24 cm (47.3 in)	120.64 cm (47.5 in)
	<b>Type</b>	TFT LCD panel with LED backlight	TFT LCD panel with LED backlight
<b>Viewable image size</b>		119.3 cm (46.9 in)	119.7 cm (47.1 in)
<b>Pixel pitch</b>		0.76125 x 0.76125 mm (0.0299 x 0.0299 in)	0.76125 x 0.76125 mm (0.0299 x 0.0299 in)
<b>Weight — maximum</b>	<b>Without stand and speaker</b>	23.82 kg (52.52 lbs)	29.02 k (63.98 lbs)
	<b>With speaker</b>	24.58 kg (54.19 lbs)	29.78 kg (65.65 lbs)
	<b>With stand</b>	25.24 kg (55.64 lbs)	30.44 kg (67.11 lbs)
	<b>With stand and speaker</b>	26.02 kg (57.36 lbs)	31.22 kg (68.832 lbs)
<b>Dimensions (W x H x D)</b>	<b>Without stand and speaker</b>	104.68 x 59.16 x 9 cm (41.21 x 23.29 x 3.54 in)	105.09 x 59.57 x 9.4 cm (41.37 x 23.45 x 3.7 in)
	<b>With stand</b>	104.68 x 66.47 x 29.83 cm (41.21 x 26.16 x 11.7 in)	105.09 x 66.88 x 29.83 cm (41.37 x 26.33 x 11.7 in)
	<b>With Frame</b>	106.05 x 60.53 x 9.55 cm (41.75 x 23.83 x 3.75 in)	
<b>Bezel width</b>	Top and left sides in landscape orientation	3.9 mm	3.9 mm
	Bottom and right sides in landscape orientation	2.4	2.4
<b>Power</b>	<b>Rated voltage</b>	AC 100-240 V~50/60 Hz 2 A Japan: AC 100 V~50/60 Hz 2 A	AC 100-240 V~50/60 Hz 2 A Japan: AC 100 V~50/60 Hz 2 A
<b>Power consumption</b>	<b>On mode</b>	250 watts	250 watts
	<b>Sleep mode</b>	.5 watts	.5 watts
<b>Aspect ratio</b>		16:9	16:9
<b>Resolution — maximum</b>		1920 x 1080 @ 60 Hz	1920 x 1080 @ 60 Hz

**Table B-1 Specifications (continued)**

		<b>HP LD4730</b>	<b>HP LD4730G</b>
<b>Resolution — recommended</b>		1366 x 768 @ 60 Hz	1366 x 768 @ 60 Hz
<b>Horizontal frequency</b>		30 – 83 kHz	30 – 83 kHz
<b>Vertical frequency</b>		50 – 76 Hz	50 – 76 Hz
<b>Synchronization type</b>		For VGA input, separate H and V syncs are supported.	For VGA input, separate H and V syncs are supported.
<b>Video input connectors</b>		VGA, DisplayPort, Ethernet	VGA, DisplayPort, Ethernet
<b>Other input connector</b>		RS-232-C, USB, audio	RS-232-C, USB, audio
<b>Environmental conditions</b>	<b>Operating</b>	0° to 40°C Humidity 20% to 80% Altitude 0–5,000 m (0–16,400 feet)	0° to 40°C Humidity 20% to 80% Altitude 0–5,000 m (0–16,400 feet)
	<b>Storage</b>	–20° to 60°C Humidity 5% to 95% Altitude 0 – 12,192 m (0 – 40,000 feet)	–20° to 60°C Humidity 5% to 95% Altitude 0 – 12,192 m (0 – 40,000 feet)
<b>Contrast Ratio (Typical)</b>		1400:1	1400:1
<b>Maximum Pixel Clock</b>		160 MHz	160 MHz
<b>Packed Weight</b>		29.02 kg (63.98 lbs)	34.22 kg (75.44 lbs)
<b>Packed Dimensions (L x W x H)</b>		122.7 x 25.5 x 75.3 cm (48.3 x 10 x 29.7 in)	122.7 x 25.5 x 75.3 cm (48.3 x 10 x 29.7 in)
<b>Typical Viewing Angle (any direction)</b>		178 degrees	178 degrees
<b>Color Depth</b>		24 bit	24 bit
<b>Backlight</b>		Direct LED	Direct LED
<b>Backlight Lifetime (Typ)</b>		50,000 Hrs	50,000 Hrs
<b>Tiled-array mullion</b>		0.69 cm (0.27 in)	0.69 cm (0.27 in)
<b>Luminance (Typical)</b>		800 cd/m <sup>2</sup>	800 cd/m <sup>2</sup>
<b>Impedance</b>	<b>Audio amplifier AC input</b>	>=10 K Ohm	>=10 K Ohm



Locations of the VESA mounting holes are shown below. All units are mm.

**Figure B-1** VESA mounting holes

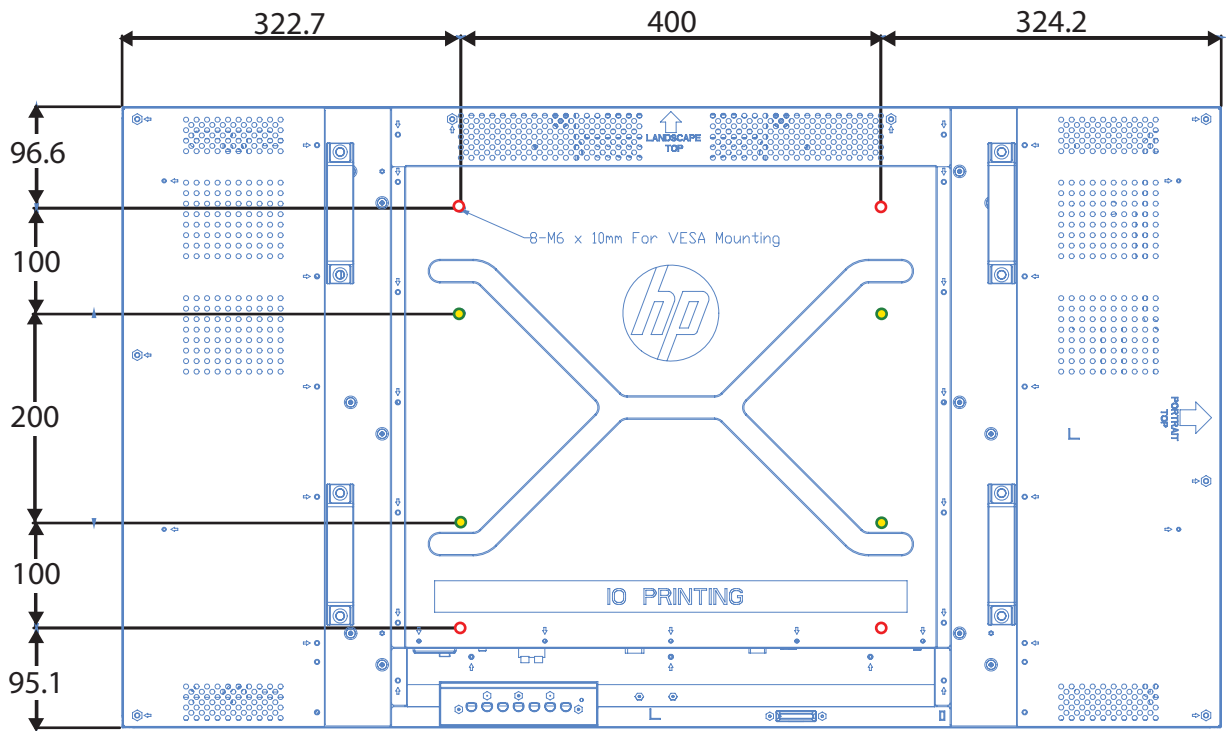

## Recognizing preset display resolutions

The display resolutions listed below are the most commonly used modes and are set as factory defaults. This display automatically recognizes these preset modes and they will appear properly sized and centered on the screen.

### Preset display modes

**Table B-2** Factory preset display modes

Preset	Pixel format	Horizontal frequency (kHz)	Vertical Frequency (Hz)
1	640 x 480	31.469	59.940
2	640 x 480	37.861	72.809
3	640 x 480	37.500	75.000
4	720 x 400	31.469	70.087
5	800 x 600	37.879	60.317
6	800 x 600	48.077	72.188
7	800 x 600	46.875	75.000
8	832 x 624	49.726	74.551

**Table B-2 Factory preset display modes (continued)**

Preset	Pixel format	Horizontal frequency (kHz)	Vertical Frequency (Hz)
9	720 x 480	31.469	59.940
10	1024 x 768	48.363	60.004
11	1024 x 768	56.476	70.069
12	1024 x 768	60.023	75.029
13	1152 x 720	44.86	60.00
14	1152 x 870	68.68	75.06
15	1152 x 900	71.71	76.05
16	1280 x 720	45.00	59.94
17	1280 x 768	47.396	59.995
18	1280 x 800	49.702	59.810
19	1280 x 960	60.00	60.00
20	1280 x 1024	63.981	60.020
21	1280 x 1024	79.976	75.025
22	1366 x 768	47.712	59.790
23	1440 x 900	55.935	59.887
24	1440 x 900	55.469	59.901
25	1600 x 900	55.935	59.887
26	1600 x 1000	61.648	60.00
27	1600 x 1200	75.000	60.000
28	1680 x 1050	65.290	59.954
29	1920 x 1080	67.5	60.00
30	1920 x 1200	74.038	59.950

In addition to these preset modes, the display will store up to 20 user modes. User modes are lost when the OSD **Factory Reset** option is used. In addition to frequency and resolution, a user mode includes the Horizontal Position, Vertical Position, Clock, Clock Phase, and Auto Adjustment settings.

## High definition video formats

Preset	Timing Name	Pixel Format	Horz Freq (kHz)	Vert Freq (Hz)	Pixel Rate (MHz)	OSD Display
1	480i	720x480	15.734	59.940	13.500	480i
2	480p	720x480	31.469	59.940	27.000	480p
3	720p60	1280x720	45.000	60.000	74.250	720p-60Hz
4	1080i60	1920x1080	33.750	60.000	74.250	1080i-60Hz

5	576i	720X576	15.625	50.000	13.500	576i
6	576p	720X576	31.250	50.000	27.000	576p
7	720p50	1280X720	37.500	50.000	74.250	720p-50Hz
8	1080i50	1920x1080	28.125	50.000	74.250	1080i-50Hz
9	1080p60	1920x1080	67.500	60.000	148.500	1080p-60Hz
10	1080p50	1920x1080	56.250	50.000	148.500	1080p-50Hz

## Display quality and pixel policy

Defect Type	Allowable Occurrences
Bright dot*	None
Dark dot**	Five maximum

\*A bright dot is a pixel that is always on. If two of its three colors (RGB) are always on, that is also a bright dot.

\*\*A dark dot is a pixel that is always off. If two of its three colors (RGB) are always off, that is also a dark dot.

## Power indicator

Mode	LED indicator light
Full power	Green
Low power	Red
Power off	Off

---

## C Agency regulatory notices

### Federal Communications Commission notice

This equipment has been tested and found to comply with the limits for a Class B digital device, pursuant to Part 15 of the FCC Rules. These limits are designed to provide reasonable protection against harmful interference in a residential installation. This equipment generates, uses, and can radiate radio frequency energy and, if not installed and used in accordance with the instructions, may cause harmful interference to radio communications. However, there is no guarantee that interference will not occur in a particular installation. If this equipment does cause harmful interference to radio or television reception, which can be determined by turning the equipment off and on, the user is encouraged to try to correct the interference by one or more of the following measures:

- Reorient or relocate the receiving antenna.
- Increase the separation between the equipment and the receiver.
- Connect the equipment into an outlet on a circuit different from that to which the receiver is connected.
- Consult the dealer or an experienced radio or television technician for help.

### Modifications

The FCC requires the user to be notified that any changes or modifications made to this device that are not expressly approved by Hewlett Packard Company may void the user's authority to operate the equipment.

### Cables

Connections to this device must be made with shielded cables with metallic RFI/EMI connector hoods to maintain compliance with FCC Rules and Regulations.

### Declaration of Conformity for products marked with the FCC logo (United States only)

This device complies with Part 15 of the FCC Rules. Operation is subject to the following two conditions:

1. This device may not cause harmful interference.
2. This device must accept any interference received, including interference that may cause undesired operation.

For questions regarding the product, contact:

Hewlett Packard Company

P. O. Box 692000, Mail Stop 530113

Houston, Texas 77269-2000

Or, call 1-800-HP-INVENT (1-800 474-6836)

For questions regarding this FCC declaration, contact:

Hewlett Packard Company

P. O. Box 692000, Mail Stop 510101

Houston, Texas 77269-2000

Or, call (281) 514-3333

To identify this product, refer to the Part, Series, or Model number found on the product.

## Canadian notice

This Class B digital apparatus meets all requirements of the Canadian Interference-Causing Equipment Regulations.

## Avis Canadien

Cet appareil numérique de la classe B respecte toutes les exigences du Règlement sur le matériel brouilleur du Canada.

## European Union regulatory notice

Products bearing the CE marking comply with the following EU Directives:

- Low Voltage Directive 2006/95/EC
- EMC Directive 2004/108/EC
- Ecodesign Directive 2009/125/EC, where applicable

CE compliance of this product is valid if powered with the correct CE-marked AC adapter provided by HP.

Compliance with these directives implies conformity to applicable harmonized European standards (European Norms) that are listed in the EU Declaration of Conformity issued by HP for this product or product family and available (in English only) either within the product documentation or at the following web site: [www.hp.eu/certificates](http://www.hp.eu/certificates) (type the product number in the search field).

The compliance is indicated by one of the following conformity markings placed on the product:

	For non-telecommunications products and for EU harmonized telecommunications products, such as Bluetooth® within power class below 10 mW.
	For EU non-harmonized telecommunications products (If applicable, a 4-digit notified body number is inserted between CE and !).

Please refer to the regulatory label provided on the product.

The point of contact for regulatory matters is: Hewlett-Packard GmbH, Dept./MS: HQ-TRE, Herrenberger Strasse 140, 71034 Boeblingen, GERMANY.

## German ergonomics notice

HP products which bear the “GS” approval mark, when forming part of a system comprising HP brand computers, keyboards and monitors that bear the “GS” approval mark, meet the applicable ergonomic requirements. The installation guides included with the products provide configuration information.

## Japanese notice

この装置は、クラスB情報技術装置です。この装置は、家庭環境で使用することを目的としていますが、この装置がラジオやテレビジョン受信機に近接して使用されると、受信障害を引き起こすことがあります。取扱説明書に従って正しい取り扱いをして下さい。

VCCI-B

## Korean notice

B급 기기

(가정용 방송통신기기)

이 기기는 가정용(B급)으로 전자파적합등록을 한 기기로서 주로 가정에서 사용하는 것을 목적으로 하며, 모든 지역에서 사용할 수 있습니다.

## Power cord set requirements

The display power supply is provided with Automatic Line Switching (ALS). This feature allows the display to operate on input voltages between 100–120 V or 200–240 V.

The power cord set (flexible cord or wall plug) received with the display meets the requirements for use in the country where you purchased the equipment.

If you need to obtain a power cord for a different country, you should purchase a power cord that is approved for use in that country.

The power cord must be rated for the product and for the voltage and current marked on the product's electrical ratings label. The voltage and current rating of the cord should be greater than the voltage and current rating marked on the product. In addition, the cross-sectional area of the wire must be a minimum of 0.75 mm<sup>2</sup> or 18 AWG, and the length of the cord must be between 6 feet (1.8 m) and 12 feet (3.6 m). If you have questions about the type of power cord to use, contact an authorized HP service provider.

A power cord should be routed so that it is not likely to be walked on or pinched by items placed upon it or against it. Particular attention should be paid to the plug, electrical outlet, and the point where the cord exits from the product.

## Japanese power cord requirements

For use in Japan, use only the power cord received with this product.

**⚠ CAUTION:** Do not use the power cord received with this product on any other products.

# Product environmental notices

## Disposal of waste equipment by users in private households in the European Union



This symbol on the product or on its packaging indicates that this product must not be disposed of with your household waste. Instead, it is your responsibility to dispose of your waste equipment by handing it over to a designated collection point for the recycling or waste electrical and electronic equipment. The separate collection and recycling of your waste equipment at the time of disposal will help to conserve natural resources and ensure that it is recycled in a manner that protects human health and the environment. For more information about where you can drop off your waste equipment for recycling, please contact the local city office, the household waste disposal service or the shop where you purchased the product.

## Chemical substances

HP is committed to providing our customers with information about the chemical substances in our products as needed to comply with legal requirements such as REACH (Regulation EC No 1907/2006 of the European Parliament and Council). A chemical information report for this product can be found at [www.hp.com/go/reach](http://www.hp.com/go/reach).

## HP recycling program

HP encourages customers to recycle used electronic hardware, HP original print cartridges, and rechargeable batteries. For more information about recycling programs, go to [www.hp.com/recycle](http://www.hp.com/recycle).

## Restriction of Hazardous Substances (RoHS)

A Japanese regulatory requirement, defined by specification JIS C 0950, 2005, mandates that manufacturers provide Material Content Declarations for certain categories of electronic products offered for sale after July 1, 2006. To view the JIS C 0950 material declaration for this product, visit [www.hp.com/go/jisc0950](http://www.hp.com/go/jisc0950).

2008年、日本における製品含有表示方法、JISC0950が公示されました。製造事業者は、2006年7月1日以降に販売される電気・電子機器の特定化学物質の含有につきまして情報提供を義務付けられました。製品の部材表示につきましては、[www.hp.com/go/jisc0950](http://www.hp.com/go/jisc0950)を参照してください。

## 产品中有毒有害物质或元素的名称及含量

根据中国《电子信息产品污染控制管理办法》

### LCD 显示器

部件名称	有毒有害物质或元素					
	铅 (Pb)	汞 (Hg)	镉 (Cd)	六价铬 (Cr(VI))	多溴联苯 (PBB)	多溴二苯醚 (PBDE)
液晶显示屏 - CCFL	X	X	○	○	○	○
液晶显示屏 - WLED	X	○	○	○	○	○
机箱 / 其他	X	○	○	○	○	○

○: 表示该有毒或有害物质在该部件所有均质材料中的含量均在 SJ/T11363-2006 标准规定的限量要求以下。

X: 表示该有毒或有害物质至少在该部件的某一均质材料中的含量超出 SJ/T11363-2006 标准规定的限量要求。

表中标有 "X" 的所有部件都符合欧盟 RoHS 法规，即“欧洲议会和欧洲理事会 2003 年 1 月 27 日关于在电子电气设备中限制使用某些有害物质的 2002/95/EC 号指令”。

注：环保使用期限的参考标识取决于产品正常工作的温度和湿度等条件。

## Turkey EEE regulation

In Conformity with the EEE Regulation

EEE Yönetmeliğine Uygundur

## Ukraine Restriction of Hazardous Substances

Обладнання відповідає вимогам Технічного регламенту щодо обмеження використання деяких небезпечних речовин в електричному та електронному обладнанні, затвердженого постановою Кабінету Міністрів України від 3 грудня 2008 № 1057.

The equipment complies with requirements of the Technical Regulation, approved by the Resolution of Cabinet of Ministry of Ukraine as of December 3, 2008, in terms of restrictions for the use of certain dangerous substances in electrical and electronic equipment.