

Getting Started

The information in this document is subject to change without notice.

Hewlett-Packard® Company makes no warranty of any kind with regard to this material, including, but not limited to, the implied warranties of merchantability and fitness for a particular purpose.

HP shall not be liable for errors contained herein or for incidental or consequential damages in connection with the furnishing, performance, or use of this material.

HP assumes no responsibility for the use or reliability of its software on equipment that is not furnished by HP.

This document contains proprietary information that is protected by copyright. All rights are reserved. No part of this document may be photocopied, reproduced, or translated to another language without the prior written consent of HP.

Hewlett-Packard Company
Home Products Division
P.O. Box 4010
Cupertino, CA 95015-4010

Printed in the USA.

© Copyright Hewlett-Packard Company, 1998. All rights reserved.

Hewlett-Packard is a registered trademark of Hewlett-Packard Company in the United States of America and other countries.

Intel Connect and Intel ProShare are registered trademarks of Intel Corporation.

Microsoft and Windows are registered trademarks of Microsoft Corporation in the United States of America and other countries.

Other brand or product names are trademarks of their respective holders.

Contents

Chapter 1 Preparing to Use Your

Computer1

Turning On Your Computer For the First Time2

Working in Comfort with Your HP Pavilion PC3

Preparing Your Work Environment.....6

Your Work Posture.....11

Setting Up Your HP Computing Equipment13

Chapter 2 Exploring Your System.....25

Turning On Your Computer.....26

Turning Off Your Computer.....26

Suspending Your Computer.....27

Using the Keyboard28

Using the Mouse.....30

Using Headphones.....31

Working with Diskettes32

Using the CD-ROM Drive.....34

Using the Modem.....36

Chapter 3 Discovering Your Software37

Learning about the Windows Desktop.....38

Finding Your Preinstalled Software.....41

Finding Files42

Adding Software43

Deleting Software43

Getting Help from the HP Support Center44

Getting Software Help45

| | |
|--|-----------|
| Chapter 4 Communicating with the World | 47 |
| Connecting to the Internet | 48 |
| Signing Up for Internet Access..... | 48 |
| Browsing the Internet | 49 |
| Sending and Receiving E-Mail | 50 |
| Using the HP Message Board..... | 51 |
| Terms and Conditions of the Free Internet Access | 53 |
| Removing the Channel Bar | 54 |
| Sending and Receiving Faxes | 55 |
| Glossary..... | 57 |

| | |
|---|-----------|
| Regulatory and Safety Information..... | 63 |
| FCC Regulatory and Safety Information..... | 63 |
| Declaration of Conformity | 67 |
| Additional Safety Information | 68 |
| Index | 71 |

1 Preparing to Use Your Computer

Chapter 1 covers the following topics:

- Turning your computer on for the first time
- Preparing your work environment
- Positioning yourself properly
- Positioning your computer components

Turning On Your Computer For the First Time

When you first turn on your computer, a series of startup screens, including a mouse tutorial, appears. When you get to the Microsoft® Windows® desktop, you must click the message **Click here to finish setting up your PC.**

As part of this final setup, you will see a roadmap that points out and describes several important icons on your desktop.

Note: *It is important to register with HP, so that you can be notified of changes and updates for your HP Pavilion PC.*



Note: *Your screen may look slightly different from the one shown here.*

If Your System Is Not Working

If any of your system components are not working properly, see Chapter 2, “Troubleshooting,” in the *Getting Help* guide.

Working in Comfort with Your HP Pavilion PC

Thank you for selecting HP computing equipment.

To optimize your comfort and productivity, it is important that you set up your work area correctly and use your HP equipment properly. With that in mind, we have developed some setup and use recommendations for you to follow, based on established ergonomic principles.

Improper and prolonged use of keyboards and input devices are among those tasks that have been associated with repetitive strain injury (RSI) to soft tissues in the hands and arms. If you experience discomfort or pain while using any computing equipment, discontinue use immediately and consult your physician as soon as possible. For more information on RSI, you may wish to consult “About Repetitive Strain Injury” on page 4.

Please study the recommendations offered here and consult the “Information Sources” listed on page 24. Included there are references to relevant parts of international standards, regulations, and guidelines, such as ISO 9241 and the European Community Display Screen Equipment directive. You may also wish to consult your employer’s human resources department or other relevant departments for guidance specific to your company. For a quick summary of the recommendations, refer to the “Comfort and Safety Checklist” on page 21.

Note that the recommendations and quoted dimensions in this guide are designed to accommodate a broad range of people. If you fall outside this range, you may need to adapt the recommendations accordingly. For example, if you are very tall, your work surface may need to be higher than indicated in this guide.

Thank you, again, for choosing HP computing equipment.

About Repetitive Strain Injury

Because your comfort and safety are our primary concern, we strongly recommend that you use HP computing equipment in accordance with established ergonomic principles and recommendations. Scientific literature suggests that there may be a relationship between injury to soft tissues — especially in the hands and arms — and prolonged improper use of keyboards or other equipment requiring repeated motions of the hands and forearms. This literature also suggests that there are many other risk factors that may increase the chance of such injury, commonly called Repetitive Strain Injury.

What is RSI?

Repetitive Strain Injury (RSI — also known as cumulative trauma disorder or repetitive motion injury) is a type of injury where soft tissues in the body, such as muscles, nerves, or tendons, become irritated or inflamed. RSI has been a reported problem for those who perform repetitive tasks such as assembly line work, meatpacking, sewing, playing musical instruments, and computer work. RSI also has been observed in those who frequently engage in activities such as carpentry, knitting, housework, gardening, tennis, windsurfing, and lifting children.

What causes RSI?

The specific causes of RSI have not been established. Nevertheless, the incidence of RSI has been associated with a variety of risk factors, including:

- Too many uninterrupted repetitions of an activity or motion.
- Performing an activity in an awkward or unnatural posture.
- Maintaining static posture for prolonged periods.
- Failing to take frequent short breaks.
- Other environmental and psychosocial factors.

In addition, there have been reports associating the occurrence of RSI with the use of computer keyboards, mice, and other input devices. Also, certain medical conditions, such as rheumatoid arthritis, obesity and diabetes, may predispose some people to this type of injury.

What can I do to avoid RSI?

Some people who use computers may experience physical discomfort during their use. This discomfort may be a symptom of a repetitive strain injury. Properly setting up and using computing equipment can help to minimize your chances of experiencing this discomfort. Well-designed and properly adjusted equipment alone may not be sufficient to eliminate all potential problems. Maintaining good posture and positioning when working on computers also has a significant bearing on your comfort.

What if I experience discomfort?

If you are experiencing any discomfort, seek professional medical advice immediately. Typically, the earlier a problem is diagnosed and treated, the easier it is to resolve.

Preparing Your Work Environment



When using HP computing equipment, it's important that your work environment contribute to your comfort and productivity. To help you achieve the proper environment, we have developed recommendations for optimizing your workspace, seating, work surface, and lighting arrangements. You, or both you and your employer, can best determine your specific needs.

Your Workspace



Sufficient workspace should be available to allow you to set up your equipment in a convenient, comfortable arrangement.

- The work environment should be as quiet and free of distraction as possible.
- For better eye comfort, you should avoid reflective coverings on the ceiling, walls, and floor as well as excessive contrast between the screen and its surroundings.

- As with any indoor environment, your workspace should be well ventilated. If possible, adjust the temperature to whatever is comfortable for you. If you can't adjust the temperature, wear appropriate clothing. Try to avoid working close to air-conditioning or heater vents.
- To prevent muscle stiffness, you must have enough space to move around and vary your position. Try not to remain in one position for extended periods of time.

Your Chair

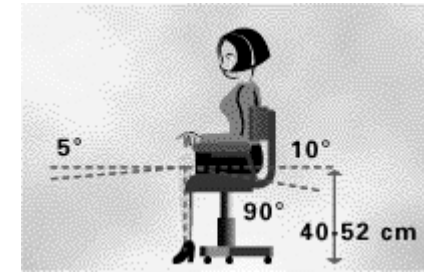

It's very important that your chair provides a comfortable sitting position and offers the following features:

- **A stable base, such as five legs with casters.** Make sure the casters are designed for the type of floor you have in your workspace, whether it is bare or carpeted.

- **A height- and tilt-adjustment feature.** It should be easy to adjust your chair height from 40 cm to 52 cm (15.5 inches to 20.5 inches) as measured from the top of the seat pan to the floor. If you are much taller or shorter than average, you may need a chair that can be adjusted beyond this range. Adjust your chair so that the work surface or keyboard tray is at elbow height and your feet are flat on the floor with your knees slightly bent below your hips. Ideally, the seat pan should be able to tilt both forward (minimum of 5 degrees) and backward (minimum of 10 degrees). If the chair has an adjustable seat pan, inclining the seat slightly forward will transfer some of the pressure from the spine to the thighs and feet. This will relieve pressure on your back.
- **A curved seat edge.** The front of the seat should be curved and finished in a “waterfall” edge.
- **An adjustable back support** in both height and forward and backward tilt. It is important that the backrest correctly supports the lower part, or lumbar curve, of the back.
- **A freely rotating swivel** so you can move easily from side-to-side.
- **Fully adjustable and padded armrests.** The chair arms should not interfere with adjusting the chair or moving it close to your work surface.

Your Work Surface

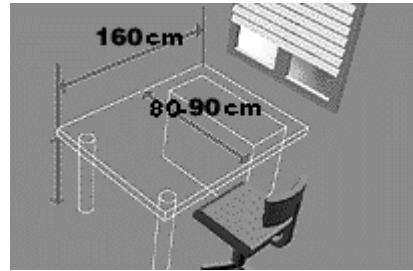

Ideally, you should be able to adjust the height of your work surface.

A simple way to ensure your work surface is at the correct height is to first adjust the height of the seatpan of your chair. With your chair properly adjusted and your feet firmly on the floor, adjust the work surface height until your forearms are parallel to the floor when you have your fingers on the keyboard or other input device.

If possible, choose a work surface with cable management capabilities. This will keep your cables and wires orderly, off the floor and out of your way.

It's also best to choose a non-reflective work surface to minimize eye discomfort from reflections and glare.

Lighting



Proper lighting can help you avoid eye discomfort. Lighting in your area should allow easy reading of documents and keyboard legends. If more light is needed for a particular task, use individual task lighting rather than increasing the general lighting.

Incoming light should be shielded or diffused to prevent glare and reflection. In cases where strong sunlight is a problem, curtains, adjustable shades, anti-glare filters, or monitor hoods are possible solutions.

Work Environment Specifications

- For better eye comfort in your work environment, you should avoid reflective surface coverings. The ceiling, walls, and floors should have a medium level of reflectance (approximately 75 percent, 40 percent, and 30 percent, respectively). Try to avoid excessive contrast between the screen and its surroundings.
- The work environment should be as quiet and free of distraction as possible, with background noise below 55 dBA.
- Where possible, relative air humidity should be in the range of 40 to 60 percent.
- The recommendation for room temperature is 19 to 23 degrees C (66 to 73 degrees F). The workplace should be well ventilated, as with any indoor environment.

- Recommended work surface space is 160 cm wide by 80 to 90 cm deep (63 inches by 32 to 36 inches deep), or a corner unit of 91 to 107 cm deep (36 to 42 inches). The recommended vertical adjustment range is 66 to 77 cm (26 to 30 inches). If the height is fixed, it should be between 72 and 75 cm (28.5 to 29.5 inches).
- There should be at least 6 cm (2 inches) between your thighs and the work surface. If the surface has a knee hole, it should be at least 58 cm (23 inches) wide, 65 cm (25.5 inches) high, and 60 cm (24 inches) deep.
- Recommended lighting levels are between 300 and 500 lux (30 to 50 foot-candles). Values over 1000 lux (100 foot-candles) are considered to be too bright. For work on the screen, 300 lux (30 foot-candles) is enough for most work. When documents are to be read, 500 lux (50 foot-candles) is recommended.

Your Work Posture

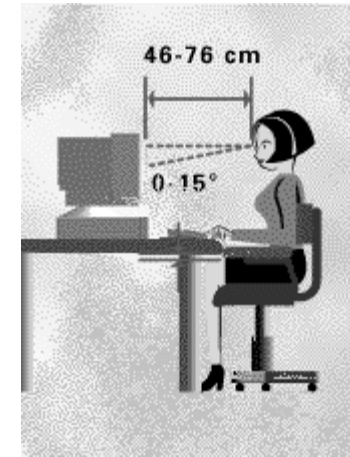

Sitting in one position for long periods can be uncomfortable. To minimize the potential for physical discomfort or injury, it's important that you maintain proper posture.

- **Back** — While sitting at your work surface, make sure your back is supported by the chair's backrest in an erect position or angled slightly backwards.
- **Arms** — Your arms should be relaxed and loose, elbows close to your sides, with forearms and hands approximately parallel to the floor.
- **Wrists** — Your wrists should be as straight as possible while using the keyboard, mouse, or trackball. They should not be bent sideways, or more than 10 degrees up or down.
- **Legs** — Your thighs should be horizontal or angled slightly downward. Your lower legs should be near a right angle to your thighs. Your feet should rest flat on the floor. If necessary, use a footrest, but double check that you have your seat height adjusted correctly before getting a footrest.
- **Head** — Your head should be upright or tilted slightly forward. Avoid working with your head or trunk twisted.
- **Overall** — Change your position frequently and take regular breaks to avoid fatigue.

Setting Up Your HP Computing Equipment



Make sure that all the elements of your HP computer system — monitor, document holder, keyboard, mice and other input devices, and headphones and speakers — are optimally arranged and adjusted to meet your personal requirements. The recommendations that follow will help you achieve this.

Note that these recommendations apply only to the use of HP desktop computers or HP notebook computers that are used with a full-size keyboard, monitor and mouse.

Your HP Monitor



It is important that your monitor screen be clean and positioned correctly to improve readability and help you work comfortably. Glare, high contrast, reflections, dirt, and dust will interfere with what you see on the screen. The recommendations that follow can help you achieve a comfortable arrangement.

- The top of your monitor screen should be at or slightly below eye level. Most HP monitors come with a tilt-and-swivel feature that makes it easy to adjust the screen position. If your monitor doesn't have this feature, consider acquiring an accessory that provides this capability.
- To avoid obscuring your view, the screen should be positioned perpendicular to your line of sight; that is, straight on.
- To avoid glare or reflection, try to position the monitor so the screen is at a right angle to your window rather than in front of it. If reflection or glare persists, tilting the screen forward may help. If this adjustment is not sufficient, it may be necessary to change either the position of the monitor on your work surface, or the location of your work surface. If reflection or glare is still a problem, find out where it is coming from. Common sources of glare are overhead lights, windows, or reflections from shiny surfaces including pictures or even bright clothing. See if there is a way to control the source of the problem (see "Lighting" on page 10). If that doesn't work, try a high-quality anti-glare filter or a screen hood.
- Maintain a comfortable viewing distance to the screen. Most people prefer a viewing distance of approximately 46 to 76 cm (18 to 30 inches), depending on monitor size. Character size and the amount of space available on the work surface can affect this distance.

- Text should be easy to read. To help ease eyestrain, adjust text attributes such as character size, spacing, and color. In addition, you will need to use the controls provided with your monitor to adjust the visual settings so that contrast and brightness levels are comfortable for you. High contrast and low brightness is usually the preferable combination.

Note: *The ISO 9241 and ANSI/HFS 100-1988 standards give technical recommendations on how to achieve good readability.*

- The monitor should be free from flicker. If the image on your screen is not stable, the monitor may require repair or adjustment.
- When possible, use a program that has a simple user interface, such as easily identifiable icons and pull-down menus. Also, screen information should be displayed in a structured and well-organized way.

Monitor use specifications

- When viewing your monitor, your head should not be tilted more than 15 degrees forward.
- Optimum readability for monitor use is generally considered to be 21 minutes of arc. This corresponds to a character size of 3.7 mm (0.15 inches) at a viewing distance of 60 cm (24 inches).
- You should not have to look up more than 5 degrees above horizontal or down more than 30 degrees below horizontal for normal work tasks, such as typing or reading.

Document Holders



When keying in data from a hard-copy document, placing it in a document holder rather than on a flat surface will make it easier to read. The following recommendations should be observed when using a document holder:

- The document holder should be at approximately the same height and distance from your eyes as the screen, and as close to the monitor as possible to prevent neck twisting. Some users prefer a document holder mounted to the monitor, while others prefer the document holder positioned between the screen and keyboard.
- If the primary task is to view documents rather than using the monitor, the document holder may be placed directly in front of the keyboard with the monitor slightly to the side.
- To help reduce stress on your neck and prevent eye fatigue, try to minimize the movement of your head and eyes while using a document holder.

Your HP Keyboard

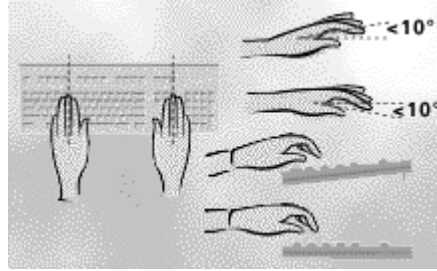

The proper positioning and use of your HP keyboard is important when using HP computing equipment. Be sure to observe the following recommendations to optimize your comfort and safety:

- We recommend you place your keyboard in front of the screen or document holder, whichever is viewed the most. Your HP keyboard has long cables, so you can place it in the position that is most comfortable for you while you are using your system.
- Because HP keyboards vary in depth, you'll want to be sure that your work surface or keyboard tray has sufficient room to accommodate your model. The keyboard tray should be wide enough to hold both the keyboard and mouse or trackball: 66 to 71 cm (26 to 28 inches).
- Your HP keyboard may have a kickstand that can be opened or closed to raise or lower the keyboard angle. If you are in the correct sitting position with your elbows at about the same level as the work surface, you may not need to use it. However, if your elbows are below the work surface, you may wish to use the kickstand to raise the back of the keyboard.

- An adjustable keyboard tray may be useful if you cannot adjust your chair or work surface to the proper height for typing. It should adjust in height from 64 to 76 cm (25 to 30 inches) above the floor and tilt forward and backward to help you find the most comfortable position. Note that research has shown that there may be less muscle tension in shoulders and forearms with the keyboard tilted away from you.
- When using your HP keyboard, remember it takes very little pressure or force from your fingers to activate the keys. Improper typing style — the use of too much force — can place unnecessary stress on the tendons and muscles in your hands, wrists, and forearms.
- Make sure that your hands are in a neutral position when you use your keyboard. This means that your forearms, wrists, and hands should be in a straight line.
- The keyboard has a low profile to help prevent excessive bending of your wrists while typing. Literature suggests that you should not bend your wrists sideways or more than 10 degrees up or down. Keep your wrists straight by moving your entire hand and forearm over to use the function keys or numeric keypad.
- You may use a palm rest to help keep your hands and wrists in a comfortable and neutral position when you are not typing. Some HP keyboards come with an integrated palm rest. If you use a palm rest, see that it is rounded and padded, and flush in height with the front edge of the keyboard. Note that your palms — not your wrists — should rest on the palm rest. If you don't have a palm rest, try not to rest your wrists on a sharp edge, such as a work surface edge.

Mice and Other Input Devices

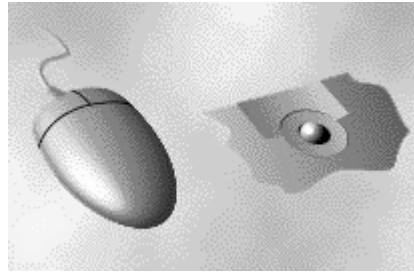

Various aspects of using mice and other input devices may increase your risk of discomfort or injury. Observing the following recommendations may reduce that risk:

- As with the keyboard, try to keep your hand, wrist, and forearm in a neutral position while using your mouse or other input device.
- When using a stylus or light pen with a graphics tablet, don't grip the stylus tightly. Keep your hand and fingers relaxed and try to maintain a neutral posture in your hand, wrist, and forearm.
- If you use your thumb to rotate the ball on a trackball or spaceball, keep it in a relaxed, natural shape, and maintain a neutral posture in your hand, wrist, and forearm.
- Hold the mouse gently by draping your fingers over it. Keep your hand relaxed and fingers loose. Do not grip the mouse tightly.
- It takes very little pressure or force from your fingers to activate the buttons or scroll wheel on your mouse, scrolling mouse, trackball, or other input device. Using too much force can place unnecessary stress on the tendons and muscles in your hands, wrists, and forearms.
- If you are using a scrolling mouse, be sure to keep your fingers and hand in a relaxed, neutral position when activating the scroll wheel. Also, this type of mouse features software that can minimize the number of mouse movements or button clicks.

- When using a mouse, trackball, stylus and graphics tablet, or other input device, position it as close to the keyboard as possible, and keep it at the same level so you do not have to stretch while using it.
- Use a good quality mouse pad to enable the mouse to work most effectively and reduce unnecessary hand and wrist movements.
- Be sure to keep your mouse and trackball clean. Regular removal of accumulated dust and dirt helps ensure proper tracking and reduces unnecessary hand and wrist motions.

Headphones and Speakers



Listening to loud sounds for prolonged periods may permanently damage your hearing. To avoid discomfort from unexpected noise, always turn down the volume before connecting headphones or speakers to your HP equipment.

When you put on the headphones, slowly increase the volume until you find a comfortable listening level, then leave the volume control in that position.

Comfort and Safety Checklist



These recommendations are drawn from the latest available international ergonomic standards and recommendations, including ISO 9241 and ANSI/HFS 100-1988.

General

- **Work Surface Height** — Adjust either your seat height, work surface, or both, to position the work surface at approximately elbow height.
- **Work Surface Arrangement** — Make sure frequently used equipment is within easy reach. For example, if you are primarily using the keyboard, place it directly in front of you, not to the side. If you are primarily using the mouse, place it in front of your hand or arm. If you are using both a mouse and keyboard, place them both at the same work surface height and close together. If a palm rest is used, the height should be flush with the front edge of the keyboard. Other items, such as your telephone or notepad, also should be considered.
- **Monitor** — Place your monitor so that the top of the screen is at, or slightly below, eye level (up to 15 degrees).

- **Head** — Do not tilt your head forward by more than 15 degrees, and try not to turn your head toward the side.
 - **Back** — While sitting at your work surface, make sure your back is supported by the chair's backrest in an erect position or angled slightly backwards.
 - **Arms** — Make sure your arms and elbows are relaxed and loose, with your upper arm perpendicular to the floor or slightly forward. Keep your forearms and hands approximately parallel to the floor with elbows bent between 70 and 115 degrees. Keep your elbows close to your sides (less than 20 degrees away from your body).
 - **Legs** — Your thighs should be horizontal or angled slightly downward. Your lower legs should be near a right angle to your thighs. Make sure there is sufficient room under the work surface for your legs.
 - **Feet** — If after adjusting your chair you cannot rest your feet comfortably on the floor, use a footrest, preferably one that can be adjusted in height and angle.
- Overall**
- Look away from the screen from time-to-time to help reduce eyestrain. Focus on distant objects briefly, and blink periodically to lubricate your eyes. You also should have your eyes checked on a regular basis and ensure your eyeglass prescription is suitable for working on a monitor screen.

- Remember to occasionally shift position and move your body. Keeping your body in one position for long periods is unnatural and stressful. When prolonged work is required, take frequent short breaks. As a rule of thumb, a five or ten minute break every hour is a good idea. Short frequent breaks are more beneficial than longer, less frequent, breaks. Data shows that people who work for long periods of time without a break may be more prone to injury.
- Changing tasks frequently will help prevent muscle stiffness. For example, alternating between keyboarding, reading, writing, filing, and moving around in your work environment helps you maintain a relaxed posture. Occasionally stretch the muscles in your hands, arms, shoulders, neck, and back. You should stretch at least as often as you take brief task breaks — at least once every hour.
- Discomfort may be alleviated by using alternative ergonomic designs and accessories such as ergonomically personalized chairs, palm rests, keyboard trays, alternative input devices, prescription eyeglasses, anti-glare screens, and more. Seek additional information from the sources available to you, including your employer, doctor, local office supply store, and the information sources provided in this guide.

Information Sources

- 1 Bailey, R.W.: *Human Performance Engineering: Designing High Quality Professional User Interfaces for Computer Products, Applications and Systems*, 3rd edition, 1996.
- 2 Bayerisches Staatsministerium fuer Arbeit: *Arbeiten mit dem Bildschirm — aber richtig!*, Max Schick GmbH, Muenchen, (Germany) 1992.
- 3 Caisse Nationale d'Assurances: *Le travail à l'écran de visualisation*, Luzern (Switzerland), 1991.
- 4 Chaffin, D. and Andersson, G.: *Occupational Biomechanics*, 1991.
- 5 European Community: *Council Directive of 29 May 1990 on the Minimum Safety and Health Requirements for the Work with Display Screen Equipment*, Directive /270/EEC, Brussels, Belgium, 1990.
- 6 Granjean, Eric: *Ergonomics in Computerized Offices*, Taylor & Francis, London, England, 1987.
- 7 Hamilton, N.: *Source Document Position as it Affects Head Position and Neck Muscle Tension*, *Ergonomics* 39 (4): 593-610.
- 8 International Standards Organization: *ISO 9241: Ergonomic Requirements for Office Work with Visual Display Terminals (VDTs)*, Geneva, Switzerland, 1992.
- 9 Putz-Anderson, V.: *Cumulative Trauma Disorders: A Manual for Musculoskeletal Diseases of the Upper Limbs*, 1988.
- 10 Sanders, M. and McCormick E.: *Human Factors in Engineering and Design*, 1987.
- 11 Shiraishi, M. and Ueno, Y.: *Functional Requirements of Forward-tilting Office Chairs*, *Hard Facts About Soft Machines*, 1994.
- 12 Swedish National Board of Occupational Safety and Health: *Work with Visual Display Units (VDUs)*, ORDINANCE AFS 1992:14, Stockholm, Sweden, 1992.
- 13 U.S. Department of Labor/Occupational Safety and Health Administration: *Ergonomics: the Study of Work*, U.S. Government Printing Office, Washington D.C., 1991.
- 14 U.S. Department of Labor/Occupational Safety and Health Administration: *Working Safely with Video Display Terminals*, U.S. Government Printing Office, Washington, D.C., 1991.

2 Exploring Your System

Chapter 2 covers the following topics:

- Turning the computer on and off
- Suspending your computer
- Using the keyboard
- Using the mouse
- Using headphones
- Working with diskettes
- Using the CD-ROM drive
- Using the modem

Turning On Your Computer

First, press the Power button on your display. Then, to turn on your computer, press the On button on the front of the PC.

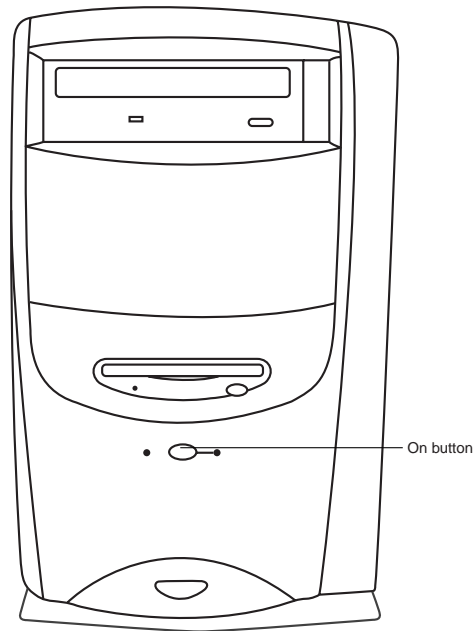

Turning Off Your Computer

There is only one way to turn off your computer correctly. To turn off the computer:

- 1 Exit all software programs. (To close programs, click X in the upper right corner of each window.)
- 2 Click **Start** on the taskbar.
- 3 Click **Shut Down** (last item on the menu).
- 4 In the dialog box, make sure **Shut down** is selected.
- 5 Click **Yes**.
- 6 Turn off your display.

Caution: *Pressing the computer's On button when software is running could corrupt your files.*

Note: *If your system is “frozen” and won’t respond to the mouse or keyboard, you can’t use Shut Down. In this case, press the On button to turn off the power of your computer. Wait a few seconds, then turn the computer back on. Turning off your computer this way does not protect your programs and files as well as Shut Down does. The next time you turn on the computer, the hard disk may be scanned for errors.*

Suspending Your Computer

As an alternative to shutting down your computer, you can put your PC in Suspend mode. When you suspend your computer, it goes into a low-power state and your display is blank as if it’s turned off. The next time you use your computer, any applications, folders, and documents that were open before you suspended the computer will be ready and waiting for you. With Suspend, you can save electricity without having to wait for your PC to go through the normal startup routine when you turn on the computer.

Suspend also allows faxes to come through to your computer, and enables your PC to automatically retrieve your e-mail messages and download information from the World Wide Web (if you have programmed your computer to do so).

To suspend the computer:

- 1 Press the Suspend button on the keyboard. The screen goes dark, and the computer goes into Suspend mode.
- 2 When you want to use your computer again, just start to use the keyboard or mouse, or press the Suspend button. The screen display will reappear just as you left it.

Another way to suspend your computer is to choose **Suspend** on the Start menu.

Note: *If you use an application that wakes your computer when it is suspended (such as when a fax program receives an incoming fax), the computer will not go back into Suspend mode automatically, unless your PC is configured to use the Auto Suspend feature. For more information on Auto Suspend, see “Setting Auto Suspend in the BIOS” in the Getting Help guide.*

Using the Keyboard

You have a special keyboard that enables you to:

- Connect directly to the Internet (if your telephone line is connected to the computer).
- Suspend your computer to save power while you aren't using it.
- Get support information.
- Set shortcuts to your favorite programs.

Note: *If your keyboard is not working properly, see Chapter 2, “Troubleshooting,” in the Getting Help guide.*

Special Keyboard Buttons

Internet Press this button to launch the Internet browser of your choice. For more information on connecting to the Internet, see page 48. This button can be reconfigured to launch any application; see “Reconfiguring Keyboard Buttons” on page 29.

Note: *The Internet button will work only if you have connected a telephone line to the computer.*

Suspend Press this button when your computer won't be used for a while, but you don't want to turn it off. Pressing this key will save electricity. The screen will go dark, and your computer will go into Suspend mode. When you want to use your system again, press Suspend again, move the mouse, or press any key. The screen display will reappear just as you left it.

Information Press this button to see HP support options. By default, this button launches Personal Guide but you can configure it to start HP Support Center or any application you choose. For information on reconfiguring this key, see the next section, “Reconfiguring Keyboard Buttons.”

Reconfiguring Keyboard Buttons

Two buttons on the keyboard can be reconfigured to start different applications: Information and Internet.

To reconfigure the buttons:

- 1 Click **Start** on the taskbar.
- 2 Select **Settings**.
- 3 Click **Control Panel**.
- 4 Double-click the **Keyboard** icon in Control Panel.



- 5 Click the **Keyboard Manager** tab.
- 6 In the window that appears, click the button you want to configure.
- 7 Select an application from the list, or click **Browse** to find an application yourself.
- 8 Change the label to reflect the new application. (The label will be displayed at the bottom of the screen when the button is pressed.)
- 9 Click **OK**.
- 10 Repeat steps 6 through 9 for each button you want to reconfigure.
- 11 Click **OK** when you are finished reconfiguring your keyboard.

Changing the Screen Display of Keyboard Messages

When you press any of the three buttons on the top of your keyboard, the button description (such as “Suspend”) appears on your screen.

To change the size, font, and color of these on-screen messages:

- 1 Click **Start** on the taskbar.
- 2 Select **Settings**.
- 3 Click **Control Panel**.
- 4 Double-click the **Keyboard** icon in Control Panel.
- 5 Click the **Keyboard Manager** tab.
- 6 Select **Change Onscreen Display**.
- 7 Make your changes.
- 8 Click **Done**.
- 9 Click **OK**.



Using the Mouse

As an alternative to the keyboard, you can use your mouse to choose commands from the menus and select items on the screen. To move the mouse pointer, just slide the mouse on your desk in the direction you want to move the pointer; the mouse pointer will move on the screen in the same direction. Mouse pads are not required, but they do provide a clean, flat surface.

Once you have pointed to an item with the mouse, you can select the item by tapping the left mouse button once. For some tasks, such as opening a document or running a program, you'll need to double-click the item. To double-click, point to the item and tap the left mouse button twice, quickly.

The right mouse button functions differently in each application. In many programs, the right button displays a context-sensitive menu.

For practice using the mouse:

- Run the mouse tutorial that came with your computer. To start the program, click the **Start** button on the taskbar, choose **Run**, type `windows\options\cabs\wintutor.exe`, and click **OK**.
- Play Solitaire or any of the other games included with your computer.

Note: *If your mouse is not working properly, see Chapter 2, “Troubleshooting,” of the Getting Help guide.*

Using Headphones

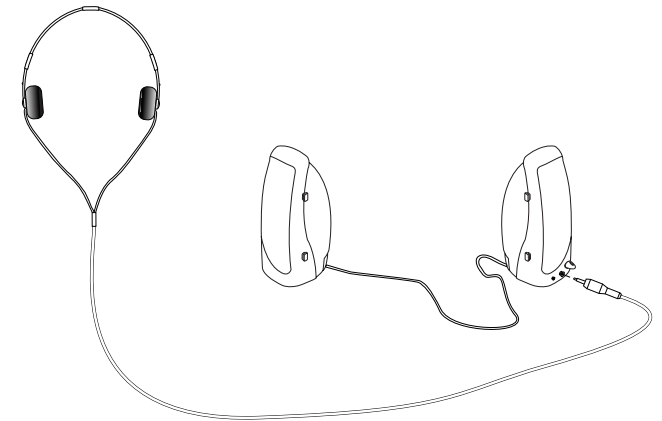

Your right HP Pavilion speaker is equipped with a standard mini (3.5mm) headphone jack. This jack supports most portable headphones. If you would like to use headphones equipped with the larger .25-inch phone jack, inexpensive adapters are available at most consumer electronics stores.

To use the headphones, plug them into the headphone jack located at the front of the right speaker.

Note that when the headphones are plugged in, the speakers will be muted. (The system's line output, however, will continue to work.) When you unplug the headphones, the speakers will go back to normal operation.

Working with Diskettes

Your computer comes with a 3.5-inch diskette drive. To insert a diskette into the drive:

- 1** Hold the diskette by the label, with the label facing up.
- 2** Insert the diskette into the drive, with the metal plate going into the drive first.
- 3** Push the diskette into the drive until you hear a click.

To remove the diskette, press the button underneath the drive. Be sure to remove the diskette before shutting down your computer; if a diskette is in the drive the next time you turn on your computer, you will see an error message and the Windows desktop will not be able to start. If this happens, just eject the diskette and press any key to continue.

Caring for Diskettes

You'll want to take proper care of your diskettes so that you don't lose important information. Follow these tips:

- Keep magnetic material away from your diskettes. Magnets can scramble the data on the diskette.
- Do not remove a diskette while the indicator light is on.
- Store diskettes at room temperature.

Formatting Diskettes

Before you can use a diskette, it must be formatted, or initialized. Most diskettes come preformatted — check the box or diskette label to see if the diskettes are already formatted. If they are not formatted, you will need to format them yourself.

To format a diskette:

- 1 Insert the diskette in the drive.
- 2 Double-click the **My Computer** icon on the desktop.
- 3 Click (don't double-click) the 3-1/2 floppy (A:) icon.
- 4 Click **File** on the menu bar and choose **Format**.
- 5 Choose **OK**.

 **Warning:** *Formatting erases all data on a diskette.*

Using the CD-ROM Drive

Your CD-ROM drive can run software on CD-ROMs as well as play music CDs. This section shows you how to perform these different tasks.

Note: *If you have any problems with your CD-ROM drive, see Chapter 2, “Troubleshooting,” in the Getting Help guide.*

Inserting a CD

To insert a CD in the CD-ROM drive:

- 1 Make sure your computer is turned on.
- 2 To eject the disc tray, press the button under the CD-ROM drive.
- 3 Remove the CD from its case, holding onto the disc’s edges only.
- 4 With the label facing up, gently place the disc in the tray.

- 5 Press the button under the CD-ROM. The disc tray glides back inside the computer.

Caring for CDs

As with diskettes, CDs require special handling so that you don’t lose important information. Follow these tips:

- Return CDs to their protective cases when you are finished using them.
- Avoid touching the underside of the disc with your fingers or placing the disc face up on your desktop. Doing so could scratch the surface.
- Handle the disc by its outside edges or inner hole only.
- Store CDs at room temperature.

Playing Music CDs

Music CDs automatically play when you insert them into your CD-ROM drive. To adjust sound, skip tracks, or stop playing the CD, click the **Media Rack** button on the taskbar.

Using CDs that Came with Your HP Pavilion PC

Some programs (such as encyclopedias) require that you insert the CD in order to run the software. To play these CDs:

- 1 Place the CD in the CD-ROM drive.
- 2 Double-click the **Preinstalled Software** icon on your desktop.
- 3 Scroll the Preinstalled Software window until you locate the program you want to start.
- 4 Double-click the CD title you wish to play.



Playing MPEG Videos

MPEG (Motion Picture Experts Group) videos can be on CDs, files downloaded from the Internet, satellite transmissions, or files on a diskette. Your computer supports the MPEG-1 standard; these files typically have a .DAT or .MPG extension.

To play an MPEG-1 file:

- 1 In My Computer or Windows Explorer, go to the drive and folder containing the MPEG-1 file.
- 2 Double-click the file name you want to play.

Using the Modem

Your HP Pavilion PC comes with a K56flex data/fax modem. Using the modem and the software included with your PC, you can:

- Connect to the Internet (see “Connecting to the Internet” on page 48).
- Send and receive e-mail messages (see “Sending and Receiving E-Mail” on page 50).
- Send and receive faxes (see “Sending and Receiving Faxes” on page 55).

Note: *For online documentation on your modem, go to the Pavilion Library in the HP Support Center.*

Even though your modem is capable of downloading at 56Kbps using K56flex technology, your online or Internet Service Provider may not operate at this speed or support this technology. Please check with your service provider for information on its capabilities.

Please note that the maximum speed for faxing is 14.4Kbps.

3 Discovering Your Software

Chapter 3 covers the following topics:





- Learning about your Windows desktop
- Finding your preinstalled software
- Finding files
- Adding and deleting software
- Getting help from the HP Support Center
- Getting software help

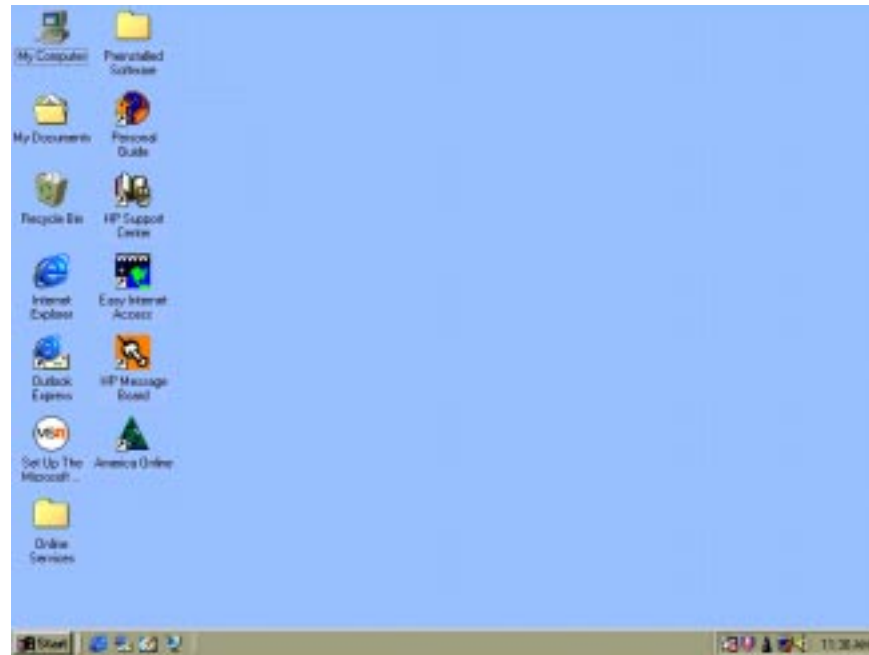



Learning about the Windows Desktop

After you turn on your computer and the operating system loads, the Windows desktop appears.



As you can see, the Windows desktop contains a number of icons; the table below describes some of the more important ones.

| | |
|---|--|
|  | Use the My Computer icon to view the contents of the drives and folders on your computer and to manage your files. |
| My Computer | |
|  | To delete a file or icon, just drag it the Recycle Bin. Don't forget to empty the bin periodically. |
| Recycle Bin | |
|  | The Internet Explorer icon launches Microsoft's Web browser. Note that you must have an Internet Service Provider in order to use this browser. |
| Internet Explorer | |
|  | The Easy Internet Access icon allows you to choose from three Web browsers and then connect to the Internet. See "Browsing the Internet" on page 49. |
| Easy Internet Access | |

| | |
|---|--|
|  | The Preinstalled Software folder contains descriptions of all the software that came with your HP Pavilion PC. You can also launch applications from this folder. See "Finding Your Preinstalled Software" on page 41. |
| Preinstalled Software | |
|  | This icon launches Personal Guide where you can run tutorials to learn more about the Windows desktop. See "Using Personal Guide" on page 40. |
| Personal Guide | |
|  | Use this icon to get help with your HP Pavilion PC software or hardware. See "Getting Help from the HP Support Center" on page 44. |
| Support Center | |
|  | Click the Start button to display the Windows main menu where you can access your programs and documents. |

Using Personal Guide

For those who are new to the Windows desktop, Personal Guide provides an easy way to start using your HP Pavilion PC. It offers easy access to a variety of on-screen tutorials and short demos that will help you get up and running quickly with your new computer.

Start Personal Guide by double-clicking its icon on the Windows desktop.



To explore a Personal Guide category, click its button in the Personal Guide window. Descriptions of the Personal Guide categories are listed on the following page.

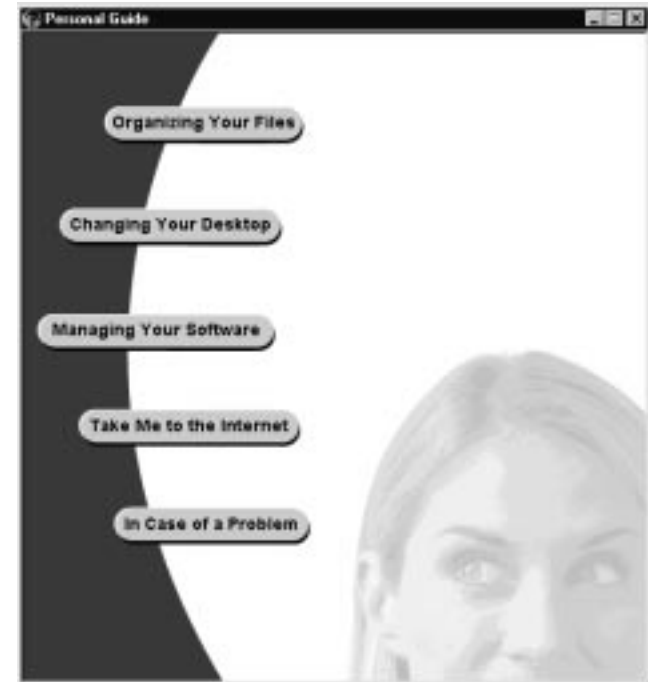

Personal Guide Categories

| | |
|--------------------------------|--|
| Organizing Your Files | Helps you get acquainted with the Windows desktop, creating folders, saving files, moving and removing documents, finding files, creating shortcuts, and using Windows Explorer. |
| Changing Your Desktop | Explains how to increase the size of the desktop, change the colors of your windows and desktop, choose a screen saver, format the taskbar, and use Suspend mode. |
| Managing Your Software | Explains how to install and remove software, add software to the Start menu, prevent software from starting automatically, use the taskbar, and start a DOS session. |
| Take Me to the Internet | Launches a demo summarizing the benefits of the Internet. If you sign up for a free Internet access trial, you can access your browser directly from here. |
| In Case of a Problem | Takes you directly to the HP Support Center so that you can get help with your HP Pavilion PC software or hardware. |

Finding Your Preinstalled Software

Your HP Pavilion PC comes with a number of preinstalled software programs; for your convenience, these programs have been placed in a folder on your desktop. The programs vary, depending on which system you purchased.

To see the key programs on your HP Pavilion PC:

- 1 Double-click the **Preinstalled Software** folder on your Windows desktop.
- 2 Click once on an icon to view a description of the software program; this description appears in the left pane of the Preinstalled Software window.
- 3 To run a program, double-click the program's icon in the window.



Note: You can also run all of these preinstalled programs (plus any new ones you install) from the Programs list. To see this list, click Start on the taskbar and then choose Programs.



Note: Your window may show different software icons.

Finding Files

To find documents or folders on your computer:

- 1 Click **Start** on the taskbar.
- 2 Select **Find**.
- 3 Click **Files or Folders**.
- 4 Type all or part of the name of the document (or folder).
- 5 Click **Find Now**. The magnifying-glass animation means the search is in progress. If there are any matches, a list of files appears.
- 6 Double-click the document (or folder) to open it.

Adding Software

The best way to install a new program is to use the Add/Remove Programs utility.

To install new programs by running Add/Remove Programs:

- 1 Insert the CD or diskette in the appropriate drive.
- 2 Click **Start** on the taskbar.
- 3 Select **Settings**.
- 4 Click **Control Panel**.
- 5 Double-click **Add/Remove Programs**.
- 6 Click **Install**.
- 7 Follow the on-screen directions.

Once a new program is installed, it appears in the Programs section of the Start menu.

Deleting Software

There are a number of ways to remove programs from your hard disk. Some programs come with their own uninstall utility, which you use to remove the program. You can also buy uninstall utilities that remove any program from your hard disk. Or you can use the Add/Remove Programs utility, located in the Control Panel.

To use the Add/Remove Programs utility:

- 1 Click **Start** on the taskbar.
- 2 Select **Settings**.
- 3 Click **Control Panel**.
- 4 Double-click **Add/Remove Programs**.
- 5 Click the program you want to remove.
- 6 Click **Add/Remove**.
- 7 Click **OK**.

Getting Help from the HP Support Center

The HP Support Center groups your support options, online documentation, tutorials, and system maintenance tools in one convenient location.

To go to the Support Center, choose **HP Support Center** in the Start menu or double-click the icon on the desktop.



Note: You can configure your Information button to launch HP Support Center. See “Reconfiguring Keyboard Buttons” on page 29.



Descriptions of HP Support Center options are listed in the following table.

HP Support Center Options

| | |
|----------------------------|--|
| Software Help | Each software package shipped with your computer is listed here, along with its manual (if there is one), online Help, and a support phone number. |
| Hardware Help | Information on hardware components (such as your keyboard) is located here. |
| HP Pavilion Library | Online manuals are found here. Software manuals (also found under Software Help) are found here as well. |
| Tutorials | Learn skills such as creating software shortcuts and changing the color of your screen background by taking the short lessons found here. |
| Common Questions | Common questions that HP Support Center personnel are frequently asked are listed and answered here. Subjects range from modems to the Internet to MS-DOS and more. Check here if you have a question about your computer. |
| System Maintenance | Here you find system tools to clean up your hard disk and remove viruses. |
| Technical Support | Find information about your technical support options here. |

Getting Software Help

If you are having trouble learning a new software program, you have a number of ways to get help:

- Use the online help. In most programs, you can open a help window by pressing the F1 function key.
- Read the online documentation. To see if a program has documentation online, double-click the **HP Support Center** icon on the desktop and click the **HP Pavilion Library** button. 
- Call the vendor's telephone support number or visit its Web site. This information is available in the HP Support Center, in the Technical Support category.

4 Communicating with the World

Chapter 4 covers the following topics:

- Connecting to the Internet
- Signing up for Internet access
- Browsing the Internet
- Sending and receiving e-mail
- Using the HP Message Board
- Sending and receiving faxes

Connecting to the Internet

Your HP Pavilion PC is Internet-ready and comes with everything you need to use the Internet:

- Free* Internet access without the use of a credit card (*Please read the terms and conditions on page 53)
- A Personal Message Board where you can create and post messages to family and friends
- Personalized e-mail accounts
- Choice of three browsers
- A Web site dedicated to HP Pavilion PC owners

Signing Up for Internet Access

If you haven't yet signed up for your free* Internet access:

- 1 Double-click the **Easy Internet Access** icon on your desktop, or press the Internet button on your keyboard. The icon is a small square with a dark background. At the top, the letters 'WWW' are written in white. Below the letters, there is a white plus sign and a small globe icon.
- 2 Watch the interactive demo to acquaint yourself with the Web and see how to use e-mail.
- 3 Click **Sign Up** to register for your free Internet access trial.
- 4 Follow the instructions on your screen. During the sign-up process, you have the option of adding multiple e-mail accounts.

Note: *Be sure to set up all the accounts you need at this time because you won't have an opportunity to do so later.*

Whenever you want to connect to the Internet in the future, just double-click the **Easy Internet Access** icon on your desktop, or press the Internet button on your keyboard.



Browsing the Internet

Exploring the Internet with your HP Pavilion PC is fun and easy. When you sign up for the Easy Internet Access, you have three Internet browsers to choose from:

- **Easy Internet Access** — HP's customized browser that offers an easy and fast way to surf the Web and send and receive electronic mail.
- **Kids Internet Browser** — HP's customized browser designed especially for children. It offers e-mail services and access to fun Web sites.

- **Microsoft Internet Explorer** — a traditional Web browser. For e-mail services, you will need to configure Microsoft Outlook Express.

Each time you connect to the Internet, you can select which browser you want to use, or you can create a customized icon that launches either the Easy Internet Access or Kids Internet browser.

To connect to the Internet:

- 1 Double-click the **Easy Internet Access** icon on your desktop, or press the Internet button on your keyboard.
- 2 Choose your account.
- 3 In the Browser Selector dialog box, click the browser you want to use.
- 4 Click **Start**.



Once you are connected to the Internet, be sure to visit the HP At Home Web site. An **HP At Home** button is provided in the Easy Internet Access browser, or you can enter the following address:

<http://www.hp-at-home.com>

At this Web site, you can get:

- Tips and updates on using your computer
- Ideas for projects that you can create on your PC
- Additional assistance when you have a question or need help

To visit other sites, click the buttons in the customized browsers or type in the Web addresses. Another way to browse the Internet is to use the browser's **Search** button to hunt for all references to a specific word or phrase on the Web.

Sending and Receiving E-Mail

The specific steps for sending and receiving e-mail depend on which mail program you are using. The procedures below are for the Easy Internet Access browser.

To go to the Easy Internet Access browser e-mail program:

- 1 Double-click the **Easy Internet Access** icon on your desktop, or press the Internet button on your keyboard. 
- 2 If you have multiple mail accounts, click the account you want to use.
- 3 Choose the **Easy Internet Access** browser and click **Start**.
- 4 Click the **Go to e-mail** button.

To send an e-mail message:

- 1 In the Easy Internet Access e-mail window, click **Write messages**.
- 2 Fill in the recipient's e-mail address and the subject of the e-mail, and then type your message.
- 3 Click **Send messages**.

To receive e-mail messages:

- 1 In the Easy Internet Access e-mail window, click **Get messages**.
- 2 Click a message in the list to read its contents.

When you are finished sending and receiving e-mail, click the **Close e-mail** button.

Using the HP Message Board

After you sign up for the Easy Internet Access, you have access to the HP Message Board. This is your own personal space where you can post messages and photos for others to view. It's a place where you can share:

- Your latest holiday photos
- Personalized notes
- Fun greetings
- And much more...

Just give your family and friends your Message Board Web address and password and they can view it with their own Internet connection.

It's as easy as Create, Post, and Share.

Creating a Message

To create a message for your Message Board:

- 1 Double-click the **HP Message Board** icon on your desktop. 
- 2 Click **Create & Post** to start the Message Creator.
- 3 Select a message option or choose to design one of your own.
- 4 Start personalizing your message.

Posting a Message

Once you've completed your message, select **Post to my Message Board** to send your message to your Message Board.

After it's been posted, a confirmation will be sent to you. Posting takes approximately 5–10 minutes.

Sharing Your Message Board

Once you receive confirmation that your message has been posted successfully, send e-mail to your friends and give them the Web address and password of your Message Board so they can view your postings. You can find the Web address and password in the confirmation e-mail that was sent to you after you posted your message.

Another way to look up the Web address and password needed for access to your postings is to double-click the **HP Message Board** icon on the desktop and select **Giving people access to your Message Board**. 

Terms and Conditions of the Free Internet Access

- Free Internet access is limited to the number of specified hours, starting from the date of purchase. Your daily usage may be limited as well.
- Free Internet access only covers the Internet Service Provider (ISP) connect time. You will be responsible for any additional phone toll charges from the phone company that are incurred when you call from your home or office to the nearest access number.
- When selecting a local access number, please remember that calling a number within your area code does not guarantee the call is free.
- Please check with your phone carrier to make sure the number you have selected is considered a local call in your area. HP and GTE are not responsible for additional long distance phone charges.
- Your Internet account is nontransferable.

Removing the Channel Bar

Your Windows desktop may contain the Internet Explorer Channel bar which you can use to quickly access pages from your favorite Web sites. In order to use the bar, however, you must have an Internet Service Provider (ISP) and you need to set up Internet Explorer 4.0 to connect with your ISP. If you don't plan on using the Channel bar in the near future, you may want to remove it from the desktop.



To remove the Channel bar from the desktop:

- 1 Right-click an empty area of the desktop.
- 2 Choose **Active Desktop** and then **Customize my Desktop**.
- 3 Turn off the **Internet Explorer Channel Bar** option.
- 4 Click **OK**.

Note: *If you later decide you want to use the Channel bar, just follow the above steps, except turn on the Internet Explorer Channel Bar option.*

Sending and Receiving Faxes

The QuickLink III software included with your HP Pavilion PC can turn your PC into a fax machine.

Sending a Fax

There are two ways to compose a fax. You can type a message on the Quick Fax notepad, or you can fax a file from any program that can print.

Sending a fax composed on the Quick Fax notepad

- 1 Double-click the **Preinstalled Software** folder on your desktop, and scroll the window until you find QuickLink III.
- 2 To start the program, double-click **QuickLink III**.
- 3 Click **Quick Fax** on the QuickLink III main window toolbar. The Message Manager appears.



- 4 Type the appropriate address and subject information in the fax header.
- 5 Type the message body in the QuickFax Note area.
- 6 Click **Send Fax**.

Faxing a file using software programs

Software programs that can print can also send faxes. To send a fax, change the selected printer (in the Print dialog box) to **QuickLink III**, and then print as you normally do.

Receiving Faxes

QuickLink III also has the ability to receive, view, and print faxes. Faxes are automatically received when the QuickLink III program is running in an open or minimized window.

Note: *To see if you have received any faxes, look at the status bar at the bottom of the QuickLink III window.*

To view and print a fax:

- 1 In QuickLink III, click **View Fax** on the toolbar.
- 2 Double-click the name of the fax that you want to view.
- 3 Click the **Print** button to print the fax on the selected printer.

Glossary

A

Add-in Card A circuit board that plugs into the motherboard and gives added capability, such as video conferencing.

Anti-Glare Filter A mesh or laminar screen placed over the monitor screen to prevent glare.

Auto Suspend A power-saving feature that is automatically enabled when the keyboard or mouse isn't used for a set period of time (such as 30 minutes).

B

BIOS (Basic Input Output System) The part of your computer that controls communication between all the disk drives, monitor, keyboard, and other devices.

Boot Starting or restarting your computer. Booting your computer when the power is off is called a "cold" boot. Restarting your computer while the power is on is called a "warm" boot.

Browser A program that allows you to view Web pages and search for information on the Internet.

Byte Represents a letter or character in a computer file or memory. A byte contains eight bits.

C

CD-ROM (Compact Disc Read-Only Memory) A circular disc that stores a large amount of information (data or music).

Central Processing Unit (CPU) The microprocessor in your computer that acts as the computer's control center. Also refers to the box that holds the internal components of your computer.

Click Press a mouse button once. If not specified, assume the left mouse button.

Comp-Video In (Composite-Video In) A connector on the TV for receiving composite video from the computer.

Comp-Video Out (Composite-Video Out) A connector on the computer for sending composite video to the TV.

Connector A metal socket for a cable plug.

Control Panel A collection of utilities that help you maintain your computer including changing screen colors, and installing printers and fonts.

D

DIMM (Dual Inline Memory Module). A small circuit board to which RAM memory chips are mounted. Used to increase system memory.

Digital Camera Port A serial port on the front of the computer to which you can connect digital cameras and other serial devices (select models only).

Diskette A small, portable, magnetically coated disk used to transfer information to and from your computer. It applies to both the 5.25-inch and 3.5-inch sizes. Also known as floppy disks.

Diskette Drive A data storage device that stores and retrieves data on diskettes.

Document Information you create in any program — text, graphics or both — and then store as a separate file.

Double-Click Pressing a mouse button twice in rapid succession. Unless specified, assume the left mouse button.

Drag and Drop A two-step process. Drag by pressing and holding down the mouse button while moving the mouse. Drop by releasing the mouse button to place an item in a specific location on the screen.

Drive Bay The space that a disk drive sits in.

DVD (Digital Video Disc or Digital Versatile Disc) A high capacity storage medium similar in appearance to CD-ROM, but used for movies, software, and music (select models only).

E

Electrostatic Discharge (ESD) A sudden redistribution of static charge which can be damaging to sensitive components, such as circuit boards and diskettes.

Ergonomics An applied science concerned with understanding the interaction between people and the equipment they work with. Ergonomics also is concerned with the design of the equipment in order to optimize the efficiency and safety of the user.

Expansion Slot A connector on the mother board for placing an add-in card.

F

File A named collection of data. A file can be a program or a document.

Folder In Windows, a named area of a disk where files are stored.

G

Gigabyte (GB) Approximately one billion bytes of information.

H

Hard Disk A magnetically coated disk that acts as the computer's storage device. The hard disk is usually "fixed" in the computer and not removed.

Hardware The physical components used to operate your computer, for example: hard drive, add-in cards, and display.

HP Pavilion Library A collection of online books available on your system.

I

Icon A small graphic that represents a program or a document. Selecting an icon launches a program or opens a document.

Internet A group of computers able to communicate with each other through connections over the telephone lines or other means such as satellite, infrared, or direct cables.

ISP (Internet Service Provider) A business that provides access to the Internet, usually on a subscription basis. By dialing the ISP with a modem, a subscriber connects to the ISP's servers which have a permanent connection to the Internet.

J

Joystick An add-on device used to navigate and play games.

K

Kilobyte (KB) Approximately one thousand bytes (actually 1024 bytes) of information.

L

LED (Light Emitting Diode) A semiconductor light used on keyboards, diskette drives, and CD/DVD drives to indicate the device is in use.

M

Megabyte (MB) Approximately one million bytes of information.

Memory Generally refers to the amount of Random Access Memory (RAM) in your computer.

Menu A list of commands displayed on your screen, which allow you to perform tasks.

Menu Bar A list of menu labels that provide you with access to corresponding menus. Usually located at the top of the program window.

MIDI (Musical Instrument Digital Interface) A communications protocol to control musical instruments, including the computers synthesizers. An audio format similar to wave files.

Modem A device that uses telephone lines to connect to other computers. This device is used commonly for faxing documents and connecting to the Internet.

Motherboard The circuit board that holds the Central Processing Unit, Random Access Memory, and add-in cards.

Mouse A device that allows you to move your cursor and to point and click icons and menu options.

MPEG A type of computer movie format.

MS-DOS The Microsoft Disk Operating System.

My Computer Offers a way to view the contents of a single folder on a drive. Lets you manage the files on your computer.

Multimedia Refers to software presented in a combination of forms: graphics, text, sound and animation.

Multimedia Keyboard A keyboard with special buttons for controlling sound, playing CDs, and launching applications (select models only).

Multitasking The ability to run more than one program at a time.

O

Online Books Software documentation that can be viewed on your computer.

P

Parallel Port A connector on your computer that allows you to connect to other devices, like a printer. Also known as the LPT port.

PC Personal computer.

Program A file or set of files that contain instructions to perform a certain task (such as word processing or financial management).

R

Random Access Memory (RAM) Refers to the internal memory in your computer where data and programs reside while being executed by the CPU.

Read-Only Memory (ROM) Any type of memory that can be read but not written to. ROM also describes the chip inside your computer that holds basic information for your computer.

Recovery CD CD provided in case you accidentally lose system files or software that came with your computer.

Recycle Bin A temporary storage place for deleted documents.

S

S-Video In A connector on the TV for receiving s-video from the computer (select models only).

S-Video Out A connector on the computer for sending s-video to the TV (select models only).

Serial Port A connector on the back of the CPU for communication between the computer and other devices, such as a camera. Also known as the COM port.

Software Applications or programs that run on your computer.

Start button A button on the Windows taskbar that displays the Windows main menu.

Suspend mode A power-saving feature that you can select when you aren't going to be using your computer for awhile.

T

Task Another term for an open program or folder.

Taskbar Usually located at the bottom of the Windows desktop, the taskbar contains the Start button, buttons representing each open program or folder, and the clock. Provides an easy way to switch between programs.

U

Universal Serial Bus (USB) A type of serial interface that can connect to many different types of peripherals, such as scanners and cameras. Allows connection of multiple devices.

W

Wallpaper The background on the desktop in Windows.

Wave Files (WAV files) An audio file format.

Windows Explorer A file management program that shows the hierarchical structure of your drives and folders and allows you to access and manage the files on your system.

Regulatory and Safety Information

FCC Regulatory and Safety Information

Regulatory Information Federal Communications Commission (FCC) (USA only)

Federal Communications Commission Radio Frequency Interference Statement

⚠ Warning: *This equipment has been tested and found to comply with the limits for a Class B digital device, pursuant to Part 15 of the FCC Rules. These limits are designed to provide reasonable protection against harmful interference in a residential installation. This equipment generates, uses, and can radiate radio frequency energy and, if not installed and used in accordance with the instructions, may cause harmful interference to radio communications. However, there is no guarantee that interference will not occur in a particular installation. If this equipment does cause harmful interference to radio or television reception, which can be determined by turning the equipment off and on, the user is*

encouraged to correct the interference by one or more of the following measures:

- *reorient or relocate the receiving antenna.*
- *increase the separation between the equipment and the receiver.*
- *connect the equipment into an outlet that is on a circuit different from the receiver.*
- *consult the dealer or an experienced radio/TV technician for help.*

Hewlett-Packard's system RFI and Radiated Immunity tests were conducted with HP-supported peripheral devices and HP-shielded cables, such as those you receive with your system. Changes or modifications not expressly approved by Hewlett-Packard could void the user's authority to operate the equipment. To comply with the limits for an FCC Class B computing device, always use shielded signal cables and the shielded power cord supplied with this unit.

Consumer Information and FCC Requirements

Telephone Connection

- This equipment complies with Part 68 of the Federal Communications Commission rules. These rules permit this device to be directly connected to the telephone network. Standardized jacks are used for these connections. This equipment should not be used on party lines or coin lines.
- If this device is malfunctioning, it may also cause harm to the telephone network; this device should be disconnected until the source of the problem can be determined and until it has been repaired. If this is not done, the telephone company may temporarily disconnect your service.
- The telephone company may make changes in its technical operations and procedures. If such changes affect the compatibility or use of this device, the telephone company is required to give adequate notice of the changes.
- If the telephone company requests information on what equipment is connected to their lines, inform them of:
 - a The telephone number this unit is connected to
 - b The ringer equivalence number
 - c The USOC jack required: RJ-11C
 - d The FCC Registration Number

Items (b) and (c) are indicated on the label. The ringer equivalence number (REN) is used to determine how many devices can be connected to your telephone line. In most areas, the sum of the RENs on any one line should not exceed five (5.0). If too many devices are attached, they may not ring properly.

- In the event of equipment malfunction, all repairs should be performed by Hewlett-Packard or an authorized HP Personal Computer Dealer Repair center. It is the responsibility of users requiring service to report the problem to HP's Home Products Division, or to one of our authorized agents. Service can be obtained by calling HP's Customer Care Center at the number listed on your *HP Pavilion PC Support Path* card.

Statement of Fax Branding

The Consumer Protection Act of 1991 makes it unlawful for any person to use a computer or other electronic device to send any message via telephone fax machine, unless it clearly contains — a margin at the top or bottom of each transmitted page or on the first page of the transmission, the date and time it is sent, identification of the business or other entity, or individual sending the message, the telephone number of the sending machine or such business, entity or individual.

Canada Department of Communication (DOC) Notice

Telephone Connection

The Canadian Department of Communications label identifies certified equipment. This certification means that the equipment meets certain telecommunications network protective, operational and safety requirements. The department does not guarantee the equipment will operate to the user's satisfaction.

Before installing this equipment, the user should ensure it is permissible to connect it to the facilities of the local communications company. The equipment must be installed using an acceptable method of connection. In some cases, the company's inside wiring associated with a single line individual service may be extended by means of a certified connector assembly (telephone extension cord). The customer should be aware that compliance with the above conditions may not prevent degradation of service in some situations.

Repairs to certified equipment should be made by an authorized Canadian maintenance facility designated by the supplier. Any repairs or alterations made by the user to this equipment, or equipment malfunctions may give the telecommunications company cause to request that the user disconnect the equipment.

The user should ensure, for their own protection, that the electrical ground connections of the power utility, telephone lines and internal metallic water pipe systems, if present, are connected together. This precaution may be particularly important in rural areas.

⚠ Warning: *Users should not attempt to make such connections themselves, but should contact the appropriate electric inspection authority or electrician, as appropriate.*

⚠ Avertissement : *L'utilisateur ne devrait pas tenter de faire ces connexions lui-même mais devrait utiliser les services de l'organisme approprié d'inspection des installations électriques ou d'un électricien, selon le cas.*

⚠ Warning: *The Load Number .9 assigned to each terminal device denotes the percentage of the total load to be connected to a telephone loop; this is used by the device to prevent overloading. The termination on a loop may consist of any combination of devices, subject only to the requirement that the sum of the Load Numbers does not exceed 100.*

DOC Statement (Canada only)

This Class B digital apparatus meets all requirements of the Canadian Interference-Causing Equipment Regulations.

Cet appareil numérique de la classe B respecte toutes les exigences du Règlement sur le matériel brouilleur du Canada.

Energy Star Compliance

Hewlett-Packard Pavilion PCs and monitors marked with the Energy Star logo comply with the U.S. Environmental Protection Agency's Energy Star guidelines for energy efficiency. For information on changing power management features, refer to "Using the BIOS Setup Program" in the *Getting Help* guide.

Declaration of Conformity

According to ISO/IEC Guide 22 and EN 45014

Manufacturer's Name: Hewlett-Packard Company
Manufacturer's Address: 10500 Ridgeview Ct.
Cupertino, CA 95015-4010
USA

declares, that the product

Product Name: HP Pavilion Multimedia Computer System
Model Number(s): 6XXX Y (X is any number 0-9, Y is any alphanumeric character or blank)
Product Options: All

conforms to the following Product Specifications:

Safety: IEC 950:1991 + A1, A2, A3, A4/EN 60950:1992 + A1, A2, A3, A4
EN 41003:1993

EMC: CISPR 22:1993 / EN 55022:1994 - Class B¹⁾
EN 50082-1:1992 - Generic Immunity
IEC 801-2:1991/prEN 55024-2:1992 - 4 kV CD, 8 kV AD
IEC 801-3:1984/prEN 55024-3:1991 - 3V/m
IEC 801-4:1988/prEN 55024-4:1992 - 0.5 kV Signal Lines,
1 kV Power Lines
FCC Title 47 CFR, Part 15 Class B²⁾/ICES-003, Issue 2
AS/NZS 3548:1992/CISPR 22:1993 Class B¹⁾

Supplementary Information:

The product herewith complies with the requirements of the following Directives and carries the CE marking accordingly.

- the EMC Directive 89/336/EEC (including 93/68/EEC)
- the Low Voltage Directive 73/23/EEC (including 93/68/EEC)

- 1) The Product was tested in a typical configuration with Hewlett-Packard Personal Computer peripherals.
- 2) This Device complies with Part 15 of the FCC Rules. Operation is subject to the following two conditions: (1) this device may not cause harmful interference, and (2) this device must accept any interference received, including interference that may cause undesired operation.
Quality Manager
Cupertino, CA May 1998

For Regulatory Compliance Information ONLY, contact:

Australian Contact: Product Regulations Manager
Hewlett-Packard Australia Ltd.
31-41 Joseph Street
Blackburn, Victoria 3130, Australia

European Contact: Your local Hewlett-Packard Sales and Service Office or
Hewlett-Packard GmbH
Department HQ-TRE Standards Europe
Herrenberger StraBe 130
D-71034 Boblingen
(FAX: + 49-7031-14-3143)

USA Contact: Quality Manager,
Hewlett-Packard
HPD
10500 Ridgeview Ct.,
Cupertino, CA 95015-4010
(Phone: 408-343-5000)

Additional Safety Information

This product has not been evaluated for connection to an “IT” power system (an AC distribution system with no direct connection to earth, according to IEC 950).

AC Power Safety Warning

Locate the computer near an AC outlet. The AC power cord is your HP Pavilion PC's main AC disconnecting device and must be easily accessible at all times. For your safety, the power cord provided with your system has a grounded plug. Always use the power cord with a properly grounded wall outlet, to avoid the risk of electrical shock.

To reduce the possibility of an electric shock from the telephone network, plug your computer into the AC outlet before connecting it to the telephone line. Also, disconnect the telephone line before unplugging your computer from the AC power outlet.

⚠ Warning: *Always disconnect the modem cord from the telephone system when installing or removing your computer cover.*

⚠ Attention : *Debrancher la carte modem du reseau telephonique lors de l'installation les couvercles de l'appareil hote sont enleves.*

⚠ Warnings: *The power supply is not user-serviceable. To prevent damage to the power supply, have a qualified person repair or replace it. All other components are user-serviceable.*

You must disconnect all power cords, telecommunications links, networks, and modems before working on the computer.

Do not operate the computer with the cover removed.

Electrostatic discharge (ESD) can damage disk drives, add-in cards, and other components. If an ESD station is not available, wear a wrist strap attached to a metal part of the computer. Place cards on a conductive foam pad, if possible, but never on the card wrapper.

For your safety, always unplug the system from its power source and from any telecommunications systems (such as phone lines), networks, or modems before performing any of the procedures described in this chapter. Failure to do so may result in personal injury or equipment damage. Hazardous voltage levels are inside the power supply and modem of this product.

⚠ Avertissements : *Le bloc d'alimentation n'est pas réparable par l'utilisateur. Pour éviter d'endommager le bloc d'alimentation, confiez-le à un technicien pour réparation ou remplacement. Tous les autres composants peuvent être changés ou réparés par l'utilisateur.*

Vous devez débrancher les cordons d'alimentation, les liaisons de télécommunications, les liaisons réseau et les modems avant de travailler dans l'ordinateur.

N'utilisez pas l'ordinateur lorsque le capot est enlevé.

Des décharges électrostatiques peuvent endommager les unités de disque, cartes d'expansion et autres composants. Si vous ne disposez pas d'une station de protection contre les décharges électrostatiques, portez un bracelet antistatique relié à une partie métallique de l'ordinateur. Placez les cartes sur un tapis en mousse conducteur, mais ne les posez jamais sur leur emballage.

Pour plus de sécurité, débranchez toujours le système de sa source d'alimentation, de tout système de télécommunications (comme les lignes téléphoniques), des réseaux et des modems avant d'exécuter l'une des procédures décrites dans ce chapitre. Si vous ne respectez pas ces consignes, vous risquez de vous blesser et de causer des dommages matériels. Des niveaux de tension dangereux se trouvent à l'intérieur du bloc d'alimentation et du modem de ce produit.

Lithium Battery Caution

⚠ Warning: *There is danger of an explosion if the battery is incorrectly replaced. Replace only with the same, or equivalent, type recommended by the manufacturer. Dispose of used batteries according to the manufacturer's instructions.*

⚠ Attention : *Il y a danger d'explosion s'il y a remplacement incorrect de la batterie. Remplacer uniquement avec une batterie du meme type ou d'un type equivalent recommandé par le constructeur. Mettre au rebut les batteries usagées conformément aux instructions du fabricant.*

Laser Safety Statement

Class 1 LED Product.

The CD-ROM and DVD drives contain a laser system and are classified as a “Class 1 Laser Product” under a U.S. Department of Health and Human Services (DHHS) Radiation Performance standard according to the Radiation Control for Health and Safety Act of 1968.

Should the unit ever require maintenance, contact an authorized service location.

⚠ Warning: *Use of controls, adjustments, or performance procedures other than those specified in the HP Pavilion PC User's Guide may result in hazardous radiation exposure. To prevent direct exposure to laser beam, do not try to open the enclosure of the CD-ROM or DVD.*

⚠ Avertissement : *L'utilisation de commandes, réglages ou procédures de performance autres que ceux spécifiés dans le Guide de l'utilisateur de l'ordinateur HP Pavilion peut entraîner une exposition à des radiations. Afin d'éviter une exposition directe au rayon laser, ne tentez pas d'ouvrir le boîtier du lecteur de CD-ROM ou DVD.*

TV Antenna Connectors Protection

External Television Antenna Grounding

If an outside antenna or cable system is connected to the product, be sure the antenna or cable system is electrically grounded so as to provide some protection against voltage surges and built-up static charges. Article 810 of the National Electrical Code, ANSI/NFPA 70, provides information with regard to proper electrical grounding of the mast and supporting structure, grounding of the lead-in wire to an antenna-discharge unit, size of grounding conductors, location of antenna-discharge unit, connection to grounding electrodes, and requirements for the grounding electrode.

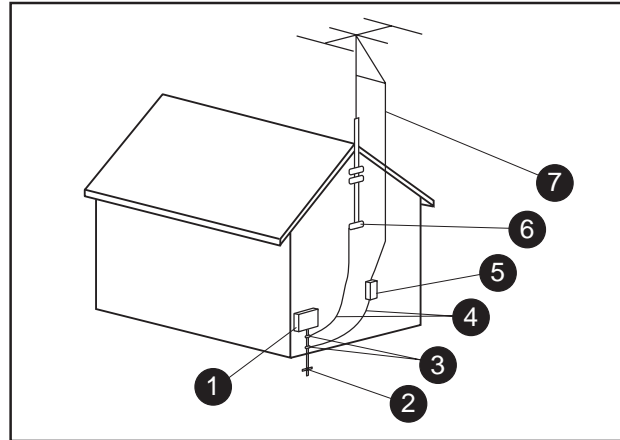

Antenna Grounding

Antenna Grounding

| Reference | Grounding Component |
|-----------|--|
| ① | Electric Service Equipment |
| ② | Power Service Grounding Electrode System (NEC Art 250, Part H) |
| ③ | Ground Clamps |
| ④ | Grounding Conductors (NEC Section 810-21) |
| ⑤ | Antenna Discharge Unit (NEC Section 810-20) |
| ⑥ | Ground Clamp |
| ⑦ | Antenna Lead in Wire |

Lightning Protection

For added protection of any Hewlett-Packard product during a lightning storm, or when it is left unattended and unused for long periods of time, unplug the product from the wall outlet and disconnect the antenna or cable system. This will prevent damage to the product due to lightning and power line surges.

Power Lines

An outside antenna system should not be located in the vicinity of overhead power lines or other electric light or power circuits, or where it can fall into such power lines or circuits.

⚠ Warning: *When installing an outside antenna system, extreme care should be taken to keep from touching such power lines or circuits as contact with them could be fatal.*

⚠ Avertissement : *Lorsque vous installez une antenne extérieure, vous devez faire attention à ne pas toucher ces lignes et circuits d'alimentation, tout contact pouvant être mortel.*

Index

A

Add/Remove Programs utility, 43
add-in cards, defined, 57
adding software, 43
Auto Suspend feature, 28
 defined, 57

B

BIOS, defined, 57
browsers, 28, 39, 49, 50
 defined, 57

C

CD-ROM drive, 34
CDs
 caring for, 34
 defined, 57
 inserting in CD-ROM drive, 34
 playing music CDs, 35
 using program CDs, 35
chair, 7

Channel bar, 54
composite video, defined, 57
computer
 setting up, 3–23
 suspending, 27
 turning on and off, 2, 26
Control Panel, defined, 58

D

deleting software, 43
desktop
 learning about, 38
 removing Channel bar from, 54
Digital Camera Port, defined, 58
DIMM, defined, 58
diskettes, working with, 32
document holders, 16

E

Easy Internet Access, 39, 48, 49, 50
e-mail, sending and receiving, 50

F

faxes
 sending and receiving, 55
 Suspend mode and, 28
finding files, 42
formatting diskettes, 33

H

hardware help, 45
headphones, 20, 31
help. See also Getting Help guide
 getting hardware help, 45
 getting software help, 45
 mouse tutorial, 31
HP At Home Web site, 50
HP Message Board, 51
HP Support Center, 36, 39, 41, 44

I

Information button, 29
Internet access, 28, 39, 41, 48
Internet button, 28, 48, 49, 50
Internet, defined, 59
ISP, defined, 59

K

keyboard, 17, 28
keyboard buttons, 28
keyboard messages, 30

L

lighting, 10

M

Media Rack, 35
messages
 e-mail messages, 50–51
 HP Message Board, 51
modem, 36
 defined, 60
monitor, 13
mouse, 19, 30

mouse tutorial, 2, 31
MPEG videos, playing, 35
music CDs, playing, 35

P

Pavilion Library, 45
 defined, 59
Personal Guide, 39, 40
playing music CDs, 35
posture, 11
preinstalled software, 39, 41
problems. *See your Getting Help guide*
programs. *See software*

Q

QuickLink software, 55

R

receiving e-mail, 51
receiving faxes, 56
registering with HP, 2
regulatory information, 63–67
removing software, 43
repetitive strain injury (RSI), 3–4

S

safety information, 21, 68–70
screen. *See monitor*
sending e-mail, 51
sending faxes, 55
setting up your computer, 13–23
shutting down computer, 26
software
 adding new programs, 43
 defined, 61
 deleting, 43
 getting help for, 45
 preinstalled software, 39, 41
sound, adjusting, 35
speakers, 20, 31
specifications
 for monitor use, 15
 for work environment, 10
starting computer, 2, 26
Suspend mode, 27, 28
Suspend mode, defined, 61
S-Video, defined, 61
system maintenance, 45
system tools, 45

T

turning computer on and off, 2, 26
tutorials, 45

U

Universal Serial Bus, defined, 61

V

videos, playing MPEG, 35
volume, adjusting, 35

W

WAV files, defined, 61
Web browsers. *See* browsers
Windows desktop. *See* desktop
workspace, setting up, 6
World Wide Web, 27. *See also* Internet
access

5967-2947