

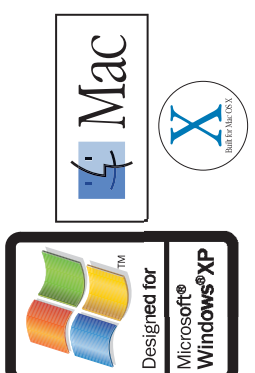



Q3093-90172



1 Wired/Wireless Network Start Here - CHOOSE CORRECT POSTER



Designed for Microsoft® Windows® XP

a Choose the one poster that matches your equipment.

If you have an existing **Windows or Macintosh Network** setup, follow this poster.

If you do not have a network, see the Direct Connect(USB) poster.



Wired Network



Wireless Network

b Remove all items from the carton. Remove all tape and packaging from the HP PSC.

2 Attach cover and lift display

a Place the cover over the top of the HP PSC. Make sure the buttons are visible.

b Firmly press down on all sides of the cover.

c Lift display.

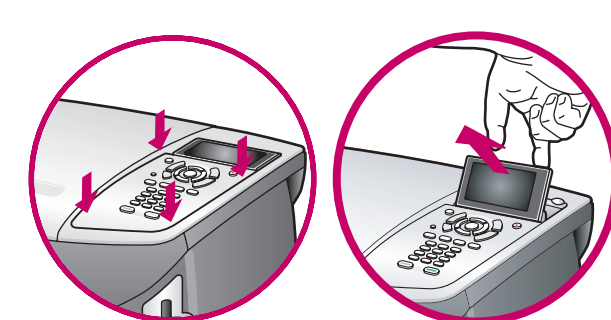

3 Remove tray and load plain white paper

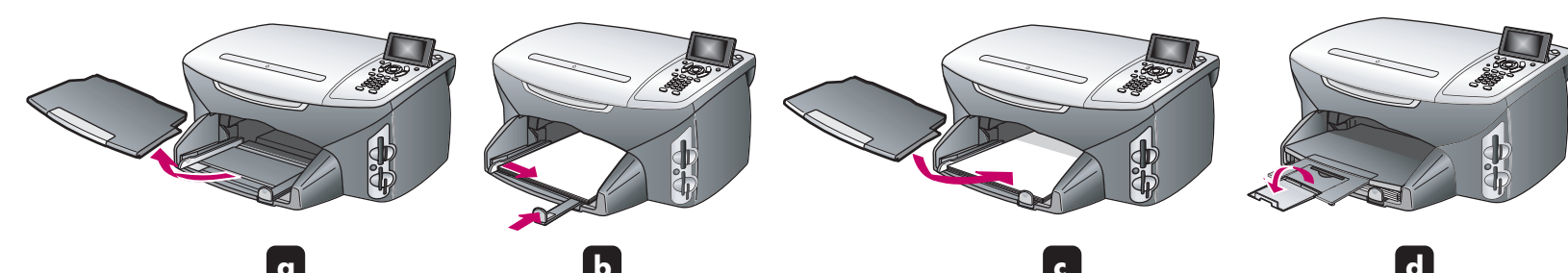

4 Connect power cords

Connect the power supply to the HP PSC, and then to the power cord. Plug into the wall.

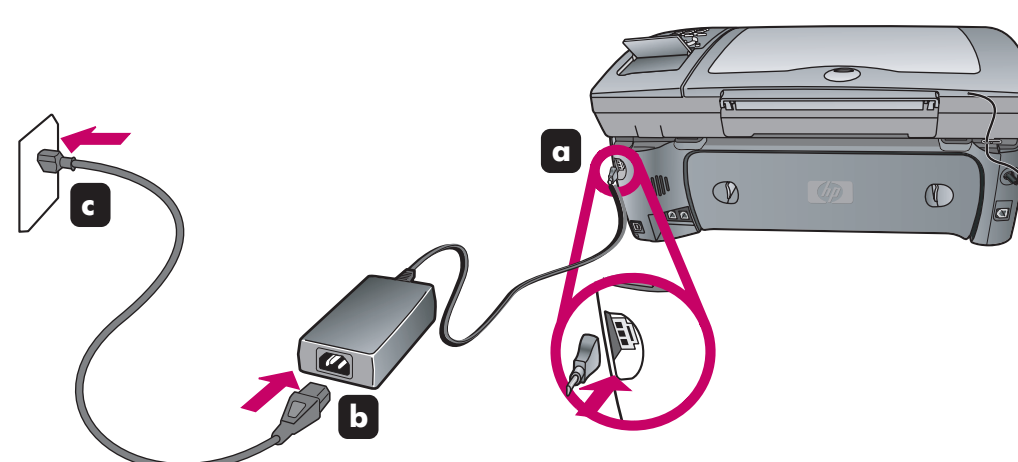

5 Connect supplied phone cord

a You must connect one end of the supplied phone cord to the phone jack on the left (1-LINE) and the other end to a wall jack.

b To connect an answering machine or use your own phone cord, see the **Fax Setup** chapter in the **Reference Guide**.

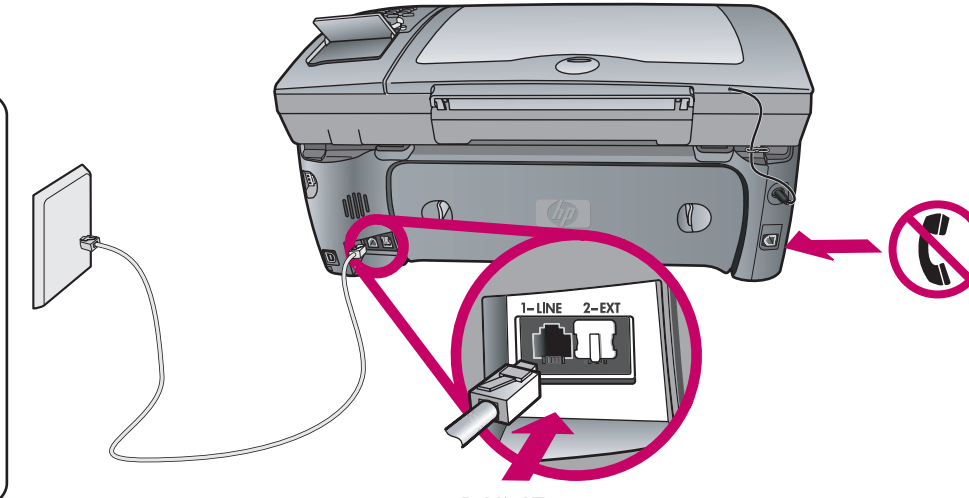

6 Turn on and set language and country/region

a Turn power on.

b Select your language, and then press **OK**. Select your country/region, and then press **OK**.

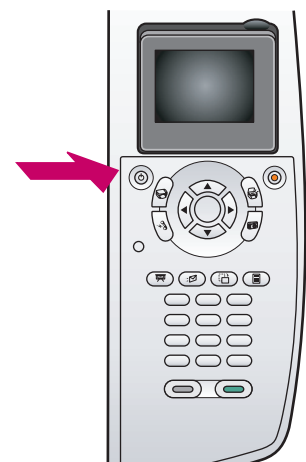

7 Insert print cartridges

a Lift the print carriage door up until it catches. Lift the blue and gray latches.

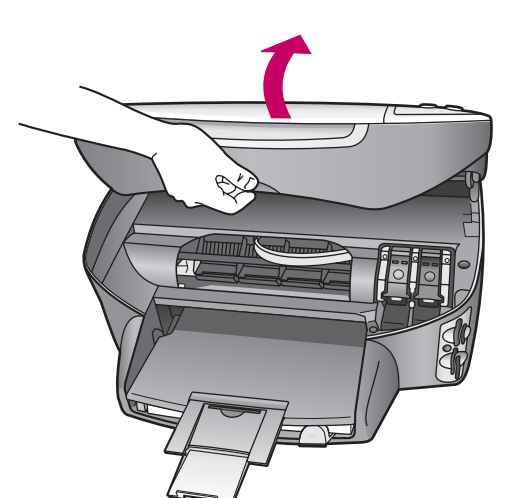

b Remove the bright pink tape from both the print cartridges. Do not touch the gold-colored contacts or retape the cartridges.

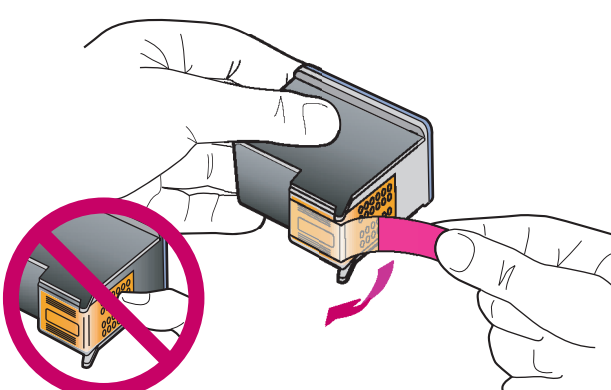

c Hold the black print cartridge with the label on top as shown. Slide the cartridge underneath the metal bar into the right (gray latch) side of the print carriage.

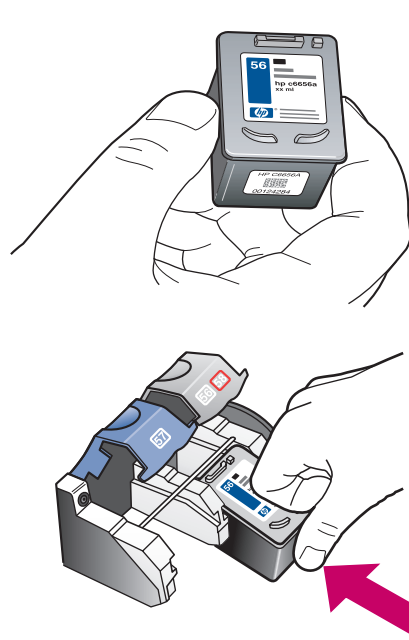

d Hold the color print cartridge with the label on top as shown. Slide the cartridge into the left (blue latch) side of the print carriage.

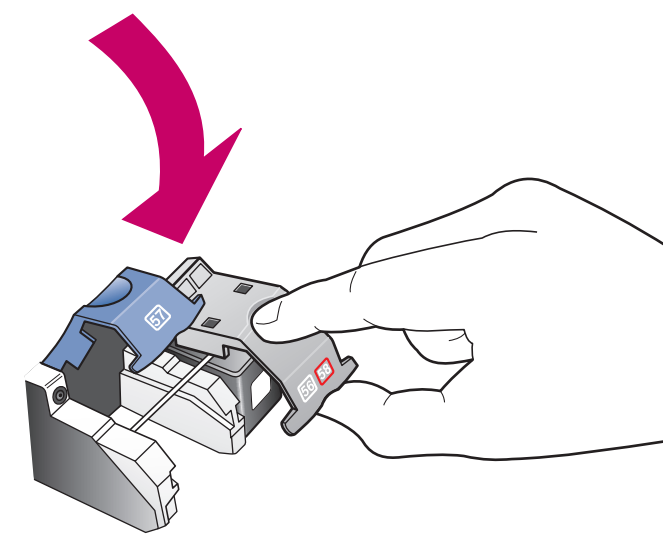

e Pull the end of the gray latch toward you, press down until it stops, and then release. Make sure the latch catches below the bottom tabs. Repeat with the blue latch.

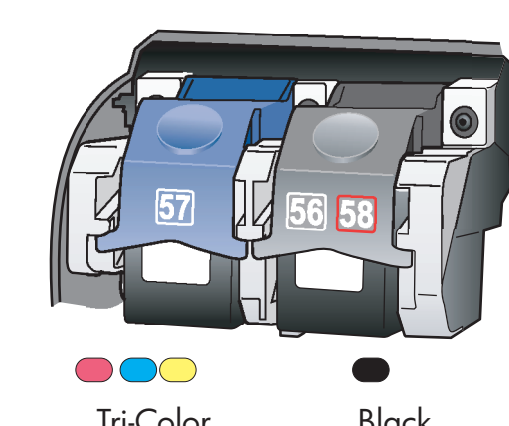

f Make sure both latches are locked into position. Close the door.

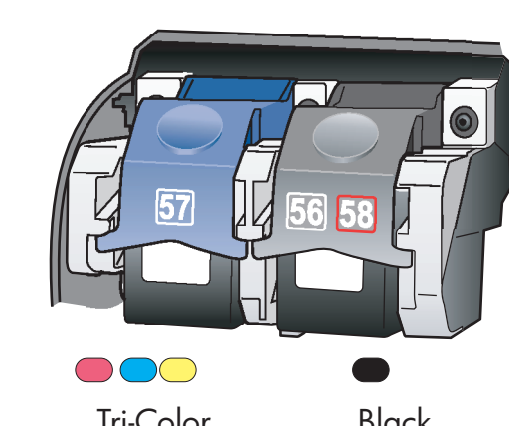

8 Align the print cartridges

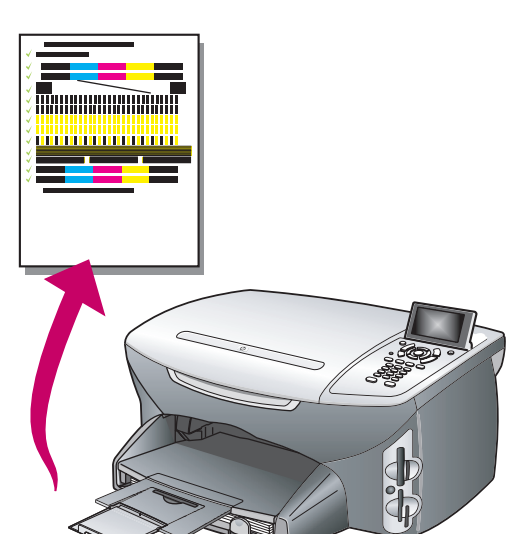

Press **OK** on the front panel to begin alignment. Wait a couple of minutes. After a page prints, alignment is complete. Discard or recycle this page.

9 Choose Wired or Wireless setup*

Match the network type to your existing network.

If you do not have an existing network, set one up before attempting to connect the HP PSC.

Choose a or b, and then turn the poster over.

a **Wired network**

Requirements:

- Router/hub/switch
- ETHERNET (CAT-5) cable

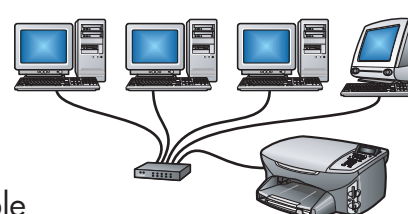

Go to step 10a to set up with a wired network.

b **Wireless network (infrastructure)**

Requirements:

- Wireless access point/gateway/base station
- ETHERNET (CAT-5) cable

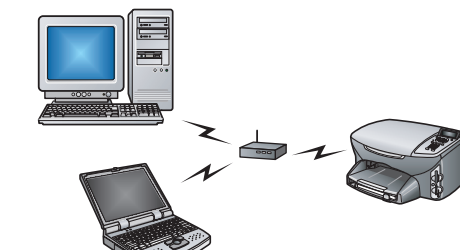

Go to step 10b to set up with a wireless network.

Wireless Information:

WPA - If your wireless network uses WPA, configure this on the HP PSC before you install the software. For details see the **Reference Guide, chapter 15, Wireless Network Setup, use the embedded web server.**

Compatibility with 802.11g - This HP PSC includes an 802.11b radio that is compatible on 802.11g systems.

*If you have a different network setup, see the **Reference Guide**.

To set up with a USB cable, please see the other poster for a direct connection (install the software before connecting the USB cable).

10a Wired network setup

Wired setup allows your HP PSC to communicate to your computers through a router/hub/switch.

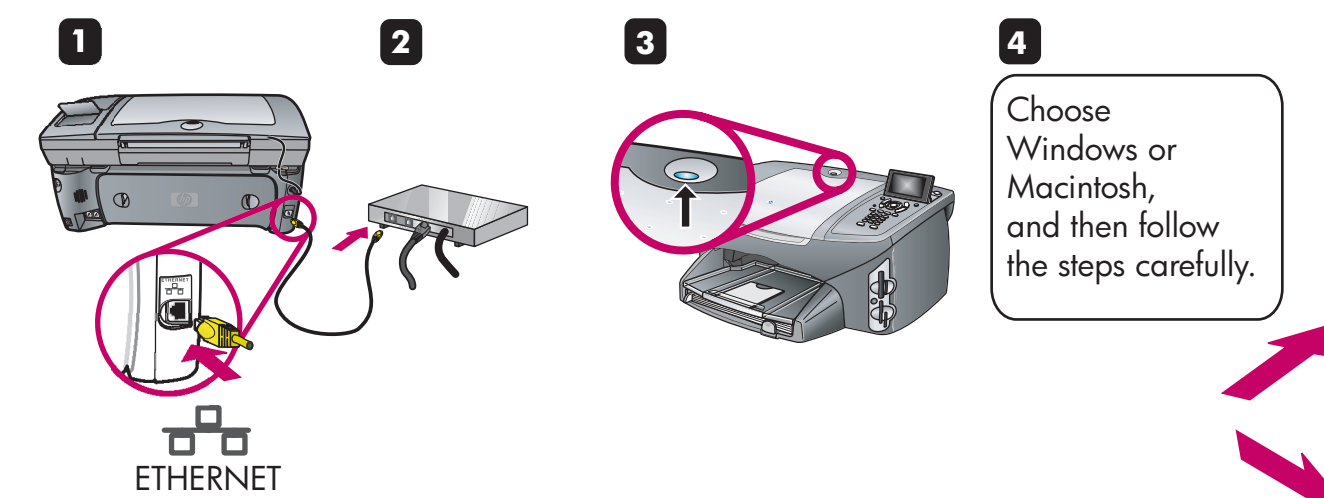
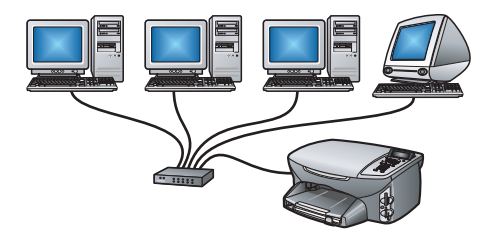

- 1** Remove the yellow plug from the ETHERNET jack. Connect the ETHERNET cable to the back of the HP PSC.
- 2** Connect the ETHERNET cable to the hub/router/switch.
- 3** STOP! Make sure the **blue network light** on the HP PSC is lit. This might take 60 seconds.

NOTE: You can use the cable from the box or purchase a longer cable.

If you have any questions, see the **Wired Network Setup** chapter in the **Reference Guide**.

Follow these boxed steps for each computer that is part of the wired network.

<p>WINDOWS USERS:</p>	<p>5 Turn on your computer and wait for the desktop to appear.</p> <p>Make sure you are logged onto the network.</p> <p>Disable any firewall software.</p>	<p>6 Insert the HP PSC Windows CD and then, follow the onscreen instructions.</p>	<p>7 Choose Through the network as your connection type.</p>	<p>8 Choose the second option, connect using a network cable as your connection type.</p>	<p>9 Complete the rest of the onscreen instructions.</p>	<p>10 After your computer restarts, follow all onscreen instructions including the Fax Setup Wizard.</p>	<p>11 Congratulations! You are ready to use the HP PSC.</p>
<p>MACINTOSH USERS:</p>	<p>5 Turn on your computer and wait for the desktop to appear.</p> <p>Make sure you are logged onto the network.</p> <p>Disable any firewall software.</p>	<p>6 Insert the HP PSC Macintosh CD.</p>	<p>7 Double-click the HP All-in-One Installer icon on your folder.</p>	<p>8 In the first dialog box, you must select Network as the device connection type.</p>	<p>9 Choose wired network as your connection type.</p>	<p>10 Complete all onscreen instructions including the Setup Assistant. In the Select Device dialog box, make sure TCP/IP (network) is selected.</p>	<p>11 Congratulations! You are ready to use the HP PSC.</p>

10b Wireless network setup (infrastructure)

Wireless setup allows your HP PSC to communicate to your computers through a wireless access point or base station.

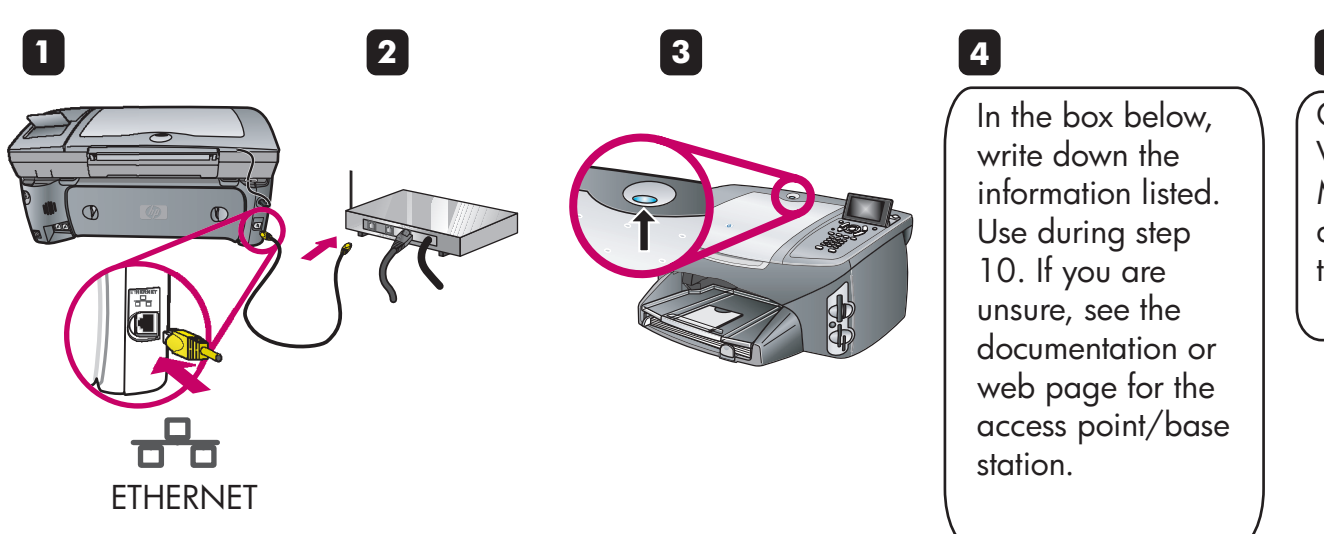
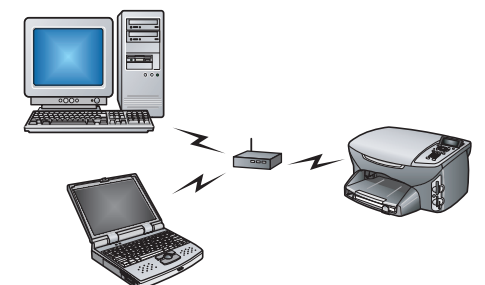

- 1** Remove the yellow plug from the ETHERNET jack. Connect the ETHERNET cable to the back of the HP PSC.
- 2** Connect the ETHERNET cable to the access point. (You will remove this later.)
- 3** STOP! Make sure the **blue network light** on the HP PSC is lit. This might take 60 seconds.

4 In the box below, write down the information listed. Use during step 10. If you are unsure, see the documentation or web page for the access point/base station.

SSID /Network Name:

WEP Key/Password (if applicable):

For Macintosh, this is called Network Name and Password.

If you have any questions, see the **Wireless Network Setup** chapter in the **Reference Guide**.

Follow these boxed steps for each computer that is part of the wireless network.

<p>WINDOWS USERS:</p>	<p>6 Turn on your computer and wait for the desktop to appear.</p> <p>Make sure you are logged onto the network.</p> <p>Disable any firewall software.</p>	<p>7 Insert the HP PSC Windows CD and then, follow the onscreen instructions.</p>	<p>8 Choose Through the network as your connection type.</p>	<p>9 Choose connect using wireless communication as your connection type.</p>	<p>10 Complete the rest of the onscreen instructions. Enter the information you wrote down earlier.</p> <p>Make sure the blue network light is steady. Refer to the Reference Guide for help.</p>	<p>11 When you see the Unplug Cable dialog box, disconnect the cable from your HP PSC and access point.</p>	<p>12 After your computer restarts, complete all onscreen instructions including the Fax Setup Wizard.</p> <p>Congratulations! You are ready to use the HP PSC.</p>
<p>MACINTOSH USERS:</p>	<p>6 Turn on your computer and wait for the desktop to appear.</p> <p>Make sure you are logged onto the network.</p> <p>Disable any firewall software.</p>	<p>7 Insert the HP PSC Macintosh CD.</p>	<p>8 In the first dialog box, you must select Network as the device connection type.</p>	<p>9 Choose wireless network as your connection type.</p>	<p>10 Enter the information that you wrote down earlier.</p> <p>Make sure the blue network light is steady. Refer to the Reference Guide for help.</p>	<p>11 Complete all onscreen instructions including the Setup Assistant. In the Select Device dialog box, make sure TCP/IP (network) is selected.</p>	<p>12 Congratulations! You are ready to use the HP PSC.</p>