



RM500SL REAL-EAR HEARING AID ANALYZER

USER'S GUIDE

Version 2.8

ã November 2006

Table of Contents

1	About RM500SL	6
1.1	Section overview	6
1.2	New in this software release	7
1.3	Electronic user's guide	7
1.4	Warranty, Trademarks, Acknowledgements	8
1.5	Notices for the European Community	9
1.6	Declaration of EMC compliance for the European Community	9
2	Getting Started	10
2.1	Section overview	10
2.2	Unpacking and connecting	10
2.3	Microphone connection	11
2.4	Microphone care	12
2.5	Battery pill use and care	12
2.6	Mouse, keyboard, barcode scanner	13
2.7	External printer, auxiliary audio outputs	14
3	General Operation	14
3.1	Section overview	14
3.2	Input device operation	15
3.3	Barcode data input	16
3.4	Keypad keys	17
3.5	Menus, lists and buttons	18
3.6	Screen messages	19
3.7	Program memory removal and replacement	19
3.8	Software updating	20
4	General Setup	20
4.1	Section overview	20
4.2	Date and time setup	20
4.3	Display settings	21
4.4	Saving test setup	21
5	Networking	22
5.1	Section overview	22
5.2	Networking requirements	22
5.3	Networking setup	23
5.4	Single computer connection	24
6	Printing and Storing Results	25
6.1	Section overview	25
6.2	Internal printer paper loading	26
6.3	Barcodes, headers and comments on printouts	27
6.4	Local printer setup	27
6.5	Printing to a USB memory stick	28
6.6	Network printer setup	29

6.7	Printing to a network file	30
6.8	Data storage to a network file	30
7	Hearing Instrument Tests Setup.....	31
7.1	Section overview	31
7.2	HIT A or B display	31
7.3	Graph or table format	31
7.4	Output or gain scale	31
7.5	Hide or Show HIT curves.....	32
7.6	1996 or 2003 ANSI standard	32
7.7	ANSI test frequencies.....	32
7.8	HIT calibration facts	33
7.9	Calibration of HIT reference microphone	34
7.10	Calibration check for coupler microphone	35
7.11	Coupling the hearing instrument.....	36
7.12	Positioning the hearing instrument.....	37
8	ANSI S3.22 Hearing Aid Tests.....	38
8.1	Section overview	38
8.2	ANSI S3.22-1996 facts.....	38
8.3	ANSI S3.22-2003 facts.....	39
8.4	ANSI 1996 Linear and AGC tests	39
8.5	ANSI 2003 Linear and AGC tests	40
8.6	ANSI test results	41
8.7	ANSI input-output curves.....	42
8.8	ANSI telecoil terminology	43
8.9	ANSI telephone simulator (TMFS) test	44
8.10	Telecoil test results	45
9	Other Hearing Instrument Tests	46
9.1	Section overview	46
9.2	Harmonic distortion	46
9.3	Multicurve procedure.....	47
9.4	Multicurve results	47
9.5	Spectral analysis in Multicurve	48
9.6	Battery drain test.....	48
9.7	Manual control procedure.....	49
9.8	Sound level meter using manual control	49
10	Real-Ear Measurement Setup.....	50
10.1	Section overview	50
10.2	REM calibration facts	50
10.3	Calibration of REM probe microphone	51
10.4	Calibration check for probe module	52
10.5	Max TM SPL setup.....	53
10.6	ABR nHL to eHL setup.....	53

10.7	Positioning the client	54
10.8	Positioning the probe tube	54
11	REM Screen Setup	55
11.1	Section overview	55
11.2	REM right or left ear display	55
11.3	Graph, table or 2cc target format	55
11.4	SPL or HL scale	56
11.5	Hide or show REM curves	56
12	REM Manual Control	56
12.1	Section overview	56
12.2	Manual control measurements	57
12.3	Sound level meter using REM probe	57
13	Sensory Loss Simulator	58
13.1	Sensory loss simulator description	58
13.2	Sensory loss simulator operation	58
14	Occlusion Effect Test.....	59
14.1	Occlusion effect measurement.....	59
15	RECD (real-ear to coupler difference).....	60
15.1	Section overview	60
15.2	RECD facts	60
15.3	RECD coupler response.....	61
15.4	RECD real-ear response	62
15.5	RECD results	63
16	Insertion Gain.....	64
16.1	Section overview	64
16.2	Insertion gain in SPL.....	64
16.3	Insertion gain in HL	65
16.4	Audiometric data entry	66
16.5	REUR measurement procedure.....	67
16.6	REAR measurement procedure.....	68
16.7	SII calculation in Insertion gain	69
17	Speechmap ®.....	70
17.1	Section overview	70
17.2	Speechmap facts	70
17.3	DSL 5.0 in Speechmap	71
17.4	DSL 5.0 changes	72
17.5	NAL-NL1 in Speechmap.....	72
17.6	Using Speechmap.....	73
17.7	Screen tour – unaided screen.....	74
17.8	Screen tour - aided screen	74
17.9	REM or S-REM mode.....	75
17.10	SII calculation in Speechmap	76

18	Speechmap Fitting Procedures.....	77
18.1	Section overview.....	77
18.2	Assessment data entry.....	77
18.3	Assessment data choices - 1.....	78
18.4	Assessment data choices - 2.....	79
18.5	Fitting to targets for soft speech.....	80
18.6	Fitting to targets for loud sounds.....	81
18.7	Fitting to targets for mid-level speech.....	82
18.8	Open fittings in Speechmap.....	82
18.9	FM fitting and verification.....	83
19	Speechmap Technical Details.....	84
19.1	Section overview.....	84
19.2	Speechmap stimuli.....	84
19.3	Stimulus levels.....	85
19.4	Microphone location effects.....	86
19.5	Speech signal analysis.....	87
20	Troubleshooting.....	88
20.1	Section overview.....	88
20.2	Self test failures.....	88
20.3	HIT high distortion or noise.....	89
20.4	HIT curves inconsistent.....	89
20.5	HIT curves differ from specifications.....	90
20.6	HIT speaker overdriven.....	90
20.7	No HIT reference mic. detected.....	90
20.8	Invalid HIT calibration.....	91
20.9	No REM ref. mic. detected.....	91
20.10	Invalid REM calibration.....	91
20.11	REM speaker overdriven.....	92
20.12	Barcode scanner malfunction.....	92
21	Technical Specifications.....	93
22	Glossary.....	94
23	References.....	98
24	Appendix 1: AudioNote 2.1 VERIFIT and RM500SL Test Signals and Analysis.....	101

The Audioscan® RM500SL User's Guide Version 2.8



1 About RM500SL

1.1 Section overview

This section provides a listing of features **new in this software release**, instructions for **accessing the electronic User's Guide**, contact, **warranty** and trademark information, and **notices** for the **European Community**.

Help is available on the following topics by pressing <Help>

- | | |
|-----------------------------------|---|
| 2: Getting Started | 12: REM Manual Control |
| 3: General Operation | 13: Sensory Loss Simulator |
| 4: General Setup | 14: Occlusion Effect Test |
| 5: Networking | 15: RECD (real-ear to coupler difference) |
| 6: Printing and Storing Results | 16: Insertion Gain |
| 7: Hearing Instrument Tests Setup | 17: Speechmap® |
| 8: ANSI S3.22 Hearing Aid Tests | 18: Speechmap Fitting Procedures |
| 9: Other Hearing Instrument Tests | 19: Speechmap Technical Details |
| 10: Real-Ear Measurement Setup | 20: Troubleshooting |
| 11: REM Screen Setup | |

In addition you will find a glossary, references and more information in the electronic user's guide on the Audioscan software CD.

FastFacts 1.1: RM500SL Help topics

1.2 New in this software release

Software 2.8 introduces the following significant additions and changes:

- 1) A **Sensory Loss Simulator** (SLS) which provides an accurate simulation of cochlear hearing loss for parents, teachers and others to experience.
- 2) **DSL® 5**, which provides targets for adults, allowances for ABR and bone conduction thresholds and speech targets for the stimulus level selected. (**Note that targets do not appear until an REAR test has been started.**)
- 3) **Open Fitting** protocol in Speechmap which can be used to fit instruments with large vents or open ear molds.
- 4) A **new** calibrated **speech passage** to augment the “carrots” passage.
- 5) Screen images and test data may be saved to files on a **USB memory stick**.
- 6) Support for **PostScript** printers, including **color laser printers**.
- 7) **Realtime rms levels** for broadband signals like speech and pink noise.
- 8) The **Scroll wheel** on a mouse may be used to traverse long lists and Help.
- 9) **RECD measurements** are now less sensitive to ambient noise.
- 10) **MPO** tone bursts have been lengthened to 128ms for better correlation with loudness perception.
- 11) **Input-Output** screens now have a cursor readout. Left click on any graph.
- 12) **New calibration & equalization** signals improve accuracy and noise rejection.
- 13) **Speech level** now goes down to 50dB SPL.
- 14) **Hatching legends** and curve numbers are shown on printouts for better identification on black and white printouts.

Please consult the relevant section of this User's Guide or Help for more details.

FastFacts 1.2: New in this software release

1.3 Electronic user's guide

A printable user's guide is on the Audioscan CD-ROM supplied with a new instrument or mailed as a software update. A .pdf file viewer, such as Acrobat Reader (5.0 or higher) or Foxit Reader is required to view the User's Guide. Foxit Reader is supplied on the CD-ROM.

- 1) Insert the CD-ROM into the CD drive on your computer.
- 2) Select My Computer, then the CD drive and the User's Guide folder.
- 3) To install Foxit Reader, copy FoxitReader.exe to an appropriate location on your PC. To run FoxitReader.exe double click it.
- 4) To view the User's Guide, double-click the RM500SLUsersGuide.pdf file.

The User's Guide may also be downloaded from www.audioscan.com.

FastFacts 1.3: Electronic users guide

1.4 Warranty, Trademarks, Acknowledgements

The **Audioscan RM500SL** is manufactured by Etymonic Design Inc.,
41 Byron Ave., Dorchester, Ontario, Canada N0L 1G0.

Phone: 800-265-2093 (USA only); 519-268-3313 **Fax:** 519-268-3256
www.audioscan.com **Email:** info@audioscan.com or service@audioscan.com

Warranty: The RM500SL is warranted against defects for two years from date of purchase. Within this period, it will be repaired without charge for parts, labor or return shipping when returned prepaid to your authorized Audioscan service agent. **This warranty does not apply to battery substitutes (pills)**, which carry a 90 day warranty, or to equipment that, in our sole judgement, has been subject to misuse, or unauthorized alteration or repair.

Trademarks: Audioscan, Verifit, Speechmap and Quikscan are registered trademarks of Etymonic Design Inc. DSL is a registered trademark of The University of Western Ontario. HP LASERJET is a registered trademark of Hewlett-Packard Company. IBM is a registered trademark of International Business Machines Corporation. K-AMP is a registered trademark of Etymotic Research Inc. KEMAR is a registered trademark of Knowles Electronics Inc. QUEST is a trademark of Quest Technologies Inc. PostScript is a registered trademark of Adobe Systems, Inc.

Acknowledgements: In addition to the contributions of our entire staff, we acknowledge the support received from past and present staff at the National Centre for Audiology at the University of Western Ontario in implementing the DSL method. DSL 5.0 is used under license from the University of Western Ontario (UWO). We are indebted to the University of Memphis Hearing Aid Research Laboratory for permission to use some of their recorded speech material.

FastFacts 1.4: Warranty, trademarks, acknowledgements

1.5 Notices for the European Community

Authorised Audioscan representative within the European Community:
 PC Werth Ltd., Audiology House, 45 Nightingale Lane, London SW12 8SP UK
 Phone: +44 (0)20 8772 2700 www.pcwerth.co.uk

Electromagnetic Compatibility (EMC)

Medical electrical equipment needs special precautions regarding EMC and needs to be installed and put into service according to the following information:

- ✓ The RM500SL should not be used adjacent to or stacked on other equipment. If this is necessary, its operation should be verified as normal in this configuration.
- ✓ Portable and mobile RF communications equipment can affect medical electrical equipment and may affect the performance of the RM500SL.
- ✓ The RM500SL has not been tested for immunity to electromagnetic disturbances. Performance degradation due to such disturbances (including electrostatic discharge) is considered normal and acceptable.

FastFacts 1.5: Notices for the European Community

1.6 Declaration of EMC compliance for the European Community

The compliances listed in the following table are met with the Audioscan SL-100 RECD transducer connected. The use of other accessories may result in increased emissions.

Guidance and manufacturer's declaration - electromagnetic emissions		
The RM500SL is intended for use in the electromagnetic environment specified below. The user of the RM500SL should assure that it is used in such an environment.		
<u>Emissions test</u>	<u>Compliance</u>	<u>Electromagnetic environment - guidance</u>
RF emissions CISPR 11	Group 1	The RM500SL uses RF energy only for its internal function. Therefore, its RF emissions are very low and not likely to cause any interference in nearby electronic equipment.
RF emissions CISPR 11	Class A	The RM500SL is suitable for use in all establishments other than domestic and those directly connected to the public low-voltage power supply network that supplies buildings used for domestic purposes.
Harmonic emissions IEC 61000-3-2	Class A	
Voltage fluctuations/ flicker emissions IEC 61000-3-3	Complies	

FastFacts 1.6: Declaration of EMC compliance for the European Community

2 Getting Started

2.1 Section overview

This section provides help on unpacking the RM500SL and connecting various components and accessories. Note that **battery pills** (SL-110), the **RECD transducer** (SL-100), the **barcode scanner** (VA-120) and a **microphone extension cable** (VA-130) are accessories for the RM500SL and must be ordered separately.

The following topics are covered in this section:

[2.2: Unpacking and connecting](#)

[2.3: Microphone connection](#)

[2.4: Microphone care](#)

[2.5: Battery pill use and care](#)

[2.6: Mouse, keyboard, barcode scanner](#)

[2.7: External printer, auxiliary audio outputs](#)

FastFacts 2.1: Getting started

2.2 Unpacking and connecting

- 1) Carefully unpack the RM500SL and check the contents of the shipping box against the enclosed packing list. Note that some parts may be packed inside the test chamber.

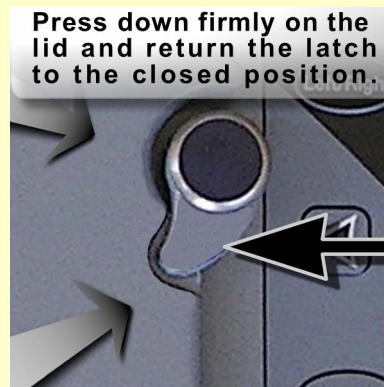

- 2) Unwrap the power cord from its stowage hooks - noting carefully how it has been packed. **To avoid serious damage to the display screen, always repack the cord this way.**
- 3) Connect the power cord to the socket next to the power switch on the right side of the unit. Plug the other end into a **grounded** 100 – 240 volt power outlet.

FastFacts 2.2: Unpacking and connecting

2.3 Microphone connection

- 1) Plug the reference microphone and the coupler microphone into the connectors in the test chamber as shown.

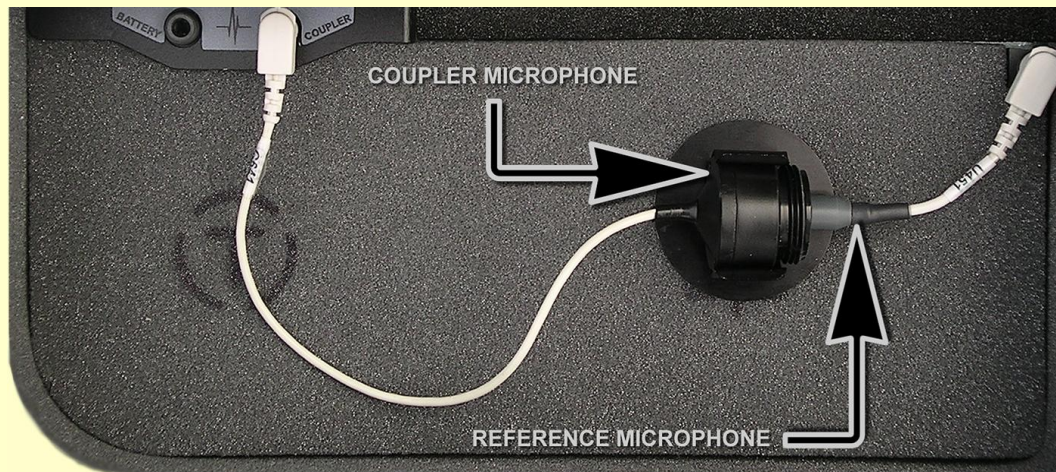

- 2) Plug the probe microphone assembly into the probe connector located at the left of the test chamber as shown.

NOTE: A microphone extension cable (VA-130) is available from Audioscan. Standard audio extension cables should not be used. They will substantially increase noise levels.

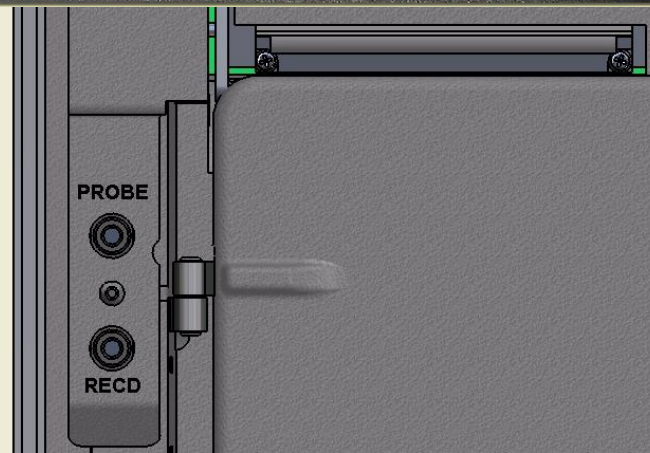

FastFacts 2.3: Microphone connection

2.4 Microphone care

Coupler microphone:

- 1) **DO NOT** twist the cable when attaching a coupler to the coupler microphone. Turn only the coupler or unplug the coupler microphone before turning it.
- 2) **DO** store the coupler microphone in its mounting clip when transporting.
- 3) **DO** make sure that the 2cc coupler is tightly screwed to the coupler microphone when performing hearing instrument tests. **Coupler leakage can cause feedback and erratic response curves.**
- 4) **DO** ensure there are no cracks in the #13 tubing on the BTE (HA-2) coupler.
- 5) **DO** replace the tubing on the BTE coupler with 3/8" (10 mm) of #13 tubing.

Probe microphone:

- 1) **DO NOT reuse probe tubes.** Debris and liquid from cleaning attempts can lodge in the enlarged base of the probe tube and subsequently clog the probe microphone port.
- 2) **DO NOT** attempt to open or repair the probe microphone. Attempting to repair the probe module may lead to damage or alteration of the factory calibration.
- 3) **DO** keep the probe module and probe tubes in a clean area.
- 4) **DO** stow the probe module when not in use or when transporting the RM500SL.

FastFacts 2.4: Microphone care

2.5 Battery pill use and care

Battery pills are optional. The **thin connecting strip** of each battery pill is **fragile**. When inserting pills into hearing instrument battery compartments, take care that this strip is not pinched or bent severely as the battery door is closed.

- 1) Select a battery pill that is appropriately sized for the hearing instrument that you are testing.
- 2) Insert the pill into the hearing instrument, carefully closing the battery door over the thin connecting strip.
- 3) Plug the pill's cable into the battery pill jack inside the RM500SL HIT test chamber (to the left of the coupler microphone connection).
- 4) Turn the hearing instrument on.



FastFacts 2.5: Battery pill use and care

2.6 Mouse, keyboard, barcode scanner

The RM500SL may be operated from the **built-in keypad**, a **USB mouse** (not included) or a standard USB computer (QWERTY) **keyboard** (not included), which may also be used to enter headers and comments on printouts: See [3.2 Input device operation](#).

An optional **barcode scanner** may be connected to the USB port to enter threshold, UCL and RECD data directly from a RM500SL or Verifit printout. Barcoded threshold data printed by some Grason-Stadler audiometric equipment may also be scanned. Scanners other than that supplied by Audioscan may not work and are not supported by Audioscan.

Multiple USB devices may be used together by connecting them to the RM500SL USB port via a USB hub.

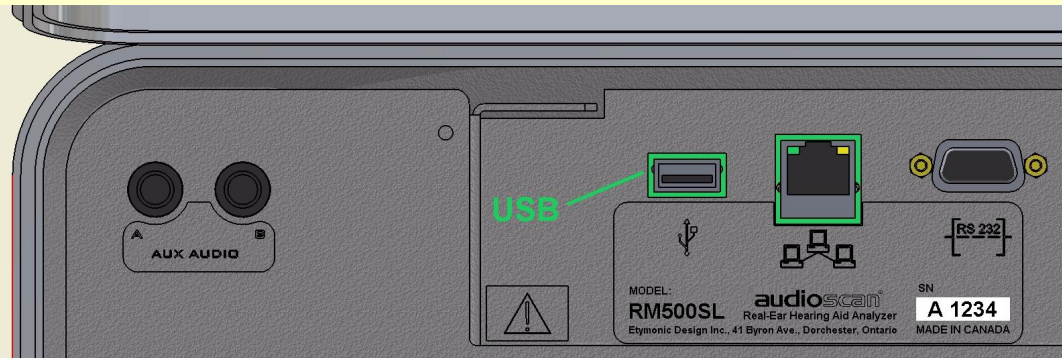

..In the European Community, if this device is connected to one or more other devices to make a system, the CE mark on this device is only valid if the other devices in the system carry a CE mark in respect of the Medical Device Directive and if the supplier has stated that the requirements of the Medical Device Directive will be met for this particular combination.

FastFacts 2.6: Mouse, keyboard, barcode scanner

2.7 External printer, auxiliary audio outputs

An **external printer** may be connected to the the USB port. It may be color or black & white but it **must be PCL3, PCL5 or PostScript compatible**. The external printer must first be selected in Setup. See [6: Printing and Storing Results](#)

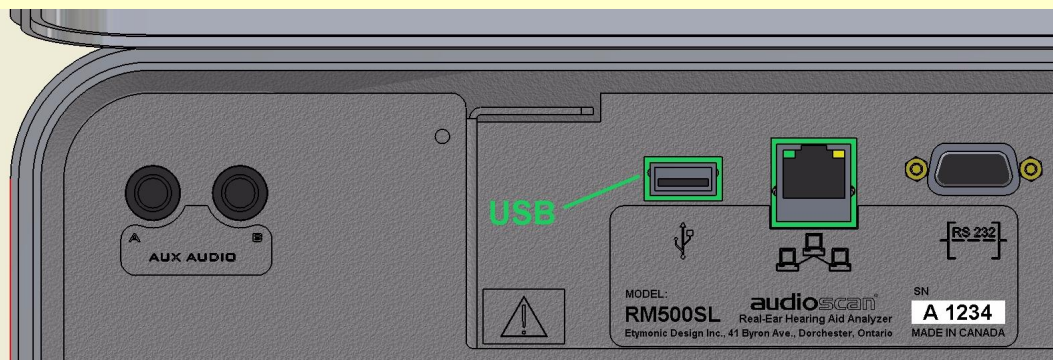

Auxiliary audio output jacks are not active with this version of software.



...In the European Community, if this device is connected to one or more other devices to make a system, the CE mark on this device is only valid if the other devices in the system carry a CE mark in respect of the Medical Device Directive and if the supplier has stated that the requirements of the Medical Device Directive will be met for this particular combination.

FastFacts 2.7: External printer, auxiliary audio outputs

3 General Operation

3.1 Section overview

The RM500SL is operated by using the built-in keypad, a USB QWERTY keyboard (not included) or a USB computer mouse (not included). Any of these pointing devices can be used to select items from menus, operate on-screen buttons and to enter audiometric data. In addition, audiometric data printed in barcode form by the RM500SL, the Verifit VF1 or some Grason-Stadler products, may be scanned into the RM500SL.

This section covers the following topics:

[3.2: Input device operation](#)

[3.3: Barcode data input](#)

[3.4: Keypad keys](#)

[3.5: Menus, lists and buttons](#)

[3.6: Screen messages](#)

[3.7: Program memory removal and replacement](#)

[3.8: Software updating](#)

FastFacts 3.1: General operation

3.2 Input device operation

The RM500SL may be operated by means of the **built-in keypad**, an external **mouse** (not included) or an external QWERTY **keyboard** (not included). These devices are used to summon on-screen menus and select items from them, to operate on-screen buttons and to input data. The **scroll wheel** on a mouse will scroll through long lists in list boxes and in Help. **Clicking the right mouse** button generates an **image of the keypad** which may be operated by the mouse. **Clicking the left mouse button** when the mouse pointer is on a graph will display a **screen cursor** with a digital readout of X and Y co-ordinates. Clicking again will dismiss the cursor.

Function	Keypad	QWERTY	Mouse
Summon Help menu	<Help>	F1	Right click
Summon Setup menu	<Setup>	F2	Right click
Summon Test menu	<Tests>	F3	Right click
Summon Session menu	<Session>	F4	Right click
Switch between ears or Switch between A/B Data	<Left/Right>	F5	Right click
Print	<Print>	Print Scrn	Right click
Move across screen columns	↔ Arrows	↔ Arrows	Roll
Move within a screen column	↑↓ Arrows	↑↓ Arrows	Roll
Select a highlighted item or operate a screen button	Round key (<PICK> key)	Numeric Enter Key	Left click
Enter numeric data	Select point on chart	Numeric keypad	Left click on a point on chart
Enter text	Not possible	Any key	Not possible
Proceed from current state	<Continue>	Enter ↵	Click Continue
Revert to previous state	<Cancel>	Esc	Click Cancel

Also see [2.6: Mouse, keyboard, barcode scanner](#) and [3.3: Barcode data input](#)

FastFacts 3.2: Input device operation

3.3 Barcode data input

In **Speechmap** and **Insertion gain** tests, audiometric data in barcode form on a RM500SL or Verifit printout may be entered by scanning the appropriate barcode. In Speechmap, threshold, UCL, RECD, transducer, age and ABR nHL to eHL conversion factors are encoded. In Insertion gain, threshold and transducer type are encoded. The type of data and the ear (left, right) is shown below the barcode. Only data for the displayed ear are imported. Barcodes may be scanned in any order and it does not matter if the barcode is “upside down”.

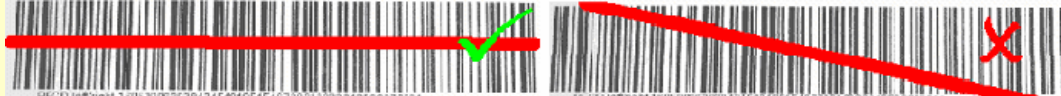

- 1) Select Speechmap or Insertion gain from the Tests menu.
- 2) Hold the printout so that the barcode to be scanned is flat. With the scanner 6” - 8” from the barcode, press the trigger on the scanner and center the illuminated red line along the length of the barcode.
- 3) When the scan is successful, the scanner will “beep”, the red line will extinguish and a Barcode Entry poster will appear on the screen. A green checkmark on the poster shows which data have been accepted. A message will advise if the barcode does not contain data for the screen you are viewing.
- 4) When all desired data have been accepted, select [Done] to apply the data.

[See 6.3: Barcodes, headers and comments on printouts](#). Barcodes on some Grason-Stadler printouts may also be scanned into the RM500SL.

Barcode Entry		
Ear	<input type="button" value="Left"/>	<input type="button" value="Right"/>
Age	<input type="button" value="Adult"/>	
Transducer	<input type="button" value="Headphone"/>	
Threshold	<input checked="" type="checkbox"/>	<input checked="" type="checkbox"/>
UCL	<input checked="" type="checkbox"/>	<input checked="" type="checkbox"/>
RECD	<input checked="" type="checkbox"/>	<input checked="" type="checkbox"/>
<input type="button" value="Done"/> <input type="radio"/>		
<input type="button" value="Cancel"/> <input type="checkbox"/>		

FastFacts 3.3: Barcode data input

3.4 Keypad keys

Keypad Button	Function
<Help>	Summon context-sensitive Help Screen.
<Setup>	Summon Setup Menu containing a list of RM500SL features that can be modified. Any modifications made will be maintained after power off.
<Tests>	Summon Test Selection Menu containing a list of the available test procedures.
<Session>	Summon Session Data Menu to erase or export data
<Left/Right>	Used to alternate between ears or A/B Data.
<Print>	Print on internal or external printer or print to file.
↔ Arrows	Move across screen columns.
↕ Arrows	Move within a screen column.
Round Key (<PICK> key)	Select a highlighted item or operate a screen button.
<Continue>	Proceed from current state.
<Cancel>	Revert to previous state.



FastFacts 3.4: Keypad keys

3.5 Menu, lists and buttons

Menu **Setup Box** **List Box**

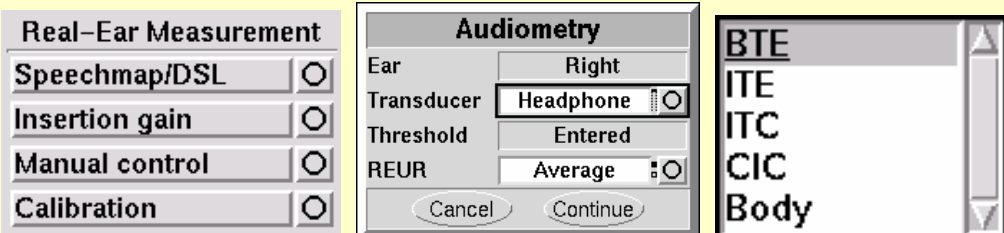



The **Menu** screenshot shows a window titled "Real-Ear Measurement" with four items: "Speechmap/DSL", "Insertion gain", "Manual control", and "Calibration". Each item has a small circle with a vertical line on its right side. The **Setup Box** screenshot shows a window titled "Audiometry" with fields for "Ear" (Right), "Transducer" (Headphone), "Threshold" (Entered), and "REUR" (Average). It also has "Cancel" and "Continue" buttons. The **List Box** screenshot shows a list of items: "BTE", "ITE", "ITC", "CIC", and "Body". The "BTE" item is highlighted with a thick border.



Screen Buttons are identified by a circle within a raised block  and are located at the right hand end of a line of screen text. A screen button highlighted using the keypad or a QWERTY keyboard is surrounded by a heavy line. A screen button highlighted by the mouse pointer changes color from light to dark gray. A highlighted screen button is operated by pressing the <PICK> (round) key on the keypad, the numeric Enter key on a keyboard or by clicking the left mouse button. This process also selects the highlighted item in a list box.

There are three different types of screen buttons:

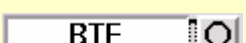

When selected, a **Menu Button** displays a menu, a setup box or a test screen.

 **Insertion Gain** 

When selected, a **List Button** displays a drop-down list box.

 **BTE**  The current list item is shown in the window.

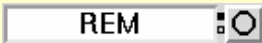
When selected, a **Toggle Button** alternates between states.

 **REM**  The current state is shown in the window.

FastFacts 3.5: Menu, lists and buttons

3.6 Screen messages

The **Title bar** (top line of the display screen) informs you of the selected Test (e.g., Multicurve).

The **Message bar** (bottom line of the display screen) suggests the next step in a test or informs you of the state of the instrument or conditions that could affect your data. For example, it will inform you if the microphones need to be calibrated.

FastFacts 3.6: Screen messages

3.7 Program memory removal and replacement

Operating software is contained on a USB flash drive located in the test chamber under the printer paper roll cradle as shown. Software updates are shipped on a CD-ROM and must be transferred to the USB flash drive in order to be used. This requires that the USB flash drive be removed from the RM500SL and plugged into the USB port on a PC that has a CD-ROM drive.

To remove the USB flash drive, ensure that the RM500SL power is off and:

- 1) Open the test chamber and remove the foam from the test chamber floor.
- 2) Pull the USB flash drive straight toward the front of the unit until it is free.

To install the USB flash drive, ensure that the RM500SL power is off and:

- 1) Open the test chamber and remove the foam from the test chamber floor.
- 2) Gently insert the USB flash drive into the USB port, with its foam pad down.
- 3) Replace the foam in the floor of the test chamber.

NOTE that the USB flash drive has been especially configured for the RM500SL. Replacing this flash drive with another can cause erratic operation. Such replacement should be done only when authorized and **ONLY** by an Audioscan service representative.

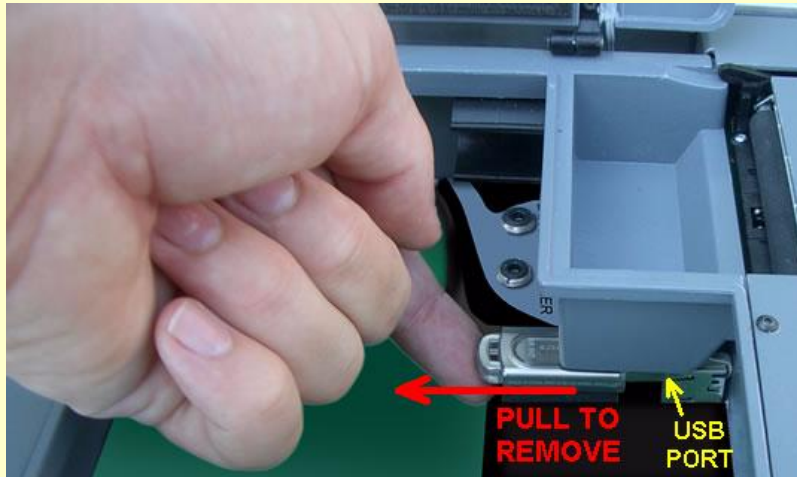

FastFacts 3.7: Program memory removal and replacement

3.8 Software updating

Software updates, along with a new User's Guide, are shipped on a CD-ROM. The software must be transferred to the USB flash drive in the RM500SL in order to be used. This transfer requires a PC with a CD-ROM drive and a USB port. To update the RM500SL software:

- 1) Refer to [3.7: Program memory removal and replacement](#) and remove the USB flash drive from the RM500SL.
- 2) Insert the software update CD-ROM into the CD-ROM drive on your PC.
- 3) Double-click on My Computer, then double-click on the CD-ROM drive.
- 4) Double-click on [rm500sl_update.exe](#) and follow instructions to complete the update.
- 5) Remove the USB memory stick from the PC.
- 6) Refer to [3.7: Program memory removal and replacement](#) and install the USB flash drive in the RM500SL.

See [1.3: Electronic user's guide](#) for help in accessing the new User's Guide.

FastFacts 3.8: Software updating

4 General Setup

4.1 Section overview

This section covers the following topics:

- [4.2: Date and time setup](#)
- [4.3: Display settings](#)
- [4.4: Saving test setup](#)

FastFacts 4.1: General setup

4.2 Date and time setup

To set the date and time that appears on printouts and calibration screens:

- 1) Press <Setup>, then highlight and <PICK> [Date & Time] on the Setup poster.
- 2) To change the date, highlight and <PICK> the month window to display a drop-down list of months.
- 3) Highlight and <PICK> the desired month on the list.
- 4) Repeat the previous step to change the date, year and time in the appropriate windows.
- 5) When the new date and time information has been set, press <Continue> to exit.

FastFacts 4.2: Date and time setup

4.3 Display settings

This feature sets the screen saver timing and the background color used on the graphic test displays. The screen saver blanks the screen after 60, 90 or 120 minutes of inactivity to prolong the life of the display.

To change display settings:

- 1) Press <Setup>, then highlight and <PICK> [Display].
- 2) To change the **screen saver timing**, highlight and <PICK> the current setting
- 3) Highlight and <PICK> the desired screen saver timing from the drop-down list.
- 4) To change the **background color** of the graphic display on the various test screens, highlight and <PICK> [Color] to toggle between black and white.
- 5) Press <Continue> to exit setup.

FastFacts 4.3: Display settings

4.4 Saving test setup

This feature lets you retain the last-used stimulus type and level for most tests when the power is turned off. It also lets you retain the last-used target method and transducer type in Speechmap and Insertion Gain tests.

To enable/disable this feature:

- 1) Press <Setup>, then highlight and <PICK> [Test setup]
- 2) Highlight and <PICK> [Save test setup] to toggle between Yes and No.

FastFacts 4.4: Saving test setup

5 Networking

5.1 Section overview

The RM500SL may be connected to a network using a Cat 5, RJ-45 cable. This allows screen images to be printed on a network printer or on a shared printer on a networked PC. Images and underlying data may also be saved to a shared folder on a networked PC. See [6: Printing and Storing Results](#) for details. The RM500SL may also be connected to a single computer using a network hub.

This section covers the following topics:

[5.2: Networking requirements](#)

[5.3: Networking setup](#)

[5.4: Single computer connection](#)

FastFacts 5.1: Networking

5.2 Networking requirements

The RM500SL may be connected to a network using a Cat 5, RJ-45 cable. The network connector is next to the serial number label on the recessed panel. For automatic address assignment, the network must have a Dynamic Host Configuration Protocol (DHCP) server.

For manual addressing, the remote computer must be running Windows 95 or higher, File and Printer Sharing for Microsoft Networks must be enabled and the TCP/IP Connection must be configured so that the IP address of the remote computer is on the same subnet as the RM500SL. These settings should be obtained from your network administrator.

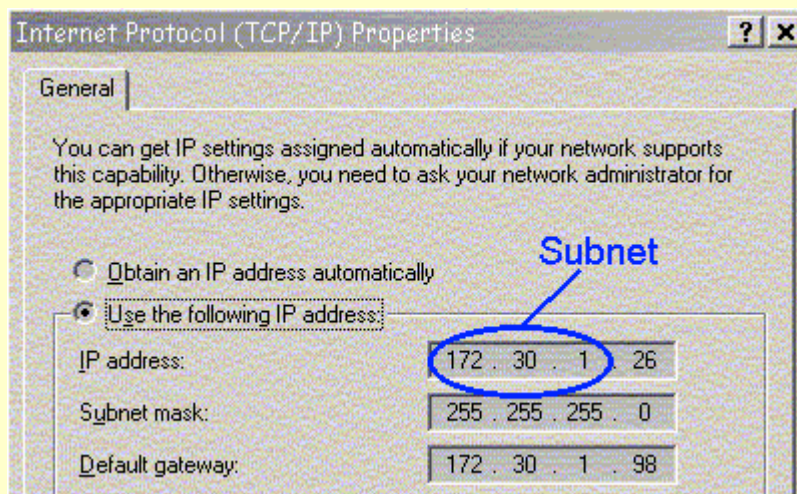

FastFacts 5.2: Networking requirements

5.3 Networking setup

Check [5.2: Networking requirements](#) and connect the RM500SL to your network.

- 1) Press <Setup> then highlight and <PICK> [Network]
- 2) In the Network poster, highlight and <PICK> [Enable networking].
- 3) If your network supports automatic address assignment (DHCP), highlight and <PICK> [Obtain automatically]. Highlight and <PICK> [Test connection].
- 4) For manual configuration, highlight and <PICK> [Obtain manually]. Then highlight each of the 4 boxes in each row and highlight and <PICK> the numbers, provided by your network administrator, from the drop-down lists.
- 5) Highlight and <PICK> [Test connection]. The RM500SL will prompt you for an IP address of a computer or router on your network. In a single PC-to-RM500SL network, this is the IP address of the PC you are connecting to.

Max TM SPL Enable networking

Frequencies

Test setup

ABR nHL to eHL

Speakers

ANSI

Display

Network

Printing

Date & Time

Self test

CD-ROM

Network address

Obtain automatically

Obtain manually

IP Address 172 30 1 110

Network 172 30 1 0

Broadcast 172 30 1 255

Netmask 255 255 255 0

Test connection

Numbers assigned by network administrator for the RM500SL

FastFacts 5.3: Networking setup

5.4 Single computer connection

The computer must be running Windows 95 or higher, with a functioning network card connected to one port on a Ethernet **network hub or switch**. Connect a Cat 5, RJ-45 cable from a hub port to the RM500SL connector. **To set up the PC:**

- 1) Right click Network Neighborhood (or My Network Places) & select Properties.
- 2) Right click Local Area Network Connection & select Properties.
- 3) If Internet protocol TCP/IP is not installed, install it from your Windows disk.
- 4) Highlight Internet Protocol (TCP/IP) & select the Properties button.
- 5) Check "Use the following IP address" and enter the following in the IP address box: 172. 30. 1. 1. Enter 255. 255. 255. 0 in the Subnet mask box.

On the RM500SL, see [5.3 Networking setup](#) and manually configure as shown:

IP Address	172	30	1	2
Network	172	30	1	0
Broadcast	172	30	1	255
Netmask	255	255	255	0

FastFacts 5.4: Single computer connection

6 Printing and Storing Results

6.1 Section overview

Pressing <Print> will cause the current screen image to be **printed** on the internal printer, on an external local printer, on a network printer, on a Windows-shared printer on a networked PC, or **saved** to file on a USB memory stick, or a Windows-shared file on a networked PC. Date, time, barcoded audiometric data and fixed or variable headers and comments (via a connected keyboard), may be added to printouts (but not when saving to a file). Session data may also be saved as a delimited text file to a USB memory stick or in a Windows-shared folder on a networked PC for further analysis.

The following topics are covered in this section:

[6.2: Internal printer paper loading](#)

[6.3: Barcodes, headers and comments on printouts](#)

[6.4: Local printer setup](#)

[6.5: Printing to a USB memory stick](#)

[6.6: Network printer setup](#)

[6.7: Printing to a network file](#)

[6.8: Data storage to a network file](#)

FastFacts 6.1: Printing and storing results

6.2 Internal printer paper loading

On-screen instructions on paper replacement are provided if you try to print to the internal printer when it is out of paper or when the paper lever has been raised.

To load a new roll of paper:

- 1 Lift the printer head using the small black lever to the left of the printer.
- 2 Press the <Print> key for on-screen instructions.
- 3 Remove the empty spool from the paper tray and any remaining paper from the printer.
- 4 Hold a new roll in front of the paper tray with paper feeding from the top of roll.
- 5 Insert the paper's leading edge into the lower slot at rear of tray.
- 6 Feed the paper by highlighting the on-screen 'Paper Feed' button and pressing <PICK>.
- 7 Advance the paper until it comes out of the upper slot.
- 8 Place the roll in the paper tray and advance another 10" (25 cm) of paper.
- 9 Lower the printer head using the small black lever. Press <Continue> to print or <Cancel> to cancel the print job.



If nothing shows on the paper when you press <Print> and the paper is coming out –check that the glossy side is up as it comes out of the printer.

Thermal paper may darken if stored for prolonged periods at elevated temperatures and lose contrast if subjected to light. Keep long-term supplies and printouts in a cool dry place out of direct light.

FastFacts 6.2: Internal printer paper loading

6.3 Barcodes, headers and comments on printouts

The date and a header, such as facility or patient name, may be added to printouts. Barcodes representing hearing threshold, UCL and RECD, where applicable, may be added to printouts of Speechmap, Insertion gain and RECD tests. Lines for hand-written notes or typed comments may also be added.

- 1) Connect a computer keyboard to the USB port.
- 2) Press <Setup>, then highlight and <PICK> [Printing].
- 3) Highlight [Page setup] and press <PICK> to display the page setup poster.
- 4) To print the **date and time** on each printout, highlight and <PICK> [Date].
- 5) To print **lines** for handwritten notes, highlight and <PICK> [Lines].
- 6) To add **barcodes** for audiometric data, highlight and <PICK> [Barcode].
- 7) To print a **fixed header** on printouts, highlight and <PICK> [Header]. Connect a keyboard to the USB port and enter the desired header (up to 35 characters). Press <PICK> (or Enter key on the keyboard **number** pad) to complete the entry. To be prompted for a **new header** for each printout, highlight and <PICK> [Ask].
- 8) To print **fixed comments** following a printout, highlight and <PICK> [Description]. Connect a keyboard to the USB port and enter comments. Press <PICK> (or Enter on the keyboard **number** pad) to complete the entry. To be prompted for **new comments** for each printout, highlight and <PICK> [Ask].
- 9) To be prompted for a **file name** when you print to a USB memory stick or a network file, highlight and <PICK> [Ask]. **Do not use space \$ \ / or tab in the file name.** USB file names are limited to 8 characters. See [6.7: Printing to a network file](#).
- 10) Press <Continue> to exit page setup and <Continue> to exit Setup.

FastFacts 6.3: Barcodes, headers and comments on printouts

6.4 Local printer setup

- 1) Connect an external printer to the USB port. **Only PCL3, PCL5 or PostScript compatible printers are supported.**
- 2) Press <Setup>, then highlight and <PICK> [Printing].
- 3) Highlight & <PICK> [USB].
- 4) Highlight & <PICK> [Printer details] (automatic if printer type is set to None).
- 5) Highlight & <PICK> [Printer type].
- 6) Highlight & <PICK> your printer type. Select Color(1) for a printer with a single ink cartridge; color(2) for a printer with separate color and black ink cartridges. Check [Black only] for black printouts on a color printer
- 7) Press <Continue> to exit printer setup and <Continue> to exit Setup.



FastFacts 6.4: Local printer setup

6.5 Printing to a USB memory stick

- 1) Plug a USB memory stick into the USB port next to the product label on recessed panel. The RM500SL may be either on or off.
- 2) Press <Setup>, then highlight and <PICK> [Printing].
- 3) Highlight and <PICK> [Print to USB file].
- 4) Highlight and <PICK> [Printer details] to change the file type [Bitmap (bmp)] or [Internet GIF (gif)] and the captured area [Full screen], [Main window] (full screen without the message line or [Active window] (foreground image only).
- 5) To save a screen image to a file, press <Print>. After about 4 seconds, a message will advise that data is being saved. **Do not unplug the USB stick until this message disappears.**
- 6) To input a file name from a connected keyboard each time you print, highlight and <PICK> [Page setup], then highlight & <PICK> [Ask]. File names are limited to 8 characters plus .bmp or .gif. **Do not use space \$ \ / or tab in the file name.**
- 7) To save all test data as a space-delimited text file, press <Session>, then <Pick> the [Erase all data] button to show a list of options. Highlight and <Pick> [Export data to file on USB stick] and press <Continue>.

Data from this file may be copied to the clipboard and pasted to most spreadsheet programs. After pasting to Excel, select Text to Columns in the Data menu and indicate that the data are space-delimited (need not repeat if file remains open).

FastFacts 6.5: Printing to a USB memory stick

6.6 Network printer setup

To print to a network printer or to a Windows-shared printer on the network, you must first enable networking. See section [5: Networking](#). To print to a printer on a Windows PC connected to a network, you must also share the printer on the PC by selecting Start, Settings and Printers. Then right click on the printer you wish to share and select Sharing. **Only PCL 3, PCL 5 or PostScript compatible printers are supported.** In Windows2003 Server you must add permission to allow Anonymous Logon to print to the shared printer.

- 1) Press <Setup>, then highlight and <PICK> [Printing].
- 2) Highlight & <PICK> [Other network printer] or [Windows shared printer].
- 3) Highlight & <PICK> [Printer details] (automatic if printer type is set to None).
- 4) Highlight & <PICK> [Printer type], then select from Deskjet Color(1) (single ink cartridge), Deskjet Color(2) (both color and black ink cartridges), Laserjet Black or PostScript. Check [Black only] for black printouts on a color printer.
- 5) Connect a computer keyboard to the USB port and fill in the boxes with the requested information. Highlight and <PICK> each box to open it for data entry and again to close it (or use the Enter key on the keyboard's numeric keypad). Obtain needed information from your network administrator.

Windows network printer		Other network printer	
Printer type	HP Deskjet Color (2) <input type="radio"/> Black only <input type="checkbox"/>	Printer type	HP Laserjet Black <input type="radio"/>
	Hewlett-Packard Deskjet (tm) color printer with separate black and color cartridges		Hewlett-Packard Laserjet (tm) printer
Computer	MAD1 <input type="radio"/>		
Share name	ColorJet55 <input type="radio"/> Case Sensitive	IP Address	172.30.1.99 <input type="radio"/>
Username	Dave <input type="radio"/>	Port	9100 <input type="radio"/>
Password	***** <input type="radio"/>		
	<input type="radio"/> Test connection		Cancel <input type="radio"/> Continue <input type="radio"/>

FastFacts 6.6: Network printer setup

6.7 Printing to a network file

To save the screen image as a file on a network PC, you must first enable networking. See [5: Networking](#). You must also "share" a folder in the PC root directory (e.g. c:\MyData) and ensure that Change permissions are enabled.

- 1) Press <Setup>, then highlight and <PICK> [Printing].
- 2) Highlight and <PICK> [Print to file].
- 3) Highlight and <PICK> the file type [Bitmap (bmp)] or [Internet GIF (gif)].
- 4) Highlight and <PICK> [Full screen], [Main window] (full screen without the message line or [Active window] (foreground image only).
- 5) Connect a computer keyboard to the USB port and fill in [Computer], [Share name], [Username] and [Password] (not needed for Windows 95/98). Highlight and <PICK> each box to open it for data entry and again to close it (or use the Enter key on the keyboard's numeric keypad).
- 6) Highlight and <PICK> [Test connection] and wait for a successful report.
- 7) To input a file name each time you <Print>, highlight and <PICK> [Page setup], then highlight & <PICK> [Ask]. **Do not use space \$ \ / or tab in the file name.**

Network file	
File type	Bitmap (bmp) <input type="radio"/>
Print frame	Main window <input type="radio"/> Network name of your PC
Computer	Alice1 <input type="radio"/> Shared folder on your PC
Share name	MyData <input type="radio"/> (Case sensitive. May not contain space \$ \ / or tab)
Username	Alice <input type="radio"/>
Password	***** <input type="radio"/> Network user name and password (if required)

FastFacts 6.7: Printing to a network file

6.8 Data storage to a network file

All measurement data (curves) displayed at the end of the test are stored until overwritten by repetition of the same test, invalidated by a related test. (In such cases, the message bar will inform you of impending data loss.), erased by selecting <Session> and one of the [Erase data] choices or the power is turned off. (Setup data will be retained even after the power is turned off.)

The RM500SL database may be saved as a delimited text file on a networked PC if network file printing has been set up. See [6.7: Printing to a network file](#).

- 1) Press the <Session> key.
- 2) Highlight and <PICK> [Erase all data] to generate a list box.
- 3) Highlight and <PICK> [Export data to file].
- 4) Press <Continue>.

Data from this file may be copied to the clipboard and pasted to most spreadsheet programs. After pasting to Excel, select Text to Columns in the Data menu and indicate that the data are space-delimited (need not repeat if file remains open).

FastFacts 6.8: Data storage to a network file

7 Hearing Instrument Tests Setup

7.1 Section overview

For most tests, two completely separate sets of test results, labelled A and B, may be retained and displayed. The appearance of Hearing Instrument Test (HIT) screens may be changed in several ways. Most screens may be formatted to show results in graphical or tabular format. The Multicurve screen may be scaled in dB SPL or dB Gain. Individual curves may be hidden (but not erased).

This section covers the following topics:

- | | |
|---------------------------------|--|
| 7.2: HIT A or B display | 7.8: HIT calibration facts |
| 7.3: Graph or table format | 7.9: Calibration of HIT reference microphone |
| 7.4: Output or gain scale | 7.10: Calibration check for coupler microphone |
| 7.5: Hide or Show HIT curves | 7.11: Coupling the hearing instrument |
| 7.6: 1996 or 2003 ANSI standard | 7.12: Positioning the hearing instrument |
| 7.7: ANSI test frequencies | |

FastFacts 7.1: Hearing instrument tests setup

7.2 HIT A or B display

For most tests, two completely separate sets of test results, labelled A and B, may be retained and displayed. To switch between A and B test results, press the <Left/Right> key.

FastFacts 7.2: HIT A or B display

7.3 Graph or table format

Except for Distortion, Input/Output, Battery drain and Manual control screens, you have the option of selecting either a graphic or tabular format.

To change the **data format**, highlight, then <PICK> [Graph] or [Table].

FastFacts 7.3: Graph or table format

7.4 Output or gain scale

On the Multicurve test screen, you have the option of displaying test results in SPL (dB) or gain (dB).

To change the **scale**, highlight, then <PICK> [dB SPL] or [dB Gain]

FastFacts 7.4: Output or gain scale

7.5 Hide or Show HIT curves

On screens capable of showing more than one curve, you may show or hide test curves. Hiding a curve does not erase it.

To hide or show test curve(s):

- 1) Highlight, then <PICK> Curve [Hide/Show].
- 2) Highlight, then <PICK> the desired test curve to toggle between Hide or Show. The curve will toggle on or off when selected.
- 3) Press <Continue> to return to the test screen.

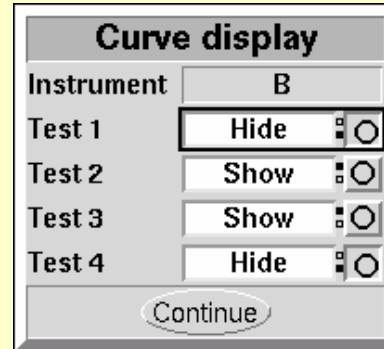

FastFacts 7.5: Hide or Show HIT curves

7.6 1996 or 2003 ANSI standard

Automated tests of linear and AGC hearing aids may be conducted according to either the ANSI S-3.22-1996 or ANSI S3.22-2003 test standards. For differences, see [8.2: ANSI S3.22-1996 facts](#) and [8.3: ANSI S3.22-2003 facts](#).

To select the standard to be used:

- 1) Press <Setup>, then highlight and <PICK> [ANSI]
- 2) Highlight and <PICK> the version of the ANSI standard you wish to use.
- 3) Press <Continue> to exit

FastFacts 7.6: 1996 or 2003 ANSI standard

7.7 ANSI test frequencies

The Frequencies feature allows hearing instruments to be evaluated at the Special Purpose Average (SPA) frequencies defined by ANSI S3.22, rather than the default High Frequency Average (HFA) frequencies. The choice of SPA (or HFA) frequencies influences the average OSPL90, average full-on gain, reference test gain, bandwidth and equivalent input noise. The frequencies at which distortion is measured are one-half the selected SPA frequencies. You can also select the frequencies at which attack and release times are measured.

To change the averaging frequencies:

- 1) Press <Setup>, then highlight and <PICK> [Frequencies].
- 2) Highlight and <PICK> the HFA/SPA frequencies box, to generate a drop-down list box of alternate test frequencies.
- 3) Highlight the desired HFA/SPA test frequencies and press <PICK> to select.

To change the frequencies for attack and release time measurements:

In the list of available frequencies, highlight and <PICK> the frequencies to be used to measure attack and release time.

Press <Continue> to exit.

FastFacts 7.7: ANSI test frequencies

7.8 HIT calibration facts

HIT microphone calibration establishes a correction curve for the uncalibrated HIT reference microphone by comparison with the factory calibrated coupler microphone. It may be performed as often as desired but will be invalidated at 1 am the following day or at 1 am the following Monday, depending on the choice of Daily or Weekly calibration interval. After the calibration has expired, you will be prompted to calibrate whenever you attempt a test that uses the HIT microphones.

Note that there are two styles of HIT reference microphones. The newer style is larger but responds beyond 16 kHz and has a lower noise floor. The two have different correction curves, as shown below, but will produce the same test results, once calibrated. Your calibration curve should be similar to one of these and should remain stable over time. Irregularities in the calibration curve may be the result of positioning errors. See [7.9: Calibration of HIT reference microphone](#).

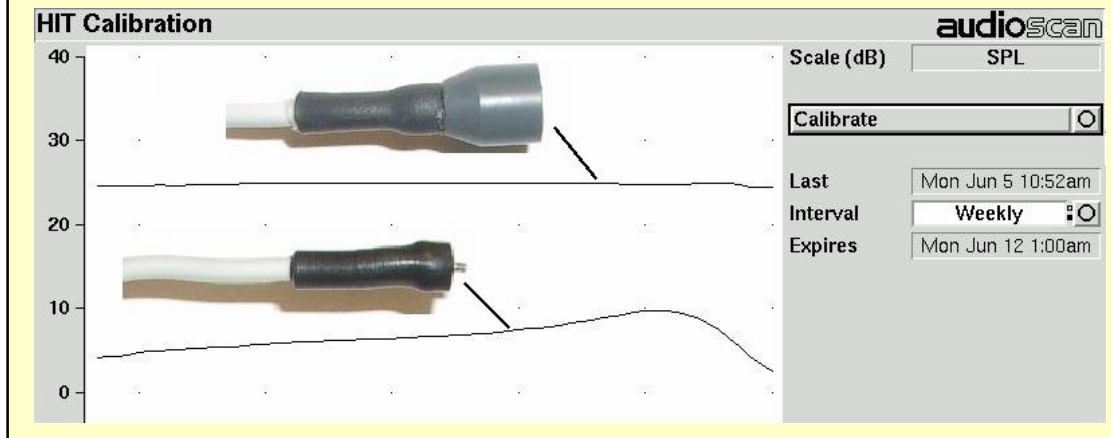

FastFacts 7.8: HIT calibration facts

7.9 Calibration of HIT reference microphone

Remove any coupler from the coupler microphone before calibration.

- 1) Position the HIT reference microphone opening concentric with the coupler microphone opening and about 1 – 2 mm from as shown below.
- 2) Close and seal the test chamber by tightening the latch at the front of the lid.
- 3) Press <Tests>, then highlight and <PICK> [Calibrate] from the Hearing Instruments Test column.
- 4) Highlight, then <PICK> [Daily] or [Weekly] to select the calibration interval.
- 5) Highlight and <PICK> [Calibrate]. [See 7.8: HIT calibration facts](#)

It is recommended that you print a copy of the initial calibration curve and compare it with your daily or weekly curve. Any change in this curve indicates a drift in either the coupler or the reference microphone which needs further investigation. See [7.10: Calibration check for coupler microphone](#) for an additional check.

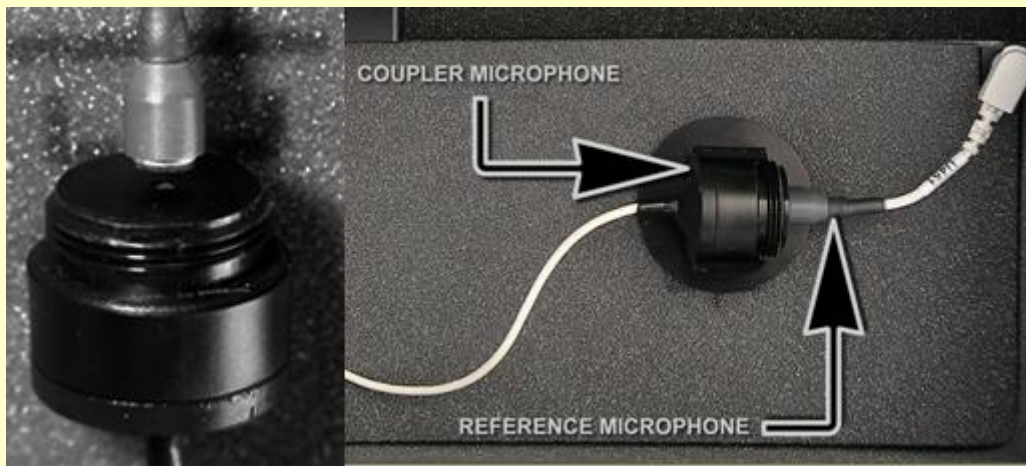

FastFacts 7.9: Calibration of HIT reference microphone

7.10 Calibration check for coupler microphone

Accuracy of HIT measurements depends on the calibration of the coupler microphone. This should be checked regularly using a microphone calibrator with an adapter ring. The RE780 (1 1/8") and RE781 (1") rings are designed for Quest CA22 and QC-10/20 respectively. To verify the coupler microphone calibration:

- 1) Calibrate the HIT reference microphone. See [7.9: Calibration of HIT reference microphone](#)
- 2) Screw the appropriate calibrator ring onto the coupler microphone.
- 3) Insert the coupler microphone with the attached calibrator ring into the calibrator opening.
- 4) Turn the calibrator on and adjust it to present one of the available frequencies and levels (e.g., 94 dB SPL at 1000 Hz).
- 5) Press <Tests>, then highlight and <PICK> HIT [Manual control].
- 6) Highlight and <PICK> the [Level] window, then highlight and <PICK> 0 from the drop-down list.
- 7) Highlight, then <PICK> the [Frequency] window, then highlight and <PICK> the frequency of the calibrator (e.g. 1000 Hz) from the drop-down list.
- 8) Highlight, then <PICK> the [Filter] window, then highlight and <PICK> 1/12th octave from the drop-down list.
- 9) Highlight, then <PICK> [Start test] (which changes to [Stop test]).
- 10) Check that the Coupler microphone level is within 1 dB of the calibrator level setting, +/- the calibrator accuracy. For a 94 dB calibrator with +/- 0.3 dB accuracy, the indicated coupler microphone level should be 94 +/- 1.3 dB.
- 11) To stop the measurement, highlight and <PICK> [Stop test].

FastFacts 7.10: Calibration check for coupler microphone

7.11 Coupling the hearing instrument

The RM500SL is supplied with 2 metal couplers, a type HA-1 (ITE) and a type HA-2 (BTE). Note that an **ANSI standard coupler for CICs does not exist**. These must be tested in the HA-1 coupler.

When threading the couplers onto the coupler microphone, **it is very important that they be firmly tightened** to ensure a good acoustic seal. Avoid twisting the coupler microphone cable – turn the coupler not the microphone or unplug the microphone while tightening the coupler.

BTE instruments are coupled to the HA-2 coupler by means of a 3/8th “ (10 mm) length of heavy wall #13 (2mm) earmold tubing. The only purpose of this tubing is to seal the tip of the earhook to the coupler inlet. All of the tubing required by ANSI S3.22 is machined into the metal stem of the HA-2 coupler. The #13 tubing should be inspected regularly for cracks which will cause feedback.

Custom instruments are sealed to the HA-1 coupler with putty so that the end of the eartip is flush with the inside of the coupler opening. Putty should not extend into the coupler cavity or block the sound outlet of the instrument. **Vents should be sealed at the faceplate end**. It is very important that the instrument be well-sealed to the coupler. **Excess low frequency output is usually due to open vents or a poor seal to the coupler**.

Open fit instruments must use the coupler and coupling system specified by the manufacturer. This may involve a hook that replaces the open fit tubing or an adapter tube that may be sealed to the opening of the HA-1 coupler with putty.

Receiver-in-canal instruments are coupled to the HA-1 coupler using putty to seal the receiver module or soft tip to the coupler opening.

Excess low frequency output is usually due to open vents or a poor seal to the coupler.

For health reasons, hearing instruments should be clean before putty is applied and putty should be replaced frequently.

FastFacts 7.11: Coupling the hearing instrument

7.12 Positioning the hearing instrument

- 1) The hearing instrument should be coupled to the appropriate coupler and a battery or battery pill installed. See [7.11: Coupling the hearing instrument](#) and [2.5: Battery pill use and care](#).
- 2) Place the instrument and coupler in the test chamber so that the microphone opening(s) of the instrument are on the crossbar within the test zone. >> 
- 3) Position the HIT reference microphone as close as possible to the (front-facing) microphone opening of the hearing instrument without touching it.
- 4) Close and seal the test chamber.

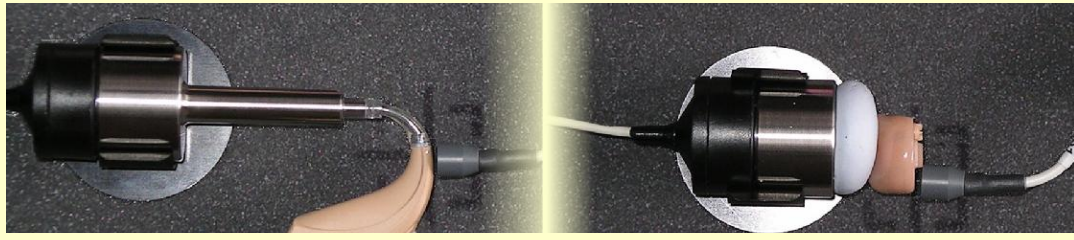

FastFacts 7.12: Positioning the hearing instrument

8 ANSI S3.22 Hearing Aid Tests

8.1 Section overview

These Hearing Instrument Tests follow the procedures of ANSI S3.22-1996 or ANSI S3.22-2003 as selected in Setup. See [7.6: 1996 or 2003 ANSI standard](#) :

Linear: An automated test sequence for linear hearing aids per ANSI S3.22.

AGC: An automated test sequence for AGC hearing aids per ANSI S3.22.

Input/Output: 1 - 4 curves of coupler SPL vs input SPL at .25, .5, 1, 2 and 4 kHz.

Telecoil: **STS** (1996 - simulated telephone sensitivity) or **RSETS** (2003 - relative simulated equivalent telephone sensitivity) using a coil in the test chamber floor.

This section covers the following topics:

[8.2: ANSI S3.22-1996 facts](#)

[8.7: ANSI input-output curves](#)

[8.3: ANSI S3.22-2003 facts](#)

[8.8: ANSI telecoil terminology](#)

[8.4: ANSI 1996 Linear and AGC tests](#)

[8.9: ANSI telephone simulator \(TMFS\) test](#)

[8.5: ANSI 2003 Linear and AGC tests](#)

[8.10: Telecoil test results](#)

[8.6: ANSI test results](#)

FastFacts 8.1: ANSI S3.22 hearing aid tests

8.2 ANSI S3.22-1996 facts

The RM500SL performs selected hearing instrument tests in accordance with ANSI S3.22-1996. This standard expresses some outputs and gains as High Frequency Average (HFA) values. The HFA is the average of values at 1000, 1600 and 2500 Hz. If a hearing aid meets certain conditions, the manufacturer may choose other averaging frequencies called Special Purpose Average (SPA) frequencies. The current averaging frequencies are indicated explicitly on test results where space permits and also appear as tick marks on the frequency axis of graphs. To change the averaging frequencies, see [7.7: ANSI test frequencies](#).

This standard also requires some tests with the gain control full on and some with the gain control in the Reference Test Position (RTP). This requirement applies to both Linear and AGC aids that have a HFA (or SPA) full-on gain greater than the HFA (or SPA) OSPL90 minus 77 dB. Otherwise the RTP is full on. If required, the RM500SL will pause in its testing and guide you in setting the gain control to the RTP.

All other controls on the hearing instrument should be set to provide the widest frequency response, the greatest gain and the highest maximum output. AGC controls or programmable settings should be as designated by the manufacturer.

At full-on gain the **[Linear]** and **[AGC]** test sequences provide a curve of OSPL90 (Output Sound Pressure Level for a 90 dB input SPL), the HFA (or SPA) and peak value of this curve, the frequency of the peak and the HFA (or SPA) gain for a 50 dB input SPL.

With the gain control at RTP, these sequences also provide a frequency response curve with an input SPL of 60 dB (Linear) or 50 dB (AGC), the HFA (or SPA) gain for a 60 dB input SPL, the frequency range, battery drain, equivalent input noise, harmonic distortion, attack and release time (AGC only).

FastFacts 8.2: ANSI S3.22-1996 facts

8.3 ANSI S3.22-2003 facts

ANSI S3.22-2003 has been designated a recognized standard by the FDA but is not yet mandatory. Manufacturers may use either version for reporting test data.

The most significant change from the 1996 version is the requirement for the hearing aid to be set in its most linear mode for the setting of the gain control to Reference Test Setting (changed from Reference Test Position) and for all tests except attack and release and input-output (I/O) curves. These two tests are to be conducted with the AGC function set for maximum effect. The AGC test sequence will pause to allow AGC to be set prior to measuring attack and release time.

Full-on gain is determined with 50 dB input SPL (60 dB was formerly an option) and frequency response curves are run at 60 dB SPL for Linear **and** AGC aids.

The OSPL90 curve, the HFA (or SPA) and peak value of this curve, the frequency of the peak, the HFA (or SPA) full-on gain are determined at full-on gain setting. The response curve, frequency range, Reference Test Gain, battery drain, equivalent input noise, distortion, attack and release times are determined at RTS.

These changes result in more consistent values for reference test gain, equivalent input noise and attack and release time. See [7.6: 1996 or 2003 ANSI standard](#), [8.2: ANSI S3.22-1996 facts](#) and [8.5: ANSI 2003 Linear and AGC tests](#).

FastFacts 8.3: ANSI S3.22-2003 facts

8.4 ANSI 1996 Linear and AGC tests

- 1) Press <Tests>, then highlight and <PICK> [Linear] or [AGC].
- 2) Highlight and <PICK> [Start test]; test setup instructions will be displayed.
- 3) Refer to [7.11: Coupling the hearing instrument](#), [7.12: Positioning the hearing instrument](#) and [2.5: Battery pill use and care](#) to prepare the instrument for testing.
- 4) **Turn the instrument ON.**
- 5) Set the gain control (manual or programmable) to maximum with all other controls set to provide the widest frequency response, greatest gain and highest maximum output. AGC controls and/or programmable parameters should be set as designated by the manufacturer.
- 6) Press <Continue> to run the test or press <Cancel> to abort the test. Note that, if required, the RM500SL will pause during the test to request that the volume control be adjusted to the Reference Test Position (RTP). Open the HIT chamber if necessary and, without moving the hearing instrument, adjust the user gain control until the large vertical arrow on the screen prompt disappears. Press <Continue> to resume the test.

If you are unsure which test sequence to run, try [AGC] first. If attack and release times are all near zero, the instrument is probably linear.

FastFacts 8.4: ANSI 1996 Linear and AGC tests

8.5 ANSI 2003 Linear and AGC tests

- 1) Press <Tests>, then highlight and <PICK> [Linear] or [AGC].
- 2) Highlight and <PICK> [Start test]; test setup instructions will be displayed.
- 3) Refer to [7.11: Coupling the hearing instrument](#), [7.12: Positioning the hearing instrument](#) and [2.5: Battery pill use and care](#) to prepare the instrument for testing.
- 4) **Turn the instrument ON.**
- 5) Set the gain control (manual or programmable) to maximum with all other controls set to provide the widest frequency response, greatest gain and highest maximum output. AGC controls and/or programmable parameters should be set to **minimize** AGC action (AGC off or threshold high, compression ratio close to 1).
- 6) Press <Continue> to run the test or press <Cancel> to abort the test. Note that, if required, the RM500SL will pause during the test to request that the gain control be adjusted to the Reference Test Setting (RTS). If necessary, open the HIT chamber and, without moving the hearing instrument, adjust the gain control until the large vertical arrow on the screen prompt disappears. Press <Continue> to resume the test.

During the AGC test, the RM500SL will pause to request that AGC controls or programmable parameters be set for **maximum** AGC effect. If the manufacturer does not provide settings to produce maximum AGC effect, use settings that result in the highest gain for soft sounds and the lowest gain for loud sounds. This will typically result in the lowest compression threshold, a flat I/O curve and the longest attack/release times. These are not “typical” characteristics but indicate the adjustment range possible for these parameters.

If you are unsure which test sequence to run, try [AGC] first. If attack and release times are all near zero, the instrument is probably linear.

FastFacts 8.5: ANSI 2003 Linear and AGC tests

8.6 ANSI test results

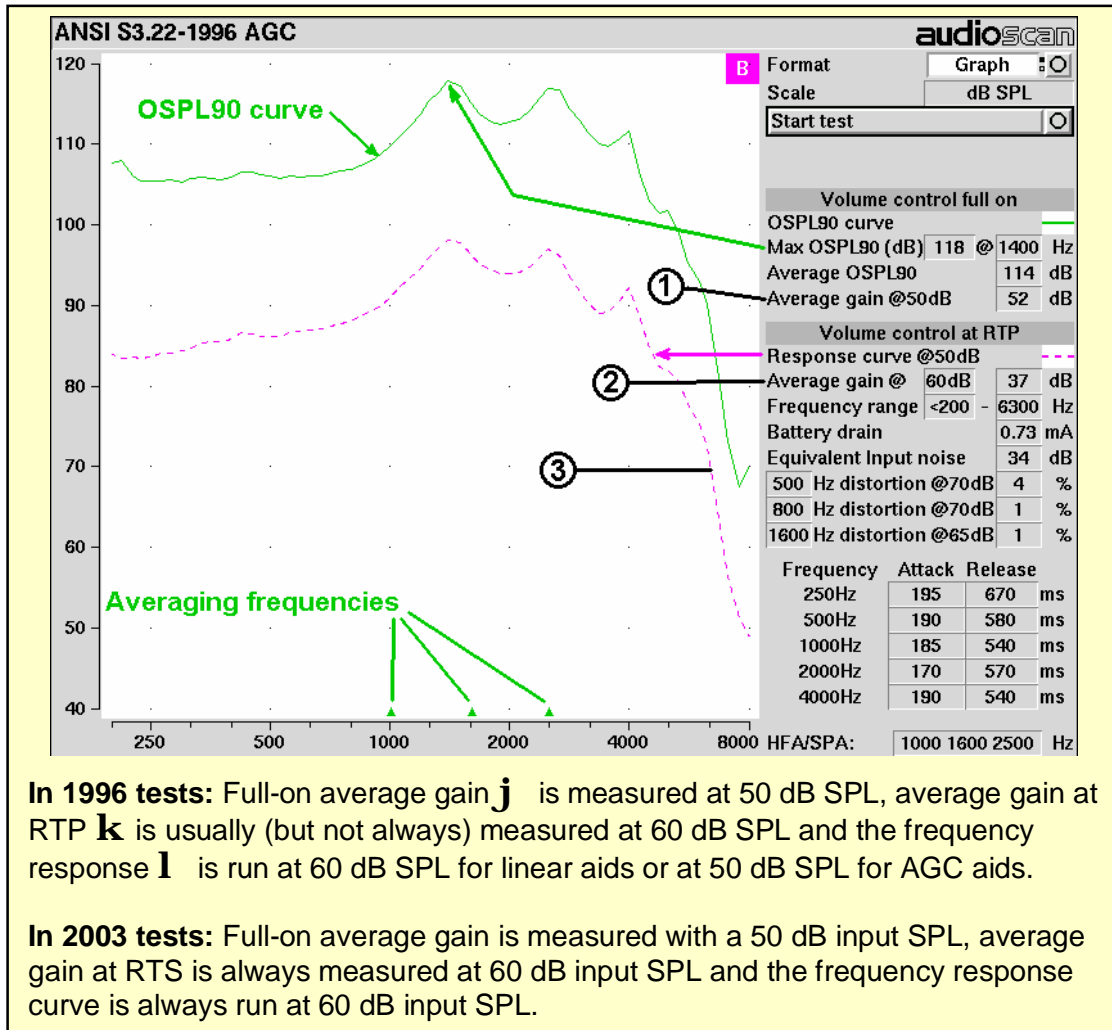

FastFacts 8.6: ANSI test results

8.7 ANSI input-output curves

An input/output curve shows the output level of a hearing instrument as a function of input level and frequency. It is a steady-state pure-tone curve and does not reflect performance with complex signals such as speech.

You may run the tests at any setting of the instrument controls but ANSI S3.22 requires that certain settings be used. See [8.2: ANSI S3.22-1996 facts](#) and [8.3: ANSI S3.22-2003 facts](#). The [Input/Output] test allows you to generate up to 4 separate input/output curves at each of 5 individual frequencies (250, 500, 1000, 2000, 4000 Hz) as provided in ANSI S3.22.

- 1) Press <Tests>, then highlight and <PICK> [Input/Output].
- 2) Refer to [7.11: Coupling the hearing instrument](#), [7.12: Positioning the hearing instrument](#) and [2.5: Battery pill use and care](#) to prepare the instrument for testing.
- 3) **Turn the instrument ON**; set AGC controls or programming parameters as in [8.4: ANSI 1996 Linear and AGC tests](#) or [8.5: ANSI 2003 Linear and AGC tests](#)
- 4) Highlight and <PICK> [Curve 1]. Test setup instructions will be displayed.
- 5) Press <Continue> to generate a set of 5 input/output curves.
- 6) To measure another set of 5 input/output curves, highlight and <PICK> another [Curve #].
- 7) To summon a cursor to determine curve values, position the mouse pointer on a graph area and click the left mouse button. Click again to turn it off.

NOTE: Noise in the test area may cause erroneous results at low input levels (particularly at 250 and 500 Hz). Ensure that the test chamber is well sealed and ambient noise is low.

FastFacts 8.7: ANSI input-output curves

8.8 ANSI telecoil terminology

The RM500SL test chamber contains an integrated telephone magnetic field simulator (TMFS) meeting the requirements of ANSI S3.22, that enable the measurement of coupler SPL produced by a hearing instrument with a telephone pickup coil. ANSI uses the following terms in telecoil testing:

RTG (reference test gain) is the average gain measured with the gain control in the reference test position (1996) or reference test setting (2003). [See 8.2: ANSI S3.22-1996 facts](#) and [8.3: ANSI S3.22-2003 facts](#).

TMFS (Telephone magnetic field simulator). A 38.4-mm diameter coil spaced 16.5 mm below a test surfaced driven by a specified test signal. Intended to simulate a telephone handset receiver.

SPLITS (Coupler SPL for an inductive telephone simulator). SPL developed in a 2cc coupler by a hearing instrument with the gain control in the RTP (1996) or RTS (2003) when the input is the magnetic field generated by a TMFS.

HFA (or SPA) –SPLITS. Average of the SPLITS at HFA or SPA frequencies.

STS (1996 - simulated telephone sensitivity) or **RSETS** (2003 - relative simulated equivalent telephone sensitivity) is calculated as HFA (or SPA) SPLITS minus (RTG + 60). A positive STS or RSETS indicates greater output when using the telephone than when using the microphone.

FastFacts 8.8: ANSI telecoil terminology

8.9 ANSI telephone simulator (TMFS) test

ANSI S3.22 requires that the gain control be set to RTP (1996) or RTS (2003) before running this test. The reference test gain (RTG) is required in order to calculate the STS (1996) or RSETS (2003). The easiest way to meet both requirements is to run a [Linear] or [AGC] test before running this test. See [8.4: ANSI 1996 Linear and AGC tests](#); [8.5: ANSI 2003 Linear and AGC tests](#)

- 1) First, complete a [Linear] or [AGC] test, then press <Tests>.
- 2) Highlight & <PICK> [Telecoil].
- 3) Set the aid to 'T' (telecoil input).
- 4) Highlight and <PICK> [Start TMFS test]. Test setup instructions are displayed.
- 5) Position the aid on the 'T' inscribed on the test chamber floor. BTE aids should lie as flat as possible on the test chamber surface, while custom aids should be oriented with their faceplate parallel to the top surface (if possible) and touching it as shown.
- 6) Press <Continue> to start the test.
- 7) While maintaining the orientation of step 5, move the hearing instrument around on the test chamber surface to maximize the number shown in the 'Maximize Average-SPLITS Value' box.
- 8) Without moving the hearing instrument, press <Continue> to store the Average (HFA-or SPA) SPLITS value and run the SPLITS curve.
- 9) If an RTG has been previously obtained, the STS or RSETS will be shown.



FastFacts 8.9: ANSI telephone simulator (TMFS) test

8.10 Telecoil test results

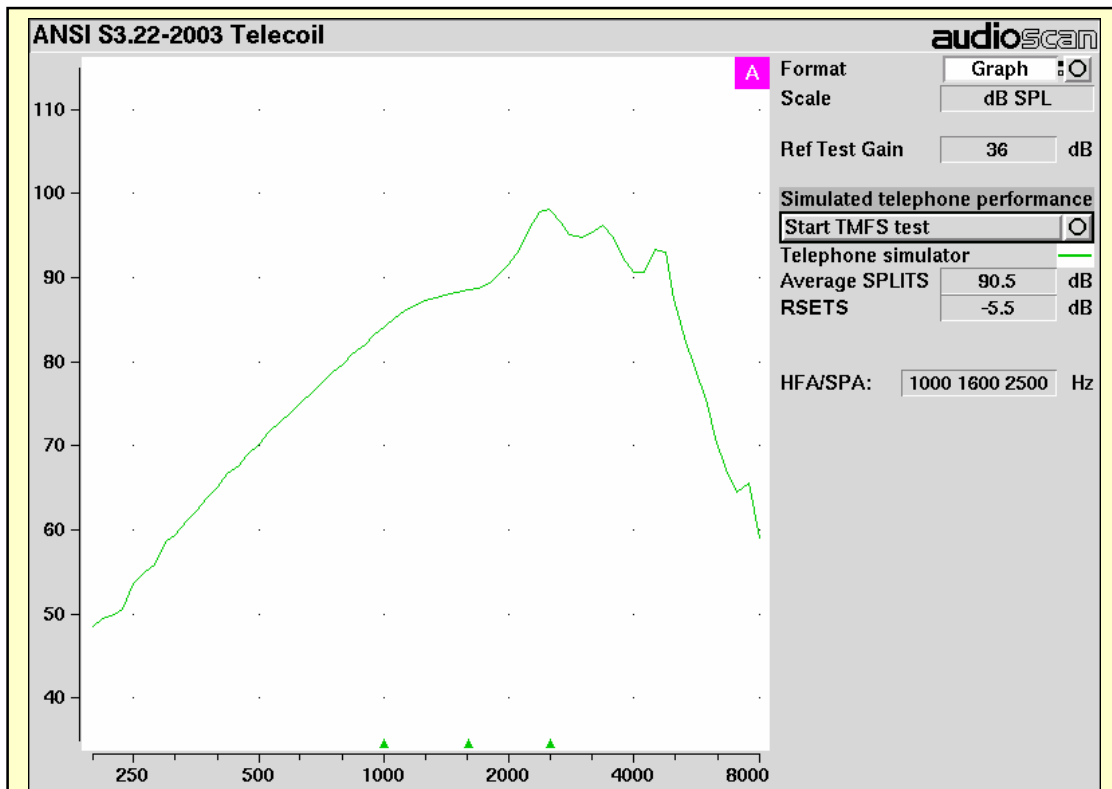

See [8.8: ANSI telecoil terminology](#) for explanation of abbreviations.

Note that the 2003 standard requires that the telecoil test be performed with the AGC set for minimum effect. See [8.3: ANSI S3.22-2003 facts](#).

The 1996 standard requires the manufacturer to specify the AGC settings used for the telecoil test.

FastFacts 8.10: Telecoil test results

9 Other Hearing Instrument Tests

9.1 Section overview

In addition to the tests of ANSI S3.22, the RM500SL provides the following:

Distortion: Harmonic distortion at 2nd or 3rd harmonics and 2nd plus 3rd with input levels varying from 60 – 90 dB SPL.

Multicurve: 1 – 4 curves of coupler SPL or coupler gain for swept tones or pink noise in 1/12th octaves at selected input SPL of 0 or 40 to 90 dB in 5 dB steps. Can be used as a 1/12th octave **spectrum analyzer** by setting stimulus to 0 dB.

Battery drain: A 10 second test of battery current drain with no acoustic input, a 1 kHz 65 dB input SPL, and an average for 90 dB input SPL at the HFA or SPA frequencies selected in Setup. **Optional battery pills are required.**

Manual control: Coupler and HIT reference mic. SPL at selected 1/12th octave frequencies and stimulus SPL of 0 and 40 – 90 dB in 5 dB steps. Can be used as a dual channel **sound level meter** with 1/12th octave, A and C filters.

This section covers the following topics:

[9.2: Harmonic distortion](#)

[9.6: Battery drain](#)

[9.3: Multicurve procedure](#)

[9.7: Manual control procedure](#)

[9.4: Multicurve results](#)

[9.8: Sound level meter using manual control](#)

[9.5: Spectral analysis in Multicurve](#)

FastFacts 9.1: Other hearing instrument tests

9.2 Harmonic distortion

This test measures harmonic distortion at 2nd or 3rd harmonics with input levels varying from 60 – 90 dB SPL. It also presents the sum of 2nd and 3rd harmonics as total harmonic distortion (THD). For hearing aids, this differs little from true THD.

- 1) Press <Tests>, then highlight and <PICK> [Distortion].
- 2) Refer to [7.11: Coupling the hearing instrument](#), [7.12: Positioning the hearing instrument](#) and [2.5: Battery pill use and care](#) to prepare the instrument for testing.
- 3) **Turn the hearing instrument ON.**
- 4) Highlight and <Pick> [Start test].
- 5) Highlight and <PICK> [Harmonics], then highlight and <PICK> THD, 2nd or 3rd from the drop-down list.
- 6) Highlight and <PICK> [Input], then highlight and <PICK> the desired input level (60 – 90 dB SPL) from the drop-down list.
- 7) Press <Continue> to run the test. Distortion will be displayed at 1/3 octaves in graphic and in tabular form.

FastFacts 9.2: Harmonic distortion

9.3 Multicurve procedure

Multicurve generates 1 to 4 output or gain response curves using either pink noise or swept pure tones at input levels ranging from 40 – 90 dB SPL and 0 dB (off).

- 1) Press <Tests>, then highlight and <PICK> [Multicurve].
- 2) Refer to [7.11: Coupling the hearing instrument](#), [7.12: Positioning the hearing instrument](#) and [2.5: Battery pill use and care](#) to prepare the instrument for testing. **Turn the instrument ON.**
- 3) Highlight and <PICK> button 1, 2, 3 or 4 in the Test column.
- 4) Highlight and <PICK> the Stimulus window, then highlight and <PICK> either [Pink noise] or [Swept] from the drop-down list.
- 5) Highlight and <PICK> the Level window for the selected Test, then highlight and <PICK> a stimulus level from the drop-down list.
- 6) Press <Continue> to run a sweep or to capture a pink noise curve; press <Cancel> to abort the test.
- 7) To measure another response curve, highlight and <PICK> another test button; to overwrite a curve, highlight and <PICK> its test button.

To change scale from dB SPL to dB Gain, highlight & <PICK> the Scale window.

FastFacts 9.3: Multicurve procedure

9.4 Multicurve results

- 1) **Output** curves for the noise signal are in 1/12th octave bands. They will be approximately 18 dB lower than pure tone curves for a linear instrument.
- 2) **Gain** curves for a linear instrument will be the same for both swept and pink noise test signals.
- 3) For compression instruments, both gain and output curves may be expected to differ for the two test signals.
- 4) See [7: Hearing Instrument Tests Setup](#) to change screen appearance.

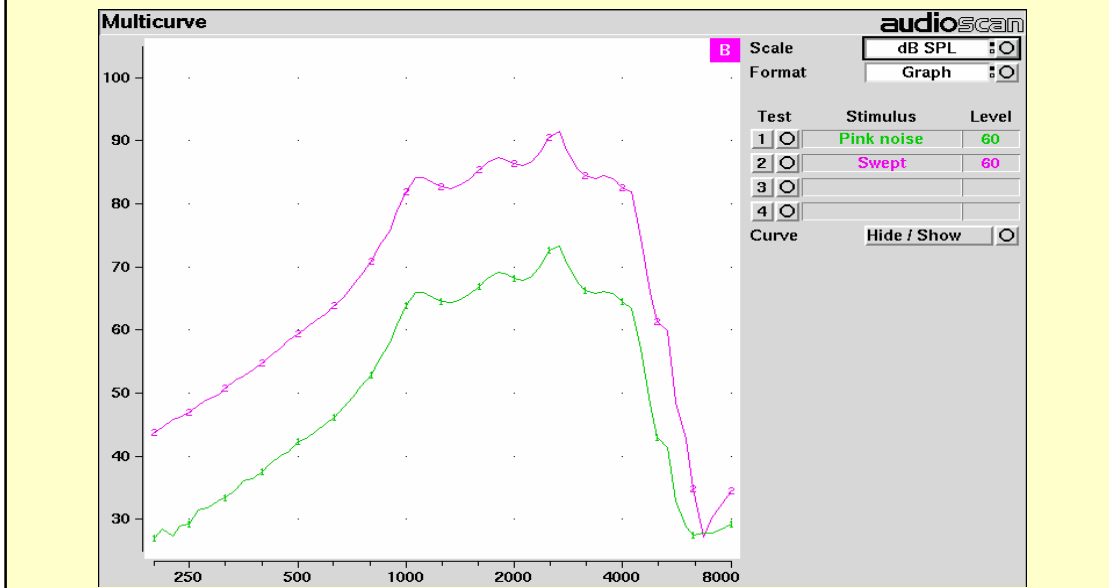

FastFacts 9.4: Multicurve results

9.5 Spectral analysis in Multicurve

Selecting a stimulus level of 0 dB (off) in [Multicurve] presents a spectral analysis of the coupler microphone signal (Scale = dB SPL) or the difference between the coupler and reference microphone spectra (Scale = dB Gain).

If the stimulus type is [Pink noise], the analysis is performed in 1/12th octave bands and displayed in real time. Pressing <Continue> captures the displayed spectrum.

If the stimulus type is [Swept], a swept filter analysis is performed in 1/12th octave bands and displayed at 1/3rd octave frequencies. Pressing <Continue> causes the swept filter analysis to be performed in 1/12th octave bands and displayed at 1/12th octave frequencies.

FastFacts 9.5: Spectral analysis in Multicurve

9.6 Battery drain test

The battery drain test automatically measures the battery current when there is no input signal (quiescent), when the input signal is a 1 kHz tone at 65 dB SPL and the average of the currents when the input signal is 90 dB SPL at the HFA or SPA frequencies (Avg @ 90 dB). Battery life is estimated assuming 80% quiescent and 20% Avg @ 90 dB use. **Optional battery pills are required.**

With the hearing instrument set as normally used:

- 1) Install and connect the proper battery pill. See [2.5: Battery pill use and care](#)
- 2) Highlight and <PICK> Battery drain from Hearing Instrument Tests list.
- 3) Highlight and <PICK> [Battery type] and select from drop-down list.
- 4) Highlight and <PICK> [Hours per day] and select from drop-down list.
- 5) Highlight and <PICK> [Start test]

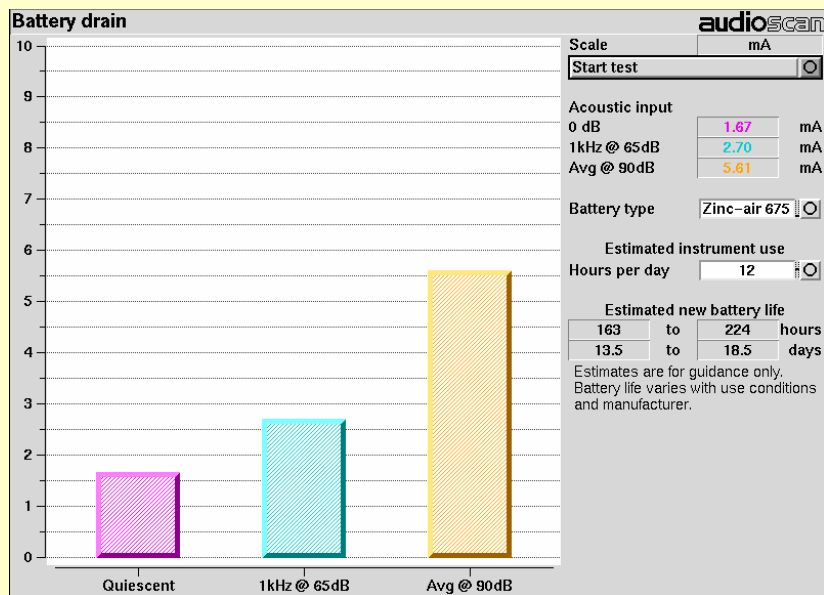

FastFacts 9.6: Battery drain test

9.7 Manual control procedure

Manual control displays the reference microphone SPL, the coupler microphone SPL, their difference in dB (gain) and coupler microphone signal distortion at any selected 1/12th octave frequency and at a selected input level from 40 to 90 dB (in 5 dB steps) and at 0 dB (off).

- 1) Press <Tests>, then highlight and <PICK> [Manual control].
- 2) Highlight and <PICK> the Level window, then highlight and <PICK> the desired stimulus level from the drop-down list.
- 3) Highlight and <PICK> the Frequency window, then highlight and <PICK> the desired frequency from the drop-down list. (Distortion measurement data is available only from 200-4000 Hz.)
- 4) Highlight and <PICK> [Start test] to start the test. [Start test] changes to [Stop Test]. To stop the measurement, highlight and <PICK> [Stop test]. You may change Level and Frequency without stopping the test.

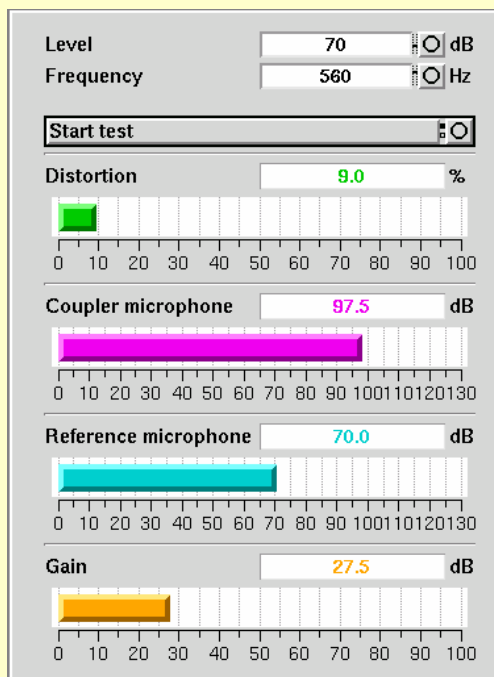

FastFacts 9.7: Manual control procedure

9.8 Sound level meter using manual control

When set for a stimulus level of 0 dB (off), the Manual control mode allows the RM500SL to be used as a sound level meter. Sound at the HIT reference microphone and the coupler microphone may be analyzed by 1/12th octave, A-weighted or C-weighted filters. A and C-weighted measurements are limited to frequencies above 100 Hz and the averaging time and update rate are 384 ms.

- 1) Press <Tests>, then highlight and <PICK> [Manual control].
- 2) Highlight and <PICK> the Level window, then highlight and <PICK> 0 dB stimulus level from the drop-down list.
- 3) Highlight and <PICK> the Filter window, then highlight and <PICK> 1/12th octave, A-weighted, or C-weighted from the drop-down list.
- 4) For 1/12th octave filter, highlight and <PICK> the Frequency window, then highlight and <PICK> the desired frequency from the drop-down list.
- 5) Highlight and <PICK> [Start test] to start the test. [Start test] changes to [Stop Test]. To stop the measurement, highlight and <PICK> [Stop test]. You may change Level and Frequency without stopping the test.

NOTE: A microphone extension cable (VA-130) is available from Audioscan. Standard audio extension cables should not be used. They will substantially increase noise levels.

FastFacts 9.8: Sound level meter using manual control

10 Real-Ear Measurement Setup

10.1 Section overview

For safe and effective operation, the Real-Ear Measurement (REM) system must be properly set up and calibrated, the client must be properly positioned and the probe tube must be properly positioned in the ear canal. Note that the REM speaker is in the lid of the test chamber which must be open to a near-vertical position for all real-ear measurements.

Real-Ear Unaided Response (**REUR**): SPL, or band SPL, in the open (unaided) ear canal for a given stimulus.

Real-Ear Unaided Gain (**REUG**): Difference, in dB, between the REUR and the stimulus SPL, or stimulus band SPL.

Real-Ear Aided Response (**REAR**): SPL, or band SPL, in the ear canal for a given stimulus, with a working hearing aid in place.

Real-Ear Aided Gain (**REAG**): Difference, in dB, between the REAR and the stimulus SPL, or stimulus band SPL.

Real-Ear Saturation Response (**RESR**): The REAR obtained using a narrow-band signal at a level high enough to saturate the hearing aid (usually 85 - 90 dB SPL).

Real-Ear-to-Coupler Difference (**RECD**): Difference, in dB, between the real-ear SPL and the 2cc coupler SPL produced by the same transducer driven by the same signal.

This section covers the following topics:

[10.2: REM calibration facts](#)

[10.6: ABR nHL to eHL setup](#)

[10.3: Calibration of REM probe microphone](#)

[10.7: Positioning the client](#)

[10.4: Calibration check for probe module](#)

[10.8: Positioning the probe tube](#)

[10.5: Max TM SPL setup](#)

FastFacts 10.1: Real-ear measurement setup

10.2 REM calibration facts

The probe microphone and its associated tubing does not have a flat frequency response. The REM calibration process compares this response with the flat, factory-calibrated response of the REM reference microphone and compensates all subsequent probe-tube measurements for this difference. It may be performed as often as desired but will be invalidated at 1 am the following day or at 1 am the following Monday, depending on the choice of Daily or Weekly calibration interval. After the calibration has expired, you will be prompted to calibrate whenever you attempt a test that uses the REM microphones.

It is suggested that a copy of the calibration curves for the probe modules when new be posted near the RM500SL for comparison with daily or weekly curves. If there is a drift in calibration with time, the module may need replacement. See [10.4: Calibration check for probe module](#).

Calibration should be repeated if probe modules are switched or if a probe-tube with different dimensions is installed.

FastFacts 10.2: REM calibration facts

10.3 Calibration of REM probe microphone

Ensure the probe microphone assembly to be calibrated is plugged into the appropriate jack. See [2.3: Microphone connection](#) and [10.2: REM calibration facts](#)

- 1) Open the test chamber and elevate the speaker to its vertical position.
- 2) Press <Tests>, then highlight & <PICK> [Calibration] from the REM column.
- 3) Press the enlarged end of a probe tube as far as it will go, into the recessed opening at the top of the probe module.
- 4) Position the open end of the probe tube in front of the reference microphone inlet and press it between the posts as shown.
- 5) Hold the probe module 5 – 6 inches (12.5 - 15 cm) away from and directly in front of the loudspeaker. Orientation of the probe module is not critical.
- 6) Press <PICK> to calibrate. The resulting curve should be similar in shape to that shown but may be shifted ± 5 dB.
- 7) To change the calibration interval, highlight & <PICK> [Daily] or [Weekly].

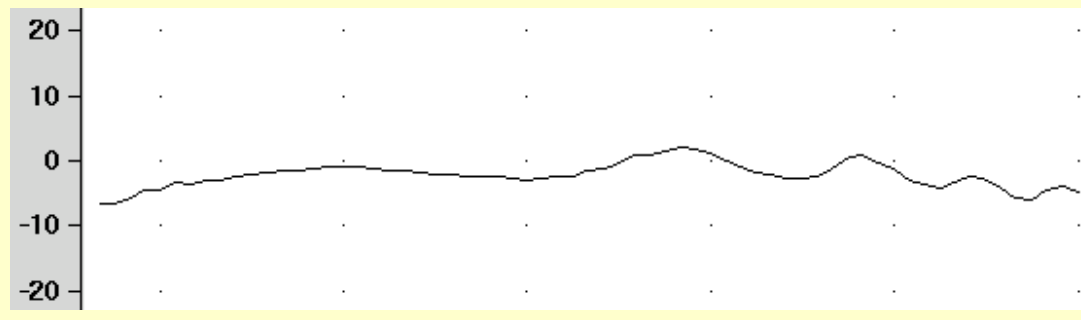
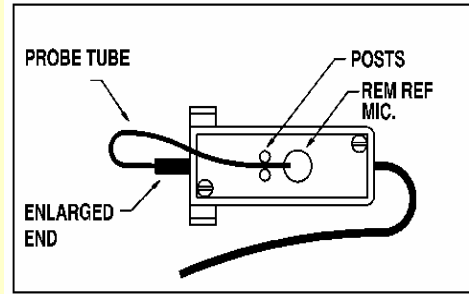

FastFacts 10.3: Calibration of REM probe microphone

10.4 Calibration check for probe module

The calibration curve for the probe module is a comparison of the response of the probe microphone (with tube) to the response of the REM reference microphone. Any change in the curve indicates a change in one of these microphones (or the probe tube). See [10.3: Calibration of REM probe microphone](#). As part of a regular calibration schedule, or to investigate changing calibration curves, the REM reference microphone may be checked against a high quality sound level meter.

- 1) Press <Tests>, then highlight and <PICK> REM [Manual control].
- 2) Highlight & <PICK> [Level], then highlight & <PICK> 70 from the drop-down list.
- 3) Highlight and <PICK> [Frequency], then highlight and <PICK> 2000 Hz from the drop-down list.
- 4) Highlight, then <PICK> [Start test] (which changes to [Stop test]).
- 5) Hold the probe module about 18" (0.5 m) in front of the REM speakers.
- 6) Hold the microphone of a calibrated sound level meter next to the REM reference microphone as shown. Set the sound level meter to C weighting and slow.
- 7) The sound level meter should read 70 ± 2 dB.
- 8) Repeat with the frequency at 250 Hz.
- 9) To stop the measurement, highlight and <PICK> [Stop test].

The probe module should be replaced if it fails this test.

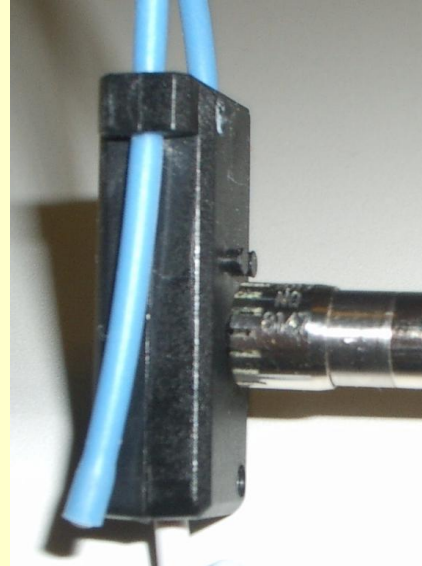

FastFacts 10.4: Calibration check for probe module

10.5 Max TM SPL setup

The Max TM SPL safety feature allows you to set a limit on the SPL, measured by the probe microphone, above which a test terminates. The MAX TM SPL limit is shown on all REM screens. The default limit is 120 dB.

To choose a different Max TM SPL setting:

- 1) Press <Setup>, then highlight and <PICK> [Max TM SPL].
- 2) Highlight and <PICK> the current Max TM SPL setting.
- 3) Highlight and <PICK> the desired Max TM SPL setting from the drop-down list.
- 4) Press <Continue> to exit Setup.

This Max TM SPL setting will be in effect until you change it.

If the limit is exceeded during a real-ear test, the RM500SL will terminate the test and display the message “**MAX TM SPL EXCEEDED**”. You must then decide to either adjust the maximum output limiting of the hearing instrument or increase the Max TM SPL setting following the steps above.

If the MAX TM SPL limit has been disabled, a notice will appear on each real-ear screen. Also, a message reminding you that the MAX TM SPL limit has been disabled will appear when you select a real-ear test.

FastFacts 10.5: Max TM SPL setup

10.6 ABR nHL to eHL setup

Estimated Hearing Level (eHL): An estimate of the behavioral pure tone threshold that accounts for a measured ABR threshold.

Normalized Hearing Level (nHL): (a) Stimulus peak-to-peak equivalent SPL (pe SPL) at ABR threshold relative to the average stimulus pe SPL at ABR threshold of a normal-hearing jury OR (b) stimulus SPL at ABR threshold relative to the average stimulus SPL at behavioral threshold of a normal-hearing jury for the same stimulus. (Note that in this latter case, nHL is equivalent to eHL).

In Speechmap/DSL you have the option of entering ABR thresholds in either eHL or nHL. If eHL is selected, the threshold is treated as if it were a behavioral pure-tone threshold. If nHL is selected, the entered data will first be converted to eHL before SPL threshold and fitting targets are calculated. To do this, appropriate eHL to nHL conversion factors must be applied. You can choose to apply default conversion factors or enter new ones for each client.

This setup allows you to select the **default** conversion factors that are applied in Speechmap/DSL to convert ABR nHL threshold to eHL threshold.

- 1) Press <Setup>, then highlight and <PICK> [ABR eHL to nHL].
- 2) Highlight and <PICK> [DSL defined] or [User defined]
- 3) For [User defined], enter conversion factors using a mouse, the keypad or a keyboard. See [18.2:Assessment data entry](#).

When using the barcode option, both entered nHL data and the nHL to eHL conversion factors are printed as a single barcode. See [3.3: Barcode data input](#).

FastFacts 10.6: ABR nHL to eHL setup

10.7 Positioning the client

Sound reflections from nearby surfaces (including the operator) can cause large measurement errors. Room noise can increase test time, cause errors and alter the operation of the hearing instrument being evaluated.

- 1) Choose a quiet location and position the client and the real-ear speaker at least 1.5 m (5 feet) away from any hard surfaces.
- 2) The speaker mounted in the lid of the test chamber is used for real-ear measurements. It is normally used with the lid in a near-vertical position but the elevation may be changed by opening the lid past vertical.
- 3) Position the client directly in front of, and facing, the front REM speaker at a distance of 18" to 36" (45 to 90 cm) from the center of the head. The speaker and the head should be at approximately the same level.

FastFacts 10.7: Positioning the client

10.8 Positioning the probe tube

- 1) Use an otoscope to ensure there is no ear canal obstruction (e.g. cerumen) and to get a sense of ear canal length.
- 2) Install a new probe tube on the probe module. Set the black marker ring approximately 28 mm from end of probe tube for adult females, approximately 30 mm from end of probe tube for adult males and approximately 20-25 mm from end of probe tube for children. These positions may be modified based on the otoscopic examination. (Tip - the probe module body is 28 mm long.)
- 3) Hang the probe module on the ear, as shown. **The reference microphone should face outwards.**
- 4) Adjust the blue cord until the probe module is snug against the head, directly below the earlobe (cheek level). To facilitate this, clip the probe module cable to clothing on the side opposite the test ear and draw the cable snug.
- 5) Hold the front blue cord so that it passes behind the ear canal entrance and pass the end of the probe tube in **front** of the blue cord and into the ear canal.
- 6) Carefully slide the probe tube into the ear canal until the marker ring approaches the intertragal notch. Then let the front blue cord move forward to hold the probe tube in place. **Use an otoscope to verify that the tube is 2 to 5 mm from the eardrum.**

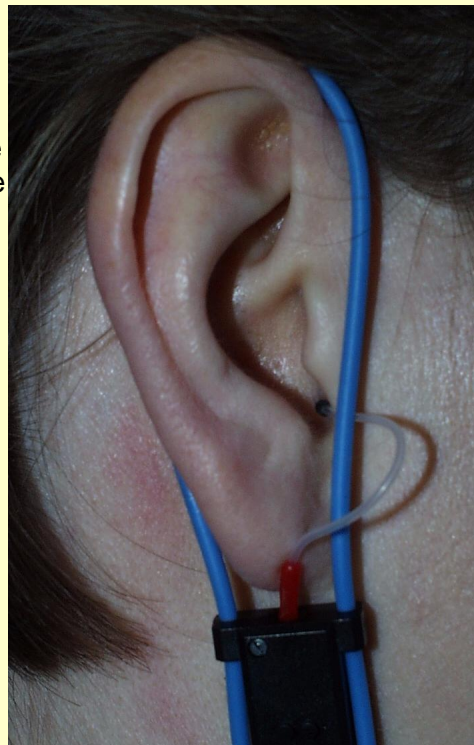

FastFacts 10.8: Positioning the probe tube

11 REM Screen Setup

11.1 Section overview

To accommodate your working preferences, the appearance of REM screens may be changed in several ways.

This section covers the following topics:

11.2: REM right or left ear display

11.4: SPL or HL scale

11.3: Graph, table or 2cc target format

11.5: Hide or show REM curves

FastFacts 11.1: REM screen setup

11.2 REM right or left ear display

The RM500SL can retain and display REM test results for two ears. To switch between left and right test results, press the <Left/Right> key.

FastFacts 11.2: REM right or left ear display

11.3 Graph, table or 2cc target format

Most REM test screens may be viewed in graphic or tabular format.

- ✓ In RECD, highlight and <PICK> [Format] to toggle between [Graph] and [Table] views.
- ✓ In Speechmap and Insertion gain, highlight and <PICK> [Format], then highlight and <PICK> [Graph], [Table] or [2cc targets] from the drop-down list.
- ✓ In [2cc targets] format, reserve gain and fitting formula may be changed. Highlight & <PICK> the appropriate window, then highlight & <PICK> the reserve gain or fitting formula from the drop-down list.

In Speechmap, if DSL or NAL-NL1 has been selected as a target method, then 2cc coupler targets for user gain, full-on gain and OSPL90 are provided. The full-on gain is just the user gain plus the reserve gain. If no target method has been selected, only 2cc OSPL90 values are indicated. **Target gains are for speech-like signals at a 70 dB input SPL; OSPL90 targets are for 90 dB pure tones.**

Real-ear targets are converted to 2cc coupler values by using age-appropriate average or measured (if available) RECD values and the appropriate microphone location effects for the desired style of hearing instrument.

The gain values given assume the hearing instrument is linear for a 70 dB speech input. This assumption is necessary to allow the microphone location effects to be incorporated.

For BTE and body aids, the 2cc coupler values provided assume a fully-occluding earmold with #13 tubing extending to the medial tip of the earmold. If a different type of mold is used, alterations to these values should be made to account for the different acoustic characteristics. For CIC instruments, the 2cc values take into account that the instrument, when deeply inserted into the ear canal, will produce a greater SPL in the ear than that measured in the ITE coupler.

FastFacts 11.3: Graph, table or 2cc target format

11.4 SPL or HL scale

In Speechmap and Insertion gain tests you may view results in either dB HL or dB SPL.

Insertion gain tests view the hearing aid as improving the sound-field threshold. In Insertion gain, the HL scale presents aided results as improved sound-field thresholds while the speech region remains fixed.

Speechmap tests view the hearing aid as increasing the ear canal SPL. Speech gets louder but the threshold remains fixed. On the HL scale in Speechmap, normal ear canal threshold becomes the 0 dB HL line and all data is replotted using this reference. A physical interpretation of the data is difficult and the use of **HL in Speechmap is not recommended**. All instructions given in this guide assume the SPL Speechmap scale.

To change the scale:

Highlight and <PICK> [Scale] to toggle between a dB SPL and dB HL scale.

FastFacts 11.4: SPL or HL scale

11.5 Hide or show REM curves

On screens capable of showing more than one curve, you may show or hide test curves. Hiding a curve does not erase it. To erase curves use the <Session> key.

To hide or show test curve(s):

- 1) Highlight, then <PICK> Curve [Hide/Show].
- 2) Highlight, then <PICK> the desired test curve to toggle between Hide or Show. The curve will toggle on or off when selected.
- 3) Press <Continue> to return to the test screen.

FastFacts 11.5: Hide or show REM curves

12 REM Manual Control

12.1 Section overview

Manual control displays the reference microphone SPL, the probe microphone SPL, their difference in dB (gain) and probe microphone signal distortion at any selected 1/12th octave frequency and at a selected input level from 40 to 90 dB (in 5 dB steps) and at 0 dB (off). With the stimulus turned off, the probe module becomes a dual channel sound level meter with a choice of 1/12th, A and C filters in both channels.

This section covers the following topics:

[12.2: Manual control measurements](#) [12.3: Sound level meter using REM probe](#)

FastFacts 12.1: REM Manual Control

12.2 Manual control measurements

- 1) Refer to [10: Real-Ear Measurement Setup](#) to prepare the system for use and for proper positioning of the client and the probe tube.
- 2) Press <Tests>, then highlight and <PICK> [Manual control].
- 3) Highlight and <PICK> the Level window, then highlight and <PICK> the desired stimulus level from the drop-down list.
- 4) Highlight and <PICK> the Frequency window, then highlight and <PICK> the desired frequency from the drop-down list. (Distortion measurement data is available only from 200-2500 Hz.)
- 5) Highlight and <PICK> [Start test] to start the test. [Start test] changes to [Stop Test]. To stop the measurement, highlight and <PICK> [Stop test]. You may change Level and Frequency without stopping the test.

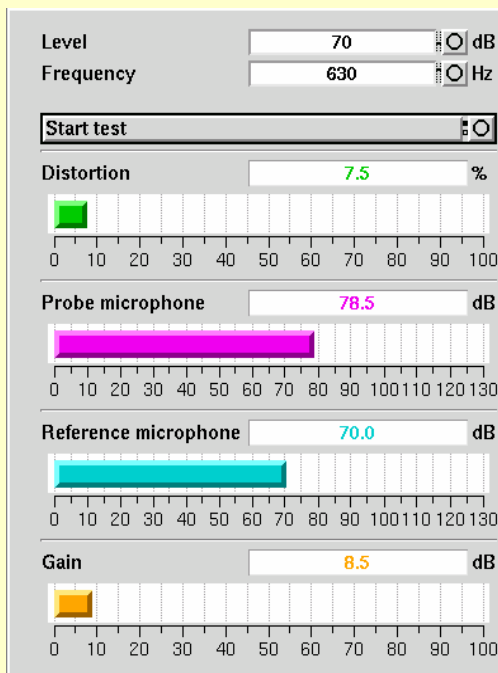

FastFacts 12.2: Manual control measurements

12.3 Sound level meter using REM probe

The manual control feature enables the RM500SL to be used as a sound level meter to perform C-weighted, A-weighted or 1/12th octave analysis of sound as measured by the probe and reference microphones. A and C-weighted measurements are limited to frequencies above 100 Hz and the averaging time and update rate are 384 ms.

- 1) Refer to [10: Real-Ear Measurement Setup](#) to prepare the system for use and for proper positioning of the client and the probe tube.
- 2) Press <Tests>, then highlight & <PICK> [Manual control] in the REM column.
- 3) Highlight and <PICK> the Level window, then highlight and <PICK> 0 dB stimulus level from the drop-down list.
- 4) Highlight and <PICK> the Filter window, then highlight and <PICK> 1/12th octave, A-weighted, or C-weighted from the drop-down list.
- 5) For 1/12th octave filter, highlight and <PICK> the Frequency window, then highlight and <PICK> the desired frequency from the drop-down list.
- 6) Highlight and <PICK> [Start test] to start the test. [Start test] changes to [Stop Test]. To stop the measurement, highlight and <PICK> [Stop test]. You may change Level and Frequency without stopping the test.

FastFacts 12.3: Sound level meter using REM probe

13 Sensory Loss Simulator

13.1 Sensory loss simulator description

A pure conductive loss attenuates loud and soft sounds equally, and is easily simulated by just turning down the volume or inserting an earplug. Losses of a sensory nature are more complex and more difficult to simulate.

The most common sensory loss is caused by outer hair cell damage and results in loss of audibility for soft sounds but near-normal loudness for loud sounds. Inner hair cell damage elevates threshold and reduces loudness for both soft and loud sounds, possibly somewhat more for soft sounds.

This sensory loss simulator (SLS) is intended to allow normal-hearing listeners to hear sounds as if they had the elevated threshold and altered loudness perception caused by outer and inner hair cell damage. It is based on the cochlear hearing loss model described in Moore & Glasberg (2004).

In this simulation, losses less than 58 dB SPL are considered to be due entirely to outer hair cell damage. Any loss greater than this is considered inner hair cell loss.

This SLS does not simulate broadening of the auditory filters or other distortions that may accompany cochlear hearing loss.

For comparison purposes, a simulation of a purely conductive loss is also provided.

To properly experience the simulation, listeners should be within 1m of the REM speaker and in a quiet room.

FastFacts 13.1: Sensory loss simulator description

13.2 Sensory loss simulator operation

Listeners should be within 1m of the REM speaker and in a quiet room.

- 1) Press <Tests>, then highlight and <PICK> [Sensory loss simulator].
- 2) If an audiogram has previously been entered in Speechmap or Insertion gain, go to step 4. Otherwise, highlight and <PICK> [Audiometry].
- 3) Enter HL threshold values using a mouse or the keypad. Left click the mouse on the audiogram form to enter a point. Click again to delete the point. On the keypad use the arrow keys to change frequency and level and press <PICK> to enter or delete a threshold point.
- 4) Press <Continue> when all points have been entered. See [16.4: Audiometric data entry](#) or [18.2: Assessment data entry](#) for more details.
- 5) Highlight and <PICK> [Start test]. Sound, processed to simulate the entered hearing loss, will be presented via the REM speaker.
- 6) Highlight and <PICK> [Stimulus], then highlight and <PICK> a sound to play.
- 7) Highlight and <PICK> [Hearing], then highlight and <PICK> from [Normal, ½ Entered loss, Entered loss].
- 8) Highlight and <PICK> [Type of loss] to toggle between [Sensorineural] and [Conductive] hearing loss simulations.
- 9) Highlight and <PICK> [Cancel] to stop the simulation.

FastFacts 13.2: Sensory loss simulator operation

14 Occlusion Effect Test

14.1 Occlusion effect measurement

- 1) Refer to [10: Real-Ear Measurement Setup](#) to prepare the system for use and for proper positioning of the client and the probe tube.
- 2) Insert the earmold or custom hearing instrument into the ear, being careful not to advance the probe tube further into the ear canal. A lubricant applied to the earmold or custom instrument shell in the vicinity of the probe tube will make insertion easier and prevent slit leaks around the tube.
- 3) **Turn the hearing aid OFF.**
- 4) Press <Tests>, then highlight and <PICK> [Occlusion].
- 5) Highlight and <PICK> [Start test] to start the test. [Start test] changes to [Stop Test].
- 6) While the client vocalizes “ee” in a normal voice, highlight and <PICK> [Stop test] to stop the test and freeze the screen. A red occlusion bar indicates an occlusion problem, a yellow bar indicates a possible problem and a green bar indicates no problem.
- 7) Increase venting and repeat the test until a green bar is obtained.

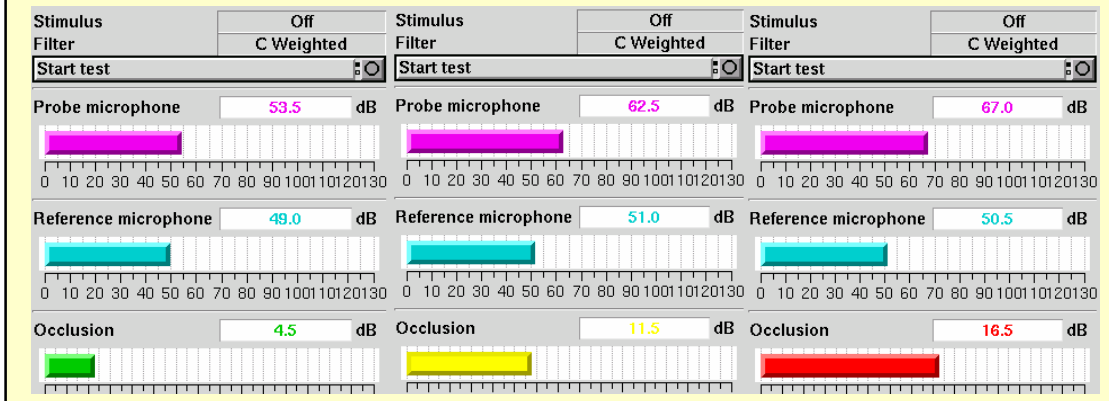

FastFacts 14.1: Occlusion effect measurement

15 RECD (real-ear to coupler difference)

15.1 Section overview

The RECD measurement procedure may be accessed by selecting RECD from the **REM tests** list or from the Audiometry poster within **Speechmap**. An **optional RECD transducer** is required for RECD measurements.

This section covers the following topics:

[15.2: RECD facts](#)

[15.3: RECD coupler response](#)

[15.4: RECD real-ear response](#)

[15.5: RECD results](#)

FastFacts 15.1: RECD (real-ear to coupler difference)

15.2 RECD facts

Individual RECD values are derived by comparing the real-ear SPL for a given test signal to the 2cc coupler SPL for the same test signal. These RECD values are used to: (1) convert HL threshold and UCL obtained using insert phones to SPL values, (2) simulate real-ear measurements from 2cc coupler measures (S-REM); and (3) derive 2cc coupler targets from real-ear aided targets.

If you use insert ear phones for audiometry **OR** **if you verify using S-REM**, you should **measure RECD** (preferred) or use age-related average RECD.

If you use headphones or sound field for audiometry **AND** you **use REM** for verification, **RECD is not applied in any way** and need not be measured.

If you use 2cc coupler targets, you should use measured or age-related RECD.

Insert phone audiometry with measured RECD and REM verification provides the best fitting accuracy, with S-REM verification being slightly less accurate. Insert phone HL data with age-related average RECD is next best.

This software provides average RECDs for 1 - 60 months, 6 - 10 years of age and Adult. A sampling of age-related foam-tip **HA-2 RECD** values is shown below.

Age/Freq	250	500	750	1000	1500	2000	3000	4000	6000
1 month	3	8	9	12	15	15	16	20	23
12 months	3	6	8	10	10	11	11	15	17
24 months	3	5	7	9	9	10	10	14	15
36 months	3	5	7	9	8	9	9	13	14
60 months	3	5	7	9	7	8	8	13	13
8 yrs - Adult	3	4	6	8	7	7	8	13	13

Values are from DSL 5.0 but differ from DSL in that values for 119 months have been used for ages >119 months. **DSL 5.0 RECDs differ from DSL 4.1 RECDs.**

FastFacts 15.2: RECD facts

15.3 RECD coupler response

Prepare the system for HIT tests. See [2.3: Microphone connection](#), [7.9: Calibration of HIT reference microphone](#). Connect the **optional** RECD transducer to the RECD jack to the left of the test chamber.

- 1) Press <Tests> then highlight and <PICK> [RECD] from the REM tests list.
- 2) If a valid coupler response exists, go to [15.4:RECD real-ear response](#).
- 3) If no coupler response exists or the measurement interval has been exceeded, connect the RECD transducer to the BTE coupler.

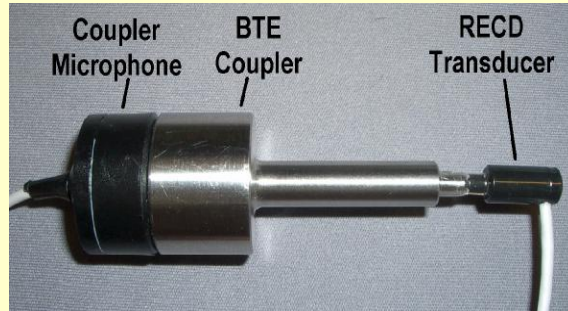

- 4) Highlight and <PICK> [Measure coupler] and follow the setup instructions.
- 5) Press <Continue> to generate the coupler response curve (green). When this curve is stable, press <Continue> to save it.
- 6) Highlight and <PICK> [Daily] or [Weekly] to toggle the measurement interval for the coupler response.

For comparison purposes, an age-related average RECD is shown as a dotted curve on the screen. If you have accessed RECD from the REM tests list, you may highlight and <PICK> the Age box to change the age for this reference curve.

FastFacts 15.3: RECD coupler response

15.4 RECD real-ear response

Connect the RECD transducer to the RECD jack to the left of the test chamber. Prepare the system for REM tests. See [10.3: Calibration of REM probe microphone](#).

- 2) Press <Tests> then highlight and <PICK> [RECD] from the REM tests list.
- 3) If no coupler response exists or the measurement interval has been exceeded, go to [15.3:RECD coupler response](#).
- 4) If a valid coupler response exists, highlight and <PICK> [Measure real ear].
- 5) Refer to [10.8: Positioning the probe tube](#) and insert the probe tube into the ear canal to within 2 - 5 mm of the eardrum.
- 6) Insert the foam tip into the ear, being careful not to advance the probe tube further into the ear canal. Insertion depth should be as used with insert phones. **Allow the foam tip to fully expand in the ear.**
- 7) Press <Continue> to generate the real-ear response curve (pink) and the RECD curve (cyan). If the RECD curve is **negative and unstable** in the low frequencies, check the seal of the foam tip. Increase the tip size and/or apply a lubricant to the foam tip to improve the seal. If the RECD curve deviates more than 10 dB from the average in the 4 - 6 kHz region, check for proper probe placement and possible blockage of the tube by the foam tip or cerumen.
- 8) When these curves are stable, press <Continue> to save them.

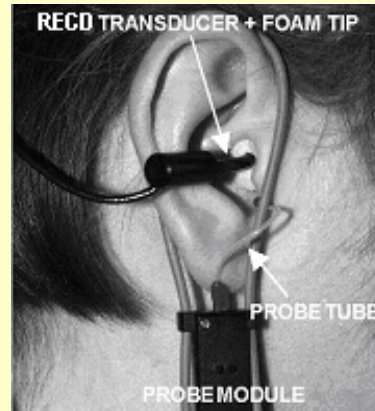

For comparison purposes, an age-related average RECD is shown as a dotted curve on the screen. If you have accessed RECD from the REM tests list, you may highlight and <PICK> the Age box to change the age for this reference curve.

FastFacts 15.4: RECD real-ear response

15.5 RECD results

The RECD measurement screen shows the response of the RECD transducer in the real ear (pink) and in the 2cc coupler (green). The difference between these curves is the RECD (cyan). An age-appropriate average RECD is shown for reference (dotted). A negative RECD below about 1 kHz may indicate a poor seal between the foam tip and the ear canal. A negative RECD above about 3 kHz may indicate the foam tip is blocking the probe tube. See [15.2: RECD facts](#), [15.3: RECD coupler response](#), [15.4: RECD real-ear response](#).

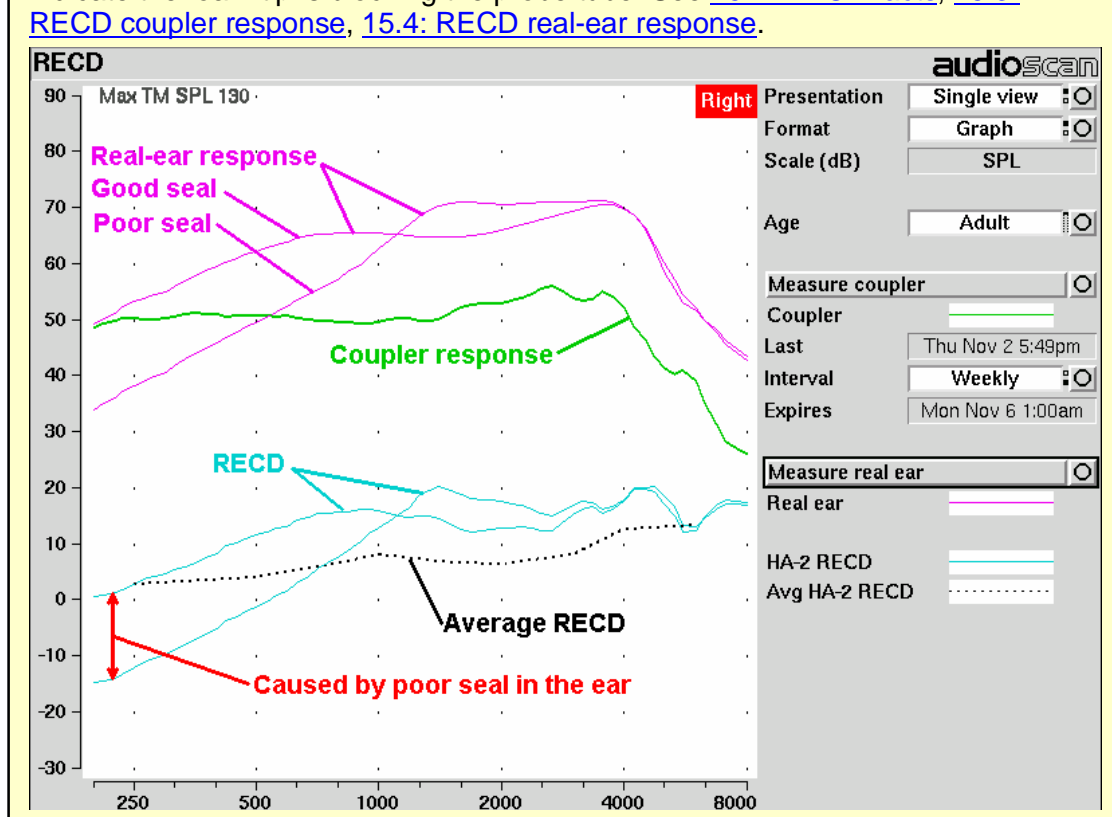

FastFacts 15.5: RECD results

16 Insertion Gain

16.1 Section overview

Insertion gain is the difference between aided and unaided ear canal SPL (REIG = REAG - REUG). It inherently assumes a sound-field audiogram. For non-linear hearing aids, REIG is stimulus-dependent and the dependency is specific to each hearing aid. Insertion gain fitting methods ignore these facts. **Speechmap is recommended for fitting all non-linear hearing instruments.**

Refer to [10: Real-Ear Measurement Setup](#) and [11: REM Screen Setup](#) for terminology and information on preparing the system for use and for proper positioning of the client and the probe tube.

This section covers the following topics:

16.2: Insertion gain in SPL

16.6: REAR measurement procedure

16.3: Insertion gain in HL

16.7: SII calculation in Insertion gain

16.4: Audiometric data entry

16.5: REUR measurement procedure

FastFacts 16.1: Insertion gain

16.2 Insertion gain in SPL

See [10: Real-Ear Measurement Setup](#) and [11: REM Screen Setup](#)

- 1) Press <Tests>, then highlight & <PICK> [Insertion gain] from the REM tests list.
- 2) Highlight and <PICK> [Instrument] to chose from BTE, ITE, ITC, CIC, Body. This changes the CORFIG used for 2cc targets.
- 3) Highlight and <PICK> fitting method to chose from FIG6, NAL-NL1, NAL-R, POGO II, Berger, Libby, User, None

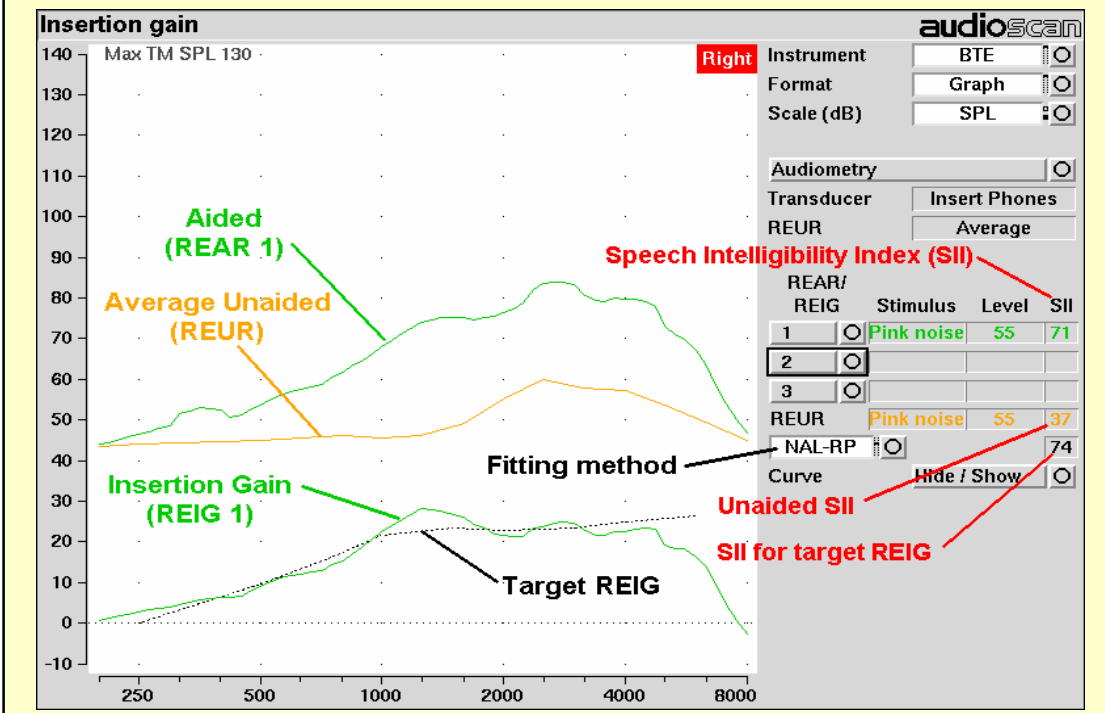

FastFacts 16.2: Insertion gain in SPL

16.3 Insertion gain in HL

See [10: Real-Ear Measurement Setup](#) and [11: REM Screen Setup](#)

- 1) Press <Tests>, then highlight & <PICK> [Insertion gain] from the REM tests list.
- 2) Highlight and <PICK> [Instrument] to chose from BTE, ITE, ITC, CIC, Body. This changes the CORFIG used for 2cc targets.
- 3) Highlight and <PICK> fitting method to chose from FIG6, NAL-NL1, NAL-R, POGO II, BERGER, LIBBY, USER, NONE.

An estimated aided threshold curve is calculated by shifting the unaided threshold curve upward by the REIG. This estimate assumes a) the **unaided threshold is a sound-field threshold** and b) a **linear aid** (i.e. REIG doesn't depend on level).

The REUR curve uses the right-hand SPL scale and is shown for reference only.

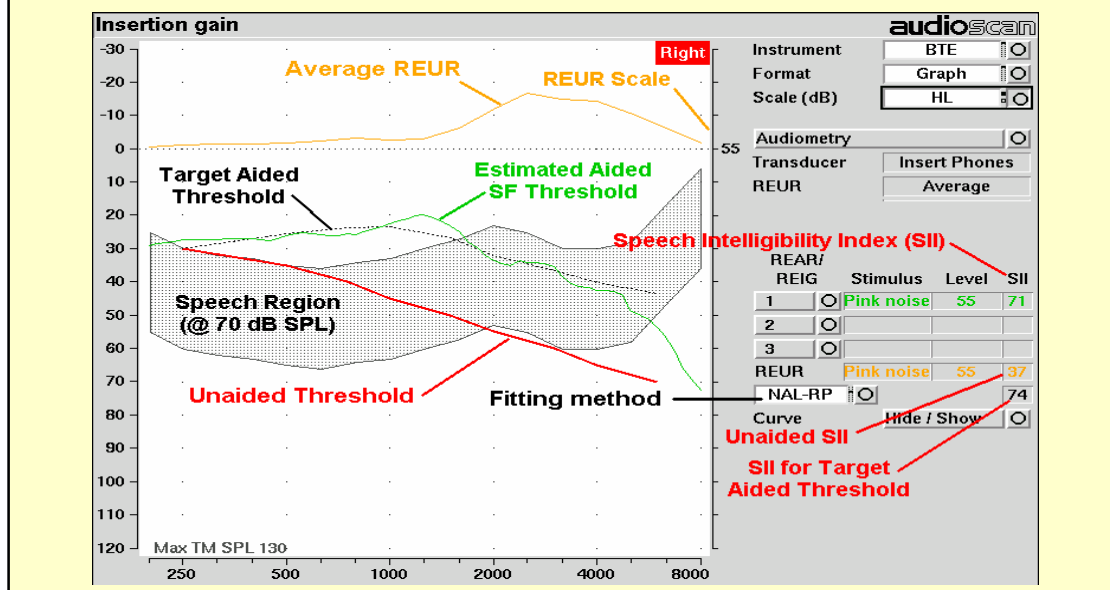

FastFacts 16.3: Insertion gain in HL

16.4 Audiometric data entry

Threshold data and parameters may be entered by scanning a barcode on a previous RM500SL or Verifit printout or manually using a mouse, the keypad or the numeric keypad on an external keyboard. See [2.6: Mouse, keyboard, barcode scanner](#), and [3.2: Input device operation](#).

To enter data from a barcode see [3.3: Barcode data input](#) and:

- 1) Press the barcode trigger and center the red line on the barcode from a distance of 6 - 8". The scanner will beep and the Barcode Entry poster opens.
- 2) Highlight and <PICK> [Done] to accept the data indicated on the poster.

To enter assessment data and parameters manually:

- 1) Highlight and <PICK> [Audiometry].
- 2) Highlight and <PICK> [Transducer], then highlight and <PICK> from the list.
- 3) Highlight and <PICK> [REUR], then highlight and <PICK> to toggle selection.

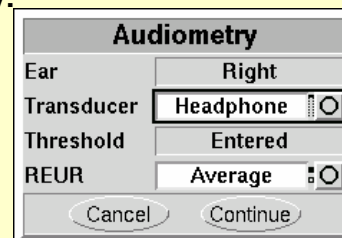

Audiometry	
Ear	Right
Transducer	Headphone
Threshold	Entered
REUR	Average
Cancel Continue	

Measured REUR should be used with a soundfield threshold because individual REUR is part of the threshold. **Average REUR should be used with headphone or insert phone thresholds** because individual REUR isn't part of these thresholds.

- 4) When all selections have been completed, press <Continue>.
- 5) Enter HL threshold values using a mouse or keypad. Left click the mouse on the audiogram form to enter a point. Click again to delete the point. On the keypad use the arrow keys to change frequency and level and press <PICK> to enter or delete a threshold point.
- 6) Press <Continue> when all points have been entered.

FastFacts 16.4: Audiometric data entry

16.5 REUR measurement procedure

Performing a REUR test erases all existing REAR and REIG data for the current test ear. **REUR should be measured only if Transducer = Soundfield.**

Otherwise it is more accurate to use average. See [16.4: Audiometric data entry](#).

- 1) Press <Tests>, then highlight and <PICK> [Insertion gain] from the REM list.
- 2) Referring to [10: Real-Ear Measurement Setup](#) and [11: REM Screen Setup](#), prepare the system, position the patient and insert the probe tube.
- 3) If REUR is set to Average, highlight and <PICK> [Audiometry] then highlight and <PICK> [REUR] to toggle to [Measure]. Press <Continue> to advance to the Threshold entry poster. You may enter threshold data at this time (see [16.4: Audiometric data entry](#)) or press <Continue> to proceed with the measurement.
- 4) Highlight and <PICK> REUR (below REAR/REIG test 3).
- 5) Press <Continue> to accept the default 55 dB SPL Pink noise stimulus and capture the REUR curve OR highlight and <PICK> [Stimulus] and [Level] to select other values. These choices have no impact on the resulting REIG.
- 6) If there is a notch in the 4000 to 8000 Hz region, try advancing the probe tube 2 mm and repeating step 3. If the notch moves to a higher frequency, repeat this step until the notch moves beyond the highest frequency of interest.

Because it is analyzed in 1/3 octave bands, the Noise stimulus produces a REUR 12 dB below that produced by the Swept stimulus at the same overall level.

The Average REUR used is shown at right. Measured REUR will vary from this.

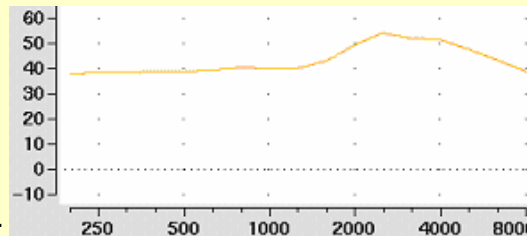

For small children the peak may shift to the right and become sharper. Drainage tubes and perforated ear drums will cause large differences - usually around 1 kHz.

FastFacts 16.5: REUR measurement procedure

16.6 REAR measurement procedure

- 1) Press <Tests>, then highlight and <PICK> [Insertion gain] from the REM list
- 2) Referring to [10: Real-Ear Measurement Setup](#) and [11: REM Screen Setup](#), prepare the system, position the patient and insert the probe tube. (For tight-fitting hearing aids or earmolds, the probe tube may be inserted through a vent.)
- 3) Without disturbing the probe tube, insert the hearing instrument or earmold.
- 4) Referring to [16.4: Audiometric data entry](#), enter threshold data.
- 5) Highlight and <PICK> button 1, 2, or 3 in the REAR/REIG column. This will present a signal from the REM speaker and display the REAR Setup box.
- 6) Highlight and <PICK> [Stimulus], then highlight and <PICK> [Pink noise] or [Swept]. Use pink noise when using the NAL-NL1 fitting formula. Use Swept when testing maximum output capabilities.
- 7) Highlight and <PICK> [Level], then highlight and <PICK> a stimulus level from the list box. Use the level shown on the target REIG curves. If no level is shown, use the lowest level required to overcome background noise.
- 8) Adjust the hearing instrument so that the REIG curve (SPL scale) or Aided threshold curve (HL scale) approximates the dotted target curve. For multi-level targets, match each curve using the stimulus level indicated.
- 9) Press <Continue> to complete the test and capture the data.

See [16.2: Insertion gain in SPL](#) and [16.3: Insertion gain in HL](#) for an explanation of screen curves. [See 16.7: SII calculation in Insertion gain](#)

NOTE: Because it is analyzed in 1/3 octave bands, the Noise stimulus produces a REAR up to 12 dB below that produced by the Swept stimulus at the same overall level. The REIGs will be similar except at levels which cause non-linear operation of the hearing instrument.

FastFacts 16.6: REAR measurement procedure

16.7 SII calculation in Insertion gain

The RM500SL calculates a Speech Intelligibility Index (SII) value (in %) for unaided speech at 70 dB SPL (REUR), the target REIG and for each aided test. The calculations use the 1/3 octave band method of ANSI S3.5 –1997 without the 160 Hz band and without masking effects. Level distortion effects are included but no hearing loss desensitization is applied. An idealized speech region of LTASS +/- 15 dB is used.

The speech recognition associated with a given SII is a function of the test material and the cognitive abilities of the listener. There is considerable individual variability in relating the SII to speech recognition, especially amongst impaired listeners. The following shows expected nominal recognition scores vs SII for normals on the Connected Speech Test (Sherbecoe and Studebaker 2003).

SII (%)	Score (%)
10	1
15	8
20	20
25	45
30	60
35	74
40	84
45	90
50	94
55	96
60	98
70	99
80	100
90	100

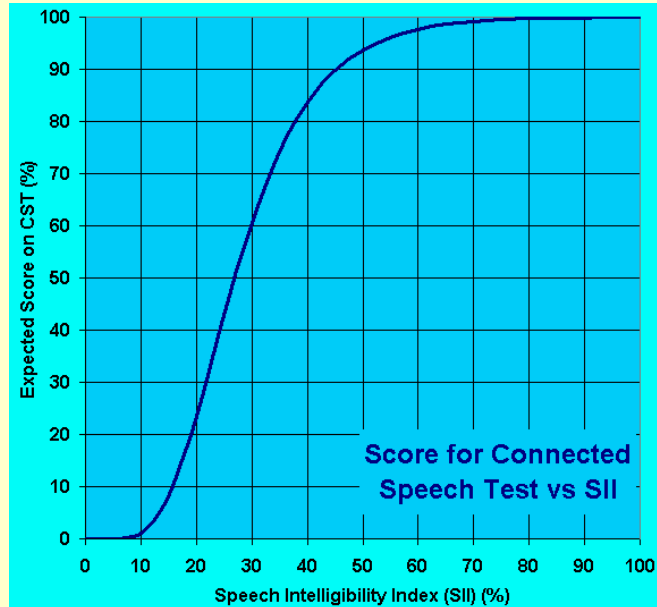

FastFacts 16.7: SII calculation in Insertion gain

17 Speechmap®

17.1 Section overview

Speechmap presents hearing threshold, UCL and amplified speech spectra as SPL in the ear canal. The fitting goal is to make amplified speech audible and comfortable while avoiding discomfort for loud sounds. Speechmap is normally used in SPL and this guide describes only this usage. See [11.4: SPL or HL scale](#).

This section covers the following topics:

[17.2: Speechmap facts](#)

[17.7: Screen tour – unaided screen](#)

[17.3: DSL 5.0 in Speechmap](#)

[17.8: Screen tour - aided screen](#)

[17.4: DSL 5.0 changes](#)

[17.9: REM or S-REM mode](#)

[17.5: NAL-NL1 in Speechmap](#)

[17.10: SII calculation in Speechmap](#)

[17.6: Using Speechmap](#)

Related sections are [18: Speechmap Fitting Procedures](#) and [19: Speechmap Technical Details](#)

FastFacts 17.1: Speechmap

17.2 Speechmap facts

Speechmap is a trademarked hearing instrument fitting environment introduced by Audioscan in 1992. It presents hearing threshold, UCL and amplified speech spectra as SPL in the ear canal. The fitting goal is to make amplified speech audible and comfortable while avoiding discomfort for loud sounds. Originally speech was simulated using amplitude-modulated tonal signals. The RM500SL replaces these simulated speech signals with real speech, both recorded and live. For details of the test signals and analysis methods, see [19: Speechmap Technical Details](#).

Speechmap departs from insertion gain target methods in presenting amplification goals in the context of the residual auditory area, not as an isolated target line, and in the use of real speech, not tones or broad-band noise. This is extremely important for non-linear hearing aids, analog or digital, because their processing is signal-dependent. It also makes provision to correct audiometric data and 2cc coupler measurements for age-related or individually-measured acoustic differences between real ears and the couplers used for calibration and testing.

The Speechmap environment provides two hearing instrument verification options: **REM (real-ear measurement)** and **S-REM (simulated REM)**. See [17.9: REM or S-REM mode](#) for details.

FastFacts 17.2: Speechmap facts

17.3 DSL 5.0 in Speechmap

The **Desired Sensation Level (DSL)** method is a systematic eardrum sound pressure level (SPLogram) approach to hearing instrument fitting that seeks to ensure amplified speech will be audible and comfortable while loud sounds will not be uncomfortable. It takes into account individual acoustic factors in audiometric and electroacoustic data. DSL was developed by the National Centre for Audiology (NCA), London, Ontario. Audioscan has implemented DSL within its Speechmap fitting system since 1994.

In 2005, DSL underwent an extensive revision. **This has resulted in changes to speech targets for children.** These changes will be more significant when the individual RECD values have not been measured for the child being fitted. See [17.4:DSL 5.0 changes](#) and www.audioscan.com for details of the changes.

The Audioscan version of DSL 5.0 may differ from others in the following ways:

- 1) DSL 5.0 uses RECD values for ages > 119 months from a different source than for ages ≤ 119 months; Audioscan has used the RECD values for a 119 month old for ages > 119 months so all values come from the same study.
- 2) Input-output curve targets and compression threshold targets are not provided. Such steady-state parameters are of little value in estimating amplified speech levels. Matching amplified speech to the LTASS targets at levels from 50 to 75 dB SPL provides much better assurance that fitting goals are being met.
- 3) There is no provision to input the number of compression channels. This may be useful when the signal used for verification is not the signal for which the targets were developed. It is irrelevant when using real-speech signals to match speech targets and when using narrow-band signals to match narrow-band maximum output targets.
- 4) The term Uncomfortable Level (UCL) is used rather than Upper Limit of Comfort (ULC) in referring to the ear canal SPL that should never be exceeded.
- 5) Broadband output limiting targets are not provided.

FastFacts 17.3: DSL 5.0 in Speechmap

17.4 DSL 5.0 changes

The Audioscan version of DSL 5.0 includes provision for **bone conduction** and **ABR** threshold, **binaural** targets, targets for speech levels from **50 to 75 dB SPL**, **new targets** for children, **targets for adults** and **new RECD** default values for children (1 month to 10 years) and adults. The **UWO child's spectrum** has been removed and an "**own voice**" spectrum has been added. As a result of a re-analysis of published data, the **vocal effort effects for Soft and Average** speech levels have been made the same. In addition, the target symbol has been elongated to indicate that the fit-to **target is a range, not a point**.

The children's LTASSa targets for 70 dB speech differ from those in previous versions of DSL. These differences are functions of the hearing loss and age (where average RECDs are used) and can be more than 10 dB at 250 Hz but are less at other frequencies. There are two main reasons for this.

- 1) The introduction of the requirement that amplified speech peaks should not exceed UCL. This has the largest impact at 250 Hz and for losses exceeding 50 dB SPL. Targets are generally reduced less than 5 dB for losses under 60 dB HL if RECDs have been measured.
- 2) The introduction of new default average RECDs. Where average RECDs are used, this generally results in a target decrease in addition to that caused by the change in 1) above.

In evaluating the impact of these new targets, it must be remembered that, in most cases, the reduction in SII will be 5 -10 points. An SII change from 70 to 60 predicts a reduction of only 1% on the connected speech test while a change from 60 to 50 predicts a reduction of 4%. See [17.10: SII calculation in Speechmap](#) for more information on the SII.

For more information on the changes in DSL 5.0, visit www.audioscan.com. **Audioscan assumes no responsibility for the validity of these changes; that responsibility rests with the National Centre for Audiology.**

FastFacts 17.4: DSL 5.0 changes

17.5 NAL-NL1 in Speechmap

The **NAL-NL1** procedure seeks to amplify speech such that all bands of speech are perceived with equal loudness while maximizing speech intelligibility and ensuring that the wearer perceives speech to be no louder than that which a normal hearing person would perceive. Although NAL-NL1 states its goals for speech, it derives insertion gain targets assuming noise as a verification signal. Because it is more accurate to verify a non-linear fitting using the signal for which the procedure was developed, Audioscan converts the NAL-NL1 insertion gain targets to LTASS targets for amplified speech in the Speechmap environment, resulting in **Speechmap/NAL-NL1**. The conversions use the same adult average RECD and REUG as used in DSL. The RESR targets are from Hearing Aids (Dillon, Thieme Publishing, 2001, p274).

An insertion gain version is available by selecting [Insertion gain] from the REM tests menu. The pink noise stimulus should be used.

FastFacts 17.5: NAL-NL1 in Speechmap

17.6 Using Speechmap

The Speechmap fitting environment provides a number of distinctly different stimuli. Speech and noise are analyzed in 1/3 octave bands and (except for pink noise) data are presented as 3 curves. The top curve is the level exceeded 1% of the time (speech peaks), the lower curve is the level exceeded 70% of the time (speech valleys) and the middle curve is the average. Starting a test causes the signal to be presented continuously - the speech signals run in a loop - and the curves are updated frequently to show any changes you make to the hearing instrument. Pressing <Continue> restarts the speech passage and the curves are then calculated for the entire passage, producing an accurate display of the speech region and LTASS, and an accurate SII calculation. When using live speech, a <Freeze curve> button captures short-term speech features. See [17.10: SII calculation in Speechmap](#) and [19: Speechmap Technical Details](#).

Before starting, please review [10: Real-Ear Measurement Setup](#), [17.2: Speechmap facts](#), [17.9: REM or S-REM mode](#).

- ✓ **To access Speechmap**, press <Tests>, then highlight & <PICK> [Speechmap] from the REM tests list.
- ✓ **To change screen setup**, see [11: REM Screen Setup](#), and [17.9: REM or S-REM mode](#).
- ✓ **To set up hearing instrument type**, highlight & <PICK> [Instrument], then highlight & <PICK> BTE, ITE, ITC, CIC, Open, Body, CROS or FM. This changes microphone location effects and the RECD used in S-REM and 2cc targets, and the reference microphone used for FM and CROS.
- ✓ **To enter audiometric data**, see [18.2: Assessment data entry](#).
- ✓ **To run a test**, highlight and <PICK> one of the 4 REAR buttons. Then highlight and <PICK> [Stimulus] to select the stimulus type. Highlight and <PICK> [Level] to select stimulus level. Press <Continue> to run the test and display the data. See, [17.7: Screen tour](#) & [18: Speechmap Fitting Procedures](#).

FastFacts 17.6: Using Speechmap

17.7 Screen tour – unaided screen

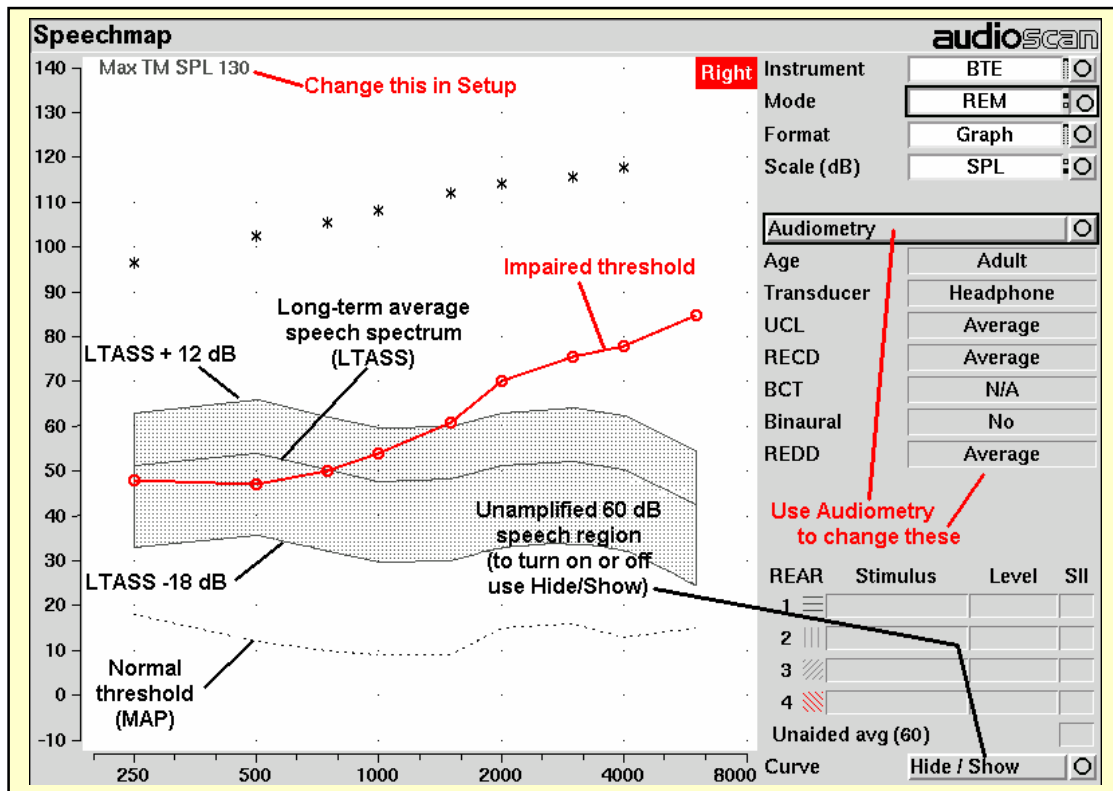

FastFacts 17.7: Screen tour – unaided screen

17.8 Screen tour - aided screen

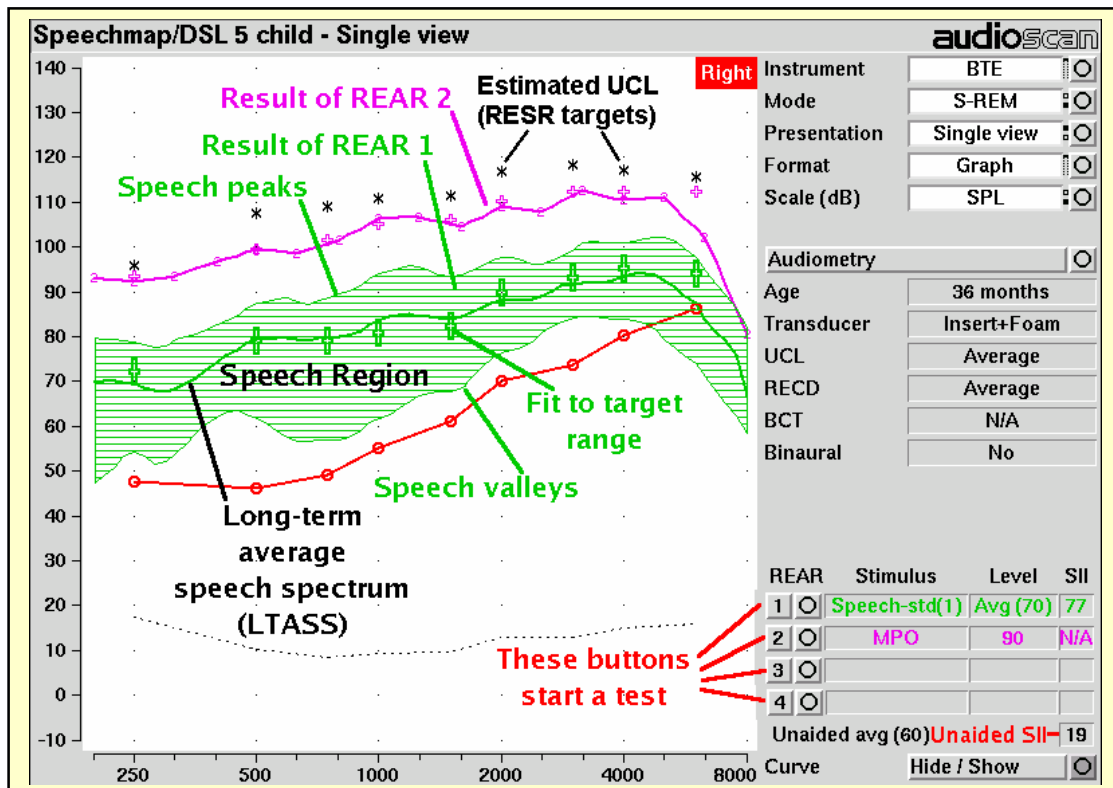

FastFacts 17.8: Screen tour - aided screen

17.9 REM or S-REM mode

The Speechmap environment provides two hearing instrument verification options: **REM (real-ear measurement)** and **S-REM (simulated REM)**. In REM mode, the stimulus is controlled by the REM reference microphone below the ear and SPL in the ear canal is measured by the probe microphone. In S-REM mode, levels measured in the 2cc coupler are converted to estimated ear canal levels using the RECD values (age-appropriate average, entered, or measured). In addition, the stimulus delivered to the hearing instrument microphone is modified to include average microphone location effects for the hearing instrument type indicated. The screen display for both modes is the same, showing SPL, measured or simulated, in the ear canal.

For REM mode, review [10: Real-Ear Measurement Setup](#),

For S-REM mode review [7.9: Calibration of HIT reference microphone](#), [7.11: Coupling the hearing instrument](#), [7.12: Positioning the hearing instrument](#).

It is suggested that hearing instruments be preset in S-REM mode with fine tuning done in REM mode.

✓ Highlight and <PICK> [Mode] to toggle between REM and S-REM.

Note that REM mode should be used for vented or open fittings. Vent effects depend on the vent, the ear and the hearing aid settings.

FastFacts 17.9: REM or S-REM mode

17.10 SII calculation in Speechmap

The RM500SL calculates a Speech Intelligibility Index (SII) value (in %) for unaided speech at 70 dB SPL and for each aided test. The calculations use the 1/3 octave band method of ANSI S3.5 –1997 without the 160 Hz band and without masking effects. Level distortion effects are included but no hearing loss desensitization is applied. An idealized speech region of LTASS +/- 15 dB is used.

The speech recognition associated with a given SII is a function of the test material and the cognitive abilities of the listener. There is considerable individual variability in relating the SII to speech recognition, especially amongst impaired listeners. The following shows expected nominal recognition scores vs SII for normals on the Connected Speech Test (Sherbecoe and Studebaker 2003).

SII (%)	Score (%)
10	1
15	8
20	20
25	45
30	60
35	74
40	84
45	90
50	94
55	96
60	98
70	99
80	100
90	100

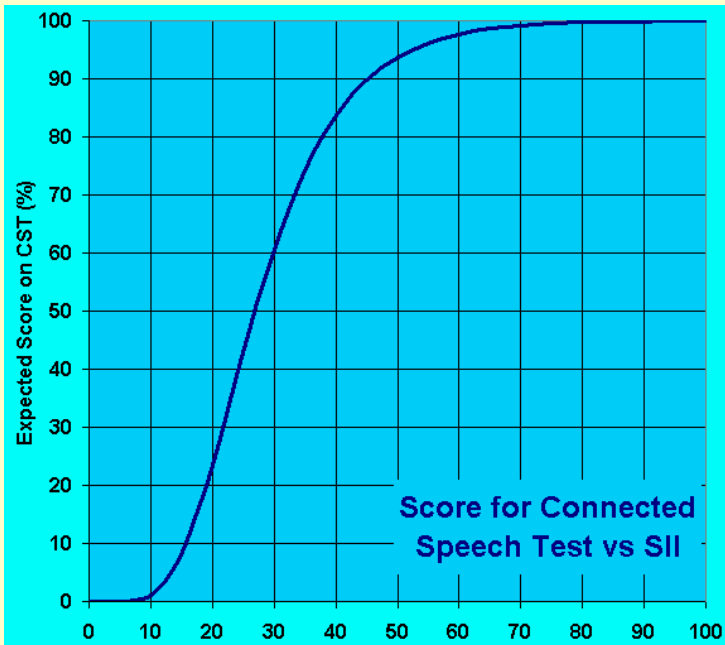

FastFacts 17.10: SII calculation in Speechmap

18 Speechmap Fitting Procedures

18.1 Section overview

The procedures in this section assume a familiarity with [10: Real-Ear Measurement Setup](#), [11: REM Screen Setup](#) and [17: Speechmap ®](#).

This section covers the following topics:

- 18.2: Assessment data entry
- 18.3: Assessment data choices
- 18.4: Assessment data choices - 2
- 18.6: Fitting to targets for loud sounds
- 18.7: Fitting to targets for mid-level speech
- 18.8: Open fittings in Speechmap
- 18.9: FM fitting and verification

Related sections are [17: Speechmap ®](#) and [19: Speechmap Technical Details](#)

FastFacts 18.1: Speechmap fitting procedures

18.2 Assessment data entry

Threshold data and parameters may be entered by scanning a barcode on a previous RM500SL or Verifit printout or manually using a mouse, the keypad or the numeric keypad on an external keyboard. See [2.6: Mouse, keyboard, barcode scanner](#), and [3.2: Input device operation](#).

To enter data from a barcode see [3.3: Barcode data input](#) and:

- 1) Press the barcode trigger and center the red line on the barcode from a distance of 6 - 8". The scanner will beep and the Barcode Entry poster opens.
- 2) Highlight and <PICK> [Done] to accept the data indicated on the poster.

To enter assessment data manually:

- 1) Highlight and <PICK> [Audiometry].
- 2) Highlight and <PICK> an item to toggle its setting or generate a list box. Age can be changed only if Targets = [DSL child]. See [18.3: Assessment data choices - 1](#) and [18.4: Assessment data choices - 2](#).
- 3) Press <Continue> to proceed to data entry.
- 4) Enter HL threshold using a mouse, keypad or keyboard. Left click the mouse on the audiogram to enter a point. Click again to delete the point. On the keypad the arrow keys change frequency and level and <PICK> enters or deletes a threshold point. On a keyboard enter HL values on the numeric keypad.
- 5) Press <Continue> when all points have been entered.
- 6) Repeat the process for Bone conduction, UCL and RECD if [Enter] has been selected for any. If RECD is set to [Measure], see [15: RECD \(real-ear to coupler difference\)](#).

Audiometry	
Ear	Right
Targets	DSL adult
Age	Adult
Transducer	Headphone
Threshold	Entered
Bone conduction	N/A
UCL	Average
RECD	Average
Binaural	Yes
REDD	Average
Cancel Continue	

FastFacts 18.2: Assessment data entry

18.3 Assessment data choices - 1

The following audiometric assessment parameters can be specified in the Speechmap Audiometry setup box. Defaults are the last-used choices if test setup memory has been turned on. [See 4.4: Saving test setup.](#)

- 1) **Target:** Select fitting targets from [DSL adult, DSL child, NAL-NL1, None]. DSL 5 and NAL-NL1 differ in the derivation of amplified LTASS and RESR targets. Selecting [None] eliminates the LTASS targets; UCL estimates are from DSL.
- 2) **Age:** This is permitted for [DSL child] target only. Select client's age in months from [1 months to 60 months] or years from [6 years to 10 years]. For children older than 10 yrs, previously fit using DSL, choose Adult.
- 3) **Transducer:** Type of audiogram. Select from [Headphone, Insert + Foam, Insert + Mold, Soundfield, ABR (eHL), ABR (nHL)]. **If Insert + Foam or Mold** is selected, the appropriate RECD will be used to convert entered HL values to SPL values. **If Soundfield** is selected appropriate real-ear unaided gain (REUG) values @ 45 degrees azimuth, will be used to convert HL values to SPL values. **If ABR (eHL)** is selected, entered thresholds will be treated as behavioral pure tone thresholds. **If ABR (nHL)** is selected, nHL to eHL conversion factors may be selected from [Default, Enter]. In either case, an insert earphone is assumed for sound delivery and the appropriate RECD will be applied. Note that, in some facilities, nHL is defined in such a way that it is effectively eHL; in these cases, ABR (eHL) should be selected. See [10.6: ABR nHL to eHL setup](#) and [18.4: Assessment data choices - 2.](#)
- 4) **Bone conduction:** Select from [N/A, Enter]. If [Enter] is selected, an entry screen will be provided after the air conduction thresholds have been entered.

Continued in: [18.4: Assessment data choices - 2](#)

FastFacts 18.3: Assessment data choices - 1

18.4 Assessment data choices - 2

Continued from: [18.3: Assessment data choices - 1](#)

- 5) **UCL**: Uncomfortable Level. Select from [Enter, Average]. If measured UCL values are entered, these values will be converted to real-ear SPL and used as real-ear saturation response (RESR) targets. Note that DSL 5.0 has changed this term to Upper Limit of Comfort (ULC). Regardless of the acronym, it is a narrow-band SPL that should never be exceeded.
- 6) **RECD**: Select from [Measure, Enter, Average]. If Average is selected, age-appropriate real-ear to coupler difference (RECD) values will be used. If Measure is selected, you will be required to measure the client's RECD values or accept values from the RECD test. If Enter is selected, **HA-2** RECD values may be entered and are required **at all 9 audiometric frequencies**.
- 7) **Binaural**: Select from [Yes, No]. Determines if fitting targets will be adjusted for binaural summation effects.
- 8) **REDD**: Real-ear-to-Dial Difference. [Average] (this cannot be changed). REDD values are similar for adults and children. If Headphone is selected as the transducer type, adult average values will be used to transform dB HL audiometry to dB SPL.

ABR nHL to eHL: Normalized HL to estimated HL conversion factors. Permitted only if [Transducer] = ABR (nHL). Select from [Default, Enter]. If [Enter] is selected, an entry screen will be provided after threshold data have been entered. Otherwise default factors will be used. These may be set to DSL values or to values that you have entered in Setup. Note that, in some facilities, nHL is defined in such a way that it is effectively eHL; in these cases, ABR (eHL) should be selected and no conversion factors will be applied. See 10.6: [ABR nHL to eHL setup](#) and [18.3: Assessment data choices - 1](#).

FastFacts 18.4: Assessment data choices - 2

18.5 Fitting to targets for soft speech

See [17.9: REM or S-REM mode](#), [17.6: Using Speechmap](#) and [18.2: Assessment data entry](#) for setup and audiometric data entry.

- 1) Select [Audiometry] to choose the target method and enter audiometric data.
- 2) Select REAR 1 and set stimulus to [Speech-std(1)] or [Speech-std(2)] and level to 50. Elongated + symbols show the target range for 50 dB speech LTASS.
- 3) Adjust frequency shaping and gain for soft sounds so that the middle curve (the LTASS) falls within the target range, especially between 500 - 4000 Hz. Press <Continue> to run the complete passage. Repeat as necessary.

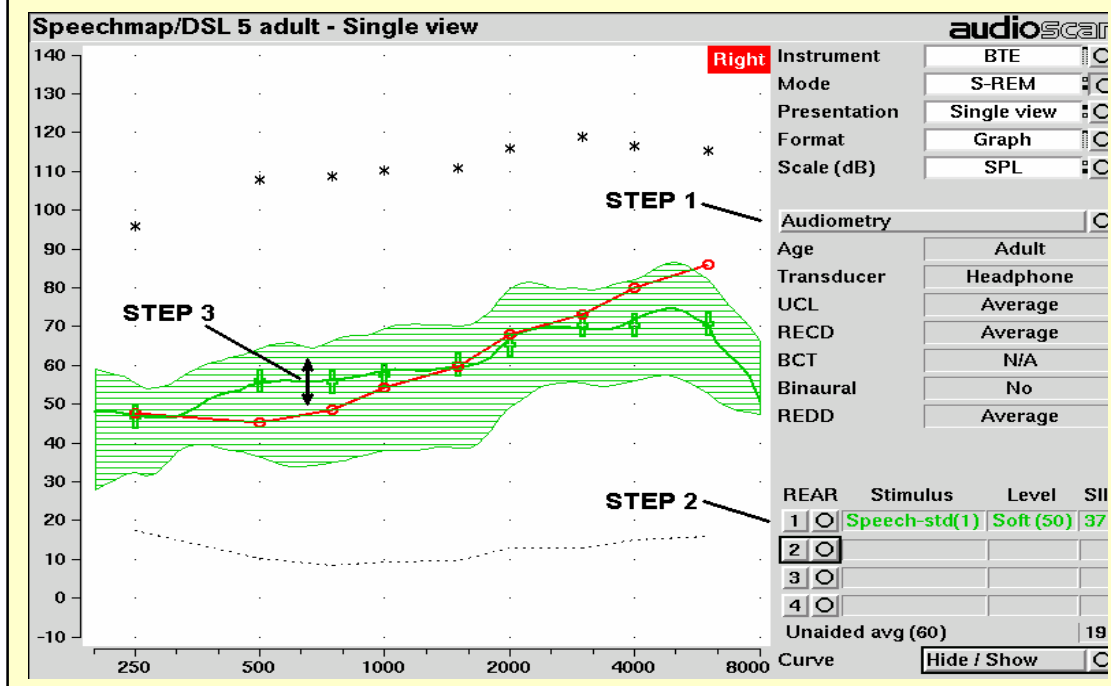

FastFacts 18.5: Fitting to targets for soft speech

18.6 Fitting to targets for loud sounds

- 4) Select REAR 2 & set stimulus to [MPO]. In S-REM mode, a 90 dB tone sweeps continuously. In REM mode, the tone sweeps when you press <Continue>.
- 5) In S-REM mode, adjust high-level gain and/or output limiting (e.g., MPO, PC) so the curve matches the + REAR90 targets (DSL) or approaches but doesn't exceed the * RESR targets (NAL-NL1) at all frequencies. Press <Continue> to record the MPO curve. In REM mode, advise the client to point to the screen if a sound becomes too loud during the test (see [10.5: Max TM SPL setup](#)). Press <Continue> to run and record a single sweep. Adjust the gain and output for loud sounds as for S-REM, factoring in client response. Repeat as necessary.

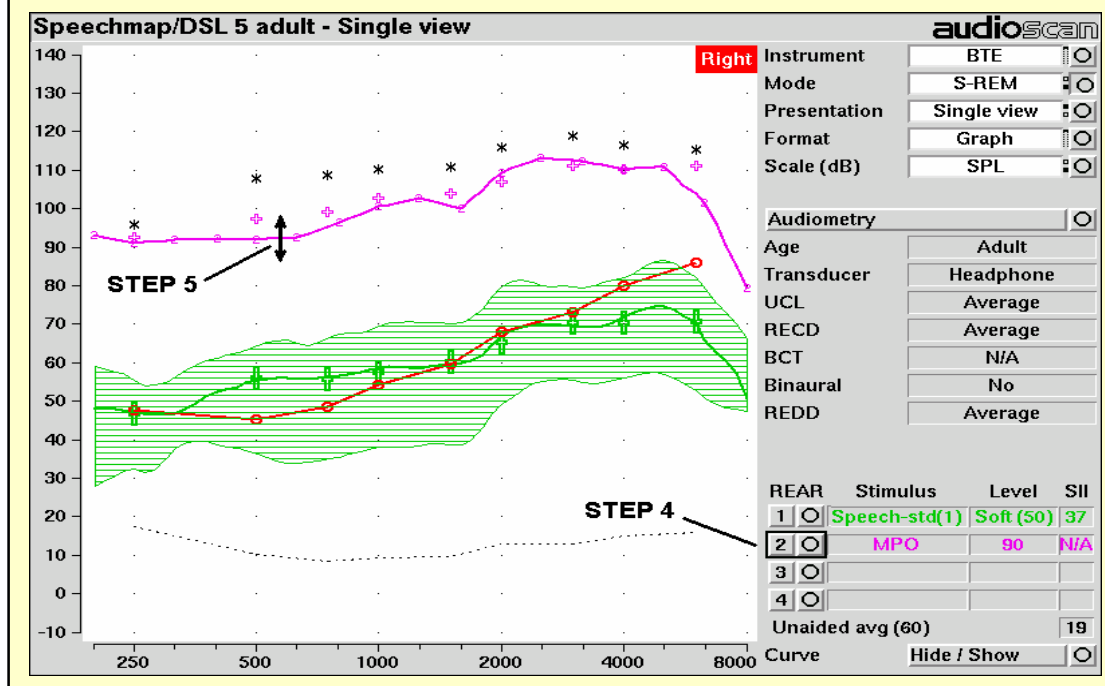

FastFacts 18.6: Fitting to targets for loud sounds

18.7 Fitting to targets for mid-level speech

- 6) Select REAR 3 and set stimulus to [Speech-std(1)] or [Speech-std(2)] and level to 70. Elongated + symbols show the target range for 70 dB speech LTASS.
- 7) Adjust gain for mid-level sounds so that the middle curve (the LTASS) falls within the target range. Press <Continue> to run the complete passage. Repeat as necessary. Achieving this goal may require adjusting gain for soft speech, which will reduce its audibility. This may be a necessary compromise with some hearing instruments and for clients with a very narrow dynamic range.

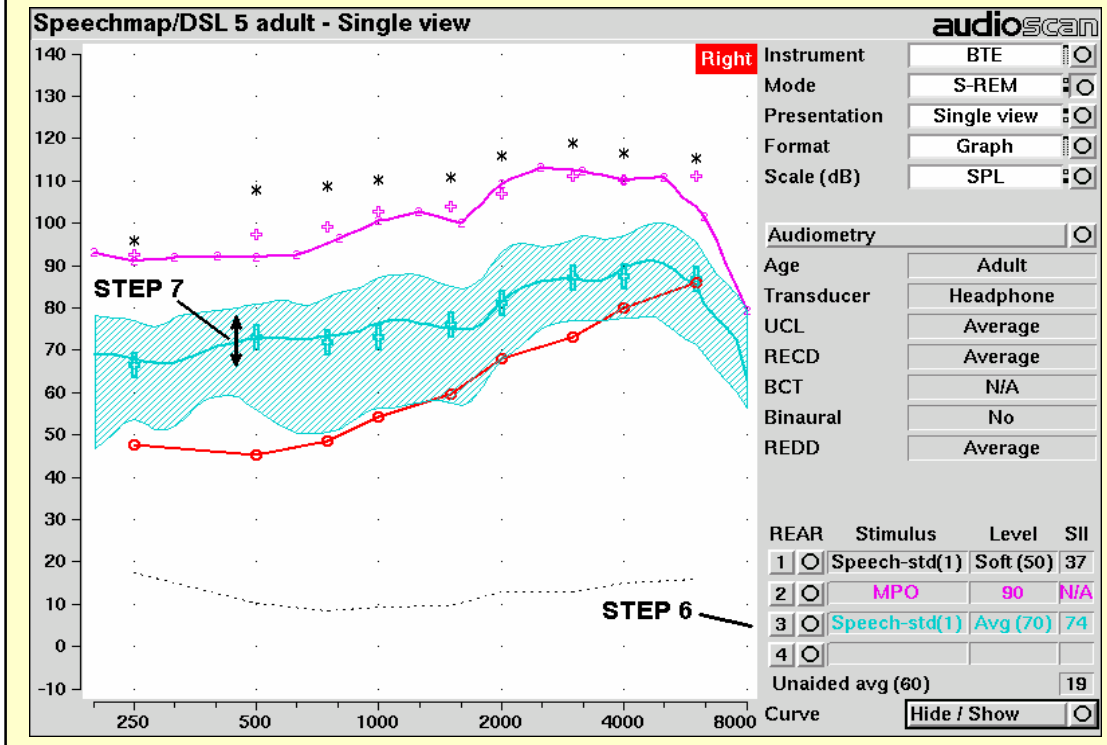

FastFacts 18.7: Fitting to targets for mid-level speech

18.8 Open fittings in Speechmap

REM mode should be used for open and vented fittings. There are no special real-ear SPL targets for open fittings - it doesn't matter how the sound reaches the TM, the perception is the same. However, the sound that escapes from a vent or open fitting may be detected by the REM reference microphone, interfering with the sound-field equalization. For this reason, the hearing instrument must be muted during sound-field equalization.

- 1) Position the client and probe tube and enter audiometric data. See [10: Real-Ear Measurement Setup](#), [17: Speechmap®](#), [18: Speechmap Fitting Procedures](#).
- 2) Highlight and <PICK> Instrument and select Open from the list.
- 3) Highlight and <PICK> a REAR test. If this is the first Open test in a session, you will be prompted to mute or turn off the hearing instrument and select the Equalize button on the setup poster. Otherwise, you are reminded to equalize whenever the client or nearby objects are moved. After equalization, unmute or turn the instrument on and follow the fitting procedures in [18.5: Fitting to targets for soft speech](#) to [18.7: Fitting to targets for mid-level speech](#).

FastFacts 18.8: Open fittings in Speechmap

18.9 FM fitting and verification

FM fitting is complex and strategies are varied and fluid. These instructions are intended to provide the general principles involved, not a detailed and proven method. They assume familiarity with the use of Speechmap in fitting hearing aids.

- 1) Set up the hearing aid or receiver/earpiece as if to fit a hearing aid in REM or S-REM mode. Set it for environmental microphone (EM) only operation. Set **Instrument** to [BTE] or [Body] to indicate the location of the EM.
- 2) Follow [18: Speechmap Fitting Procedures](#) but in [18.7: Fitting to targets for mid-level speech](#) position LTASS 5 dB below the + targets (see note). Avoid controls that change FM gain.
- 3) Switch to FM only operation. If you are in S-REM mode, move the coupler and hearing aid or earpiece outside the test chamber. In either REM or S-REM mode, place the transmitter mic. close to the HIT reference mic. in the test chamber. Turn the transmitter ON and close the test chamber.
- 4) Change **Instrument** to [FM].
- 5) Select an REAR test and, with [Stimulus] at [Speech-shaped] and [Level] at [FM Chest] or [FM Boom], adjust the receiver and/or hearing aid to set the LTASS 5 dB above + targets (see note). If possible, use controls that don't change EM gain.

If controls interact, you may need to repeat these steps or change the order to reach an optimum fitting.

NOTES: If the FM system automatically reduces EM gain when FM is received (FM priority), set the LTASS at the + targets in both EM and FM operation.

For procedures requiring a long coupler mic. cable see [2.3:Microphone connection](#).



FastFacts 18.9: FM fitting and verification

19 Speechmap Technical Details

19.1 Section overview

Speechmap provides a variety of stimuli for the testing of non-linear hearing aids with a range of digital processing features.

This section covers the following topics:

[19.2: Speechmap stimuli](#)

[19.4: Microphone location effects](#)

[19.3: Stimulus levels](#)

[19.5: Speech signal analysis](#)

For additional information see [24: Appendix 1: AudioNote 2.1 VERIFIT and RM500SL Test Signals and Analysis](#)

FastFacts 19.1: Speechmap technical details

19.2 Speechmap stimuli

The Speechmap fitting environment provides a number of well-controlled, distinctly different stimuli. These include three varieties of speech - standard (previously “shaped”), female, child, ICRA noise (digitally distorted speech) and pink noise at levels of 50 to 75 dB SPL in 5 dB steps and a tone burst at 85 or 90 dB SPL.

The two standard speech signals are by the same male talker. The spectrum has been filtered to closely match the Cox & Moore (1988) long-term average speech spectrum (LTASS). The ICRA noise, female and child speech signals are presented as recorded with no spectral shaping. Live speech may also be used.

As a result of reanalysis of published data, the previous distinction between “soft” and “average” vocal effort has been eliminated. Consequently, the speech and ICRA signals are presented unfiltered for levels from 50 to 70 dB SPL. At 75 dB SPL, the spectrum is filtered to represent a “loud” vocal effort. An “own voice” filter is also available at the 75 dB SPL level. This is intended to produce a spectrum and level at a BTE microphone location similar to that produced by the voice of an average wearer.

A tone burst (MPO) stimulus provides 128 (changed from 64) ms bursts at 1/3 octaves with a level of 90 dB SPL in S-REM and 85 dB SPL in REM mode.

In S-REM mode, all signals are filtered to include BTE, ITE, ITC, CIC, Body microphone location effects. The selected overall rms level is established prior to filtering.

For fitting FM systems, the stimuli may be modified to represent the level (84 dB SPL) and spectrum at a chest microphone location and the level (93 dB SPL) and spectrum at a boom microphone location. These are presented in the test box in both REM and S-REM modes.

The overall SPL, 1/3rd octave band SPL, vocal effort and microphone location effects are given in the following tables for the various broad-band signals available.

FastFacts 19.2: Speechmap stimuli

19.3 Stimulus levels

1/3 octave band SPL						Add to band SPL for			
Hz	Speech			ICRA Noise	Pink Noise	Loud	Own Voice	FM Chest	FM Boom
	Standard	Female	Child						
200	56.8	54.9	32.3	52.9	53	-2.2	.5	9.0	19.2
250	56.0	53.1	51.5	55.9	53	3.3	10.7	12.0	22.2
315	53.0	48.4	57.3	56.9	53	9.6	11.0	16.6	26.0
400	57.0	55.8	54.1	57.5	53	6.1	10.0	13.3	22.8
500	58.0	57.3	53.2	57.8	53	7.7	10.1	13.2	25.3
630	55.0	58.1	61.2	54.3	53	12.4	10.5	21.0	29.1
800	52.5	54.6	56.5	52.8	53	14.4	10.8	26.4	32.1
1000	51.0	52.0	52.7	50.4	53	15.0	10.5	26.4	32.7
1250	50.5	51.0	45.4	51.3	53	14.8	5.5	22.0	33.6
1600	48.0	51.1	41.1	48.5	53	15.5	4.0	22.1	33.9
2000	45.0	51.2	39.7	47.0	53	16.2	6.0	21.0	33.0
2500	44.0	49.3	35.5	44.7	53	14.8	6.0	18.2	31.9
3150	42.5	46.0	28.8	43.3	53	14.5	2.0	14.4	30.4
4000	42.0	40.0	31.2	41.1	53	13.2	-0.5	11.8	29.0
5000	40.0	36.1	30.6	39.6	53	9.2	-1.0	12.4	27.8
6300	41.5	43.5	32.6	33.5	53	4.2	0.0	11.4	26.2
8000	41.5	39.9	35.2	28.2	53	2.7	-4.0	11.0	25.8
Overall	65.0	65.0	65.0	65.0	65	75.0	75.0	84.0	93.0

LTASS for standard speech is from Cox & Moore (1988). Loud spectrum is from ANSI S3.5-1997. Own voice spectrum is from Cornelisse et al (1991) adjusted to a 1 m reference.

FastFacts 19.3: Stimulus levels

19.4 Microphone location effects

Microphone Location Effects					
Add to all stimuli in S-REM mode					
Hearing instrument type					
Frequency	BTE	ITE	ITC	CIC	BODY
200	0.5	0.3	0.0	0.9	3.0
250	0.5	0.5	0.3	0.8	3.0
315	0.8	0.8	0.3	0.7	3.0
400	1.1	1.0	0.7	0.5	3.0
500	1.2	1.8	0.0	0.4	4.0
630	1.1	2.0	0.1	0.4	3.0
800	0.9	2.0	0.4	0.4	2.0
1000	0.3	1.5	1.2	0.6	0.0
1250	0.6	0.3	-1.6	1.1	0.0
1600	2.5	-0.3	-1.9	2.0	-4.0
2000	4.1	3.8	2.1	3.3	-4.0
2500	3.5	5.0	4.8	5.0	-3.0
3150	2.8	3.3	3.5	6.9	-2.0
4000	3.7	4.3	6.4	8.3	0.0
5000	-1.2	4.3	6.6	7.6	0.0
6300	1.6	-0.4	-1.8	4.2	0.0
8000	3.3	1.0	-1.9	-5.6	0.0

Microphone location effects are added after the overall rms level has been set

FastFacts 19.4: Microphone location effects

19.5 Speech signal analysis

One of the most-used measures of a speech signal is the long-term average speech spectrum (LTASS). This is a 1/3 octave spectrum averaged over a sufficiently long portion of the speech material to provide a stable curve. In practice a 10 second average meets this requirement and, for this reason, all RM500SL passages are at least 10 seconds long.

The dynamic nature of speech is often characterized by the distribution of short-term levels in each 1/3 octave band. These levels are determined by calculating a spectrum for each of a series of short time periods within the passage. Historically, time periods of 120, 125 or 128 ms have been used. The RM500SL uses a 128 ms time period, resulting in 100 levels (or samples) in each 1/3 octave band for a 12.8 second passage. The level in each band that is exceeded by 1% of the samples (called either the 1st or 99th percentile) has historically been referred to as the speech peak for that band. The curve for these 1% levels is approximately 12 dB above the LTASS. The level in each band that is exceeded by 70% of the samples (called either the 70th or 30th percentile) has historically been called the valley of speech for that band. The curve for these 70% levels is approximately 18 dB below the LTASS. The region between these two curves is often called the speech region, speech envelope or speech “banana”. The speech envelope, when derived in this way, has significance in terms of both speech detection and speech understanding. Generally, speech will be detectable if the 1 % level is at or near threshold. The Speech Intelligibility Index (SII) is maximized when the entire speech envelope (idealized as a 30 dB range) is above (masked) threshold. This will not be an SII of 100% (or 1) because of loudness distortion factors, but higher SII values will not produce significantly higher scores on most test material. The speech-reception threshold (SRT) is attained when the LTASS is at threshold (approximately - depending on test material and the individual)

FastFacts 19.5: Speech signal analysis

20 Troubleshooting

20.1 Section overview

This section covers common problems encountered when using the RM500SL. If you require further assistance, note your model and serial number (located on the recessed panel) and contact your local distributor, or Audioscan at 519-268-3313 800-265-2093 (USA only), 519-268-3256 (fax) or service@audioscan.com

PLEASE DO NOT SHIP YOUR UNIT BACK TO THE FACTORY. In most cases we can courier you a part that you can quickly and easily replace yourself.

This section covers the following topics:

- | | |
|---|------------------------------------|
| 20.2: Self test failures | 20.8: Invalid HIT calibration |
| 20.3: HIT high distortion or noise | 20.9: No REM ref. mic. detected |
| 20.4: HIT curves inconsistent | 20.10: Invalid REM calibration |
| 20.5: HIT curves differ from specifications | 20.11: REM speaker overdriven |
| 20.6: HIT speaker overdriven | 20.12: Barcode scanner malfunction |
| 20.7: No HIT reference mic. detected | |

FastFacts 20.1: Troubleshooting

20.2 Self test failures

Any failure during power-on self test (P.O.S.T.) is indicated on-screen and further use of the instrument is denied. Try the following steps to resolve the failure:

- 1) To access Self test, press <Setup>, then highlight and <PICK> [Self test].
- 2) If you received a Max out/in or a Routing failure, remove any hearing aids from the test chamber, and rerun self test.
- 3) Unplug all microphones (REM & HIT). Rerun self test. If self test passes, reconnect the microphones, one by one, running self test each time until a failure occurs. If the failure returns, display and print the test results and contact Audioscan for help.

Setup	Self test
Max TM SPL <input type="radio"/>	P.O.S.T. <input type="radio"/>
Frequencies <input type="radio"/>	Routing <input checked="" type="checkbox"/>
Test setup <input type="radio"/>	Gain <input checked="" type="checkbox"/>
ABR nHL to eHL <input type="radio"/>	Frequency response <input checked="" type="checkbox"/>
Speakers <input type="radio"/>	Noise floor <input checked="" type="checkbox"/>
ANSI <input type="radio"/>	Max out / in <input checked="" type="checkbox"/>
Display <input type="radio"/>	Distortion <input checked="" type="checkbox"/>
Network <input type="radio"/>	Crosstalk <input checked="" type="checkbox"/>
Printing <input type="radio"/>	
Date & Time <input type="radio"/>	
Self test <input type="radio"/>	

FastFacts 20.2: Self test failures

20.3 HIT high distortion or noise

High distortion and/or noise numbers in an ANSI test

- ✓ There may be a leak between the hearing instrument under test and the coupler it is connected to. For BTE type instruments, check the integrity of the #13 tubing at the end of the coupler where it joins with the ear hook. Look for cracks. ITE type instruments need to have a good seal between the hearing instrument and the coupler. In addition, all vents need to be closed from the faceplate side of the hearing instrument.
- ✓ Ambient room noise may be leaking into the test chamber. Air conditioners, computer fans and similar noisemakers can yield artificially high noise figures. Check the sealing of the test chamber. Try turning off suspected noise sources to identify the cause.
- ✓ Vibration may be coupled into the test chamber from other equipment on the same table or wooden floor. Computers, fans and air conditioners may be the source of the vibration. Try turning off suspected sources to identify the cause. Relocate the source or the RM500SL or mount it on a foam pad.

FastFacts 20.3: HIT high distortion or noise

20.4 HIT curves inconsistent

The HIT curves keep changing from test to test.

- ✓ The battery may be close to end of life or starved for air (zinc-air cells) because of a tight seal on the battery compartment. Try a fresh battery or using the optional RM500SL battery pill.
- ✓ The HIT reference microphone (the white one in the test chamber) is incorrectly positioned. In order to control sound pressure levels precisely at the microphone inlet of the hearing instrument, the HIT reference microphone must be positioned as close as possible to the hearing instrument's microphone without actually touching it.
- ✓ The noise or feedback reduction features are attempting to reject the test signal. These need to be disabled prior to tests with tones or noise.
- ✓ The instrument is on the verge of feedback due to a poor seal to the coupler, unplugged vent or a crack in the tubing on the BTE coupler.

FastFacts 20.4: HIT curves inconsistent

20.5 HIT curves differ from specifications

The OSPL90 and response curves don't look like the manufacturer's.

- ✓ Check that all controls or program settings are the same as those used by the manufacturer.
- ✓ Check that vents on earmolds or ITE instruments are plugged at the faceplate.
- ✓ Check that ITE instruments are **well sealed** to the coupler.
- ✓ When putting a hearing instrument into the ITE coupler, be sure to keep the canal portion of the instrument flush with the inside of the 2cc volume.
- ✓ Ensure that the HIT chamber is sealed tightly.
- ✓ Ensure that the HIT microphone calibration was performed correctly.
- ✓ Check that the coupler is screwed tightly onto the coupler microphone.

FastFacts 20.5: HIT curves differ from specifications

20.6 HIT speaker overdriven

HIT speaker overdriven!

This message indicates that the test chamber speaker is unable to produce the SPL required for a test.

- ✓ Check that the test chamber lid is closed and sealed.
- ✓ Check that the HIT calibration looks normal.
- ✓ Check that the hearing instrument under test is not feeding back.
- ✓ Try running a REM test.

FastFacts 20.6: HIT speaker overdriven

20.7 No HIT reference mic. detected

No HIT reference mic. detected!

This message may be displayed when starting a hearing instrument test. It indicates that the RM500SL is not measuring any sound at the HIT reference microphone. The HIT reference microphone is the white microphone located in the test chamber.

- ✓ Ensure that the white HIT reference microphone is secure. Unplug it and plug it in again, ensuring that it 'clicks' into place. Try the HIT calibration procedure again.
- ✓ Unplug the HIT reference microphone and plug the REM probe microphone in its place. Try HIT calibration using the reference microphone of the REM probe microphone in place of the HIT reference microphone. If this is successful, the HIT reference microphone is defective and must be replaced.

FastFacts 20.7: No HIT reference mic. detected

20.8 Invalid HIT calibration

Invalid HIT Calibration!

This message may be displayed during the HIT calibration procedure. It indicates that the calibration curve is significantly different from what is expected. It may be accompanied by a missing HIT reference microphone error.

- ✓ Check that there is no coupler on the coupler microphone and that the microphones are correctly positioned for HIT calibration.
- ✓ Check that the coupler microphone is securely plugged into the correct socket.
- ✓ Follow the suggestions in [20.7: No HIT reference mic. detected](#).

FastFacts 20.8: Invalid HIT calibration

20.9 No REM ref. mic. detected

No REM reference mic. detected.

Check connection on the REM probe microphone.

- ✓ Check that a probe microphone assembly is securely plugged into the PROBE socket to the left of the test chamber.
- ✓ Unplug the HIT reference microphone in the test chamber and plug the REM probe microphone in its place. Try HIT calibration using the reference microphone of the REM probe microphone in place of the HIT reference microphone. If this fails, the REM probe microphone is defective and must be replaced.

FastFacts 20.9: No REM ref. mic. detected

20.10 Invalid REM calibration

Invalid REM Calibration!

This message may be displayed during the REM calibration procedure. It indicates that the calibration curve is significantly different from what is expected. It may be accompanied by a REM reference microphone error.

- ✓ Check that a probe microphone assembly is securely plugged into the PROBE socket to the left of the test chamber.
- ✓ Try using a new probe tube. Ensure it is correctly attached and positioned.
- ✓ Try the steps in [20.9: No REM ref. mic. detected](#).
- ✓ Unplug the coupler microphone from the test chamber and plug the REM probe microphone in its place. Position the open end of the probe tube near the HIT reference microphone in the test chamber (use putty to hold it) and close the test chamber lid. Run a Multicurve test at a stimulus level of 70 dB SPL. The result should have the shape of a normal REM calibration curve. If it does not, the REM microphone is defective and must be replaced.

FastFacts 20.10: Invalid REM calibration

20.11 REM speaker overdriven

REM speaker overdriven!

This message indicates that the REM speaker is unable to produce the SPL required for a test. This is usually the result of a standing wave null at the REM reference microphone caused by reverberation in the environment. It warns of a situation that could cause significant measurement errors.

- ✓ Move the RM500SL and client away from walls and hard objects. Avoid placing the RM500SL under an overhanging shelf or cabinet.
- ✓ Move the RM500SL to the front edge of the table.
- ✓ Move the client slightly closer to or further from the REM speaker.
- ✓ Position the test ear more directly in front of the REM speaker.
- ✓ Apply sound absorbers to nearby reflective surfaces.

FastFacts 20.11: REM speaker overdriven

20.12 Barcode scanner malfunction

If there is no red scanning beam when the trigger is pulled, tug on the cable where it enters the scanner. If it comes loose easily, push it back in until it clicks in place.

If the scanning beam stays on when the trigger is released or if the barcode scanner fails to read known good barcodes, try the following:

- 1) Unplug the scanner from the RM500SL, then reconnect it. If the problem persists...
- 2) Print this page on an external printer (see [2.7: External printer, auxiliary audio outputs](#)) or from the electronic user's guide on the RM500SL software CD (see [1.3: Electronic user's guide](#)).
- 3) Scan these two barcodes, starting with the top one. This will reset the scanner to its default settings.

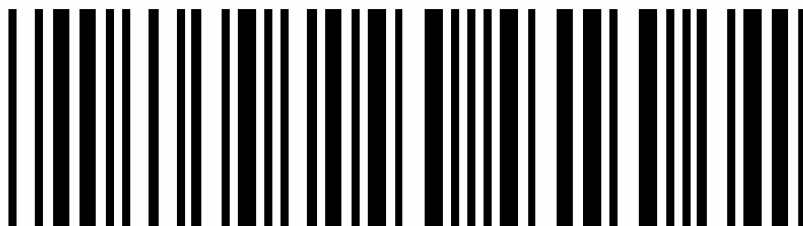
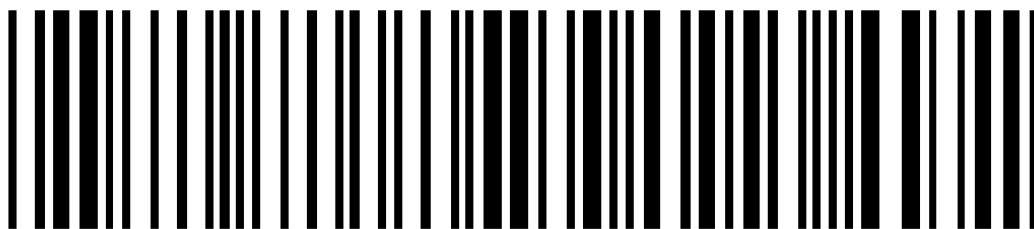

FastFacts 20.12: Barcode scanner malfunction

21 Technical Specifications

Storage & Transportation

Temperature -20°C to +60°C
Relative humidity (non-condensing).....5% to 95%
Atmospheric pressure..... 500 - 1060 hPa

General

Overall dimensions15.5"x12.75"x4.25"
Weight15lb
Display type fluorescent backlit active color
Display size12.1" diagonal
Resolution800x600 (SVGA)
Printer type..... thermal line printer
Printer resolution..... 200 dots per inch
Paper width3" (80mm)
Power amplifiers2
Stimulus Channels2
Measurement channels1
Connectors.....1-USB
1 - Ethernet (RJ45)
1 - RS232 serial (9D)
2 - auxiliary audio outputs (1/4"mono)
1- RECD transducer(3.5mm st)
1 - test chamber ref. mic.(3.5mm st)
1 - coupler microphone(3.5mm st)
1 - battery substitute(3.5mm st)
1 - real-ear mic.(3.5mm st)

HIT Chamber

Working Space8.8"x3.5"x1.5"
Speaker..... 1 - 2"x3"
Induction Coils. 1 - Telephone Magnetic Field Simulator
(TFMS ANSI S3.22 - 2003)
Battery Simulatorper ANSI S3.22 2003
Frequency Range 200 - 8000 Hz
Test Stimulitone, pink noise, calibrated or live speech
Test stimulus levels 40 to 90 dB SPL in 5 dB steps
Test stimulus levels (inductive) 31.6mA/m per
(ANSI S3.22 - 2003)
Test stimulus distortion..... <2% at 90dB SPL
..... <0.5% at 70 dB SPL
Test stimulus accuracy at reference mic. for tones (200-2000
Hz)..... ±1.5 dB SPL
Test stimulus accuracy at reference mic. for tones (2000-
8000 Hz)..... ±2.5 dB SPL
Equalization method pressure method
Analysis frequencies per octave12
Analysis filter bandwidth1/12 octave
Measurement accuracy at 1 kHz ±1db
Measurement accuracy re 1 kHz ±1 dB (200-5000 Hz)
..... ±2.5 dB (5000-8000 Hz)
Measurement range 30 - 140 dB SPL
Harmonic distortion measurement 2nd, 3rd
.....or 2nd plus 3rd
Harmonic distortion range200 to 4000 Hz
Harmonic distortion accuracy..... ±1%
Battery drain range0 - 20mA
Battery drain accuracy..... ±5%
Battery drain resolution. ±01 mA

ANSI S3.22 - 1996 and 2003 tests available

- a OSPL90
- a Full-on Gain
- a Reference Test Gain
- a Frequency Response
- a Frequency Range
- a Maximum OSPL90
- a Harmonic Distortion
- a Attack & Release time
- a Equivalent Input Noise
- a Input/Output Curves
- a Coupler SPL - Telephone Simulator
- a Simulated Telecoil Sensitivity
- a Battery Drain

Other tests Available

- a coupler SPL vs frequency
- a coupler gain vs frequency
- a spectral analysis
- a distortion vs frequency
- a manual measurement of output, gain and distortion

Real Ear

Speakers1 - 2"x 3"
Probe microphone tube 1.0 mm diameter x 75 mm
Frequency Range 200 to 8000 Hz
Test Stimuli.....frequency-modulated tone, tone burst,
.....pink noise, calibrated speech
Freq. modulationtriangular ±5%at 36 Hz
Stimulus levels for tones40 - 85 dB SPL in 5 dB steps
Test stimulus accuracy at reference mic. for tones
(200 - 2000 Hz)±1.5 dB SPL
(2000- 8000 Hz)±2.5 dB SPL
Equalization Methodmodified pressure method
Analysis frequencies per octave (tones) 12
Analysis bandwidth (speech, noise)..... 1/3 octave
Measurement accuracy at 1 kHz..... ±1 dB
Measurement accuracy re 1 kHz..... ±1 dB (200-5000 Hz)
..... ±2.5 dB (5000-8000Hz)
Measurement Range20-135 dB SPL (200-2500 Hz)
..... 30-140 dB SPL (2500-8000Hz)

ANSI S3.46 - 1997 tests available

- a Real-Ear Unaided Response
- a Real-Ear Aided Response
- a Real-Ear Occluded Response
- a Real-Ear Insertion Gain

Other tests available

- a Real-ear harmonic distortion
- a Real-ear spectral analysis
- a Manual measurement of output, gain and distortion

Fitting methods available

- a Speechmap with DSL 5, NAL-NL1
- a Insertion gain with NAL-RP, NAL-NL1, Fig6, Pogoll,
Berger, Libby

22 Glossary

AGC, Automatic Gain Control, the means by which gain is automatically controlled by the level of the signal being amplified. (ANSI S3.22)

AGC-I, input-controlled AGC (see "input compression").

AGC-O, output controlled AGC (see "output compression").

AGRAM, Abbreviation for audiogram.

ANSI, American National Standards Institute.

Attack Time, the time required for HA output to reach +/- 3dB of its steady state level in response to an input step from 55 to 90dB SPL. (ANSI S3.22)

ASP, Automatic Signal Processing, In hearing aids, level dependent frequency response shaping.

AVC, Automatic Volume Control, slow-acting AGC that attempts to maintain a constant average signal level.

BSPL, Band Sound Pressure Level, the SPL within a restricted frequency band.

BTE, Behind-The-Ear (hearing aid).

Compression, a type of AGC in which an incremental change in the input level produces a smaller incremental change in the output level.

CR, Compression Ratio, the ratio of incremental change in input SPL to the resulting incremental change in output SPL. Used to characterize steady state AGC action; can be a function of input level, duration and frequency.

CROS, Contralateral Routing Of Signals; a type of hearing aid in which the microphone is at the ear opposite to the one receiving the amplified sound.

CORFIG, Coupler Response for Flat Insertion Gain; the transformation added to real-ear insertion gain to obtain 2-cc coupler gain. Assumes linear amplification.

Coupler, a device used to acoustically couple an earphone or hearing aid to a measurement microphone and to provide an acoustic load.

DSL, Desired Sensation Level Method, a systematic eardrum (SPLogram) approach to the hearing aid fitting process that seeks to ensure amplified speech will be audible and comfortable while loud sounds will not be uncomfortable.

Directional hearing aid, a hearing aid for which the gain is dependent on the direction of sound incidence when measured under free-field conditions (ANSI S3.22).

Equalization, process of controlling the SPL (or band SPL) of the stimulus, as a function of frequency, at the field reference point (ANSI S3.46).

Expansion, a type of AGC in which an incremental change in the input level produces a larger incremental change in the output level.

FM, frequency modulation, a method of transmitting information in which the frequency of a radio wave (carrier) is varied (modulated) by the information (signal). Also, a method of reducing standing waves in a sound field in which the frequency of a test tone (carrier) is varied by a low frequency triangle or sine wave.

FM System, an assistive listening device consisting of a microphone, an fm radio transmitter and an fm receiver. The microphone and transmitter are worn by the speaker and the receiver is worn by the listener.

FOG, Full On Gain, gain for a 50 dB input SPL with the gain control set to maximum ANSI S3.22)

Gain (in dB), output sound pressure relative to input sound pressure, expressed in decibels; gain = $20\log_{10}$ (output sound pressure / input sound pressure); also, gain = (output SPL) - (input SPL).

Gain control, a manually or electronically operated control for the adjustment of overall gain (ANSI S3.22).

HA-1 Coupler, a coupler having a volume of 2 cubic centimetres with direct access to the cavity. Used for testing in-the-ear and in-the-canal hearing aids; can also be used to test behind-the-ear hearing aids with a custom earmold attached. Aka the ITE coupler.

HA-2 Coupler, a coupler having a volume of 2 cubic centimetres with access through a rigid tube. When used for testing BTE hearing aids, the rigid tube consists of 18 mm of 3 mm tubing plus 25 mm of 2 mm tubing (ANSI S3.22). When used for calibrating insert earphones, the 2 mm tubing is not used (ANSI S3.6). Aka the BTE coupler.

Harmonic, a component of a tone complex that is an integer multiple of the lowest frequency component (fundamental).

Harmonic Distortion, the addition of harmonic components to a signal. The rms value of a harmonic component of a signal as a percentage of the rms value of the fundamental. If less than 20%, the rms value of the total signal may be used instead of the fundamental.

HFA, High Frequency Average, the average of values in dB at 1000, 1600, and 2500 Hz. (ANSI S3.22).

HL, Hearing Level, the hearing threshold referenced to the threshold of normal hearing, expressed in dB.

HI, Hearing instrument.

HIT, Hearing instrument test.

Input Compression, a form of AGC in which the signal level is regulated before the volume control.

Input / Output function, steady state, single-frequency plot of the coupler SPL on the ordinate as a function of input SPL on the abscissa with equal decibel scale divisions on each axis (ANSI S3.22).

ITE, In-The-Ear (hearing aid).

Kneepoint (compression threshold), the point on an input/output curve at which the slope digresses from unity indicating the signal level at which a non-linear process begins to take effect.¹

LCD, liquid crystal display. A thin, planar information display.

Linear Region, that portion of the input-output function which is a straight line at 45 degrees.

Linear Amplification, amplification having the same gain for all input levels until the maximum output of the device is reached.

LTASS, Long-term average speech spectrum, the rms level of a speech passage in 1/3rd octave bands, averaged over the entire passage.

Loop System, an assistive listening device that uses magnetic induction to carry a signal from a microphone/amplifier to a wire loop. The signal is picked up from the loop by a hearing aid set to the telecoil position or by a receiver with built-in telecoil, volume control, and earpiece. Loops are either worn around an individual's neck or can encircle a room, such as a classroom, providing an excellent signal-to-noise ratio.¹

MAF, minimum audible field, SPL of a tone at the threshold of audibility measured in a free sound field for a subject listening with both ears and facing the sound source. The SPL is measured with the subject removed from the field at the midpoint of an imaginary line joining the centers of the ear canal openings.

MAP, minimal audible pressure, SPL of a tone, measured or inferred at the tympanic membrane, at the threshold of audibility.

MPO, Maximum Power Output, the maximum SPL that a hearing aid can deliver in response to a steady narrow band input. The stimulus may be pulsed (a tone burst) to avoid discomfort and to obtain a worst-case maximum output.

Modulation, the process of varying a characteristic of one signal with another.

NAL, National Acoustic Laboratories (Australia)

NCA, National Centre for Audiology (Canada)

Nonlinear Region, that portion of the input-output function which is not a straight line at 45 degrees.

OSPL90 (output SPL for 90-dB input SPL), The SPL developed in a 2cc coupler when the input SPL is 90 dB, with the gain control of the hearing aid full-on (ANSI S3.22).

Oscillation, in audiology, refers to the undesired tonal output of an amplifier behaving unstably as a result of feedback; whistling.¹

Output Compression, a form of AGC in which the signal level is regulated at the output.

OLC, Output-limiting Compression (compression limiting), a form of AGC with a high kneepoint and high compression ratio.

PC, Peak-clipping, a method of limiting MPO by truncating the electrical signal supplied to the output transducer. The resulting acoustic signal may not be truncated but will be distorted.

Probe microphone, microphone (which may include an extension tube) having a sound inlet which is small enough to be acoustically unobtrusive when inserted into the ear canal (ANSI S3.46).

Pure tone, a signal containing one, and only one, frequency; a sinusoidal acoustic signal.¹

REAG, Real-Ear Aided Gain, difference, in dB as a function of frequency, between the SPL (or BSPL) at a specified measurement point in the ear canal and the SPL (or BSPL) at the field reference point, for a specified sound field, with the hearing aid in place and turned on (ANSI S3.46).

REAR, Real-Ear Aided Response, the SPL (or BSPL) as a function of frequency, at a specified measurement point in the ear canal for a specified sound field, with the hearing aid in place and turned on (ANSI S3.46).

RECD, Real-Ear-to-Coupler Difference, difference, in dB as a function of frequency, between the SPL (or BSPL) produced by an insert transducer at the eardrum and in a 2cc coupler. HA-1 or HA-2 coupler should be specified.

REDD, Real-Ear-to-Dial Difference, difference, in dB as a function of frequency, between the SPL (or BSPL) measured at the eardrum and the audiometer dial setting that produced it. It is specific to the client, headphone and audiometer used to generate it.

REIG, Real-Ear Insertion Gain, difference, in dB as a function of frequency, between the REAG and the REUG taken with the same measurement point and the same sound field conditions. $REIG = REAG - REUG$. ANSI S3.46.

REOG, Real-Ear Occluded Gain, difference, in dB as a function of frequency, between the SPL (or BSPL) at a specified measurement point in the ear canal and the SPL (or BSPL) at the field reference point, for a specified sound field, with the hearing aid in place and turned off (ANSI S3.46).

REOR, Real-Ear Occluded Response, SPL (or BSPL), as a function of frequency, at a specified measurement point in the ear canal, for a specified sound field, with the hearing aid in place and turned off (ANSI S3.46). The REOR is used to evaluate the seal of an earmold. It is not related to the required gain of a hearing aid.

REUG, Real-Ear Unaided Gain, difference, in dB as a function of frequency, between the SPL (or BSPL) at a specified measurement point in the ear canal and the SPL (or BSPL) at a field reference point, for a specified sound field, with the ear unoccluded (ANSI S3.46).

REUR, Real-Ear Unaided Response, SPL (or BSPL), as a function of frequency, at a specified measurement point in the ear canal, for a specified sound field, with the ear canal unoccluded (ANSI S3.46).

Reference microphone, microphone used to measure the stimulus level in the measurement process or to control it in the equalization process.

Release Time, the time required for HA output to fall to within +/-4dB of its steady-state level for an input step from 90 to 55dB SPL. (ANSI S3.22)

REM, Real-Ear Measurement.

RTG, Reference Test Gain, the HFA gain for a 60 dB input SPL with the gain control at RTS (ANSI S3.22).

Reference, Sound-field, the calibration point of a sound-field measurement.

RTS, Reference Test Setting of the gain control, for a 60 dB input SPL, the setting of the gain control required to produce an HFA gain within 1.5 dB of the HFA-OSPL90 minus 17 dB. If the full-on HFA gain is less than the HFA-OSPL90 minus 17 dB, the RTS is the full-on setting of the gain control (ANSI S3.22).

RSETS, Relative Simulated Equivalent Telephone Sensitivity, difference in dB between the HFA-SPLITS (SPA-SPLITS) and the RTG plus 60 in the 'M' (microphone) mode. $RSETS = HFA-SPLITS - (RTG+60)$

Saturation, in a hearing aid, the limiting of output caused by the output circuitry and transducer reaching their maximum capability.

SPA, Special Purpose Average, the average of values in dB at three third octave frequencies separated by 2/3 of an octave (ANSI S3.22). See also HFA.

Spectrum, the BSPL as a function of frequency for a broad-band signal.

SII, Speech Intelligibility Index, a quantity calculated from measures of speech, noise and hearing threshold that is highly correlated with the intelligibility of speech (ANSI S3.5).

Speech Region, a statistical range of short-term spectra present in a speech passage. The short-term spectra are typically 120 - 130 millisecond averages in 1/3 octaves. The statistical range is typically from the 70th to the 99th percentile.

SPL, Sound Pressure Level, rms sound pressure relative to 20 uPa, expressed in decibels. $SPL = 20\log_{10} (\text{rms sound pressure} / 20\text{uPa})$.

SPLITS, coupler SPL for an inductive telephone simulator, SPL developed in a 2cc coupler by a hearing aid with the gain control at the RTS when the input is the magnetic field generated by a TMFS (ANSI S3.22).

TMFS, Telephone magnetic-field simulator, a device for producing a magnetic field of consistent level and geometric shape when driven by a specified current (ANSI S3.22).

THD, Total Harmonic Distortion, the rms value of all harmonic components as a percentage of the rms value of the fundamental. If less than 20%, the rms value of the total signal may be used instead of the fundamental. For most hearing aids, the inclusion of harmonics above the third will not significantly alter the THD (ANSI S3.22).

Transducer, a device which transforms energy from one form to another. For example, a microphone or earphone.

UCL, Uncomfortable Listening Level, the level for a specified stimulus that is judged to be definitely uncomfortable.

VGA, video graphics adapter.

VC, Volume Control, a user-operated gain control.

Warble Tone, a frequency-modulated sine wave. The modulating signal is often a low frequency triangle wave.

1. Valente, M: *Strategies for Selecting and Verifying Hearing Aid Fittings*. New York: Thieme Medical Publishers, Inc., 1994.

ANSI S3.5, *Methods for Calculation of the Speech Intelligibility Index*, 1997

ANSI S3.6, *Specification for Audiometers*, 1996

ANSI S3.22, *Specification of Hearing Aid Characteristics*, revised 2003.

ANSI S3.46, *Methods of Measurement of Real-Ear Performance Characteristics of Hearing Aids*, 1997.

23 References

American National Standards Institute. (1997). *American National Standard Methods of Measurement of Real-Ear Performance Characteristics of Hearing Aids. ANSI S3.46-1997*. New York: American National Standards Institute.

American National Standards Institute. (1996). *American National Standard Specification of Hearing Aid Characteristics. ANSI S3.22-1996*. New York: American National Standards Institute.

Bagatto, M., Moodie, S. T., Scollie, S., Seewald, R., Moodie, K.S., Pumford, J. & Liu, R. (2005). *Clinical protocols for hearing instrument fitting in the desired sensation level method*. *Trends in Amplification*, 9-4, 199-226.

Bentler, R.A. & Pavlovic, C.V. (1989). Transfer functions and correction factors used in hearing aid evaluation and research. *Ear and Hearing*, 10(10), 58-63.

Byrne, D. (1977). The speech spectrum - Some aspects of its significance for hearing aid selection and evaluation. *British Journal of Audiology*, 11, 40-46.

Cole, W.A. & Sinclair, S.T. (1998). The Audioscan RM500 Speechmap/DSL fitting system. *Trends in Amplification*, 3(4):125-139.

Corliss, E. L. R. (1990) The ear as a mechanism of communication. *Journal of Audio Engineering Society*, 38(9):640-652.

Cornelisse, L.E., Gagne, J-P & Seewald, R.C. (1991). Ear level recordings of the long-term average spectrum of speech. *Ear and Hearing*, 12(1), 47-54.

Cornelisse, L.E., Gagne, J-P & Seewald, R.C. (1991). Long-term average speech spectrum at chest-level microphone location. *Journal of Speech, Language, Pathology and Audiology*, 15(3):7-12.

Cornelisse, L.E., Seewald, R.C., & Jamieson, D.G. (1994). Wide-dynamic-range compression hearing aids: The DSL[i/o] approach. *The Hearing Journal*, 47(10), 23-29.

Cornelisse L.E., Seewald R.C., & Jamieson D.G. (1995). The input/output (I/O) formula: A theoretical approach to the fitting of personal amplification devices. *Journal of the Acoustical Society of America*, 97(3), 1854-1684.

- Cox, R.M. & Moore, J.N. (1988). Composite speech spectrum for hearing aid gain prescriptions. *Journal of Speech and Hearing Research*, 31:102-107.
- Dunn, H. K., & White, D. S. (1940). Statistical measurements on conversational speech. *Journal of the Acoustical Society of America*, 11:278-288.
- Feigin, J.A., Kopun, J.G., Stelmachowicz, P.G. & Gorga, M.P. (1989). Probe-tube microphone measures of ear-canal sound pressure levels in infants and children. *Ear and Hearing*, 10(4), 254-258.
- Fikret-Pasa, S. & Revit, L.J. (1992). Three experiments to validate new probe-measurement practices in prescribing customized hearing aids. *Journal of Speech and Hearing Research*, 35:384-400.
- Hawkins, D.B., Cooper, W.A., & Thompson, D.J. (1990). Comparisons among SPLs in Real Ears, 2cc and 6cc couplers. *Journal of the American Academy of Audiology* 1:154-161.
- Hawkins, D.B., Walden, B.E., Montgomery, A.A., & Prosek, R.A., (1987). Description and validation of an LDL procedure designed to select SSPL90. *Ear and Hearing* ,8:162-169.
- Killion, M. C., & Monser, E. L. (1980). "Corfig: Coupler response for flat insertion gain." In G. A. Studebaker and I. Hochberg (Eds.),. *Acoustical Factors Affecting Hearing Aid Performance*. Baltimore: University Park Press.
- Lewis, D.E., Feigin, J.A., Karasek, A.E., & Stelmachowicz, P.G. (1991). Evaluation and assessment of FM systems. *Ear and Hearing*, 12:268-280.
- Martin, H.C., Munro, K.J., & Langer, D.H. (1997). Real-ear to coupler differences in children with grommets. *British Journal of Audiology* 31:63-69.
- Moodie, K.S. (1996). A practical approach to hearing aid selection. *BSA News* 18:6-8.
- Moodie, K.S., Seewald, R.C. & Sinclair, S.T. (1994). Procedure for predicting real-ear hearing aid performance in young children. *American Journal of Audiology*, 3(1), 23-31.
- Moore, Brian C.J. & Glasberg, Brian R. (2004). A revised model of loudness perception applied to cochlear hearing loss. *Hearing Research*, 188 (2004), 70-88.
- Mueller, H.G. & Bright, K.E. (1994). Selection and verification of maximum output. In Valente M (ed.): *Strategies for Selecting and Verifying Hearing Aid Fittings*. New York: Thieme Medical Publishers, 38-63.
- Pavlovic, C. V. (1991). Speech recognition and five articulation indexes *Hearing Instruments* 42(9):20-23.
- Pearsons, K.S., Bennett, R.L., & Fidell, S. (1977). *Speech levels in various noise environments, Project Report On Contract 68 01-2466*. Washington, DC: US Environmental Protection Agency.
- Scollie, S.D., Seewald, R.C., Cornelisse, L.E. & Jenstad, L.M. (1998). Validity and repeatability of level-independent HL to SPL transforms. *Ear and Hearing* 19(5):407-413.
- Scollie, S.D., Seewald, R.C., Moodie, K.S., Dekok, K. (2000). Preferred listening levels of children who use hearing aids: Comparison to prescriptive targets. *JAAA* 11:230-238.

- Scollie, S., Seewald, R., Cornelisse, L., Moodie, S. T., Bagatto, M., Launagaray, D., Beulac, S. & Pumford, J. (2005). *The Desired Sensation Level Multistage Input/Output Algorithm*. Trends in Amplification, 9-4, 159-197.
- Seewald, R.C. (1994a). Current issues in hearing aid fitting. In J-P Gagne and N. Tye-Murray (Eds.), *Research in Audiological Rehabilitation: Current Trends and Future Directions*. *Journal of the Academy of Rehabilitative Audiology Monograph*, XXVII.
- Seewald, R.C. (1994b). Fitting children with the DSL method. *The Hearing Journal*, 47(9), 10,48-51.
- Seewald, R.C., Moodie, K.S., Sinclair, S.T. & Cornelisse, L.E. (1996). Traditional and theoretical approaches to selecting amplification for infants and young children. In Bess, F.H., Gravel, J.S. & Tharpe, A.M. (eds.): *Amplification for Children with Auditory Deficits*, Nashville: Bill Wilkerson Center Press, 161-191.
- Seewald, R.C. & Ross, M. (1988). Amplification for young hearing-impaired children. In M.C. Pollack (Ed.), *Amplification for the Hearing-Impaired*, Third Edition (pp. 213-271). Orlando: Grune & Stratton.
- Seewald, R.C., Ross, M. & Spiro, M.K. (1985). Selecting amplification characteristics for young hearing-impaired children. *Ear and Hearing*, 6(1), 48-53.
- Seewald, R.C., Ross, M. & Stelmachowicz, P.G. (1987). Selecting and verifying hearing aid performance characteristics for young children. *Journal of the Academy of Rehabilitative Audiology*, 20, 25-38.
- Seewald, R., Moodie, S. T., Scollie, S. & Bagatto, M. (2005). *The DSL method for pediatric hearing instrument fitting: Historical perspective and current issues*. Trends in Amplification, 9-4, 145-157.
- Seewald, R.C. & Moodie, K.S. (1992). Electroacoustic considerations. In M. Ross (ed), *FM Auditory Training Systems: Characteristics, Selection, & Use*. Timonium, MD: York Press.
- Sherbecoe, R.L & Studebaker, G.A. (2003) Audibility-Index predictions of normal-hearing and hearing-impaired listeners' performance on the Connected Speech Test. *Ear and Hearing*, 24-1, 71-88.
- Sinclair, S.T., Moodie, K.S. & Seewald, R.C. (1997). Pediatric Hearing Instrument Fitting: *Phonak Video Focus #2 Booklet*, Stofa, Switzerland: Phonak A/G.
- Sinclair, S.T. Seewald, R.C. & Cole, W.A. (1996). A new real-ear fitting system: Because no two ears are alike. *Hearing Review* 3(6):46-48.
- Skinner, M. W. (1988). *Hearing Aid Evaluation*. Englewood Cliffs: Prentice-Hall Inc.
- Smith, D. A. 1990. Technological report: Acoustometry. *Hearing Instruments* 41(11):40-44.
- Valente, M., Potts, L.G., Valente, M., Vass, W & Goebel, J. (1994). Intersubject Variability of real-ear sound pressure level: Conventional and insert earphones. *Journal of the American Academy of Audiology*, 5, 390-398.
- Valente, M: *Strategies for Selecting and Verifying Hearing Aid Fittings*. New York:Thieme Medical Publishers, Inc.,1994.
- Zelisko, D.L.C., Seewald, R.C. & Whiteside, S. (1992). Comparing three procedures for predicting the ear canal SPL at LDL. *ASHA*, 34(10).

24 Appendix 1: AudioNote 2.1 VERIFIT and RM500SL Test Signals and Analysis

For additional details of the signals and their analysis, see the appended AudioNote.

Within the European Community:

EU Authorised representative:
PC Werth Ltd. Audiology House
45 Nightingale Lane, London SW12 8SP UK
Council Directive 93/42/EEC for Medical Devices.

 0088





VERIFIT and RM500SL Test Signals and Analysis

Bill Cole BAsC, PEng

1 Introduction

The Verifit and RM500SL are full-duplex dual-channel audio measurement systems designed for the testing and fitting of all types of hearing instruments and many assistive listening devices. They provide an acoustic test chamber for the testing of devices coupled to standard 2 cm³ couplers as well as sound-field speaker(s) for real-ear measurement (REM) of hearing aid performance. The Verifit test chamber contains two loudspeakers for the functional testing of directional hearing instruments. Test signals are delivered to the device under test via the test chamber loudspeaker(s), the test chamber telephone magnetic-field simulator (TMFS), the test chamber magnetic field test loop (Verifit only) or the sound-field loudspeaker(s). Device output signals are measured in the 2 cm³ coupler via the coupler microphone or in a real ear via the probe microphone. Data from the 2 cm³ coupler may be viewed as coupler SPL, coupler gain or as estimated SPL in the ear canal (simulated real-ear measurements, S-REM). Data from the probe microphone may be viewed as ear canal SPL, as ear canal SPL re normal hearing threshold (i.e. dB HL), as insertion gain or as ear canal SPL in the context of an auditory area (Speechmap[®]).

Some useful facts about broad-band signals

- ∅ **Overall SPL** is the SPL in a band containing all significant frequency components of the signal.
- ∅ **Spectrum level** is the SPL in a band 1 Hz wide.
- ∅ **Band SPL** is the SPL in a restricted frequency range. If the signal is uniform in the band, band SPL = Spectrum level + 10*log(bandwidth).
- ∅ A **spectrum** is the band SPL, or spectrum level, in a series of adjacent bands.
- ∅ For a broad-band signal, the overall SPL is greater than the band SPL and the band SPL is greater than the spectrum level. For a pure tone, the overall SPL, the band SPL and the spectrum level are the same.
- ∅ A **white noise** signal has a spectrum level that is independent of frequency (i.e. constant SPL per Hertz).
- ∅ A **pink noise** signal has a spectrum level that is inversely proportional to frequency (i.e. constant SPL per octave).
- ∅ A **fractional octave** band (e.g. 1/3 octave) has a bandwidth that is proportional to frequency.
- ∅ A pink noise signal has a flat spectrum when analyzed in fractional-octave bands.
- ∅ A **critical band** is a band within which the loudness of a continuously-distributed signal of constant SPL is independent of bandwidth.

2 The test signals

Four types of test signals are currently available. These are tonal signals, pseudo-random noise, digitized real speech signals and the ICRA distorted speech signal. Test signals are generated in real time by the digital signal processor (DSP) or played from 16 bit binary audio files stored in the on-board flash memory. In the Verifit, these audio files are up-loaded from the internal compact disc (CD) drive at power up. In order to provide a repeatable acoustic signal to the device under test, a reference microphone is used in conjunction with a digital control loop to maintain the desired band level at each frequency. Live audio (speech, music etc.) may also be used as a test signal but it is not controlled for spectrum or level.

2.1 Narrow-band signals

2.1.1 Pure tones

Pure-tones are used in the ANSI hearing aid tests, in Multicurve 2 cm³ frequency response tests (gain or output), in 2 cm³ and real-ear single frequency (manual) tests, in real-ear insertion gain tests and in tone-burst maximum output (MPO) tests. Frequencies used are 1/12 octave except for the MPO test which uses 1/3 octave frequencies. Levels from 40 to 90 dB SPL are available at the reference microphone. Control of the level at each frequency is maintained by measuring the frequency response of the signal path to the reference microphone 256 ms before each test using a 256 ms, 50 – 55 dB SPL, multi-tone complex or a 256 ms chirp, depending on the test to follow. Drive levels at each frequency are then set to achieve the desired band levels at the reference

microphone.

2.2 Broad-band signals

2.2.1 Pink Noise signal

The pink noise signal is available for Multicurve 2 cm³ coupler gain and output frequency response measurements and for Insertion gain and Speechmap real-ear measurements. It is a pseudo-random signal composed of 1024 simultaneous tones summed to provide a crest factor of 12 dB. The spectrum of the pink noise signal is controlled by the reference microphone in conjunction with a digital feedback loop with a frequency resolution of 1/12 octave and a response time of about 1/3 of a second. Pink noise was selected as a test signal because it has equal energy per octave, producing a flat spectrum when analyzed in 1/12 or 1/3 octave bands. Figure 1 shows the 1/3 octave spectrum of the pink noise signal and the noise signal specified in ANSI S3.42-1997. Note that the ANSI S3.42-1997 spectrum represents speech peaks not the long-term average.

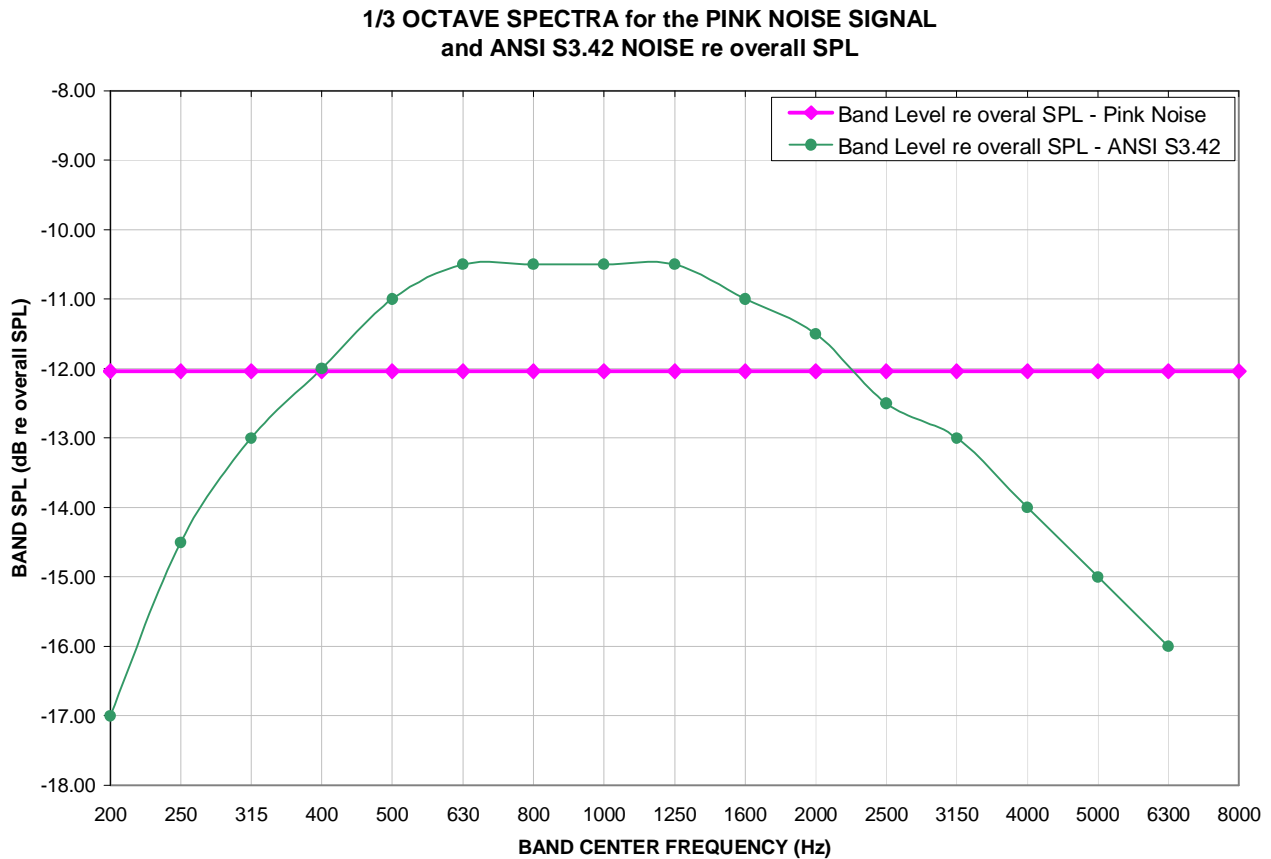

Figure 1: 1/3 octave spectra for the pink noise signal and the noise signal specified in ANSI S3.42-1997.

2.2.2 Dual-direction pink noise signal (Verifit only)

This unique test signal is available in the dual-source Verifit test chamber and for real-ear measurements by adding an additional sound-field speaker. It is similar to the pink noise signal described previously except that the component tones are presented simultaneously from two speakers, half from each. The level of each tone is independently controlled at the reference microphone. Two frequency response curves are generated simultaneously -one for each speaker. This provides a real-time measure of the functioning of the directional features of hearing aids that is independent of compression or noise reduction algorithms. Measurement methods which sequentially measure response from different directions work only with these features disabled.

2.2.3 Real-speech signals

Real-speech signals are provided in Speechmap for both REM and S-REM measurement modes. Four different

digitized speech passages and the single-talker ICRA distorted speech are provided. Each has a duration of 10 – 15 seconds and may be presented as a single passage or in a continuous loop. In order to provide a repeatable speech signal to the device under test, the signal path must be equalized prior to the presentation of the speech signal. This is accomplished by presenting a 896 ms pink noise burst at the selected speech level, 256 ms prior to the start of each speech passage and adjusting a digital filter to provide a flat response at the reference microphone.

The two “Speech-std” signals are by the same male talker, filtered to provide the long-term average speech spectrum (LTASS) recommended by Cox & Moore (1988) for average vocal effort. This is the LTASS assumed in the Desired Sensation Level (DSL) method of hearing aid fitting. The “female” and “child” signals have been chosen to provide a range of spectra and are presented “as recorded” without any processing. Overall SPLs of 50, 55, 60, 65, 70 and 75 dB (at the reference microphone) are available. Soft and Average levels (50 - 70 dB SPL) have the same spectrum. A Loud vocal effort filter is applied to the 75 dB level signals. This is shown in Figure 2.

The ICRA distorted speech signal is a recording of an English-speaking talker that has been digitally modified to make the speech largely unintelligible. The resultant signal has many of the properties of real speech but has a harsh sound and lacks harmonic structure. The latter may be significant for hearing aids which use this property of speech to control noise reduction schemes. The LTASS is similar to the “Speech-std” signals up to 5 kHz.

The test systems provide a simulated real-ear mode (S-REM) in which measurements made in the 2 cc coupler in the test chamber are converted to estimated real ear SPL. In this mode, the effects of hearing aid microphone location need to be included in the test signals so spectra are further altered to include the microphone location effects shown in Figure 3.

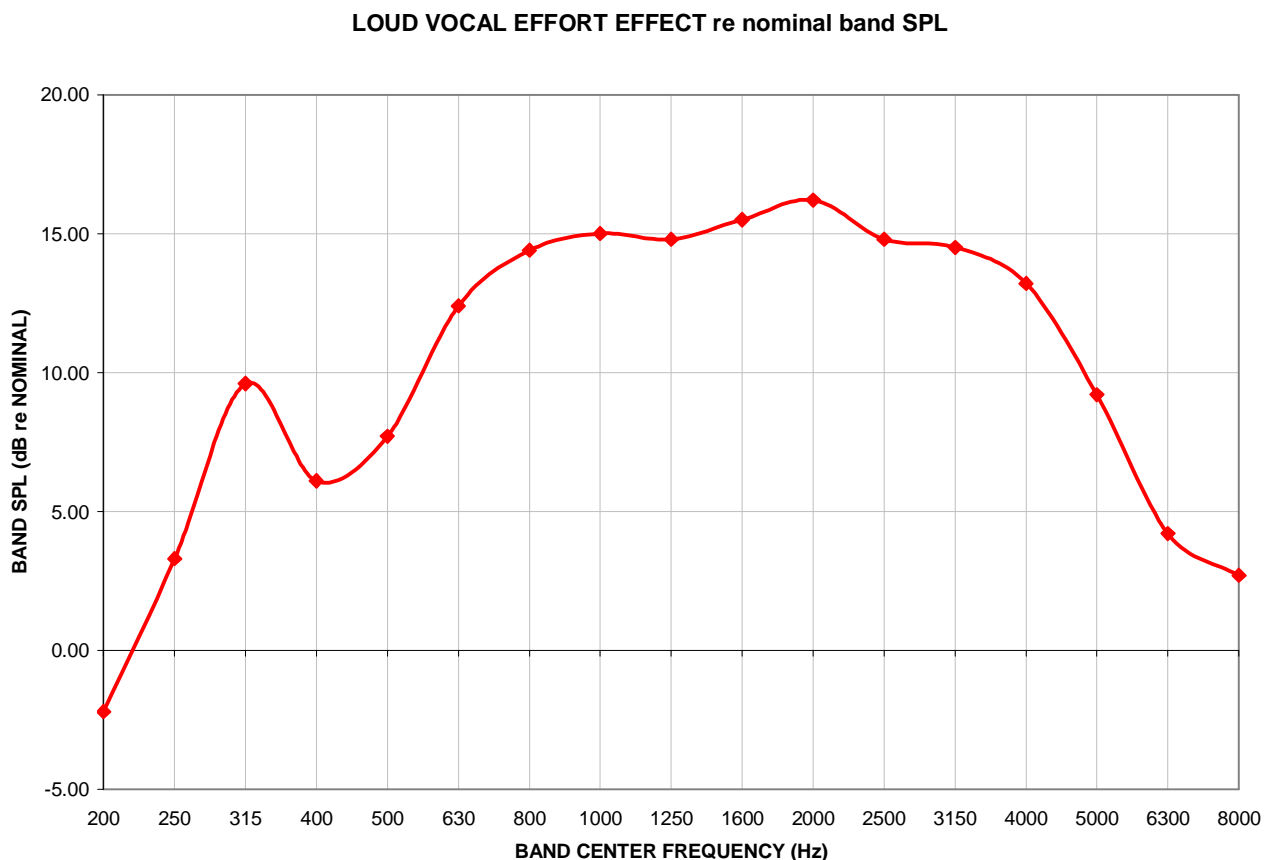

Figure 2: Loud vocal effort effect in dB re nominal band levels. Nominal band levels are band levels for an overall SPL of 65 dB. This shaping is applied to the 75 dB SPL speech and ICRA signals.

In addition to these well-controlled and repeatable signals, live speech may be used as a test signal. It will, of course, be unequalized and at an uncontrolled level.

MICROPHONE LOCATION EFFECTS re nominal band SPL

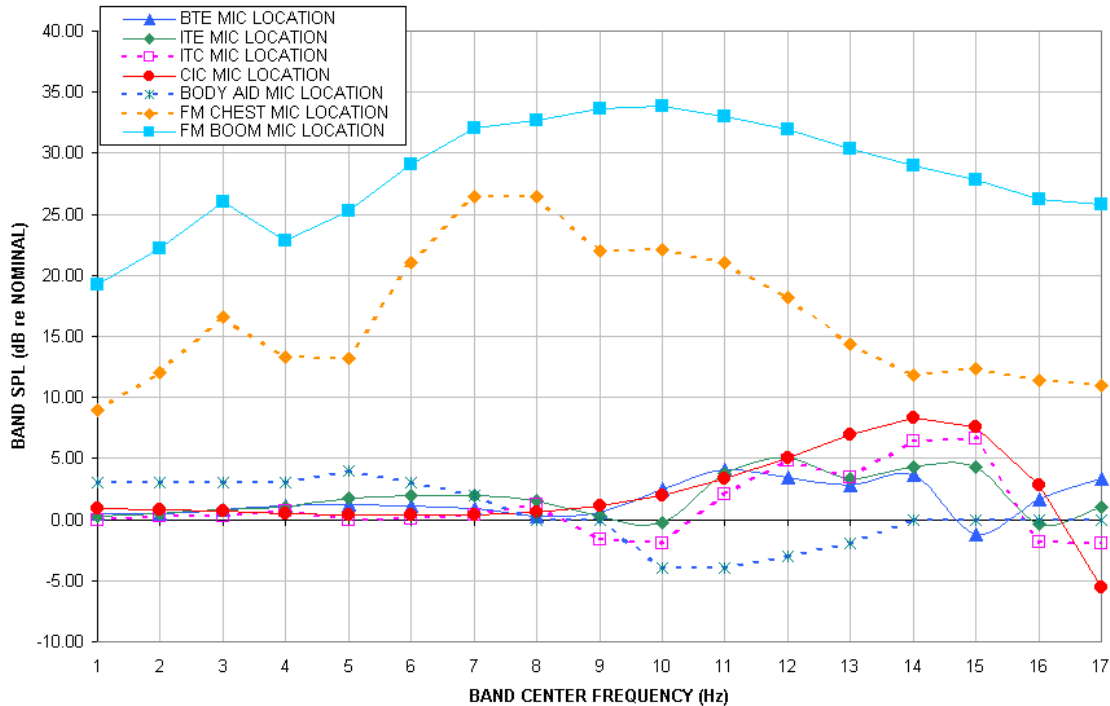

Figure 3: Microphone location effects in dB re nominal band SPL. Nominal band levels are band levels for an overall rms level of 65 dB SPL and average vocal effort in a free sound field.

3 Analysis of broad-band signals

Broad-band signals contain energy at many frequencies simultaneously. Such signals are usually analyzed in a series of narrow frequency bands to produce a spectrum. The auditory system functions on a logarithmic frequency scale and analyzes broad-band signals in critical bands which approximate 1/3 octave bands (Figure 4). Using 1/3 octave bands for analysis of broad-band signals allows measured levels to be compared more readily to narrow-band behavioral measures, such as threshold. For this reason, analysis of broad-band signals in all Real-Ear Measurements (including S-REM in Speechmap) is in 1/3 octave bands. Other analyzers use narrower analysis bands, sometimes having constant bandwidth. As shown in Figure 4, this can result in significantly underestimating the audibility (or comfort or discomfort) of a complex signal.

It should be noted that, in all Real-Ear Measurements, 1/3 octave band SPL is displayed (and reported when saving data to a file) at 1/12 octave frequencies which provides curve smoothing. When calculating overall rms from these data, the SPL at 225 Hz and subsequent 1/3 octave increments should be used.

Analysis of broad-band signals in all Hearing Instrument Tests is in 1/12 octave bands and the band SPL is displayed at 1/12 octave frequencies.

3.1 Pink noise signal analysis

All band levels are calculated with an averaging time of 128 ms.

For a linear hearing aid, a pink noise stimulus will result in a response curve that has the same shape as one obtained using a swept pure tone. However, it must be remembered that, while a swept tone has the same band SPL as overall SPL, the band SPL for a noise signal is significantly lower than the overall SPL. Consequently, for a linear aid, output curves obtained using 1/12 octave analysis will be about 18 dB lower than the output curves obtained using a swept tone at the same overall SPL. As long as the hearing aid is linear, the gain obtained will be the same for both signals. Figure 5 shows output (A) and gain (B) for a linear hearing aid, obtained using a swept tone (1) and pink noise (2) with a 60 dB overall SPL.

**Analysis Bandwidth Used by Various Analyzers
To Analyze Complex Signals**

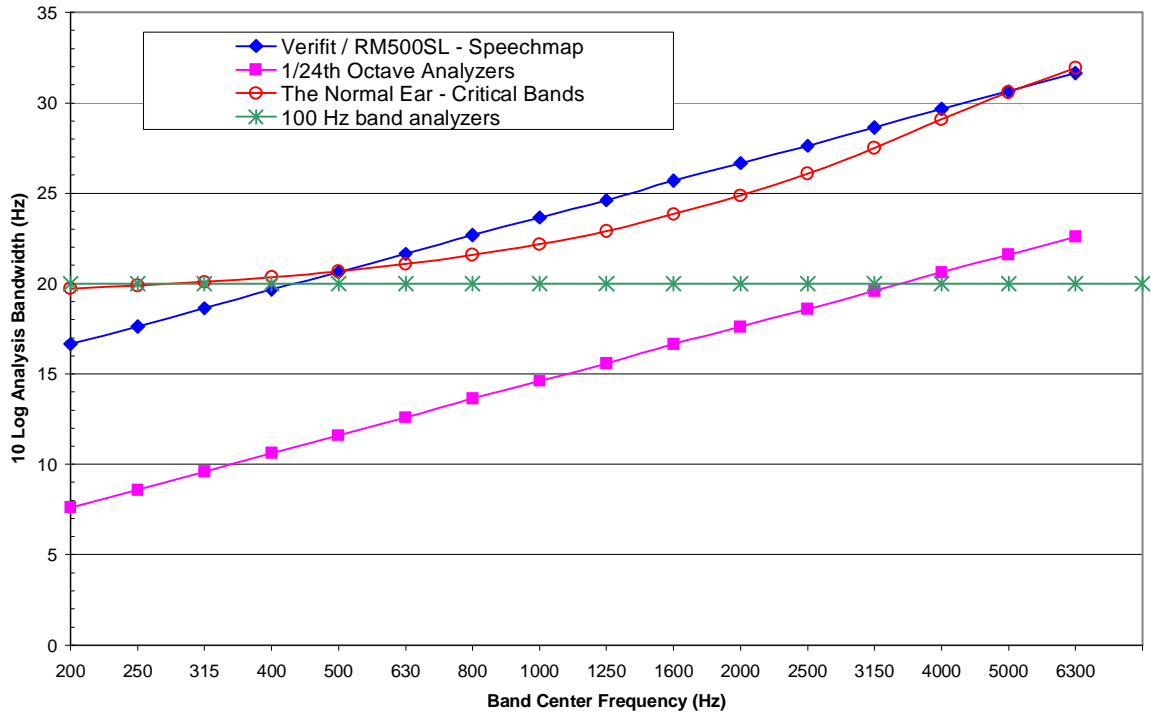

Figure 4: Analysis bandwidths of some real-ear analyzers and critical bands for a normal ear. If the analysis bandwidth is less than a critical band, aided response curves shown to be at threshold (or UCL) will actually be well above it.

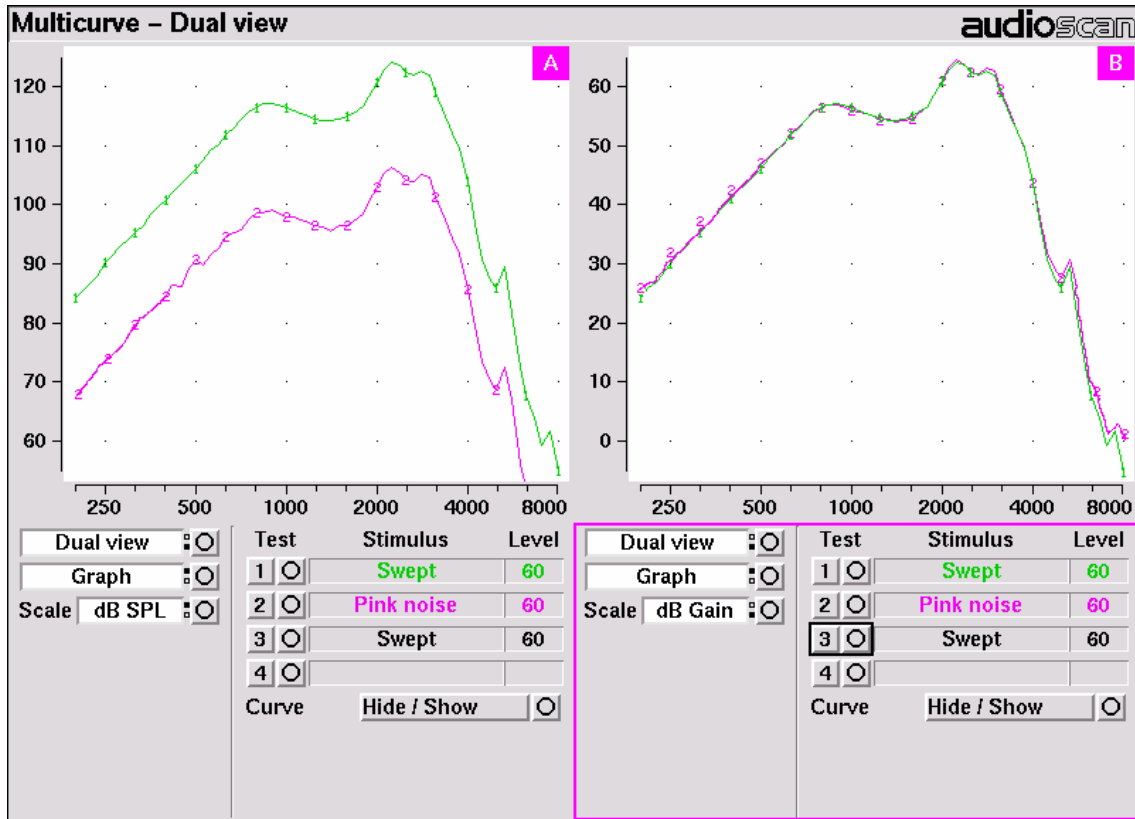

Figure 5: Output (left) and Gain (right) curves for a linear hearing aid, generated using a swept tone (1) and pink noise analyzed in 1/12 octave bands (2). (Dual view not available in RM500SL)

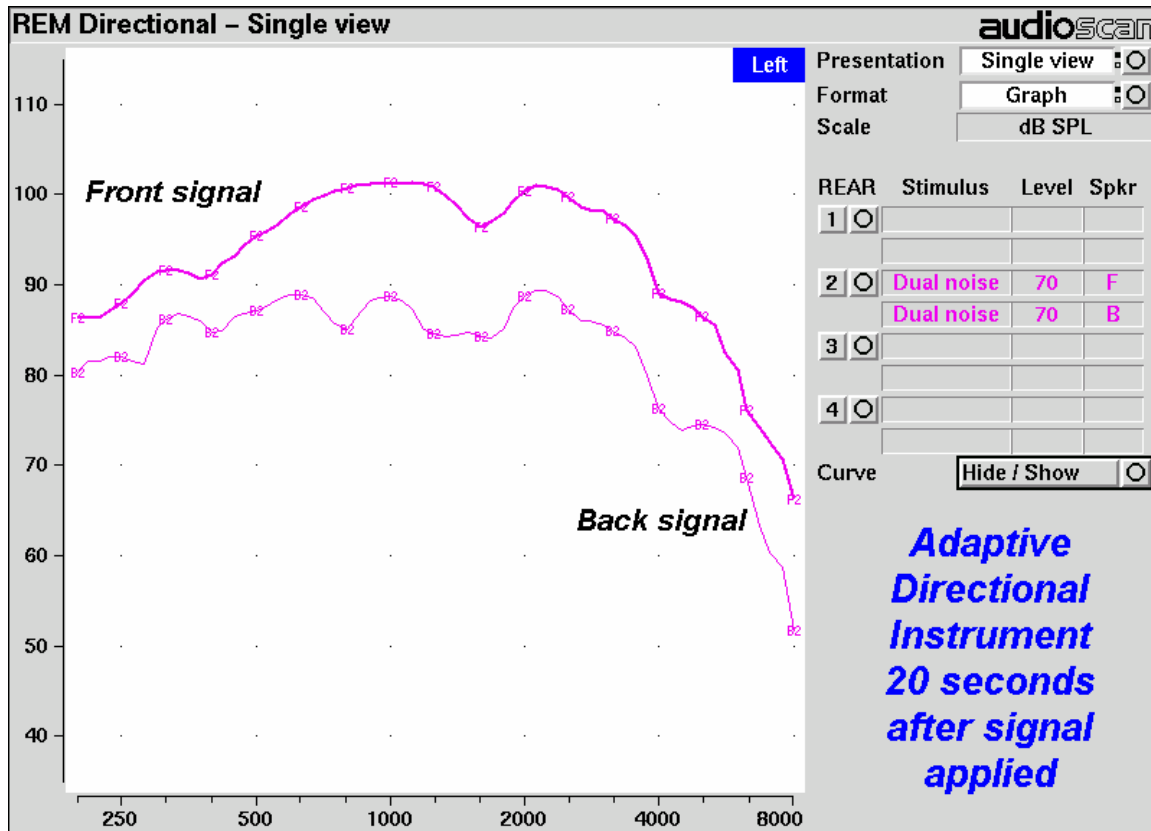

Figure 6: A real-ear directional test on an adaptive instrument with active compression and noise reduction. (Directional test not available in RM500SL)

3.2 Real-speech signal analysis

One of the most-used measures of a speech signal is the long-term average speech spectrum (LTASS). This is a 1/3 octave spectrum averaged over a sufficiently long portion of the speech material to provide a stable curve. In practice a 10 second average meets this requirement and, for this reason, all Speechmap passages are at least 10 seconds long.

The dynamic nature of speech is often characterized by the distribution of short-term levels in each 1/3 octave band. These levels are determined by calculating a spectrum for each of a series of short time periods within the passage. Historically, time periods of 120, 125 or 128 ms have been used. The Verifit and RM500SL use a 128 ms time period, resulting in 100 levels (or samples) in each 1/3 octave band for a 12.8 second passage. The level in each band that is exceeded by 1% of the samples (called L1, the 1st or 99th percentile) has historically been referred to as the speech peak for that band. The curve for these 1% levels is approximately 12 dB above the LTASS. The level in each band that is exceeded by 70% of the samples (called L70, the 70th or 30th percentile) has historically been called the valley of speech for that band. The curve for these 70% levels is approximately 18 dB below the LTASS. The region between these two curves is often called the speech region, speech envelope or speech “banana”. The speech envelope, when derived in this way, has significance in terms of both speech detection and speech understanding. Generally, speech will be detectable if the 1 % level is at or near threshold. The Speech Intelligibility Index (SII) is maximized when the entire speech envelope (idealized as a 30 dB range) is above (masked) threshold. This will not be an SII of 100% (or 1) because of loudness distortion factors, but higher SII values will not produce significantly higher scores on most test material. The speech-reception threshold (SRT) is attained when the LTASS is at threshold (approximately - depending on test material and the individual). These scenarios are shown in Figures 7 - 9 which follow.

It should be noted that analysis methods which use shorter time periods produce higher peak levels and significantly different speech envelopes. In order to produce results that can be directly compared to measures of threshold (and UCL), the analysis time period needs to approximate the integration time of the ear. Although this varies with frequency and individuals, a value between 100 - 200 ms is likely. The Verifit and RM500SL use a

128 ms analysis time period as an approximation because it also has considerable historic support.

Because the spectrum of a speech signal varies with time, it is necessary to average measurements over several seconds to obtain a stable, repeatable result. However, the effects of adjustments to hearing aid parameters need to be seen quickly in order to be useful for optimization. To resolve these conflicting needs, speech signals are first presented in a repeating loop with a sound-field equalization test prior to the start of each passage. A running calculation of the short-term speech envelope and average is performed on 2 - 3 seconds worth of data and is displayed in real time so that the effects of adjustments to hearing aid parameters are easily viewed. Pressing the Continue key causes the passage to restart and run in its entirety. The envelope and average are calculated over the full passage to provide stable and repeatable data.

When using live speech as a test signal, a "Freeze curve" function is available to capture the short-term spectra for examination and counseling purposes.

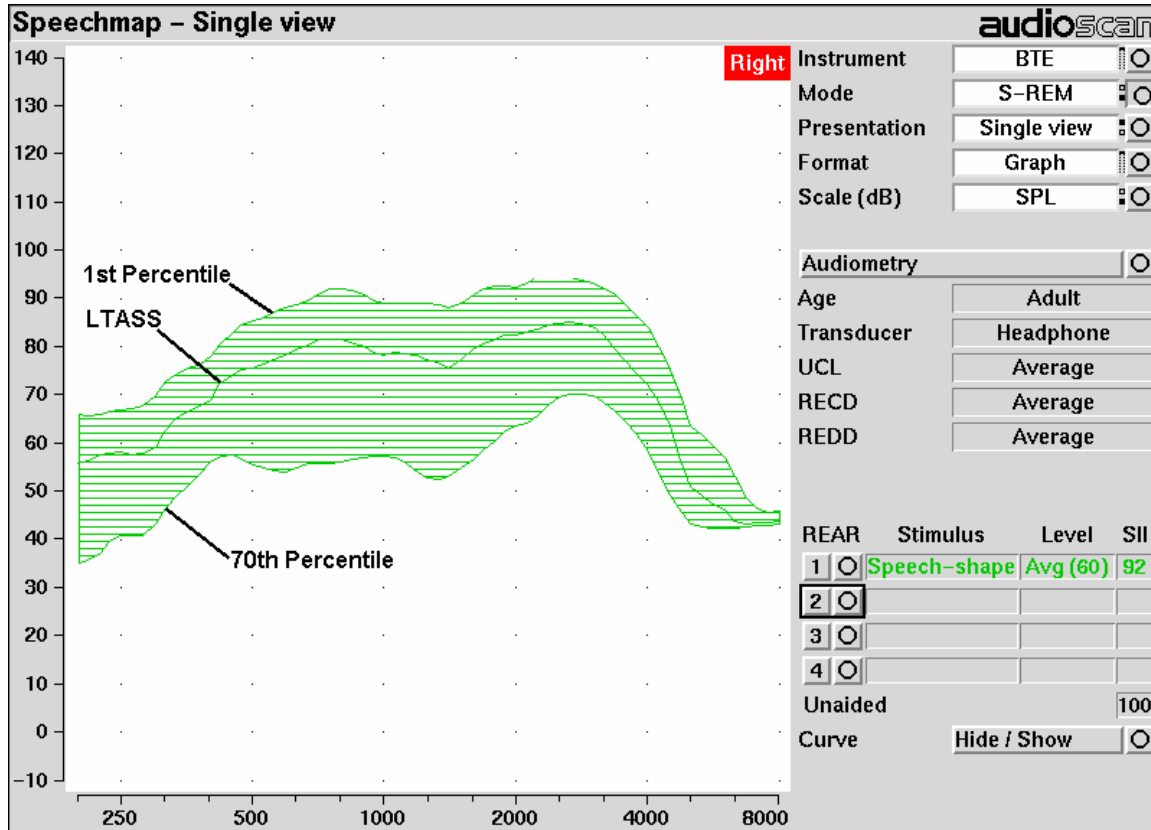

Figure 7: Example of speech envelope and LTASS

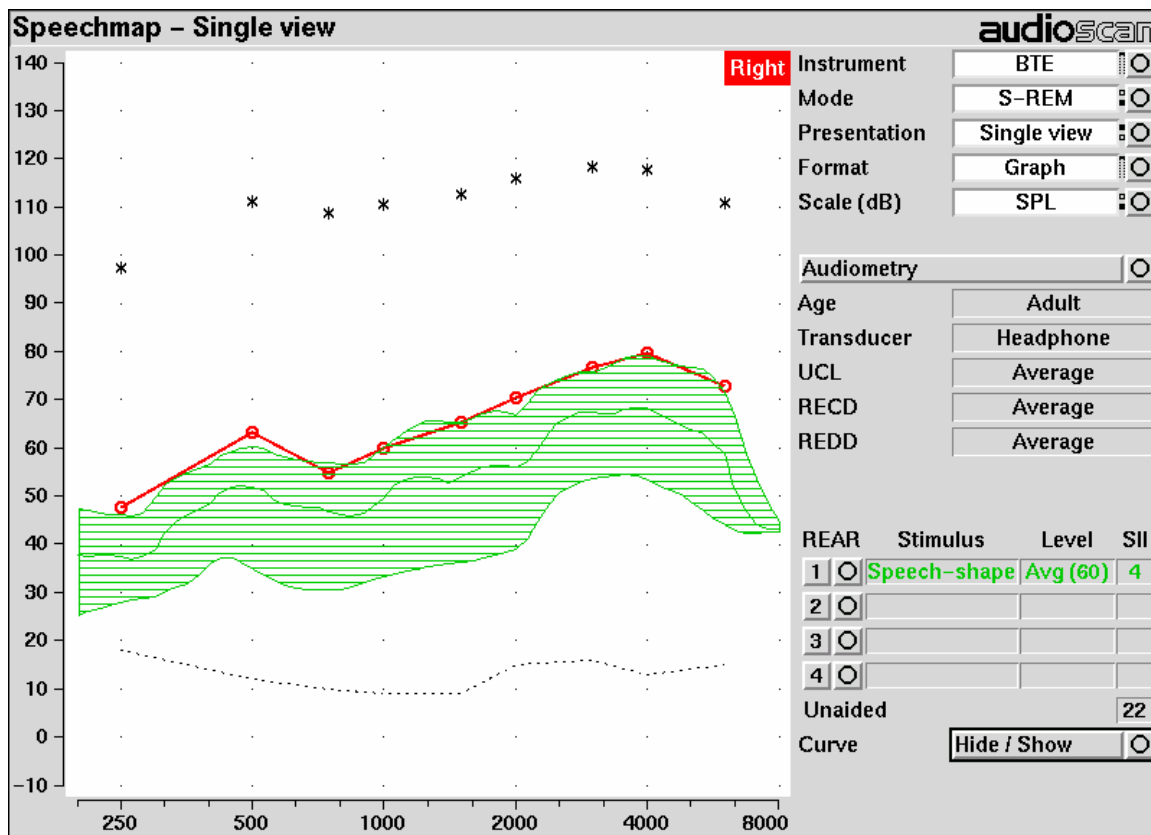

Figure 8: Speech is detectable but not understandable if the 1st percentile is at threshold

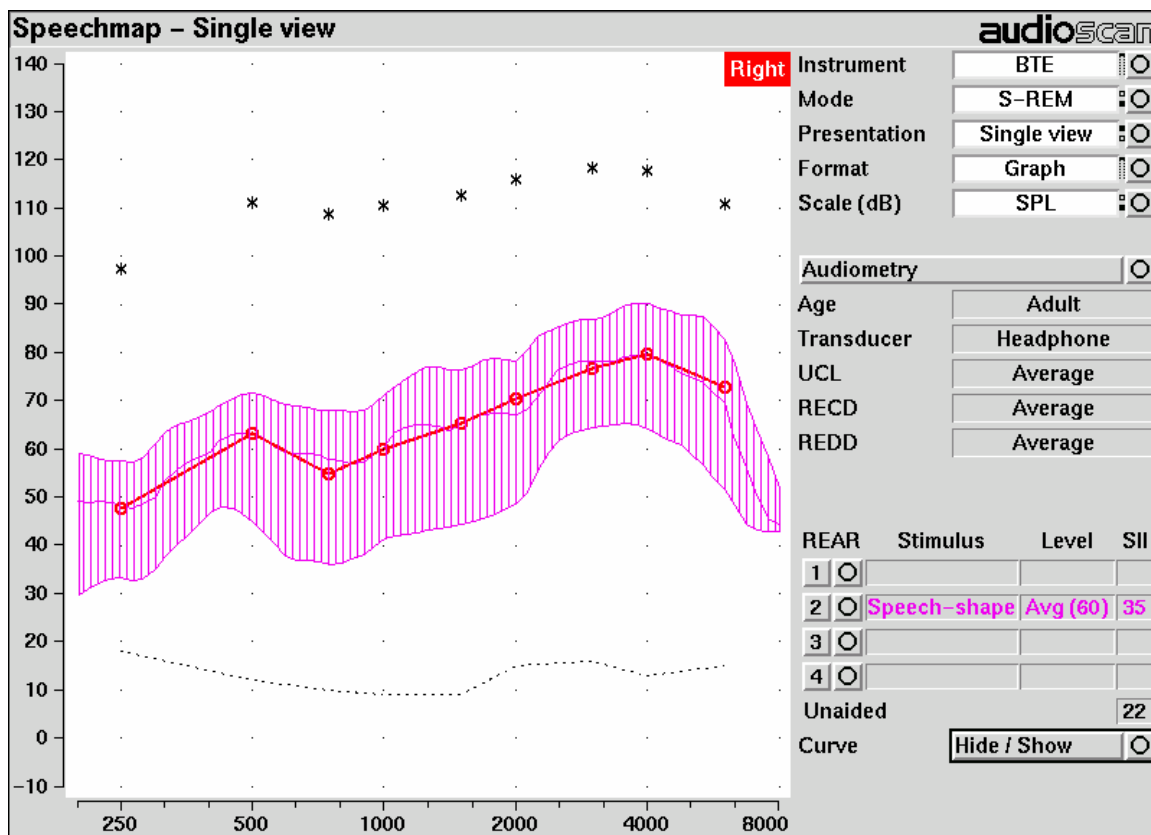

Figure 9: When LTASS is at threshold, SII \approx 33% which corresponds approximately to SRT

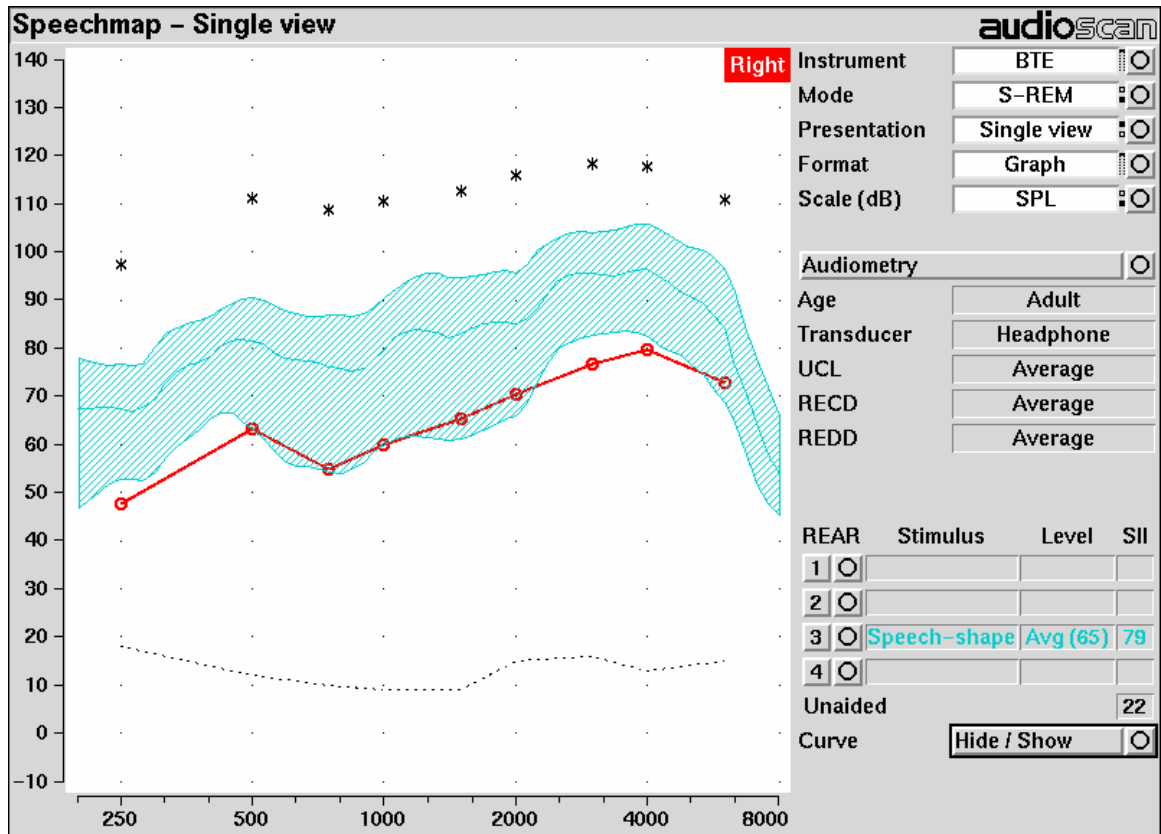

Figure 10: The highest SII is obtained when the entire speech envelope is above threshold

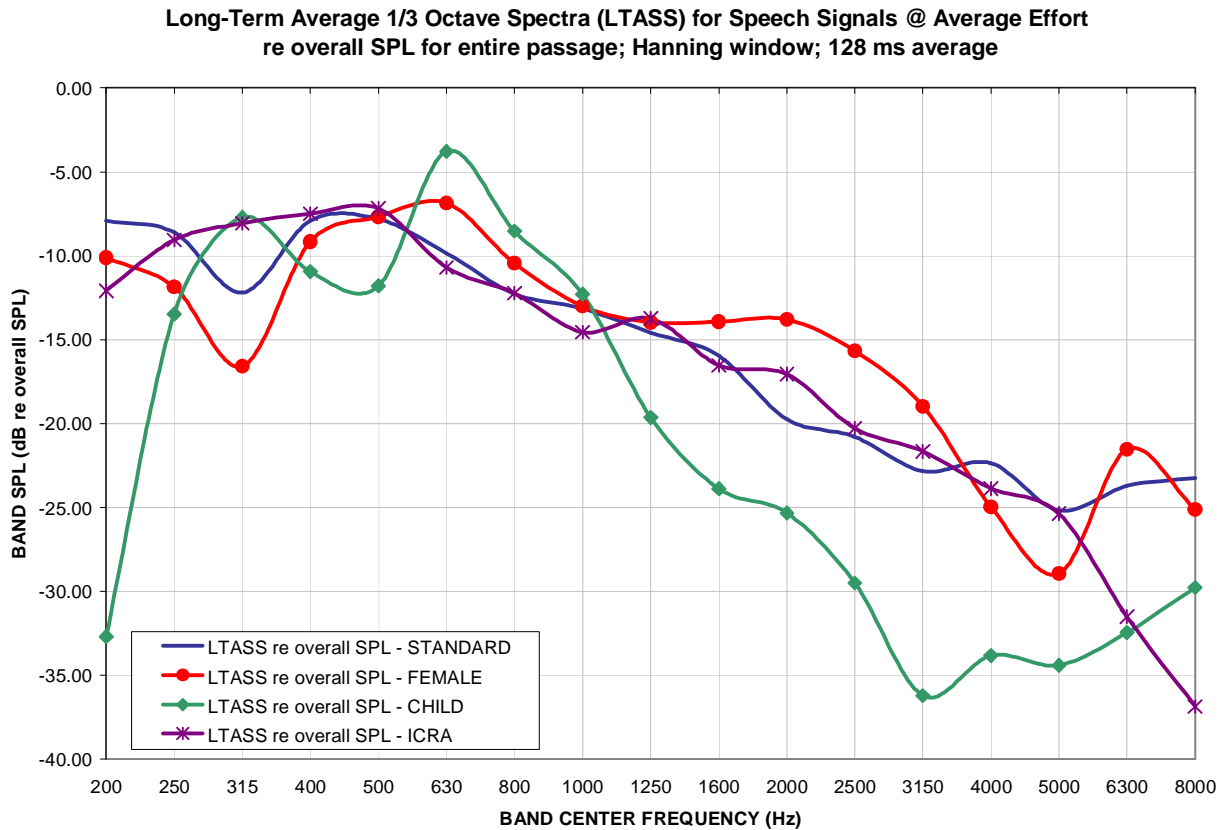

Figure 11: LTASS for Speechmap speech signals at average vocal effort

1st Percentile of 1/3 Octave Band SPLs for Speech Signals @ Average Effort]
re LTASS for entire passage; Hanning window; 128 ms average

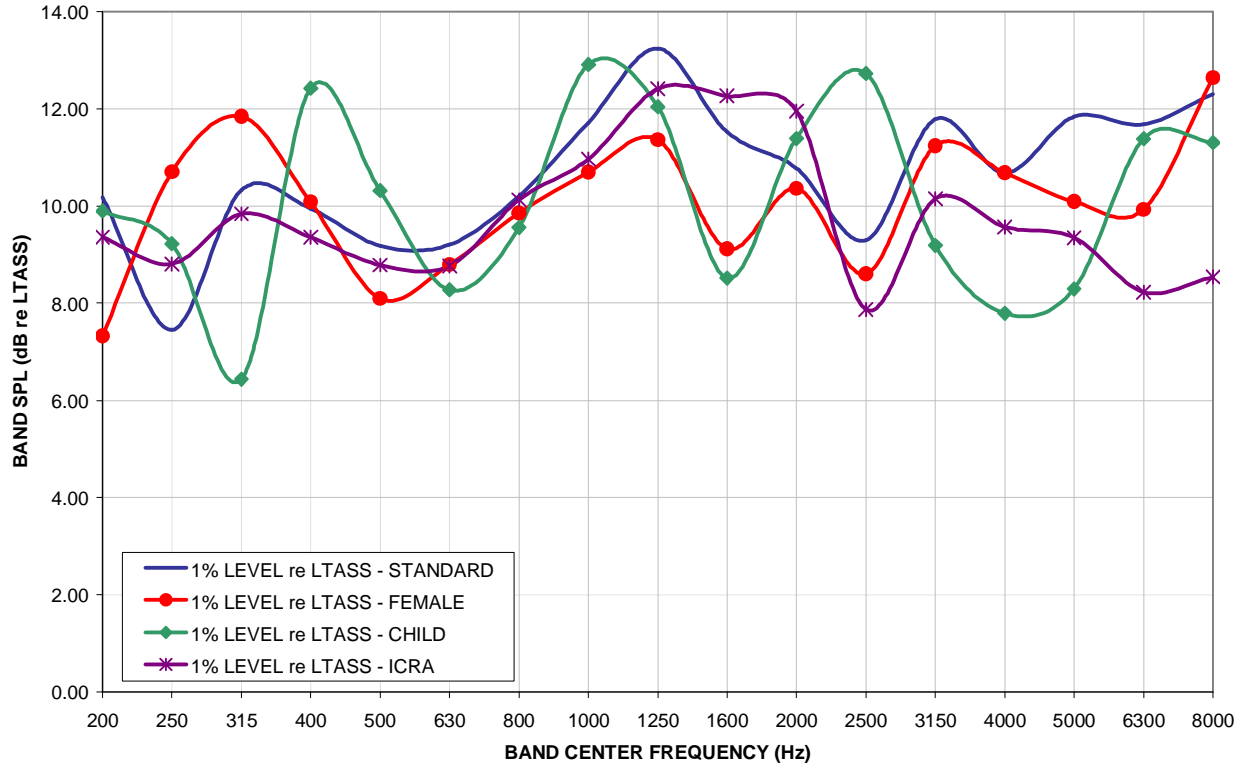

Figure 12: Level of first percentile for Speechmap speech signals at average vocal effort

70th Percentile of 1/3 Octave Band SPLs for Speech Signals @ Average Effort]
re LTASS for entire passage; Hanning window; 128 ms average

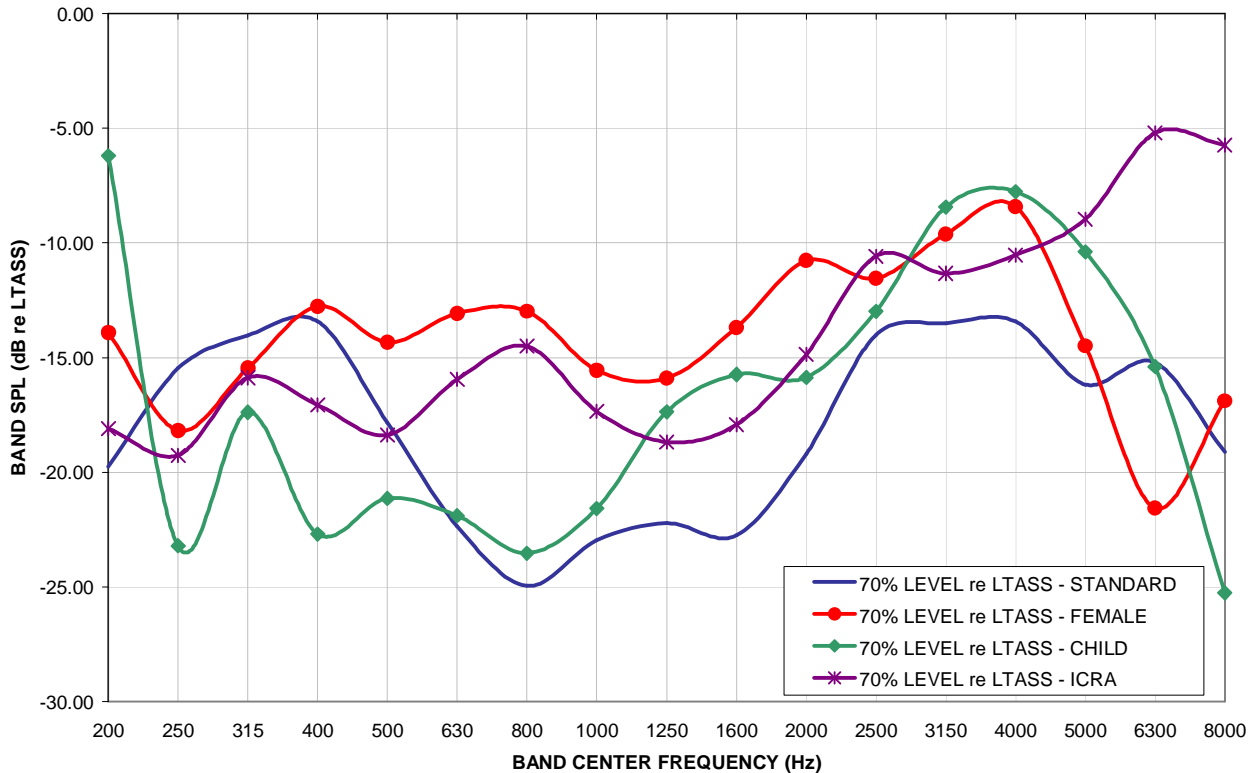

Figure 13: Level of 70th percentile for Speechmap speech signals at average vocal effort

Dynamic Range for Speech Signals @ Average Effort]
 re LTASS for entire passage; Hanning window; 128 ms average

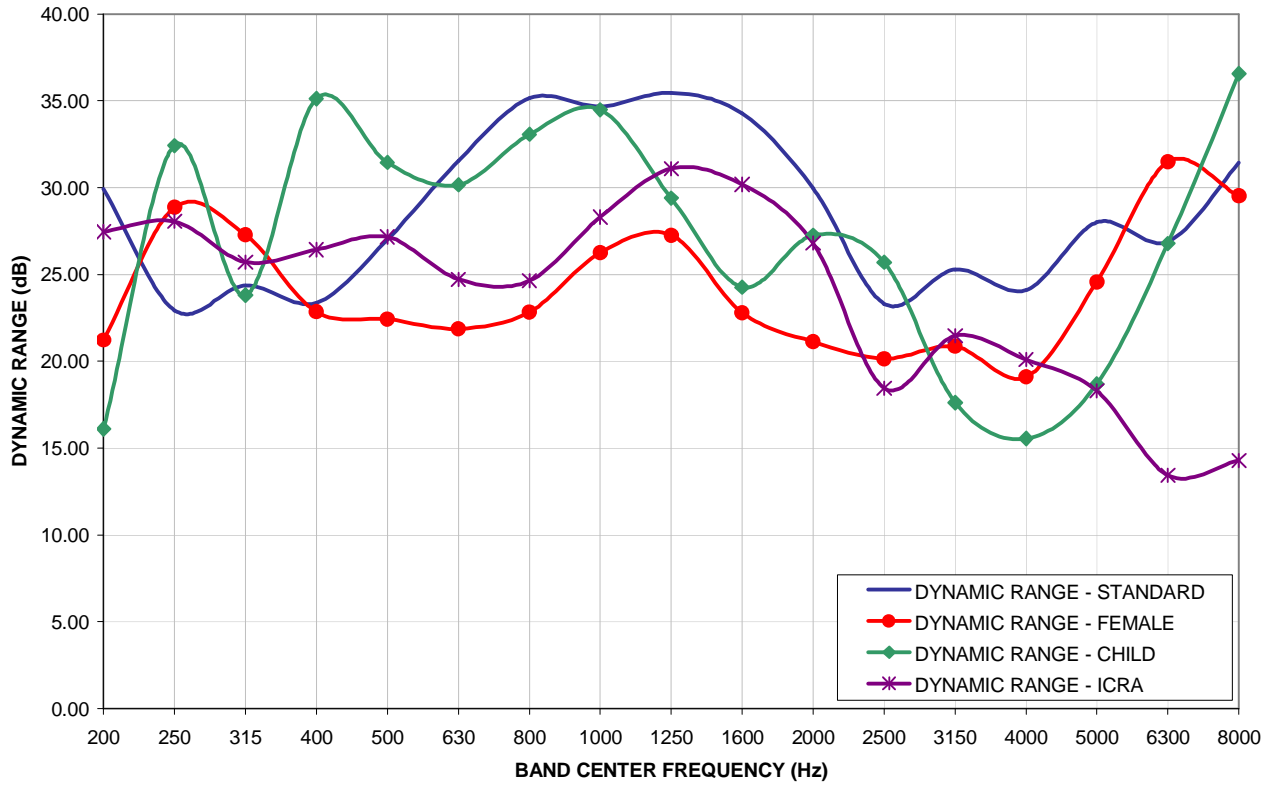

Figure 14: Dynamic range of Verifit speech signals at average vocal effort