



User Guide

HTC Touch Pro™

www.sprint.com

*© 2008 Sprint. Sprint and the logo are trademarks of Sprint.
Other marks are the property of their respective owners.*

Table of Contents

Introduction	<i>i</i>
Section 1: Getting Started	1
1A. Setting Up Service	2
Setting Up Your Smart Device	2
Activating Your Device	4
Setting Up Your Voicemail	5
Sprint Account Passwords	6
Getting Help	7
Section 2: Your Device	9
2A. Device Basics	10
Your Device	10
Accessories	13
Features of Your Device	14
Turning Your Device On and Off	14
Using Your Device's Battery and Charger	15
Navigating On Your Device	17
The Home Screen	19
LED Alerts	24
Adjusting the Volume	24
Using the Getting Started Application	25
2B. Using Phone Features	26
The Phone Screen	26
Displaying Your Phone Number	27
Making a Call	27
Answering a Call	29
Ending a Call	31
Checking Missed Calls	31
Call History	31
Speed Dial	33
Voice and Data Roaming	33
Turning the Phone On and Off	36
2C. TouchFLO 3D	37
Using the TouchFLO 3D Home Screen	37
Finger Gestures	52

2D. Entering Text	54
The Sliding QWERTY Keyboard vs. Onscreen Input Methods	54
Using the Sliding QWERTY Keyboard	56
Using the Full QWERTY Layout	57
Using the Compact QWERTY Layout	58
Using the Phone Keypad	59
Using Multitap and T9 Modes	60
Using Numeric and Symbol Mode	61
Using Block Recognizer	61
Using Letter Recognizer	62
Using Transcriber	62
2E. Synchronizing Information With Your Computer	63
About Synchronization	63
Ways to Synchronize	63
Setting Up Windows Mobile Device Center on Windows Vista	64
Setting Up ActiveSync on Windows XP	65
Synchronizing With Your Computer	66
Synchronizing via Bluetooth	67
Synchronizing Music and Video	68
2F. Contacts, Calendar, and Other Tools	69
Contacts	69
Calendar	71
Notes	73
Tasks	74
Comm Manager	75
Adobe Reader LE	76
Microsoft Office Mobile	77
ClearVue Presentation 5 Pro	78
Automatic Speech Recognition (ASR)	78
Voice Recorder	79
Zip	81
WorldCard Mobile (Business Card Scanner)	82
JETCET PRINT 5 (Wireless Printing Application)	84
2G. microSD Card	86
Using a microSD Card on Your Phone	86
Managing the microSD Card	87
Using Your Device as a USB Drive	88
2H. Bluetooth	89
Using Bluetooth	89
Bluetooth Explorer and Bluetooth File Sharing	92
Printing Files via Bluetooth	93

2I. Experiencing Multimedia	94
Taking Photos and Videos	94
Viewing Photos and Videos	103
Using Windows Media Player Mobile	109
Using Audio Booster	113
Using MP3 Trimmer	114
2J. Managing Your Device	115
Copying and Managing Files	115
Settings on Your Device	116
Changing Basic Settings	119
Using Task Manager	122
Connecting to an External Display	123
Protecting Your Device	124
Managing Memory	125
Adding and Removing Programs	125
Resetting Your Device	126
Windows Update	127
Using the Strap Holder	128
Section 3: Sprint Service	129
3A. Sprint Service Features: The Basics	130
Using Voicemail	130
Using SMS Text Messaging	133
Using Caller ID	135
Responding to Call Waiting	136
Making a Three-Way Call	136
Using Call Forwarding	136
3B. Internet	137
Ways of Connecting to the Internet	137
Getting Started With Data Services	140
Navigating the Web	143
Using Windows Live	147
Using Pocket Express	150
Using RSS Hub	152
Using Your Device As a Modem	156
Using Remote Desktop Mobile	157
Accessing Sprint Instant Messaging	158
Using Sprint Picture Mail	160
Email Messaging	162
Working With Company Email and Meeting Appointments	168

3C. Entertainment: TV, Music, and Video	175
TV	175
Sprint Music Store	177
YouTube	179
Streaming Media	183
3D. GPS Navigation	185
Guidelines and Preparation for Using GPS	185
Downloading Satellite Data via QuickGPS	186
Using Sprint Navigation	187
Section 4: Safety Information and Other Notices	191
4A. Safety Information	192
Important Health Information and Safety Precautions	192
General Precautions	195
Additional Safety Information	196
4B. Regulatory Notices	200
Regulatory Agency Identifications	200
Federal Communication Commission Interference Statement	200
Industry Canada Statement	201
FCC Hearing-Aid Compatibility (HAC) Regulations for Wireless Devices	201
SAR Information	202
IC Statement	203
Telecommunications & Internet Association (TIA) Safety Information	203
WEEE Notice	204
RoHS Compliance	204
4C. Warranty, Disclaimers and Other Notices	205
Manufacturer's Warranty	205
Privacy Restrictions	207
Weather Disclaimer	207
Warranty Disclaimer	207
Limitation of Damages	207
4D. Copyright, Trademark, and Proprietary Notices	208
Index	209

Introduction

This *User Guide* introduces you to Sprint® service and all the features of your new smart device. It's divided into four sections:

- ◆ *Section 1: Getting Started*
- ◆ *Section 2: Your Device*
- ◆ *Section 3: Sprint Service*
- ◆ *Section 4: Safety Information and Other Notices*

Throughout this guide, you'll find tips that highlight special shortcuts and timely reminders to help you make the most of your new device and service. The Table of Contents and Index will also help you quickly locate specific information.

You'll get the most out of your device if you read each section. However, if you'd like to get right to a specific feature, simply locate that section in the Table of Contents and go directly to that page. Follow the instructions in that section, and you'll be ready to use your device in no time.

User Guide Note

Because of updates in the device's software, this user guide may not be the most current version for your device. Visit www.sprint.com and log on to My Sprint Wireless to access the most recent version of the user guide.

WARNING

Please refer to "Safety Information" on page 192 to learn about information that will help you safely use your device. Failure to read and follow the Important Health and Safety Information in this user guide may result in serious bodily injury, death, or property damage.

Section 1

Getting Started



Setting Up Service

- ◆ [Setting Up Your Smart Device \(page 2\)](#)
- ◆ [Activating Your Device \(page 4\)](#)
- ◆ [Setting Up Your Voicemail \(page 5\)](#)
- ◆ [Sprint Account Passwords \(page 6\)](#)
- ◆ [Getting Help \(page 7\)](#)

Setting up and activating your new smart device is quick and easy. This section walks you through the necessary steps to set up your device, activate your device's phone, set up your voicemail, establish passwords, and contact Sprint for assistance with your Sprint service.

Setting Up Your Smart Device

When you take your device out of the box, install the battery, turn on the power, and complete the Quick Start Wizard to prepare your device for use.

Note You can also insert a microSD™ card into your device. To learn how to insert a microSD card, see "Using a microSD Card on Your Phone" on page 86.

Installing the Battery

1. Remove the back cover by following these steps:
 - Hold the device with both hands and the front panel facing down.
 - Push the back cover up with your thumb until it disengages from the device and then slide it up to remove.

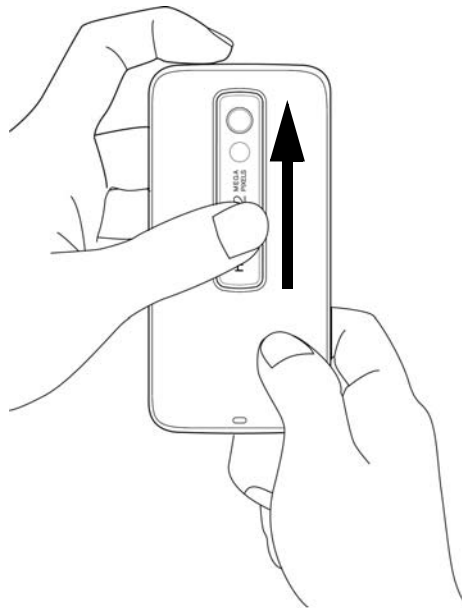

2. Install the battery by following these steps:

- Align the battery's exposed copper contacts with the battery connectors inside the battery compartment.

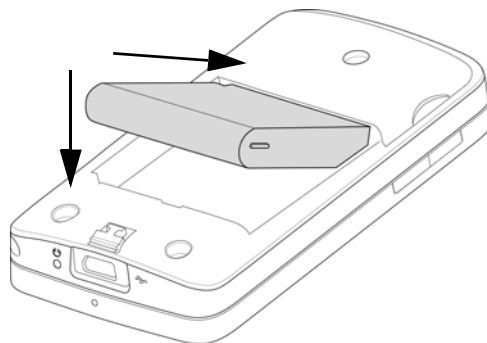

- Insert the contact's side of the battery first and then gently push the battery into place.

3. Replace the back cover.

Turning the Device On for the First Time

1. Press and hold the **Power** key for a few seconds.
2. When you turn on your device for the first time, the Quick Start Wizard starts up and guides you to calibrate the touch screen. Follow the onscreen instructions to complete the screen calibration process.
3. The wizard then starts a basic tutorial that illustrates how to use the stylus to perform copy and paste operations. You can choose to go through the tutorial or tap **Skip** to cancel the tutorial.
4. The wizard then allows you to set a device password. You can cancel this first and do it at another time. For instructions on how to set a device password, see "Protecting Your Device" on page 124.
5. After the Quick Start Wizard finishes, your device goes through a customization process. Wait for the customization to complete.
6. Your device then restarts itself.
 - If your device's phone is already activated, it will search for Sprint service and then enter standby mode.
 - If your device's phone is not yet activated, see "Activating Your Device" on page 4 for more information.

Note *Your device's battery should have enough charge for your device to turn on and find a signal, set up your voicemail, and make a call. You should fully charge your battery as soon as possible. See "Charging the Battery" on page 16 for details.*

Activating Your Device

- If you purchased your smart device at a Sprint Store, your device should be activated and ready to use.
- If you received your device in the mail and it is for a new Sprint account or a new line of service, it is designed to activate automatically. To confirm your activation, make a phone call.
- If you received your device in the mail and you are activating a new phone for an existing number on your account, you will need to contact Sprint Customer Service to activate your new device. There are two activation options:
 - From your computer's Web browser, go to www.sprint.com/activate and complete the onscreen instructions to activate your device.
 - or —
 - Dial 1-888-211-4727 from another phone to contact Sprint Customer Service to complete the phone activation.

When you have finished, make a phone call to confirm your activation.

Tip Do not press the **End** key while your device is being activated. Pressing the **End** key cancels the activation process.

Note If you are having difficulty with activation, contact Sprint Customer Service by dialing 1-888-211-4727 from any other phone.

Making Your First Call

1. Press the **Talk** key to display the Phone screen.

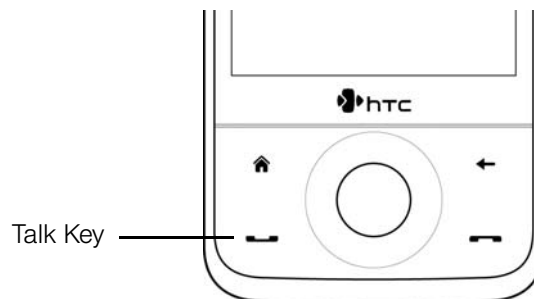



2. Tap the keys on the Phone keypad to enter the phone number.
3. Press the **Talk** key again to place the call.

For more information about using your device to make and receive phone calls, see “Using Phone Features” on page 26.

Setting Up Your Voicemail

All unanswered calls to your device are automatically transferred to your voicemail, even if your device is in use or turned off. Therefore, you will want to set up your voicemail and personal greeting as soon as your device is activated.

To set up your voicemail:

1. Press the **Talk** key to display the Phone screen.
2. Tap and hold  on the Phone keypad.
3. Follow the system prompts to:
 - Create your passcode.
 - Record your greeting.
 - Record your name announcement.
 - Choose whether to activate One-Touch Message Access (a feature that lets you access messages simply by pressing and holding , bypassing the need for you to enter your passcode).

Note *If you are concerned about unauthorized access to your voicemail account, Sprint recommends you enable your voicemail passcode.*

Sprint Account Passwords

As a Sprint customer, you enjoy unlimited access to your personal account information, your voicemail account, and your data services account. To ensure that no one else has access to your information, you will need to create passwords to protect your privacy.

Account Password

If you are the account owner, you will create an account user name and password when you sign on to www.sprint.com. (Click ***Need to register for access?*** to get started.) If you are not the account owner (if someone else receives the bill for your Sprint service), you can get a sub-account password at www.sprint.com.

Voicemail Password

You will create your voicemail password (or passcode) when you set up your voicemail. See "Setting Up Your Voicemail" on page 5 for more information on your voicemail password.

Data Services Password

With your smart device, you may elect to set up an optional data services password to control data (Web) access and authorize Premium Service purchases.

For more information or to change your passwords, sign on to www.sprint.com.

Getting Help

Managing Your Account



Online: www.sprint.com

You can go online to:

- Access your account information.
- Check your minutes used (depending on your Sprint service plan).
- View and pay your bill.
- Enroll in Sprint online billing and automatic payment.
- Purchase accessories.
- Shop for the latest Sprint devices.
- View available Sprint service plans and options.
- Learn more about data services and other great products like Sprint Picture Mail, games, ringtones, screen savers, and more.

Reaching Sprint Customer Service

You can reach Sprint Customer Service many different ways:

- From the Phone screen, dial   and then press the **Talk** key.
- Sign on to your account at www.sprint.com.
- Call us toll-free at **1-888-211-4727** (Consumer customers) or **1-888-788-4727** (Business customers).
- Write to us at Sprint Customer Service, P.O. Box 8077, London, KY 40742.

Automated Billing Information

For your convenience, your device gives you access to billing information on your Sprint account. This information includes balance due, payment received, invoicing cycle, and the number of minutes used since your last invoicing cycle.

To access automated billing information:

- ▶ From the Phone screen, dial   and then press the **Talk** key.

Note This service may not be available in all Affiliate areas.

Sprint 411

You have access to a variety of services and information through Sprint 411, including residential, business, and government listings; assistance with local or long-distance calls; movie listings; and hotel, restaurant, shopping, and major local event information. There is a per-call charge and you will be billed for airtime.

To call Sprint 411:

- ▶ From the Phone screen, dial    and then press the **Talk** key.

Sprint Operator Services

Sprint Operator Services provides assistance when placing collect calls or when placing calls billed to a local telephone calling card or third party.

To access Sprint Operator Services:

- ▶ From the Phone screen, dial  and then press the **Talk** key.

For more information or to see the latest in products and services, visit us online at www.sprint.com.

Section 2

Your Device



Section 2A

Device Basics

- ◆ *Your Device (page 10)*
- ◆ *Accessories (page 13)*
- ◆ *Features of Your Device (page 14)*
- ◆ *Turning Your Device On and Off (page 14)*
- ◆ *Using Your Device's Battery and Charger (page 15)*
- ◆ *Navigating On Your Device (page 17)*
- ◆ *The Home Screen (page 19)*
- ◆ *LED Alerts (page 24)*
- ◆ *Adjusting the Volume (page 24)*
- ◆ *Using the Getting Started Application (page 25)*

Before you start using your device, take some time to familiarize yourself first with what is available on your device. This section will introduce about the device controls, home screen, and programs on your device. Basic functions such as turning your device on and off, navigating on your device, and adjusting sound volume will also be covered in this section.

Your Device

Top Panel

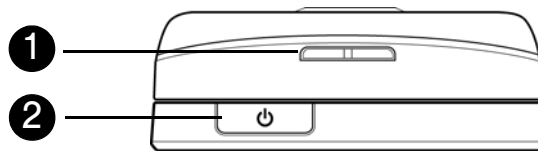

1. **Speaker.** Listen to media from here.
2. **Power Key.** Press to turn off the display temporarily. To turn off the power, press and hold for about five seconds. (For more information, see “Turning Your Device On and Off” on page 14.)

Front Panel

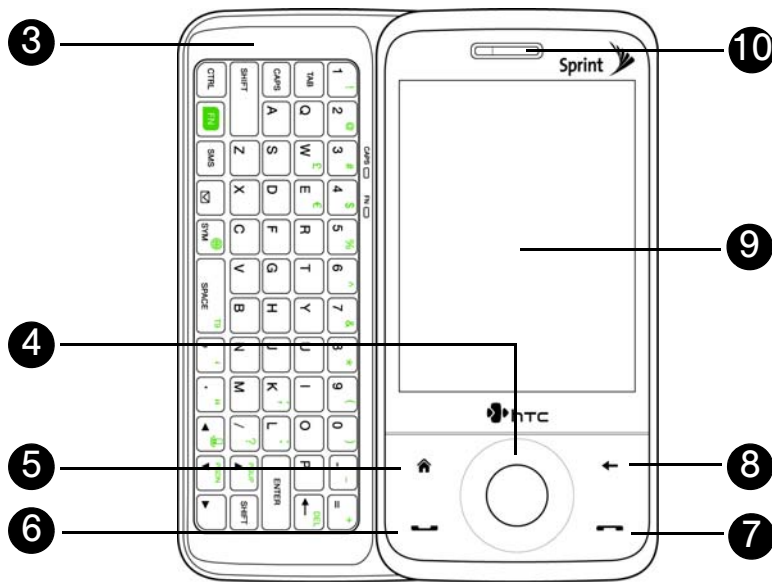

3. **Sliding QWERTY Keyboard.** Slide out the QWERTY keyboard and use it to type long messages or documents. (See “Using the Sliding QWERTY Keyboard” on page 56 for details.)
4. **Navigation Control.** Press this multi-directional control up, down, left, or right to move through menus and items, and then carry out the selection by pressing the **Enter** key (center button). In certain programs, you can slide your finger around the Navigation Control to zoom in and out. (See “Navigation Control” on page 18 for details.)
5. **Home Key.** Press to return to the Home screen. (See “The Home Screen” on page 19 for details.)
6. **Talk Key.** Press to answer an incoming call or display the Phone screen to place a call. During a call, press and hold to toggle the speakerphone on and off. (See “Using Phone Features” on page 26 for details.)
7. **End Key.** Press to end a call or return to the Home screen. Press and hold to lock the device. (See “Long Press End Key” in “System Tab” on page 117 for details.)
8. **Back Key.** Press to return to the previous screen.
9. **Touch Screen.** Slide or flick your finger on the screen when using finger gestures to navigate on the screen. Tap the screen with your finger or the stylus to write, draw, or make a selection.
10. **Earpiece.** Listen to a phone call from here.

Note When using the Home, Back, Talk, and End keys and the Navigation Control, please observe the following precautions:

- Make sure to press on the icons of the keys for the best accuracy. When pressing the Navigation Control, make sure to press the outer areas near the **Enter** key for directional control.
- For best results, do not wear gloves.

Left and Right Panels

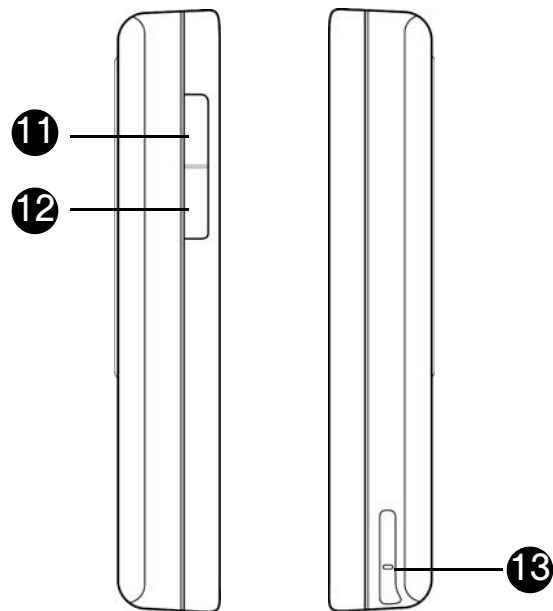

11. **Volume Up Key.** During a call or when playing music, press this button to increase the volume.
12. **Volume Down Key.** During a call or when playing music, press this button to lower the volume.
13. **Stylus.** Use the stylus to write, draw, or select items on the touch screen. (See “Stylus” on page 18 for details.)

Bottom Panel

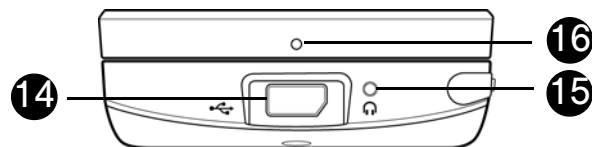

14. **Sync Connector/Earphone Jack.** Connect the supplied USB cable to synchronize information or plug in the AC phone charger to recharge the battery. You can also connect the supplied USB stereo headset.
15. **Reset Button.** Use the stylus to press the Reset button to perform a soft reset on the device.
16. **Microphone.** Speak into the microphone during phone conversations, when recording a voice note, or when giving a voice command.

Back Panel

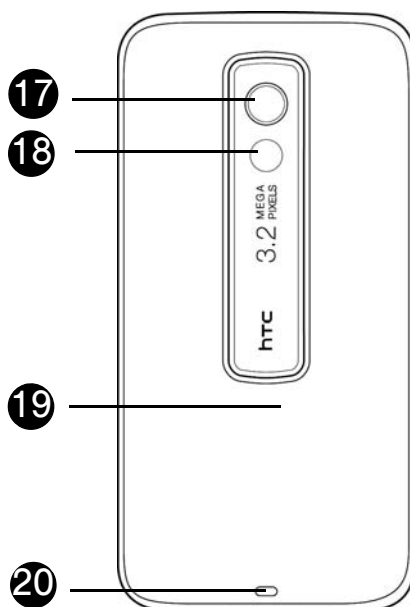

17. **3.2 Megapixel Camera.** Use the camera to take photos and capture video clips. (See “Taking Photos and Videos” on page 94 for details.)
18. **Camera Light.** Turn on to provide additional light when taking photos. (See “Taking Photos and Videos” on page 94 for details.) You can also use the camera light as a flashlight.
19. **Back Cover.** Push the back cover upward to remove it.
20. **Strap Holder.** Connect a strap or lanyard to easily carry your device. See “Using the Strap Holder” on page 128 for details.

Accessories

The product package includes the following items and accessories:

- AC phone charger
- USB sync cable
- Mini-USB stereo headset
- 1 GB microSD card
- Battery
- Multifunction audio cable
- Pouch
- Extra stylus
- LCD screen protector
- Getting Started CD
- Get Started Poster, Basics Guide, Set Up Your Email Guide, and Experience SprintSpeed Brochure

Features of Your Device

The HTC Touch Pro™ is powerful, easy to use, and reliable, and it offers many features and service options. This list previews some of those features and provides page numbers where you can find out more:

- Digital dual-band capability allows you to make and receive calls while on the Sprint National Network and to roam on other 1900 and 800 MHz digital networks where Sprint has implemented roaming agreements (page 33).
- Access the Internet using Wi-Fi (page 137) or your Sprint connection (page 140) from your device. Additional charges may apply.
- SMS Text Messaging (page 133) and Email Messaging (page 162) provide quick and convenient messaging capabilities.
- The sliding QWERTY keyboard, onscreen full QWERTY, compact QWERTY, and phone keypads let you quickly type messages (page 54).
- Automatic Speech Recognition (ASR) lets you dial phone numbers by speaking a name or a phone number (page 78).
- Speed dial lets you dial phone numbers and launch programs with one or two keypresses (page 33).
- The revolutionary TouchFLO 3D™ allows you to use finger gestures to browse the Web, flick through contacts, photos and videos, and more (page 37).
- Your Contacts list allows you to store up to five phone numbers per contact (page 69), and TouchFLO 3D lets you add favorite contacts to the Home screen for quick access (page 40).
- The built-in Calendar offers several personal information management features to help you manage your busy lifestyle (page 71).
- The Location setting works in connection with available location-based services (page 121).
- Bluetooth® allows you to connect and use Bluetooth-enabled devices, such as Bluetooth stereo headsets and printers (page 89).
- The built-in 3.2 megapixel camera and flash light allows you to take high-resolution photos and capture video clips (page 94).

Turning Your Device On and Off

Turning the Power On

- ▶ Press and hold the **Power** key located at the top of your device.

Turning the Power Off

1. Press and hold the **Power** key for about five seconds.
2. Tap **Yes** when a message prompts you to choose whether to turn off the device completely.

Switching to Sleep Mode When Not In Use

Press and immediately release the **Power** key to turn off the display temporarily and switch your device to **Sleep mode**. Sleep mode suspends your device to a low power state while the display is off in order to save battery power.

Your device automatically goes into sleep mode when you leave the device idle after a certain period of time. You will still be able to receive messages and calls while your device is in sleep mode. Pulling the stylus out of its compartment, pressing the **Power** key again, or incoming calls or messages will wake up your device.

Using Your Device's Battery and Charger

Your device is equipped with a Lithium Ion (Li-Ion) battery. It allows you to recharge your battery before it is fully drained. The battery provides up to 4.2 hours of continuous digital talk time.

- Note**
- Long backlight settings, searching for service, vibrate mode, browser use, and other variables may reduce the battery's talk and standby times.
 - Watch your device's battery level indicator and charge the battery before it runs out of power.

If you need to purchase extra batteries for your device, Sprint-approved or HTC-approved batteries and accessories can be found at Sprint Stores or through HTC; or call **1-866-343-1114** to order. They're also available at www.sprint.com.

WARNING Use only Sprint-approved or HTC-approved batteries and chargers with your device. The failure to use a Sprint-approved or HTC-approved battery and charger may increase the risk that your device will overheat, catch fire, or explode, resulting in serious bodily injury, death, or property damage.

To reduce risk of fire or burns:

- Do not attempt to open, disassemble, or service the battery pack.
- Do not crush, puncture, short external contacts, or dispose of in fire or water.
- Do not expose to temperatures above 60°C (140°F).
- Replace only with the battery pack designated for this product.
- Recycle or dispose of used battery as stipulated by local regulations.

Installing and Removing the Battery

Always turn off your device before installing or replacing the battery. You also need to remove the back cover before you can install these components.

To install the battery:

- ▶ See "Setting Up Your Smart Device" on page 2.

To remove the battery:

1. Make sure your device is turned off.
2. Remove the back cover.
3. The bottom right side of the battery has a protruding grip. Lift the protruding grip to remove the battery.

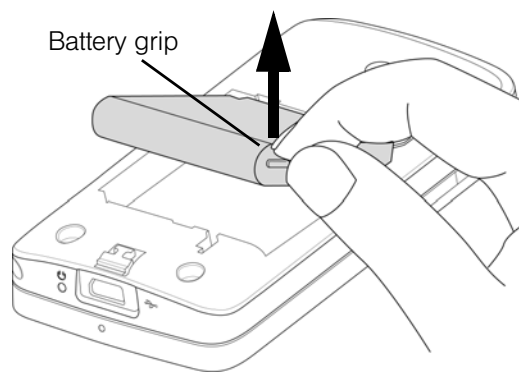

Charging the Battery

Charge your battery as soon as possible so you can begin using your device.

Keeping track of your battery's charge is important. If your battery level becomes too low, your device automatically turns off, and you will lose any information you were just working on. For a quick check of your battery level, glance at the battery charge indicator located in the upper-right corner of your device's display screen. If the battery charge is critically low, the battery icon () will be shown in the title bar.

Always use a Sprint-approved or HTC-approved desktop charger, travel charger, or vehicle power adapter to charge your battery.

To charge the battery:

1. Connect the USB connector of the phone charger to the sync connector on your device.
2. Plug in the phone charger to an electrical outlet to start charging the battery.

Charging is indicated by a “breathing” white light around the Navigation Control. As the battery is being charged while the power is on, a charging icon () also appears in the title bar of the Home screen.

After the battery has been fully charged, the Navigation Control LED shows a solid white light and a full battery icon () appears in the title bar of the Home screen.

For more information about the Navigation Control LED, see “LED Alerts” on page 24.

WARNING

- Do not remove the battery from the device while you are charging it using the phone charger or car adapter.
- As a safety precaution, the battery stops charging when it overheats.

Battery Saving Tips

How long your battery power lasts depends on the battery type and how you use your device. Try the following to help conserve battery life:

- When the device is not in use, press the **Power** key to switch off the display.
- On the Home screen, slide to the **Settings** tab and then tap **All Settings**. On the **System** tab, tap **Power > Advanced** tab of the Power settings screen. Here, you can specify the time before your device automatically turns off the display and backlight to conserve battery power. For optimum conservation, specify three minutes or less.
- On the Home screen, slide to the **Settings** tab and then tap **All Settings**. On the **System** tab, tap **Power > Backlight** tab to adjust the backlight brightness settings.
- Use the AC phone charger to plug your device into an external power outlet whenever possible, especially when using a modem or other peripherals.
- Turn Bluetooth off when you are not using it. Make your device visible to other devices only when you are trying to establish a Bluetooth partnership. For more information about Bluetooth, see “Using Bluetooth” on page 89.
- Lower the volume.
- Close battery-intensive programs such as the camera when you are done using them. Make sure the programs are ended and are not continuously running in the background. See “Using Task Manager” on page 122 for information on closing programs.

Navigating On Your Device

There are different ways you can navigate and interact with the interface of your device:

- Finger-touch control
- Stylus
- Navigation Control

Finger-touch Control

A quick and easy way to interact with the home screen and the whole interface of your device is by touch. Use the following actions, or finger gestures, to navigate with your device:

Touch or tap

When selecting items on the screen, such as the Home screen tabs, Start menu, programs and settings icons, and large onscreen buttons, simply touch them with your finger. Apply some pressure with your finger pad when touching an item on the screen.

“Tapping” is touching the screen lightly and quickly with your finger pad or fingertip. On screens that display smaller-size items, you can more accurately select an item by tapping it with your fingertip.

Swipe

“Swiping” is dragging your finger vertically or horizontally across the screen. The following are some instances when you would use swiping:

- **Flipping on the Home screen**

Swipe your finger vertically to flip through favorite contacts, messages, music albums, photos, and more. For more information, see “Using the TouchFLO 3D Home Screen” on page 37.

- **Scrolling**

When browsing the contacts list, Web pages, documents, and certain selection lists on the Home screen (such as the **All Programs** list), slowly swipe your finger vertically across the screen to scroll. This allows you to scroll by page and to view the content or available selections as you scroll.

People usually move their eyes and not a document when reading. For detailed instructions, see “Finger-scrolling” on page 52.

Slide

Sliding on the touch screen also involves dragging with your finger, but you need to press and hold your finger with some pressure before you start to drag. While dragging, do not release your finger until you have reached the target position.

The following are some instances when you would use sliding:

- **Switching between Home screen tabs**

Slide your finger left and right to switch between the Home screen tabs. For more information, see “Switching Between Tabs on the Home Screen” on page 38.

- **Advancing playback**

In players that have a progress bar, such as the Home screen’s **Sprint Music** tab and Windows Media® Player Mobile, slide your finger horizontally on their progress bar to advance forward or move backward in the music or video you are playing. For more information about the Home screen’s Sprint Music tab, see “Sprint Music” on page 44. For more information about Windows Media Player Mobile, see “Using Windows Media Player Mobile” on page 109.

Flick

Flicking the screen is similar to swiping, except that you need to swipe your finger in light, quicker strokes. This finger gesture is always in a vertical direction, such as when flicking the contacts list. See “Finger-scrolling” on page 52 for details.

Finger-zooming and finger-panning

In programs such as Album and Opera Mobile (page 143), you can use finger gestures when zooming and panning.

Stylus

You can use the stylus to navigate and interact with the touch screen. To use the stylus, pull it out from the stylus compartment at the bottom of the right panel of your device. If the backlight is off, removing the stylus automatically turns the backlight back on.

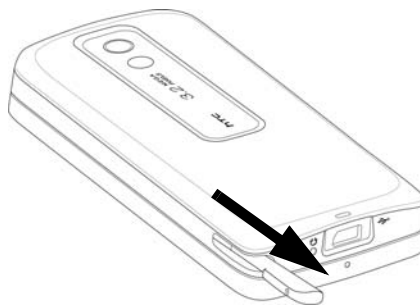

The stylus is magnetic and sticks to the side when held close to the device. This prevents you from accidentally losing or misplacing the stylus.

Basically, you tap with the stylus to open programs and select items on the screen, and you tap and hold on the screen to open a shortcut menu. You can also use the stylus the same way as what you do with finger gestures, such as swiping, sliding and flicking on the screen.

Navigation Control

On the Home screen and in many programs on your device, you can use the Navigation Control for directional control. Press the directional arrows to navigate up, down, left, and right on the screen. When an item has been selected on the screen, press the **Enter** key (the center button) to confirm your selection.

The Navigation Control is also touch sensitive and can be used for zooming. Slide your finger clockwise around the Navigation Control to zoom in, counterclockwise to zoom out.

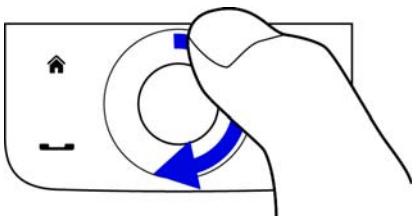

Sliding your finger clockwise

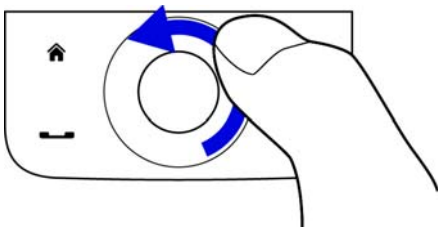

Sliding your finger counterclockwise

The following programs allow you to use the Navigation Control for zooming:

- Album (page 103)
- Camera (page 94)
- Opera Mobile (page 143)
- Word Mobile and Excel Mobile (page 77)

The Home Screen

The default Home screen of your device is the TouchFLO™ 3D Home screen which allows finger-touch access to the most important functions such as contacts, text messages, email, Internet, and more.



1. Start menu (page 22)
2. TouchFLO 3D Home screen (page 37)
3. Display the Phone screen (page 26)
4. Go to the **Programs** tab to access favorite programs (page 51)
5. Quick menu (page 23)
6. Status icons (page 20)

Status Icons

When you touch or tap the icon area of the title bar, the System Status screen opens and displays larger status icons so you can touch them with your finger more easily and accurately.



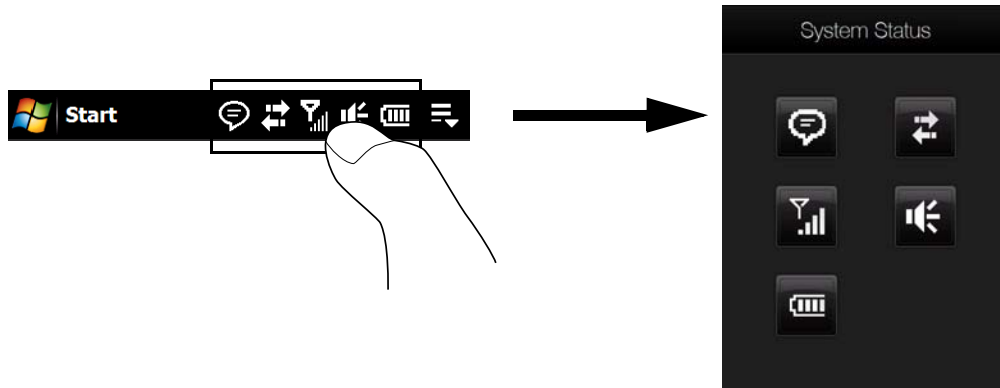



Tip The System Status screen can be disabled. To disable this screen, tap **Start > Settings > System tab > TouchFLO**, and then clear the **Show System Status screen when status icons are tapped** check box.













The following are some of the status icons that you may see on the device.





1		Multiple notifications; tap the icon to view all
		New email messages
		New SMS text messages
		New voicemail notification
		New instant message from Live Messenger
		Missed call
		Speakerphone on
		Roaming
		Alarm
		Other wireless network(s) detected
		Wired headset connected
		Bluetooth on
		Bluetooth visible mode on
		Bluetooth stereo headset connected

2	 1x	1xRTT available
	 Ev	EVDO available
		Connected to a wireless network
		Connection is active
		Connection is not active
		Synchronization in progress

3		Data connection is active but idle
		Data connection is active and transmitting data
		Maximum signal strength
		No signal
		Phone is turned off
		No phone service
		Searching for phone service
		Voice call in progress

4		Vibrate mode
		Sound on
		Sound off

5		Battery charging
		Battery fully charged
		Battery charge level very low

Start Menu

The Start menu, which can be opened from the top left corner of the screen, gives you access to all the programs and settings of your Windows Mobile-powered device.

Touch or tap to select an item on the Start menu.



1. Open the Start menu.
2. Open a recently used program.
3. Touch or tap to return to the TouchFLO 3D Home screen from another screen.
4. Open a program from the Start menu.
5. Access all programs.
6. View and change settings.
7. View Help information for the current screen.

By default, the Start menu is large to make it easier for you to touch menu items with your finger when selecting them from the Start menu. The Start menu can be made smaller, if preferred. Tap **Start > Settings > System** tab > **TouchFLO** and then clear the **Enable large Start menu** check box to display a smaller Start menu.

Quick Menu

The Quick menu, which can be opened from the top right corner of the screen, shows the currently running programs. You can quickly switch between running programs, stop programs, and see how much program memory is being used.



1. Allows you to switch to a running program by touching the program name.
Allows you to stop a running program by touching .
2. Opens the Quick Menu.
3. Shows the total percentage of program memory in use. Touch to open the Memory settings screen.
4. Allows you to customize Task Manager settings. See "Using Task Manager" on page 122 for details.
5. Stops all currently running programs.

LED Alerts

The buttons below the touch screen and the exterior edge of the Navigation Control which is an LED ring will light up in the following situations:

Control	Light Behavior
Talk Key	Light flashes when there is an incoming call.
End Key	Light stays solid when there is an incoming call.
Navigation Control	<ul style="list-style-type: none">● The LED ring shows a “breathing” white light when the battery is being charged.● The LED ring shows a solid white light when the battery is fully charged.● The LED ring flashes a white light once when the battery level is low and reaches down to about 10%.● The top and bottom parts of the LED ring flashes a white light twice when there is a new email message, voicemail, or meeting reminder.● A white light goes around the LED ring counterclockwise twice starting from the top when there is a missed call or new SMS text message.

The LED ring and the **Home**, **Back**, **Talk**, and **End** keys will flash a white light once when one of the buttons or the Navigation Control is pressed.

Adjusting the Volume

Adjusting the system volume changes the volume level of sound notifications and audio and video playback, whereas adjusting the ring volume affects only the volume of the phone ring. The system volume and ring volume can be separately adjusted.

1. Touch the icon area in the title bar and then touch the **Speaker** icon () on the System Status screen.
2. To switch between system volume and ring volume, touch the **System** and **Ring** tabs on top of the screen.
3. On either tab, you can do the following:
 - To increase or decrease the volume level, drag your finger up or down the volume bars. You can also press the Volume Up or Down keys on the left panel of your device.

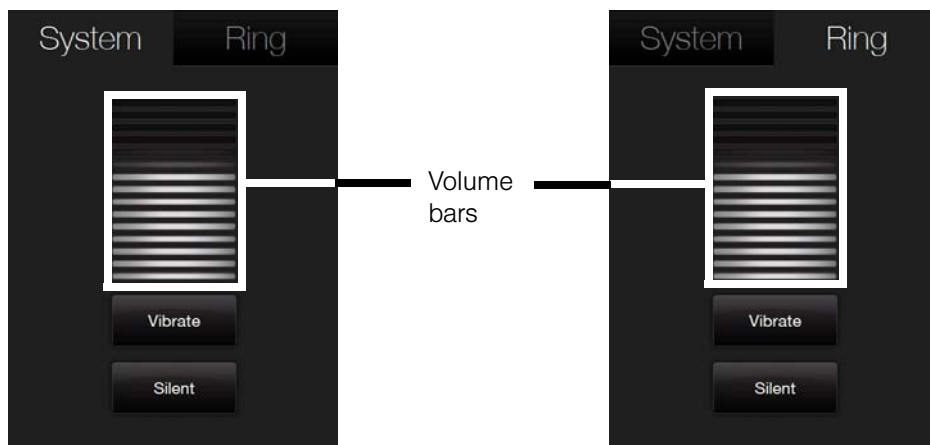

— or —

- Touch **Vibrate** to enable or disable Vibrate mode.
- or —
- Touch **Silent** to mute both the system and ring volume.

The Volume screen automatically closes. You can also manually close the screen by touching the screen.

Note On certain screens that do not show the volume status icon on the title bar, you need to use the Volume Up or Down keys on the left panel of your device to adjust the volume. Also use these buttons to adjust the conversation phone volume during an ongoing call.

Using the Getting Started Application

The **Getting Started** application is a list of “how to’s” that you can use to learn basic features and settings of your device.

To learn the basics through the Getting Started application:

1. Tap **Start > Programs > Getting Started**.
2. Tap one of the items onscreen to learn how to do a certain task.
3. Most tutorials contain a link to the screen where you actually perform a selected task. Tap the link to go to that screen.

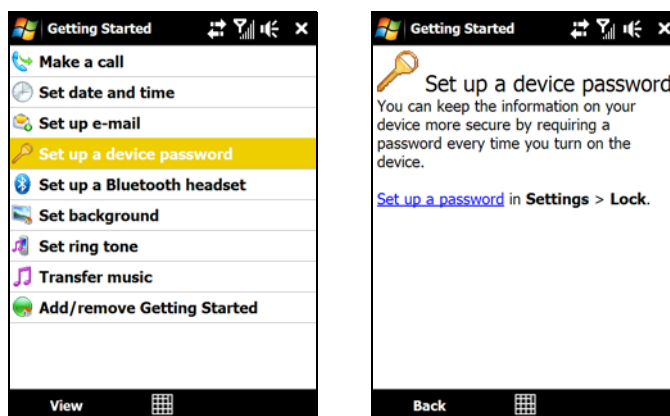

Section 2B

Using Phone Features

- ◆ *The Phone Screen (page 26)*
- ◆ *Displaying Your Phone Number (page 27)*
- ◆ *Making a Call (page 27)*
- ◆ *Answering a Call (page 29)*
- ◆ *Ending a Call (page 31)*
- ◆ *Call History (page 31)*
- ◆ *Speed Dial (page 33)*
- ◆ *Voice and Data Roaming (page 33)*

The same as with a standard mobile phone, you can use your device to make, receive, keep track of calls, and send text messages. This section will show you how to use the phone features of your device.

The Phone Screen

To display the Phone screen:

- On the TouchFLO 3D Home tab, tap **Phone**. For more information about the TouchFLO 3D Home tab, see “Home” on page 39.
 - or —
- Press the **Talk** key.

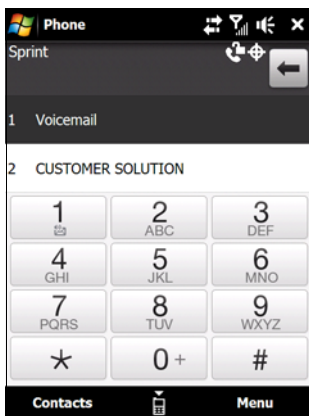
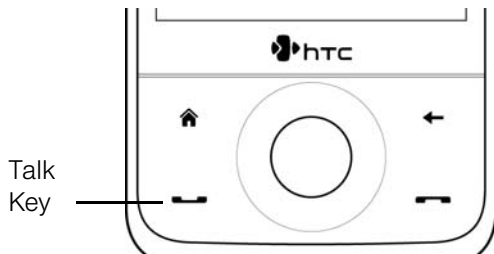

Phone screen

Displaying Your Phone Number

1. Press the **Talk** key to display the Phone screen.
2. Tap **Menu > My Phone Number**. (Your phone number and account information will be displayed.)

Tip To view information about your device, tap **Menu > Device Information** on the Phone screen.

Making a Call

Placing a call from your device is as easy as making a call from any landline phone. You can dial a phone number or select a contact who you want to call.

Making a Call from the Phone Screen

The Phone program's **Smart Dial** feature makes it easy for you to call a phone number or contact. When you start entering a phone number or contact name, Smart Dial automatically searches and sorts the contact entries in Contacts and the phone numbers in Call History (including incoming, outgoing, and missed calls). You can then select the desired number or contact to call from the filtered list.

You can enter the first letter of the name or number of a contact. Smart Dial will search for contact phone numbers and the first character of a contact name as well as from the character that appears after a space, dash, or underscore in a contact name. For example, if you tap **2**, which is associated with [a, b, and c] on the Phone keypad, contact names such as “Ben Miller,” “George Adams,” “John-Carter,” “Carter, Ellen,” “Dixon, Allan,” “Thomas_Clark,” “JaneCampbell” would appear as matches.

If the matching list is long and you want to narrow down the search further, enter another letter. Using the same example above, if you continue to tap “3” which is associated with [d, e, f], the matching list will be narrowed down to the following names: “Ben Miller,” “George Adams,” “Carter, Ellen,” “Dixon, Allan.”

To call a phone number or contact:

1. Press the **Talk** key to display the Phone screen.
2. Begin entering the first few numbers or characters by tapping the keys on the Phone keypad. As you enter numbers or letters, the Smart Dial panel will display matches found.

If you tapped a wrong number or character, tap  to erase each subsequent digit or character. To erase the entire entry, tap and hold .

3. In the Smart Dial panel, flick through the list, slide your finger up or down to scroll the list slowly, or press Navigation Control up or down.

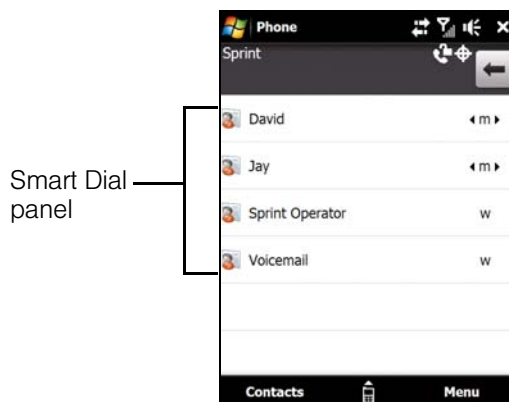

4. To call a number or contact, either:

- Tap the desired phone number or contact from the list.

— or —

- Call a different phone number associated with the displayed contact by pressing the Navigation Control up or down to select the contact, and then press the Navigation Control right or left to select the number to call.

5. Press the **Talk** key to place the call.

Tip

- When in a call, use the **Volume Up** or **Volume Down** keys on the side of the device to adjust the phone volume.
- Tap  to close the Phone keypad to see if there are more matching numbers or contacts.
- To send a text message to a selected contact, tap **Menu > Send Text Message**. For more information about sending text messages, see “Using SMS Text Messaging” on page 133.

Note

After tapping six keys and the number you are dialing is not in your contacts, a **Save to Contacts?** button will appear above the Phone keypad. Tap it to save the number to your Contacts.

Making a Call from Contacts

1. Tap **Start > Contacts** to open the Contacts screen.

2. Select the contact to call and then press the **Talk** key.

Note

If the contact has more than one number stored, press the Navigation Control right or left to select the number you want to call before pressing the **Talk** key.

— or —

Tap the contact to open the contact details, and then tap the phone number you want to call.

— or —

Tap and hold the contact you want to call, and then from the menu, select **Call Work**, **Call Home**, or **Call Mobile**.

Making a Call from the TouchFLO 3D Home screen

- ▶ To learn how to choose a favorite a contact and make a call from the TouchFLO 3D Home screen, see “Choosing from Your Favorite Contacts” on page 40.

Making an International Call

1. Tap and hold  on the Phone screen until the plus (+) sign appears. The plus (+) sign replaces the international prefix of the country that you are calling.

2. Enter the full phone number you want to dial, and press the **Talk** key on your device. The full phone number includes the country code, area code (without the leading zero, if any), and phone number.

Setting the Device to Vibrate When a Call is Established

You can set the device to vibrate once to alert you that the call has been established with the other party.

1. On the Phone screen, tap **Menu > Options... > Advanced tab**.

2. Select the **Vibrate device when connection is established** check box and then tap **ok**.

Calling Voicemail

- ▶ **1** is reserved for your voicemail. Tap and hold **1** on the Phone keypad to call voicemail and retrieve your voicemail messages. For more information about using voicemail, see “Using Voicemail” on page 130.

Answering a Call

Your device notifies you of incoming calls in the following ways:

- The device rings or vibrates.
- The **Talk** key flashes a white light.
- The LED ring around the Navigation Control flashes a white light.
- The backlight illuminates.
- The screen displays an incoming call message. If the incoming call is from a number stored in your Contacts, the caller’s name is displayed. The caller’s phone number and picture may also be displayed, if available.

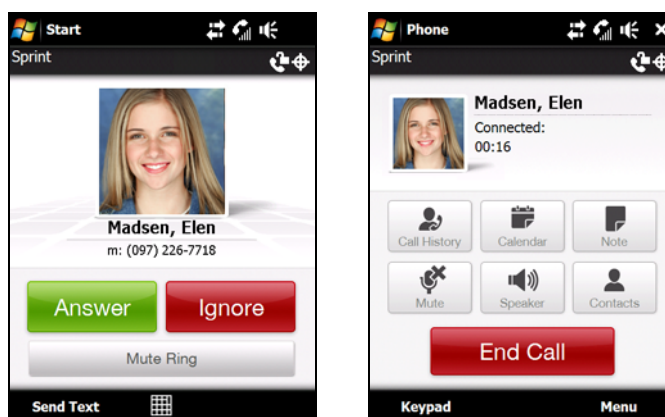

Accepting an Incoming Call

To answer the call:

- ▶ Tap **Answer** or press the **Talk** key.

To mute the ringing sound without rejecting the call:

- ▶ Tap **Mute Ring** when you receive an incoming call.
 - or —
 - Place your device face down.

Rejecting an Incoming Call

To reject the call:

- ▶ Tap *Ignore* or press the **End** key.

To reject a call and send a text message:

When you reject a call, you can choose to automatically send a text message to the caller.

1. On the Phone screen, tap *Menu > Options... > Advanced* tab.
2. Select the *Reject call with text message* check box.
3. Change the default text message if needed, and then tap *ok*.

When *Reject call with text message* is enabled, tap *Send Text* to reject the call and send the text message to the caller.

In-Call Options

To put a call on hold:



Your device notifies you when you have another incoming call, and gives you the option of rejecting or accepting the call. If you are already on a call and accept the new call, you can choose to switch between the two callers, or set up a conference call between all three parties. For instructions on how to start a conference call, see “Making a Three-Way Call” on page 136.

1. Tap *Answer* to take the second call, and put the first one on hold.
2. To end the second call and return to the first call, tap *End Call* or press the **End** key on your device.

To switch between two calls:

- ▶ Press the **Talk** key.



To turn on and off the Speakerphone:

- ▶ During a call, tap  to turn the speakerphone on or off. The speakerphone icon () appears in the title bar when the speakerphone is on.

Tip You can also press and hold the **Talk** key to turn the speakerphone on or off.

WARNING To avoid damage to your hearing, do not hold your device against your ear when the speakerphone is turned on.

To mute the microphone during a call:

- ▶ Tap  to turn the microphone on or off. When the microphone is turned off, the mute icon () appears on the screen.

To open Notes while in a call:

- ▶ Tap  or pull out the stylus.

Ending a Call

When a call is in progress, tap **End Call** or press the **End** key to hang up.

To add a new phone number to Contacts after a call:

If the phone number of the person who called is not in Contacts, you can choose to save the number after you hang up.

1. On the Phone screen, tap **Menu > Options... > Advanced** tab.
2. Select the **Add new phone number to Contacts at end of call** check box, and then tap **ok**.

When you enable this option, a pop-up message appears after you end the phone call and lets you add the phone number to Contacts.

Checking Missed Calls

Missed Call Notification

There are several ways your device alerts you when you have missed calls:

- The missed call icon () is displayed in the title bar.
- The number of missed calls is shown on the TouchFLO 3D Home tab.
- White light circles counterclockwise around the LED ring of the Navigation Control twice.

To check who the caller was:

- ▶ Tap the title bar and tap , and then tap **View**.

— or —

On the TouchFLO 3D Home tab, tap the **Call History** or **Missed Call** item. (For more information about the TouchFLO 3D Home tab, see “Home” on page 39.)



— or —

On the Phone screen, tap **Menu > Call History**.

Call History

Call History shows you your incoming calls, outgoing calls, and missed calls. Call History makes redialing a number fast and easy. It is continually updated as new numbers are added to the beginning of the list and the oldest entries are removed from the bottom of the list.

Each entry contains the phone number (if it is available) and Contacts entry name (if the phone number is in your Contacts). An icon appears to the left of the number, and it indicates the type of call:

	Missed. These are incoming calls that you were not able to answer, and they are routed to your voicemail.
	Received. These are incoming calls that were answered.
	Dialed. These are outgoing calls that you made.

Note Call History records only those calls that occur while the device is turned on. If a call is received while your device is turned off, it will not be added to the Call History.

Filtering Calls in Call History

If you have a long list of calls in the Call History, you can tap one of the buttons at the bottom of the screen to filter the list according to the type of call:

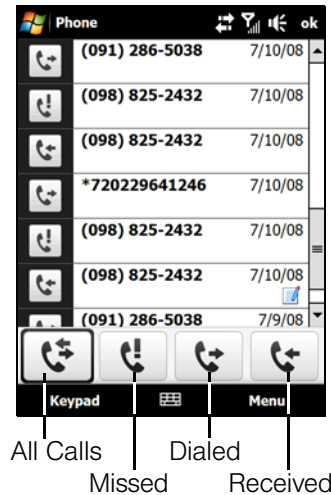

Making a Call from Call History

1. Press the Navigation Control up or down to select the number or contact name in the Call History that you want to call.
2. Press the **Talk** key to place the call.

Call History Options

- Tap an entry in the Call History to display details about a call, such as the date and time of the call, the phone number (if available), and the caller's name (if the number is already in your Contacts).
- After selecting a call entry, you can also tap **Menu** to choose what you want to do with the selected call:
 - **Save to Contacts** to save the phone number to your Contacts.
 - **View Note** to open the Notes program and view the information that you have entered about the call. This option is available only when there is a **Note** icon () that appears with the call entry.
 - **Delete** to remove the call entry from the Call History.
 - **Send Text Message** to create and send an SMS text message to the caller. (For more information about sending text messages, see "Using SMS Text Messaging" on page 133.)
 - **Filter** to restrict the list of entries that appear in the Call History according to the type of call.
 - **Delete All Calls** to erase all history entries.

Speed Dial

Use **Speed Dial** to call frequently-used numbers with a single tap. For example, if you assign a contact to the location 2 in Speed Dial, you can tap and hold  on the Phone keypad to dial the contact's number.

To create a Speed Dial entry:

1. On the Phone screen, tap **Menu > Speed Dial**.
2. Tap **Menu > New**.
3. Tap a contact, and then select the phone number of the contact that you want assigned to the speed dial key.
4. In **Location**, select an available key to use as the speed dial key.
5. Tap **ok**.

Note When you assign a new phone number in an occupied speed dial key, the new phone number will replace the existing one.

Tip To delete a speed dial entry, in the **Speed Dial** list, tap and hold the desired entry, and then tap **Delete**.

Voice and Data Roaming

Roaming is the ability to make and receive calls, send and receive text messages, or use data services when you are off the Sprint National Network. Your new HTC Touch Pro™ smart device works anywhere on the Sprint National Network and allows you to roam on other 1900 and 800 MHz digital networks where Sprint has implemented roaming agreements.

Your device allows both voice and data roaming if these services are included in your service plan. Contact Sprint to find out about roaming services and rates.

Understanding Roaming

Recognizing the Roaming Icon on the Display Screen

Your device's display screen always lets you know when you are off the Sprint National Network. Anytime you are roaming, the device displays the roaming icon () in the title bar.

Tip Remember, when you are using your device off the Sprint National Network, always dial numbers using 11 digits (1 + area code + number).

Roaming on Other Digital Networks

When you are roaming on digital networks, your call quality and security will be similar to the quality you receive when making calls on the Sprint National Network. However, you may not be able to access certain features, such as data services, depending on the available network.

Note If you're on a call when you leave the Sprint National Network, your call is dropped. If your call is dropped in an area where you think Sprint service is available, turn your device off and on again to reconnect to the network.

Checking for Voicemail Messages While Roaming

When you are roaming off the Sprint National Network, you may not receive on-device notification of new voicemail messages. Callers can still leave messages, but you will need to periodically check your voicemail for new messages if you are in a roaming service area for an extended period of time.

1. Press the **Talk** key to display the Phone screen.
2. Enter **1**, the area code, and then your phone number.
3. Press the **Talk** key again to call your voicemail.
4. When you hear your voicemail greeting, tap on the Phone keypad.
5. Enter your passcode at the prompt and follow the voice prompts.

When you return to the Sprint National Network, voicemail notification will resume as normal.

Setting Roaming Options for Your Device

You can set roaming options for your device to better control your roaming costs.

1. On the Phone screen, tap **Menu > Options... > Services** tab.
— or —
Tap **Start > Settings > Personal** tab **> Phone > Services** tab.
2. Select **Roaming**, and then tap **Get Settings**. The Phone: Roaming screen then appears where you can set options such as the roaming mode as well as Call Guard notification and Data Roam Guard notifications.

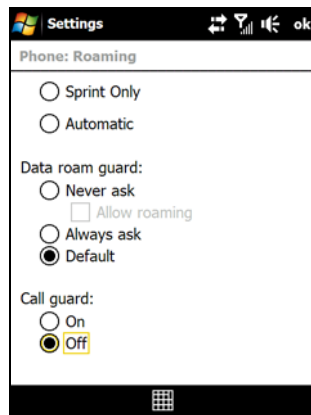

Choosing a Roaming Mode

On the Phone: Roaming screen, you can enable or disable roaming by choosing one of the following modes:

- **Sprint Only** to access the Nationwide Sprint PCS Network only and prevent roaming on other networks.
- **Automatic** to seek service on the Sprint National Network. When Sprint service is unavailable, your device searches for an alternate system.

Using Call Guard

Your device has two ways of alerting you when you are roaming off the Sprint National Network: the onscreen roaming icon and Call Guard. Call Guard makes it easy to manage your roaming by requiring an extra step before you can place or answer a roaming call. (This additional step is not required when you make or receive calls while on the Sprint National Network.)

To turn Call Guard on or off:

- ▶ On the Phone: Roaming screen, select **On** or **Off**.

Note	<ul style="list-style-type: none"> • Call Guard is turned off by default on your phone. • Automatic speed recognition (ASR) and speed dialing are not available when you are roaming with Call Guard enabled.
-------------	---

To place roaming calls with Call Guard on:

1. Press the **Talk** key to display the Phone screen.
2. Enter **1**, the area code, and then the seven-digit number. After entering the number, press the **Talk** key.
3. A pop-up message then appears, informing you that roaming rates will apply. Tap **Dismiss** to close the message, and then tap **1** to place the call.

To answer incoming roaming calls with Call Guard on:

- ▶ When you have an incoming roaming call, the Phone screen appears with a message notifying you that roaming charges may apply. Tap **Answer** if you want to accept the roaming call.

Note	If the Call Guard feature is set to On, you may need to take extra steps to make and receive roaming calls.
-------------	---

Using Data Roam Guard

Depending on service availability and roaming agreements, your device may be able to access data services while roaming on certain digital systems. You can use the **Data Roam Guard** to alert you when you are roaming off the Sprint National Network and try to use data services such as messaging.

To set your Data Roam Guard notification:

On the Phone: Roaming screen:

- Select **Never ask** and the **Allow roaming** check box to always allow data roaming without prior notification.
- Select **Never ask** and then clear the **Allow roaming** check box to always disable data roaming.
- Select **Always ask** to enable the Data Roam Guard to always display a confirmation message and alert whenever your device enters a roaming network.
- Select **Default** to enable data roaming internationally. The Data Roam Guard may display a confirmation message and alert.

To use data services when Data Roam Guard is active:

When a notification message appears informing you that data roam charges may apply:

- Tap **Roam** or **OK** to allow data roaming.
- Tap **Cancel** if you don't want to allow data roaming.

Note	If this is your first time using data roaming, the Data Roam Guard will display a second message, informing you about how to change the notification setting.
-------------	---

Turning the Phone On and Off

In many countries, you are required by law to turn off the phone while on board an aircraft.

Enabling or Disabling the Phone

1. Tap **Start > Settings > Connections tab > Comm Manager**.
2. On the Comm Manager screen, tap the **Phone** button to enable or disable the phone. When enabled, the ON indicator is activated.

Enabling or Disabling Airplane Mode

Another way to turn off the phone function is to switch your device to **Airplane Mode**.

When you enable Airplane Mode, all wireless radios on your device are turned off, including the phone and Bluetooth.

When you disable Airplane Mode, the phone function is turned back on and the previous state of Bluetooth is restored.

1. Tap **Start > Settings > Connections tab > Comm Manager**.
2. On the Comm Manager screen, tap the **Airplane Mode** button to enable or disable Airplane Mode. When enabled, the ON indicator is activated.

TouchFLO 3D

- ◆ Using the TouchFLO 3D Home Screen (page 37)
- ◆ Finger Gestures (page 52)

TouchFLO™ 3D gives you touch control over your Windows Mobile-powered device. TouchFLO 3D provides the following features:

- A Home screen that allows finger-touch access to the most widely used functions, such as People, Messages, Mail, Music, Internet, and more.
- Finger gestures that allow you to navigate screens.

This section will show you how to easily use the TouchFLO 3D Home screen to check SMS text messages and email messages, access the Web browser, check weather, and more. You will also learn how to navigate on your device using finger gestures.

Using the TouchFLO 3D Home Screen

The TouchFLO 3D Home screen has the following tabs:

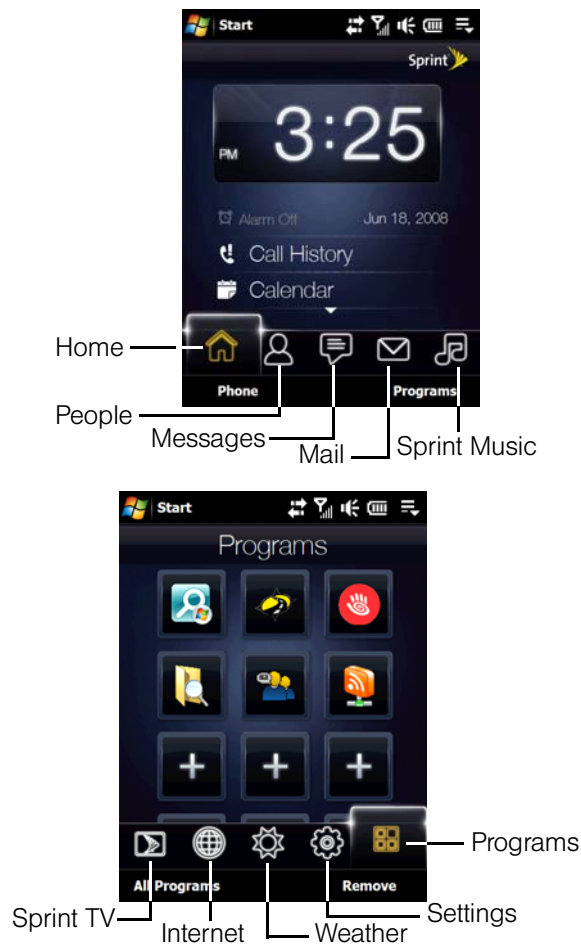

Switching Between Tabs on the Home Screen

- Touch or tap the desired tab on the Home screen.
 - or —
- Press the Navigation Control right or left to move to the next or previous tab.
 - or —
- Press and hold your finger on the active tab, and then slide your finger right or left over the tabs. Release when you have selected the desired tab.

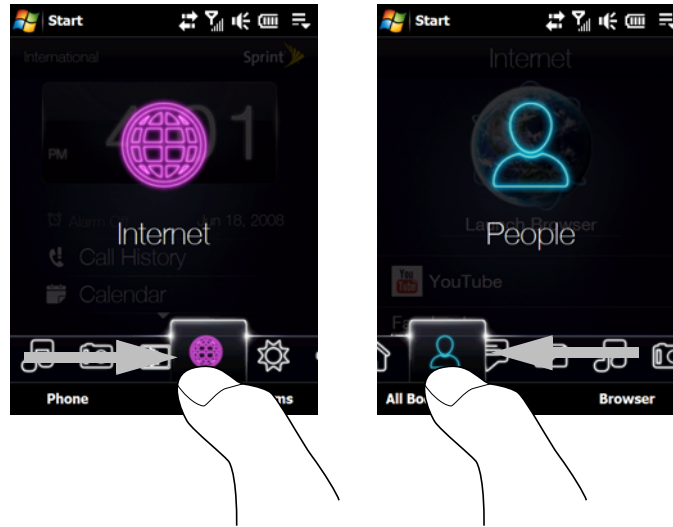

Note Apply some pressure when pressing and holding on the active tab to be able to slide over the tabs.

- or —
- Swipe left across the screen to move to the next tab, and swipe right across the screen to move to the previous tab.

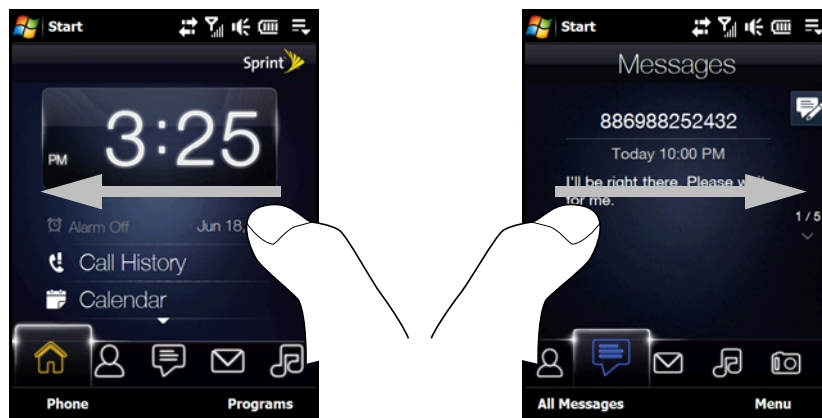

Home

The **Home** tab displays the current date, a digital clock, and an alarm icon that indicates whether the alarm is on or off. Missed calls and your upcoming calendar appointments are also shown on the **Home** tab.

To select an item on the Home tab:

- ▶ Touch the item.

— or —

Press the Navigation Control up or down first to navigate to the item you want to select and then press the Enter button.

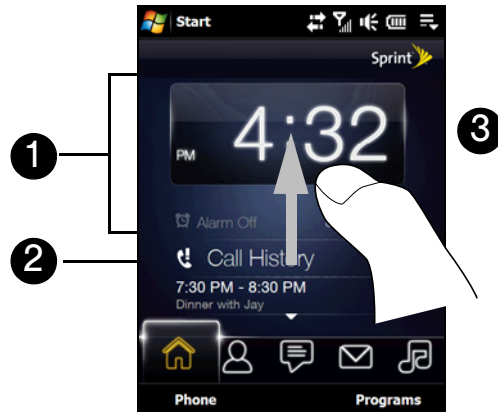

Home tab with large digital clock

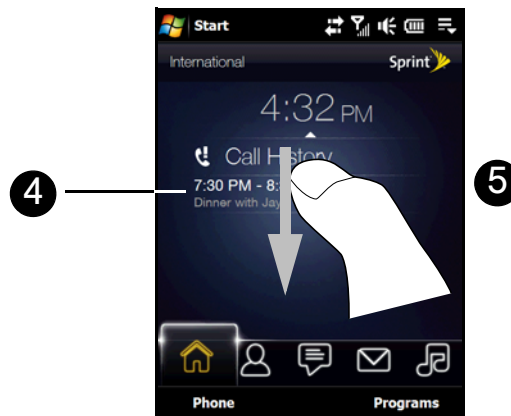

Home tab with small digital clock

1. Touch the date or the large digital clock to open the Clock & Alarms screen where you can set the date, time, and alarm. (See “Changing Basic Settings” on page 119 for details.)
2. Touch this area to view details about missed calls in the Call History. (See “Call History” on page 31 for details.)
3. Swipe upward on the screen to display the small digital clock and view more appointments.
4. One all-day appointment and up to two timed appointments can be displayed. Touch this area to create, edit, or view an appointment. (See “Calendar” on page 71 for details.)
5. Swipe downward on the screen to change back to the large digital clock.

People

On the **People** tab, you can add favorite contacts who you most frequently communicate with. This allows you to quickly make calls, send text messages, and send email messages to your favorite contacts.

Tip You can add up to 15 favorite contacts on the **People** tab.

Adding Favorite Contacts

You should already have created or synchronized contacts on your device before you can add them to the **People** tab.

1. On the Home screen, slide your finger to the **People** tab.
2. Touch the small or big **Plus** icon, or touch **Add Favorite**.

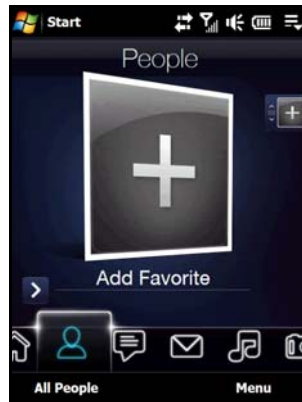

3. On the Select a Contact screen, touch the name of the desired contact.

Tip To create a new contact, touch **Menu > New Contact**. See "Contacts" on page 69 for details.

4. Select a phone number or email address to associate with the favorite contact.

Note If there is no picture associated with the contact, the next screen prompts you to assign a picture to the contact.

5. To add another favorite contact, touch the small **Plus** icon () at the right side of the screen and repeat steps 3 and 4.

Choosing from Your Favorite Contacts

1. Do any of the following:
 - To flip through the contact pictures one at a time, swipe your finger up or down the screen. You can also press the Navigation Control up or down to flip through the contact pictures.

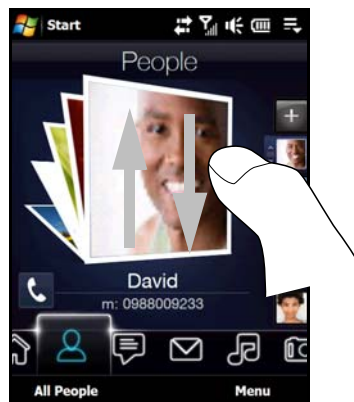

- On the picture strip at the right side of the People screen:
 - Touch the picture of the desired favorite contact.
 - or —
 - Press and hold on the currently selected contact picture to display a slideout bar, and then slide up or down the picture strip. Release your finger when the desired contact is selected.



2. After selecting a favorite contact, touch the icon on the left side of the contact name. The icon shown will depend on the contact information chosen for the contact. For example, a phone icon () will be shown if a phone number is selected and you can tap this icon to call the favorite contact.
3. Touch the picture of the contact on the center screen to access his or her contact card. On the contact card, you will see the last outgoing or incoming call as well as contact details such as phone numbers, email address, and more.

Tip

- On the **People** tab, touch **All People** to access all contacts that are stored on your device.
- To remove the current favorite contact, touch **Menu** > **Remove Favorite**.

Messages

On the **Messages** tab, you can read text messages as they arrive and create a new text message. When there are new incoming text messages, the icon on the **Messages** tab will show the number of new messages. For example,  indicates that there is a new unread message.



1. To view the entire message thread from the sender and reply, touch the message on the screen.
2. Touch **All Messages** to access all text messages in your inbox and other folders.
3. Touch **Menu** to remove the current message and access more options.
4. To flip through received text messages, swipe your finger upward or downward, touch the up or down arrow on the screen, or press the Navigation Control up or down.
5. Touch the **New** icon to create a new text message.

For more information about working with text messages, see “Using SMS Text Messaging” on page 133.

Mail

The **Mail** tab is where you send and receive email messages. Including Outlook Email, you can add up to four POP3/IMAP4 and Web-based email accounts in this tab.

To add an email account:

1. On the Home screen, slide your finger to the **Mail** tab.
2. If this is your first time to add an email account, touch **New Account** on the bottom right side of the screen.
3. Set up your email account using the Email Setup wizard.
4. To add another email account, touch **Menu > Accounts > New Account** and use the Email Setup wizard to set up your account.

For detailed instructions on setting up email accounts using the Email Setup wizard, see “Email Setup Wizard” on page 162.

To check email:

- ▶ When there are new email messages, the icon on the **Mail** tab and the respective icons of the email accounts will show the number of newly received messages.

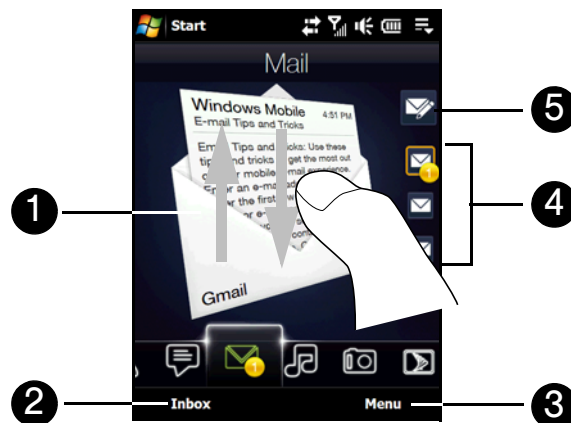

1. To browse through received email messages, swipe up or down on the envelope image or press the Navigation Control up or down.
Touch the email icon on the screen to open and read the message.
2. Touch **Inbox** to access all email messages of the currently selected account.
3. Touch **Menu** to access more options.
4. These are your email accounts. Touch an icon to select an email account and view the new email messages received in that account.
5. After selecting an email account, touch this icon to create and send a new email message.

For more information about working with email, see “Email Messaging” on page 162 and “Working With Company Email and Meeting Appointments” on page 168.

Sprint Music

The **Sprint Music** tab allows you to visually browse through albums and music tracks that are on your device and play music. The albums and music tracks that you see on this tab are from the **Now Playing** list of the Library.

Note Your device searches for all music files that have the following audio formats: MP3 (.mp3), WMA (.wma), AAC/AAC+ (.aac), and MPEG-4 (.m4a). It searches for music from the following locations:
Device: My Music (including all subfolders)
My Documents (including all subfolders)
Storage: \Storage Card (including all subfolders)

From the **Sprint Music** tab, you can also access the Sprint Music Store to purchase and download music. For more information about purchasing and downloading music onto your device, see “Sprint Music Store” on page 177.

Playing Music

- ▶ On the **Sprint Music** tab, flip through albums and all the music in each album, and then touch the **Play** icon (▶) to start playback.

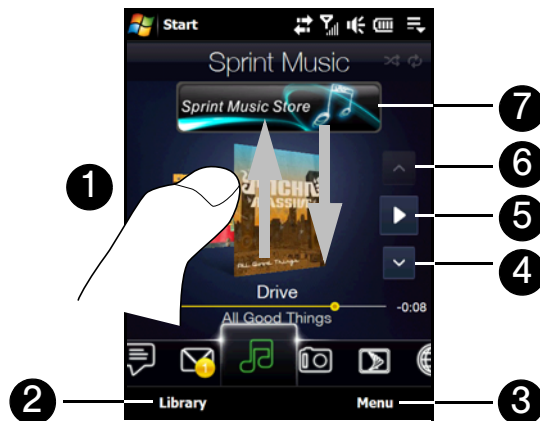

1. Swipe upward or downward on the screen or press the Navigation Control up or down to flip through albums and the music or songs in an album.
2. Touch **Library** to access the Library. See “The Library” on page 45 for details.
3. Touch **Menu** to set music playback to repeat, turn shuffle on or off, and more.
4. Touch the **Down** arrow icon to go to the next album or the next music in the current album.
5. Touch the **Play** icon to play or the **Pause** icon to pause playback. You can also press the **Enter** key to play or pause.
6. Touch the **Up** arrow icon to go to the previous album or the previous music in the current album.
7. Touch **Sprint Music Store** to download music from Sprint Music Store. See “Sprint Music Store” on page 177 for details.

To advance forward or backward in the music:

- Touch and hold on the thin bar below the album art to display the progress bar:



Drag your finger right or left on the progress bar to move forward or backward in the current music.
— or —

- Slide your finger around the Navigation Control as follows:

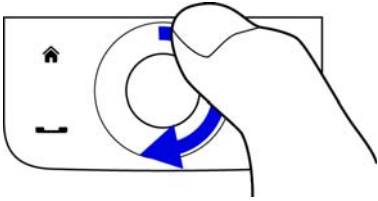

Slide your finger clockwise to advance forward in the music.

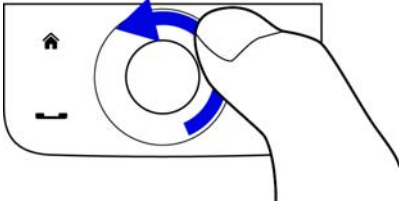

To move backward in the music, slide your finger counterclockwise.

To set repeat and shuffle modes:

The icons on the upper-right side of the **Sprint Music** tab show whether repeat and shuffle modes are enabled.



- Touch **Menu > Repeat** and choose whether to repeat once, repeat all, or do not repeat.
- To toggle shuffle mode on and off, touch **Menu > Shuffle** and then select **Shuffle On** or **Shuffle Off**.

The Library

The Library organizes music into categories, such as **Now Playing**, **Artists**, **Albums**, **Genres**, **All Songs**, and more. When you add more albums or music tracks to your device, go to the Library to locate and play the new albums or music tracks.

To browse and play music in the Library:

1. On the **Music** tab, touch **Library** to open the Library screen.
2. The tabs at the bottom of the Library screen correspond to the different categories. To browse music under a certain category, slide to the tab that corresponds to the desired category.
3. Tap a music track to play it.

Note When you select a category in the Library such as **Artists** and play its music, the **Now Playing** list will be replaced with the music tracks from that category.

Playlists

You can group your favorite music into a playlist and then play back the playlist.

To create a new playlist:

1. Select the desired music on the **Music** tab or the **Library**.
2. Touch **Menu > Add to Playlist**.
3. Touch **<New Playlist>**, enter a **Playlist name**, and then touch **OK**.

To add more music files to a playlist:

1. On the **Playlists** tab, touch a playlist to open it.
2. Touch **Menu > Edit**.
3. Touch **Menu > Add**.
4. Select the check boxes of the music you want to add to the playlist, or touch **Menu > Select All** to choose all the music.
5. Touch **OK** three times and then touch **Up** to return to the **Playlists** tab.

To play back a playlist:

1. On the **Playlists** tab, touch a playlist to open it.
2. Touch the first song in the playlist. The **Music** tab starts playing the first song. After each song, the next one in the playlist will be played.

Note *Playlists are not automatically updated when music files have been deleted from the device memory or the microSD card.*

Types of Playlists

There are two types of playlists that can be shown on the **Playlists** tab:

- **Custom playlists.** Playlists that are created on the **Music** tab.
- **Windows Media Player playlists.** Playlists that are in Windows Media Player Mobile's Library (which is synchronized with Windows Media Player on your computer). They are indicated by the Windows Media Player icon (). These playlists cannot be edited.

Note *If a Windows Media Player playlist contains a combination of music, video and image files, only music files in the playlist will be synchronized to your device and other media types will be filtered out.*

Photos and Videos

The **Photos and Videos** tab lets you flip through your photos and video clips and view them full-screen. From this tab, you can also launch the camera so you can take pictures and record video clips.

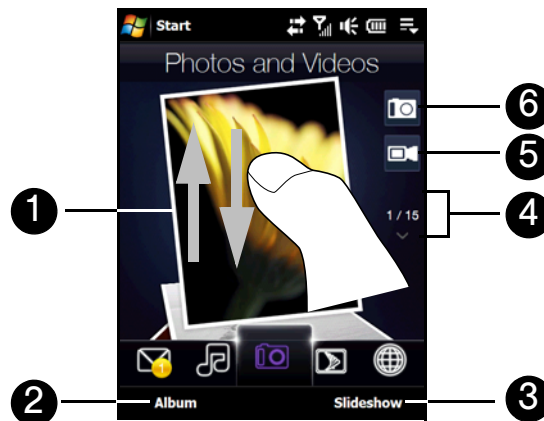

1. Touch the photo or video on the screen to view or play it full-screen.
2. Touch **Album** to open the Album program. See "Viewing Photos and Videos" on page 103 for details.
3. Touch **Slideshow** to view the photos as a slideshow. If a video is selected, touch **Play**.

4. To flip through photos and videos, swipe upward or downward, touch the up or down arrow, or press the Navigation Control up or down.
5. Touch the video camera icon to shoot video.
6. Touch the camera icon to take a photo.

Tips

- For more information about viewing full-screen, see “Viewing an Image” on page 105 and “Playing Back Video” on page 108. The file formats that can be viewed on the **Photos and Videos** tab are the same as the **Album** program.
- To transfer media files from a computer and view them on the **Photos and Videos** tab, copy or synchronize them to a folder under **\My Device** (the device memory) or **\Storage Card**.

Setting an Album as a Favorite

The **Photos and Videos** tab displays pictures and video files from the current favorite album. By default, the Camera Shots album, which stores the pictures and videos that you captured using the device camera, is set as the favorite. You can change to another favorite album, if preferred.

1. On the **Photos and Videos** tab, touch **Album** to open the Album program.
2. Touch **Albums** and then select one of the listed favorite albums.
3. Tap **Menu > Set as Favorite**, and then tap **OK** on the confirmation screen.

Sprint TV

On the **Sprint TV** tab, you can watch live TV and catch up on episodes of your favorite shows – anywhere on the Sprint National Network.

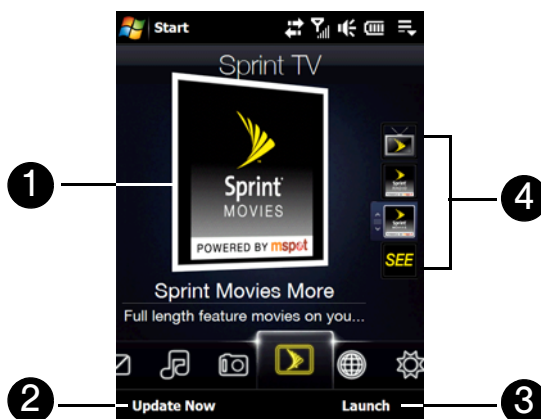

1. Touch the displayed channel on the center of the screen to watch the channel.
2. Touch **Update Now** to download the latest preset channel list from Sprint.
3. Touch **Launch** to open the Sprint TV application so you can connect to Sprint data services, access all available channels, and choose to which channels you want to subscribe.
4. Preset channel selections are listed on the strip at the right side of the screen.

To watch a preset channel:

- ▶ Touch the icon on the right that corresponds to the desired channel.
- or —

Press and hold on the highlighted channel icon to display a slide-out bar, and then slide your finger up or down. Release your finger when you have selected the desired channel.

For more information about using Sprint TV, see “TV” on page 175.

Internet

On the **Internet** tab, you can open Opera Mobile™ to browse the Web and add Web favorites for one-touch access to your favorite Web sites.

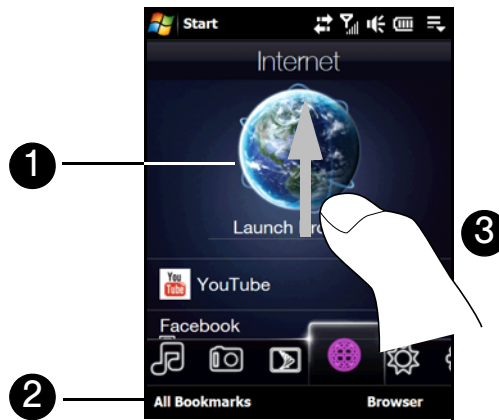

1. Swipe upward or press the Navigation Control down to scroll down the screen and access more Web favorites.
2. Touch **All Bookmarks** to open Opera Mobile and add, view or delete Web favorites.
3. Touch the globe image or touch **Launch Browser** to browse the Web using Opera Mobile.

For more information about using Opera Mobile, see “Navigating the Web” on page 143.

Weather

The **Weather** tab shows you the current weather as well as weather information for the next five days of the week.

Adding a City

The **Weather** tab can display weather information of your local city and other added cities. Follow the steps below to add a city on this tab.

Tip You can add up to 10 cities in the Weather tab.

1. On the **Weather** tab, touch **Menu > Add Location**.
2. The Select Country screen then appears. Flick your finger on the screen or use the Quick Scroll bar on the right of the screen to choose the country. You can also slowly scroll through the country list by dragging your finger upward on the screen. Touch the desired country to select it.
3. The Select City screen then appears. Flick your finger on the screen or use the Quick Scroll bar on the right of the screen to choose the city. You can also slowly scroll through the city list by dragging your finger upward on the screen. Touch the desired city to select it.

Viewing Weather Information

Your device automatically connects to the Internet via the data connection or Wi-Fi to download and display weather information. The current temperature, temperature range, type of weather (sunny, cloudy, showers, or other), and the time of day (daytime or nighttime) are shown on the **Weather** tab. To see the weather information for the next five days of the week, touch **5-day** at the bottom left side of the screen.



1. Touch **5-day** at the bottom left side of the screen to see the weather information for the next five days of the week.
2. Touch **Menu** to add or delete a city, change the temperature to Celsius or Fahrenheit, and more.
3. To switch between cities, swipe your finger upward or downward, touch the up or down arrow on the screen, or press the Navigation Control up or down.
4. Shows the last weather update. Touch this item to download the latest weather information.

Choosing Download Options

1. On the **Weather** tab, touch **Menu > Settings**.

Tip You can also slide to the **Settings** tab and then touch **Data**.

2. You can choose from the following options:
 - **Download weather automatically.** When this option is selected, weather information is automatically downloaded from the AccuWeather Web site whenever you select the **Weather** tab, if the data has not been updated within the last three hours. Weather data is also downloaded every time an ActiveSync connection is established (through over-the-air or USB connections). Clear this option if you prefer to manually download weather information.
 - **Download weather when roaming.** Select this option only if you want to allow automatic download of weather data when roaming. This may incur additional costs.

Settings

The **Settings** tab allows you to synchronize information with your computer or the Exchange Server, change sound settings such as the ring tone, and choose a different wallpaper for the **Home** tab. You can also easily turn the communications features of your device, such as Wi-Fi and Bluetooth, on or off.



1. Touch to connect and synchronize your device with the computer or Exchange Server. (See “Synchronizing Information With Your Computer” on page 63 and “Starting Synchronization” on page 169 for details.)
2. Touch to set the sound profile, ring tone, and more.
3. Touch to change the wallpaper of the Home tab. (See “Changing the Background Image” below.)
4. Touch to open Comm Manager where you can easily turn features such as Wi-Fi and Bluetooth on or off. (See “Comm Manager” on page 75 for details.)
5. Touch to set weather download options. (See “Choosing Download Options” on page 49 for details.)
6. Touch **All Settings** to access all the settings of your device. (See “Settings on Your Device” on page 116 for details.)

Changing the Background Image

You can change the background image of the Home tab by following these steps:

1. Slide your finger to the **Settings** tab of the Home screen, and then tap **Wallpaper**.
2. On the Select a Picture screen, navigate to the folder where the image you want to use is located. When you have found your desired background image, tap the image to select it.
3. Slide your finger to the **Home** tab. You will now see that the background image has changed.

For more information about customizing other types of settings, see “Managing Your Device” on page 115.

Programs

The **Programs** tab allows you to add your favorite programs for one-touch access.



1. Touch an empty slot to add a favorite program.
2. Touch **All Programs** to access all the programs of your device.
3. Touch **Remove** to choose which program to remove from the Programs tab.
4. Touch a program icon to open the corresponding program.

When you have filled up the screen with programs, scroll down the **Programs** tab to access more empty slots and add more programs. To scroll down, press and hold on the screen and then drag your finger upward. You can add up to 18 favorite programs.

To scroll back up, press and hold on the screen and then drag your finger downward.

Note To replace a slot with another program, you must delete the occupying program shortcut first and then add your desired program.

Finger Gestures

You can use finger gestures to scroll, zoom and pan on the touch screen.

Finger-scrolling

Finger-scrolling can be used to scroll up and down Web pages, documents, and lists such as the contacts list, file list, message list, calendar appointments list, and more.

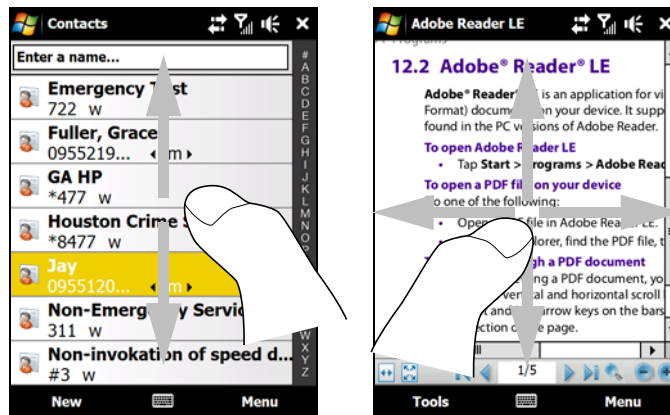

When finger-scrolling, swipe or flick your finger on the touch screen.

To scroll up and down:

- To scroll down, swipe your finger upward on the touch screen. To scroll up, swipe your finger downward on the touch screen.
- To auto-scroll, flick your finger upward or downward on the touch screen. Touch the screen to stop scrolling.

To scroll left and right:

- To scroll towards the right, swipe your finger to the left. To scroll towards the left, swipe your finger to the right.
- To auto-scroll, flick your finger left or right. Touch the screen to stop scrolling.

Finger-zooming

The type of finger gesture to use when zooming varies in different programs.

- To zoom in on a Web page in Opera Mobile, tap your finger twice on the screen. See “Navigating the Web” on page 143 for details.
- To zoom in on a photo in Album, make a full-circle swipe on the touch screen. See “Viewing Photos and Videos” on page 103 for details.

Finger-panning

You can use finger-panning to move to and view other parts of a zoomed photo, Web page, document, or an email message. To pan, touch and hold on the touch screen and then drag your finger in any direction.

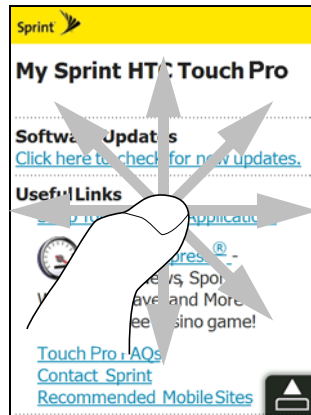

Tip To enable or mute finger scrolling and panning sounds, touch **Start > Settings > System tab > TouchFLO**, and then select or clear the **Enable sound when finger scrolling and panning** check box.

Section 2D

Entering Text

- ◆ *The Sliding QWERTY Keyboard vs. Onscreen Input Methods (page 54)*
- ◆ *Using the Sliding QWERTY Keyboard (page 56)*
- ◆ *Using the Full QWERTY Layout (page 57)*
- ◆ *Using the Compact QWERTY Layout (page 58)*
- ◆ *Using the Phone Keypad (page 59)*
- ◆ *Using Multitap and T9 Modes (page 60)*
- ◆ *Using Numeric and Symbol Mode (page 61)*
- ◆ *Using Block Recognizer (page 61)*
- ◆ *Using Letter Recognizer (page 62)*
- ◆ *Using Transcriber (page 62)*

Your device provides convenient ways to enter letters, numbers, and symbols whenever you are prompted to enter text (for example, when adding a Contacts entry or when using email and SMS text messaging). This section shows you how to enter text using the sliding QWERTY keyboard and various onscreen input methods that are available on your device.

The Sliding QWERTY Keyboard vs. Onscreen Input Methods

When you start a program or select a field that requires text or numbers, you use either the sliding QWERTY keyboard or one of the onscreen input methods to enter text.

Sliding QWERTY Keyboard

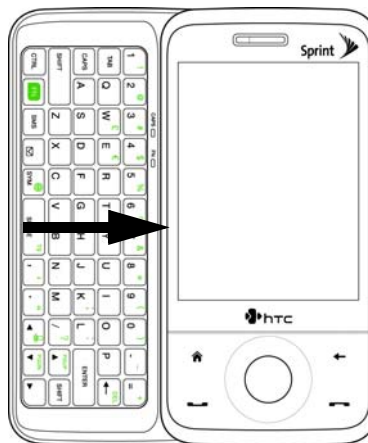

Your device comes with a sliding QWERTY keyboard, which is similar to a standard keyboard on your computer.

To use the keyboard, slide the screen panel to the right to reveal the keyboard. The screen orientation automatically switches between landscape and portrait modes depending on the orientation of the device.

Onscreen Input Methods

When you start a program or select a field that requires text or numbers, the *Input Panel* icon becomes available on the menu bar.

Tap the *Input Selector* arrow (that appears next to the *Input Panel* icon) to open a menu where you can select a text input method and customize input options. After selecting a text input method, the corresponding *Input Panel* is displayed, which you can use to enter text.

Tip Select *Other Input Methods* to display more input methods.

To show or hide the *Input Panel*:

- ▶ Tap the *Input Panel* icon.

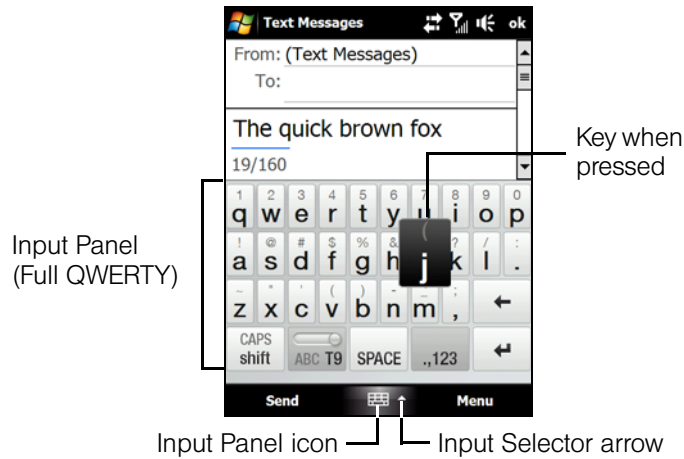

To select an input method:

- ▶ Tap the *Input Selector* arrow, and then choose from the Input Methods menu.

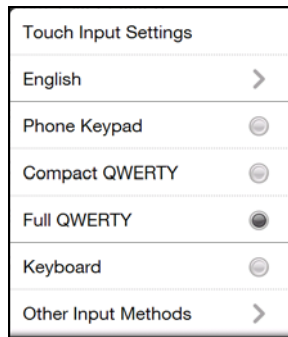

Input Methods menu

Icon	Input method
	Full QWERTY
	Compact QWERTY
	Phone Keypad

Icon	Input method
	Letter Recognizer or Block Recognizer
	Transcriber
	Keyboard

Notes

- Some text input methods may not be available in certain language versions of the device.
- When in landscape mode, Compact QWERTY and the Phone keypad are not available.

Using the Sliding QWERTY Keyboard

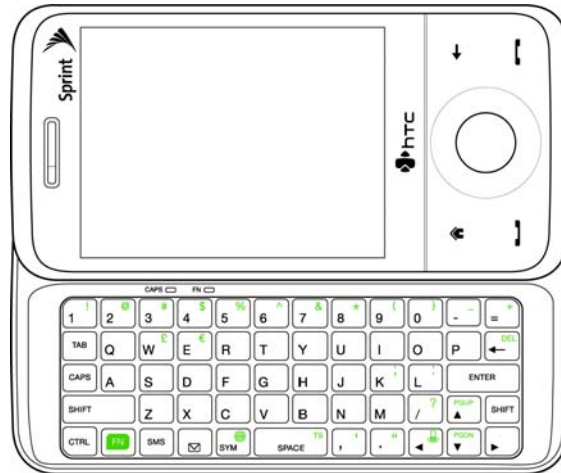

You can do the following with the sliding QWERTY keyboard:

- To type lowercase letters and numbers, press the keys using your thumbs.
- To use all uppercase letters, press **CAPS**. To change back to all lowercase letters, press **CAPS** again.
- To use a single uppercase letter, press **SHIFT**, and then press the corresponding key.
- To enter the symbol or punctuation mark, or launch the program that is printed at the upper right corner of a key, press **FN**, and then press the corresponding key.
- To open the Symbol Pad, press **SYM**.
- Press **ENTER** to insert a hard return while typing.
- Press the arrow keys **←** / **→** / **PGUP** / **PGDN** for directional movement.
- Press **✉** to open the Messaging program.
- Press **SMS/MMS** to open your SMS/MMS messaging account.
- Press and hold **FN**, and then press **SPACE T9** to open the T9 menu.

Using the Full QWERTY Layout

Full QWERTY is a full onscreen QWERTY keyboard layout similar to a desktop computer keyboard.

Tip

You can also use the Windows Mobile onscreen keyboard which also has a QWERTY keyboard layout by selecting **Keyboard** (or **Other Input Methods > Keyboard**) on the **Text input method** menu.

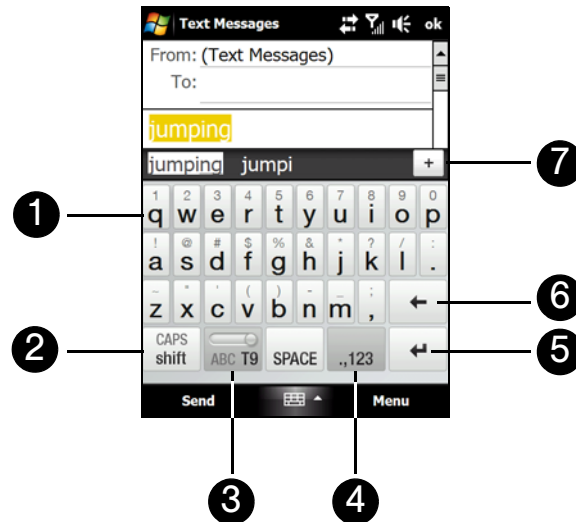

1. Tap the keys to enter letters or symbols.
Tap and hold a key to enter a punctuation mark, symbol, or number that appears on top of a key.
2. Tap to enter an uppercase letter.
Tap twice to turn on Caps Lock.
3. indicates you are in Normal mode. Tap to change to T9 mode.
 indicates you are in T9 mode. Tap to change back to Normal mode.
4. Tap to open a keyboard layout that lets you easily enter numbers and symbols. See “Using Numeric and Symbol Mode” for details.
5. Tap the **Enter** key to create a new line.
6. Tap the **Back** key to delete the previous character.
7. Displays the word candidate list in T9 mode. Tap a word to insert it into your text. Tap to add a word to the T9 dictionary.





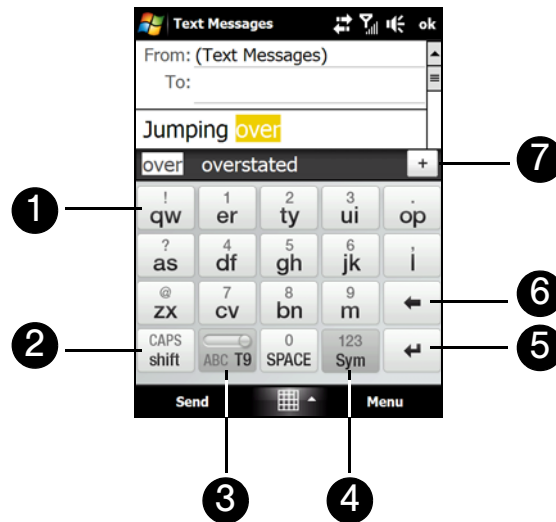

To enter text using the Full QWERTY layout:

1. Start a program that accepts text input, such as Word Mobile.
2. Tap the **Input Selector** arrow, and then tap **Full QWERTY**.
3. Start tapping keys on the keyboard as you would on a computer keyboard to enter your text. To learn how to enter text using T9 mode, see “Using Multitap and T9 Modes” in this section.

Using the Compact QWERTY Layout

Compact QWERTY is an onscreen keyboard layout that features 20 keys. With its large, touch-friendly keys and enhanced features such as T9 predictive input, you can enter text faster and more accurately.



1. Tap the keys to enter letters or symbols.
Tap and hold a key to enter a punctuation mark, symbol, or number that appears on top of a key.
2. Tap  to enter an uppercase letter.
Tap  twice to turn on Caps Lock.
3.  indicates you are in Multitap mode. Tap to change to T9 mode.
 indicates you are in T9 mode. Tap to change back to Multitap mode.
4. Tap  to open a keyboard layout that lets you easily enter numbers and symbols. See “Using Numeric and Symbol Mode” for details.
5. Tap the **Enter** key to create a new line.
6. Tap the **Back** key to delete the previous character.
7. Displays the word candidate list in T9 mode. Tap a word to insert it into your text. Tap  to add a word to the T9 dictionary.

Tip You can tap and hold  to immediately open the numeric keyboard.

To enter text using the Compact QWERTY layout:

1. Start a program that accepts text input, such as Word Mobile.
2. Tap the *Input Selector* arrow, and then tap *Compact QWERTY*.
3. Start tapping keys on the keyboard to enter your text. To learn how to enter text using Multitap or T9 mode, see “Using Multitap and T9 Modes” on page 60.

Using the Phone Keypad

The *Phone Keypad* is a 12-key onscreen keypad that has a layout similar to mobile phone keypads, plus some additional keys. The Phone keypad has large keys and enhanced input features such as T9 predictive input, which makes it faster for you to enter text in your messages and documents.

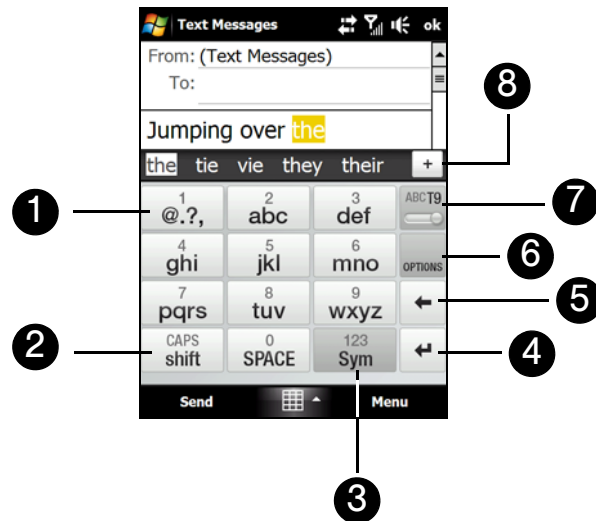

1. Tap the keys to enter letters or symbols.
Tap and hold a key to enter a punctuation mark, symbol, or number that appears on top of a key.
2. Tap to enter an uppercase letter.
Tap twice to turn on Caps Lock.
3. Tap to open a keyboard layout that lets you easily enter numbers and symbols. See “Using Numeric and Symbol Mode” for details.
4. Tap the **Enter** key to create a new line.
5. Tap the **Back** key to delete the previous character.
6. Tap *Options* to open the input settings.
7. indicates you are in Multitap mode. Tap to change to T9 mode.
 indicates you are in T9 mode. Tap to change back to Multitap mode.
8. Displays the word candidate list in T9 mode. Tap a word to insert it into your text. Tap to add a word to the T9 dictionary.

Tip You can tap and hold to immediately open the numeric keyboard.

To enter text using the Phone keypad:

1. Start a program that accepts text input, such as Word Mobile.
2. Tap the *Input Selector* arrow, and then tap *Phone Keypad*.
3. Tap keys on the keyboard to enter your text. To learn how to enter text using Multitap or T9 mode, see “Using Multitap and T9 Modes” on page 60.

Using Multitap and T9 Modes

When using the onscreen keyboards, you can choose to enter text using Multitap or T9 mode.

Multitap Mode

In **Multitap** mode (for Compact QWERTY and Phone keypad), enter a character by tapping a key until the desired character is displayed on the screen.

- To enter the first letter that shows on a key, tap the key once. To enter the second letter, tap twice.
- To enter a punctuation mark, symbol, or number that appears on top of a key, tap and hold the key.

T9 Mode

T9 is a predictive text input mode that displays a word candidate list as you enter the first few characters so you select just the word that you want.

To enter text using T9 mode:

1. Start entering the first few letters of a word. As you enter each letter, predicted words will appear above the keyboard.
2. Tap the desired word to immediately insert it to your text.

Note Navigate through the word candidate list if there are more words to choose from.

To add a word to the T9 dictionary:

If the word that you have entered is not found in the dictionary, you can add it to the dictionary.

1. While in T9 mode, type a letter and then tap **+** on right side of the word candidate list.
2. Type the word you want to add and then tap **ADD**.



To customize Touch Input settings:



1. Tap the **Input Selector** arrow, and then tap **Touch Input Settings**.
2. On the Touch Input Settings screen, select or clear the following options according to your preferences:
 - **Spell Correction.** Lets you correct typographical errors by selecting from a list of possible words that reflect the characters of the keys you have tapped as well as characters of nearby keys.
 - **Word Completion in T9 mode.** Lets you select from a list of possible words based on the keys that you have tapped and on the words available in the dictionary.
 - **Word Completion in ABC mode.** Lets you select from a list of possible combinations based on the characters that appear on the keys that you tapped.
 - **Auto-Substitution.** Automatically inserts an apostrophe when you type common contracted words (for example, "dont" automatically becomes "don't").
3. Tap **Done**.

Using Numeric and Symbol Mode

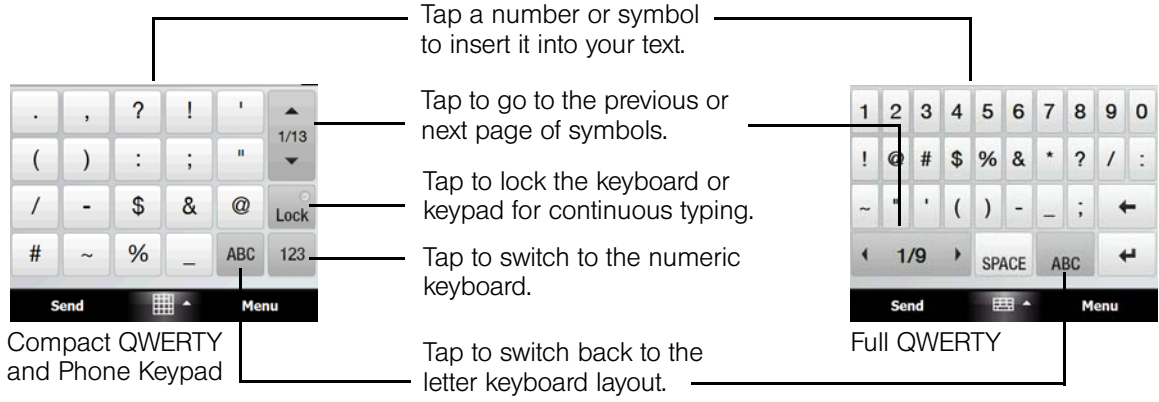
Switch to Numeric and Symbol mode to let you easily enter numbers and common symbols such as parentheses, braces, currency signs, punctuation marks, special characters, and more. Numeric and Symbol mode is available when using the Full QWERTY and Compact QWERTY layouts and the Phone keypad.





To switch to Numeric and Symbol mode:

1. While using the Full QWERTY, Compact QWERTY, or Phone keypad, tap  / .
2. Locate the number or symbol, and then tap it to insert it into your text.

To lock the keyboard in Numeric and Symbol mode:

You can lock the keyboard in Numeric and Symbol mode so you can continuously enter symbols and numbers.

1. Tap the **Input Selector** arrow and then tap **Other Input Methods > Options**.
2. In the **Input Method** tab, select a **Touch** input method in the **Input method** list, and then tap **Options**.
3. Clear the **Turn on one-touch symbol entry** check box.

Tip When using the Compact QWERTY layout or the Phone keypad, tap  /  to toggle between locking the keyboard in Numeric and Symbol mode and switching back to the letter keyboard layout after tapping a symbol or number.

Using Block Recognizer

With **Block Recognizer**, you use a single stroke to write letters, numbers, symbols, and punctuation, which are then converted into typed text.

To use Block Recognizer:

1. From within a program, tap the **Input Selector** arrow and then tap **Other Input Methods > Block Recognizer**.
2. Write characters, numbers, and symbols in the designated writing area.
 - Enter letters by writing in the **abc** (left) area of the box.
 - Enter numbers by writing in the **123** (right) area of the box.
 - Enter symbols and punctuation by tapping the left or right area of the box (a gray dot appears), and then writing the desired character.

Tip For help with writing characters, tap the question mark near the writing area.

Using Letter Recognizer

With *Letter Recognizer*, you can write individual letters, numbers, and punctuation marks, which are then converted into typed text.

To use Letter Recognizer:

1. From a program, tap the *Input Selector* arrow and then tap *Other Input Methods > Letter Recognizer*.
2. Write characters, numbers, and symbols in the designated writing area.
 - Enter uppercase letters by writing in the **ABC** (left) area of the box.
 - Enter lowercase letters by writing in the **abc** (middle) area of the box.
 - Enter numbers by writing in the **123** (right) area of the box.
 - Enter punctuation and symbols by writing the desired character in the **123** (right) area of the box.

Tip For help with writing characters, tap the question mark near the writing area.

Using Transcriber

Transcriber is a handwriting recognition program that enables you to write in cursive, print, or a combination of both.

To write using Transcriber:

1. Open a program that accepts user input, such as Word Mobile.
2. Tap the *Input Selector* arrow and then tap *Other Input Methods > Transcriber*. The Transcriber introductory screen appears. Read the introduction and tap *ok*.
3. Position the cursor where you want text to appear.
4. Use the stylus to write anywhere on the screen. The handwriting will be converted to text shortly after you lift the stylus from the screen.

To enter punctuation and symbols:

Transcriber comes with an onscreen keyboard that provides an easy way to add punctuation or a special symbol to existing text. To use this keyboard, tap  on the Transcriber toolbar.

The keyboard remains visible until you tap the button again.

Tips

- To reposition the keyboard, tap and hold the title bar, and then drag it to the desired location.
- When no text is selected, you can open the keyboard by using the  gesture (draw a line straight down and then straight up). For more information about using Transcriber gestures, see Help on your device.

To edit text:

1. In a program, draw a line from left to right across the text you want to edit.
2. After you lift the stylus from the screen, the line disappears and the selected text will be highlighted.
3. Do either of the following:
 - Rewrite the text.
 - Use gestures to capitalize letters, insert spaces, and so on. For information about using Transcriber gestures, see Help on your device.

Synchronizing Information With Your Computer

- ◆ *About Synchronization (page 63)*
- ◆ *Ways to Synchronize (page 63)*
- ◆ *Setting Up Windows Mobile Device Center on Windows Vista (page 64)*
- ◆ *Setting Up ActiveSync on Windows XP (page 65)*
- ◆ *Synchronizing With Your Computer (page 66)*
- ◆ *Synchronizing via Bluetooth (page 67)*
- ◆ *Synchronizing Music and Video (page 68)*

You can take information from your computer wherever you go by synchronizing them to your device. This section explains how to connect your device to the computer and synchronize your data.

About Synchronization

The following types of information can be synchronized between your computer and your device:

- **Microsoft® Office Outlook® information**, which includes Office Outlook email, contacts, calendar, tasks, and notes
- **Notes**, which are created using Microsoft® Office OneNote® 2007
- **Media**, such as pictures, music, and video
- **Favorites**, which are the bookmarked links to your favorite Web sites
- **Files**, such as documents and other files

Before you can synchronize, you first need to install and set up the synchronization software on your computer. For more information, see “Setting Up Windows Mobile Device Center on Windows Vista” and “Setting Up ActiveSync on Windows XP” in this section.

Ways to Synchronize

After you have installed the synchronization software on your computer, connect and synchronize your device with your computer by:

- Using the supplied USB sync cable.
Upon connecting the sync cable to your device and your computer, the synchronization process automatically starts.
- Using Bluetooth.
You must first set up a Bluetooth partnership between your device and your computer before you can synchronize information between them using Bluetooth. For more information about setting up a Bluetooth partnership, see “Bluetooth Partnerships” on page 90. For information about synchronizing through Bluetooth, see “Synchronizing via Bluetooth.”

Try to synchronize regularly in order to keep information up-to-date in both your device and your computer.

Note You can also synchronize Outlook email, contacts, calendar, and tasks on your device with the Exchange Server at your workplace. For more information about setting up your device to synchronize with the Exchange Server, see “Working With Company Email and Meeting Appointments” on page 168.

Setting Up Windows Mobile Device Center on Windows Vista

Microsoft Windows Mobile® Device Center is the replacement for Microsoft® ActiveSync® on Windows Vista®.

Note Some versions of Windows Vista come with Windows Mobile Device Center already installed. If Windows Mobile Device Center is not available in your Windows Vista installation, you can install it from the Getting Started CD that came with your device.

Setting Up Synchronization in Windows Mobile Device Center

When you connect your device to your computer and start Windows Mobile Device Center for the first time, you are asked to create a Windows Mobile partnership with your device. To create a partnership:



1. Connect your device to your computer. Windows Mobile Device Center configures itself, and then opens.
2. On the license agreement screen, click **Accept**.
3. On the Windows Mobile Device Center's Home screen, click **Set up your device**.

Note Choose **Connect without setting up your device** if you only want to transfer media files, check for updates, and explore your device but not synchronize Outlook information.

4. Select the items you want to synchronize, and then click **Next**.
5. Enter a device name, and then click **Set Up**.

When you finish the setup wizard, Windows Mobile Device Center synchronizes your device automatically. Outlook email messages and other information appear on your device after synchronization.

Using Windows Mobile Device Center

To open Windows Mobile Device Center, click *Start > All Programs > Windows Mobile Device Center* on your Windows Vista computer.



Within Windows Mobile Device Center, you can do the following:

- Click **Mobile Device Settings** to change synchronization settings.
- Click **Pictures, Music and Video** > -- *new pictures/video clips are available for import*, and a wizard will guide you through tagging and transferring photos from your device to the Photo Gallery on your computer.
- Click **Pictures, Music and Video** > *Add media to your device from Windows Media Player* to synchronize music and video files using Windows Media Player. For more information, see “Using Windows Media Player Mobile” on page 109.
- Click **File Management** > *Browse the contents of your device* to view documents and files on your device.

Note See *Windows Mobile Device Center Help* for more information.

Setting Up ActiveSync on Windows XP

The Getting Started CD that comes with your device contains Microsoft ActiveSync 4.5 (or later). Follow the steps in this section to install and set up ActiveSync on Windows XP or other compatible Windows systems.

Note For a list of compatible Windows systems, go to this Web site:
<http://www.microsoft.com/windowsmobile/activesync/activesync45.msp>

Installing ActiveSync

1. Place the Getting Started CD in the CD or DVD drive of your computer, and then click **Setup and Installation**.
2. Select the **ActiveSync** check box, and then click **Install**.
3. Read the license terms, and then click **Accept**.
4. When installation is completed, click **Done**.
5. On the Getting Started with Windows Mobile screen, click **Close**.

Setting Up Synchronization in ActiveSync

1. Connect your device to your computer. The Synchronization Setup Wizard automatically starts and guides you to create a synchronization partnership. Click **Next** to proceed.
2. To synchronize your device with your computer, clear the **Synchronize directly with a server running Microsoft Exchange** check box, and then click **Next**.
3. Select the information types that you want to synchronize, and then click **Next**.
4. Select or clear the **Allow wireless data connections** check box according to your preference.
5. Click **Finish**.

When you finish the wizard, ActiveSync synchronizes your device automatically. Notice that Outlook email messages and other information appear on your device after synchronization.

Synchronizing With Your Computer

Connect and synchronize your device with your computer using the USB cable or Bluetooth connection.

Starting and Stopping Synchronization

You can manually synchronize from either your device or your computer.

From your Device



- ▶ On the TouchFLO 3D Home screen, slide to the **Settings** tab and then touch **Sync Data**.
– or –

Tap **Start > Programs > ActiveSync**, and then tap **Sync**. To end synchronization before it completes, tap **Stop**.

Tip



To delete a partnership with one computer completely, disconnect your device from that computer. In ActiveSync on your device, tap **Menu > Options...**, tap the computer name, and then tap **Delete**.

From Windows Mobile Device Center

1. Click **Start > All Programs > Windows Mobile Device Center**.
2. Click  at the lower left of the Windows Mobile Device Center. To end synchronization before it completes, click .

From ActiveSync on Your Computer

When you connect your device to your computer, ActiveSync automatically opens on your computer and synchronizes.

- To manually start synchronization, click .
- To end synchronization before it completes, click .

Specifying What Information Is Synchronized

You can change the information types and the amount of information to synchronize for each type on either your device or your computer. Follow the steps below to change synchronization settings on your device.

Note Before changing synchronization settings on your device, disconnect it from your computer.

1. In ActiveSync on your device, tap **Menu > Options**.
2. Select the check box for any items you want to synchronize. If you cannot select a check box, you might have to clear the check box for the same information type elsewhere in the list.
3. To change synchronization settings for an information type (for example, **E-Mail**), select it, and tap **Settings**. You can then set the download size limit, specify the time period of information to download, and more.

Notes

- Some information types such as *Favorites, Files, and Media* cannot be selected in ActiveSync Options on your device. You can select or clear these items only from your computer's Windows Mobile Device Center or ActiveSync.
- A computer can have sync partnerships with many different Windows Mobile powered devices, but a device can have sync partnerships with at most two computers. To ensure that your device will synchronize properly with both computers, set up the second computer using the same synchronization settings you used on the first computer.
- Outlook email can be synchronized with only one computer.

Troubleshooting Sync Connection Problems

In some cases, when the computer connects to the Internet or a local network, it may disconnect the connection with your device in favor of the Internet or network connection.

If this happens, tap **Start > Settings > Connections** tab **> USB to PC**, and then clear the **Enable advanced network functionality** check box. This makes your computer use a serial USB connection with your device.

Synchronizing via Bluetooth

You can connect and synchronize your device with the computer using Bluetooth.

Note To connect and synchronize your device with a computer via Bluetooth, your computer must have a built-in Bluetooth or installed with a Bluetooth adapter or dongle.

1. Set up Windows Mobile Device Center or ActiveSync on your computer to synchronize through Bluetooth. See the program's Help for instructions.
2. On your device, tap **Start > Programs > ActiveSync**.
3. Make sure that Bluetooth on both your device and the computer are turned on and set to visible mode. See "Using Bluetooth" on page 89 for details.
If this is the first time you have connected to this computer via Bluetooth, you must first complete the Bluetooth wizard on your device and set up a Bluetooth partnership between your device and the computer. For more information about creating a Bluetooth partnership, see "Bluetooth Partnerships" on page 90.
4. Tap **Menu > Connect via Bluetooth**. Make sure the Bluetooth function of both your device and the computer are turned on and set to visible mode.

Note To conserve battery power, turn off Bluetooth when not in use.

Synchronizing Music and Video

If you want to carry your music or other digital media along with you while you travel, set up Windows Media® Player on your computer to synchronize music and video with your device.

Other than selecting the **Media** information type to be synchronized, all media synchronization settings must be set in Windows Media Player. Before media can be synchronized, you must do the following:

- Install Windows Media Player Version 11 on your computer. (Windows Media Player 11 works only with Windows XP or later versions).
- Connect your device to the computer with a USB cable. If your device is currently connected using Bluetooth, you must end that connection before media can be synchronized.
- Set up a sync partnership between your device and your computer's Windows Media Player.

For more information about using Windows Media Player Mobile, see “Using Windows Media Player Mobile” on page 109.

Contacts, Calendar, and Other Tools

- ◆ *Contacts* (page 69)
- ◆ *Calendar* (page 71)
- ◆ *Notes* (page 73)
- ◆ *Tasks* (page 74)
- ◆ *Comm Manager* (page 75)
- ◆ *Adobe Reader LE* (page 76)
- ◆ *Microsoft Office Mobile* (page 77)
- ◆ *ClearVue Presentation 5 Pro* (page 78)
- ◆ *Automatic Speech Recognition (ASR)* (page 78)
- ◆ *Voice Recorder* (page 79)
- ◆ *Zip* (page 81)
- ◆ *WorldCard Mobile (Business Card Scanner)* (page 82)
- ◆ *JETCET PRINT 5 (Wireless Printing Application)* (page 84)

Your device is equipped with several personal information management features that help you manage your busy lifestyle. Document viewers, voice recognition and recording programs, a business card reader, and other useful tools are also available. This section shows you how to use these features and tools.

Contacts

Adding New Contacts

Contacts is your address book and information storage for people and businesses you communicate with. You can add the following types of contacts to your device:

- **Outlook contacts.** Contacts that are stored on your device, which can be created on your device or synchronized with your computer or the Exchange Server.
- **Windows Live™ contacts.** Contacts that you communicate with using Windows Live™ Messenger or MSN.

Note You can add Windows Live™ contacts only after setting up Windows Live™ on your device. See “Adding Windows Live Contacts” on page 149 for details.

To open the **Contacts** screen:

- ▶ On the TouchFLO 3D Home screen, slide to the **People** tab and then tap **All People**.
– or –
Tap **Start > Contacts**.

To add a contact on your device:

1. Open the **Contacts** screen.
2. Tap **New**, select **Outlook Contact**, and enter the contact information.
3. In the **File as** field, choose how you want the contact name to appear in the contact list.

4. To add a photo of the contact, tap **Select a picture**, and then select the picture file or tap **Camera** to take a photo of the contact.
5. To assign a ring tone to the contact, tap the **Ring tone** field, scroll through the list of tones, and then select a desired tone.
6. When finished, tap **ok**.

Tips

- If a person who is not in your list of contacts called you and you want to save that person's phone number, tap and hold the phone number in the Call History and then tap **Save to Contacts** from the shortcut menu.
- To save a phone number that is contained in a message, open the message, tap the underlined phone number, and then tap **Menu > Save to Contacts**.
- To edit contact information, tap the contact name and then tap **Menu > Edit**.

Managing Contacts

To group similar contacts:

For easier management, you can group similar contacts by assigning them to categories.

1. Create a new Outlook contact or edit an existing Outlook contact.
2. Tap **Categories**.
3. Select a preset category such as Business or Personal, or tap **New** to create your own category.
4. When finished, tap **ok**.

To find a contact on your device:

There are several ways to find a contact when your contact list is long:

- Begin entering a contact name in the provided text box until the contact you want is displayed.
- On the Quick Scroll bar on the right of the Contacts screen, scroll to or tap a letter to go directly to the part of the contacts list where contact names start with that letter.

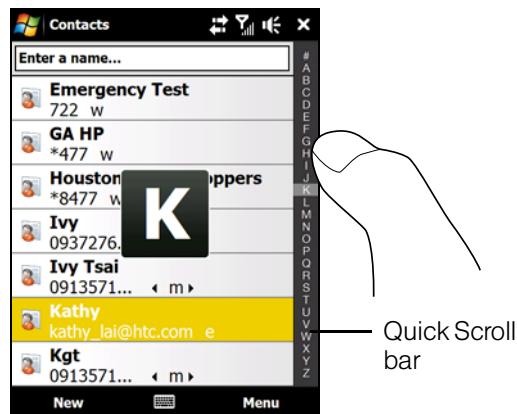

Note

You can disable the Quick Scroll bar by tapping **Menu > Options...** and selecting the **Show alphabetical index** check box. This will show the alphabetical index at the top of the Contacts list.

- Filter the list by categories. In the contact list, tap **Menu > Filter**, and then tap a category you've assigned to a contact. To show all contacts again, select **Menu > Filter > All Contacts**.

To beam a contact's details:

You can quickly send contact information to another mobile phone or device through Bluetooth beaming.

1. On the Contacts screen, select a contact.
2. Tap **Menu** > **Send Contact** > **Beam**, and then select a device where to beam the contact to.

Note Before beaming, make sure Bluetooth is turned on and set to visible mode on your device and the target mobile device. You can also beam contact information to your computer. See "Bluetooth" on page 89 for details.

Calendar

Use **Calendar** to create appointments, including meetings and other events. You can also synchronize Calendar appointments between your device and computer. This section shows you how to create a new appointment, change calendar views and send meeting requests.

To open the Calendar screen:

- ▶ On the TouchFLO 3D Home screen, tap **Calendar** or a displayed appointment.
 - or –
 - Tap **Start** > **Calendar**.

Creating Appointments

To schedule an appointment:

1. Open the Calendar screen and then tap **Menu** > **New Appointment**.
2. Enter a name for the appointment in the **Subject** field.
3. Do one of the following:
 - If it is a special occasion such as a birthday or an all-day event, set the **All Day** option to **Yes**.
 - If there is a time frame for the appointment, set the start and end dates and times.
4. Specify the type of category for your appointment, so that it can be grouped with other related appointments. Tap **Categories**, and then select a preset category (Business, Holiday, Personal, or Seasonal), or tap **New** to create your own category.
5. When finished, tap **ok** to return to the calendar.

Notes

- All-day events do not occupy blocks of time in Calendar; instead, they appear in banners at the top of the calendar.
- To remove an appointment, tap **Menu** > **Delete Appointment**

Tip To have the time entered automatically in Day view, tap and drag to select a time slot for the new appointment, and tap **Menu** > **New Appointment**.

To set the reminder time for new appointments:

By default, Calendar has been set to display a reminder alert when you have new upcoming appointments. You can change the reminder time.

1. Open the Calendar screen.
2. Tap **Menu** > **Tools** > **Options...** > **Appointments** tab.
3. Make sure the **Set reminders for new items** check box is selected.
4. Set the time when you want the reminder to alert you, and then tap **ok** to return to the Calendar screen.

The Calendar Screen

By default, Calendar displays appointments in *Agenda* view. You can also look at your appointments in *Day*, *Week*, *Month*, and *Year* views.

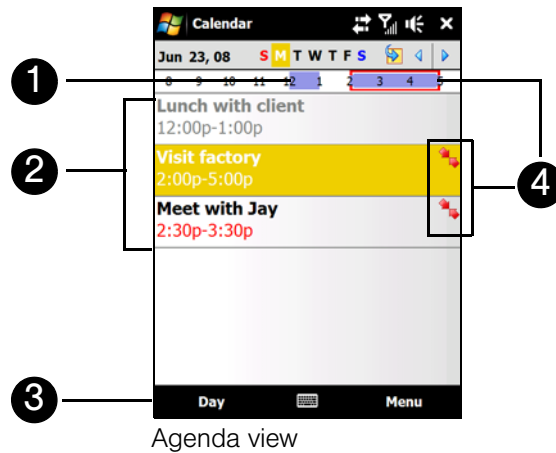

1. The highlighted hours indicate the time of your appointments.
2. Tap an appointment to view details about the appointment.
3. Tap the lower-left side of the screen to change the calendar view to one of the following: *Day*, *Week*, *Month*, *Year*, or *Agenda*.
4. The red box and red arrows indicate there are conflicting appointments.

Viewing Appointments

- To see detailed appointment information in any view, tap the appointment.
- To view appointments by category, tap *Menu > Filter*, and then select the desired category.
- To change the default view that Calendar uses to display appointments, tap *Menu > Tools > Options... > General* tab. Tap the *Start in* box, and then choose the calendar view.
- When in Month view, you will see the following indicators:
 - Morning appointment
 - Afternoon or evening appointment
 - Both morning and afternoon or evening appointments
 - All-day event

Sending Appointments

Sending a Meeting Request

Use Calendar to schedule meetings via email with contacts who use Outlook or Outlook Mobile.

1. Open the Calendar screen.
2. Schedule a new appointment, or open an existing one and tap *Menu > Edit*.
3. Tap *Attendees*, and then tap *Add Required Attendee* or *Add Optional Attendee* and add the contacts whom you want to invite.

Note You can specify if an attendee is required or optional only if your device is connected to a Microsoft Exchange 2007 server. Otherwise, all attendees are designated as required. For more information, see "Managing Meeting Requests" on page 173.

4. When you have finished adding attendees, tap **Done**.
5. Tap **ok** to send.

Tip To choose the email account to use for sending meeting requests, tap **Menu > Tools > Options... > Appointments tab**. Tap the **Send meeting requests via** box and choose to send via your Outlook Email, POP3/IMAP4 or Windows Live™ account.

Notes

- If you're sending the meeting request using your Outlook Email account, it will be sent to the attendees the next time you synchronize your device with your computer or Exchange Server.
- When attendees accept your meeting request, the meeting is automatically added to their schedules. When their response is sent back to you, your calendar is updated as well.

Notes

Using **Notes**, you can create handwritten and typed notes, record voice notes, convert handwritten notes to text for easy readability, and more.

To create a note:

1. Tap **Start > Programs > Notes**. In the note list, tap **New**.
2. Choose an input method and then enter your text.

Tip For more information about input methods and entering text, see "Entering Text" on page 54.

3. When finished, tap **ok** to save and return to the note list.

Notes

- To select handwritten text, tap and hold next to the writing. As soon as dots appear, and before they form a complete circle, quickly drag across the writing.
- If a letter crosses three ruled lines, it is treated as a drawing rather than text.

To draw in a note:

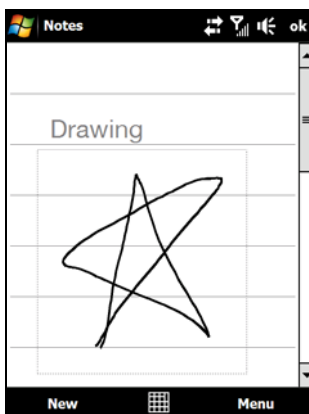

1. Create or open a note file.
2. Use the stylus to draw on the screen. A selection box then appears around your drawing.
3. Tap **ok** to save.



Note To select a drawing (for example, to copy or delete it), tap and hold the drawing briefly. When you lift the stylus, the drawing is selected.

To record a voice note:

You can create a stand-alone recording (voice note) or you can add a recording to a note.

1. Tap **Start > Programs > Notes**.
2. If you do not see the Recording toolbar, tap **Menu > View Recording Toolbar**.
3. Do one of the following:
 - To add a recording to a note, create or open a note.
 - To create a stand-alone recording, record from the note list.
4. Tap the **Record** icon () to begin recording your voice. Tap the **Stop** icon () when you are finished recording.

Tip To select the voice recording format, return to the note list and then tap **Menu > Options... > Global Input Options** link (at the bottom of the Options screen). On the Input screen, tap the **Options** tab and choose the desired format from the Voice recording format list.

Tasks

Use **Tasks** to keep track of things you need to do. A task can occur once or repeatedly (recurring).

Your tasks are displayed in a task list. Overdue tasks are displayed in red. A reminder will be displayed when you have new tasks to be completed.

To create a task:

1. Tap **Start > Programs > Tasks**.
2. Tap **Menu > New Task**, enter a subject for the task, and fill in information such as start and due dates, priority, and so on.
3. Specify the type of category for your task, so that it can be grouped with other related tasks. Tap **Categories**, and then select a preset category (Business, Holiday, Personal, or Seasonal), or tap **New** to create your own category.
4. When finished, tap **ok**.

To change the priority of a task:

Before you can sort tasks by priority, you need to specify a priority level for each task.

1. Tap **Start > Programs > Tasks**.
2. Tap the task you want to change the priority for.
3. Tap **Edit**, and tap a priority level in the **Priority** box.
4. Tap **ok** to return to the task list.

Note All new tasks are assigned a Normal priority by default.

To show start and due dates in the task list:

1. Tap **Start > Programs > Tasks**, and then tap **Menu > Options**.
2. Select the **Show start and due dates** check box, and then tap **ok**.

Comm Manager

Comm Manager is a central location where you can easily turn on and off the communication features of your device such as the phone, Wi-Fi, data connection, Bluetooth, and more.

To access the *Comm Manager*:

Do one of the following:

- ▶ On the TouchFLO 3D Home screen, slide to the **Settings** tab, and then touch **Communications**.

– or –

Touch **Start > Programs > Comm Manager**.

– or –

Touch **Start > Settings > Connections tab > Comm Manager**.



1. Switch Airplane Mode on or off. Turning on Airplane Mode turns off the phone, Wi-Fi, and Bluetooth functions. For more information, see “Enabling or Disabling Airplane Mode” on page 36.
2. Switch the phone on or off. Tap **Settings > Phone** to set the ring tone and other phone settings. See “Managing Your Device” on page 115 for details.
3. Switch Bluetooth on or off. Tap **Settings > Bluetooth** to configure Bluetooth on your device. See “Bluetooth” on page 89 for details.
4. Switch Wi-Fi on or off. Tap **Settings > Wireless LAN** to configure wireless network connection settings. See “Connecting via Wi-Fi” on page 137 for details.
5. Switch between automatically receiving (as items arrive) or manually retrieving Outlook email. See “Working With Company Email” on page 170 for details.
6. Connect to or disconnect from data services. See “Connecting to Data Services from the Comm Manager” on page 141 and “Disconnecting from Data Services” on page 142 for details.

Adobe Reader LE

Adobe® Reader® LE is an application for viewing PDF (Portable Document Format) documents on your device. It supports a subset of the features found in full versions of Adobe Reader.

To open Adobe Reader LE:

- ▶ Tap **Start > Programs > Adobe Reader LE**.

To open a PDF file on your device:







- ▶ Open a PDF file in Adobe Reader LE.
 - or –
 - Open File Explorer, find the PDF file, and then tap the file to open it.

To navigate through a PDF document:

You can use the controls in the program and finger gestures to navigate a PDF document.

- Tap **Tools > View > Continuous** and then slide your finger up or down the screen to scroll through the pages in the document.

Tip You can also drag the scroll bars to scroll through the pages.

- Tap  to zoom in or  to zoom out. After zooming in, slide your finger on the screen to pan the current page.
- Press the Navigation Control up, down, left, or right to move to the desired direction of the page.
- Tap  to return to the previous page; tap  to move to the next page. Tap  to jump to the first page; tap  to jump to the last page.
- Tap **Tools > Go To > Page Number** to enter a page number that you want to view.

To search for text in the document:

1. Tap **Tools > Find > Text** or tap  in the toolbar.
2. Type in the text to be searched, and then tap **Find**. The matched text in the document will be highlighted.
3. To view the next occurrence of the text, tap **Tools > Find > Next**.

Tips

- Adobe Reader LE displays a bookmark pane for the PDF files that contain bookmarks. Tap the bookmarks to go to a specific section/page within the file.
- Adobe Reader LE supports password-protected PDF files with up to 128-bit encryption. When you open a password-protected PDF file, you will be prompted to enter the password before opening it.

Microsoft Office Mobile

Microsoft® Office Mobile consists of the following applications:

- **Microsoft® Office Excel® Mobile** lets you create and edit Excel workbooks and templates on your device.
- **Microsoft® Office OneNote® Mobile** lets you create notes with text, photos, and voice recordings for synchronization later with Microsoft Office OneNote 2007 on your computer.
- **Microsoft® Office PowerPoint® Mobile** allows you to view (but not create) slide show presentations in *.ppt and *.pps formats.
- **Microsoft® Office Word Mobile** lets you create and edit documents and templates in Word Mobile and save them as *.doc, *.rtf, *.txt, and *.dot files.

To use Microsoft Office Mobile:

1. Tap **Start > Programs > Office Mobile**.
2. Tap the Office Mobile application that you want to use.

When working with Word Mobile and Excel Mobile files, you can use the Navigation Control on your device for zooming:

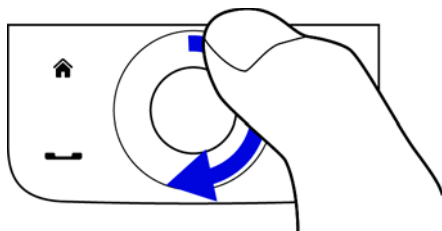

To zoom in, slide your finger clockwise around the Navigation Control.

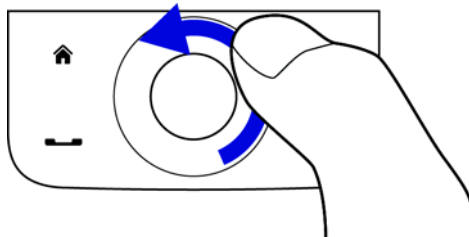

To zoom out, slide your finger counterclockwise around the Navigation Control.

Word Mobile and Excel Mobile do not fully support all features of Microsoft Office Word and Microsoft Office Excel. To see a complete list of features that are not supported in Word Mobile and Excel Mobile, see Help on your device.

Tips

- By default, Word Mobile saves documents in .docx format, while Excel Mobile saves workbooks in .xlsx format. If you want to open these types of files on a computer that uses Microsoft Office 2000, Office XP, or Office 2003, you need to download and install the **File Format Converter** in your computer. You can find this converter at <http://www.microsoft.com/downloads/details.aspx?FamilyId=941B3470-3AE9-4AEE-8F43-C6BB74CD1466&displaylang=en>.
- If you want Word Mobile to save documents in .doc format, tap **Menu > Tools > Options...** (or **Menu > Options...** when no document is opened), and then change the **Default template** to **Word 97-2003 Document (.doc)**.
- If you want Excel Mobile to save workbooks in a format that is compatible with Microsoft Office 2000, Office XP, or Office 2003, tap **Menu > Options...** (with no workbook opened), and then change **Template for new workbook** to **Blank 97-2003 Workbook**.

ClearVue Presentation 5 Pro

ClearVue Presentation 5 Pro lets you create, view, edit, and save Microsoft Office PowerPoint files on your device.

To access ClearVue Presentation 5 Pro:

- ▶ Tap **Start > Programs > ClearVue Presentation 5 Pro**.

To create a new PowerPoint presentation:

1. In ClearVue Presentation 5 Pro, tap **Menu > File > New**.
2. Do one of the following:
 - Tap **Menu > Slide** to add a new slide, create a duplicate of the current slide, hide a slide, and more.
 - Tap **Menu > Shape** to insert a text box, object, or picture, to modify or delete the inserted object or picture, and more.
 - Tap **Menu > Text** to add or modify text.
3. After creating your PowerPoint presentation, tap **Menu > File > Save As...** to save your presentation.

For more information about how to use ClearVue Presentation 5 Pro, see the ClearVue Presentation 5 Pro help. To access help, tap **Menu > Help...** or tap  in ClearVue Presentation 5 Pro.

Automatic Speech Recognition (ASR)

Your device's built-in ASR lets you make phone calls, open programs, play back music, get calendar information, and more, just by using your voice. It only responds to a set of predefined commands and does not allow you to record your own commands.

This section gives a few examples on how to use ASR. For more information, see ASR help on the device. To access help, tap **Start > Settings > Personal tab > Voice Command**, and then tap **Start > Help**.

To use ASR:

1. Press and hold the **Talk** key, and a microphone icon () will appear on the title bar.
2. Hold your device a few inches away from your mouth. In a clear voice, say a command.
For example, say "Help" to ask for information about using ASR.
3. The ASR software then asks you a question. Say your answer.

To place a call:

You can call contacts that are stored on your device, dial a phone number, redial, and place a return call.

1. Press and hold the **Talk** key until the microphone icon () appears on the title bar.
2. In a clear voice, say one of the following commands:
 - "Call [contact name]" to call a contact.
 - "Dial [number]" to dial a phone number.
 - "Redial" to repeat the last call made.
 - "Callback" to return the last call received.

- “Call [contact name] at [location]” to call a contact at a specific number.

For example, say:

“Call Ann at mobile”

“Call Ann at home”

“Call Ann at work”

3. The ASR software will then confirm with you the contact or number to call. Say “Yes” or “Correct.”
If the ASR software is wrong about the contact or number to call, say “No” or “Incorrect” to try again.
4. Your device starts to call the contact or number.

To open a program:

1. Press and hold the **Talk** key until the microphone icon () appears on the title bar.
2. In a clear voice, say “Start”, “Open”, or “Show” then the program name.

To request information from your calendar:

1. Press and hold the **Talk** key until the microphone icon () appears on the title bar.
2. In a clear voice, ask for the information you want to retrieve.

For example, say:

“What’s my next appointment?”

“What’s my next meeting?”

“What’s my schedule tomorrow?”

To request for date and time:



1. Press and hold the **Talk** key until the microphone icon () appears on the title bar.
2. In a clear voice, say “What date is it?” The ASR software then tells you the current date.
3. Press and hold the **Talk** key again, and then say “What time is it?”
4. The ASR software then tells you the current time.

Voice Recorder

Voice Recorder lets you record your voice and quickly send it as an email attachment, beam it via Bluetooth, or set the recorded voice as your ring tone.

Note *Voice Recorder saves voice recordings in AMR-NB (Adaptive Multi-Rate Narrowband) format only. This is a common speech audio format used in mobile devices.*

To record your voice:

1. Tap **Start** > **Programs** > **Voice Recorder**.
2. Hold the device’s microphone close to your mouth.
3. Touch **Record** or  to start recording. Tap **Stop** or  to end the recording.

To select or create a folder in which to save voice recordings:

By default, all recordings are saved in the **My Voices** folder of the device. You can choose another folder or create a new folder to save your voice recordings.

Tip If a microSD card is installed before you open Voice Recorder, the recordings are saved in the **My Voices** folder on the microSD card by default.

1. Tap the arrow beside the folder name on the upper left side of the screen.
2. In the menu that opens, choose an existing folder or touch **Add/Delete** to create a new folder.

To play back a voice recording:

- ▶ On the Voice Recorder screen, touch a voice recording, or navigate to a voice recording and then tap **Play** ().

Tip If you need to adjust the sound volume, touch any of the status icons on the title bar and then touch the volume icon () to open the System Volume screen where you can adjust the volume.

To send a voice recording via email:

- ▶ Select a voice recording, tap **Menu > Send**, and then select an email account.

This creates a new email message with the voice recording inserted as a file attachment. See “Email Messaging” on page 162 to learn how to send email.

To beam a voice recording via Bluetooth:

1. Select the voice recording you want to beam, and then tap **Menu > Beam File**.

Tip To select multiple recordings, tap and drag over the desired recordings or tap **Menu > Select All**.

2. Tap the device you want to send the voice recording to.
3. On the other device, accept the file transfer to receive the file.

To set a voice recording as a ring tone:

- ▶ Select the voice recording, and then tap **Menu > Set as Ringtone**.

To rename or move a recording:

1. Select the voice recording, and then tap **Menu > Rename/Move**.

Tip To select multiple recordings, tap and drag over the desired recordings or tap **Menu > Select All**. Note that you can move multiple files, but you cannot rename multiple files simultaneously.

2. In the **Name** box, enter the new voice recording name.
3. To move the voice recording, select the new destination in the **Folder** and **Location** boxes, and then tap **ok**.

Zip

The **Zip** program increases the storage capacity of your device by allowing you to compress files in the conventional zip format. It also allows you to extract files from a zip file.

To start Zip on your device:

- ▶ Tap **Start > Programs > Zip**.

Each time you start **Zip**, it searches for files that have the .zip file extension, and displays these files on the Archive List screen.

To open a zip file and extract files:

1. Touch a zip file to open it, or navigate to a zip file and then touch **File > Open Archive**.

Note You cannot select multiple zip files.

2. From the zip file, select files by doing one of the following:
 - Touch a file to select it.
 - To select several files, touch **Menu > Action** and make sure **Multi-Select Mode** is selected. Select files by touching each file. (Touch a selected file to deselect it).
 - To select all files, touch **Menu > Action > Select All**.
3. Touch **Menu > Action > Extract**.
4. Choose a folder where the files will be extracted to, and then touch **Extract**.
5. Touch **Menu > File > Close Archive** to close the zip file.

To create a new zip archive:

1. Touch **File > New Archive**.
2. On the Save As screen, enter the zip file name and choose a folder where you want to save it. You can also choose whether to save the zip file to the device's main memory or to the microSD card.
3. Touch **Save**.
4. Touch **Menu > Action > Add**.
5. Navigate to the folder that contains the files you want to archive.
6. Select files to add by doing one of the following:
 - Touch a file to select it.
 - To select several consecutive files, drag over the files.
 - To select several non-contiguous files, use the stylus to tap and hold on the screen and then select **Multi-Select Mode**. Select files by tapping each file. (Touch a selected file to deselect it).
 - To select all files, use the stylus to tap and hold on the screen and then tap **Select All**.
7. Touch **Add**.
8. Touch **Menu > File > Close Archive** to save and close the zip file.

WorldCard Mobile (Business Card Scanner)

WorldCard Mobile uses your device's built-in camera to scan business cards and import the information into your Contacts. For more information, see *WorldCard Mobile* help on the device. To access help, tap **Start > Programs > WorldCard Mobile**, and then tap **Start > Help**.

To access *WorldCard Mobile*:

- ▶ Tap **Start > Programs > WorldCard Mobile**.



1. Touch to view copyright information.
2. Touch to open *WorldCard Mobile* help.
3. Touch to exit *WorldCard Mobile*.
4. Touch to launch the camera and take a photo of a business card.

To capture a business card and export its information to Contacts:

1. Tap  on the *WorldCard Mobile* screen.
2. Frame the business card on the screen, and then press the **Enter** key to take the shot.

Tip Make sure that the business card is well lit and that the entire business card is visible on the screen before taking a picture.

3. Tap .

4. On the *WorldCard Mobile* screen, tap **Recognize**.

Tips

- If you want to retake the shot, tap **Re-Capture**.
- For better recognition, choose the **Language** and **Region** based on the language used in the business card.

5. The screen will display contact information captured from the business card. Use the onscreen keyboard to edit the contact information, if needed.

Tip Uncheck the box beside any contact information that you do not want to appear in your Contacts..

6. Tap **Export** to transfer the captured data to Contacts.

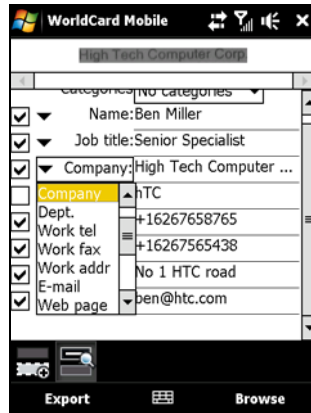

7. Go to your Contacts list to view the exported contact.

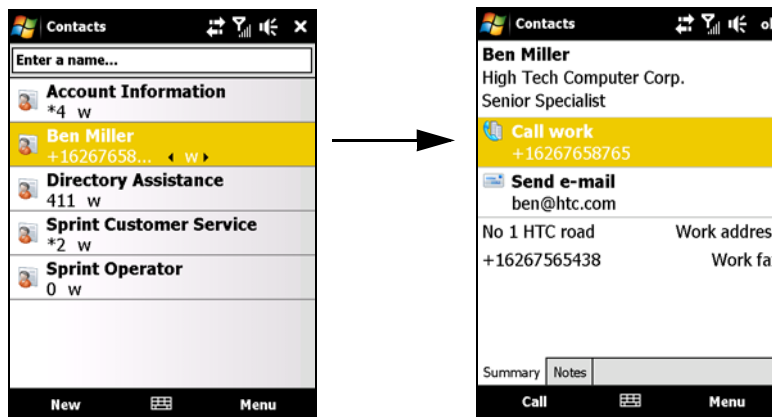

JETCET PRINT 5 (Wireless Printing Application)

JETCET PRINT™ 5 lets you print image files or documents from your device directly to a Bluetooth or network printer. You can also print email, email attachments, Web pages, appointments, contacts, and tasks. For more information, see JETCET PRINT 5 help on the device. To access help, tap **Start > Programs > JETCET PRINT 5**, and then tap **Start > Help**.

To access JETCET PRINT 5:

- ▶ Tap **Start > Programs > JETCET PRINT 5**.

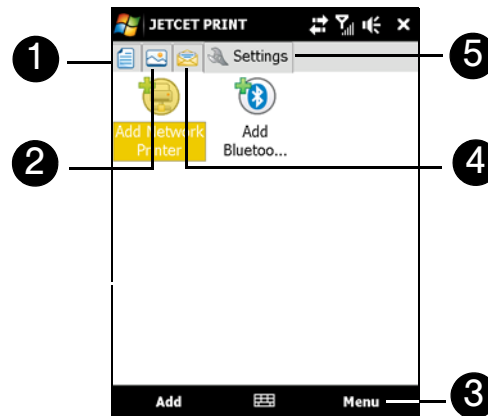

1. Tap to select a document to print.
2. Tap to select an image to print.
3. Tap to view and select additional tools or options.
4. Tap to select an email message, email attachment, appointment, calendar, or task to print.
5. Tap to set up a printer or change the printer settings.

To set up a printer:

- ▶ In the JETCET PRINT 5 application, select the **Settings** tab, and then tap:
 - **Add Network Printer** to set up and connect to a shared network printer.

Note The device will wait continuously if enter an incorrect IP address while setting up a network printer.

– or –

- **Add Bluetooth Printer** to set up and connect to a Bluetooth printer.

To print a file:

1. In the JETCET PRINT 5 application, locate and select the type of file that you want to print (document, image, or email/PIM) by tapping the corresponding tabs on top of the screen.
2. Select the file that you want to print, and then tap **Print**.
3. Select the printer to use and the paper size, and then tap **Next**.
4. Choose a page layout from the list, and then tap **Next** to print the file.

Tip You can also print image files from File Explorer. To print, use File Explorer to locate the file you want to print. Tap and hold the file, and then tap **Print via Bluetooth...** on the pop-up menu.

To print a Web page:

1. Tap *Start > Programs > Internet Explorer*.

Note You can print Web pages only in Internet Explorer.

2. Go to the Web page that you want to print.
3. Tap and hold the screen, and then tap *Print...* on the menu.
4. Select the printer to use and the paper size, and then tap *Next*.

Section 2G

microSD Card

- ◆ *Using a microSD Card on Your Phone (page 86)*
- ◆ *Managing the microSD Card (page 87)*
- ◆ *Using Your Device as a USB Drive (page 88)*

Your device lets you insert a microSD™ card to expand the available storage space. This highly secure digital card enables you to exchange images, music, and other data between SD-compatible devices, and also provides additional storage space on your device.

Using a microSD Card on Your Phone

Your phone comes with a 1 GB microSD (Secure Digital) memory card to expand the phone's available memory space. It allows you to store images, videos, and music in your phone.

Inserting the microSD card

The microSD card slot is located under the back cover of your device.

1. Remove the back cover. (See “Installing the Battery” on page 2.)
2. Insert the microSD card into the slot with the gold contacts facing down (in the same orientation as the image just to the left of the card slot).

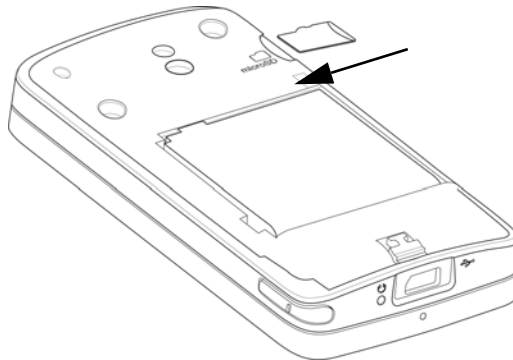

3. Replace the back cover.

Removing the microSD card

1. Remove the back cover. (See “Installing the Battery” on page 2.)
2. Remove the microSD card by pressing on the exposed edge and releasing. The card should pop out partway.

Managing the microSD Card

Copying files to the microSD card:

1. Tap **Start > Programs > File Explorer** and navigate to the appropriate folder.
2. Tap and hold the file you want to copy, and then tap **Copy**.
3. Tap the down arrow (▼), and then tap **Storage Card** in the list.
4. Tap and hold an empty area on the screen and then select **Paste** on the menu.

Tip You can configure programs such as Word Mobile and Excel Mobile to directly save edited files to the microSD card. In the program's file list, tap **Menu > Options...**, and then select **Storage Card** in the **Save to** box.

Encrypting files on your microSD card:

You can set your device to encrypt files as they are saved on the microSD card.

1. On the Home screen, slide to the **Settings** tab, and then tap **All Settings**.
2. On the **System** tab, tap **Encryption**.
3. Select the **Encrypt files when placed on a storage card** check box, and then tap **ok**.

Notes

- Encrypted files can only be read on the device that encrypted them.
- Encrypted files are opened just like other files, provided you are using the device that encrypted them. There is no separate step for you to take to read these files.

Important If **Encrypt files when placed on a storage card** is enabled, back up all files from the microSD card before using **Clear Storage**, **hard reset**, or **updating the ROM system software**. Otherwise you will no longer be able to access the encrypted files on the microSD card. Use **ActiveSync** or **Windows Mobile Device Center** to transfer files between your microSD card and computer. After the procedure, copy those files back to the microSD card.

Checking the available microSD card memory:

1. On the Home screen, slide to the **Settings** tab and then tap **All Settings**.
2. On the **System** tab, tap **Memory > Storage Card** tab.

If your device is running low on memory, try the following to free memory on your device:

 - Close programs that are not in use.
 - Move files and email attachments to the microSD card.
 - Delete unnecessary files. Tap **Start > Programs > File Explorer**. Tap and hold the file, and tap **Delete**.
 - Delete large files. To find large files on your device, tap **Start > Programs > Search**. In the **Type** list, tap **Larger than 64 KB**, and tap **Search**.
 - In Opera Mobile or Internet Explorer Mobile, delete temporary Internet files and clear history information.
 - Remove programs you no longer use.
 - Reset your device.

Using Your Device as a USB Drive

You can use an installed microSD card as a USB flash drive, allowing you to take pictures, music, documents, and other files with you on the go.

- ▶ Tap **Start** > **Settings** > **Connections** tab > **USB to PC** and then select **Disk Drive** mode.

While **Disk Drive** mode is enabled:

- You will not be able to use your device to access files from the microSD card or run applications that are installed on the microSD card while the device is connected to your computer.
- Your computer will connect only to the device's microSD card. When you access your device from the computer, you will only see the contents of the microSD card.

Remember to change back to **ActiveSync** mode when you need to synchronize data between your device and your computer.

Bluetooth

- ◆ *Using Bluetooth (page 89)*
- ◆ *Bluetooth Explorer and Bluetooth File Sharing (page 92)*
- ◆ *Printing Files via Bluetooth (page 93)*

Your device features built-in Bluetooth technology, allowing you to share information more easily than ever before.

Bluetooth is a short-range communications technology that allows you to connect wirelessly to a number of Bluetooth devices, such as headsets and hands-free car kits, and Bluetooth-enabled handhelds, computers, printers, and wireless phones. The Bluetooth communication range is usually up to approximately 30 feet.

This section shows you how to use Bluetooth on your device, including turning Bluetooth on and off, connecting to another Bluetooth device such as a Bluetooth stereo headset, and more.

Using Bluetooth

Bluetooth Modes

Bluetooth on your device has three different modes:

- **On.** Bluetooth is turned on. Your device can detect other Bluetooth-enabled devices within range, but cannot be detected by other Bluetooth-enabled devices.
- **Visible.** Bluetooth is turned on, and all other Bluetooth-enabled devices within range can detect your device.
- **Off.** Bluetooth is turned off. In this mode, you can neither send nor receive information using Bluetooth.

Notes

- *By default, Bluetooth is turned off. If you turn it on and then turn off your device, Bluetooth also turns off. When you turn on your device again, Bluetooth automatically turns on.*
- *Turn off Bluetooth when not in use to conserve battery power, or in places where using a wireless device is prohibited, such as aboard an aircraft and in hospitals.*

Turning Bluetooth On and Making Your Device Visible

1. On the Home screen, slide to the **Settings** tab and then tap **Menu > Bluetooth Devices > Mode** tab.
2. Select the **Turn on Bluetooth** and **Make this device visible to other devices** check boxes.
3. Tap **ok**. The Title bar will show  to indicate that the device is visible.

Turning Off Bluetooth Visibility After a Certain Period of Time

You can automatically turn off Bluetooth visibility after a specified period of time.

1. On the Home screen, slide to the **Settings** tab and then tap **Menu > Bluetooth Devices > Timeout** tab.
2. In **Turn off Visible mode**, select the time before your device's Bluetooth visibility turns off.
3. Tap **ok**.

Bluetooth Partnerships

A Bluetooth partnership is a relationship that you create between your device and another Bluetooth-enabled device in order to exchange information in a secure manner.

Creating a Bluetooth Partnership

1. On the Home screen, slide to the **Settings** tab and then tap **Menu > Bluetooth Devices > Devices** tab.
2. Tap **Add new device**. Your device displays the names of other Bluetooth devices within range.
3. Tap the device name in the box, and then tap **Next**.
4. Specify a passcode to establish a secure connection. The passcode can be 1 up to 16 characters.
5. Tap **Next**.
6. Wait for the paired device to accept the partnership. The receiving party needs to enter the same passcode that you specified.
7. The name of the paired device is then displayed. You may edit and enter a new name for that device.
8. Select the check boxes of services that you want to use from the paired device, and then tap **Finish**.

Note *Creating a Bluetooth partnership between two devices is a one-time process. Once a partnership is created, the devices can recognize the partnership and exchange information without entering a passcode again.*

Accepting a Bluetooth Partnership

1. Ensure that Bluetooth is turned on and in visible mode.
2. Tap **Yes** when prompted to establish a partnership with the other device.
3. Enter a passcode (the same passcode that is entered on the device requesting the partnership) to establish a secure connection. The passcode must be between 1 and 16 characters.
4. Tap **Next**.
5. Tap **Finish**. You can now exchange information with the paired device.

Tips

- To rename a Bluetooth partnership, tap and hold the partnership's name on the **Devices** tab of the Bluetooth screen, and then tap **Edit**.
- To delete a Bluetooth partnership, tap and hold the partnership's name on the **Devices** tab, and then tap **Delete**.

Connecting a Bluetooth Hands-free or Stereo Headset

For hands-free phone conversations, you can use a Bluetooth hands-free headset such as a car kit with your device. Your device also supports A2DP (Advanced Audio Distribution Profile) which allows you to use a Bluetooth stereo headset for hands-free phone conversations and for listening to stereo music.

To connect a Bluetooth hands-free or stereo headset:

1. Make sure that both your device and the Bluetooth headset are turned on and within range, and that the headset is visible. Refer to the manufacturer's documentation to find out how to set the headset in visible mode.
2. On the Home screen, slide to the **Settings** tab and then tap **Menu > Bluetooth Devices > Devices** tab > **Add new device**.
3. Tap the name of the Bluetooth headset, and then tap **Next**. The device will automatically pair with the Bluetooth headset.

Windows Mobile will automatically try one of the preconfigured passcodes (0000, 1111, 8888, 1234) to pair the Bluetooth headset with the device. If this fails, you have to enter the passcode delivered with your headset manually.

Note *If the Bluetooth stereo headset becomes disconnected, turn the headset on and repeat step 1 to 2 in the previous steps. Tap and hold the name of the Bluetooth stereo headset and tap **Set as Wireless Stereo**.*

Beaming Information Using Bluetooth

You can beam information, such as contacts, calendar items, tasks, and files from your device to your computer or to another Bluetooth-enabled device.

Note *If your computer does not have built-in Bluetooth capability, you need to connect and use a Bluetooth adapter or dongle on your computer.*

To beam information from your device to a computer (Windows Vista or Windows XP SP2 [or higher] only):

1. Turn on Bluetooth on your device, and make your device visible. For information about this, see “Turning Bluetooth On and Making Your Device Visible.”
2. Set Bluetooth on your computer to visible mode, create a Bluetooth partnership, and then enable your computer to receive Bluetooth beams.

Note *If the Bluetooth adapter or dongle on your computer was installed using a third-party driver, open the Bluetooth software that came with the Bluetooth adapter or dongle and enable the adapter or dongle to be discovered by other devices. Refer to the Bluetooth adapter's documentation for more information.*

3. On your computer, open **Bluetooth Devices** from the Control Panel, and then click the **Options** tab on the **Bluetooth Devices** window.
4. For **Windows Vista**, select **Allow Bluetooth devices to find this computer**. For **Windows XP**, select **Turn discovery on** and **Allow Bluetooth devices to connect to this computer**.
5. Create a Bluetooth partnership between your device and computer. For information about creating a partnership, see “Bluetooth Partnerships” on page 90.
6. In the **Options** tab of **Bluetooth Devices**, select **Show the Bluetooth icon in the notification area**.
7. To enable your computer to receive Bluetooth beams, right-click the Bluetooth icon  in the notification area at the bottom right corner of your computer screen and select **Receive a File**. You are now ready to beam.
8. On your device, select an item to beam. The item can be an appointment in your calendar, a task, a contact card, or a file.
9. To beam a contact, tap **Menu > Send Contact > Beam**. To beam other types of information, tap **Menu > Beam [type of item]**.
10. Tap the device name to which you want to send the item.
11. If you beamed a calendar, task, or contact item to your computer and it is not automatically added to Outlook, select **File > Import and Export** in Outlook to import it.

To beam information to a Bluetooth-enabled device such as another Windows Mobile-powered device, follow steps 1 to 10 in the above procedure.

Tips

- The default folder on your computer where beamed items are stored may be *C:\Documents and Settings\your_username\My Documents* in Windows XP or *C:\Users\your_username\My Documents* in Windows Vista.
- For your device to receive Bluetooth beams, tap **Start > Settings > Connections tab > Beam** and make sure the **Receive all incoming beams** check box is selected.

Bluetooth Explorer and Bluetooth File Sharing

Bluetooth Explorer searches for other Bluetooth devices that have file sharing enabled and lets you access their Bluetooth shared folders. You can copy files from and to their shared folders, and create subfolders in those folders. When you enable **Bluetooth file sharing** on your device, other Bluetooth-enabled devices will also be able to access your Bluetooth shared folder.

To enable Bluetooth Explorer and Bluetooth file sharing on your device:

1. On the Home screen, slide to the **Settings** tab and then tap **Menu > Bluetooth Devices > FTP** tab.
2. Select the **Enable Bluetooth Explorer** check box. This makes the **Bluetooth** device folder visible in the File Explorer.
3. Select the **Enable File Sharing** check box. You can use the default Bluetooth shared folder, or tap **Browse** to use another folder as your shared folder.
4. Tap **ok**.

To use Bluetooth Explorer:

1. Bluetooth Explorer is integrated with the File Explorer program. You can open it by tapping **Start > Programs > Bluetooth Explorer** or by tapping the down arrow () on the upper left of File Explorer screen then tapping **Bluetooth**.
2. Bluetooth Explorer then scans for other Bluetooth devices that have file sharing enabled. From the list, tap to select a Bluetooth device you want to connect to. You may need to enter a passcode in order for you to connect to the selected device. If there are files contained in the other device's Bluetooth shared folder, you will be able to see those files on the Bluetooth Explorer screen.

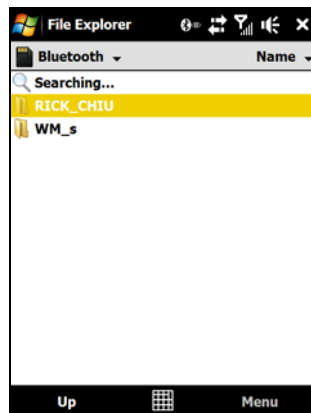

3. Select one or more files, and then tap **Menu > Edit** and choose to cut or copy the files.
4. Tap **Up** twice.
5. Navigate to the folder where you want to paste the files on your device, and then tap **Menu > Edit > Paste**.

Printing Files via Bluetooth

Connect your device to a Bluetooth printer to print contact information, appointment details, images, and other file types.

Notes

- You can print files in the .txt, .jpg, .xhtml, .vcf, .vcs file formats.
- To learn how to set up a Bluetooth printer, see “JETCET PRINT 5 (Wireless Printing Application)” on page 84

Before you start printing, make sure to turn on the Bluetooth printer and to turn on Bluetooth on your device. To turn on Bluetooth, tap **Start > Settings > Connections** tab > **Comm Manager**, and then tap the **Bluetooth** button.

Printing Contact Information

1. On the Home screen, slide to the **People** tab and then tap **All People**.
2. Select the contact whose information you want to print.
3. Tap **Menu > Print via Bluetooth > Menu > Search Devices**. Your device starts to search for Bluetooth devices.
4. Select the Bluetooth printer and tap **Menu > Send File**.
5. Set the printing options you want, and then tap **Print**.

Printing a Calendar Appointment

1. Tap **Start > Calendar**, and then select (highlight) the appointment whose details you want to print.
2. Follow steps 3 to 5 in “Printing Contact Information.”

Printing a JPEG File

1. In Pictures & Videos, locate the JPEG file you want to print.
2. Tap and hold the JPEG image file and then on the menu, tap **Print via Bluetooth**.
3. Follow steps 3 to 5 in “Printing Contact Information.”

Printing a Text File

1. In File Explorer, locate the text file you want to print.
2. Tap and hold the text file and then on the menu, tap **Print via Bluetooth**.
3. Follow steps 3 to 5 in “Printing Contact Information.”

Experiencing Multimedia

- ◆ *Taking Photos and Videos (page 94)*
- ◆ *Viewing Photos and Videos (page 103)*
- ◆ *Using Windows Media Player Mobile (page 109)*
- ◆ *Using Audio Booster (page 113)*
- ◆ *Using MP3 Trimmer (page 114)*

Your device's multimedia features give you the ability to capture full color digital pictures and videos, view your pictures and videos, and more. This section explains how to use these multimedia features.

Taking Photos and Videos

Use your device's built-in camera to take photos and record video clips.

To launch the camera:

- ▶ On the Home screen, slide to the **Photos and Videos** tab, and then tap the camera icon (). The screen orientation automatically switches to landscape mode when you launch.

Tip You can also tap **Start > Programs > Camera** to launch the camera.

To turn off the camera:

- ▶ Tap the **Exit** icon () on the camera screen. Tap the screen to show the camera screen icons.

Capture Modes

The camera on your device allows you to capture pictures and video clips by using various built-in modes that provide you flexibility in taking your shots.





To change the capture mode:

- ▶ Press the Navigation Control right or left (landscape orientation).
– or –

Tap the middle icon at the bottom of the screen (the icon displayed is based on the current capture mode). On the onscreen menu, tap the capture mode you want to use.



You can select from the following capture modes:



Icon	Capture mode
	Photo Captures standard still images.
	Video Captures video clips, with or without accompanying audio.
	Panorama Captures a sequence of still images continuously in one direction, and allows stitching of all the images to create a panoramic view of a scenery.
	Contacts Picture Captures a still image and gives you the option to immediately assign it as a Photo ID for a contact.
	Picture Theme Captures still images and places them within frames.

Supported File Formats

Using the available capture modes, the camera in your device captures files in the following formats:

Capture mode	Format
Photo / Contacts Picture / Picture Theme / Panorama	JPEG
Video	H.263 (.3gp) ; MPEG-4 (.mp4)

Using Auto-focus

The camera comes with an auto-focus function to let you capture sharp and crisp photos and videos of your subjects. Depending on the **Shoot Option** you have chosen, you will need to either touch or press the **Enter** key to activate auto-focus. When auto-focus is activated, it is indicated by a flashing white bracket (). When focus is set, the bracket changes to a steady green bracket ().

Note For more information about the different shoot options, see "Advanced Options" on page 101.

By default, you need to touch (do not press) the **Enter** key to activate autofocus, and then when focus is set, press the **Enter** key to take the shot or start capturing video. For example, in Photo mode, touch the **Enter** key to activate auto-focus; when focus is set, press the **Enter** key to take the shot.

Notes

- In Video mode, press the **Enter** key again to stop recording.
- In Picture Theme or Panorama mode, press the **Enter** key for each shot you need to take.

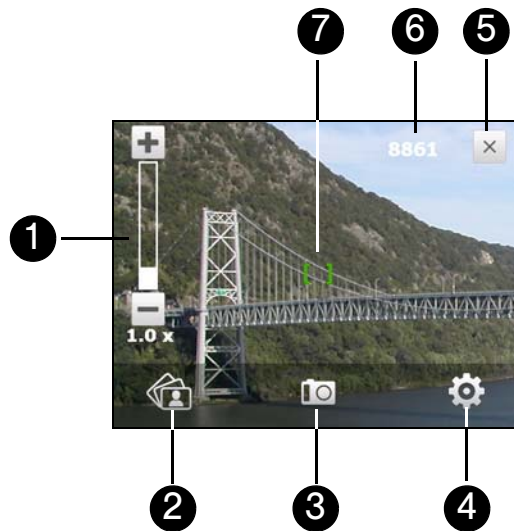

Onscreen Controls and Indicators

Tap the screen to display the controls and indicators.



1. **Zoom control.** Tap  to zoom in, or  to zoom out.

Tip You can also press the Navigation Control up or down (landscape orientation) or slide your finger clockwise or counterclockwise on the center Navigation Control to zoom in or out.

2. **Album.** Tap to open Album. See “Viewing Photos and Videos” for details.
3. **Capture mode.** Displays the current capture mode. Tap to open an onscreen menu where you can choose the capture mode.
4. **Menu.** Tap to open the camera settings screen. See “Menu Panel” for details.
5. **Exit.** Tap to turn off the camera.
6. **Remaining information indicator.** In Photo, Contacts Picture, Picture Theme, and Panorama modes, this shows the remaining/available shots of pictures based on the current settings.
In Video mode, this shows the remaining duration that can be recorded. While recording video, this shows the recorded duration.
7. **Auto-focus indicator.** Displays a flashing bracket () when focusing. When focus is set, the flashing bracket changes to a steady green bracket ().

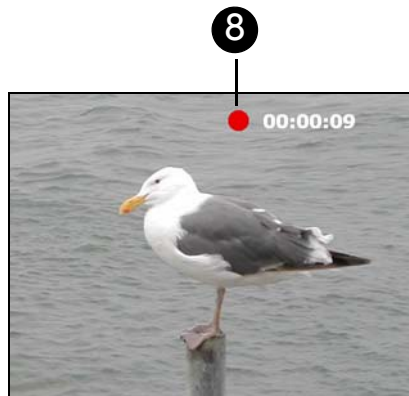

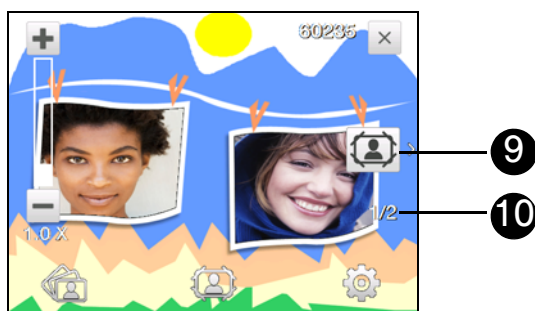

8. **Recording indicator.** Flashes when recording a video.









9. **Template Selector icon.** In Picture Theme mode, tap to toggle among different templates.
10. **Progress indicator.** In Picture Theme and Panorama modes, this shows the number of consecutive shots.

Menu Panel

The Menu Panel provides a quick way of adjusting most common camera settings and lets you access more advanced camera settings. On the camera screen, tap  to open the Menu Panel. To adjust a setting, keep tapping a button on the panel, for instance, Resolution, to cycle through the available settings. To access advanced options, tap **Advanced** ().

Note The available settings on the panel depend on the selected Capture mode.



1. **Flash Light.** Tap to turn the camera light that is located at the back of your device on or off. When the camera light is on, it will stay on until you turn it off or exit camera mode..
2. **Self-timer.** Tap to set the self-timer to **2 seconds**, **10 seconds**, or **Off** when in the Photo or Contacts Picture mode. When you press the **Enter** key to capture a still image, it starts to count down, and then captures a still image after the time expires.
3. **Advanced.** Tap to open the advanced camera settings. See “Advanced Options” for details.
4. **Brightness.** Tap to open the Brightness bar at the bottom of the screen. On the Brightness bar, tap  to decrease, or  to increase the brightness level. Tap outside the Brightness bar to apply the change.
5. **White Balance.** White balance enables the camera to capture colors more accurately by adjusting to different lighting conditions. White balance settings include:
 - Auto ()
 - Daylight ()
 - Night ()
 - Incandescent ()
 - Fluorescent ()

Zooming

Before capturing a photo or a video clip, you can zoom in to make the object in focus move closer, or zoom out to make the object move farther away.

To zoom in:

- ▶ Slide your finger around the Navigation Control clockwise, press the Navigation Control up (landscape orientation), or tap .

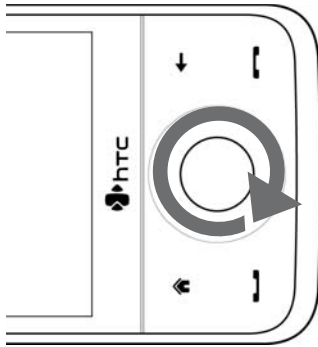





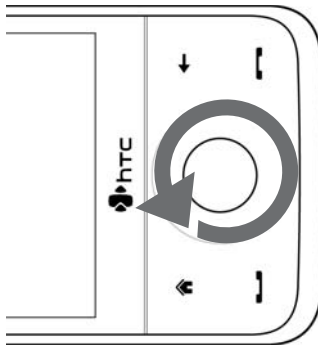







To zoom out:

- ▶ Slide your finger around the Navigation Control counterclockwise, press the Navigation Control down (landscape orientation), or tap .



The camera zoom range for a photo or a video clip depends on the capture mode and resolution. Refer to the table for more information.





Capture mode	Resolution	Zoom range
Photo	 3M (2048 x 1536)	1.0x to 2.0x
	 2M (1600 x 1200)	1.0x to 2.0x
	 1M (1280 x 960)	1.0x to 2.0x
	 Large (640 x 480)	1.0x to 2.0x
	 Medium (320 x 240)	1.0x to 4.0x
Video	 CIF (352 x 288)	1x and 1.5x
	 Large (320 x 240)	1x and 1.5x
	 Medium (176 x 144)	1x and 1.5x
	 Small (128 x 96)	1x and 1.5x
Panorama	 Large (640 x 480)	1x and 2x
	 Medium (320 x 240)	1x, 2x and 4x
Contacts Picture	 Medium (240 x 320)	1.0x to 4.0x
Picture Theme	Determined by the current template	Depends on the size of the selected template

The Review Screen

After capturing, the review screen lets you view, send, or delete the photo or video clip by tapping an icon at the bottom of the screen.



Review screen icons

Icon	Function
	Back. Return to the live camera screen.
	View. View the captured image or video in the Album program.
	Delete. Delete the captured image or video.
	Send. Send the captured image or video via email.
	Assign to Contact. After capturing in Contacts Picture mode, tap this icon to assign the photo to a selected contact.

Advanced Options

Advanced options let you adjust options for your selected capture mode and set camera preferences. Access the advanced options by tapping **Advanced** on the Menu Panel.

Navigating the Advanced Options Screen

- ▶ You can either tap onscreen or press the Navigation Control up or down (landscape orientation) to navigate through the advanced options screen.

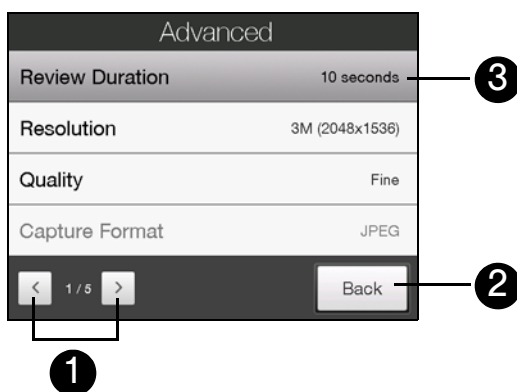

1. Tap the **Left and Right Arrows** to go through the different pages of settings.
2. Tap **Back** to go back to the live camera screen.
3. Tap an item to change the setting.

Settings on the Advanced Options Screen

- **Review Duration.** Set a time length for displaying the captured image or video on the review screen. Select **No Limit** if you do not want to impose a time limit. Select **No Review** to immediately return to the live camera screen after capturing and saving.
- **Resolution.** Select the resolution to use when taking photos or capturing videos.
- **Quality.** Select the JPEG image quality level for all captured still images. Choose from **Basic**, **Normal**, **Fine**, and **Super Fine**.
- **Capture Format.** Select the desired file format.
- **Time Stamp** (Photo mode). Choose whether to include the shooting date and time on captured photos.
- **Storage.** Select where you want to save your files. You can either save the files to the main memory or to the microSD card.
- **Keep Backlight.** Turn the backlight on or off. This overrides your device backlight settings while you are using the camera.
- **Shutter Sound.** Choose whether you want the camera to make a shutter sound when you press the **Enter** key.
- **Shoot Option.** The camera comes with an auto-focus feature that is activated when the **Enter** key is either touched or pressed.
 - **Touch and Press.** Requires you to touch the **Enter** key to activate the auto-focus; when focus is set, press the **Enter** key to take the shot.
 - **Touch.** Requires you to touch the **Enter** key to activate autofocus; when focus is set, the camera automatically takes the shot.
 - **Full Press.** Requires you to press the **Enter** key to activate auto-focus; when focus is set, the camera automatically takes the shot.

- **Image Properties.** This option lets you adjust the capture properties, such as *Contrast*, *Saturation*, and *Sharpness*.

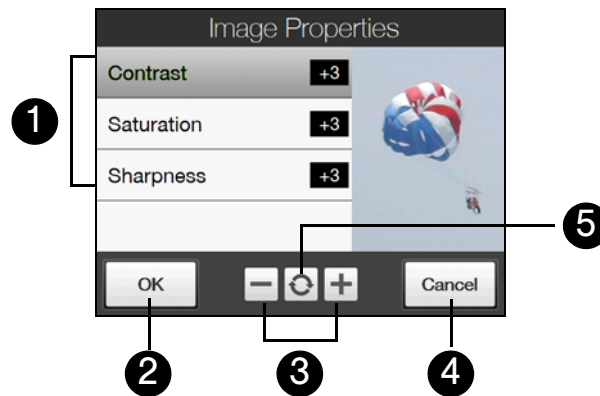

1. Tap a setting to adjust.
2. Tap *OK* to save the settings.
3. Tap \oplus or \ominus , or press the Navigation Control right or left (landscape orientation) to increase or decrease the value.
4. Tap *Cancel* to close the submenu without applying and saving the changes.
5. Tap the *Reset* icon to reset all properties to their default values.

- **Effect.** Choose a special effect such as Grayscale or Sepia to apply to your photos or video clips.
- **Metering Mode.** Select a metering mode to allow the camera to measure the amount of light and calculate the best-fit exposure value before capturing. Choose either *Center Area* to measure light using the center area of the subject, or *Average* to measure light using the area around the subject.
- **Prefix.** When *Default* is selected as the prefix, the file name of each new captured file is set to "IMAGE" or "VIDEO" followed by a sequential number, for example: IMAGE_001.jpg. You may also choose to name files using either the current *Date* or *Date & Time* as the prefix.

Note If you set the camera to save captured photos to a microSD card, the prefix cannot be selected. Captured photos will be named using the convention IMAGnnnn.jpg (where 'nnnn' is the counter) which is the DCIM (Digital Camera Images) naming standard, and will be saved to the \DCIM\100MEDIA folder on the microSD card.

- **Counter.** To reset the file naming counter back to 1, tap *Reset*.
- **Flicker Adjustment.** When taking indoor shots, flicker on the camera screen may be caused by inconsistencies between the vertical scan rate of the camera display and the flicker frequency of fluorescent lighting. To reduce flicker, you can change the flicker adjustment setting to the proper frequency (*50Hz* or *60Hz*) of the power in the country where your device is being used (60Hz throughout the United States).

- **Grid** (Photo mode). Choose whether to show a grid on the camera screen. Showing a grid helps you frame and center your subject easily and accurately.

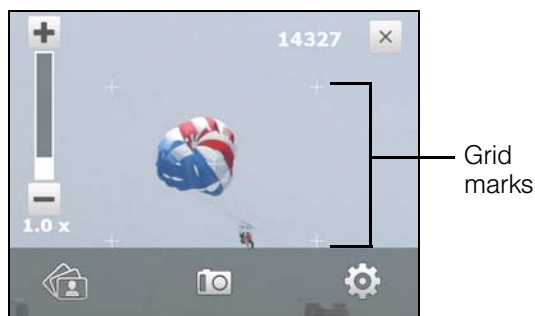

- **Record with Audio** (Video mode). Select **On** to record audio with the captured video clips, or select **Off** to capture video without audio.
- **Template** (Picture Theme mode). Select a template.
- **Recording Limit** (Video mode). Set the maximum duration or file size for recording video.
- **Template Folder** (Picture Theme mode). By default, templates are stored in the **My Documents\Templates** folder on the device's **Main Memory**. If you transferred some templates to the microSD card (via File Explorer), set this option to **Main + Card** to specify that templates are located in both the main memory and the microSD card.
- **Show Reminder** (Contacts Picture mode). Select **On** if you want the camera to always display a message that confirms whether to assign the captured picture to a contact.
- **Help**. Tap to display the camera help.
- **About**. Tap to display version and copyright information.

Viewing Photos and Videos

Album offers a host of features that let you rotate images, view your images as a slideshow, use images as contact pictures, and more.

Note Album can only display files in the BMP, GIF, PNG, JPG, Animated GIF, 3GP, MP4, and WMV formats.

Launching Album

To open Album:

- ▶ On the Home screen, slide to the **Photos and Videos** tab and tap **Album**.
 - or –
 - Tap **Start > Programs > Album**.
 - or –
 - On the camera screen, tap .

Note When you open Album from the camera, the screen orientation of Album is switched to landscape mode.

To launch the camera from the Album program:

- ▶ On the main Album screen, tap the camera icon.

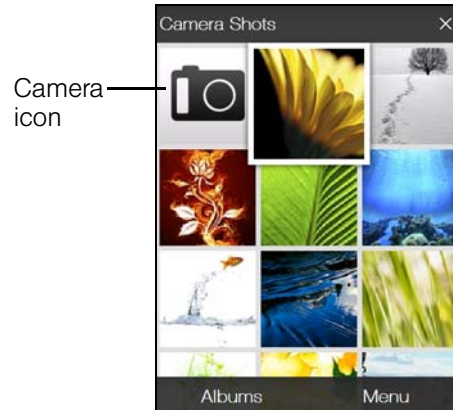





Selecting a Photo or Video to View

1. On the main Album screen, tap **Albums** and then select the album to view. The contents of the album are then displayed on the main Album screen.
2. Browse through the files by sliding your finger upward or downward.
3. Do one of the following:
 - Tap an image to view it in full-screen mode. See “Viewing an Image” below for details.
 - Tap a video file (files with the  icon) to play back the video file. See “Playing Back Video” on page 108 for details.
 - Select a still image and then tap **Menu > Slideshow** to view the images in the album as a slideshow. Animated GIF and video files will not be played back in the slideshow. See “Viewing Still Images as a Slideshow” on page 107 for details.

Viewing an Image

While viewing an image in full-screen mode, tap the screen or press the **Enter** key to open the onscreen menu.



Icon	Function
	Back. Return to the main Album screen, <i>Photos and Videos</i> tab, or the camera screen.
	Slideshow. Start a photo slideshow.
	Send. Send the photo using one of the Messaging accounts.
	Menu. Open a menu where you can save the screen image as a photo for a contact, save the current image as a new file, delete the image, and view file properties

Tip You can delete multiple files at once by selecting **Menu > Delete Items** on the main Album screen and then selecting the files to delete.

To rotate the image:

While viewing images, you can automatically rotate the image by simply turning your device sideways.



To view the next or previous image:

When viewing images in portrait or landscape mode, go to the next image by swiping your finger across the screen from right to left. Go back to the previous image by swiping your finger from left to right.



To zoom in or out of an image:

While viewing an image, make a full circle motion on the screen with your finger.

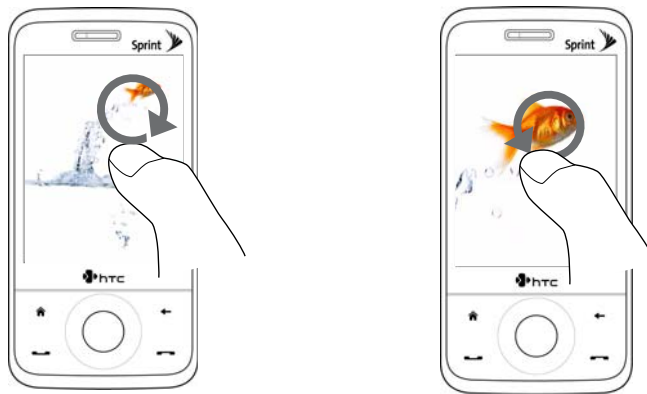

Slide your finger clockwise on an area to zoom in on that area.

Slide your finger counter-clockwise to zoom out.

Tips





- When you zoom in on an image, double tap the screen to automatically zoom out and fit the image to the screen.
- When you zoom in on an image, tap and hold the screen so you can pan the image.
- You can also zoom in and out of the image by sliding your finger around the Navigation Control clockwise or counterclockwise, respectively.
- When you zoom in on an image, tap the screen to open the onscreen menu. On the onscreen menu, tap  and then select **Save Screen Image** to save the image onscreen as a new file.

Viewing Still Images as a Slideshow

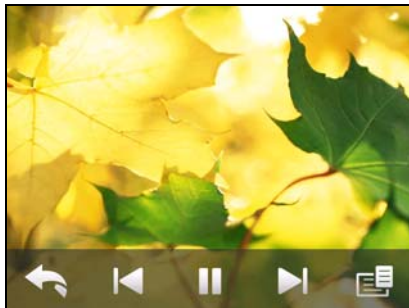
While viewing the slideshow, tap the screen to show playback controls.

Tip The screen orientation automatically switches to landscape mode when viewing a slideshow.



Icon	Function
	Back. Return to the main Album screen or the <i>Photos and Videos</i> tab.
	Previous. Go back to the previous photo.
	Play/Pause. Play or pause the slideshow.
	Next. Go to the next photo.
	Menu. Open a menu where you can change slideshow options, such as set the transition effect to use, time per slide, and orientation of the images.

Tip If the images are in your favorite album, you can start the slideshow from the *Photos and Videos* tab on the Home screen. On the *Photos and Videos* tab, tap *Slideshow*.

Playing Back Video

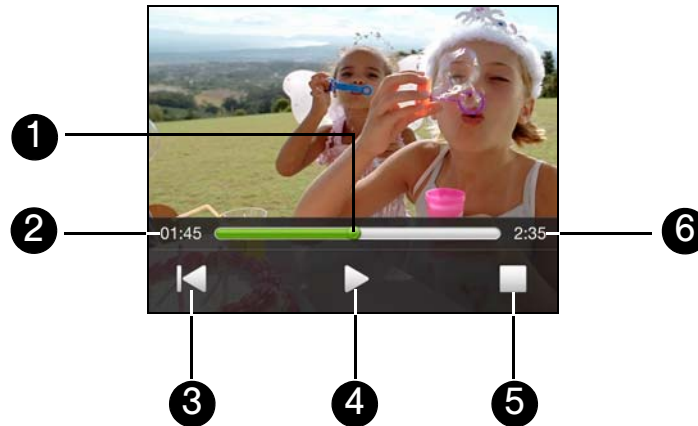

While playing back video, tap the screen to show the playback controls.



1. Drag on the **Slider Bar** to go forward or backward in the video.
2. Shows the elapsed time.
3. Tap the **Rewind** icon to go back to the beginning of the video.
4. Tap the **Play/Pause** icon to play or pause the video playback.
5. Tap the **Stop** icon to stop playing the video.
6. Shows the total duration.

Tip If the video is in your favorite album, you can start the video playback from the **Photos and Videos** tab on the Home screen. On the **Photos and Videos** tab, tap **Play**.

Closing Album

Close Album by tapping  on the main Album screen. When viewing files in full-screen mode, tap the screen to show the onscreen menu or playback controls and then tap  to go back to the main Album screen.

Using Windows Media Player Mobile

Windows Media® Player Mobile plays digital audio and video files that are stored on your device or on a network, such as on a Web site. This section shows you how to use Windows Media Player Mobile.

To open Windows Media Player Mobile:

- ▶ Tap *Start > Programs > Windows Media*.

Supported File Formats

Video File Formats Supported	File Extensions
Windows Media Video	.wmv, .asf
MPEG4 Simple Profile	.mp4
H.263	.3gp, .3g2
H.264	.mp4, .3gp, .3g2, .m4v
Motion JPEG	.avi

Audio File Formats Supported	File Extensions
Windows Media Audio	.wma
WAVE	.wav
MP3	.mp3
MIDI and SP MIDI	.mid, .midi, .rmi
AMR Narrow Band	.amr, .3gp
AMR Wide Band	.awb, .3gp
AAC, AAC+, and eAAC+	.aac, .mp4, .m4a, .3gp
MPEG4 audio	.m4a
QCELP	.qcp, .3g2
EVRC	.qcp

About the Controls

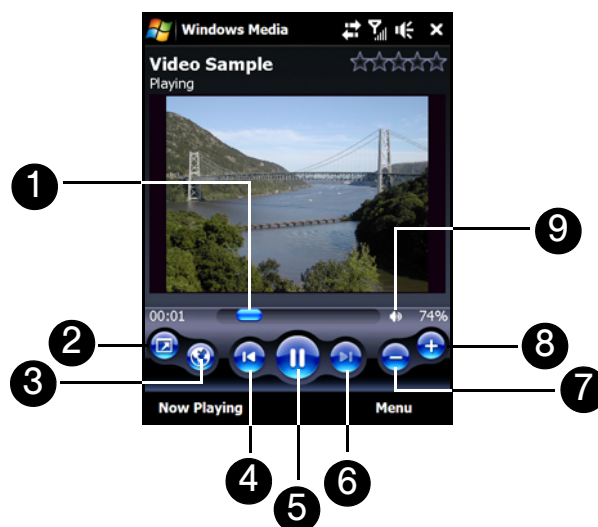

1. Drag on the *Slider Bar* to jump to any part of the video or audio.
2. Tap the *Full Screen* icon to play video in full-screen mode.
3. Tap the *Internet* icon to launch the Web browser and go to the WindowsMedia.com Web site.
4. Tap the *Previous* icon to skip to the beginning of the current file or to the previous file.
5. Tap the *Play/Pause* icon to play or pause the video/audio.
6. Tap the *Next* icon to skip to the next file.
7. Tap the *Minus* icon to decrease volume.
8. Tap the *Plus* icon to increase the volume
9. Tap the *Sound* icon to mute or unmute sound.

Windows Media Player Mobile has three primary screens:

- **Playback screen.** The screen that displays the playback controls (such as Play, Pause, Next, Previous, and Volume) and the video window. You can change the appearance of this screen by choosing a different skin.
- **Now Playing screen.** The screen that displays the Now Playing playlist. This special playlist indicates the current file being played and any files that are “queued up” to play next.
- **Library screen.** The screen that lets you quickly find your audio files, video files, and playlists. It contains categories such as My Music, My Videos, My TV, and My Playlists.

At the bottom of each screen, you can open a *Menu*. The commands on this menu vary, depending on which screen you are viewing. For more information about the commands in these menus, see Help on your device.

Synchronizing Video and Audio Files

Use the latest version of Windows Media Player on your computer to synchronize digital media files from your computer to your device. This ensures that protected files and album art (for skins) are copied to your device correctly.

Synchronizing Content to Your Device Automatically

1. On your computer, open Windows Media Player, and then connect your device to your computer.
2. In the Device Setup Wizard, select **Yes, search my computer now**.

Note If you have previously opened Windows Media Player and searched for media on your computer, you will not be prompted to search your computer.

3. On the Device Setup dialog box, enter a name for your device and click **Finish**. Windows Media starts synchronizing the music files in the computer with the device.
4. Click **Stop Sync** and then on the left panel of Windows Media Player, right-click the name of your device and click **Set Up Sync**.
5. Select the playlist(s) that you want to sync between your computer and device, and then click **Add**.

Note On the Device Setup dialog box, make sure that the **Sync this device automatically** check box is selected.

6. Click **Finish**.

The files will begin synchronizing to your device. The next time you connect your device to your computer while Windows Media Player is running, synchronization will start automatically.

Synchronizing Content Manually to Your Device

1. If you have not set up media synchronization between your device and computer, follow steps 1 to 3 in "Synchronizing Content to Your Device Automatically."
2. Click the **Sync** tab on the Windows Media Player of your computer. Select a Playlist or a Library on the left panel of the Windows Media Player.
3. From the Content List, drag the media files that you want to sync to your device and drop them to the Sync List.



1	Playlists and Library List
2	Content List
3	Sync List

4. Click **Start Sync** to start synchronizing the selected files to your device.

Notes

- Use Windows Media Player 11 or higher on your computer to synchronize media files to your device.
- Audio files copy faster if Windows Media Player is configured to automatically set the quality level for audio files copied to your device. For more information, see the Windows Media Player Help.

Playing Media

Use the Library to find and play songs, videos, and playlists that are stored on your device or microSD card.

To update the Library:

1. If you are not on the Library screen, tap **Menu > Library**.
2. On the Library screen, tap the Library arrow (near the top of the screen), and then tap the media storage that you want use, for example, storage card.
3. In most cases, Windows Media Player Mobile automatically updates the library. However, you can manually update the library to ensure that it contains new files that you recently copied to your device or microSD card. Tap **Menu > Update Library** to manually update the library list.

To play video and audio files on your device:

1. Select a category (for example, My Music or My Playlists).
2. Tap and hold the item that you want to play (such as a song, album, or artist name), and then tap **Play**.

Tips

- To play a media file that is stored on your device but is not in a library, on the Library screen, tap **Menu > Open File**. Tap and hold the item that you want to play (such as a file or a folder), and then tap **Play**.
- To play a media file from the Internet or a network server, tap **Menu > Library** then tap **Menu > Open URL**.

Playlists

In Windows Media Player Mobile, you can create a new playlist by saving the current Now Playing playlist and giving it a new name.

To save a new playlist:

1. If you are not on the Library screen, tap **Menu > Library**.
2. Tap to select a category (for example, My Music or My Playlists).
3. Select a media file that you want, and then tap **Menu > Queue Up**. This adds the file to the Now Playing list. Repeat this step until you have added all desired media files to the Now Playing list.

Note

You cannot select multiple files at the same time.

4. After adding the media files, tap **Menu > Now Playing**.
5. On the Now Playing screen, tap **Menu > Save Playlist**.
6. Enter the playlist name, and then tap **Done**.
7. To play back the playlist you created, tap My Playlists in the Library, select your playlist, and then tap **Play**.

Troubleshooting

If you encounter a problem while using the Windows Media Player Mobile, see the Troubleshooting Windows Media Player Mobile page at the Microsoft Web site: (<http://www.microsoft.com/windows/windowsmedia/player/windowsmobile/troubleshooting.aspx>).

Using Audio Booster

Audio Booster optimizes sound for a better listening experience. It provides preset moods, such as hip-hop, jazz, and rock, and several enhancement presets that suit different types of music.

To access **Audio Booster**:

- ▶ Tap **Start > Programs > Audio Booster**.

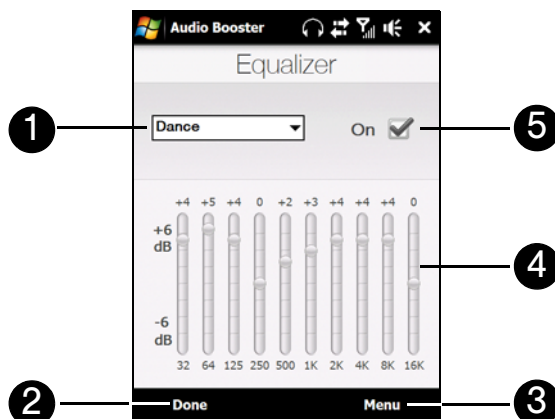

Control	Use
1 Equalizer Presets	Tap to choose the Equalizer preset to use.
2 Done	Tap to apply the modified settings.
3 Menu	<ul style="list-style-type: none"> ● Tap Menu > Cancel to exit Audio Booster without applying the modified settings; ● Tap Menu > Save as Preset or Delete Preset to save or delete preset equalizer settings.
4 Frequency Band	Drag the sliders to adjust the frequency.
5 On	Select the check box to enable or disable the equalizer.

To use an **Equalizer preset**:

- ▶ Tap the list box and then select a desired preset.

To create a custom equalizer preset:

1. Adjust the frequency bands to desired values by dragging the equalizer controls. The selected values are indicated on top of the sliders.
2. Save equalizer settings as a preset by tapping **Menu > Save as Preset**.
3. Enter a preset name and then tap **Done**. The preset you created will be added to the list box.

To delete a custom equalizer preset:

1. Tap the list box and then select the Equalizer preset you want to delete.
2. Tap **Menu > Delete Preset**.

Note You can only delete custom equalizer presets. Equalizer presets that are preinstalled cannot be deleted.

Using MP3 Trimmer

Use *MP3 Trimmer* to trim MP3 files. You can choose to save a trimmed file as a new file or set it as a ring tone.

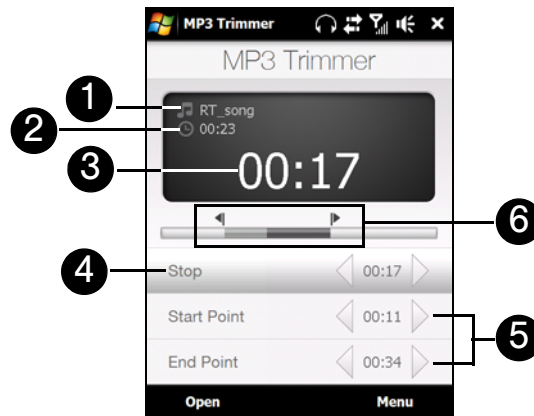

1. Shows the title of the MP3 file.
2. Shows the duration of the trimmed portion.
3. Shows the elapsed playback time.
4. Tap **Play** to start playback, or tap **Stop** to end the playback.
5. For more precise trimming, you can also tap the **Start Point** and **End Point** controls to step backward and forward in one-second increments.
6. The two arrows are the Mark in and Mark out points in the music. Use them to mark the part of the music that will be used as the new file or ring tone. Drag the left arrow to mark the start time (**Start Point**), and then drag the right arrow to mark the end time (**End Point**).

To trim the MP3 file:

1. Tap **Start > Programs > MP3 Trimmer**.
2. Tap **Open** to find an MP3 file.
3. On the MP3 Trimmer screen, use the stylus to adjust the Mark in and Mark out points.
 - After you set the Mark in point, the song will play back starting from the Mark in point.
 - After you set the Mark out point, the song will play back starting from five seconds before the Mark out point.
4. Tap **Play** to play back the trimmed song.
5. Tap **Menu** and select to whether set the file as the default ring tone, save the file to the ring tone folder, or save it using another file name.

Tip

*If you only want to save the song to the ring tone folder for future use, tap **Save to Ring Tone Folder**. Later on, you can tap **Start > Settings > Personal tab > Phone** to set it as your ring tone.*

Managing Your Device

- ◆ *Copying and Managing Files (page 115)*
- ◆ *Settings on Your Device (page 116)*
- ◆ *Changing Basic Settings (page 119)*
- ◆ *Using Task Manager (page 122)*
- ◆ *Connecting to an External Display (page 123)*
- ◆ *Protecting Your Device (page 124)*
- ◆ *Managing Memory (page 125)*
- ◆ *Adding and Removing Programs (page 125)*
- ◆ *Resetting Your Device (page 126)*
- ◆ *Windows Update (page 127)*
- ◆ *Using the Strap Holder (page 128)*

You can customize your device to sound, look, and operate just the way you want it to. This section describes how to customize your device to best suit your needs.

Copying and Managing Files

You can copy files between your device and computer, or copy files to the microSD card of your device. You can also efficiently manage your files and folders using File Explorer.

To copy files using Windows Mobile Device Center or ActiveSync:

1. Connect your device to the computer.
2. Click **File Management** > **Browse the contents of your device** in Windows Mobile Device Center on your computer, or click **Explore** in ActiveSync on your computer. This opens Windows Explorer on your computer and displays the contents of your device.
3. To copy a file from your device to your computer, browse the contents of your device, right-click the file you want to copy, and then click **Copy**.
Right-click a folder on your computer, and then click **Paste**.
4. To copy a file from your computer to your device, browse the folders on your computer, right-click the file you want to copy, and then click **Copy**.
Right-click a folder on your device, and then click **Paste**.

To manage files on your device using File Explorer:









File Explorer lets you browse and manage the contents of your device. The root folder on the device is named **My Device**, and contains the following folders: My Documents, Program Files, Windows, and more.

1. Tap **Start** > **Programs** > **File Explorer** and then tap a folder or file to open it.
2. To return to an upper level folder, tap **UP** and select the folder.
3. To quickly delete, rename, or copy a file, tap and hold the file, and then choose the desired operation on the shortcut menu. To copy or delete multiple files, tap and drag over the desired files to select, tap and hold the selection, and then choose the desired operation on the shortcut menu.



















Settings on Your Device

You can adjust the device settings to suit the way you work. To access all available settings, slide to the **Settings** tab on the Home screen and tap **All Settings**. This section describes about the various settings that you will find on your device.









Personal Tab

Icon	Description
	Buttons Assign a program or function to a hardware button.
	Input Set options for each of the input methods.
	Lock Set a password for your device.
	Menus Set which programs will appear in the Start menu.
	Owner Information Enter your personal information on your device.
	Phone Customize phone settings such as ring tone, ring type, services, and other phone options.
	Sounds & Notifications Enable sounds for events, notifications, and more, and set the type of notification for different events.
	Today Customize the appearance and the information to be displayed on the Home screen.
	Voice Command Choose which functions you want to access with voice commands.









System Tab

Icon	Description
	About See basic information such as the Windows Mobile® version and type of processor used on your device. You can also specify a name for your device.
	Certificates See information about certificates that are installed on your device.
	Clear Storage Reset your device to factory default settings.
	Clock & Alarms Set the device clock to the date and time of your locale or to a visiting time zone when you're traveling. Alarms can also be set at specified days and times of a week.
	Customer Feedback Send feedback to the Customer Experience Improvement Program of Microsoft.
	Device Information See information about the firmware version, hardware, identity, and the duration of calls made on your device.
	Encryption Encrypt files on your storage card. Encrypted files will only be readable on your device.
	Error Reporting Enable or disable the device's error reporting function. When this function is enabled and a program error occurs, technical data about the state of the program and your computer will be logged in a text file and delivered to Microsoft's technical support if you choose to send it.
	External GPS Set the appropriate GPS communication ports, if required. You may need to do this when there are programs on your device that access GPS data or you have connected a GPS receiver to your device. See Help for details.
	G-Sensor Recalibrate the G-Sensor of the device. Use when autorotate or the Teeter game is not working properly. .
	Key Lock Lock the buttons on your device except for the Power key when the device is in Sleep mode. This ensures you will not switch the device on by accident and consume unnecessary power.
	Long Press End Key Choose the desired function to be executed (for instance, lock the device) when pressing and holding the End key.
	Managed Programs Displays the programs that were installed on your device using System Center Mobile Device Manager.
	Memory Check the device memory allocation status and storage card information.
	Microphone AGC Adjust the volume of your voice automatically when you are recording.
	Power Check the remaining battery power. You can also set the brightness of the backlight and timeout for turning off the display (switching device to Sleep mode) to conserve battery power.
	Regional Settings Set the regional configuration to use, including the format for displaying numbers, currency, date, and time on your device.
	Remove Programs Remove programs that you installed on your device.

System tab (continued)

Icon	Description
	Screen Recalibrate the screen, apply ClearType, and change the screen text size.
	Task Manager Stop running programs and set the () button to end programs immediately when you tap the button. For more information, see “Using Task Manager” on page 122.
	Text Messaging Configure the text message inbox as Threaded mode or Classic mode.
	TouchFLO You can enable or mute the finger scrolling and panning sound. You can also enable or disable the large Start menu, and choose to show or hide the System Status screen when title bar icons are tapped.
	Update PRL Download the most recent Preferred Roaming List.
	Update Profile Renew or establish information needed to access network voice or data services.
	Video Out Set the video format to use when outputting to an external display.
	Windows Update Link to Microsoft's Web site and update Windows Mobile on your device with the latest security patches or fixes, if they are available.

Connections Tab

Icon	Description
	Beam Set your device to receive incoming Bluetooth beams.
	Bluetooth Turn Bluetooth on, set your device to visible mode, and scan for other Bluetooth devices.
	Comm Manager Manage your device's connections (including data connection and Bluetooth), turn the phone on or off, and enable or disable the Direct Push function.
	Connections Set up one or more types of modem connections for your device, such as phone dial-up, and more, so that your device can connect to the Internet or a private local network.
	Domain Enroll Enroll your device in your company's domain to let System Center Mobile Device Manager to manage the device. Please ask your Server Administrator for more details.
	USB to PC Set the type of USB connection to your PC. Select the ActiveSync option for synchronizing data, or use Disk Drive mode for transferring files.
	Wi-Fi Scan for available wireless networks.
	Wireless LAN See information about the active wireless network, and customize Wi-Fi settings.

Changing Basic Settings

Date and Time

To set the date and time:

1. On the Home screen **Home** tab, tap the time display and then tap the **Time** tab.

Tip Tap the **More** tab and select the **Display the clock on the title bar in all programs** option to show the clock on all screens.

2. Select the correct time zone and change the date or time.

Note During synchronization, the time on your device is updated with the time on your computer.

To set the date and time for a different location:

If you visit or communicate with someone in a particular time zone often, you can select it as your visiting time zone.

1. On the Home screen **Home** tab, tap the time display and then tap the **Time** tab.
2. Tap **Visiting**.
3. Select the correct time zone and change the date or time.

Regional Settings

The style in which numbers, currency, dates, and times are displayed is specified in regional settings.

1. On the Home screen, slide to the **Settings** tab and then tap **All Settings**.
2. On the **System** tab, tap **Regional Settings > Region** tab and then select your region from the list. The region you select determines which options will be available on the other tabs.

Note This does not change the language of your device's operating system.

3. To customize regional settings further, tap the appropriate tabs and set the desired options.

Display Settings

To adjust the screen brightness:

1. On the Home screen, slide to the **Settings** tab and then tap **All Settings**.
2. On the **System** tab, tap **Power > Backlight** tab.
3. Adjust the brightness by dragging the slider under **On battery power** and **On external power**.

To set the backlight to dim after a time delay:

1. On the Home screen, slide to the **Settings** tab and then tap **All Settings**.
2. On the **System** tab, tap **Power > Advanced** tab.
3. In **On battery power** and **On external power**, select the **Turn off backlight if device is not used for** check box, and then specify the time delay.

To increase or decrease the size of text on the screen:

1. On the Home screen, slide to the **Settings** tab and then tap **All Settings**.
2. On the **System** tab, tap **Screen > Text Size** tab. Move the slider to increase or decrease the text size.

Device Name

The device name is used to identify your device in the following situations:

- Synchronizing with a computer
- Connecting to a network
- Restoring information from a backup

Note If you synchronize multiple devices with the same computer, each device must have a unique name.

To change the device name:

1. On the Home screen, slide to the **Settings** tab and then tap **All Settings**.
2. On the **System** tab, tap **About > Device ID** tab.
3. Enter the device name.

Notes

- The device name must begin with a letter, consist of letters from A to Z, numbers from 0 to 9, and cannot contain spaces. Use the underscore character to separate words.
- If you enroll your device to your company's domain, the device name will be changed to be the same as the one used to enroll the device.

Ringer Settings

To change the ring type and ring tone :

1. On the Home screen, slide to the **Settings** tab and then tap **Sound**.
2. Scroll down and then tap **Ring Type**. Select the Ring Type you want to use and then tap **Done**.
3. Tap **Ringtone** and then select the ringtone you want to use.
4. Tap **Done**.

Tips

- You can use *.wav, *.mid, *.mp3, *.wma, or other types of sound files that you downloaded from the Internet or copied from your computer as ring tones. For a complete list of supported audio file formats for ring tones.
- To use your sound files as ring tones, copy them first to the /My Documents/My Ringtones folder on your device, and then select the sound from the **Ring tone** list of your device. For more information about copying files, see "Copying and Managing Files" on page 115.

Alarms and Notifications

To set an alarm:

1. On the Home screen **Home** tab, tap the time display and then tap the **Alarms** tab.
2. Tap **<Description>** and enter a name for the alarm.
3. Tap the day of the week for the alarm. Select multiple days by tapping each desired day. Tap again to deselect the day.
4. Tap the time to open a clock and set the time for the alarm.

Tip You can drag the hour and minute hands of the clock to set the time.

5. Tap the alarm icon () to specify the type of alarm you want. You can choose a flashing light, a single sound, a repeating sound, or vibration.
6. If you choose to play a sound, tap the list next to the **Play sound** check box and tap the sound you want.

To choose how to be notified about events or actions:

1. On the Home screen, slide to the **Settings** tab and then tap **Sound > Advanced**.
2. On the **Sounds** tab, choose how you want to be notified by selecting the appropriate check boxes.
3. On the **Notifications** tab, in **Event**, tap an event name and choose how you want to be notified by selecting the appropriate check boxes. You can choose from several options, such as a special sound, a message, or a flashing light.

Tips

- Turning off sound notifications helps conserve battery power.
- The types of notifications that can be enabled depend on the event. For instance, only **Play sound** and **Vibrate** notifications can be enabled if it is an ActiveSync event.
- Flashing light notification is either enabled or disabled, depending on the type of event. This setting is preconfigured and cannot be changed.

Phone Services

Additional phone service options can be easily configured on your device.

To access and change settings of phone services:

1. On the Home screen, slide to the **Settings** tab and then tap **All Settings**.
2. On the **Personal** tab, tap **Phone > Services** tab.
3. Select the service you want to use, and then tap **Get Settings**.
4. Choose your desired options, and then tap **ok**.

The following are some of the phone services that you can configure for your device:

Phone Services	Usage
Location Setting	Allow the mobile phone network to detect your current location via your device's built-in GPS chip. This is especially useful in times of emergency.
Roaming	To better control roaming costs, you can set your device to roam only on certain networks. The Data Roam Guard also helps you to manage your roaming costs.
TTY Mode	Allow the use of a TTY (teletypewriter) device with the smart device phone for users who are visually or hearing impaired. Choose one of the following modes, depending on the operation mode that is supported by the TTY device: <ul style="list-style-type: none"> ● Full mode: Send and receive text during an ongoing call. ● VCO mode: Voice Carry Over mode, which allows users to send voice and receive text during an ongoing call. ● HCO mode: Hearing Carry Over mode, which allows users to send text and receive voice during an ongoing call. ● Off: Disable TTY mode, and send and receive voice during an ongoing call.
Time Synchronization	Allow the system time on your device to be synchronized with the time information of the mobile phone network.
Plus Code Dialing	This allows easy dialing when making international calls.
Roaming Alert	Enable sound alerts on your device so that you can be notified when your device enters or goes out of the network coverage area. By default, alert notification is disabled.

For more information about customizing settings of phone services, see Help on your device.

Using Task Manager

Task Manager lets you view and stop running programs, configure the  button, and enable the Quick Menu on the Home screen.

To open Task Manager:

- ▶ Tap the **Quick Menu** button on the top right corner of the Home screen to open the Quick Menu, and then tap .
- or –

On the Home screen, slide to the **Settings** tab and then tap **All Settings**. On the **System** tab, tap **Task Manager**.

To switch back to a running program:

- ▶ Tap the program name in the Quick Menu.
- or –



On the Task Manager screen, tap and hold the program name on the **Running** tab, and then tap **Activate**.

To configure the Exit button:

You can configure the **Exit** button () to shut down running programs when the button is tapped, or to just temporarily close the program screen but keep the program running.

1. On the Task Manager screen, tap the **Button** tab.
2. Select the **Enable the “X” button to end running programs** check box.

Note When the **Enable the “X” button to end running programs** check box is not selected, tapping the **Exit** button will only close a program screen. The program is not ended and continues to run in the background.

3. Choose the action for shutting down programs (by tapping the  button, or by tapping and holding the  button).
4. Tap **ok**.

To close running programs from the Task Manager:

1. On the Task Manager screen, tap the **Running** tab.
2. Do one of the following:
 - Select the check box of the programs that you want to close, and then tap **Stop Selected**.
 - Tap **Stop All** to close all programs in the list.
 - Tap **Menu > Stop All but Selected** to close all programs except those which check boxes are selected.

Tip You can also close running programs from the Quick Menu on the Home screen. See “Quick Menu” on page 23 for details.

To add a running program to the exclusive list:

If you add a running program to the **Exclusive Programs List**, it will not be closed when you tap **Stop Selected** or **Stop All** and will not be listed in the Quick Menu on the Home Screen.

1. On the Task Manager screen, tap the **Running** tab.
2. Tap and hold the program name, and then tap **Add Exclusive**.

Tip To remove a program from the exclusive list, tap the **Exclusive** tab, select the check box of the program, and then tap **Remove**.

To set the sorting preference and program icon size in the Quick Menu:

1. On the Task Manager screen, tap the **Others** tab.
2. In **Sort programs in Quick Menu by**, choose whether to sort according to **Program name** or **Memory usage**. The list will be sorted in ascending order.
3. In **Program icon size in Quick Menu**, choose whether to use **Small size** or **Large size**.

Connecting to an External Display

The Video Out function allows you to view your device's onscreen content on an external display (such as a television) that has composite jacks and uses a standard RCA connection cable.

Important The Video Out feature cannot be used with Sprint TV.

- Notes**
- You need a Video Out cable accessory to be able to connect your device to an external display. The Video Out cable accessory is sold separately.
 - When you plug in the Video Out cable accessory to your device, you will not be able to play music files from the TouchFLO 3D Sprint Music tab.
 - It is recommended that you use an audio accessory (not the Video Out cable accessory) such as the wired headset when you want to listen to music on your device.

To connect the device to an external display:

1. Turn off the external display.
2. Connect the ends (red, white, and yellow RCA plugs) of the Video Out cable accessory to the corresponding jacks on the external display.

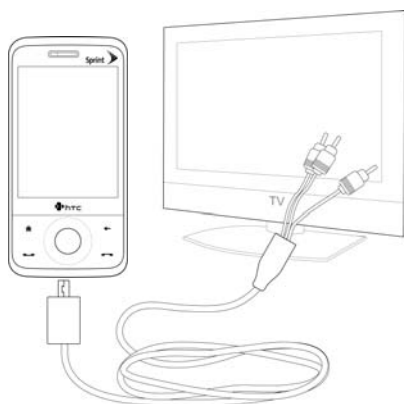

3. Plug the other end of the Video Out cable accessory into your device's sync connector. The Video Out screen opens.

Note The display automatically changes to landscape mode after connecting the Video Out cable accessory.

4. Choose **NTSC** and then tap **Done**.

Note If you need to change the video format option again, tap **Start > Settings > System tab > Video Out**

5. Select the type of media you want to output.
6. Turn on the external display and then switch it to the input signal where you connected your device (for example, Video 1).

Protecting Your Device

You can help keep your data more secure by requiring a password every time the device is turned on.

To set a device password:

1. On the Home screen, slide to the **Settings** tab and then tap **All Settings**.
2. On the **Personal** tab, tap **Lock**.
3. Select the **Prompt if device unused for** check box, and then specify the idle time before the device requires a password.
4. In the **Password type** box, select the type of password you would like to use.

Tip If your device is configured to connect to a network, use an alphanumeric password for increased security.

5. Enter the password in both the **Password** and **Confirm** boxes.
6. Tap **ok**. The next time the device is turned on, you will be prompted to enter your password.

Notes

- To ensure that you can always make emergency calls, do not begin your password with the digits of your local emergency number.
- If you entered a hint, the hint will be displayed after the wrong password is entered five times.
- Each time a wrong password is entered, the device response time gets longer until the device appears to be not responding.
- If you forget your password, you can hard reset or clear the device memory. Before you do this, make sure you back up your data and files so that you can restore them back to your device. For more information about hard resetting the device and clearing the memory, see "Resetting Your Device" on page 126.

Managing Memory

To see how much memory is available for use:

1. On the Home screen, slide to the **Settings** tab and then tap **All Settings**.
2. On the **System** tab, tap **Memory > Main** tab. The amount of memory allocated to data storage versus program storage is displayed, as well as the amount of memory in use versus the available memory.

Adding and Removing Programs

Additional programs that you purchased can be installed and uninstalled on your device. Your device does not allow you to uninstall most of the preinstalled programs.

Note Before you purchase additional programs for your device, make sure that they are compatible with your device.

To install a program:

1. Download the program to your computer (or insert the CD or disk that contains the program into your computer).
 - You may see a single ***.exe** file, a ***.zip** file, a **Setup.exe** file, or several versions of files for different device types and processors. Be sure to select only the programs designed for your device.
2. Read any installation instructions or documentation that comes with the program. Many programs provide special installation instructions.
3. Connect your device to the computer.
4. Double-click the installation setup file.

To uninstall a program:

1. Tap **Start > Settings > System** tab > **Remove Programs**.
2. In the **Programs in storage memory** list, select the program you want to remove, and then tap **Remove**.

Resetting Your Device

Soft Reset

Occasionally, you may need to reset your device. A soft (or normal) reset of your device clears all active program memory and shuts down all active programs. This can be useful when your device is running slower than normal, or a program is not performing properly. A soft reset is also necessary after the installation of some programs. If a soft reset is performed when programs are running, unsaved work will be lost.

To perform a soft reset:

1. Pull out the stylus.
2. Use the stylus to press the **Reset** button located at the bottom of the device. Your device restarts and displays the Home screen.

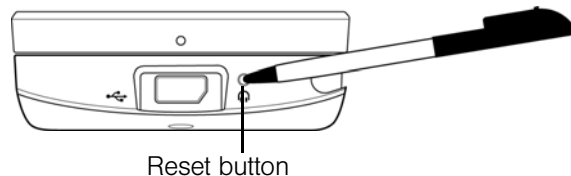

Hard Reset

You can also perform a hard reset (also known as a full reset). A hard reset should only be performed if a normal reset does not solve a system problem. After a hard reset, the device is restored to its default settings—the way it was when you first purchased it and turned it on. Any programs you installed, data you entered, and settings you customized on your device will be lost. Only Windows Mobile software and other preinstalled programs will remain.

Warning

Your device will be set back to factory default settings. Make sure that any additional installed programs and/or user data have been backed up before you perform a hard reset.

Important

If Encrypt files when placed on a storage card is enabled, back up all files from the microSD card before using Clear Storage, hard reset, or updating the ROM system software. Otherwise you will no longer be able to access the encrypted files on the microSD card. Use ActiveSync or Windows Mobile Device Center to transfer files between your microSD card and computer. After the procedure, copy those files back to the microSD card.

To perform a hard reset:

1. With the device turned off, press and hold the **Volume Down** and **Enter** keys first, and then press and hold the **Power** key until you see the following message on the screen:

```
This operation will delete
all your personal data,
and reset all settings
to manufacturer default.
Press VolUp to restore
manufacturer default, or
press other keys to cancel.
```

2. Release the **Volume Down**, **Enter**, and **Power** keys, and then press the **Volume Up** key to perform the hard reset, or press any other button to cancel the reset.

Clearing Storage

You can also use Clear Storage to reset your device back to factory default settings.

1. On the Home screen, slide to the **Settings** tab and then tap **All Settings**.
2. On the **System** tab, tap **Clear Storage**.
3. Enter “1234” and then tap **Yes**.

Windows Update

You can update Windows Mobile on your device with the latest updates, security patches or fixes, if these are available.

To set up Windows Update:

The first time you run Windows Update, you need to set up how you want Windows Update to check for patches on the Microsoft Web site.

1. On the Home screen, slide to the **Settings** tab and then tap **All Settings**.
2. On the **System** tab, tap **Windows Update**.
3. On the Update Setup screen, tap **Next**.
4. Choose how you want to check for updates (**Manual** or **Automatic**) and then tap **Next**.

Note If you select **Automatic**, you will be asked if you want to use your current data plan to check for updates. Select or clear the **Use my data plan to check for and download updates** check box and tap **Next**.

5. Tap **Finish**.

To check for updates:

1. On the Home screen, slide to the **Settings** tab and then tap **All Settings**.
2. On the **System** tab, tap **Windows Update**.
3. Tap **Check Now**.

Note Windows Mobile updates may not be available at all times. Check the Windows Mobile Web site for update information.

To change Windows Update options:

1. On the Home screen, slide to the **Settings** tab and then tap **All Settings**.
2. On the **System** tab, tap **Windows Update**.
3. Tap **Menu** and then select the option you want to change:
 - Tap **Connections** to change how the device connects to the Internet when checking for updates.
 - Tap **Change Schedule** to change how Windows Update checks for Windows Mobile updates.

Using the Strap Holder

The strap holder at the bottom of the back cover of your device allows you to attach a wrist strap, lanyard, or string accessory.

To attach a strap, lanyard or string accessory to the strap holder:

1. Remove the back cover.
2. Insert the loop of the strap, lanyard, or string accessory through the strap holder hole on the back cover.

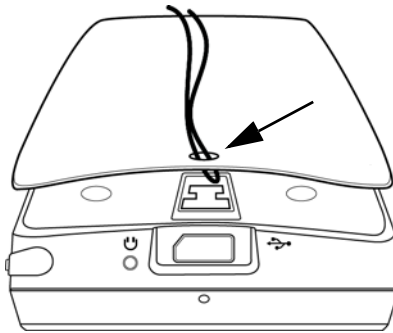

Tip

To pass a loop through the strap holder easier, push the loop into the strap holder hole using a pointed object such as a needle or toothpick.

3. Attach the loop over the small t-shaped hook at the bottom of the device.

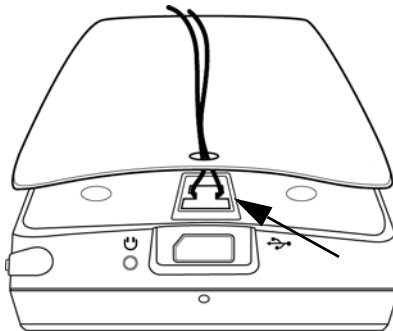

4. Slightly pull the strap, lanyard, or string accessory to fix it securely on the t-shaped hook.
5. Replace the back cover.

Section 3

Sprint Service



Sprint Service Features: The Basics

- ◆ *Using Voicemail (page 130)*
- ◆ *Using SMS Text Messaging (page 133)*
- ◆ *Using Caller ID (page 135)*
- ◆ *Responding to Call Waiting (page 136)*
- ◆ *Making a Three-Way Call (page 136)*
- ◆ *Using Call Forwarding (page 136)*

Now that you've explored your device's fundamentals, it's time to learn about the calling features that enhance your Sprint service. This section outlines your basic Sprint service features.

Using Voicemail

Setting Up Your Voicemail

- ▶ For instructions on how to set up your voicemail, see "Setting Up Your Voicemail" on page 5.

Voicemail Notification

There are several ways your device alerts you to a new voicemail message:

- By displaying the voicemail icon () in the title bar and a pop-up message.
- By displaying the number of voicemails on the TouchFLO 3D Home tab.
- By sounding the assigned alert or ringer type
- By showing a white light flashing twice at the top and bottom of the LED ring of the Navigation Control.

New Voicemail Message Alerts

When you receive a new voice message, your device alerts you that you have voicemail.

To call your voicemail:

- ▶ The number of new voicemails is shown on the TouchFLO 3D Home tab. Tap it to call your voicemail.

— or —

Press the **Talk** key to display the Phone screen, and then tap and hold  on the Phone keypad.



Retrieving Your Voicemail Messages

You can listen to voice messages directly from your device or from any other touch-tone phone.

Note When you are roaming off the Sprint National Network, you may not receive notification of new voicemail messages. It is recommended that you periodically check your voicemail by dialing 1 + area code + your wireless phone number. When your voicemail answers, press  and enter your passcode. You will be charged roaming rates when accessing voicemail while roaming off the Sprint National Network.

Your device accepts messages even when it is turned off. However, you are notified of new messages only when your device is turned on and you are in a Sprint service area.

Using One-Touch Message Access

▶ Press the **Talk** key to display the Phone screen, and then tap and hold  on the Phone keypad.













Using Another Phone to Access Messages

1. Dial your wireless phone number.
2. When your voicemail answers, press *.
3. Enter your passcode.

Tip When you call into voicemail, you first hear the header information (date, time, and sender information) for the message. To skip directly to the message, press  during the header.

Voicemail Key Guide

Below are some Phone keypad functions that you can use while listening to voicemail messages. For further details and menu options, see “Voicemail Menu Key” on page 132.

 Date/Time	 Send Reply	 Advance
 Replay	 Rewind	 Forward
 Erase	 Return Call	 Save
 Cancel	 Help	 Skip





Voicemail-to-Voicemail Message Reply

Reply to a voice message received from any other Sprint Voicemail user.

1. After listening to a voice message, tap  on the Phone keypad.
2. Follow the voice prompts to record and send your reply.

Using Expert Mode

Using the Expert Mode setting for your personal voicemail box helps you navigate through the voicemail system more quickly by shortening the voice prompts you hear at each level.

1. Tap and hold  to access your voicemail. (If your voicemail box contains any new messages, tap  to access the main voicemail menu.)
2. Tap  to change your Personal Options, following the system prompts.
3. Tap  for Expert Mode.
4. Tap  to turn Expert Mode on or off.



Voicemail-to-Voicemail Message Forwarding

Forward a voice message, except those marked “Private,” to other Sprint Voicemail users.

1. After listening to a voice message, tap  on the Phone keypad.
2. Follow the voice prompts to enter the phone number.
3. Follow the voice prompts to record your introduction and forward the voice message.













Extended Absence Greeting

When your device is turned off or you are off the Sprint National Network for an extended period, your device can play this greeting instead of your normal personal greeting.

1. From the main voicemail menu, tap  on the Phone keypad for Personal Options.
2. Tap  for Greetings.
3. Tap  to record an Extended Absence Greeting.

Voicemail Menu Key

Following the prompts on the voicemail system, you can use the keypad on the Phone screen to navigate through the voicemail menu. The following list outlines the voicemail menu structure.

-  Listen
 -  Date and Time Information
 -  Send a Reply Message
 -  Advance a Few Seconds
 -  Replay
 -  Rewind a Few Seconds
 -  Forward Message
 -  Erase
 -  Return This Call
 -  Save
 -  Options
 -  Skip to the Next Message

- 2
ABC Send a Message
- 3
DEF Personal Options
 - 1
EJ Settings
 - 1
EJ Skip Passcode
 - 2
ABC Autoplay
 - 3
DEF Play Back Date, Time, and Caller Info.
 - 4
GHI Change Passcode
 - 5
JKL Group Distribution Lists
 - 6
MNO Numeric Paging
 - * Return to Personal Options Menu
 - 2
ABC Greetings
 - 1
EJ Personal Greetings
 - 2
ABC Name Announcement
 - 3
DEF Extended Absence Greeting
 - * Return to Personal Options Menu
 - 3
DEF Expert Mode
- 8
TUV Place a Call
- * Exit

Using SMS Text Messaging

With SMS Text Messaging, you can send and receive instant text messages between your device and another messaging-ready device. When you receive a new text message, it will notify you by sounding the assigned alert or ringer type and then displaying the SMS icon () in the title bar.

In addition, SMS Text Messaging includes a variety of preset messages, such as “I’m running late,” “I’ll be right there,” and more, which make composing messages fast and easy. You can use your device to customize your own preset messages (up to 160 characters).

Creating a New Text Message

From the TouchFLO 3D Home Screen

1. On the Home screen, slide to the **Messages** tab.
2. Touch the **New** icon () on the upper right side of the screen.

Tip To send a text message to a favorite contact, first select the photo of the desired contact in the **People** tab to open his or her contact card and then touch **Send text message**. For more information about working with favorite contacts, see “People” on page 40.

From the Messaging Screen

1. Tap *Start > Messaging > Text Messages*.
2. Tap *Menu > New*.

From the Contacts Screen

1. Tap *Start > Contacts*.
2. Tap the contact's name to open his or her contact card.
3. Touch *Send text message*.

Composing and Sending a Text Message

After creating a new text message, follow the steps below to enter your message and then send it.

1. To add recipients, enter their mobile phone numbers in the **To** field, separating them with a semicolon. You can also tap **To** or tap *Menu > Add Recipient* to add mobile phone numbers from Contacts.
2. Enter your message.

Tip To choose from preset messages, tap *Menu > My Text* and tap a desired message. To check the spelling, tap *Menu > Spell Check*.

3. Tap *Send*.

Tips

- For more information about entering text and symbols, see "Entering Text" on page 54.
- If you want to know when a text message is received, before sending the message that you are composing, tap *Menu > Message Options...*, and then select the **Request message delivery notification** check box.
- To always receive a delivery notification, tap *Menu > Tools > Options...* in the text message list, tap **Text Messages**, and then select the **Request delivery notifications** check box.

Managing Threaded Text Messages

Text messages that are sent to and received from a contact (or number) are grouped as a single thread in your inbox. Threaded text messaging lets you see exchanged messages (similar to a chat program) with a contact on the screen.

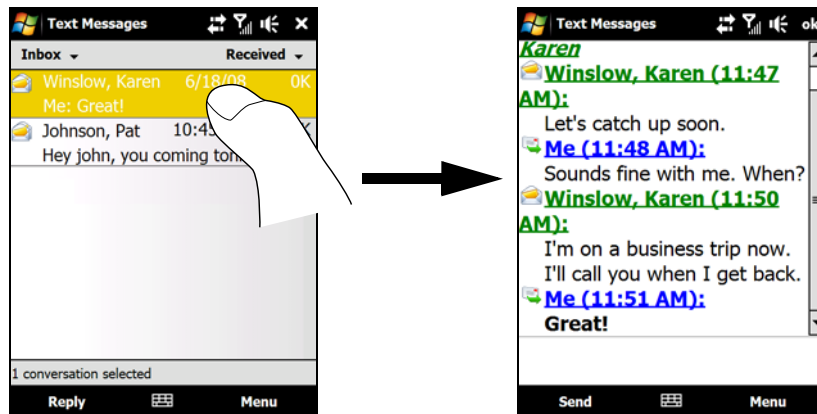

To reply to a text message:

1. In the Text Messages inbox, tap a message thread to open it.
2. At the bottom of the screen, type your reply message and then tap **Send**.

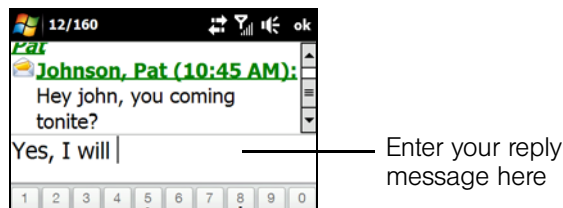

To delete a message in the thread:

1. In the Text Messages inbox, tap a message thread to open it.
2. Press the Navigation Control up or down to select a message in the thread that you want to delete.
3. Tap **Menu > Delete**.

To delete all messages in a thread:

1. In the Text Messages inbox, select a message thread by pressing the Navigation Control up or down.
2. Tap **Delete**.

Changing the Text Messaging Mode

By default, the Text Messaging inbox is in **Threaded** mode. When text messages are threaded, there are certain functions that cannot be used, such as marking messages as unread, forwarding, and moving text messages to other mailbox folders.

You can change the Text Messaging inbox to **Classic** mode so that each text message will be individually stored in the inbox and you can use the above-mentioned functions with your text messages.

To change the Text Messaging inbox to Classic mode:

1. Tap **Start > Settings > System tab > Text Messaging**.
2. In **Text Messaging Layout**, select **Classic**.
3. Reset your device. See “Soft Reset” on page 126 for instructions on how to reset.

Using Caller ID

Caller ID allows people to identify a caller before answering the phone by displaying the number of the incoming call. If you do not want your number displayed when you make a call, follow these steps.

1. Press the **Talk** key to display the Phone screen.
2. Tap *** 6 7** on the Phone keypad.
3. Enter the number you want to call.
4. Press the **Talk** key to place the call.

To permanently block your number, call Sprint Customer Service.

Responding to Call Waiting

When you're on a call, Call Waiting alerts you to incoming calls by sounding two beeps. Your device's screen informs you that another call is coming in and displays the caller's phone number (if it is available and you are in digital mode).

To respond to an incoming call while you're on a call:

- ▶ Press the **Talk** key. (This puts the first caller on hold and answers the second call.)

To switch back to the first caller:

- ▶ Press the **Talk** key again.

Tip For those calls where you don't want to be interrupted, you can temporarily disable Call Waiting by pressing *7 0 before placing your call. Call Waiting is automatically reactivated once you end the call.

Making a Three-Way Call

With Three-Way Calling, you can talk to two people at the same time. When using this feature, the normal airtime rates will be charged for each of the two calls.

1. Place the first call, or take an incoming call.
2. Press the **Talk** key to put the first call on hold, and dial a second number.
3. When you're connected to the second party, press the **Talk** key to begin the three-way call.

If one of the parties in the current call hangs up, you and the remaining caller still remain connected.



If you initiated the call and are the first to hang up, all other callers are disconnected.

Using Call Forwarding

Call Forwarding lets you forward all your incoming calls to another phone number – even when your device is turned off. You can continue to make calls from your device when Call Forwarding is activated.

Note You cannot forward your calls to an international number.

To activate Call Forwarding:

1. On the Phone keypad, tap    .
2. Enter the area code and phone number to which your future calls should be forwarded.
3. Press the **Talk** key. (You will see a message and hear a tone to confirm the activation of Call Forwarding.)

To deactivate Call Forwarding:

1. On the Phone keypad, tap     .
2. Press the **Talk** key. (You will see a message and hear a tone to confirm the deactivation.)

Note You are charged a higher rate for calls you have forwarded.

Section 3B

Internet

- ◆ *Ways of Connecting to the Internet (page 137)*
- ◆ *Getting Started With Data Services (page 140)*
- ◆ *Navigating the Web (page 143)*
- ◆ *Using Windows Live (page 147)*
- ◆ *Using RSS Hub (page 152)*
- ◆ *Using Your Device As a Modem (page 156)*
- ◆ *Using Remote Desktop Mobile (page 157)*
- ◆ *Accessing Sprint Instant Messaging (page 158)*
- ◆ *Using Sprint Picture Mail (page 160)*
- ◆ *Email Messaging (page 162)*
- ◆ *Working With Company Email and Meeting Appointments (page 168)*

Your device allows you to wirelessly connect to the Internet, and with Sprint data services, you have access to a dynamic variety of data services you will really use. Data services such as email, instant messaging, Web browsing, and RSS feeds let you have fun, stay in touch, and stay informed no matter where you go on the Sprint National Network.

Ways of Connecting to the Internet

Your device's networking capabilities allow you to wirelessly access the Internet or your corporate network through one of the following connections:

- Wi-Fi (see "Connecting via Wi-Fi" below)
- Data Services (see "Getting Started With Data Services" on page 140)

Note You can also add and set up the following connections:

- **VPN:** A VPN connection is used to access your corporate network by using an existing Internet connection.
- **Proxy:** A Proxy connection is used to access the Internet using an existing connection to your corporate or WAP network.

Connecting via Wi-Fi

Wi-Fi provides wireless Internet access over distances of up to 300 feet (100 meters). To use Wi-Fi on your device, you need access to a wireless access point or "hotspot."

Note The availability and range of your device's Wi-Fi signal depends on factors such as the number of walls and other objects through which the signal must pass and background interference caused by microwave ovens and other devices that generate RF signals.

Turning Wi-Fi On and Off

1. On the Home screen, slide to the **Settings** tab.
2. Tap **Communications** to open the Comm Manager.
3. On the Comm Manager screen, tap **Wi-Fi** to enable or disable the wireless function.

When enabled, the **On** indicator is activated and available wireless networks will be detected. Follow the steps in “Connecting to a Wireless Network” on page 138 to choose and connect to a wireless network.

Connecting to a Wireless Network

After Wi-Fi is turned on, your device scans for available wireless networks in your area.

1. The network names of the detected wireless networks are displayed on a pop-up message window. Tap the desired wireless network, and then tap **OK**.

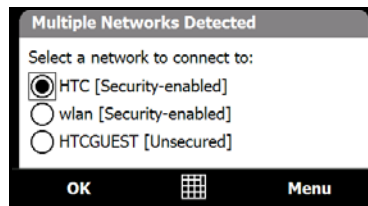

Note When you select an open (unsecured) network, you will be automatically connected to the network after tapping **OK**. You do not need to do steps 2 and 3.

2. On the next pop-up message window, do one of the following:
 - Tap **The Internet** if the wireless network connects your device to the Internet.
 - or –
 - Tap **Work** if the wireless network connects your device to a private or corporate network.



3. Enter the network key and then tap **Connect**.

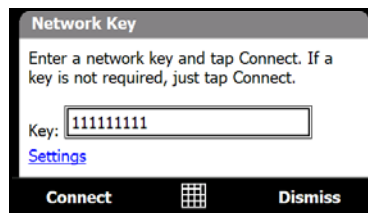



Next time you use your device to detect wireless networks, you will not see the pop-up messages again, and you will not be prompted to enter the network key of the previously accessed wireless network (unless you perform a hard reset or clear storage which will erase custom settings on your device).

Note Wi-Fi networks are self-discoverable, which means no additional steps are required for your device to connect to a Wi-Fi network. It may be necessary to provide a user name and password for certain closed wireless networks.

Checking Wireless Network Status

You can check the current wireless connection status from any of the following screens of your device:

- **Title bar.** When you enable Wi-Fi on your device, the Wi-Fi ON icon  appears on the title bar. After Wi-Fi is turned on, your device scans for available wireless networks and the wireless signal icon  appears on the title bar. The arrows in this icon move back and forth while your device is scanning for a wireless network signal. Once your device successfully connects to a wireless network, the arrows stop moving.
- **Wireless LAN screen.** On the Home screen, slide to the Settings tab and then tap *Menu > Wireless Networks*. On the Main tab, you will see the wireless network that your device is currently connected to. The configuration and signal quality of the wireless network are also shown

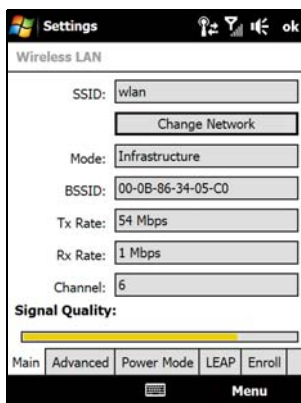

- **Configure Wireless Networks screen.** On the Home screen, slide to the *Settings* tab and then tap *All Settings*. In the *Connections* tab, tap *Wi-Fi*. This screen displays the wireless networks currently available. To connect to a wireless network in the list, tap and hold on the desired network, and then tap *Connect*. Tap a wireless network in the list to view or change its connection settings. You can also add new wireless networks, if available, by tapping *Add New*.

Saving Battery Power While Using Wi-Fi

Using Wi-Fi quickly consumes battery power. Turn off Wi-Fi when not in use. You can also enable power saving settings.

1. On the Home screen, slide to the *Settings* tab.
2. On the Settings screen, tap *Menu > Wireless Networks > Power Mode* tab.
3. On the *Power Mode* tab, move the *Power Save Mode* slider to a position that optimizes performance with the least power consumption.

For example, move the slider to the left (*Best Performance*) to have the optimal wireless network performance; move to the right (*Best Battery*) to obtain the maximum battery usage.

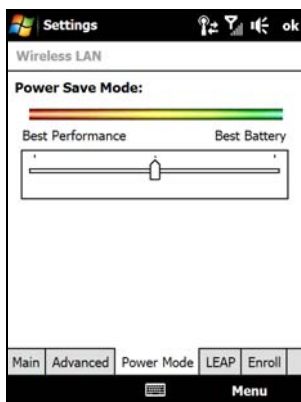

Getting Started With Data Services

Sprint enhances data services with increased broadband speed, and gives you clearer, high-quality visuals and sound when you preview videos and music online. It also offers you exciting services such as Sprint TV, the Sprint Music Store, and YouTube. (For more information about Sprint TV, the Sprint Music Store, and YouTube, see “Entertainment: TV, Music, and Video” on page 175.)

Data Services

Here is a brief list of the data services available for your device. For more information, please visit us online at www.sprint.com.

Sprint Picture Mail – Take photos or capture videos and then send them as picture messages from your device (page 160).

Messaging – Send and receive email messages (page 162) and instant messages (page 158) on your device.

Web Browsing – Experience full-color graphic versions of popular Web sites from your device. You can use the Opera Mobile (page 143) or Internet Explorer Mobile browser (page 145) to search and browse Web sites.

Information Services – View the latest news, sports, stock quotes, travel information, and more. You can download and use Sprint’s Pocket Express (page 150), or use the built-in RSS Hub program (page 152).

Phone as Modem – Use your device as a high-speed Internet connection for your laptop computer. Use the built-in Internet Sharing program (page 156) to transform your device into a USB or Bluetooth modem for your computer.

Your User Name

When you buy your device and sign up for service, you’re automatically assigned a user name. When you use data services on your device, your user name is submitted to identify you to the Sprint National Network. Your user name will be automatically programmed into your device. You don’t have to enter it.

Finding Your User Name

If you aren’t sure what your user name is, you can easily find it on your device.

▶ Tap **Start > Settings > System tab > Device Information > Version** tab.

Tip

If you choose to change your user name and select a new one online, you must then update the user name on your device. Tap **Start > Settings > System tab > Update Profile**.

Connecting to Data Services

To connect to data services and access the Internet, you can simply launch the Web browser on your device. You can also connect to data services from the Connections settings screen or the Comm Manager.

Connecting to Data Services Using Opera Mobile

- ▶ Tap **Start** > **Opera Browser**.

— or —

On the Home screen, slide to the **Internet** tab and then touch **Launch Browser** or the globe image.

Your data connection starts and the Sprint Powerdeck home page is displayed:

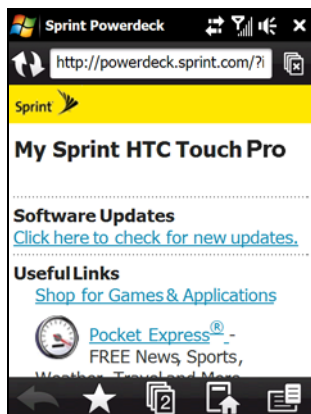

Sprint Powerdeck Home Page

Connecting to Data Services from the Connections Screen



1. On the Home screen, slide to the **Settings** tab and then tap **All Settings**.
2. On the **Connections** tab, tap **Connections**.
3. Under the **Sprint** item, tap **Manage existing connections**.
4. Tap and hold **Sprint** to open a shortcut menu, and then tap **Connect**.

Connecting to Data Services from the Comm Manager

1. Do one of the following to open the Comm Manager:
 - On the Home screen, slide to the **Settings** tab and then tap **Communications**.
 - or —
 - Tap **Start** > **Programs** > **Comm Manager**.
 - or —
 - Tap **Start** > **Settings** > **Connections** tab > **Comm Manager**.
2. Tap **Data Connection**. The ON/OFF button turns yellow and the indicator is in the ON position when your device is connected to data services.

Data Connection Status Icons

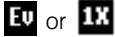
Your device displays the current status of your data connection through status icons at the top of the screen. The following symbols are used for data connections:

-  A high-speed connection to the Sprint Mobile Broadband network (EVDO) or a Sprint 1xRTT data connection is available. These icons in conjunction with the data connection icons below let you know what type of connection your device is using.
-  Your device has an active connection to the Sprint Mobile Broadband (EVDO) or Sprint 1xRTT data network. When active, data is being transferred and you cannot receive calls.
-  Your device's data connection is idle. You can receive incoming calls.

If none of the above status icons are displayed, your device does not have a current data connection. To launch a connection, see “Connecting to Data Services” on page 141.

Disconnecting from Data Services

1. Do one of the following to open the Comm Manager:
 - On the Home screen, slide to the **Settings** tab and then tap **Communications**.
 - or —
 - Tap **Start > Programs > Comm Manager**.
 - or —
 - Tap **Start > Settings > Connections tab > Comm Manager**.
2. Tap **Data Connection**. The ON/OFF button turns white and the indicator is in the OFF position when your device has disconnected from data services.

Navigating the Web

To search, browse, and navigate the Web on your device, you can use either the Opera Mobile or Internet Explorer Mobile application.

Using Opera Mobile

Opera Mobile™ is a full-featured Internet browser, optimized for use on your device.

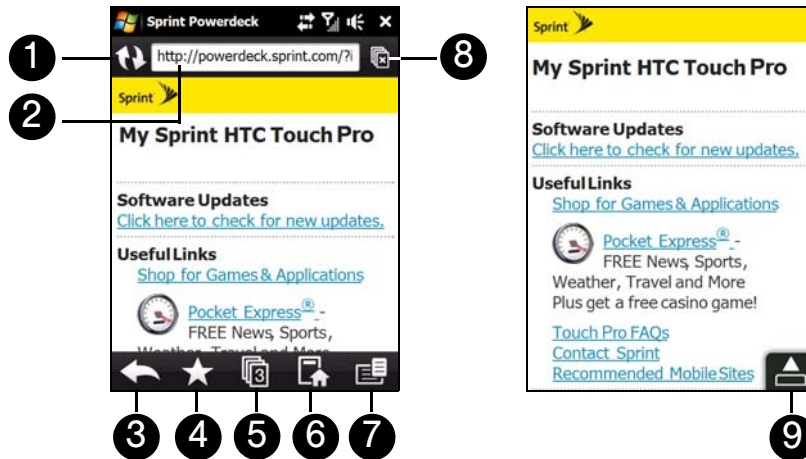

1. **Refresh.** Tap to reload the Web page being viewed.
2. **Address bar.** Enter the URL of a Web site here.
3. **Back.** Tap to go back to the previous Web page viewed.
4. **Favorites.** Tap to go to the Favorites screen where you can add a favorite, edit favorite Web pages, and send the favorite URL link via one of the Messaging accounts.
5. **Tabs.** Tap to add a new browsing tab or switch to another existing browsing tab.
6. **Home.** Tap to go to the Home page.
7. **Menu.** Tap to open a menu where you can change Opera Mobile settings, check downloads, view History, and more.
8. **Close tab.** Tap to close the current tab. This is enabled only if you have more than one tab opened.
9. **Exit Full Screen mode.** When browsing the Web, Opera Mobile automatically switches to full-screen mode. Tap to show the address and Menu bars again.

To open Opera Mobile:

- ▶ On the Home screen, slide to the **Internet** tab and then tap the globe image or **Browser**.
— or —
Tap **Start > Opera Browser**.

To go to a Web site:

1. On the Opera Mobile screen, tap the address bar.
2. Enter the URL address and tap .

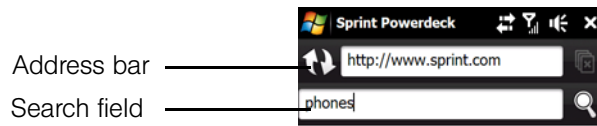

Tip When you tap the address bar, a search field also appears. Quickly search the Web by entering the search item and tapping .

Viewing Web Pages

While browsing Web pages, use finger gestures to pan and zoom on the Web page. To zoom in, tap your finger twice on the screen. To zoom out, tap your finger twice on the screen again.

Tip Touch and hold an empty area on a Web page to open a shortcut menu that lets you go back to the previous page, reload the page, add the page as a Favorite, and more. You can also tap and hold a link or image on a Web page to open a menu with different options.

To change the screen orientation:

- Change the screen orientation by simply turning your device sideways.

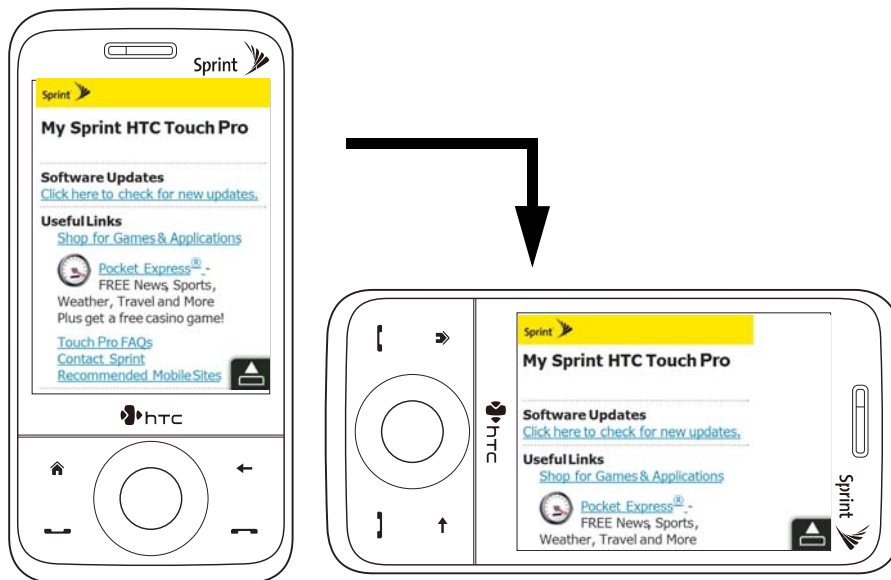

Opera Mobile Menu

On the menu bar, tap  to open the menu.

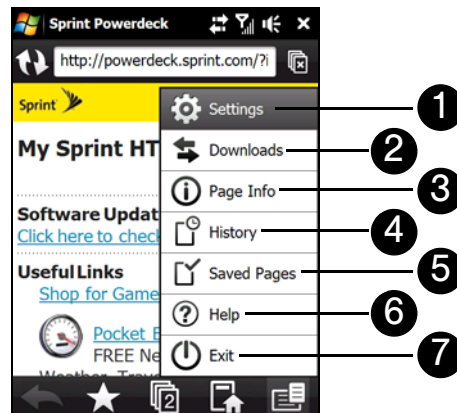

1. **Settings.** Tap to open the Settings screen where you can set the default home page, change display settings, set privacy settings, and more.
2. **Downloads.** Tap to view items being downloaded. You can also resume or stop current downloads.
3. **Page Info.** Tap to view information about the Web page you are browsing.
4. **History.** Tap to see Web pages that you have viewed.
5. **Saved Pages.** Tap to manage and view Web pages that you have saved.
6. **Help.** Tap to open the Opera Mobile help file.
7. **Exit.** Tap to close Opera Mobile completely. Opera Mobile will not run in the background.

Note For more information about using Opera Mobile, go to: <http://www.opera.com/products/mobile/>.

Using Internet Explorer Mobile

Internet Explorer® Mobile is the standard Web browser that is included with Windows Mobile.

To launch Internet Explorer Mobile:

- ▶ Tap **Start > Programs > Internet Explorer**.

To go to a Web site:

1. Tap **Menu > Address Bar** to highlight the address bar.
2. Enter the Web address of the desired Web site in the address bar and then tap .

To navigate a Web page:

- ▶ Press the Navigation Control up, down, left, or right to scroll vertically or horizontally on a Web page.
— or —
Drag your finger on the screen to pan around the Web page.

To save an image from a Web page:

1. Tap and hold the image to open a shortcut menu and then tap **Save Image**. A confirmation message is then displayed.
2. To save the image to “\My Documents\My Pictures” on your device, tap **Yes**.
— or —
To save the image in another location such as the microSD card, tap **Save As**.

To use the browser menu:

- ▶ Tap **Menu** to choose from a list of options that will let you change the text size of a Web page, save favorites, and more.

Options available in the browser menu include:

- **Zoom Out**. Fits the whole Web page within the screen, with a selection box shown on the page. To zoom in on a certain part of the Web page, first press the Navigation Control up, down, left, or right to move the box to the desired part of the Web page, and then tap **Zoom In**.
- **Home**. Sets the current Web page as the default home page.
- **Address Bar**. Highlights the address bar and allows you to enter a Web address.
- **Favorites**. Allows you to access and manage your favorites.
- **Add to Favorites**. Marks the current Web site as your favorite.
- **Forward**. Moves forward to a previously viewed Web page.
- **Refresh**. Reloads the current Web page.
- **View**. Allows you to change how a Web page is displayed. You can choose from the following options:
 - **Zoom Level**. Allows you to choose the font size for the text.
 - **One Column**. Arranges the content into one column that is as wide as the screen. This means that you will rarely have to scroll horizontally.
 - **Fit to Screen**. Makes items smaller and arranges the content so that you can see most of it without having to scroll horizontally.
 - **Desktop**. Keeps the same layout and size as on a desktop computer, which will require both horizontal and vertical scrolling.
 - **Full Screen**. Displays the current Web page in full-screen view. To change back to the normal view, tap and hold on the Web page to open a shortcut menu, and then tap **Full Screen**.
 - **Show Pictures**. Allows you to display or hide images when loading Web pages. If the size of a Web page is large and takes a long time to load, you can clear this option to hide images.
- **Edit**. Allows you to choose whether to cut, copy, or paste a selected text, or to select all text on a Web page.
- **Tools**. Additional options you will find in this submenu include:
 - **History**. Displays a list of Web sites that you previously accessed and allows you to quickly return to a visited Web site.
 - **Send Link**. Allows you to send the current Web address in a text message, Sprint Picture Mail, or email message.
 - **Properties**. Displays information about the current Web page such as file size.
 - **Options**. Allows you to change various browser settings such as the default home page, to clear the browser’s history or cookie files, and more.

Using Windows Live

Windows Live™ gives you a full Internet experience on your device. Windows Live™ helps you to find information, pursue your interests, and get in touch with friends and family on the Internet easier.

Windows Live™ offers the following key features:

- **Live Search Bar**, which lets you search for information on the Web.
- **Live Messenger**, the next generation of MSN Messenger Mobile.
- **Live Mail**, the next generation of Hotmail.
- **Live Contacts**, your address book for storing Live Mail, Live Messenger, and Hotmail contacts.

Setting Up Windows Live™

The first time you use Windows Live™, sign in using your Windows Live™ ID, which is your Windows Live™ Mail or Hotmail address, and password.

To set up Windows Live™ for the first time:

1. Tap **Start > Programs > Windows Live** and then tap **Sign in to Windows Live**.
2. Tap the links to read the Windows Live™ Term of Use and the Microsoft Privacy Statement. After reviewing them, tap **Accept**.
3. Enter your Windows Live™ Mail or Hotmail address and password, ensure that the **Save password** check box is selected, and then tap **Next**.
4. Tap **Next**.
5. Choose what information you want to sync online with your device.

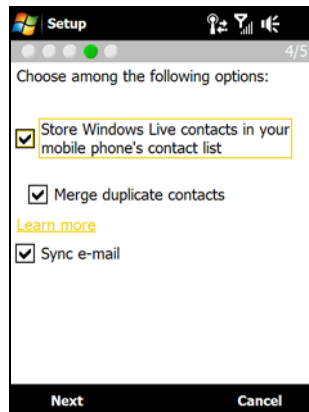

- If you select **Store Windows Live contacts in your mobile phone's contact list**, your Windows Live™ contacts will be added to the contact list and to Windows Live™ Messenger on your device.
 - If you select **Sync e-mail**, your Windows Live™ Mail or Hotmail inbox messages will be downloaded to your device.
6. Tap **Next**.
 7. After synchronization is complete, tap **Done**.

The Windows Live Interface

On the Windows Live main screen, you will see a search bar, navigation buttons, and an area where you can show and customize your profile.

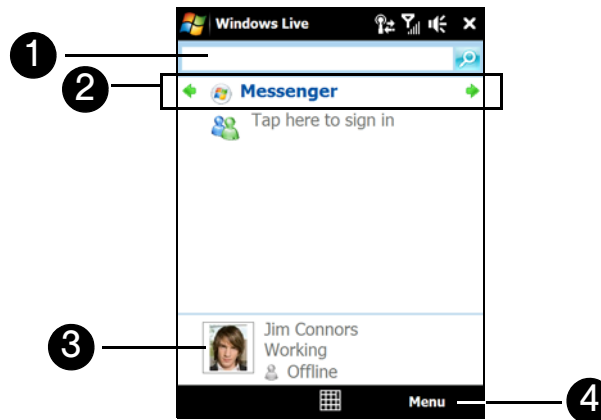

1. **Search Bar.** To search for Web sites, enter search keywords and then tap  .
2. **Navigation Buttons.** Tap the left or right arrow to switch between Windows Live™ Messenger, Windows Live™ Mail, and Sync status.
3. **Display Picture.** Tap your display picture to change your display name, picture, or personal message.
4. **Menu.** Tap *Menu* to access and change settings.

Windows Live Messenger

With this mobile version of Windows Live™ Messenger, you enjoy many of the same features that you get from the desktop version, which include the following:

- Instant messaging via text and voice
- Multiple conversations
- Inserting emoticons
- Contact list with online or offline status
- Sending and receiving files (including photos)
- Changing the status and display name
- Viewing contacts by online status, groups, and more
- Sending messages even when a contact is offline

Note Before you can use Windows Live Messenger, your device must be connected to the Internet. To find out how to connect your device to the Internet, see "Ways of Connecting to the Internet" on page 137 .

Launching Messenger and Signing In

To open Windows Live™ Messenger:

- ▶ Tap **Start > Programs > Messenger**.
- or –

On the Windows Live main screen, tap the left or right arrow until you see **Messenger**, and then tap it.

To sign in and out:

1. Tap **Sign in** on the Messenger screen.
2. If this is your first time to sign in, a message appears to inform you that your messenger contacts will be added to the contact list on your device. Tap **OK** to add them. Signing in may take several minutes, depending on your connection speed.

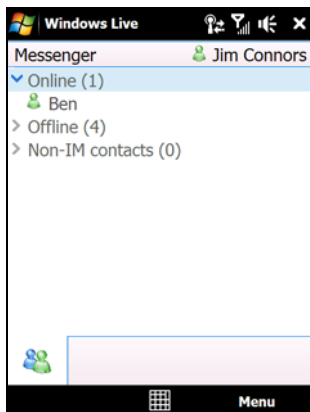

Live Messenger screen after you have signed in

3. To sign out, tap **Menu > Sign out**.

To start and end conversations:

1. In the contact list, select a contact, and then tap **Send IM** to open a message screen.
2. Enter your text message in the text entry area of the message screen.
3. To add an emoticon, tap **Menu > Add emoticon** and then tap an icon from the list.
4. Tap **Send**.
5. To end a conversation with the current contact, tap **Menu > End conversation**.

Tips

- To send a file, tap **Menu > Send**. You can choose to send a picture, voice clip or any file.
- To invite one or more contacts to the conversation, tap **Menu > Options... > Add participant**.
- To send a voice message, tap **Voice Clip** on a message screen then start talking. After you have recorded a message, tap **Send**.

Adding Windows Live Contacts

You can add new Windows Live contacts in Windows Live Messenger or in Contacts.

To add a Windows Live contact in Live Messenger:

1. Tap **Menu > Add new contact**.
2. Enter the email address of the contact, and then tap **OK**.

To add a Windows Live contact in Contacts:

1. On the Home screen, slide to the **People** tab and then tap **All People**.
2. Tap **New**, and then tap **Windows Live**.
3. In the **IM** box, enter the email address of the contact, which can be a Windows Live ID or any other email address.

Tip

You can fill in other information about the contact, if desired. This is not necessary if you will communicate with the contact only through Live Messenger or Live Mail.

4. Tap **OK**.
5. Follow the onscreen instructions to add the new contact to your Windows Live™ contact list.

Using Pocket Express

With Sprint's exclusive Pocket Express feature, you can personalize your device's data services to suit your needs. Pocket Express makes it easier than ever to retrieve the most popular Web information and categories instantly. It uses the ZIP code you provide to customize the content you receive, so you can get the information you want, when you want it.

Pocket Express acts like a computer browser's customized home page, displaying a variety of top categories such as News, Sports, Weather, Money, Movies and more. This information is updated throughout the day, so you'll always be up-to-date.

Installing Pocket Express

Pocket Express is not preinstalled on your device. You need to download it first and install it on your device.

1. On the Home screen, slide to the **Programs** tab and then tap the Pocket Express icon.

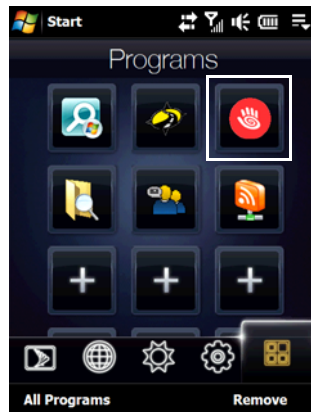

— or —

Tap **Start > Programs > Get Pocket Express**.

2. Enter your preferred ZIP code and then tap **I Agree**.
3. A message is then displayed, informing you that the Pocket Express application will be downloaded and installed on your device. Choose whether to install on the **Device** or **Storage Card** (if one is installed), and then tap **Install** to start the installation.
4. On the next message that is displayed, tap **OK** to reset your device and complete the installation.

Initializing Your Pocket Express Service

1. On the Home screen, slide to the **Programs** tab and then tap the Pocket Express icon.
— or —
Tap **Start > Programs > Pocket Express**.
2. On the welcome screen, enter the same ZIP code that you specified when installing Pocket Express, and then tap **I Agree**.
3. Initializing your Pocket Express service may take a while. Wait for the initialization process to complete.

Accessing Pocket Express Information

Finding the information you're looking for with Pocket Express is as easy as navigating a Web browser on your computer. (The following examples will illustrate how to access News and Movies information).

To access News information using Pocket Express:

1. On the Home screen, slide to the **Programs** tab and then tap the Pocket Express icon.
— or —
Tap **Start > Programs > Pocket Express**.
2. The Pocket Express **PageOne** menu will be displayed. From the Pocket Express PageOne menu screen, tap **Breaking News Photos & Opinion** (or **News**). You will then be presented with a list of news categories.

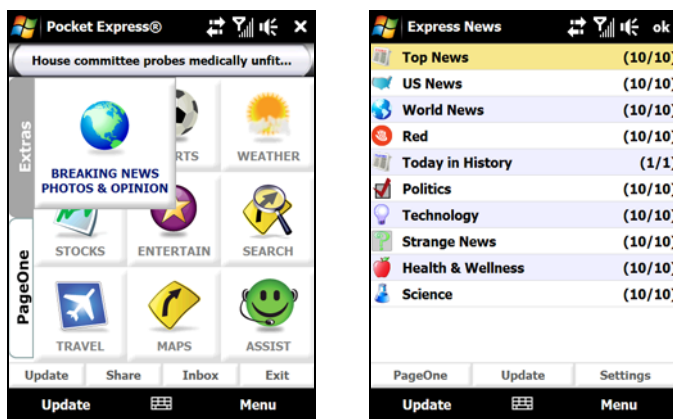

3. Tap the desired category to display a list of news stories for that category.
4. Tap the story you want to read. The news story you selected is then displayed on the screen.
5. After you have finished reading the news story, you can return to the PageOne menu screen by tapping **Menu > Page One**.

To access Movies information using Pocket Express:

1. From the Pocket Express PageOne menu, tap **Showtimes & Entertainment** (or **Entertain**).
2. Select a movie. You will be presented with showtimes, the option to buy tickets, and more.

Select other categories such as Weather, Sports, and Money from the Pocket Express main screen and enjoy the feature-rich contents of Pocket Express.

Every category offers you the capability to customize news and information based on your preference.

Updating Pocket Express Information

The Pocket Express news and information is automatically delivered to your device several times a day. You can also manually retrieve updates.

- ▶ From a Pocket Express category page (such as News), tap **Update**. Your device will retrieve updates for the selected category.

Using RSS Hub

RSS Hub is an RSS reader that keeps you up-to-date with the latest news from the Internet. It monitors Internet news channels and downloads the most current news updates and podcasts so you are instantly informed of breaking news and events.

This section provides basics on using RSS Hub. For more information and tips on using RSS Hub, see Help on your device.

Note Make sure you have an active Internet connection before using RSS Hub. To find out how to connect to the Internet, see "Ways of Connecting to the Internet" on page 137.

Subscribing to and Organizing News Channels

You must subscribe to news channels before you can receive RSS feeds.

To subscribe to news channels:

1. Tap **Start > Programs > RSS Hub**, and then tap **Continue**.
2. In the New Channel Wizard screen, select the **Choose from a list of known Channels** option, and then tap **Next**. A list of RSS channels is displayed.

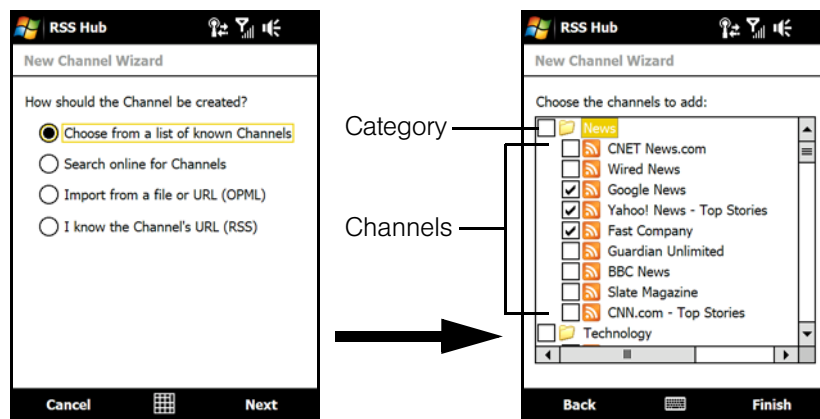

Note If the RSS channel you want to subscribe to is not in the list of known channels, tap **Back**, and then select another option on the New Channel Wizard screen. For more information on these other options, see the Help on your device.

3. Select the check boxes of the RSS channels you want to subscribe to, and then tap **Finish**.

Tip Channels are grouped by categories. If you want to select all channels in a category, select the category check box.

4. The channel list appears. Tap *Refresh* to update the channels.

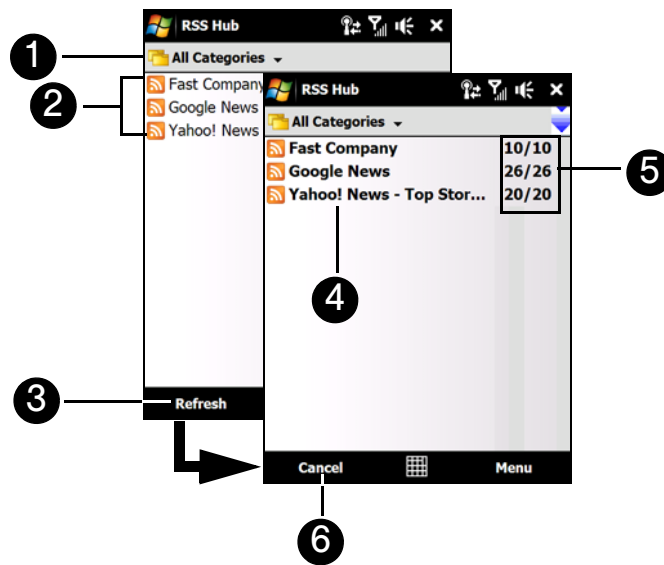

1. *Categories*. Tap to select the channel category to display.
2. *Channel List*. Shows the list of available channels.
3. *Refresh*. Tap to update the channels.
4. *Updated Channels*. Channels are displayed in bold after they have been updated. Tap a channel to view the headlines for that channel.
5. *Headline Count*. Shows the number of headlines per channel.
6. *Cancel*. Tap to cancel the channel update process.

To add new channels:

1. In the channel list, tap *Menu > Channel > New* to open the New Channel Wizard screen.
2. Select an option, and then follow screen instructions to add new channels. For more information on New Channel Wizard options, see Help on your device.

To filter the channels in the display:

In the channel list, tap *Menu > View*, and then select:

- *Update* to display only those channels with unread headlines.
- *All* to display all subscribed channels.





To manage channel categories:

- To view all the channels in a particular category, tap *All Categories* in the upper left area of the channel list, and then tap the category you want to display.
- To add a new category, tap *Menu > Categories* in the channel list to display all categories, and then tap *Menu > New*.
- To rename or delete a category, tap *Menu > Categories* in the channel list to display all categories, select a category, and then tap *Menu > Rename* or *Menu > Delete*.
- If you want to change the channel category, tap and hold the channel in the channel list, and then tap *Change Category*. Select a new category and then tap *ok*.

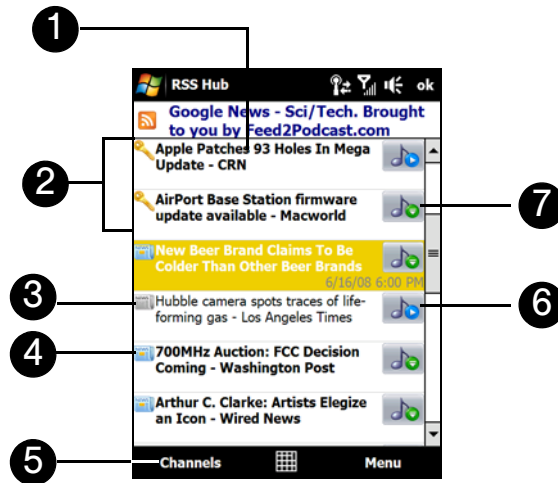
Viewing and Organizing Headlines

Tap a channel in the channel list to display the headlines for that channel.





1. **Headline.** Tap a headline to open the news summary screen.
2.  This icon indicates that the headline or news summary contains a keyword.
3.  This icon indicates that the headline has already been read.
4.  This icon indicates that the headline is new or unread.
5. **Channels.** Tap to return to the channel list.
6.  After download is completed, tap this icon to play back or view the file attachment.
7.  Tap this icon to download the audio/video file attachment.

New or unread headlines display in bold and are marked with a blue newspaper icon. Headlines that have been read are marked with a gray newspaper icon.

Viewing the News Summary

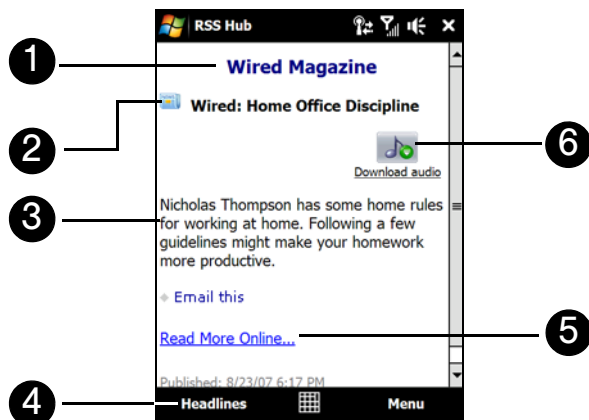
Tap a headline in the headline list to display the news summary.



1. Shows the channel name
2. Displays the headline and read status.
3. Displays the news summary.
4. Tap **Headlines** to return to the headline list.
5. Tap **Read More Online** to open the news item in Opera Mobile. See “Navigating the Web” on page 143 for details.
6. Tap  to download the audio, video or image file attachment.

To change view options:

- ▶ In the news summary screen, tap **Menu** to change the text size, fit the text to the screen (text wrap), or enable **ClearType** for better viewing.

To download, play, or save podcasts:

1. When you see an audio or video file attachment in the news summary, do one of the following to download the file:

- Tap **Menu > Podcasts > Start Download**.

— or —

- Tap the **Download audio/Download video** link below the audio or video file icon.

Tip

To cancel the file download, tap **Menu > Podcasts > Cancel Download**, or tap **Cancel download** below the audio or video file icon.

2. After downloading the file, do one of the following:

- Tap **Menu > Podcasts > Play** or tap **Play audio/Play video** below the audio or video file icon to play back the file.

— or —

- Tap **Menu > Podcast > Save** to save a copy of the file to the device main memory or microSD card (if one is installed.)

To send the headline link via email:

1. In the news summary screen, tap **Menu > Send Link via Email**.
2. Messaging opens and displays the Account Picker screen. Tap the email account you want to use to send the headline link. A new email message is then created with the headline link.
3. Specify the email recipients, and then send it.

For more information on how to compose email messages, see “Composing and Sending an Email Message” on page 165.

To view the next or previous news summary:

- ▶ In the news summary screen, tap **Menu > Next** or **Menu > Previous**, or press the Navigation Control right or left.

Tip For more information about the features and configuring RSS Hub, refer to the program help. To open the program help, tap **Start > Help** while in RSS Hub.

Using Your Device As a Modem

Internet Sharing connects your computer to the Internet by using your device’s data connection. You can connect via USB or Bluetooth.

Notes

- Sprint requires customers to have a separate Phone As Modem service plan in order to use this device as a modem. More information about Phone As Modem service plans are available at www.sprint.com, or you can contact Sprint Customer Service to add the Phone as Modem service plan to your account.
- Make sure you have subscribed to a Phone As Modem Service plan and have set up a phone dial-up modem connection on your device. If your device has not been set up with a data connection yet, tap **Menu > Connection Settings** on the Internet Sharing screen.
- To use a Bluetooth connection, make sure your computer has built-in Bluetooth capability. If your computer does not have Bluetooth, you can connect and use a Bluetooth adapter or dongle on your computer.
- When you launch Internet Sharing, ActiveSync will automatically disconnect.

Setting Up Your Device as a USB Modem

1. On your device, tap **Start > Programs > Internet Sharing**.
2. In the **PC Connection** list, select **USB**.
3. In the **Network Connection** list, select the name of the connection that your device uses to connect to the Internet.
4. Plug in the USB Sync cable between your device and the computer, and then tap **Connect**.

Using Your Device as a Bluetooth Modem

For the computer to use the Internet connection of your device, activate Internet Sharing on your device, and then set up a Bluetooth Personal Area Network (PAN) between the computer and your device.

1. On your device, turn on Bluetooth and set it to visible mode by following the steps in “Turning Bluetooth On and Making Your Device Visible” on page 89.
2. Initiate a Bluetooth partnership from your device by following the steps in “Creating a Bluetooth Partnership” on page 90.
3. Tap **Start > Programs > Internet Sharing**.
4. Select **Bluetooth PAN** as the **PC Connection**.

5. From the **Network Connection** list, select the name of the connection that your device uses to connect to the Internet.
 6. Tap **Connect**.
 7. On your computer, set up a Bluetooth Personal Area Network (PAN) with your device:

For Windows Vista:

 - a. Click **Start > Control Panel > Network and Internet > Network and Sharing Center**.
 - b. Click **Manage network connections** and then under **Personal Area Network**, double-click **Bluetooth Network Connection**.
 - c. In the Bluetooth Personal Area Network Devices dialog box, select your device, and then click **Connect**.

For Windows XP:

 - a. Click **Start > Control Panel > Network Connections**.
 - b. Under **Personal Area Network**, click the **Bluetooth Network Connection** icon.
 - c. Under **Network Tasks**, click **View Bluetooth network devices**.
 - d. In the Bluetooth Personal Area Network Devices dialog box, select your device, and then click **Connect**.
- Note** *If the Bluetooth adapter or dongle on your computer was installed using a third-party driver, open the Bluetooth software that came with the Bluetooth adapter or dongle to connect your computer and device via Bluetooth. Refer to the Bluetooth adapter or dongle documentation for more information.*
8. On the Internet Sharing screen on your device, check if a connected status message is displayed, which indicates that your computer has been successfully connected to the Internet using your device as a Bluetooth modem.

Ending the Modem Connection

- ▶ On the Internet Sharing screen, tap **Disconnect**.

Using Remote Desktop Mobile

Remote Desktop Mobile lets you access your computer remotely from your device and use programs which are available on your computer.

- Notes**

 - Make sure that you configure the remote computer to allow remote desktop connections. Refer to your operating system's manual or help file for details.
 - You need to be connected to the Internet to remotely access your desktop computer.

To configure the remote desktop display:

Before you connect to your remote computer, configure the Remote Desktop Mobile to optimize the remote computer display on your device.

1. Tap **Start > Programs > Remote Desktop Mobile**.
2. Tap **Options > Display** tab.
3. Do any of the following:
 - In **Color**, select **256 Colors**.
 - Select the **Full screen** check box to display the remote desktop in full-screen mode.
 - When using programs which are specifically configured for use with your device, select the **Fit remote desktop to screen** check box to fit the program on the device screen.
4. Tap **ok**.

To connect to a remote computer:

1. On the Remote Desktop Mobile screen, enter the computer name (or IP address), user name, password, and domain of the remote computer, and then select the **Save password** option.

Note If the computer is set up on a custom port, include the custom port number with the computer name (computername:portnumber). You can get this information from your system administrator.

2. Tap **Connect**. When connected, you can now access and start using the desktop computer programs on your device.

To disconnect from the remote computer:

- ▶ Tap **Disconnect**.

— or —

When in full-screen mode, tap **Start > Disconnect** on the Windows desktop (on the device). When prompted, tap the **Disconnect** button.

Accessing Sprint Instant Messaging

The Sprint Instant Messaging application provides you with access to popular instant messaging (IM) communities, including AOL® Instant Messenger™, MSN® Messenger, and Yahoo!® Messenger.

1. To launch Sprint Instant Messaging, tap the Instant Messaging icon on the **Programs** tab of the Home screen.

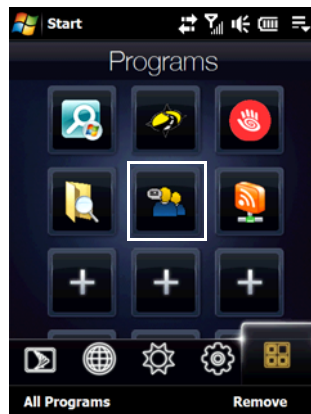

— or —

Tap **Start > Programs > Instant Messaging**.

2. The first time you launch Sprint Instant Messaging, it will prompt you to download and install the application to your device. Follow the onscreen instructions to download and complete the installation.
3. After installation, launch Sprint Instant Messaging again (see step 1).
4. A message appears, informing you to add a messaging and data plan to your service plan. Tap **OK** to close the message.

5. Tap a community: *AOL Instant Messenger*, *MSN Messenger*, or *Yahoo! Messenger*.

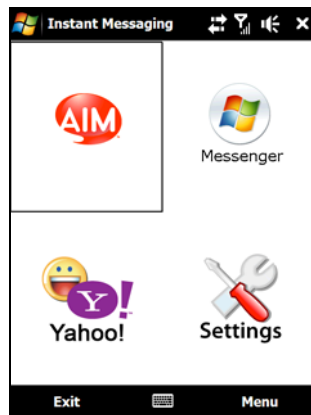

6. Enter the required sign-in information for the selected community, such as user name or password, and then tap **Sign In**.

Note *The information required to sign in will vary depending on the instant messaging community you are accessing.*

The instant messaging screen for your selected community will then be displayed, and you can start chatting online with your friends or family.

Using Sprint Picture Mail

Sprint Picture Mail lets you send pictures and videos that you have captured using your device's built-in camera to wireless phone numbers and email addresses. You can send a picture to up to 10 people at a time using their email addresses or their device phone numbers.

To register your Sprint Picture Mail account:

If this is your first time to use Sprint Picture Mail, you need to register your Sprint Picture Mail account and establish a password.

1. Launch the Web browser on your device. (You can use either Opera Mobile or Internet Explorer Mobile.)
2. Go to this Web site: www.sprint.com/picturemail.
3. Scroll to the bottom right section of the Sprint Picture Mail Web site and then tap **Join Now**.
4. On the right side of the sign-in Web page, enter your device's phone number in the **Sprint Phone Number** box (without hyphens) and ensure the **No, send me a password** option is selected.

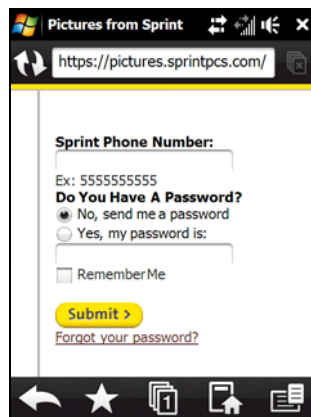



5. Tap **Submit**.
6. Your password will be sent to your device in a text message. On the Home screen, slide to the **Messages** tab and check if you have received this text message.

Tip Write down your Sprint Picture Mail password and keep your password in a secure place so you will not lose it.

7. Tap **Start > Messaging > Sprint Picture Mail**.
8. Follow the onscreen instructions to enter your Sprint Picture Mail password. You will be prompted to confirm your password.

Your device will then connect to the Sprint Picture Mail Web site and confirm your account information. When you receive confirmation that your account has been successfully registered, you may start using this service to send pictures and videos to your friends and family.

To capture a picture or video and send it:

1. On the Home screen, slide to the **Photos and Videos** tab.
2. Tap the camera icon () if you want to take a picture, or tap the video camera icon to record a video clip. For information about capturing photos and videos with the camera, see "Taking Photos and Videos" on page 94.
3. After taking a photo or recording video, tap the **Send** icon () at the bottom of the camera screen.
4. On the Send File screen, tap **Send**.

5. The Messaging screen is then displayed. Tap *Sprint Picture Mail*.

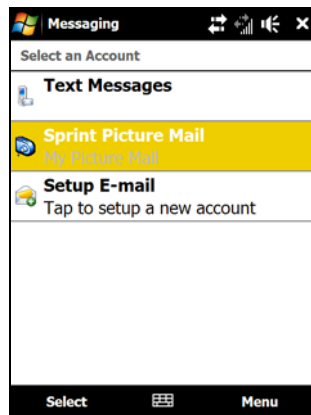

6. Tap *Menu > New* to create a new picture message. Your captured photo or video clip will be automatically attached to the message.
7. Select a recipient from your Contacts list, or manually enter the wireless phone number or email address of the recipient.
8. Select additional options, such as entering a text message and adding a voice recording.
9. When you are ready to send your picture mail, tap *Send*.

To select a picture or video and send it:

1. Tap *Start > Programs > Album*. The Album screen then opens and displays pictures and video clips that are found on your device in thumbnail view.
2. Press the Navigation Control up, down, left, or right until the desired picture or video clip is selected.
3. After selecting a picture or video clip, tap *Menu > Send*.
4. The Messaging screen is then displayed. Tap *Sprint Picture Mail*.
5. Tap *Menu > New* to create a new picture message. Your captured photo or video clip will be automatically attached to the message.
6. Select a recipient from your Contacts list, or manually enter the wireless phone number or email address of the recipient.
7. Select additional options, such as entering a text message and adding a voice recording.
8. When you are ready to send your picture mail, tap *Send*.

To learn more about Sprint Picture Mail, visit the Sprint Picture Mail Web site at www.sprint.com/picturemail.

Email Messaging

Types of Email Accounts

You can set up the following types of email accounts on your device:

- Outlook email that you sync with your computer or the Exchange Server.
- Email accounts that you have with an Internet Service Provider (ISP) or other email provider.
- Web-based email accounts such as Gmail®, Yahoo!® Mail Plus, AOL®, and others.
- Work accounts that you access using a VPN connection.

Setting Up Your Device to Synchronize Outlook Email with the Computer

If you have installed the synchronization software on your computer and created a partnership with your device, and then your device is ready to send and receive Outlook email.

If you have not yet installed the synchronization software nor created a partnership, see “Setting Up Windows Mobile Device Center on Windows Vista” on page 64 or “Setting Up ActiveSync on Windows XP” on page 65 for instructions.

Tip

To set up your company email account so that you can access Outlook email messages wirelessly, you must set up your device to synchronize via an over-the-air connection with your company's Exchange Server. For more information about synchronizing with your company email server, see “Setting Up an Exchange Server Connection” on page 168.

Adding an Email Account

To add a new email account:

- ▶ On the TouchFLO 3D Home screen, slide to the **Mail** tab and then touch **Menu > Accounts > New Account**.
— or —
Tap **Start > Messaging > Setup E-mail**.

The Email Setup Wizard then opens and lets you enter your email account settings. See “Email Setup Wizard” for details.

Email Setup Wizard

Windows Mobile's **Email Setup Wizard** walks you through the process of setting up your email account. It has an Auto Setup feature that can automatically set up your email account based on the email address and password that you enter, if your email provider settings are preconfigured on your device. If the settings are not found on your device, Auto Setup then attempts to retrieve the settings online for which you may be charged when your device connects to the Internet and downloads them. If it cannot find the email settings online, you need to enter them manually.

Note

For more information about setting up your company Outlook email account, see “Setting Up an Exchange Server Connection” on page 168.

Setting Up an Internet Email Account

Set up a POP3 or IMAP4 email account on your device if you have an email account from an Internet service provider (ISP) or other email service provider, or a Web-based account such as Gmail, Yahoo! Mail Plus, or AOL. You can also add a work account that you access using a VPN server connection as a POP3/IMAP4 account.

1. Add a new email account. See “Adding an Email Account” for instructions.
2. Enter your email address and the password for your email account. Ensure that the **Save password** check box is selected and then tap **Next**.
3. If email provider settings are found preconfigured on your device, the Email Setup Wizard shows a successful message. Tap **Next**.
If the settings are not found on your device, select the **Try to get e-mail settings automatically from the Internet** check box to find and download email server settings from the Internet and then tap **Next**.
4. Enter **Your name** and the **Account display name** and then tap **Next**.

Note If the Email Setup Wizard was unsuccessful in finding and downloading settings from the Internet, select **Internet e-mail from the Your email provider list** on the next screen. You will be asked to enter email server settings. See “Specifying Email Server Settings” for details.

5. In the **Automatic Send/Receive** list, choose how frequently you want email messages to be automatically sent and downloaded on your device.

Note Tap **Review all download settings** to select download options, set the email format as HTML or plain text, and more. For more information, see “Customizing Download and Format Settings” on page 164.

6. Tap **Finish**.

Specifying Email Server Settings

If Auto Setup is unsuccessful, contact your ISP or email provider for the **Incoming mail server** and **Outgoing mail server** settings so you can enter them on your device.

Other options that you can select include the following:

- Select the **Outgoing server requires authentication** check box, if required by your provider.
- If the outgoing email server requires a different user name and password for sending email, clear the **Use the same user name and password for sending e-mail** check box. You will be prompted to enter this information.
- Tap **Advanced Server Settings**, and then select the **Require SSL** check boxes if your email provider uses an SSL connection for more secured email. From the **Network connection** list, select the data connection that you use for connecting to the Internet.

Customizing Download and Format Settings

Before you tap **Finish** when setting up your POP3 or IMAP4 email account, you can tap the **Review all download settings** link at the bottom of the screen to choose download options, message format, and other settings.

Options	Description
Automatic Send/Receive	You can select a time interval for connecting to the Internet automatically to send and receive messages.
Download messages	Set the number of days of messages that you want to be downloaded to your device.
Send/receive when I click Send	By default, messages are immediately delivered when you tap Send . If you prefer to save outgoing messages to the Outbox folder first, clear the check box. (In this case, you will need to manually send messages by tapping Menu > Send/Receive).
Use automatic send/receive schedule when roaming	This allows your device to data roam when there is a set time interval for connecting to the Internet automatically. Since this may result in higher connection costs, you may want to leave the check box cleared.
When deleting messages	Choose whether to delete messages from the mail server when you delete them on your device.
Message format	Select HTML or Plain Text.
Message download limit	Select the email download size. If you have a large volume of email, use a lower size or select to download headers only.

Setting Up a Custom Domain Email

When you are using an email domain name that is hosted by a different email provider (for example, your email address may be Benjamin@startup.com but Email.com hosts the email account and provides email services), select the **Custom Domain** option in the Email Setup Wizard to set up your email account.

1. Add a new email account. See “Adding an Email Account” for instructions.
2. Enter your email address and password for your email account. Ensure that the **Save password** check box is selected and then tap **Next**.
3. Clear the **Try to get e-mail settings automatically from the Internet** and then tap **Next**.
4. In **Your e-mail provider**, select **Custom domain** and then tap **Next**.
5. Enter the domain of your email provider and then tap **Next**.
6. The Email Setup Wizard then tries to find the email provider settings on your device or from the Internet. If the settings are found, it shows a successful message. Tap **Next**.
7. Enter **Your name** and the **Account display name** and then tap **Next**.

Note If the Email Setup Wizard was unsuccessful in finding the settings, you will be prompted to enter email server settings on the succeeding screens. See “Specifying Email Server Settings” on page 163 for details.

8. In the **Automatic Send/Receive** list, choose how frequent you want email messages to be automatically sent and downloaded on your device.

Note Tap **Review all download settings** to select download options, set the email format as HTML or plain text, and more. For more information, see “Customizing Download and Format Settings” on page 164.

9. Tap **Finish**.

Creating a New Email Message

To start from an empty message:

1. On the TouchFLO 3D Home screen, slide to the **Mail** tab.
2. Select the email account you want to use on the right side of the screen.

Tip To choose from other email accounts that are not displayed on the **Mail** tab, touch **Menu > Accounts > Accounts** and then select an email account from the **Account Selection** screen.

3. Touch the **New Mail** icon () to create a new email message.

To send an email message to a favorite contact:

1. On the TouchFLO 3D Home screen, slide to the **People** tab.
2. Swipe your finger on the screen to flip through the photos of your favorite contacts.
3. When the photo of the desired contact is displayed, touch the displayed photo and then touch **Send e-mail**.

For more information about working with favorite contacts, see “People” on page 40.

Tip You can also touch **Start > Contacts**, select a contact name, and then touch **Send e-mail**.

Composing and Sending an Email Message

After creating a new email message, follow the steps below to enter your message and then send it.

1. To add recipients, enter their email addresses, separating them with a semicolon. You can also tap **To** if you want to add email addresses stored in **Contacts**.
2. Enter a subject and compose your message.

Tip To choose from preset messages, tap **Menu > My Text** and tap a desired message. To check the spelling, tap **Menu > Spell Check**.

3. Tap **Send**.

Tip

- For more information about entering text and symbols, see “Entering Text” on page 54.
- To set the message priority, tap **Menu > Message Options**.
- If you are working offline, email messages are moved to the **Outbox** folder and will be sent the next time you connect.

To add an attachment to a message:

1. In the message that you are composing, tap **Menu > Insert** and tap the item you want to attach: **Picture**, **Voice Note**, or **File**.
2. Select the file or picture you want to attach, or record a voice note.

Filtering the Inbox Message List

When the Inbox on your device is full of messages, you can filter your Inbox to display only the messages that contain a particular sender or subject you are searching for.

To filter your Inbox:

Enter the sender name or email subject you want to look for. As you type characters, the message list narrows down to the sequence of characters you have entered.

For example, entering “B”, and then “E” narrows the list to only the emails that contain sender names and email subjects that start with “BE.”

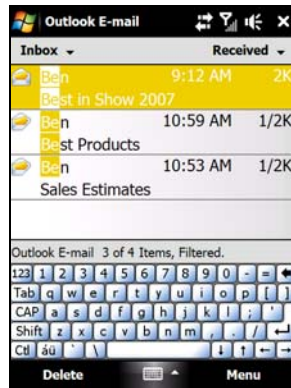

Viewing and Replying to Messages

To download a complete email message:

By default, each email received in the inbox on your device contains only the first few kilobytes of the message. When you open an email message, it displays only the headers and part of the message. You must download the whole email to view the complete content.

To download a complete email message, open the email and then do one of the following:

- ▶ Finger-scroll to the end of the message, and tap **Get entire message and any attachments** (POP3 email account) or tap **Get the rest of this message** (IMAP4 and Outlook email accounts).

— or —

Tap **Menu > Download Message**.

Notes

- The Fetch Mail feature, which is available for POP3 and IMAP4 Internet email accounts, downloads an entire email without the need for you to perform a full synchronization. This limits the download to just the email message that you want and helps save data cost. Fetch Mail is also available for Outlook Email. See “Instant Email Download Using Fetch Mail” on page 171 for details.
- Downloading may take some time, depending on the speed of your Internet connection, email file size, and whether file attachments are automatically downloaded.

To download file attachments:

- **POP3 email account:** File attachments of a POP3 Internet email account are automatically downloaded when you download a complete email.
- **IMAP4 and Outlook email accounts:** File attachments appear below the subject of an email message. Tapping an attachment opens the attachment if it has been fully downloaded or marks it for download the next time you send and receive email.

You can set automatic downloading of file attachments. See “Customizing Email Settings” on page 167 for details.

To reply to or forward a message:

1. Open the message and tap **Menu > Reply**, **Menu > Reply All**, or **Menu > Forward**.
2. Enter your response, and then tap **Send**.

Notes

- You can receive and view HTML email from any type of email account. The HTML format is retained, without layout shifting or resizing. HTML email support in Outlook Mobile is available only if you are synchronizing your device with Microsoft Exchange Server 2007.
- When replying using an Outlook email account, you can customize ActiveSync to exclude addresses, including your own, from being added to the recipient list. Tap **Menu > Options...** in ActiveSync, select the **E-mail** item, tap **Settings**, and then tap **Advanced**. In the **My e-mail addresses** box, enter email addresses you want to exclude.

Synchronizing Email

Synchronizing email ensures that new email is downloaded to the device Inbox folder, that in the Outbox folder is sent, and that email deleted from the server is removed from your device. The exact way that you synchronize email depends on the type of email account you have.

To automatically synchronize an Outlook email account:

1. Connect your device to your computer through USB or Bluetooth. Otherwise, connect through Wi-Fi or a data connection if you are synchronizing Outlook email with the Exchange Server. For more information, see “Ways of Connecting to the Internet” on page 137.
2. Synchronization automatically begins, and your device sends and receives Outlook email.

To manually synchronize your Outlook or Internet email account:

1. Tap **Start > Messaging**, and then select your Internet email account.
2. Tap **Menu > Send/Receive**.

Customizing Email Settings

To change the download size and format for Outlook email:

1. Disconnect your device from the computer.
2. Tap **Start > Programs > ActiveSync**.
3. Tap **Menu > Options...**, select **E-mail**, and then tap **Settings**.
4. On the E-mail Sync Options screen:
 - Under **Message format**, select HTML or Plain text.
 - Under **Download size limit**, select the desired email size.
5. Close ActiveSync and reconnect your device to the computer.

To change the download size and format for Internet email:

1. Tap **Menu > Options** on the Account Selection screen, or tap **Menu > Tools > Options...** while you're in a message list.
2. Tap your POP3 or IMAP4 Internet email account.
3. Tap **Download Size Settings**.
 - Under **Message format**, select HTML or Plain text.
 - Under **Download size limit**, select the desired email size.
4. Tap **Done**.

To automatically receive attachments on Outlook email:

1. Tap **Start > Programs > ActiveSync**.
2. Tap **Menu > Options**.
3. Tap **E-mail > Settings**, and then select **Include file attachments**.

To automatically receive attachments on IMAP4 email:

1. Tap **Menu > Options** on the Account Selection screen, or tap **Menu > Tools > Options...** while you're in a message list.
2. Tap the name of your IMAP4 email account.
3. Tap **Download Size Settings**.
4. In **Download attachments**, select a download size or select **All attachments**.
5. Tap **Done**.

To store attachments on the microSD card:

1. Tap **Start > Messaging**.
2. Tap **Menu > Options > Storage** tab.
3. Select the **When available, use this storage card to store attachments** check box

Working With Company Email and Meeting Appointments

To keep up-to-date with your company email and meeting schedules while you're out of the office, you can connect your device to the Internet through Wi-Fi or your Sprint connection and synchronize with your company's Exchange Server. This section shows you how to set up an Exchange Server connection on your device so that you can access your Outlook email and synchronize other information such as calendar appointments with your company's Exchange Server.

Setting Up an Exchange Server Connection

Before you can synchronize or access information on the Exchange Server, you need to set up an Exchange Server connection on your device. You need to get the following information from your network administrator and enter them on your device:

- Exchange Server name (must be Outlook Web Access server name)
- Domain name
- User name and password that you use at work

If you have not synchronized your device with your computer, follow these steps to set up an Exchange Server connection.

1. Tap **Start > Programs > ActiveSync**.
2. Tap **Menu > Add Server Source**.
3. Enter your **E-mail address**, and ensure that the **Attempt to detect Exchange Server Settings automatically** check box is selected. By selecting the option, the device attempts to download exchange server settings so that you do not need to enter them manually. Tap **Next**.
4. Enter your **User name**, **Password**, and **Domain**. Exchange Server settings and the password are case-sensitive, so be sure to enter uppercase and lowercase letters correctly. Select the **Save password** check box if you want to save your password so that you do not need to enter it again. Tap **Next**.
5. After Automatic Configuration finishes, enter the **Server address**. Tap **Next**.

Note If SSL authentication is required, select the **This Server requires an encrypted (SSL) connection** check box.

6. Select the check boxes of the items that you want to sync with the Exchange Server.

Tips

- To change synchronization settings of an information item, for example, **E-mail**, select the check box, and then tap **Settings**.
- If you synchronized email with your computer before, you will not be able to select the **E-mail** item. You need to cancel the **E-mail Setup Wizard** first, tap **Start > ActiveSync > Menu > Options**, and then clear the **E-mail** check box under the **Windows PC** group of items.
- To change the rules for resolving synchronization conflicts, tap **Menu > Advanced**.

7. Tap **Finish**.

Notes To change Exchange Server settings, open **ActiveSync** on your device, and then tap **Menu > Configure Server**.

Starting Synchronization

Before you start synchronizing with the Exchange Server, make sure your device has been set up with a Wi-Fi or data connection to the Internet so that you can synchronize over the air. For more information about connections, see “Ways of Connecting to the Internet” on page 137.

After you finish setting up an Exchange Server connection, your device automatically starts synchronization.

To manually start synchronization:

- ▶ On the TouchFLO 3D Home screen, slide to the **Settings** tab and then touch **Sync Data**.
- or -
Tap **Start > Programs > ActiveSync** and then tap **Sync**.

Note If you connect your device to your office computer via a USB or Bluetooth connection, you can use this connection to the computer to “pass through” to the network and download Outlook email and other information to your device.

Working With Company Email

Your device gives you instant access to your company email and lets you manage your messages easier. Direct Push, Fetch Mail, Remote email search, and email flags are just some of the tools you can use to manage your emails. This section shows you how to use these tools to manage your email.

Note Some messaging features depend on the Microsoft Exchange Server version used in your company. Check with your network administrator for the availability of these features.

Automatic Synchronization Using Direct Push

Direct Push technology (push email feature) enables you to receive new email messages on your device as soon as they arrive in your Inbox on the Exchange Server. Items such as contacts, calendar, and tasks are also immediately updated onto your device when these items have been changed or new entries have been added on the Exchange Server. To make Direct Push work, you need to have a Wi-Fi or data connection on your device.

You need to perform a full synchronization between your device and the Exchange Server first before Direct Push can be enabled.

Requirement The Direct Push feature works for your device only if your company is using Microsoft Exchange Server 2003 Service Pack 2 (SP2) with Exchange ActiveSync or higher version.

You can turn on Direct Push in the Comm Manager or ActiveSync.

To turn on Direct Push in Comm Manager:

1. To open the Comm Manager, slide to the **Settings** tab on the TouchFLO 3D Home screen and then touch **Communications**.
2. On the Comm Manager screen, touch **Microsoft Direct Push**.

To turn on Direct Push in ActiveSync:

1. Tap **Start > Programs > ActiveSync** and then tap **Menu > Schedule**.
2. Select **As items arrive** in the **Peak times** and **Off-peak times** boxes.

Note When Direct Push is off, you need to manually retrieve your emails.

Scheduled Synchronization

If you do not want to use Direct Push, you can set a regular schedule for synchronizing Outlook email and information.

1. In ActiveSync on your device, tap **Menu > Schedule**.
2. Select a shorter time interval in the **Peak times** box for you to be able to receive emails more frequently. (Peak times usually refer to your working hours when email volume is high).
3. Select a longer interval in the **Off-peak times** box.

Tip To set the days and hours that make up your peak and off-peak times, tap the **peak times** link at the bottom of the screen.

Instant Email Download Using Fetch Mail

The **Fetch Mail** feature downloads an entire email message immediately without the need for you to perform a full Send/Receive action. This limits the download to just the email message that you want and helps to reduce data service charges.

Requirement *Fetch Mail works for your device only if your company is using Microsoft Exchange Server 2007 or higher.*

1. On the TouchFLO 3D Home screen, slide to the **Mail** tab, select your **Outlook** account, and then tap **Inbox**.
2. Open an email message.
3. By default, only the first few words of the message is shown. To download the whole email message, finger-scroll to the end of the message, and then tap **Get the rest of this message**.
4. Wait for the remainder of the message body to download.

Notes

- For information about changing email sync options such as setting the download size for email, see “Customizing Email Settings” on page 167.
- When you receive an email message that contains a link to a document such as a PDF or Microsoft Office document located on SharePoint or an internal file server, you can tap the link to view the document on your device. You can view the document only if you have a Microsoft Outlook account that synchronizes with Microsoft Exchange Server 2007 or later. Exchange Server must also be set up to allow access to SharePoint document libraries or internal file servers.

Searching for Email on the Exchange Server

You can access email that is not available on your device by searching your Microsoft Exchange Server mailbox. The search results are downloaded and displayed in a Search Results folder.

Requirement *Your company must be using Microsoft Exchange Server 2007 or higher.*

1. Tap **Start > Messaging > Outlook E-mail**.
2. Tap **Menu > Tools > Search Server**.
3. In the **Look for** text box, enter the search keyword.
4. Choose the date range of messages to search from.
5. In the **Look in** list, specify whether to search in the **Inbox**, **Sent Items**, or **All Folders**.
6. Tap **Search**.

Tip *To clear the search results and return to the message list, tap **Menu > Clear Results**.*

Flagging Your Messages

Flags serve as a reminder for you to follow up on important issues or requests contained in email messages. Flagging messages, which has been a useful feature on desktop Outlook Email, can also be done in Outlook Mobile on your device. You can flag received email messages on your device.

Requirement *Flags are enabled only if emails are synchronized with Microsoft Exchange Server 2007 or higher. Flags are disabled or hidden if email is synchronized with earlier versions of Microsoft Exchange Server.*

To flag or unflag a message:

1. Open Outlook on your device and access the Inbox.
2. Select a message or open a message.
3. Tap **Menu** > **Follow Up** and select one of the following options:

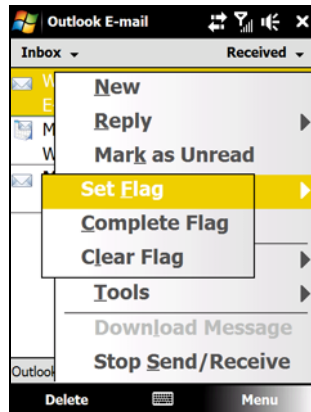

- **Set Flag** to mark the message with a red flag to indicate that it needs following up.
- **Complete Flag** to mark the message with a check mark to indicate that the issue or request in the email is already completed.
- **Clear Flag** to remove the flag to unmark the message.

Note Email message reminders are displayed on your device if the messages are flagged with reminders and synchronized from the Exchange Server.

Out-of-office Auto-reply

Outlook Mobile allows you to retrieve and change your out-of-office status. Just like desktop Outlook Email, Outlook Mobile automatically sends an auto-reply message when you're not available.

To send out-of-office auto-reply messages:

1. Tap **Start** > **Messaging** > **Outlook E-mail**, and then tap **Menu** > **Tools** > **Out of Office**.

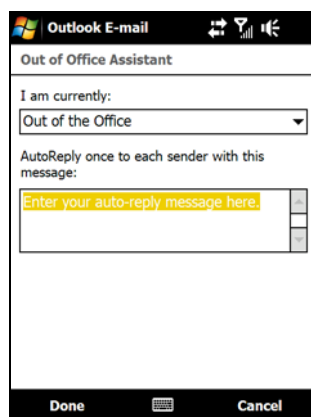

2. In the *I am currently* list, select **Out of the Office**.
3. Enter your auto-reply message, and then tap **Done**.

Managing Meeting Requests

When you schedule and send meeting requests from your device, you can invite attendees to your meeting and check their status to know about their availability.

When you receive a meeting request, you can reply by accepting or declining the request. The meeting request also clearly indicates whether there are conflicting or adjacent meetings.

Requirement Your company must be using Microsoft Exchange Server 2007 or higher.

To reply to a meeting request:

1. When you receive a meeting request by email, a notification will be displayed on your device. Open the email.
2. Tap **Accept** to reply and accept the meeting request, or tap **Menu > Decline** if you cannot attend the meeting.

Tips

- Before responding, you can check your availability during the time of the requested meeting by tapping **View your calendar**.
- If the time of the meeting conflicts with your other appointments, a "Scheduling Conflict" status appears on top of the email.

3. Choose whether to edit your response email before sending it, and then tap **OK**.

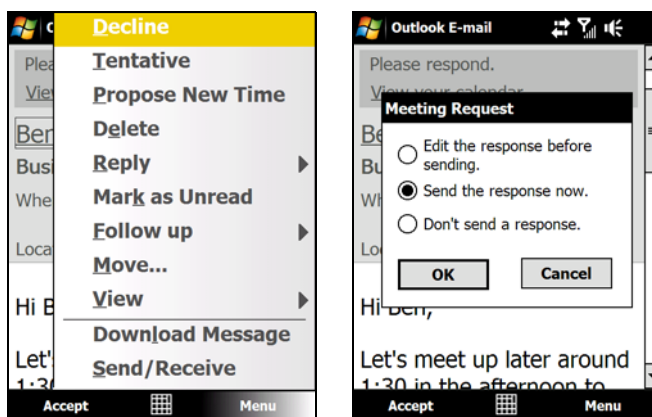

If you accepted the meeting request, it will automatically be added as an appointment in Calendar on your device.

To view the list of meeting participants:

1. Tap **Start > Calendar**.
2. Tap a meeting request that you sent and then tap **Attendees**. The required and optional attendees will be listed.

Icons indicating whether each attendee has accepted or declined the meeting request will also be displayed.

Tips

- To see the icon indicators in the attendees list, make sure Calendar is synchronized with the Exchange Server.
- For information about creating a meeting request, see "Sending a Meeting Request" on page 72.
- To view an attendee's contact information, tap the attendee's name. If the attendee is included in your contacts list, you will see the contact information immediately. If the attendee is not in your contacts list, tap **Company Directory** to view the contact information.

Finding Contacts in the Company Directory

In addition to having contacts on your device, you can access contact information from your organization's Company Directory. By having over-the-air access to the Company Directory, you can easily send email messages and meeting requests to anyone in your company.

Requirement Access to the Company Directory is available only if your organization is running Microsoft Exchange Server 2003 SP2 or higher, and you have completed your first synchronization with the Exchange Server.

1. Synchronize with the Exchange Server.
2. Do any of the following:
 - In Contacts, tap *Menu > Company Directory*.
 - In a new email message, tap the *To* box (or tap *Menu > Add Recipient*), and then tap *Company Directory* on the top of the list.

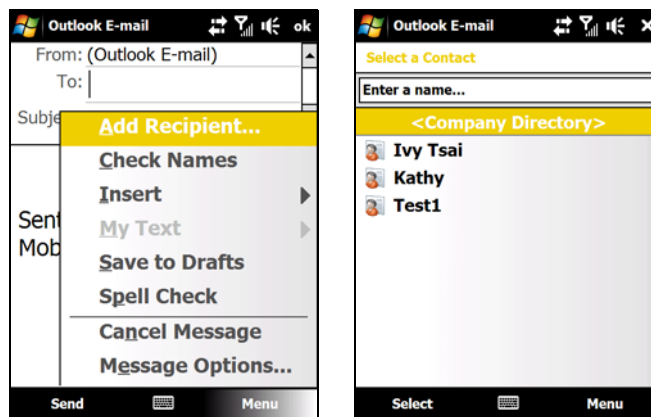

- When creating a meeting request and selecting required and optional attendees in Calendar, tap *Company Directory*.
3. Enter a partial or full contact name and tap *Search*. In the search results list, tap a contact to select it.

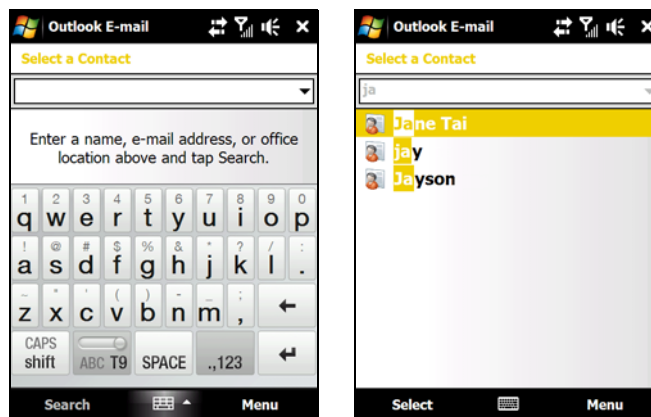

Notes

- You can save a contact from the Company Directory to your device by selecting the contact, and then tapping *Menu > Save to Contacts*.
- You can search on the following information as long as that information is included in the Company Directory: First name, Last name, Email name, Display name, Email address, or Office location.

Entertainment: TV, Music, and Video

- ◆ *TV (page 175)*
- ◆ *Sprint Music Store (page 177)*
- ◆ *YouTube (page 179)*
- ◆ *Streaming Media (page 183)*

Sprint TV gives you the ability to listen to audio clips and to view video clips right from your device's display. Watch live TV and catch up on episodes of your favorite shows – anywhere on the Sprint National Network.

Sprint Music Store lets you preview, purchase, download, and listen to over a million songs right on your device. You can even add songs from your own library to round out your on-the-go playlist.

TV

Your Sprint TV Channel Options

The Sprint TV application offers a wide variety of accessible channels. Subscription options include comprehensive basic packages as well as a full menu of “a la carte” channels. Visit www.sprint.com for more information on channels and pricing.

Some of the available categories may include:

- Sprint Radio
- Sprint Power View
- Primetime TV
- Music Videos
- Sprint TV Live
- Music & Radio
- Sports
- Entertainment
- Cartoons
- News & Weather
- Movies & Shorts
- Mobile Previews

Tip Available categories and content are subject to change.

Playing a Video or Audio Clip

1. On the TouchFLO 3D Home screen, slide to the *Sprint TV* tab and then tap *Launch*.
– or –
Tap *Start > Programs > Sprint TV*.
2. Tap *Continue* to connect to data services.
3. Select *Sprint TV*, *Sprint Radio*, *Sprint Movies*, or *Premium Channels* to display channel options.
4. Use the Navigation Control and press the **Enter** key to select a channel from the Sprint TV listings or to select an available category.

Note The first time you access a channel, you will be prompted to purchase access (unless the channel doesn't have a monthly fee). Select **Subscribe** to purchase access, or select **Preview** to view a preview of the selected channel.

5. If applicable, select a clip and tap **OK** to view the program. The clip will automatically load and begin playing.

Tip

While you are playing a clip, you can press the Navigation Control up or down to surf to a different channel. A small pop-up screen will be displayed that tells you which channel you are watching as well as other channels that you have access to. Use the Navigation Control to scroll through the channels. Once you find a channel that you want to watch or listen to, scroll to it and tap **OK** (or simply wait approximately three seconds), and the channel will begin loading.

Sprint TV FAQs

1. **How long are the clips? Will I know the estimated time it will take to play the clip prior to accessing it?**

Once you have selected a channel, you will see a listing of the available clips, with each clip's length displayed after the clip's title. In general, a clip's duration will depend on the story or content being provided, and can be fairly short or as long as a few minutes.

2. **Can I access a clip wherever I am, as long as I have my device?**

As long as you are on the Sprint National Network, you will have access to the audio and video clips.

3. **Are the videos that I'm viewing "live" videos?**

It depends on the content provider. Some of the channels available through Sprint TV stream live content. Others provide media on demand with video and audio clips that are refreshed throughout the day, but that are not "live."

4. **After purchasing access to an Available Channel for a monthly fee, do I receive any confirmation? That is, how do I know it has been purchased?**

The next time you access the channel, you bypass the Preview/Purchase page and go directly to the available content.

5. **If I don't subscribe to a data services plan from Sprint, will I still be able to view the multimedia clips?**

Yes. For service access charges, please consult your Sprint service plan or [visit www.sprint.com](http://www.sprint.com).

6. **What does it mean when the video pauses and I see the word "loading" at the bottom of the screen?**

This happens when the phone is loading the data necessary to play the clip. It typically occurs when there is heavy traffic on the network.

7. **How can I cancel service if I decide I don't want it?**

To cancel your Sprint TV service, visit www.sprint.com and sign on to My Sprint Wireless with your account number and password. From this page, you have the ability to cancel the service or any channels to which you subscribe.

8. **Can I surf to a different channel while I am playing a clip?**

Yes. While you are playing a clip, you can press the Navigation Control up and down to surf to a different channel. A small pop-up screen will be displayed that tells you which channel you are watching as well as other channels that you have access to. Use the Navigation Control to scroll through the different channels. Once you find a channel that you want to watch, scroll to it and press (or simply wait approximately three seconds), and the channel will begin loading.

Sprint Music Store

The *Sprint Music Store* enables you to purchase and download digital music files to play on your device.

Accessing the Sprint Music Store

From the *Sprint Music* tab of the Home screen, you can connect to the Sprint National Network and access the Sprint Music Store. When you enter the store for the first time, you will be prompted to set up your user identification and password.

1. On the *Sprint Music* tab of the Home screen, touch the *Sprint Music Store* icon.

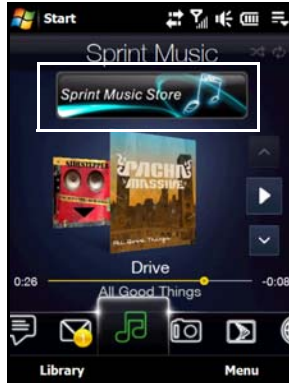

2. Follow the onscreen instructions to establish your User ID and password.

Tip Your User ID for the Sprint Music Store is your 10-digit wireless phone number. The password may be any 4-digit number.

3. After you have entered your password, highlight *Create New Account* and tap *OK*.
4. Use the Navigation Control to explore the store.

Purchasing and Downloading Music

Now that you're in the store, you can shop for songs to purchase and download to your device's main memory or a microSD card.

1. From the Sprint Music Store opening page, select an option to browse the store:

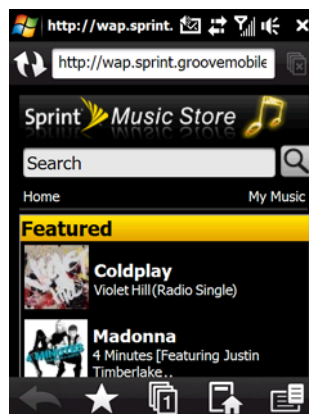

- **Featured Music** offers a revolving selection of highlighted songs and artists.
 - **Genres** allows you to choose from different types of music such as Hip Hop/Rap, R&B, Pop, Inspirational songs, and more.
 - **Categories** allows you to choose from other types of categories.
 - **Search** gives you the option of searching for specific songs or artists. Just use one of the onscreen keypads of your device to enter your search criteria in the available field.
2. Select a song by tapping on the song title. and tap **OK**. (The song information screen will be displayed.)
 3. Tap **Preview** to play the selected song.
 4. When you are ready to purchase the song, tap on the displayed price. This confirms your purchase and begins the download process.
- The song will be downloaded to your device (\Music).

Note If you have a microSD card inserted, you have the option to download the song to it.

Once the song has been downloaded to your device's meom, you will be able to immediately listen to it, add it to a playlist, or continue shopping.

Playing Music

- ▶ The **Sprint Music** tab of the Home screen allows you to play the song that you purchased and downloaded to your device. See "Sprint Music" on page 44 for details.

Receiving an Incoming Call While Playing Music

An incoming call causes the currently played music file to be paused while the phone call is active. Once the current call is ended, you can select to resume any paused applications. (Music will resume playing automatically.)

1. When you receive an incoming call, tap **Answer** on the Phone screen.
2. When you are done with your call, tap **End Call** on the Phone screen or press the **End** key to end the call. The previously paused application then resumes.

Backing Up Your Downloaded Music Files

When you purchase and download a music file from the Sprint Music Store, you get two versions of the song: one to download and play on your device (file type: AAC+), and another to download from <http://musicstore.sprint.com> and play on your computer (file type: WMA). The AAC+ files downloaded to your device can only be played on your device and on your account, and once they have been downloaded, they cannot be downloaded again without being repurchased.

Sprint recommends you back up your AAC+ music files to your computer so you can access the files in case your device is lost or damaged, or if you buy a new device.

1. Use your computer to navigate to the Music folder of your device (that is, go to this path: \Music).

Note If you downloaded the music files to the microSD card, go to \Storage Card.

2. Select and copy the music files to a folder on your computer's hard drive.

Note Although you can store AAC+ files on your computer, they will only be playable on your device and on your account.

YouTube

YouTube™ lets you browse, search, and watch video clips from the YouTube server. This section shows you how to use the YouTube application on your device to browse, search, watch, and bookmark videos from YouTube.

Note You need an active connection to use YouTube. If you are using a data connection, your data connection bill may increase significantly due to large file sizes of the videos.

Introducing the YouTube Screen

Tap *Start > Programs > YouTube* to open the YouTube application.

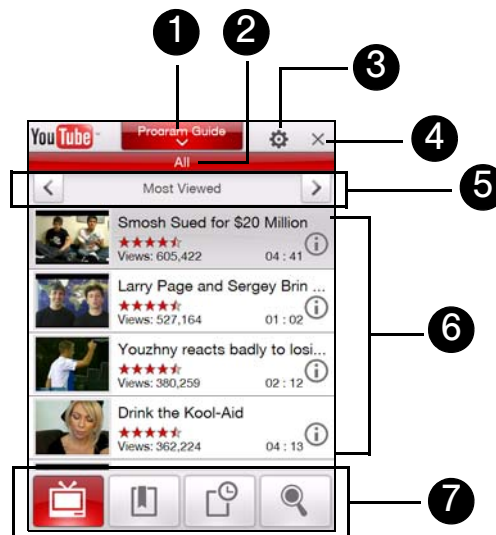



1. **Program Guide.** Tap to open the Program Guide list. The Program Guide list only appears if you are subscribed to a channel.
2. **Channel.** Displays the current program channel being viewed.
3. **Settings.** Tap to set video playback quality.
4. **Exit.** Tap to close YouTube.
5. **Left and Right Arrows.** Tap the arrows to filter the list by *Most Viewed*, *Top Rated*, and *Featured*.
6. **Video List.** Displays the available videos for the selected program channel. Tap a video to watch it.
7. **About.** Tap ⓘ to view details about the video.
8. **Tabs.** Tap these tabs to switch between the different YouTube screens: *Videos*, *Bookmarks*, and *Search*.

Browsing for Videos



The Program Guide list lets you change the program channel so you can browse different types of videos available on the YouTube server. By default, there is only one channel in the Program Guide.

To add a new program channel into the Program Guide list:

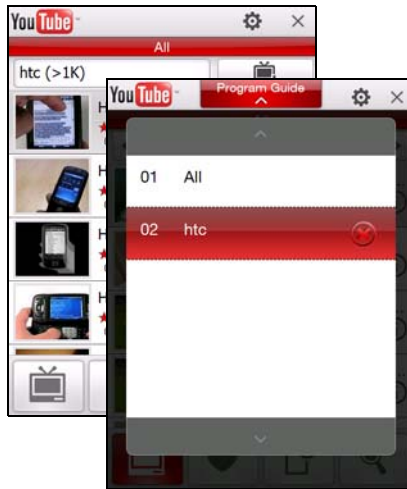
1. On the YouTube screen, tap .
2. On the **Search** screen, enter the channel you want to add to the Program Guide list.
3. Tap **Search**. YouTube searches for the channel and then displays the available videos from it.
4. Tap  and then tap **OK** on the confirmation screen. The channel you just subscribed to will now be shown when you tap **Program Guide**.



Tip

You can also add a YouTube user as a program channel. To add, tap  in any of the YouTube screens and then tap .

To change the program channel:

1. On the **Videos** screen, tap **Program Guide** at the top of the screen.
2. On the Program Guide list, select a channel.
3. The video list refreshes to display the available videos for the newly selected channel.

To delete a program channel from the Program Guide list:

You can only delete program channels that you have added to the Program Guide list.

1. On the **Videos** screen, tap **Program Guide**.
2. Scroll down to the channel you want to delete and then tap .
3. On the confirmation screen, tap **Yes**.

Watching Videos

In the Videos, Bookmarks, or History screens, tap a video to launch the YouTube Video Player.



1. **Slider Bar.** Drag to go forward or backward in the video.
2. **Rewind.** Tap to go back to the beginning of the video.
3. **Play/Pause.** Tap to toggle between playing and pausing the video.
4. **Stop.** Tap to stop the video playback.
5. **Resize.** Tap to resize the video to fit the screen. Tap again to go back to actual size.
6. **Download Progress.** Shows how much of the video has been downloaded.

When you tap **Stop** () or finish watching the entire video, you are presented with options on what you can do next.

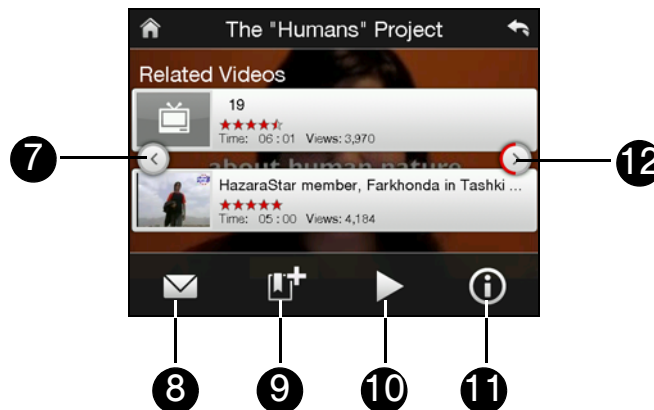

7. **Previous.** Tap to go back to the previous page of related videos.
8. **Send.** Tap to send the link to the video you just watched to another person using one of the Messaging accounts.
9. **Add Bookmark.** Tap to add the video to your Bookmarks.
10. **Play.** Tap to play back the video again.
11. **About.** Tap to view details about the video you just watched.
12. **Next.** Tap to go to the next page of related videos. If no action is taken, it automatically goes to the next page after 10 seconds.

Tip To adjust the volume, press the Volume Up or Down keys at the left side of the device.

Using the Navigation Control

You can also use the Navigation Control to control the video playback.



Control	Use
Enter Key	Toggle between playing and pausing video playback.
Navigation Control Right (landscape orientation)	Press and hold to go forward in the video.
Navigation Control Left (landscape orientation)	Press and hold to go back in the video.
Volume Up or Down	Press to adjust the volume.

Bookmarks



You can save frequently viewed videos to Bookmarks for quick access.

To view Bookmarks:

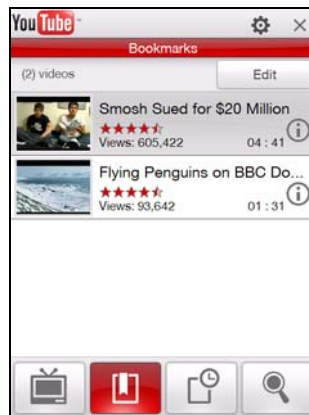
- ▶ On the YouTube screen, tap . Tap a video to watch it.



To add a video into Bookmarks:

- ▶ After watching a video, tap .
 - or –
 - On the list of videos, tap  on the video you want to add to Bookmarks and then tap Bookmark.

To delete a video from Bookmarks:

1. On the **Bookmarks** screen, tap **Edit**.
2. Tap  on the video you want to remove from Bookmarks.
3. On the confirmation screen, tap **Yes**.
4. Tap **Done**.

History

View recently watched videos on the History screen.

To view *History*:

- ▶ On the YouTube screen, tap . Tap a video to watch it.

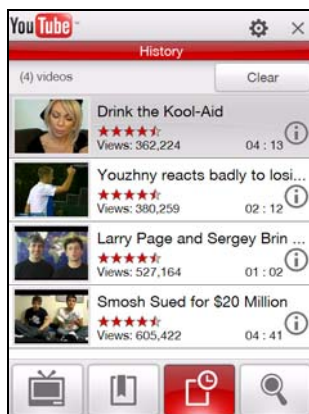

Note To clear the History list, tap **Clear**.

Streaming Media

Streaming Media lets you stream live broadcasts or on-demand media content from the Web. The media is sent in a continuous stream to your device and is played as it arrives, along with the audio.

The Streaming Media program allows you to play 3GP and MPEG-4 files. It also supports playback of SDP (Session Description Protocol) files.

To access streaming content via *Opera Mobile*:

In Opera Mobile, you can open a Web page containing RTSP (Real Time Streaming Protocol) links to streaming media content then play the content in the Streaming Media program.

1. On the Home screen, slide to the **Internet** tab, and then tap **Browser**.
2. In the address bar, enter the URL address of the Web page that contains the RTSP link to the desired *.3gp, *.mp4, or *.sdp file.
3. On the Web page, tap the RTSP link.
4. Streaming Media then automatically opens and starts playing the file. During playback, use the button controls to play or pause the stream, switch to full-screen mode, rewind, and fast forward.

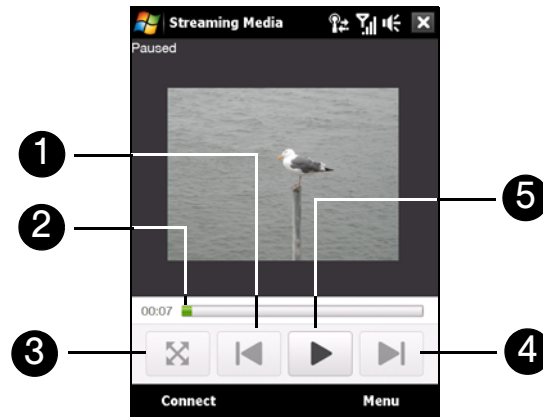

1. Touch to rewind the media file.
2. Touch and then drag to go backward or forward in the video.
3. Touch to switch to full-screen mode. Touch the screen again to exit full-screen mode.
4. Touch to fast forward the media file.
5. Touch to toggle between playing or pausing the playback.

To stream media files directly on the Streaming Media Player:

Streaming Media only supports RTSP links when you stream *.3gp and *.mp4 files directly on the program.

Note Before you launch the Streaming Media program, make sure that you are connected to the Internet.

1. Tap **Start > Programs > Streaming Media**.
2. From the program, tap **Connect**.
3. Enter the URL for the Web site (rtsp://) and the file name.
4. Tap **Connect**.
5. Streaming Media then starts playing the file. During playback, use the button controls to play or pause the stream, switch to full-screen mode, rewind, and fast forward.

To view streaming video information:

- ▶ Tap **Menu > Properties** to view the properties and general information of a streaming video clip, such as video codec, audio codec, dimension, frames, and duration of the video.

To configure streaming video connection settings

- ▶ Tap **Menu > Options** to configure the following settings:
 - **Playback tab.** Specify the memory space (in terms of duration) to reserve for storing video and audio data while streaming media.
 - **Networks tab.** Choose the connection to use and specify a range of port numbers to use for streaming.
 - **Video tab.** Select the **Use Landscape mode when watching in full screen** check box to automatically switch to landscape mode when watching in full-screen mode.

GPS Navigation

- ◆ *Guidelines and Preparation for Using GPS (page 185)*
- ◆ *Downloading Satellite Data via QuickGPS (page 186)*
- ◆ *Using Sprint Navigation (page 187)*

Use your device's built-in GPS capabilities and the Sprint Navigation software to easily access both directional information and location-specific features such as nearby businesses, services or other points of interest. Sprint Navigation also provides turn-by-turn driving directions onscreen and by voice right on your device.

Guidelines and Preparation for Using GPS

Please follow these guidelines before and when using your device as a GPS device.

- Do not attempt to set or adjust the GPS system while driving.
- When using the device inside a vehicle, use the car holder to mount the device securely in place. Avoid placing the device in the areas shown in the following diagram:

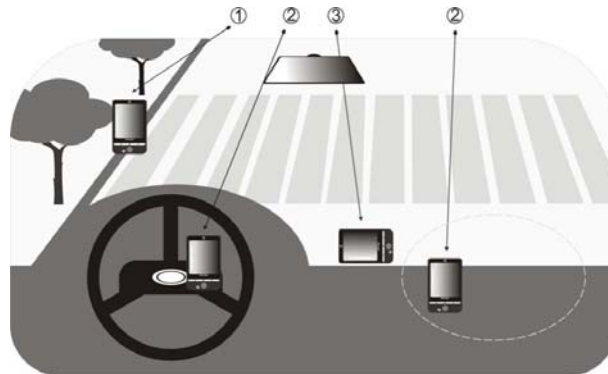

1. Do not place where it will block the driver's vision.
 2. Do not place where air bags could deploy.
 3. Do not place anywhere in the vehicle without securing the device in the holder.
- The GPS signal cannot pass through solid non-transparent objects. Signal reception may be affected by obstructions such as high-rise buildings, tunnels, bridges, forests, and weather conditions. Even metal in the overhead visors could block GPS reception.
 - Wireless communication products (such as mobile phones or radar-detecting devices) may interfere with the satellite signal, resulting in unstable signal reception.
 - The Global Positioning System (GPS) is maintained by the United States Department of Defense. Any changes that the DOD makes may affect the accuracy and function of the GPS system.
 - Do not leave your device in a vehicle or expose the device to direct sunlight to avoid overheating the battery, which could cause damage to the device or the vehicle.

Downloading Satellite Data via QuickGPS

Before you start using your device for GPS navigation, open the **QuickGPS** program first to download ephemeris data (current satellite position and timing information) to your device. This data is needed to determine the GPS position of your current location.

QuickGPS downloads data from a Web server using the Internet connection on your device (Wi-Fi, ActiveSync, or data services). This significantly speeds up the time for determining your GPS position.

To open **QuickGPS**:

- ▶ Tap **Start > Programs > QuickGPS**.

To download data:

- ▶ Tap **Download** on the QuickGPS screen.

You will initially see onscreen the **Valid time** for the downloaded data. This will continue to update until the time runs out.

To speed up GPS positioning, download the latest ephemeris data when the validity of the data expires.



Download Options

To configure download times, tap **Menu > Options** and choose from the available options:

- **Remind me when data expires.** Enables your device to display a reminder message when the validity of the ephemeris data has expired. When you see the reminder message, tap **Menu** to dismiss the reminder or to set the snooze time so that you will be reminded again. Tap **OK** to open the QuickGPS program and download the latest data.
- **Autodownload when data expires.** Allows ephemeris data to be automatically updated onto your device when the data has expired.
- **Autodownload when connected to PC via ActiveSync.** Allows ephemeris data to be automatically downloaded via ActiveSync to your device when your device is connected to your computer. Your computer must be connected to the Internet in order to download data.

Note The data is stored on Web servers. QuickGPS is preconfigured to connect to these servers.

Using Sprint Navigation

Sprint Navigation™ utilizes GPS positioning technology and access to Sprint's wireless data network to provide you with driving directions and a host of other services including:

- GPS navigation that gives you turn-by-turn directions to any destination address in the continental United States. If you miss a turn or get off track, Sprint Navigation will calculate a new route for you. You can enter a destination address by using Sprint Navigation's automatic voice recognition system or by typing on the your device's onscreen keypad.
- Audio and visual traffic alerts while driving or viewing maps, as well as traffic rerouting capabilities to minimize delays.
- Maps of the area around your current location, a marked Favorite, or an address you enter manually or have previously entered. You can pan the map (adjust left/right/up/down) and zoom in or out.

Launching Sprint Navigation

1. To launch Sprint Navigation on your device, tap the Sprint Navigation icon on the *Programs* tab.

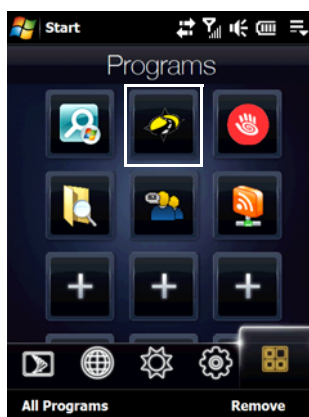

After starting Sprint Navigation, you will see a splash screen for a few seconds.

2. Type in your *First Name*, *Last Name*, and *Email Address*, and then tap *Login*.

3. You will then see a safety warning. If you agree to the conditions listed, tap *Go*.
4. You can choose to take a brief tour of Sprint Navigation or proceed directly to the application.

Note *The Product tour is only displayed the first time you log into Sprint Navigation. If you would like to access the Product Tour again after your first login, you can access it from the Tools/Extras menu.*

Using Sprint Navigation

The Main Menu

After logging into Sprint Navigation, you will be taken to the application's Main menu.

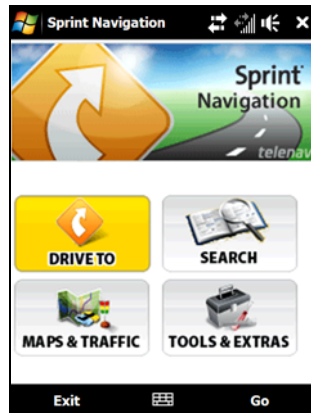

- **Drive To** lets you get driving directions by address, recently entered locations, airport code or business name.
- **Search** provides you with different ways to provide the addresses and phone numbers of banks, restaurants, gas stations, emergency services, and other hard to find locations.
- **Maps & Traffic** allows you to view map and traffic information for your current location, favorite places, a business, specific addresses, and more.
- **Tools & Extras** gives you options for setting preferences and other features.

Entering an Address

With Sprint Navigation, there are two ways to enter an address – by typing it or by speaking it. To access the address entry menu, tap **Drive To** and then tap **Address**. You will then see the following options:

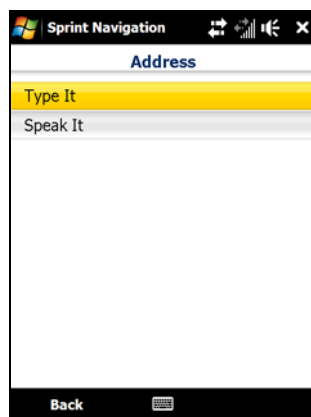

- **Type It** allows you to enter a street address by typing it in the appropriate fields.
 1. On the Address screen, tap **Type It**.
 2. Enter the street name. You may type in a partial entry (five or more letters) for the street name.

Note You can always leave the street address field blank and type in a city to perform a city search. The **City** and **State** fields have an auto-fill feature, so you usually will not have to type in the whole name of the city or state.

3. Tap **Done** to submit the address.

Note *To quickly clear the fields, choose **Menu > Clear All** on the address screen.*

4. Sprint Navigation checks to see if the address you entered can be found. Sprint Navigation prompts you to modify the address if it is too new to be found in the mapping database or if the street number cannot be found for some other reason.

After submitting the address, you will be taken to the trip confirmation street and you are ready to begin your trip.

● **Speak It** allows you to enter a street address by calling in and dictating the address.

1. On the Address screen, tap **Speak It**.

2. Follow the voice prompts to enter your destination address.

3. After a successful entry, hang up and you will be taken back to the screen you were viewing prior to making the call. The location you just entered will now be displayed at the top of your Recent Places list. You may need to tap **Refresh Recent Places** to make the address available.

You should now have a basic understanding of how to enter an address and get driving directions. For more information about using Sprint Navigation, visit the support page at <http://www.htc.com/us/default.aspx>.

Note *The Sprint Navigation software gets routing directions, maps, and its directory of businesses and points of interests from the Sprint Navigation servers. You need to subscribe to a data plan in order to access this information. If you do not have a data plan yet, check Sprint Navigation's Web site at <http://www.sprint.com/navigation> for subscription rates.*

Section 4

***Safety Information and
Other Notices***



Section 4A

Safety Information

- ◆ *Important Health Information and Safety Precautions (page 192)*
- ◆ *General Precautions (page 195)*
- ◆ *Additional Safety Information (page 196)*

This User Guide contains important operational and safety information that will help you safely use your device. Failure to read and follow the information provided in this guide may result in serious bodily injury, death, or property damage.

Important Health Information and Safety Precautions

When using this product, the safety precautions below must be taken to avoid possible legal liabilities and damages.

Retain and follow all product safety and operating instructions. Observe all warnings in the operating instructions on the product.

To reduce the risk of bodily injury, electric shock, fire, and damage to the equipment, observe the following precautions.

Electrical Safety

This product is intended for use when supplied with power from the designated battery or power supply unit. Other usage may be dangerous and will invalidate any approval given to this product.

Safety Precautions for Proper Grounding Installation

CAUTION: Connecting to an improperly grounded equipment can result in an electric shock to your device.

This product equipped with a USB Cable for connecting with desktop or notebook computer. Be sure your computer is properly grounded (earthed) before connecting this product to the computer. The power supply cord of a desktop or notebook computer has an equipment-grounding conductor and a grounding plug. The plug must be plugged into an appropriate outlet which is properly installed and grounded in accordance with all local codes and ordinances.

Safety Precautions for Power Supply Unit

- **Use the correct external power source.** A product should be operated only from the type of power source indicated on the electrical ratings label. If you are not sure of the type of power source required, consult your authorized service provider or local power company. For a product that operates from battery power or other sources, refer to the operating instructions that are included with the product.
- **Handle battery packs carefully.** This product contains a Li-ion battery. There is a risk of fire and burns if the battery pack is handled improperly. Do not attempt to open or service the battery pack. Do not disassemble, crush, puncture, short external contacts or circuits, dispose of in fire or water, or expose a battery pack to temperatures higher than 60° C (140° F).

WARNING

Danger of explosion if battery is incorrectly replaced. To reduce risk of fire or burns, do not disassemble, crush, puncture, short external contacts, expose to temperature above 60° C (140° F), or dispose of in fire or water. Replace only with specified batteries. Recycle or dispose of used batteries according to the local regulations or reference guide supplied with your product.

**● Take extra precautions:**

- Keep the battery or device dry and away from water or any liquid as it may cause a short circuit.
- Keep metal objects away so they don't come in contact with the battery or its connectors as it may lead to short circuit during operation.
- Do not use a battery that appears damaged, deformed, or discolored, or the one that has any rust on its casing, overheats, or emits a foul odor.
- Always keep the battery out of the reach of babies and small children, to avoid swallowing of the battery. Consult the doctor immediately if the battery is swallowed.
- If the battery leaks:
 - Do not allow the leaking fluid to come in contact with skin or clothing. If already in contact, flush the affected area immediately with clean water and seek medical advice.
 - Do not allow the leaking fluid to come in contact with eyes. If already in contact, DO NOT rub; rinse with clean water immediately and seek medical advice.
 - Take extra precautions to keep a leaking battery away from fire as there is a danger of ignition or explosion.

Safety Precautions for Direct Sunlight

Keep this product away from excessive moisture and extreme temperatures. Do not leave the product or its battery inside a vehicle or in places where the temperature may exceed 60°C (140°F), such as on a car dashboard, window sill, or behind a glass that is exposed to direct sunlight or strong ultraviolet light for extended periods of time. This may damage the product, overheat the battery, or pose a risk to the vehicle.

Prevention of Hearing Loss

CAUTION: Permanent hearing loss may occur if earphones or headphones are used at high volume for prolonged periods of time.

Road Safety

Vehicle drivers in motion are not permitted to use telephony services with handheld devices, except in the case of emergency. In some countries, using hands-free devices as an alternative is allowed.

Safety Precautions for RF Exposure

- Avoid using your phone near metal structures (for example, the steel frame of a building).
- Avoid using your phone near strong electromagnetic sources, such as microwave ovens, sound speakers, TV and radio.
- Use only original manufacturer-approved accessories, or accessories that do not contain any metal.
- Use of non-original manufacturer-approved accessories may violate your local RF exposure guidelines and should be avoided.

Interference with Medical Equipment Functions

This product may cause medical equipment to malfunction. The use of this device is forbidden in most hospitals and medical clinics.

If you use any other personal medical device, consult the manufacturer of your device to determine if they are adequately shielded from external RF energy. Your physician may be able to assist you in obtaining this information.

Turn your phone OFF in health care facilities when any regulations posted in these areas instruct you to do so. Hospitals or health care facilities may be using equipment that could be sensitive to external RF energy.

Nonionizing Radiation

Your device has an internal antenna. This product should be operated in its normal-use position to ensure the radiative performance and safety of the interference. As with other mobile radio transmitting equipment, users are advised that for satisfactory operation of the equipment and for the safety of personnel, it is recommended that no part of the human body be allowed to come too close to the antenna during operation of the equipment.

Use only the supplied integral antenna. Use of unauthorized or modified antennas may impair call quality and damage the phone, causing loss of performance and SAR levels exceeding the recommended limits as well as result in non-compliance with local regulatory requirements in your country.

To assure optimal phone performance and ensure human exposure to RF energy is within the guidelines set forth in the relevant standards, always use your device only in its normal-use position. Contact with the antenna area may impair call quality and cause your device to operate at a higher power level than needed. Avoiding contact with the antenna area when the phone is IN USE optimizes the antenna performance and the battery life.



General Precautions

- **Avoid applying excessive pressure to the device.** Do not apply excessive pressure on the screen and the device to prevent damaging them and remove the device from your pants' pocket before sitting down. It is also recommended that you store the device in a protective case and only use the device stylus or your finger when interacting with the touch screen. Cracked display screens due to improper handling are not covered by the warranty.
- **Heed service markings.** Except as explained elsewhere in the Operating or Service documentation, do not service any product yourself. Service needed on components inside the device should be done by an authorized service technician or provider.
- **Damage requiring service.** Unplug the product from the electrical outlet and refer servicing to an authorized service technician or provider under the following conditions:
 - Liquid has been spilled or an object has fallen into the product.
 - The product has been exposed to rain or water.
 - The product has been dropped or damaged.
 - There are noticeable signs of overheating.
 - The product does not operate normally when you follow the operating instructions.
- **Avoid hot areas.** The product should be placed away from heat sources such as radiators, heat registers, stoves, or other products (including amplifiers) that produce heat.
- **Avoid wet areas.** Never use the product in a wet location.
- **Avoid using your device after a dramatic change in temperature.** When you move your device between environments with very different temperature and/or humidity ranges, condensation may form on or within the device. To avoid damaging the device, allow sufficient time for the moisture to evaporate before using the device.

NOTICE: When taking the device from low-temperature conditions into a warmer environment or from high-temperature conditions into a cooler environment, allow the device to acclimate to room temperature before turning on power.
- **Avoid pushing objects into product.** Never push objects of any kind into cabinet slots or other openings in the product. Slots and openings are provided for ventilation. These openings must not be blocked or covered.
- **Mounting accessories.** Do not use the product on an unstable table, cart, stand, tripod, or bracket. Any mounting of the product should follow the manufacturer's instructions, and should use a mounting accessory recommended by the manufacturer.
- **Avoid unstable mounting.** Do not place the product with an unstable base.
- **Use product with approved equipment.** This product should be used only with personal computers and options identified as suitable for use with your equipment.
- **Adjust the volume.** Turn down the volume before using headphones or other audio devices.
- **Cleaning.** Unplug the product from the wall outlet before cleaning. Do not use liquid cleaners or aerosol cleaners. Use a damp cloth for cleaning, but NEVER use water to clean the LCD screen.

Additional Safety Information

When Driving

Do Not Use the PC Functions of Your Device While Driving or Walking

Never use the personal computer functions of your device while driving an automobile or any other moving vehicle. Always pull out of traffic and come to a stop in a legally permissible and safe location before using your device. Failure to do so could result in serious bodily injury in a traffic accident.

When driving:

- Always secure your device in its leather pouch.
- Never place your device on the passenger seat or anyplace else in the car where it can become a projectile during a collision or stop.
- An air bag inflates with great force. DO NOT place objects, including either installed or portable wireless equipment, in the area over the air bag or in the air bag deployment area. If in-vehicle wireless equipment is improperly installed and the air bag inflates, serious injury could result.

Never store or transport flammable liquids, gases or explosive materials in the same compartment of your automobile as the device or any of its accessories, as possible sparking in the device could cause ignition or explosion.

Never use your device while walking. Usage while walking could result in bodily injury caused by inattention to automobile traffic or other pedestrian hazards.

Using The Phone While Driving Is Extremely Dangerous

Talking on or using your device while driving is extremely dangerous and is illegal in some states. Remember, safety comes first. Check the laws and regulations on the use of phones in the areas where you drive. Always obey them.

If you must use the phone function while driving, please:

- Give full attention to driving. Driving safely is your first responsibility.
- Use hands-free operation and/or one-touch, speed dialing, and auto answer modes.
- Pull off the road and park before making or answering a call.

Warning

Failure to follow these instructions could lead to serious personal injury and possible property damage.

When Using Your Device Near Other Electronic Devices

Your wireless handheld portable device is a low power radio transmitter and receiver. When it is ON, it receives and also sends out radio frequency (RF) signals.

Most modern electronic equipment is shielded from RF energy. However, certain electronic equipment may not be shielded against the RF signals from your wireless device; therefore, use of your device must be restricted in certain situations.

In addition, the computer portion of your device produces low levels of RF energy due to the generation of digital timing pulses by its clock oscillator circuits. Your device has been equipped with internal shielding to minimize stray emissions of RF energy. However, use of the computer functions of your device must be restricted in certain situations.

Hearing Aids

Some digital wireless phones may interfere with some hearing aids. In the event of such interference, you may want to consult your service provider, or call the customer service line to discuss alternatives.

For more regulatory information about hearing devices, see “FCC Hearing-Aid Compatibility (HAC) Regulations for Wireless Devices”.

Electronic Devices in Vehicles

RF signals may affect improperly installed or inadequately shielded electronic systems in motor vehicles. Check with the manufacturer or its representative regarding your vehicle. You should also consult the manufacturer of any equipment that has been added to your vehicle.

Posted Facilities

Turn your device OFF where posted notices so require.

Turn Off Your Device Before Flying

Aircraft

FCC regulations prohibit using the transmitting and phone functions of your device while in the air. In addition, most airline regulations prohibit the on-board use of portable PCs (and all other portable electronic devices that could potentially emit stray RF energy), particularly during take-offs and landings, to prevent any possible interference with the reception of signals by airborne electronic navigational devices.

Turn your device OFF before boarding an aircraft. Always request and obtain prior consent and approval of an authorized airline representative before using your device aboard an aircraft. Always follow the instructions of the airline representative whenever using your device aboard an aircraft, to prevent any possible interference with airborne electronic equipment.

Turn Off Your Device in Dangerous Areas

Blasting Areas

To avoid interfering with blasting operations, turn your device OFF when in a “blasting area” or in areas posted “Turn off two-way radio”. Obey all signs and instructions.

Potentially Explosive Atmospheres

Turn your device OFF when in any area with a potentially explosive atmosphere and obey all signs and instructions. Sparks in such areas could cause an explosion or fire resulting in bodily injury or even death.

Areas with a potentially explosive atmosphere are often, but not always, clearly marked. They include fueling areas such as gas stations; below deck on boats; fuel or chemical transfer or storage facilities; vehicles using liquefied petroleum gas (such as propane or butane); areas where the air contains chemicals or articles, such as grain, dust, or metal powders; and any other area where you would normally be advised to turn off your vehicle’s engine.

General Safety and Other Precautions

Your device is a high quality piece of equipment. Before operating, read all instructions and cautionary markings on the product, battery and AC phone charger.

Failure to follow the directions below could result in serious bodily injury and/or property damage due to battery liquid leakage, fire or rupture.

DO NOT use or store this equipment in a place where it will be exposed to high temperatures, such as near an open flame or heat-emitting equipment.

DO NOT drop your device or subject it to severe shock. When not using, lay down the unit to avoid possible damage due to instability.

DO NOT expose this equipment to rain or spilled beverages.

DO NOT use unauthorized accessories.

DO NOT disassemble the device or its accessories. If service or repair is required, return unit to an authorized Sprint cellular service center. If the unit is disassembled, the risk of electric shock or fire may result.

Never allow metallic objects, such as staples and paper clips, to get into the inside of your device.

Never touch the liquid that might leak from a broken liquid crystal display. Contact with this liquid could cause a skin rash. If the crystal display liquid should come into contact with the skin or clothing, wash it immediately with clean water.

In the event that the device emits an unusual odor or sound or generates smoke, immediately disconnect the AC phone charger from the power outlet, then detach the battery.

Antenna Safety

Use only the supplied or an approved replacement antenna. Unauthorized antennas, modifications, or attachments could impair call quality, damage your device, or result in violation of FCC regulations. Please contact your local dealer for replacement antenna.

Do not use the device with a damaged antenna. If a damaged antenna comes into contact with the skin, a minor burn may result. Please contact your local dealer for replacement antenna.

Battery Safety

Your device uses a removable and rechargeable lithium ion battery. Please contact customer service for assistance should you need a replacement battery.

DOs

- Only use the battery and charger approved by the manufacturer.
- Only use the battery for its original purpose.
- Try to keep batteries in a temperature between 41°F (5°C) and 95°F (35°C).
- If the battery is stored in temperatures above or below the recommended range, give it time to warm up or cool down before using.
- Completely drain the battery before recharging. It may take one to four days to completely drain.
- Store the discharged battery in a cool, dark, and dry place.
- Purchase a new battery when its operating time gradually decreases after fully charging.
- Properly dispose of the battery according to local regulations.

DON'Ts

- Don't attempt to disassemble the battery – it is a sealed unit with no serviceable parts.
- Don't expose the battery terminals to any other metal object (e.g., by carrying it in your pocket or purse with other metallic objects such as coins, clips and pens). This can short circuit and critically damage the battery.

- Don't leave the battery in hot or cold temps. Otherwise, it could significantly reduce the capacity and lifetime of the battery.
- Don't dispose of the battery into a fire.

Lithium ion batteries are recyclable. When you replace the removable battery, please request the repair center to recycle the battery in accordance with RBRC standards. When disposing of the battery by yourself, please call RBRC at (800) 822-8837 for proper disposal tips.

Never touch any fluid that might leak from the built-in battery. Such liquid when in contact with the eyes or skin, could cause injury to the skin or eyes. Should the liquid come into contact with the eyes, irrigate the eyes thoroughly with clean water and immediately seek medical attention. In the event the liquid comes into contact with the skin or clothing, wash it away immediately with clean water.

AC Phone Charger

Use the Correct External Power Source

A product should be operated only from the type of power source indicated on the electrical ratings label. If you are not sure of the type of power source required, consult your authorized service provider or local power company. For a product that operates from battery power or other sources, refer to the operating instructions that are included with the product.

The AC phone charger designed by Sprint for this unit requires the use of a standard 120 V AC power source for device operation.

Never attempt to disassemble or repair an AC phone charger. Never use an AC phone charger if it has a damaged or worn power cord or plug. Always contact a Sprint authorized service center, if repair or replacement is required.

Never alter the AC cord or plug on an AC phone charger. If the plug will not fit into the available outlet, have a proper outlet installed by a qualified electrician.

Never allow any liquids or water to spill on an AC phone charger when it is connected to an AC power source.

Always use the authorized Sprint AC phone charger to avoid any risk of bodily injury or damage to your cellular phone or battery.

Never attempt to connect or disconnect the AC phone charger with wet hands. Always unplug the AC phone charger from the power source before attempting any cleaning. Always use a soft cloth dampened with water to clean the equipment, after it has been unplugged.

Handling the cord on this product or cords associated with accessories sold with this product, will expose you to lead, a chemical known to the State of California to cause birth defects or other reproductive harm. Wash hands after handling.

Always disconnect the travel charger or desktop charger from the power source when it is not in use.

Section 4B

Regulatory Notices

- ◆ *Regulatory Agency Identifications (page 200)*
- ◆ *Federal Communication Commission Interference Statement (page 200)*
- ◆ *Industry Canada Statement (page 201)*
- ◆ *FCC Hearing-Aid Compatibility (HAC) Regulations for Wireless Devices (page 201)*
- ◆ *SAR Information (page 202)*
- ◆ *IC Statement (page 203)*
- ◆ *Telecommunications & Internet Association (TIA) Safety Information (page 203)*
- ◆ *WEEE Notice (page 204)*
- ◆ *RoHS Compliance (page 204)*

This section provides more safety information and regulation statement for using your device.

Regulatory Agency Identifications

For regulatory identification purposes, your product is assigned a model number of *RAPH800*.

To ensure continued reliable and safe operation of your device, use only the accessories listed below with your *RAPH800*.

The Battery Pack has been assigned a model number of *DIAM171*.

Note	<i>This product is intended for use with a certified Class 2 Limited Power Source, rated 5 Volts DC, maximum 1 Amp power supply unit.</i>
-------------	---

Federal Communication Commission Interference Statement

This equipment has been tested and found to comply with the limits for a Class B digital device, pursuant to Part 15 of the FCC Rules. These limits are designed to provide reasonable protection against harmful interference in a residential installation. This equipment generates, uses and can radiate radio frequency energy and, if not installed and used in accordance with the instructions, may cause harmful interference to radio communications. However, there is no guarantee that interference will not occur in a particular installation. If this equipment does cause harmful interference to radio or television reception, which can be determined by turning the equipment off and on, the user is encouraged to try to correct the interference by one of the following measures:

- Reorient or relocate the receiving antenna.
- Increase the separation between the equipment and receiver.
- Connect the equipment into an outlet on a circuit different from that to which the receiver is connected.
- Consult the dealer or an experienced radio or television technician for help.

FCC Caution: Any changes or modifications not expressly approved by the party responsible for compliance could void the user's authority to operate this equipment.

This device complies with Part 15 of the FCC Rules. Operation is subject to the following two conditions: (1) This device may not cause harmful interference, and (2) this device must accept any interference received, including interference that may cause undesired operation.

Important Note

Radiation Exposure Statement:

This equipment complies with FCC radiation exposure limits set forth for an uncontrolled environment. End users must follow the specific operating instructions for satisfying RF exposure compliance. To maintain compliance with FCC RF exposure compliance requirements, please follow operation instruction as documented in this guide.

This transmitter must not be co-located or operating in conjunction with any other antenna or transmitter, except the transmitters built-in with this device.

Industry Canada Statement

This device complies with RSS-210 of the Industry Canada Rules. Operation is subject to the following two conditions: (1) This device may not cause harmful interference, and (2) this device must accept any interference received, including interference that may cause undesired operation.

Important Note

Radiation Exposure Statement:

This equipment complies with IC radiation exposure limits set forth for an uncontrolled environment. End users must follow the specific operating instructions for satisfying RF exposure compliance. To maintain compliance with IC RF exposure compliance requirements, please follow operation instruction as documented in this guide.

FCC Hearing-Aid Compatibility (HAC) Regulations for Wireless Devices

On July 10, 2003, the U.S. Federal Communications Commission (FCC) Report and Order in WT Docket 01-309 modified the exception of wireless phones under the Hearing Aid Compatibility Act of 1988 (HAC Act) to require digital wireless phones be compatible with hearing-aids. The intent of the HAC Act is to ensure reasonable access to telecommunications services for persons with hearing disabilities.

While some wireless phones are used near some hearing devices (hearing aids and cochlear implants), users may detect a buzzing, humming, or whining noise. Some hearing devices are more immune than others to this interference noise, and phones also vary in the amount of interference they generate.

The wireless telephone industry has developed a rating system for wireless phones, to assist hearing device users find phones that may be compatible with their hearing devices. Not all phones have been rated. Phones that are rated have the rating on their box or a label located on the box.

The ratings are not guarantees. Results will vary depending on the user's hearing device and hearing loss. If your hearing device happens to be vulnerable to interference, you may not be able to use a rated phone successfully. Trying out the phone with your hearing device is the best way to evaluate it for your personal needs.

M-Ratings: Phones rated M3 or M4 meet FCC requirements and are likely to generate less interference to hearing devices than phones that are not labeled. M4 is the better/higher of the two ratings. **RAPH800** is rated M4.

Please power off the Bluetooth function while using hearing aid devices with your **RAPH800**.

Hearing devices may also be rated. Your hearing device manufacturer or hearing health professional may help you find this rating. Higher ratings mean that the hearing device is relatively immune to interference noise. The hearing aid and wireless phone rating values are then added together. A sum of 5 is considered acceptable for normal use. A sum of 6 is considered for better use. A sum of 8 is considered for best use.

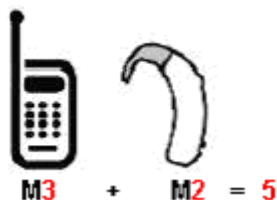

In the above example, if a hearing aid meets the M2 level rating and the wireless phone meets the M3 level rating, the sum of the two values equal M5. This should provide the hearing aid user with “normal usage” while using their hearing aid with the particular wireless phone. “Normal usage” in this context is defined as a signal quality that is acceptable for normal operation.

The M mark is intended to be synonymous with the U mark. The T mark is intended to be synonymous with the UT mark. The M and T marks are recommended by the Alliance for Telecommunications Industries Solutions (ATIS). The U and UT marks are referenced in Section 20.19 of the FCC Rules. The HAC rating and measurement procedure are described in the American National Standards Institute (ANSI) C63.19 standard.

For information about hearing aids and digital wireless phones

FCC Hearing Aid Compatibility and Volume Control:

<http://www.fcc.gov/cgb/dro/hearing.html>

Gallaudet University, RERC:

<http://tap.gallaudet.edu/DigWireless.KS/DigWireless.htm>

SAR Information

0.908 W/KG @ 1g (HEAD)

0.734 W/KG @ 1g (BODY)

THIS MODEL DEVICE MEETS THE GOVERNMENT’S REQUIREMENTS FOR EXPOSURE TO RADIO WAVES.

For body worn operation, this phone has been tested and meets the FCC RF exposure guidelines when used with the HTC Corporation accessories supplied or designated for this product. Use of other accessories may not ensure compliance with the FCC RF exposure guidelines.

Your wireless mobile CDMA phone is a radio transmitter and receiver. It is designed and manufactured not to exceed the emission limits for exposure to radio frequency (RF) energy set by the Federal Communications Commission of the U.S. Government. These limits are part of comprehensive guidelines and establish permitted levels of RF energy for the general population. The guidelines are based on the safety standards previously set by both U.S. and international standards bodies:

- American National Standards Institute (ANSI) IEEE. C95.1-1992.
- National Council on Radiation Protection and Measurement (NCRP). Report 86. 1986.
- International Commission on Non-Ionizing Radiation Protection (ICNIRP) 1996.
- Ministry of Health (Canada), Safety Code 6. The standards include a substantial safety margin designed to assure the safety of all persons, regardless of age and health.

The exposure standard for wireless mobile CDMA phone employs a unit of measurement known as the Specific Absorption Rate, or SAR. The SAR limit set by the FCC is 1.6 W/kg*.

The FCC has granted an Equipment Authorization for this model device with all reported SAR levels evaluated as in compliance with the FCC RF exposure guidelines. SAR information on this model device is on file with the FCC and can be found under the Display Grant section of <https://gulfoss2.fcc.gov/prod/oet/cf/eas/reports/GenericSearch.cfm> after searching on FCC ID: NM8RAPH800. Additional information on Specific Absorption Rates (SAR) can be found on the Cellular Telecommunications & Internet Association (CTIA) Web-site as <http://www.phonefacts.net>.

Additional information on Specific Absorption Rates (SAR) can be found on the Cellular Telecommunications & Internet Association (CTIA) Web-site as <http://www.phonefacts.net>.

* In the U.S. and Canada, the SAR limit for mobile CDMA phone used by the public is 1.6 Watts/kg (W/kg) averaged over one gram of tissue. The standard incorporates a substantial margin of safety to give additional protection for the public and to account for any variations in usage.

Normal condition only to ensure the radiative performance and safety of the interference. As with other mobile radio transmitting equipment, users are advised that for satisfactory operation of the equipment and for the safety of personnel, it is recommended that no part of the human body be allowed to come too close to the antenna during operation of the equipment.

IC Statement

Operation is subject to the following two conditions:

1. This device may not cause interference; and
2. This device must accept any interference, including interference that may cause undesired operation of the device.

Important Note IC Radiation Statement:

This equipment complies with IC radiation exposure limits set forth for an uncontrolled environment. End users must follow the specific operating instructions for satisfying RF exposure compliance.

This Class B digital apparatus complies with Canadian ICES-003.

Telecommunications & Internet Association (TIA) Safety Information

Pacemakers

The Health Industry Manufacturers Association recommends that a minimum separation of six inches be maintained between a handheld wireless phone and a pacemaker to avoid potential interference with the pacemaker. These recommendations are consistent with the independent research by and recommendations of Wireless Technology Research. Persons with pacemakers:

- Should ALWAYS keep the phone more than six inches from their pacemaker when the phone is turned ON.
- Should not carry the phone in a breast pocket.
- Should use the ear opposite the pacemaker to minimize the potential for interference. If you have any reason to suspect that interference is taking place, turn the phone OFF immediately.

Hearing Aids

Some digital wireless phones may interfere with some hearing aids. In the event of such interference, you may want to consult your service provider, or call the customer service line to discuss alternatives.

Other Medical Devices

If you use any other personal medical device, consult the manufacturer of your device to determine if they are adequately shielded from external RF energy. Your physician may be able to assist you in obtaining this information.

Turn the phone OFF in health care facilities when any regulations posted in these areas instruct you to do so. Hospitals or health care facilities may be using equipment that could be sensitive to external RF energy.

WEEE Notice

The Directive on Waste Electrical and Electronic Equipment (WEEE), which entered into force as European law on 13th February 2003, resulted in a major change in the treatment of electrical equipment at end-of-life.

The purpose of this Directive is, as a first priority, the prevention of WEEE, and in addition, to promote the reuse, recycling and other forms of recovery of such wastes so as to reduce disposal.



The WEEE logo (shown at the left) on the product or on its box indicates that this product must not be disposed of or dumped with your other household waste. You are liable to dispose of all your electronic or electrical waste equipment by relocating over to the specified collection point for recycling of such hazardous waste. Isolated collection and proper recovery of your electronic and electrical waste equipment at the time of disposal will allow us to help conserving natural resources. Moreover, proper recycling of the electronic and electrical waste equipment will ensure safety of human health and environment. For more information about electronic and electrical waste equipment disposal, recovery, and collection points, please contact your local city center, household waste disposal service, shop from where you purchased the equipment, or manufacturer of the equipment.

RoHS Compliance

This product is in compliance with Directive 2002/95/EC of the European Parliament and of the Council of 27 January 2003, on the restriction of the use of certain hazardous substances in electrical and electronic equipment (RoHS) and its amendments.

Warranty, Disclaimers and Other Notices

- ◆ *Manufacturer's Warranty (page 205)*
- ◆ *Privacy Restrictions (page 207)*
- ◆ *Weather Disclaimer (page 207)*
- ◆ *Warranty Disclaimer (page 207)*
- ◆ *Limitation of Damages (page 207)*

Your device has been designed to provide you with reliable, worry-free service. If for any reason you have a problem with your equipment, please refer to the manufacturer's warranty in this section. For information regarding the terms and conditions of service for your device, please visit www.sprint.com or call Sprint Customer Service at 1-888-211-4727.

Manufacturer's Warranty

12 Month Limited Warranty

Personal Communications Devices, LLC (the Company) warrants to the original retail purchaser of this PCD handheld portable cellular telephone, that should this product or any part thereof during normal consumer usage and conditions, be proven defective in material or workmanship that results in product failure within the first twelve (12) month period from the date of purchase, such defect(s) will be repaired or replaced (with new or rebuilt parts) at the Company's option, without charge for parts or labor directly related to the defect(s).

The antenna, keypad, display, rechargeable battery and battery charger, if included, are similarly warranted for twelve (12) months from date of purchase.

This Warranty extends only to consumers who purchase the product in the United States or Canada and it is not transferable or assignable.

This Warranty does not apply to:

- (a) Product subjected to abnormal use or conditions, accident, mishandling, neglect, unauthorized alteration, misuse, improper installation or repair or improper storage;
- (b) Product whose mechanical serial number or electronic serial number has been removed, altered or defaced;
- (c) Damage from exposure to moisture, humidity, excessive temperatures or extreme environmental conditions;
- (d) Damage resulting from connection to, or use of any accessory or other product not approved or authorized by the Company;
- (e) Defects in appearance, cosmetic, decorative or structural items such as framing and non-operative parts;
- (f) Product damaged from external causes such as fire, flooding, dirt, sand, weather conditions, battery leakage, blown fuse, theft or improper usage of any electrical source.

The Company disclaims liability for removal or reinstallation of the product, for geographic coverage, for inadequate signal reception by the antenna or for communications range or operation of the cellular system as a whole.

When sending your wireless device to Personal Communications Devices for repair or service, please note that any personal data or software stored on the device may be inadvertently erased or altered. Therefore, we strongly recommend you make a back up copy of all data and software contained on your device before submitting it for repair or service. This includes all contact lists, downloads (i.e. third-party software applications, ringtones, games and graphics) and any other data added to your device. In addition, if your wireless device utilizes a SIM or Multimedia card, please remove the card before submitting the device and store for later use when your device is returned, Personal Communications Devices is not responsible for and does not guarantee restoration of any third-party software, personal information or memory data contained in, stored on, or integrated with any wireless device, whether under warranty or not, returned to Personal Communications Devices for repair or service.

To obtain repairs or replacement within the terms of this Warranty, the product should be delivered with proof of Warranty coverage (e.g. dated bill of sale), the consumer's return address, daytime phone number and/or fax number and complete description of the problem, transportation prepaid, to the Company at the address shown below or to the place of purchase for repair or replacement processing. In addition, for reference to an authorized Warranty station in your area, you may telephone in the United States (800) 229-1235, and in Canada (800) 465-9672 (in Ontario call 416-695-3060).

THE EXTENT OF THE COMPANY'S LIABILITY UNDER THIS WARRANTY IS LIMITED TO THE REPAIR OR REPLACEMENT PROVIDED ABOVE AND, IN NO EVENT, SHALL THE COMPANY'S LIABILITY EXCEED THE PURCHASE PRICE PAID BY PURCHASER FOR THE PRODUCT.

ANY IMPLIED WARRANTIES, INCLUDING ANY IMPLIED WARRANTY OF MERCHANTABILITY OR FITNESS FOR A PARTICULAR PURPOSE, SHALL BE LIMITED TO THE DURATION OF THIS WRITTEN WARRANTY. ANY ACTION FOR BREACH OF ANY WARRANTY MUST BE BROUGHT WITHIN A PERIOD OF 18 MONTHS FROM DATE OF ORIGINAL PURCHASE. IN NO CASE SHALL THE COMPANY BE LIABLE FOR AN SPECIAL CONSEQUENTIAL OR INCIDENTAL DAMAGES FOR BREACH OF THIS OR ANY OTHER WARRANTY, EXPRESS OR IMPLIED, WHATSOEVER. THE COMPANY SHALL NOT BE LIABLE FOR THE DELAY IN RENDERING SERVICE UNDER THIS WARRANTY OR LOSS OF USE DURING THE TIME THE PRODUCT IS BEING REPAIRED OR REPLACED.

No person or representative is authorized to assume for the Company any liability other than expressed herein in connection with the sale of this product.

Some states or provinces do not allow limitations on how long an implied warranty lasts or the exclusion or limitation of incidental or consequential damage so the above limitation or exclusions may not apply to you. This Warranty gives you specific legal rights, and you may also have other rights, which vary from state to state or province to province.

IN USA: Personal Communications Devices, LLC
555 Wireless Blvd.
Hauppauge, NY 11788
(800) 229-1235

IN CANADA: Personal Communications Devices, LLC
5535 Eglinton Avenue West
Suite# 234
Toronto, ON M9C 5K5
(800) 465-9672

Privacy Restrictions

Some countries require full disclosure of recorded telephone conversations, and stipulate that you must inform the person with whom you are speaking that the conversation is being recorded. Always obey the relevant laws and regulations of your country when using the recording feature of your PDA Phone.

Weather Disclaimer

THE WEATHER INFORMATION, DATA AND DOCUMENTATION ARE PROVIDED “AS IS” AND WITHOUT WARRANTY OR TECHNICAL SUPPORT OF ANY KIND FROM HTC. TO THE MAXIMUM EXTENT PERMITTED BY APPLICABLE LAW, HTC AND ITS AFFILIATES expressly disclaim any and all representations and warranties, express or implied, arising by law or otherwise, regarding the Weather Information, Data, Documentation, or any other Products and services, including without limitation any express or implied warranty of merchantability, express or implied warranty of fitness for a particular purpose, non-infringement, quality, accuracy, completeness, effectiveness, reliability, usefulness, that the Weather Information, Data and/or Documentation will be error-free, or implied warranties arising from course of dealing or course of performance.

Without limiting the foregoing, it is further understood that HTC and its Providers are not responsible for Your use or misuse of the Weather Information, Data and/or Documentation or the results from such use. HTC and its Providers make no express or implied warranties, guarantees or affirmations that weather information will occur or has occurred as the reports, forecasts, data, or information state, represent or depict and it shall have no responsibility or liability whatsoever to any person or entity, parties and non-parties alike, for any inconsistency, inaccuracy, or omission for weather or events predicted or depicted, reported, occurring or occurred. WITHOUT LIMITING THE GENERALITY OF THE FOREGOING, YOU ACKNOWLEDGE THAT THE WEATHER INFORMATION, DATA AND/OR DOCUMENTATION MAY INCLUDE INACCURACIES AND YOU WILL USE COMMON SENSE AND FOLLOW STANDARD SAFETY PRECAUTIONS IN CONNECTION WITH THE USE OF THE WEATHER INFORMATION, DATA OR DOCUMENTATION.

Warranty Disclaimer

Your warranty is invalidated if you open or tamper with the device's outer casing.

For details about warranty coverage, see “Manufacturer’s Warranty” on page 205.

Limitation of Damages

TO THE MAXIMUM EXTENT PERMITTED BY APPLICABLE LAW, IN NO EVENT SHALL HTC OR ITS PROVIDERS BE LIABLE TO USER OR ANY THIRD PARTY FOR ANY INDIRECT, SPECIAL, CONSEQUENTIAL, INCIDENTAL OR PUNITIVE DAMAGES OF ANY KIND, IN CONTRACT OR TORT, INCLUDING, BUT NOT LIMITED TO, INJURY, LOSS OF REVENUE, LOSS OF GOODWILL, LOSS OF BUSINESS OPPORTUNITY, LOSS OF DATA, AND/OR LOSS OF PROFITS ARISING OUT OF, OR RELATED TO, IN ANY MANNER, OR THE DELIVERY, PERFORMANCE OR NONPERFORMANCE OF OBLIGATIONS, OR USE OF THE WEATHER INFORMATION, DATA OR DOCUMENTATION HEREUNDER REGARDLESS OF THE FORESEEABILITY THEREOF.

Section 4D

Copyright, Trademark, and Proprietary Notices

Copyright © 2008 HTC Corporation. All Rights Reserved.

HTC, the HTC logo, HTC Innovation, ExtUSB, TouchFLO, Touch Pro and HTC Care are trademarks and/or service marks of HTC Corporation.

Microsoft, MS-DOS, Windows, Windows NT, Windows Server, Windows Mobile, Windows XP, Windows Vista, ActiveSync, Windows Mobile Device Center, Internet Explorer, MSN, Hotmail, Windows Live, Outlook, Excel, PowerPoint, Word, OneNote and Windows Media are either registered trademarks or trademarks of Microsoft Corporation in the United States and/or other countries.

Bluetooth and the Bluetooth logo are trademarks owned by Bluetooth SIG, Inc.

Copyright © 2008, Adobe Systems Incorporated. All Rights Reserved.

microSD is a trademark of SD Card Association.

Opera® Mobile from Opera Software ASA. Copyright 1995-2008 Opera Software ASA. All Rights Reserved.

Google is a registered trademark of Google, Inc. in the United States and other countries.

YouTube is a trademark of Google, Inc.

Copyright © 2001-2008, Spb Software House. All Rights Reserved.

Copyright © 2008, Esmertec AG. All Rights Reserved.

Copyright © 2003-2008, ArcSoft, Inc. and its licensors. All Rights Reserved. ArcSoft and the ArcSoft logo are registered trademarks of ArcSoft, Inc. in the United States and/or other countries.

Copyright © 2004-2008, Ilium Software, Inc. All Rights Reserved.

All other company, product and service names mentioned herein are trademarks, registered trademarks or service marks of their respective owners.

HTC shall not be liable for technical or editorial errors or omissions contained herein, nor for incidental or consequential damages resulting from furnishing this material. The information is provided "as is" without warranty of any kind and is subject to change without notice. HTC also reserves the right to revise the content of this document at any time without prior notice.

No part of this document may be reproduced or transmitted in any form or by any means, electronic or mechanical, including photocopying, recording or storing in a retrieval system, or translated into any language in any form without prior written permission of HTC.

Index

A

- A2DP 90
- About 117, 120
- ActiveSync 65, 66, 67
- Adding and Removing Programs 125
- Adobe Reader LE 76
- Airplane Mode 36, 75
- Alarm 120
- Album
 - About 103
 - Closing Album 108
 - Playing Back Video 108
 - Selecting a Photo or Video to View 104
 - Viewing an Image 105
- Attachment
 - Adding an Attachment to a Message 165
 - Downloading 167
- Audio Booster 113
- Automatic Speech Recognition (ASR) 116

B

- Backlight
 - Adjusting Brightness 119
 - Setting Backlight Timeout 119
- Basic Settings 119
- Battery
 - Battery Saving Tips 16
 - Charging the Battery 16
 - Installing the Battery 2
 - Removing the Battery 15
 - Using Your Device's Battery and Charger 15
- Beaming Information Using Bluetooth 91, 118
- Block Recognizer 61
- Bluetooth
 - About 89, 118
 - Bluetooth Explorer 92
 - Bluetooth file sharing 92
 - Bluetooth shared folder 92
 - Connecting a Bluetooth Hands-free or Stereo Headset 90
 - Modes 89
 - Partnerships (Pairing) 90
 - Turning Bluetooth On and Off 75
- Business card scanner (see "WorldCard Mobile") 82
- Buttons 116

C

- Calendar
 - Creating Appointments 71
 - Sending Appointments 72
 - Viewing Appointments 72
- Call Forwarding 136
- Call Waiting 136
- Caller ID 135
- Camera
 - Advanced Options 101
 - Capture Modes 94
 - Menu Panel 97
 - Onscreen Controls and Indicators 96
 - Using Auto-focus 95
 - Zooming 98
- Certificates 117
- Checking Missed Calls 31
- Clear Storage 117, 127
- ClearVue Presentation 78
- ClearVue Presentation 5 Pro 78
- Clock & Alarms 117, 119, 120
- Comm Manager 75, 118
- Compact QWERTY 58
- Company Directory 174
- Connecting to an External Display 123
- Connecting to Data Services 141
- Connections Settings 118
- Contacts 69
- Contacts Picture capture mode 95
- Copying and Managing Files 115
- Customer Feedback 117

D

- Data Connection 21, 75, 141, 142
- Device Information 117
- Device Name 120
- Direct Push 75, 170
- Domain Enroll 118
- Downloading
 - Downloading a Complete Email Message 166
 - Email Settings 164, 167
 - File Attachments 167
 - Satellite Data 186
 - Web Feeds 152

E

- Email
 - Custom Domain Email 164

- Email Setup Wizard* 162
- Internet Email* 163
- Mail Tab (TouchFLO 3D)* 43
- Outlook Email* 162
- Replying To or Forwarding a Message* 167
- Sending* 165
- Types of Email Accounts* 162

E

- Windows Live Messenger* 149
- Encrypt files on your microSD* 87
- Encryption* 117
- Error Reporting* 117
- Exchange Server* 168, 170
- External GPS* 117

F

- Favorite Contacts* 40
- File Explorer* 115
- Finding Contacts*
 - Company Directory* 174
- Finger Gestures* 52
- Finger Panning* 53
- Finger Scrolling* 52
- Full QWERTY* 57

G

- GPS* 117, 185
- G-Sensor* 117

H

- Hard Reset* 126
- Home Screen* 19, 37
- Home Tab (TouchFLO 3D)* 39

I

- IMAP4* 163
- Input* 116
- Input Methods*
 - Block Recognizer* 61
 - Compact QWERTY* 58
 - Full QWERTY* 57
 - Letter Recognizer* 62
 - Phone Keypad* 59
 - Transcriber* 62
- Inserting the microSD card* 86
- Instant Messaging* 158
- International Call* 28
- Internet* 137

- Internet Email* 163
- Internet Explorer Mobile* 145
- Internet Sharing* 156
- Internet Tab (TouchFLO 3D)* 48

J

- JETCET PRINT 5* 84

K

- Key Lock* 117

L

- Letter Recognizer* 62
- Library*
 - Music Tab (TouchFLO 3D)* 45
 - Windows Media Player Mobile* 110
- Live Messenger* 148
- Lock* 116
- Long Press End Key* 117

M

- Mail Tab (TouchFLO 3D)* 43
- Making a Call*
 - Calling From Contacts* 28
 - Favorite Contacts* 40
 - International Call* 28
 - Phone Screen* 27
 - Three-Way Call* 136
- Managed Programs* 117
- Meeting Requests* 173
- Memory* 117, 125
- Menus* 116
- Messages Tab (TouchFLO 3D)* 41
- Messaging*
 - Email* 162
 - Instant Messaging* 158
 - Sprint Picture Mail* 160
 - Text Messaging* 133
 - Windows Live Messenger* 148
- Messenger* 148
- Microphone AGC* 117
- Microsoft Office Mobile* 77
- Missed Call Notification* 31
- Modem* 156
- MP3 Trimmer* 114
- Multitap* 60

N

News Channels (Web Feeds) 152
 Notes 73
 Now Playing
 Music Tab (TouchFLO 3D) 45
 Numeric and Symbol Mode 61

O

Office Mobile 77
 Opera Mobile 143
 Owner Information 116

P

Panorama Capture Mode 95
 People Tab (TouchFLO 3D) 40
 Phone 26, 116
 Phone Keypad 59
 Phone Services 121
 Photo Capture Mode 95
 Photos and Videos Tab (TouchFLO 3D) 46
 Picture Mail 160
 Picture Theme Capture Mode 95
 Playing Media 112
 Playing Music
 Music Tab (TouchFLO 3D) 44
 Windows Media Player Mobile 112
 Playlists
 Music Tab (TouchFLO 3D) 45
 Windows Media Player Mobile 112
 Pocket Express 150
 POP3 163
 Power 117
 PowerPoint 78
 Programs Tab (TouchFLO 3D) 51
 Putting a Call On Hold 30

Q

Quick Menu 23, 122
 QuickGPS 186

R

Recording
 Voice Recorder 79
 Regional Settings 117, 119
 Remote Desktop Mobile 157
 Remove Programs 117
 Removing the microSD card 86

Replying
 Email 167
 Text (SMS) 135

Resetting
 Clear Storage 127
 Hard Reset 126
 Soft Reset 126

Ring Tone 50, 120
 Ring Type 120

S

Screen 118, 119
 Screen Text Size 119
 Sending
 Email 165
 Meeting Request 72
 Text Message 134
 Settings Tab (TouchFLO 3D) 50
 Sleep Mode 14
 SMS 42, 133
 Soft Reset 126
 Sounds & Notifications 116, 121
 Speakerphone 30
 Speed Dial 33
 Sprint Instant Messaging 158
 Sprint Music Store 177
 Sprint Picture Mail 160
 Sprint TV 176
 Sprint TV Tab (TouchFLO 3D) 47
 Start Menu 22
 Status Icons 20
 Streaming Media 183
 Switching Between Two Calls 30
 Synchronizing
 ActiveSync 66
 Choosing What Information Is Synchronized 67
 Exchange Server 168
 Music and Videos 68
 Settings Tab (TouchFLO 3D) 50
 Using Bluetooth 67
 Video and Audio Files 111
 Windows Mobile Device Center 64
 Your Device With Your Computer 66

T

T9 60
 Task Manager 118, 122
 Tasks 74

- Text Messages
 - Creating a New Text Message 133
 - Messages Tab (TouchFLO 3D) 42
 - Sending 134
- Text Messaging
 - Threaded and Classic Modes 118, 135
- Text Size (Screen) 119
- Three-Way Call 136
- Today 116
- TouchFLO 3D 37
- TouchFLO Settings 118
- Transcriber 62
- Troubleshooting
 - Sync Connection 67
 - Windows Media Player Mobile 112
- Turning the Phone On and Off 36, 75
- Turning Your Device On and Off 14

U

- Update PRL 118
- Update Profile 118
- USB to PC 67, 118
- Using Your Device As a Modem 156
- Using Your Device as a USB Drive 87

V

- Vibrate 21, 28, 120
- Video Capture Mode 95
- Video Out 118
- Voice Command 116
- Voice Recorder 79
- Voicemail 5, 29, 130

W

- Weather Tab (TouchFLO 3D) 48
- Wi-Fi 75, 118, 137
- Windows Live 147
- Windows Live Messenger 148
- Windows Media Player Mobile 109
- Windows Mobile Device Center 64
- Windows Update 118, 127
- Wireless LAN 118
- Wireless printing (see "JETCET Print 5") 84
- WorldCard Mobile 82

Y

- YouTube 179

Z

- Zooming
 - Camera 98
 - Finger-zooming 52