

CHC[®] i70 GNSS Receiver

Revision 1.0
May 2017



Copyright

Copyright 2016-2017 CHC | Shanghai Huace Navigation Technology Ltd. All rights reserved. The CHC are trademark of Shanghai Huace Navigation Technology Limited. All other trademarks are the property of their respective owners.

Trademarks

All product and brand names mentioned in this publication are trademarks of their respective holders.

Safety Warnings

The Global Positioning System (GPS) is operated by the U.S. Government, which is solely responsible for the accuracy and maintenance of the GPS network. Accuracy can also be affected by poor satellite geometry and obstructions, like buildings and heavy canopy.

The i70, iG8 model's the function, software and electric circuit are the same , only to different guest with product model numbers different.

*i70 GNSS Receiver User Guide
Revision 1.0 May 2017*

CONTENTS

1. Introduction.....	4
1.1. Safety information.....	4
1.1.1. Warnings and cautions.....	4
1.1.2. Regulations and safety.....	4
1.1.3. Use and Care.....	5
1.2. Technical support.....	5
1.3. Disclaimer.....	5
1.4. Your comments.....	5
2. Getting started with i70.....	6
2.1. About the receiver.....	6
2.2. Parts of the receiver.....	6
2.2.1. Front panel.....	6
2.2.2. Lower housing.....	8
2.2.3. Receiver ports.....	8
2.3. Batteries and power.....	9
2.3.1. Internal batteries.....	9
2.3.1.1. Charging the battery.....	9
2.3.1.2. Battery safe.....	10
2.3.2. External power supply.....	10
2.4. Inserting battery and SIM card.....	11
2.5. Product basic supply accessories.....	12
2.5.1. Base kit basic supply.....	12
2.5.2. Rover kit basic supply.....	13
2.6. Connecting to an office computer.....	14
2.7. Connecting to a controller.....	15
2.7.1. Connecting via Wi-Fi with LandStar 7 software.....	15
2.7.2. Connecting via Bluetooth with LandStar 7 software.....	17
2.8. Downloading logged data.....	19
3. Front panel operation.....	21
3.1. Main operation menus.....	21
3.2. Configure the working mode.....	23
4. Base station setup and operation.....	28
4.1. Base station setup guidelines.....	28
4.2. Outputting corrections using internal radio modem.....	29
4.2.1. Base station setup.....	29
4.3. Outputting corrections using external radio.....	30
5. Rover station setup and operation.....	32
5.1. Rover station setup guidelines.....	32
5.2. Rover station setup.....	33
6. Configuring through a web browser.....	34
6.1. Status menu.....	35
6.1.1. Position submenu.....	35

6.1.2. Activity submenu.....	36
6.1.3. Google Map submenu.....	37
6.2. Satellites menu.....	37
6.2.1. Tracking Table submenu.....	37
6.2.2. Tracking Info. Table submenu.....	38
6.2.3. Tracking SkyPlot submenu.....	38
6.2.4. Satellite Activation submenu.....	38
6.3. Receiver Configuration menu.....	39
6.3.1. Description.....	39
6.3.2. Antenna Configuration submenu.....	39
6.3.3. Reference Station Settings submenu.....	40
6.3.4. Receiver Reset submenu.....	42
6.3.5. Languages submenu.....	42
6.3.6. User Management submenu.....	42
6.3.7. USB Function Switch submenu.....	42
6.3.8. HCPPP Settings submenu.....	42
6.3.9. 1PPS submenu.....	43
6.4. Data Recording menu.....	43
6.4.1. Log Settings submenu.....	43
6.4.2. FTP Push Settings submenu.....	45
6.4.3. FTP Push log submenu.....	46
6.4.4. Data Download submenu.....	46
6.5. IO Settings menu.....	47
6.5.1. IO Settings submenu.....	47
6.6. Network Setting menu.....	51
6.6.1. Discription submenu.....	51
6.6.2. Mobile network setting submenu.....	52
6.6.3. Email alarm submenu.....	52
6.6.4. HTTP submenu.....	52
6.6.5. HTTPS submenu.....	53
6.6.6. FTP service submenu.....	53
6.7. Module setting menu.....	53
6.7.1. Description submenu.....	53
6.7.2. WiFi submenu.....	54
6.7.3. Bluetooth settings submenu.....	54
6.7.4. Radio settings submenu.....	54
6.7.5. Buzzer setting submenu.....	55
6.8. Firmware menu.....	55
6.8.1. Firmware Info submenu.....	55
6.8.2. Hardware Version.....	56
6.8.3. Config File.....	56
6.8.4. System Log Download submenu.....	56
6.8.5. User Log.....	56
6.8.6. Firmware Update submenu.....	57

6.8.7. GNSS Board Upgrade.....	57
6.8.8. Radio Upgrade.....	57
6.8.9. Upgrade Online.....	57
6.8.10. GNSS Registration submenu.....	58
6.9. Cloud Service Setting menu.....	58
6.9.1. Cloud Service Setting submenu.....	58
A. Communication ports definition.....	59
A.1. CHC i70 receiver IO port (7-pin Lemo port) definition.....	59

1. INTRODUCTION

The i70 GNSS Receiver User Guide describes how to set up and use the CHC® i70 GNSS receiver.

In this manual, “the receiver” refers to the i70 GNSS receiver unless otherwise stated.

Even if you have used other Global Navigation Satellite Systems (GNSS) products before, CHC recommends that you spend some time reading this manual to learn about the special features of this product. If you are not familiar with GNSS, go to www.chcnv.com for an interactive look at CHC and GNSS.

1.1. SAFETY INFORMATION

1.1.1. WARNINGS AND CAUTIONS

An absence of specific alerts does not mean that there are no safety risks involved.

A Warning or Caution information is intended to minimize the risk of personal injury and/or damage to the equipment.



WARNING - A Warning alerts you to a potential misused or wrong setting of the equipment.



CAUTION - A Caution alerts you to a possible risk of serious injury to your person and/or damage to the equipment.

1.1.2. REGULATIONS AND SAFETY

The receivers contain a built-in wireless modem for signal communication through Bluetooth® wireless technology or through external communication datalink. Regulations regarding the use of the wireless modem vary greatly from country to country. In some countries, the unit can be used without obtaining an end-user license. However, in some countries, the administrative permissions are required. For license information, consult your local dealer. Bluetooth® operates in license-free bands.

Before operating a i70 GNSS receiver, determine if authorization or a license to operate the unit is required in your country. It is the responsibility of the end-user to obtain an operator's permit or license for the receiver for the location or country of use.

1.1.3. USE AND CARE

This receiver is designed to withstand the rough environment that typically occurs in the field. However, the receiver is high-precision electronic equipment and should be treated with reasonable care.



CAUTION - Operating or storing the receiver outside the specified temperature range will cause irreversible damage.

1.2. TECHNICAL SUPPORT

If you have a problem and cannot find the information you need in this manual or CHC website (www.chcnv.com), contact your local CHC dealer from which you purchased the receiver(s).

If you need to contact CHC technical support, please contact us by email (support@chcnv.com) or Skype (chc_support).

1.3. DISCLAIMER

Before using the receiver, please make sure that you have read and understood this User Guide, as well as the safety information. CHC holds no responsibility for the wrong operation by users and for the losses incurred by the wrong understanding about this User Guide. However, CHC reserves the rights to update and optimize the contents in this guide regularly. Please contact your local CHC dealer for new information.

1.4. YOUR COMMENTS

Your feedback about this user guide will help us to improve it in future revision. Please email your comments to support@chcnv.com.

2. GETTING STARTED WITH I70

2.1. ABOUT THE RECEIVER

The i70 GNSS receiver incorporates a GNSS engine, GNSS antenna, internal radio, optional 4G cellular modem, Bluetooth, Wi-Fi, and dual-battery in a ruggedized and miniature unit that is easy for you to set up an all-in-one RTK rover or mobile base station.

The LCD panel enables you to check satellite-tracking status, internal battery status, Wi-Fi status, working mode, data logging status and basic receiver information. Bluetooth and Wi-Fi technology provide cable-free communication between the receiver and controller.

The receiver can be used as the part of a RTK GNSS system with CHC LansStar 7 software. And you can download the GNSS data that recorded in the internal memory of receiver to a computer.

You can change basic settings of the receiver with its LCD panel. To configure the receiver for performing a wide variety of functions, you can use the web interface by connecting the receiver with PC or smartphone through Wi-Fi.

2.2. PARTS OF THE RECEIVER

The operating controls are all located on the front panel. Battery compartment and SIM card slot are on the backside. Serial ports and connectors are located on the bottom of the unit.

2.2.1. FRONT PANEL

The following figure shows a front view of the receiver.



The front panel contains one LCD screen, two indicator LEDs, and two buttons.

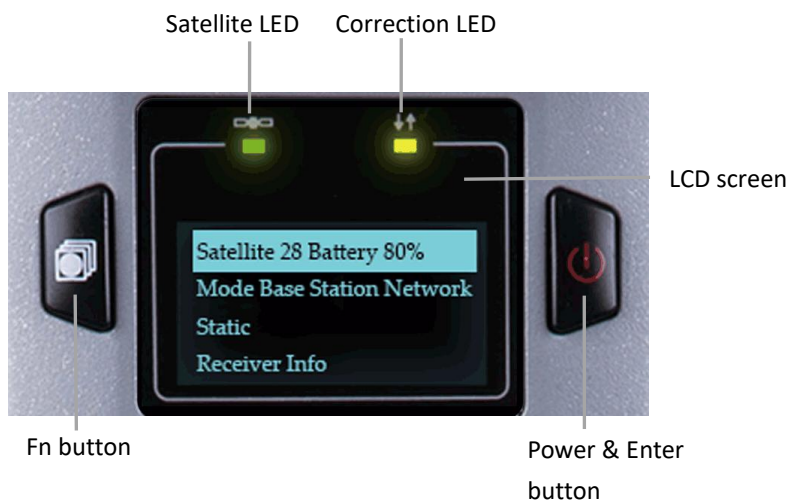

Name	Description
Satellite LED (Green)	Shows the number of satellites that the receiver has tracked. <ul style="list-style-type: none"> When the receiver is searching satellites, the green LED flashes once every 5 seconds. When the receiver has tracked N satellites, the green LED will flash N times every 5 seconds.
Correction LED (Yellow)	Indicates whether the receiver is transmitting/receiving differential data. <p>The yellow LED flashes once per second when</p> <ul style="list-style-type: none"> As a Base station: successfully transmitting differential data. As a Rover station: successfully receiving differential data from Base station.
LCD screen	This liquid crystal display enables you view the basic information and current configuration settings of receiver.
Fn button	<ul style="list-style-type: none"> Move to next line of the menus or options. Move to next character of the value that you want to make change. Cancel the change you make on a function.
Power & Enter button	<p>Works as a Power button:</p> <ul style="list-style-type: none"> Press and hold this button for 3 seconds to turn on or turn off the receiver. <p>Works as a Enter button:</p> <ul style="list-style-type: none"> Advance to next screen. Make change to the selected character or field. Confirm the change you make on a function. Confirm the changes you make on a screen.

Works as a Reset button:

- Hold Fn button, and press this button for 5 times continuously to reset the mainboard.
-

For more information about the front panel and relevant operations, see [3. Front panel operation](#).



2.2.2. LOWER HOUSING

The lower housing contains one SIM card slot, two battery compartments, one TNC radio antenna connector, two communication and power ports, one 5/8-11 threaded insert, and two nameplates.



2.2.3. RECEIVER PORTS



Port	Name	Description
	IO port	<ul style="list-style-type: none"> This port is a 7-pin Lemo connector that supports RS-232 communications and external power input. Users can use GPS to PC Data Cable supplied with the system to realize RS-232 communications between the receiver and computer or controller. Also, users can use a 7-pin cable to transmit differential data to an external radio.
	USB port	<ul style="list-style-type: none"> This port is a mini-USB connector that supports USB communications. Users can use USB Cable supplied with the system to download the logged data to a computer.
	Radio antenna connector	Connect a radio antenna to internal radio of the receiver. And this connector is not used if you are using an external radio.

2.3. BATTERIES AND POWER

2.3.1. INTERNAL BATTERIES

The receiver has two rechargeable Lithium-ion batteries, which can be removed for charging.

2.3.1.1. Charging the battery

The rechargeable Lithium-ion battery is supplied partially charged. Charge the battery completely before using it for the first time. To charge the battery, first remove the battery from the receiver, and then place it in the battery charger, which is connected to AC power.



WARNING - Charge and use the rechargeable Lithium-ion battery only in strict accordance with the instructions. Charging or using the battery in unauthorized equipment can cause an explosion or fire, and can result in personal injury and/or equipment damage.

To prevent injury or damage:

- Do not charge or use the battery if it appears to be damaged or leaking.
- Charge the Lithium-ion battery only in a CHC product that is specified to charge it. Be sure to follow all instructions that are provided with the battery charger.
- Discontinue charging a battery that gives off extreme heat or a burning odor.
- Use the battery only in CHC equipment that is specified to use it.
- Use the battery only for its intended use and according to the instructions in the product documentation.

2.3.1.2. Battery safe



WARNING - Do not damage the rechargeable Lithium-ion battery. A damaged battery can cause an explosion or fire, and can result in personal injury and/or property damage.

To prevent injury or damage:

- Do not use or charge the battery if it appears to be damaged. Signs of damage include, but are not limited to, discoloration, warping, and leaking battery fluid.
- Do not expose the battery to fire, high temperature, or direct sunlight.
- Do not immerse the battery in water.
- Do not use or store the battery inside a vehicle under hot weather condition.
- Do not drop or puncture the battery.
- Do not open the battery or short-circuit its contacts.



WARNING - Avoid contact with the rechargeable Lithium-ion battery if it appears to be leaking. Battery fluid is corrosive, and contact with it can result in personal injury and/or property damage.

To prevent injury or damage:

- If the battery leaks, avoid with the battery fluid.
- If battery fluid gets into your eyes, immediately rinses your eyes with clean water and seek medical attention. Please do not rub your eyes!
- If battery fluid gets onto your skin or clothing, immediately use clean water to wash off the battery fluid.

2.3.2. EXTERNAL POWER SUPPLY

Two methods are available for providing the external power to the receiver by the GPS to PC Data Cable+ Power Adapter, or GPS to PC Data Cable + external power cable (option purchase)+ vehicle battery.

In the office:

The Power Adapter is connecting with AC power of 100-240V, the output port of the Power Adapter connects with the Power Port of the GPS to PC Data Cable.

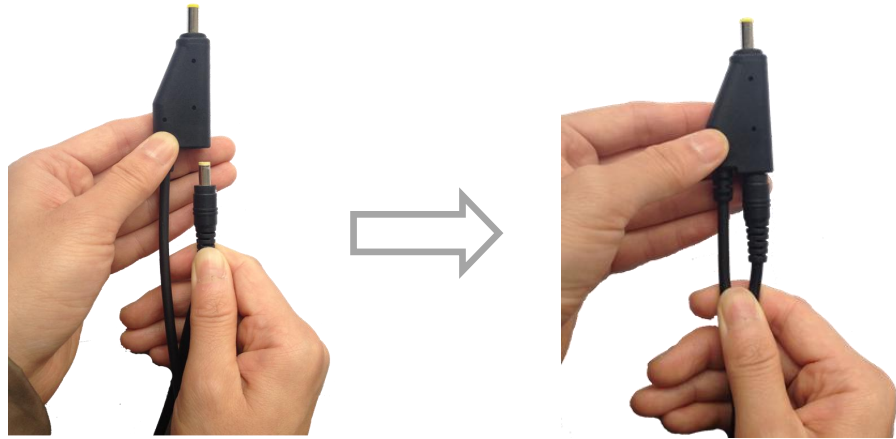

In the field:

The external power cable is connecting with a vehicle battery, the output port of the external power cable connects with the Power Port of the GPS to PC Data Cable.



WARNING - Use caution when connecting external power cable's clip leads to a vehicle battery. Do not allow any metal object to connect (short) the battery's positive (+) terminal to either the negative (-) terminal or the metal part of the vehicle battery. This could result in high current, arcing, and high temperatures, exposing the user to possible injury.

2.4. INSERTING BATTERY AND SIM CARD

Push down the spring-loaded button on the battery cover to open the cover.

Make electrode sheets of battery turn toward the receiver, align the socket of the battery and the lug of the battery compartment, and then insert the battery into the battery compartment until it is locked by the battery bail.

To remove the battery, slide the battery bail to the left or right.

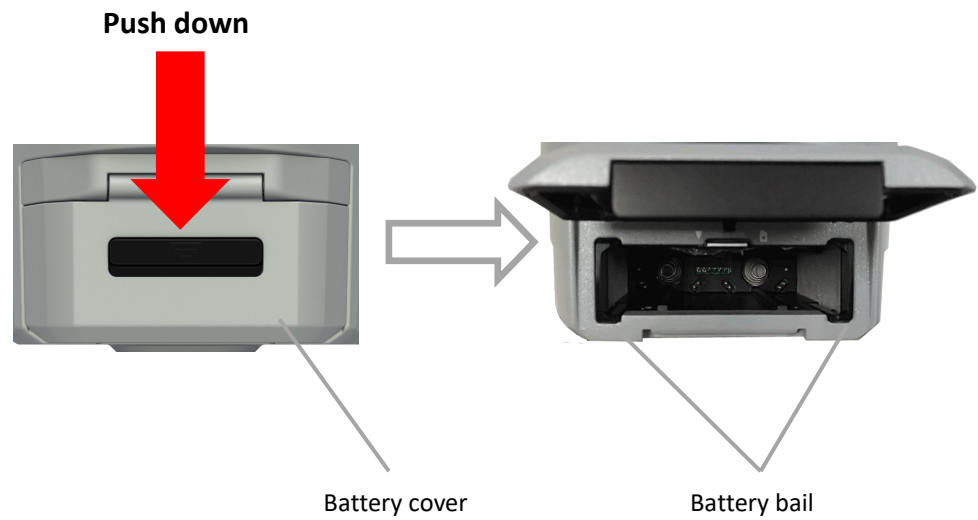



Insert the SIM card with the contacts facing upward, as indicated by the SIM card icon next to the SIM card slot.

To eject the SIM card, slightly push it in to trigger the spring-loaded release mechanism.

Tip – The SIM card is provided by your cellular network service provider.

2.5. PRODUCT BASIC SUPPLY ACCESSORIES

2.5.1. BASE KIT BASIC SUPPLY

Item	Picture
i70 GNSS Receiver	
UHF Bar Antenna (450-470 MHz)	
USB Cable	

GPS to PC Data Cable



Lithium Battery



H.I. Tape



Extension pole



Tribrach with optical plummet



Auxiliary H.I. Tool





Tribrach adaptor



Transport Hard Case



2.5.2. ROVER KIT BASIC SUPPLY

Item	Picture
i70 GNSS Receiver	
UHF Bar Antenna (450-470 MHz)	

USB Cable



GPS to PC Data Cable



Battery Charger



Power Adapter with Cord



Lithium Battery



2M Range Pole w/bag



Auxiliary H.I. Tool



Transport Hard Case



2.6. CONNECTING TO AN OFFICE COMPUTER

The receiver can be connected to an office computer for serial data transfer or settings via a GPS to PC Data Cable. Before you connect to the office computer, ensure that the receiver is powered on by internal battery or external power.

The following figure shows how to connect to the computer for serial data transfer or settings:

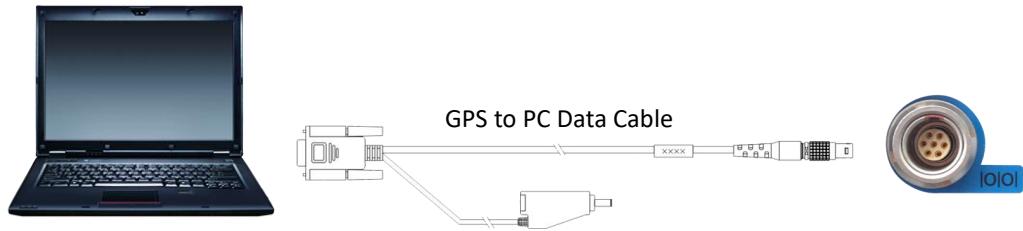

2.7. CONNECTING TO A CONTROLLER

2.7.1. CONNECTING VIA WI-FI WITH LANDSTAR 7 SOFTWARE

1. Turn on the controller → run LandStar 7 → go to **Config** main menu → tap **Connect**.
2. In the *Connect* screen, select **CHC** for the *Manufacturer* field, **i70** for *Device Type* field, **WiFi** for *Connection Type* field,

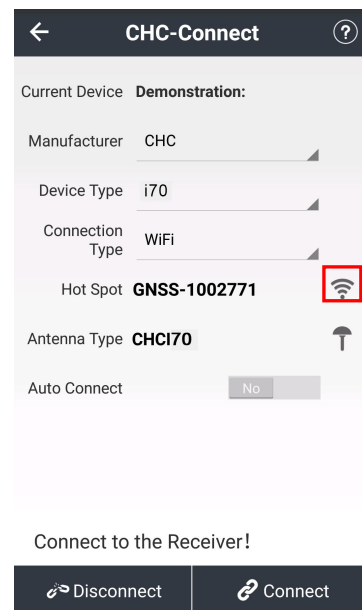

3. Tap the Wireless Lan icon on the right side to select the hot-spot → Switch on the WiFi module by the top switch → tap refresh button to search the hot spot around → select the target device in the list.

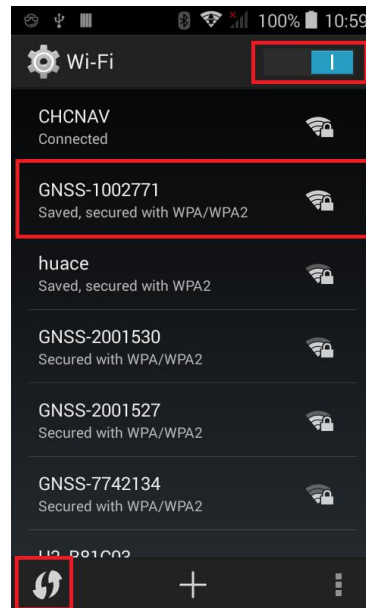

4. Tap **Connect** to link to the hot spot. If the first time connection to this hot spot, user may type in the password.

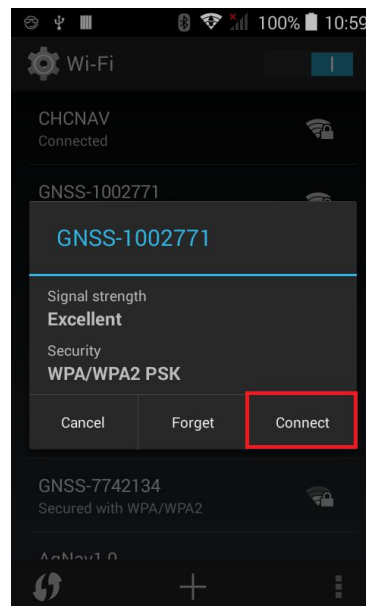

Tip – The Wi-Fi key of the receiver is 12345678 by default.

5. Tap the **Connect** button to build the connection.

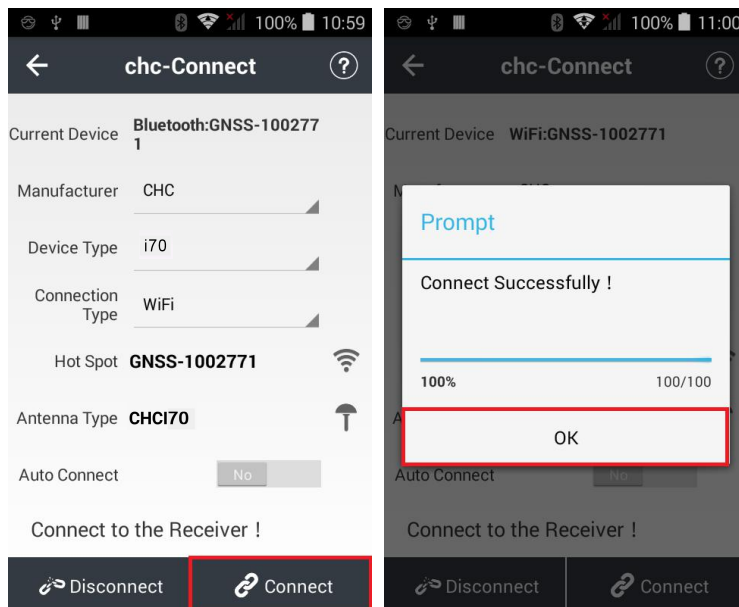

2.7.2. CONNECTING VIA BLUETOOTH WITH LANDSTAR 7 SOFTWARE

1. Turn on the controller → run LandStar 7 → go to **Config** main menu → tap **Connect**.
2. In the *Connect* screen, select **CHC** for the *Manufacture* field, **i70** for *Device Type* field, **Bluetooth** for *Connection Type* field.

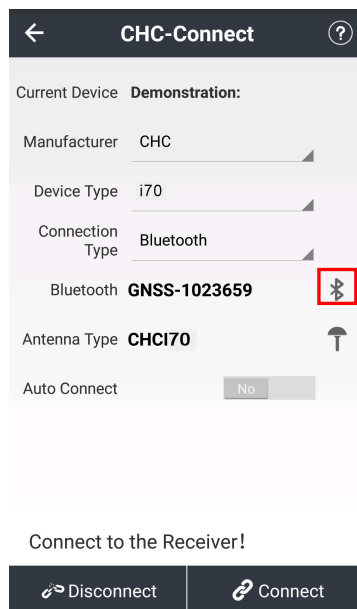

3. Tap the **Bluetooth Manager** and turn on the **Bluetooth** function to search bluetooth device around → select the target device in the list.

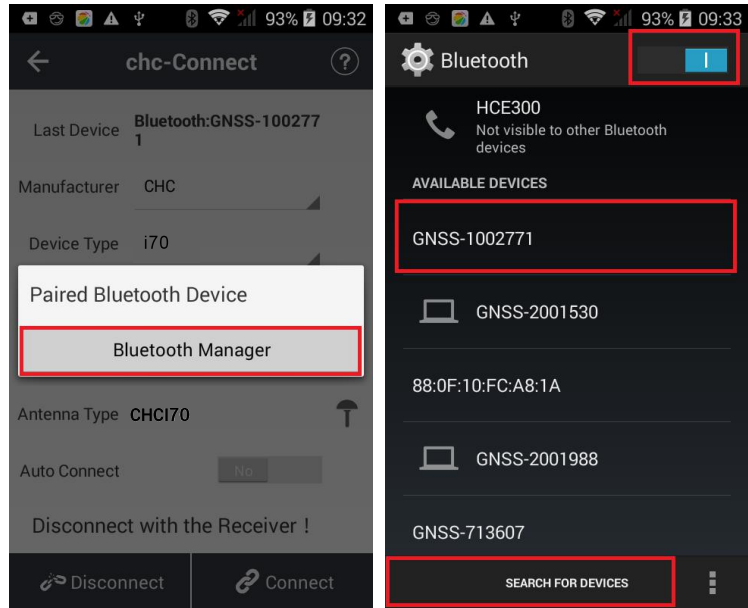

- 4. Tap **Pair** to connect the bluetooth device → selected the target device in the bluetooth manager list

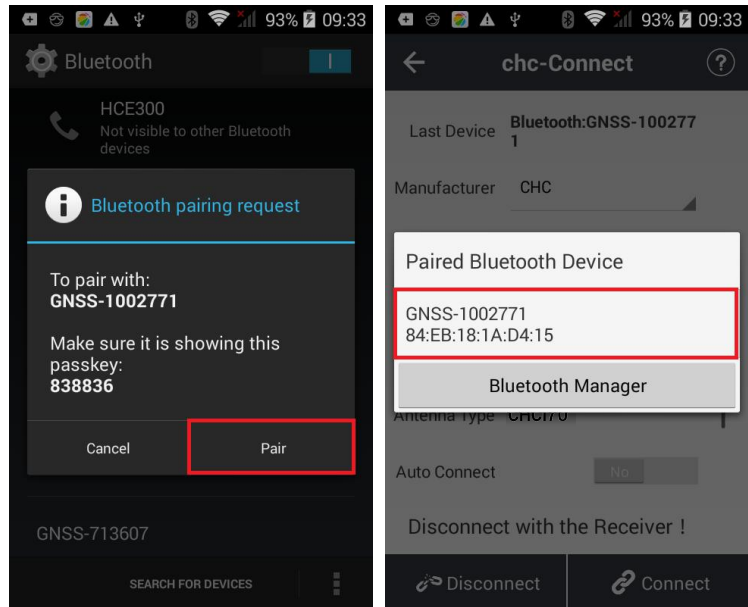

- 5. Tap the **Connect** button to build the connection.

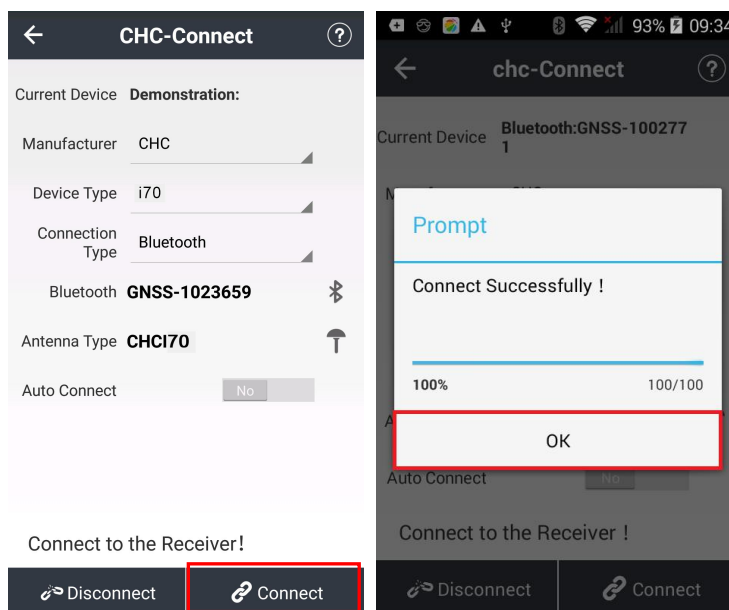

2.8. DOWNLOADING LOGGED DATA

Data logging involves the collection of GNSS measurement data over a period of time at a static point or points, and subsequent postprocessing of the information to accurately compute baseline information. Data logging using receivers requires access to suitable GNSS postprocessing software such as the CHC Geomatics Office (CGO) Software.

The procedures of downloading logged data in the receiver are as follows:

1. Switch on the receiver and connect it with a computer by USB Cable. After the successful connection, a removable disk named as the Serial Number (SN) of the receiver will appear on the computer.
2. Double click the removable disk and you will see the folder named as "repo". Double click this folder, you will see 9 folders. The "push_log" folder is used to save the log files, and the other 8 folders represent different logging session and are used for store static data.
3. Double click the folder that you has configured to store the static data, you will see the folder(s) created by the i70 system automatically and named by the date which is decide by GPS time when you start to log data.
4. Select the destination folder and double click it, and then two folders named as different data format (hcn and rinex) will be displayed.
5. Select the data format that you has configured to save the static data, you will find the static raw data.

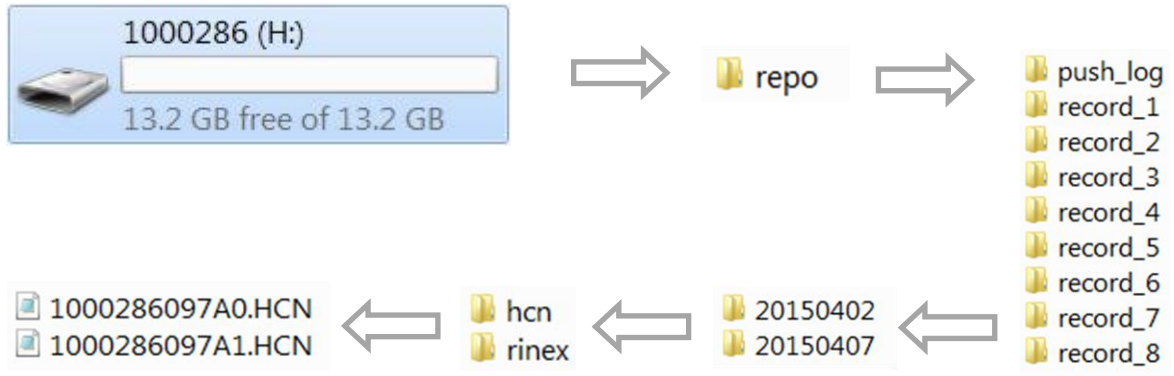

Tip – For hcn files, the name of the file is represented as XXXXXDDNN, where XXXXX is the SN of the receiver, DDD is day of year, and NN is the recording session.



WARNING – The static data will be saved in the first logging session, the “record_1” folder, by default. Old files will be deleted if the storage space is full. If you configure not to auto delete old files when the memory is low, the receiver will stop data logging.

3. FRONT PANEL OPERATION

The front panel contains one LCD screen, two indicator LEDs, and two buttons. The operating controls are all located on the front panel.

3.1. MAIN OPERATION MENUS

The main operation menus of the front panel are as follows:

Top-level Menu	Second-level Menu	Description
SV: 22 Battery: 97%		<ul style="list-style-type: none"> Click Enter button to enter the second-level menus. Indicates the number of the satellites tracked and the internal batteries power remaining. If the receiver is searching for satellites and the batteries are not be inserted, this menu will be displayed as “SV: Getting Battery: N/A”.
	22 = G09 R05 C07 S00 E0	Indicates the total number of satellites that have been tracked and the number of satellites tracked of each constellation, where G represents GPS, R represents GLONASS, C represents BeiDou, S represents SBAS and E represents Galileo.
	Pwr: A 97% B 97%	Indicates the remaining power of the battery inserted in the left (B) and right (A) battery compartment.
	Wlan Status On Wlan Mode HotSpot	<ul style="list-style-type: none"> Indicates the Wi-Fi status. Click Enter button to change the status, and then click Fn button to cancel the change, or click Enter button to confirm the change.
	Dial Status Offline	<ul style="list-style-type: none"> Indicates whether the receiver has been connected to cellular network. Generally, when the SIM card has been inserted before the receiver is turned on, this menu will be displayed as “Dial Status Online”.
	Cancel	Click Enter button to back to the top-level menu.

Mode Rover UHF	<ul style="list-style-type: none"> Base Cable Base Int. UHF Base APIS Base APIS & Cable Rover APIS Rover Ntrip/IP Rover UHF Cancel 	<ul style="list-style-type: none"> • Click Enter button to enter the second-level menus. • Indicates the current working mode. • Click Enter button to enter the configuration screen of the selected working mode. • More operation information, see 3.2. Configure the working mode.
Static Off	<ul style="list-style-type: none"> Set Off Recorded 00:02 Epoch Intv 1s Mask Angle 13 Degree Duration time 1440 min 	<p>Click Enter button to back to the top-level menu.</p> <ul style="list-style-type: none"> • Click Enter button to enter the second-level menus. • Indicates the current data logging status: Static Off or Static On. <p>Click Enter button to change the data logging status.</p> <p>Indicates the duration of data logging.</p> <ul style="list-style-type: none"> • Click Enter button to change the measurement interval. • The available options are: 0.2s, 0.5s, 1s, 2s, 5s, 10s, 15s, 30s, and 60s. <p>Click Enter button to change the mask degree from 0 degree to 15 degrees.</p> <ul style="list-style-type: none"> • Click Enter button to enter <i>Duration Time Setting</i> screen. • In the <i>Duration Time Setting</i> screen, click Fn button to move to the character of the duration time value you want to make change, and then click Enter button to change from 0 to 9. After the change has been done, you can click Fn button to move to OK field, and then click Enter button to save the change and back to the second-level menu; or click Fn button to move to Cancel field and click Enter button to cancel the change and back to the second-level menu.
	OK	<p>Click Enter button to save the settings of the data logging and back to the top-level menu, and then the settings will take effect.</p>

Receiver Info.	Cancel	Click Enter button to cancel the settings of the data logging and back to the top-level menu. Click Enter button to enter the second-level menus and check the basic information about the receiver.
	SN 1000514	Displays the Serial Number (SN) of the receiver.
	PN 1180020032231	Displays the Part Number (PN) of the receiver.
	Reg. 20301231	Displays the expiry date of registration code.
	Ver. 1.1.41	Displays the firmware version.
	Language English	Click Enter button to change the display language between Chinese, English and Russian.
	Cancel	Click Enter button to back to the top-level menu.

3.2. CONFIGURE THE WORKING MODE

7 working modes are provided for quickly setting up a RTK base station or rover station. Users can configure each working mode through front panel as follows:

Working Mode	Menus in Configuration Screen	Description
Base Cable		<ul style="list-style-type: none"> Set up the receiver as a base station using external UHF. Click Enter button to enter the configuration screen.
	Mode Base Cable	The title of this configuration screen.
	Format CMR	<ul style="list-style-type: none"> Click Enter button to change the correction format. The available correction formats are: CMR, CMR+, SCMR, RTCM v2.3, RTCM v3, and RTCM v3.2.
	OK	Click Enter button to save the settings and back to the top-level menu, and then this working mode will take effect.
Base Int. UHF	Cancel	Click Enter button to cancel the settings and back to the second-level menu.
		<ul style="list-style-type: none"> Set up the receiver as a base station using internal UHF. Click Enter button to enter the configuration screen.
	Mode Base Int. UHF	The title of this configuration screen.

	Channel 1	Click Enter button to change the channel from 1 to 9.
	Format CMR	<ul style="list-style-type: none"> Click Enter button to change the correction format. The available correction formats are: CMR, CMR+, SCMR, RTCM v2.3, RTCM v3, and RTCM v3.2.
	Power 2w	<ul style="list-style-type: none"> Click Enter button to change the transmitting power. The available transmitting power options are: 0.1w, 0.5w, 1w and 2w.
	Protocol CHC	Indicates the current protocol.
	OK	Click Enter button to save the settings and back to the top-level menu, and then this working mode will take effect.
	Cancel	Click Enter button to cancel the settings and back to the second-level menu.
Base APIS		<ul style="list-style-type: none"> Set up the receiver as a base station using APIS service. Click Enter button to enter the configuration screen.
	Mode Base APIS	The title of this configuration screen.
	Format CMR	<ul style="list-style-type: none"> Click Enter button to change the correction format. The available correction formats are: CMR, CMR+, SCMR, RTCM v2.3, RTCM v3, and RTCM v3.2.
	IP 211.144.118.5	<ul style="list-style-type: none"> Click Enter button to enter <i>Common IP</i> screen. In <i>Common IP</i> screen, click Fn button to move to the line of IP address, and then click Enter button to change to other predefined IP address. After the IP address has been changed, you can click Fn button to move to OK field, and then click Enter button to save the change and back to the second-level menu; or click Fn button to move to Cancel field and click Enter button to cancel the change and back to the second-level menu.
	Port 9901	Click Enter button to change the port from 9901

		to 9920.
	OK	Click Enter button to save the settings and back to the top-level menu, and then this working mode will take effect.
	Cancel	Click Enter button to cancel the settings and back to the second-level menu.
Base APIS & Cable		<ul style="list-style-type: none"> Set up the receiver as a base station using both APIS service and external UHF. Click Enter button to enter the configuration screen.
	Mode Base APIS & Cable Way Cable & APIS	The title of this configuration screen. Indicates that the receiver is set up as a base station using not only external UHF, but also APIS service
	Format CMR	<ul style="list-style-type: none"> Click Enter button to change the correction format. The available correction formats are: CMR, CMR+, SCMR, RTCM v2.3, RTCM v3, and RTCM v3.2.
	IP 211.144.118.5	<ul style="list-style-type: none"> Click Enter button to enter <i>Common IP</i> screen. In <i>Common IP</i> screen, click Fn button to move to the line of IP address, and then click Enter button to change to other predefined IP address. After the IP address has been changed, you can click Fn button to move to OK field, and then click Enter button to save the change and back to the second-level menu; or click Fn button to move to Cancel field and click Enter button to cancel the change and back to the second-level menu.
	Port 9901	Click Enter button to change the port from 9901 to 9920.
	OK	Click Enter button to save the settings and back to the top-level menu, and then this combination working mode will take effect.
	Cancel	Click Enter button to cancel the settings and back to the second-level menu.
Rover APIS		<ul style="list-style-type: none"> Set up the receiver as a rover station using APIS service. Click Enter button to enter the

		configuration screen.
Mode Rover APIS		The title of this configuration screen.
Current Base SN 1000456		<ul style="list-style-type: none"> • Display the SN of corresponding base station. • Click Enter button to enter <i>Base SN setting</i> screen. In the <i>Base SN setting</i> screen, click Fn button to move to the character of the value you want to make change, and then click Enter button to change from digital 0 to 9 (in addition, the initial character can be changed to letter R). After the change has been done, you can click Fn button to move to OK field, and then click Enter button to save the change and back to the second-level menu; or click Fn button to move to Cancel field and click Enter button to cancel the change and back to the second-level menu.
	IP 211.144.118.5	<ul style="list-style-type: none"> • Click Enter button to enter <i>Common IP</i> screen. • In <i>Common IP</i> screen, click Fn button to move to the line of IP address, and then click Enter button to change to other predefined IP address. After the IP address has been changed, you can click Fn button to move to OK field, and then click Enter button to save the change and back to the second-level menu; or click Fn button to move to Cancel field and click Enter button to cancel the change and back to the second-level menu.
	Port 9901	Click Enter button to change the port from 9901 to 9920.
	OK	Click Enter button to save the settings and back to the top-level menu, and then this working mode will take effect.
	Cancel	Click Enter button to cancel the settings and back to the second-level menu.
Rover Ntrip/IP		<ul style="list-style-type: none"> • Set up the receiver as a rover station using Ntrip. • Click Enter button to enter the configuration screen.

	Mode Rover Ntrip/IP Status Logged	<p>The title of this configuration screen.</p> <ul style="list-style-type: none"> Indicates current status of Ntrip: Status Not Logged or Status Logged. Users need to use the web interface to configure the settings to log on Ntrip (see 7.5.1. IO Settings submenu → RTK Client for instruction) before.
	OK	<p><i>Note – Make sure a valid SIM card has been inserted in the receiver.</i></p> <p>Click Enter button to save the settings and back to the top-level menu, and then this working mode will take effect.</p>
	Cancel	<p>Click Enter button to cancel the settings and back to the second-level menu.</p>
Rover UHF		<ul style="list-style-type: none"> Set up the receiver as a rover station using internal UHF. Click Enter button to enter the configuration screen.
	Mode Rover UHF Channel 1	<p>The title of this configuration screen.</p> <p>Click Enter button to change the channel from 1 to 9.</p>
	Protocol CHC OK	<p>Indicates the current protocol.</p> <p>Click Enter button to save the settings and back to the top-level menu, and then this working mode will take effect.</p>
	Cancel	<p>Click Enter button to cancel the settings and back to the second-level menu.</p>

Note – The operation menus of front panel may vary from different firmware versions of your receiver. The menus described in this chapter are based on firmware version 1.1.41.

4. BASE STATION SETUP AND OPERATION

Real-Time Kinematic (RTK) operation provides centimeter-level precision by eliminating errors that are present in the GNSS system. For all RTK operations, you require both a rover receiver and a source of corrections from a base station or network of base stations.

A base station consists of a receiver that is placed at a known point. The receiver tracks the same satellites that are being tracked by the rover receiver simultaneously. Errors in the GNSS system are monitored at the base station, and a series of position corrections are computed. The messages are sent through a radio link to the rover receiver, where they are used to correct the real time positions of the rover.

This chapter provides the information to help you identify good setup locations, outlines basic precautions that you need to take to protect the equipment, and describes the conventional process to set up the base station and the configuring procedure that required for transmitting correction data.

4.1. BASE STATION SETUP GUIDELINES

For good performance, the following base station setup guidelines are recommended:

- Place the GNSS receiver in a location on the worksite where equal range in all directions provides full coverage of the site.
- Place the GNSS antenna in a location that has a clear line of sight to the sky in all directions. Do not place the antenna near vertical obstructions such as buildings, deep cuttings, site vehicles, towers, or tree canopy.
- The GNSS antenna must have a clear line of sight to the sky at all times during operation.
- Place the GNSS and radio antennas as high as practical. This minimizes multipath from the surrounding area, and enables the radio to broadcast to the maximum distance.
- Choose the most appropriate radio antenna for the size of the worksite. The higher the gain on the antenna, the longer the range.
- Make sure that the GNSS receiver does not lose power. To operate continuously for more than a few hours without loss of power at the base station, provide external power. When you use an external power supply, the integrated battery provides a backup power supply, enabling you to maintain continuous operation through a mains power failure.
- Do not locate a GNSS receiver, GNSS antenna, or radio antenna within 400 meters (about 1,300 feet) of transmitters, such as a power radar or

cellular communications tower.

- Do not set up the base station close to the sources of electromagnetic interference, include alternators and generators, electric motors, equipment with DC-to-AC converters, etc.
- Do not operate the receiver outside the specified operating temperature range -40°C to $+60^{\circ}\text{C}$ (-40°F to $+140^{\circ}\text{F}$).
- Take reasonable care to keep the GNSS receiver equipment dry, which could prolong their life and reduce the effects of corrosion on ports and connectors.

4.2. OUTPUTTING CORRECTIONS USING INTERNAL RADIO

MODEM

4.2.1. BASE STATION SETUP

1. Connect the radio antenna onto i70 receiver. Screw the receiver onto extension pole.
2. Screw the extension pole with auxiliary H.I. tool onto tribrach adaptor.
3. Mount the tribrach onto the tripod.
4. Insert the tribrach adaptor into the tribrach.
5. Level and plumb the receiver over the known (control) point.
6. Measure the height of the base station GNSS antenna by measuring the slant height from the known (control) point to the end of auxiliary H.I. tool.

Note –After entered the vertical height from the known (control) point to the bottom of receiver that you calculated by adding the height of the extension pole to the height from the known (control) point to the auxiliary H.I. tool, LandStar 7 will calculate the height to the Antenna Phase Center (APC) automatically.

7. If required, connect the receiver to an external 12 V power supply.

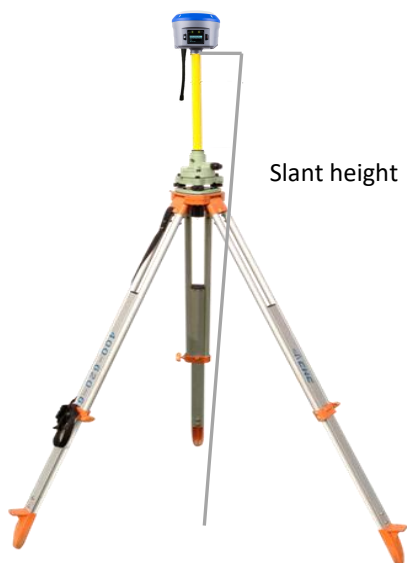

4.3. OUTPUTTING CORRECTIONS USING EXTERNAL RADIO

For base receiver part:

1. Screw the i70 receiver onto extension pole.
2. Screw the extension pole with auxiliary H.I. tool onto tribrach adaptor.
3. Mount the tribrach onto the tripod.
4. Insert the tribrach adaptor into the tribrach.
5. Level and plumb the receiver over the known (control) point.
6. Measure the height of the base station GNSS antenna by measuring the slant height from the known (control) point to the auxiliary H.I. tool.

Note – After entered the vertical height from the known (control) point to the bottom of receiver that you calculated by adding the height of the extension pole to the height from the known (control) point to the end of auxiliary H.I. tool, LandStar 7 will calculate the height to the Antenna Phase Center (APC) automatically.

7. If required, connect the receiver to an external 12 V power supply.

For external radio part (take the CHC DL6 Datalink for example):

8. Connect the Datalink Antenna to the 3 meter Cable for Datalink Antenna.
9. Connect 3 meter Cable for Datalink Antenna to Datalink Antenna Mounting Pole.
10. Screw the Datalink Antenna Mounting Pole onto the tribrach adaptor.
11. Mount the tribrach onto the tripod.
12. Insert the tribrach adaptor into the tribrach.
13. Set up the Datalink Antenna nearby the base receiver.

14. Fix the DL6 Datalink onto the tripod.
15. Place the car battery at an appropriate location.

For connection between the receiver part and external radio part:

16. Connect Datalink Antenna to the Datalink Antenna Slot of DL6 Datalink via 3 meter Cable for Datalink Antenna.
17. Connect the base receiver with DL6 Datalink via GPS to Datalink Cable.
18. Connect the car battery with DL6 Datalink via Datalink External Power Cable.



CAUTION – The Datalink Antenna must be connected to the Datalink before the Datalink is powered on; otherwise, the Datalink can be damaged.



5. ROVER STATION SETUP AND OPERATION

Real-Time Kinematic (RTK) operation provides centimeter-level precision by eliminating errors that are present in the GNSS system. For all RTK operations, you require both a rover receiver and a source of corrections from a base station or network of base stations.

The second part of the RTK GNSS system is the rover receiver. The rover receiver is moved between the points that require measurement or stakeout. The rover receiver is connected to a base station or to a source of RTK corrections such as a CORS (Continuous Operational Reference System) or the CHC APIS service. The connection is provided by:

- an integrated radio
- an integrated cellular modem
- a cellular modem in the controller

This chapter provides the information to help you identify good setup locations, describes the conventional process to set up the rover station and the configuring procedure that required for receiving correction data.

5.1. ROVER STATION SETUP GUIDELINES

For good rover operation, observe the following setup guidelines:

- Place the GNSS antenna in a location that has a clear line of sight to the sky in all directions. Do not place the antenna near vertical obstructions such as buildings, deep cuttings, site vehicles, towers, or tree canopy. GNSS rovers and the base station receive the same satellite signals from the same satellites. The system needs five common satellites to provide RTK positioning.



WARNING – Take care not to touch overhead power lines with the CHC i70 GNSS receiver or the range pole when moving the equipment into position. Touching overhead power lines may cause electrocution, leading to serious injury.

- GNSS satellites are constantly moving. Because you cannot measure at a specific location now does not mean that you will not be able to measure there later, when satellite coverage at the location improves.
- To get a fixed position solution with centimeter precision, initialize the RTK rover receiver. For initialization to take place, the receiver must track at least five satellites that the base station is also tracking. In a dual-satellite constellation operation, for example, GPS and GLONASS, the receiver must track at least six satellites.

- To continue to survey at centimeter precisions, the rover must continuously track at least four satellites that the base station is also tracking. The radio link between the base and rover receivers must also be maintained.
- Loss of the satellite signals will result in a loss of centimeter position precision.

5.2. ROVER STATION SETUP

1. If required, connect the radio antenna onto i70 receiver.
2. Screw the receiver on top of the range pole.
3. Fix the controller bracket on the range pole.
4. Fit the controller in the controller bracket.
5. Level and plumb the receiver over the target measuring point.



6. CONFIGURING THROUGH A WEB BROWSER

Supported browsers:

- Google Chrome
- Microsoft Internet Explorer® version 10, or higher

To connect to the receiver through a web browser:

1. Turn on the Wi-Fi of the receiver.
2. Search the wireless network named as GNSS-XXXXXXX (the SN of your receiver) on your computer, and then establish the connection.
3. After the successful connection between your computer and the receiver, enter the IP address of the receiver into the address bar of the web browser on your computer:

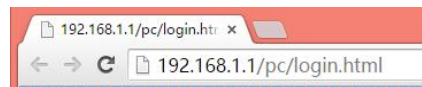

4. The web browser prompts you to enter a login account and password:

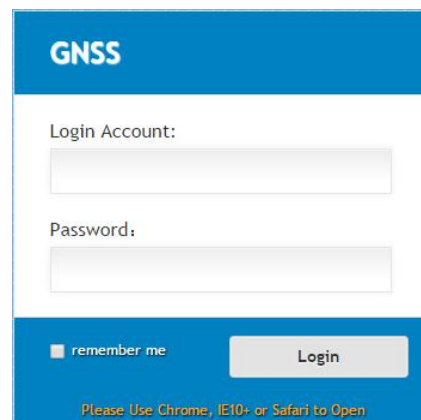
A screenshot of a web browser displaying a login page for a device named "GNSS". The page has a blue header with the text "GNSS" in white. Below the header, there are two input fields: "Login Account:" and "Password:". Below the "Password:" field, there is a checkbox labeled "remember me" and a "Login" button. At the bottom of the page, there is a small text message: "Please Use Chrome, IE10+ or Safari to Open".

The default login account for the receiver is:

- Login Account: admin
- Password: password

*Note – Tick **remember me** option, and then the browser will remember the Login Account and Password you entered for the next time you enter this login screen.*

5. Once you are logged in, the web page appears as follows:

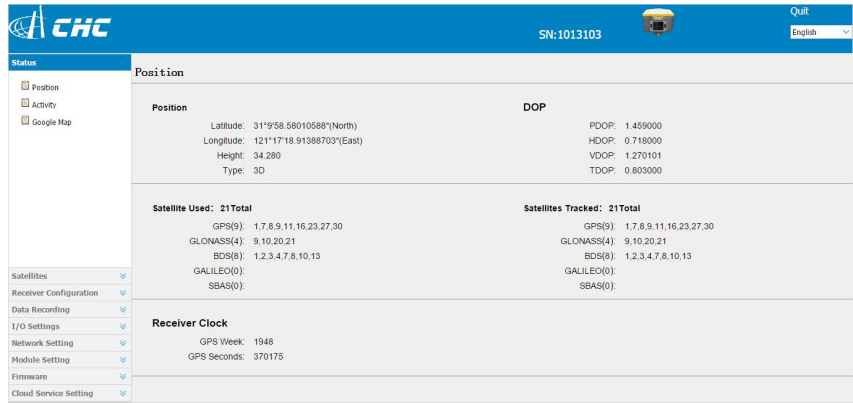

This web page shows the configuration menus on the left of the browser window, and the setting on the right. Each configuration menu contains the related submenus to configure the receiver and monitor receiver performance.

This chapter describes each configuration menu.

To view the web page in another language, select the corresponding language name from the dropdown list on the upper right corner of the web page.

Currently, three languages are available:

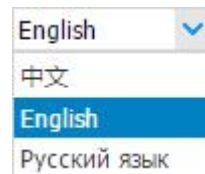

6.1. STATUS MENU

This menu provides a quick link to review the receiver's position information, satellites tracked, runtime, current data log status, current outputs, available memory, and more.



6.1.1. POSITION SUBMENU

This page shows the relevant position information about the receiver's

position solution which including the position, DOP values, satellites used and tracked, and the receiver clock information.

Position	
Position	DOP
Latitude: 31°58.72613874'(North)	PDOP: 1.220000
Longitude: 121°17'18.99714793'(East)	HDOP: 0.682000
Height: 28.304	VDOP: 1.011571
Type: 3D	TDOP: 0.713000
Satellite Used: 21 Total	Satellites Tracked: 21 Total
GPS(8): 1,7,8,9,11,16,27,30	GPS(8): 1,7,8,9,11,16,27,30
GLONASS(6): 9,10,11,19,20,21	GLONASS(6): 9,10,11,19,20,21
BDS(7): 1,2,3,7,8,10,13	BDS(7): 1,2,3,7,8,10,13
GALILEO(0):	GALILEO(0):
SBAS(0):	SBAS(0):
Receiver Clock	
GPS Week: 1948	
GPS Seconds: 370856	

6.1.2. ACTIVITY SUBMENU

Lists several important items to help you understand how the receiver is being used and its current operating condition. Items include the identities of currently tracked satellites, internal and external storage usage rate, how long the receiver has been operational, state of the internal battery, power source state, files being logged, and data streams being output. With this information, it is easy to tell exactly what functions the receiver is performing:

Activity	
Satellites Track: 20 Total	Activity Status
GPS(8): 1,7,8,9,11,16,27,30	Current Time: 2017-05-11 07:02:49 (UTC)
GLONASS(6): 9,10,11,19,20,21	Operation Duration: 00-00-00 00:21:04
BDS(6): 2,3,7,8,10,13	Internal Storage: <input type="text" value="0.68%"/> 202MB/29728MB
GALILEO(0):	External Storage: <input type="text" value="0%"/> Disconnected
SBAS(0):	External Power: Connected
	Battery A: <input type="text" value="0%"/>
	Battery B: <input type="text" value="0%"/>

Data Log			
Recording Number	File Name	Activated	Log Status
1	record1	No	Inactive
2	record2	No	Inactive
3	record3	No	Inactive
4	record4	No	Inactive
5	record5	No	Inactive
6	record6	No	Inactive
7	record7	No	Inactive
8	record8	No	Inactive

Data Export		
Port Type	Output Data	
1	RTK Client	---
2	TCP/UDP_Client1/RTKIP S	---
3	TCP/UDP_Client2/RTKIP S	---
4	TCP/UDP_Client3/RTKIP S	---
5	TCP/UDP_Client4/RTKIP S	---
6	TCP/UDP_Client5/RTKIP S	---
7	TCP/UDP_Client6/RTKIP S	---
8	TCP Server/RTKIP Client	---
9	TCP Server/RTKIP Client	---
10	TCP Server/RTKIP Client	---
11	TCP Server/RTKIP Client	---
12	Serial Port	GPSA_Sx
13	Bluetooth	GPSA_Sx
14	Radio	---
15	GSM	---

6.1.3. GOOGLE MAP SUBMENU

Tap this submenu to show the location of the receiver on Google map.

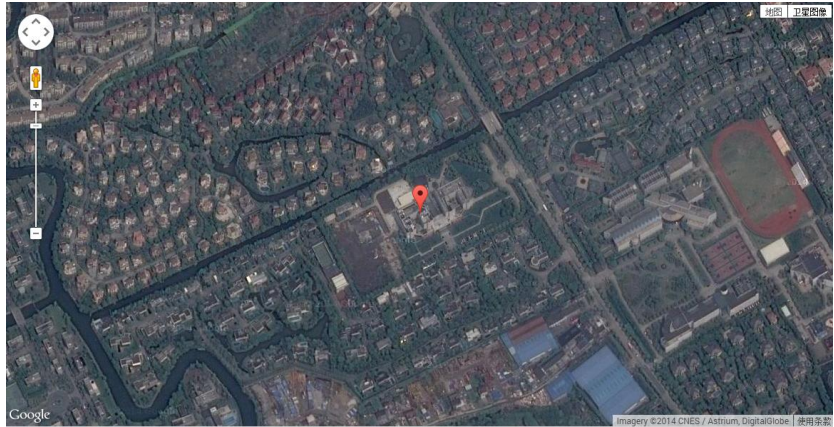

6.2. SATELLITES MENU

Use the Satellites menu to view satellite tracking details and enable/disable GPS, SBAS, GLONASS, BDS and Galileo constellations. These menus include tabular and graphical displays to provide all required information on satellite tracking status.



6.2.1. TRACKING TABLE SUBMENU

Provides the status of satellites tracked in general, such as the satellite ID, satellite type, attitude angle, azimuth angle, L1 SNR, L2 SNR, L5 SNR and enable/disable status of each one.

ID	Type	Elevation Angle	Azimuth Angle	L1 SNR	L2 SNR	L5 SNR	Enabled
1	GPS	80	180	43.224	36.502	0.000	Yes
7	GPS	62	291	50.767	42.422	0.000	Yes
9	GPS	61	111	50.687	43.187	0.000	Yes
9	GPS	14	204	39.876	30.895	0.000	Yes
11	GPS	64	202	50.450	42.431	0.000	Yes
16	GPS	21	92	36.483	30.539	0.000	Yes
27	GPS	29	44	45.052	33.664	0.000	Yes
30	GPS	26	315	43.215	32.061	0.000	Yes
9	GLONASS	27	132	43.719	45.671	0.000	Yes
10	GLONASS	12	9	45.961	44.004	0.000	Yes
11	GLONASS	22	309	39.639	41.404	0.000	Yes
19	GLONASS	12	31	33.631	37.786	0.000	Yes
20	GLONASS	64	4	41.421	45.119	0.000	Yes
21	GLONASS	50	236	45.885	46.211	0.000	Yes
2	BDS	25	235	37.007	40.947	41.625	Yes
3	BDS	63	250	42.463	43.521	45.278	Yes
4	BDS	25	111	32.847	38.953	0.000	Yes
7	BDS	61	92	36.431	45.692	47.090	Yes
8	BDS	22	223	27.564	45.705	47.521	Yes
10	BDS	69	225	38.828	44.253	45.898	Yes
13	BDS	44	221	37.359	40.187	42.245	Yes

6.2.2. TRACKING INFO. TABLE SUBMENU

The following figure is an example of satellite track diagram page. Users can determine the satellite types and the corresponding SNR of L-band carriers to be displayed in any combination.

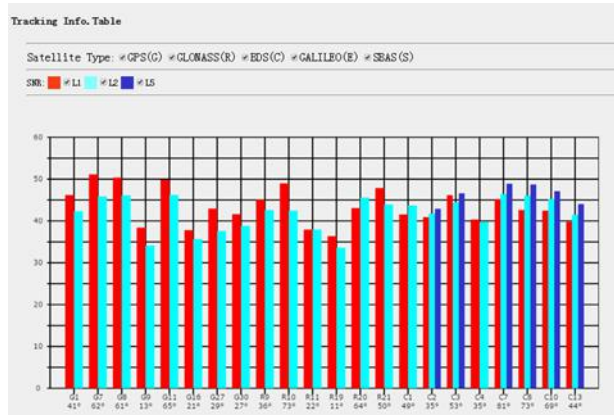

6.2.3. TRACKING SKY PLOT SUBMENU

The following figure is an example of Skyplot page.

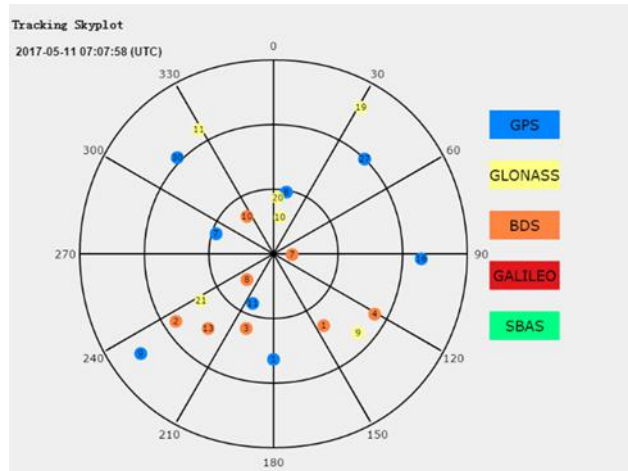

6.2.4. SATELLITE ACTIVATION SUBMENU

Use this menu to enable or disable satellites.



6.3. RECEIVER CONFIGURATION MENU

Use this menu to configure settings such as the antenna type and height, elevation mask and PDOP setting, the reference station coordinates, receiver resetting and web interface language:

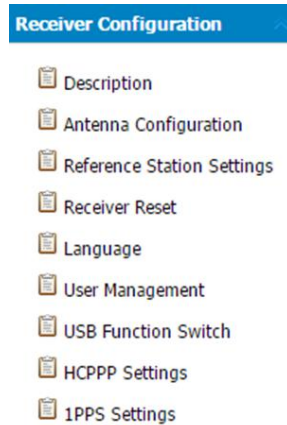

6.3.1. DESCRIPTION

This submenu shows the receiver information and reference station information, including antenna related information, elevation mask angle, reference station work mode and position, etc.

Receiver Summary	
Receiver Info:	Reference Station Info:
Antenna Type: CHCI70	Reference Station Mode: Auto Rover
Antenna SN: 1013103	Reference Latitude: 0°00.00000000'(South)
Measure Way: Antenna Phase Center	Reference Longitude: 0°00.00000000'(West)
Antenna Height: 2.0000(Meter)	Reference Height: 0.0000
Elevation Mask: 10	
PDOP Mask: 6	

6.3.2. ANTENNA CONFIGURATION SUBMENU

Use this screen to configure all of the items relating to the GNSS antenna. You must enter the correct values for all antenna-related fields, as the choices you make significantly affect the accuracy for logged data and broadcast correction data:

 A screenshot of the 'Antenna Configuration' form. The form has a title 'Antenna Configuration' and contains several fields: 'Measure Way' (dropdown menu set to 'Antenna Phase Cente'), 'Antenna manufacturer' (dropdown menu set to 'CHCNav'), 'Antenna Type' (dropdown menu set to 'CHCI70'), 'Antenna SN' (text input field with '1013103'), 'Antenna Height' (text input field with '2.0000' and '(Meter)' label), 'Elevation Mask' (text input field with '10'), and 'PDOP Mask' (text input field with '6'). At the bottom right of the form is a 'Save' button with a floppy disk icon.

6.3.3. REFERENCE STATION SETTINGS SUBMENU

Use this screen to configure settings such as the station coordinates and the broadcast station identifiers. You must enter accurate information in these fields, as this data significantly affects the accuracy of logged data files and broadcast correction data:

Reference Station Settings

Reference Station Mode:

Base Station Name:

Base Station ID:

Reference Latitude: ° ' " N S

Reference Longitude: ° ' " E W

Reference Height:

Sample for Average:

Positioning Constraint: Single Solution Coordinates Fixed Solution Coordinates

Sampling Amount:

Reference Station Settings

Reference Station Mode:

Sample for Average:

Positioning Constraint: Single Solution Coordinates Fixed Solution Coordinates

Sampling Amount:

Reference Station Settings

Reference Station Mode:

Base Station Name:

Base Station ID:

Reference Latitude: ° ' " N S

Reference Longitude: ° ' " E W

Reference Height:

Sample for Average:

Positioning Constraint: Single Solution Coordinates Fixed Solution Coordinates

Sampling Amount:

For Reference Station Mode:

There are three modes available:

- a) **Auto Rover:** The receiver will serve as a rover after this mode is enabled, and then receive correction data through the working mode set last time.
- b) **Auto Base:** The receiver will serve as a base after this mode is enabled, and then broadcast correction data based on coordinate inputted by user, or obtained through autonomous positioning automatically.
- c) **Manual Base:** The receiver will serve neither as a base or a rover after this mode is enabled. Users need to configure the receiver manually.

For Reference Latitude and Reference Longitude:

There are mainly three methods to enter the reference coordinates and shown as follows:

- a) **Acquire Current Position:** Click this button to acquire current position obtained through autonomous positioning automatically.
- b) **Manual Input:** Manually input the coordinate of a control point.
- c) **From CORS:** After the receiver logging in CORS, the software can record the coordinate of current position based on fix solution.

For Sample for Average:

Users can determine the positioning limit and sampling amount. The positioning limit falls into two types:

- a) **Single Solution Coordinates:** Collect the coordinates of receiver obtained through autonomous positioning.
- b) **Fixed Solution Coordinates:** Only collect coordinates of receiver with a fixed solution.

After the configuration of positioning limit and sampling amount, click



to carry out sampling and averaging → the progress bar will show the progress → the result will be served as the coordinate of current position.

If users need to save the changes, please tap  button.

6.3.4. RECEIVER RESET SUBMENU

Use this screen to completely or partially reset the receiver:

Receiver Reset

- Reboot Receiver: Confirm
- Clear Satellite Data: Confirm
- Reset To Defaults: Confirm
- Turn Off Receiver: Confirm

6.3.5. LANGUAGES SUBMENU

Use this screen to select the web interface language:

Language

English Confirm

中文

English

Русский

Türkçe

Español

6.3.6. USER MANAGEMENT SUBMENU

User Management

Add Save Delete Modify Anti-theft password

ID	User Name	Password
1	admin	*****
2	admin1	*****
3	admin2	*****

6.3.7. USB FUNCTION SWITCH SUBMENU

Use this menu to switch between USB personal area network and Multimedia storage.

USB Function Switch

USB Function Switch: USB personal area network Multimedia storage

6.3.8. HCPPP SETTINGS SUBMENU

Use this menu to select HCPPP Range.

HCPPP Settings

HCPPP Range: 5min

6.3.9. 1PPS SUBMENU

Use this button to turn on or turn off 1PPS.

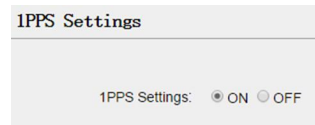

6.4. DATA RECORDING MENU

Use the Data Logging menu to set up the receiver to log static GNSS data and to view the logging settings. You can configure settings such as observable rate, recording rate, continuous logging limit, and whether to auto delete old files if memory is low. This menu also provides the controls for the FTP push feature:

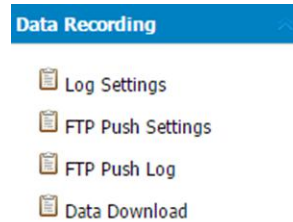

6.4.1. LOG SETTINGS SUBMENU

Here shows the data logging status, including internal and external storage usage and data logging status of each session. Also, users can configure the data logging settings for each session, including recording name, store location, storage limit, store formats, start time, etc.

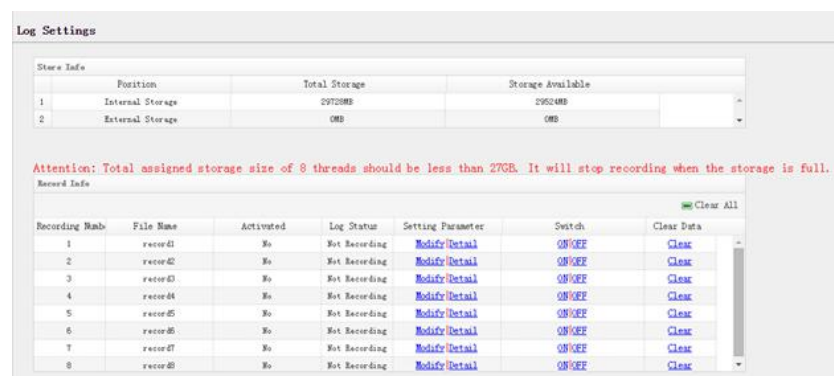

To edit the settings of each session, click the **Modify** button to the right of the required session, and then the *Recording Edit* screen appears:

The 'Recording Edit' window contains the following settings:

- Auto Record: Yes No
- Sample Interval: 5s
- Elevation Mask: 10 (°)
- Duration Time: 1440 (Minute)
- Site Name: 1013103
- Antenna Height: 0.0000
- Measure Way: Slant Height
- Storage Format: HCN
- RINEX Version: OFF

At the bottom, there is an 'Advanced' button, a 'Save' button, and a 'Back' button.

Click advanced to see more settings.

The 'Advanced' window contains the following settings:

- Start Date: Yes No
- Apply Time: Yes No
- Integral Point Store: Yes No
- Circulating Memory: Yes No
- Repeat Observations: Yes No
- Store Location: Internal Storage
- Assigned Storage: 10000 (MB)
- Observer: CHC
- Observe Agency: CHC
- FTP Push: Close, 1:ftp server 1, 2:ftp server 2, 3:ftp server 3

Additional text in the window: "the data overwritten first file after storage space is full" and "Turn on to record a single observation. Turn off to record repeated observations."

In this screen, you can configure all the data logging parameters, and determine whether the recording files will be affected by the FTP Push. The parameters are mainly as follows:

- **File Name:** The name of this logging session.
- **Sample Interval:** Select the observable rate from the dropdown list.
- **Store Location:** Determine whether to store at internal storage or external storage.
- **Enable Start Time:** Set the start time of data logging in UTC. Select **Or not** option below to determine whether to start data logging from the start time defined, or immediately after this session is switched on.
- **Duration Time:** Set the duration of data logging.
- **Assigned Storage:** Set the storage space of this session.
- **Circulating Memory:** Select **Yes** or **No** option to determine whether to auto delete old files if the storage space is full.
- **Data Format:** Set the data format of the logged data.
- **FTP Push:** Decide whether to push the stored files to the FTP server of your choice.

Tap  **Save** button to save the settings and back to the *Log Settings*

screen. Also, users can click  **Back** to abandon the changed settings and back to *Log Settings* screen.

Note – To modify data logging parameters, make sure the data logging session is switched off.

To switch on or off **ANY** data logging session, tap the **ON** or **OFF** button to the right of the required session.

To delete the recorded files of **ANY** data logging session, tap the **Clear** button to the right of the required session.

To delete the recorded files of **ALL** data logging sessions, tap the **Clear ALL Accounts** button.

6.4.2. FTP PUSH SETTINGS SUBMENU

Use this screen to configure the receiver to push stored files to the FTP server of your choice. Only files that are configured to use FTP push are transmitted.

FTP Push Settings

Server ID	Server IP	Remote Directory	Server Description	Modify
1	192.168.3.72	/repo/first	ftp server 1	Modify
2	192.168.3.72	/repo/second	ftp server 2	Modify
3	192.168.3.72	/repo/third4	ftp server 3	Modify

Tap **Modify** button to the right of the required FTP server and the *FTP Push Settings* screen appears:

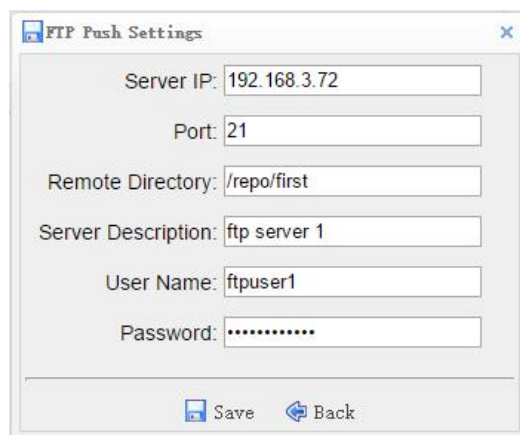

FTP Push Settings

Server IP: 192.168.3.72



Port: 21

Remote Directory: /repo/first

Server Description: ftp server 1

User Name: ftpuser1

Password:

 **Save**  **Back**

6.4.3. FTP PUSH LOG SUBMENU

Shows the related information about the recorded files that were pushed. And users can tap **Clear Ftp Send Log** button in the upper right corner to clear the log of FTP Push operations.



6.4.4. DATA DOWNLOAD SUBMENU

In this submenu, users can download the data files that were recorded in the internal storage through the internal FTP site.

1. Click this submenu, and then the log on dialogue box will prompt you to enter a user name and password:

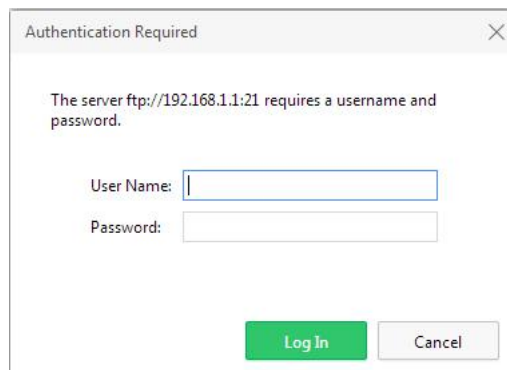

The default logon account for the internal FTP site is:

- User name: ftp
- Password: ftp

2. Click the directory named as “repo” to view and download the files currently stored on the receiver:

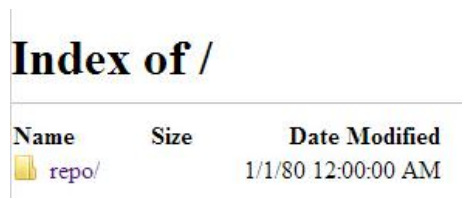

3. To find the file need to be downloaded, click the name of data logging session → the date of file that be recorded → the format of the file → the name of the target file.

Index of /repo/record_1/20150518/rinex/

Name	Size	Date Modified
[parent directory]		
1000514138D.15C	0 B	5/18/15 3:04:00 AM
1000514138D.15G	0 B	5/18/15 3:04:00 AM
1000514138D.15N	0 B	5/18/15 3:04:00 AM
1000514138D.15O	8.0 kB	5/18/15 3:04:00 AM
1000514138F.15C	0 B	5/18/15 5:56:00 AM
1000514138F.15G	0 B	5/18/15 5:56:00 AM
1000514138F.15N	0 B	5/18/15 5:56:00 AM
1000514138F.15O	240 kB	5/18/15 5:59:00 AM
1000514138I.15C	0 B	5/18/15 8:15:00 AM
1000514138I.15G	0 B	5/18/15 8:15:00 AM
1000514138I.15N	0 B	5/18/15 8:15:00 AM
1000514138I.15O	64.0 kB	5/18/15 8:16:00 AM

- To download a file, left-click the name of the target file → download the file according to the prompts.

6.5. IO SETTINGS MENU

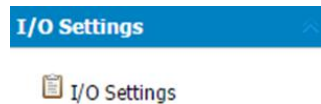

Use the IO Settings menu to set up all receiver outputs and inputs. The receiver can output CMR, RTCM, Raw data, Ephemeris data, GPGGA, GPGSV, on TCP/IP, UDP, serial port, or Bluetooth ports.

6.5.1. IO SETTINGS SUBMENU

The following figure shows an example of the screen that appears when you select this submenu.

I/O Settings					
	Type	Description	Output	Connection Status	Modify
1	RTX Client	211.144.118.5:2102	---	Disconnected	Connect Disconnect Data
2	TCP/UDP_Client1/RTXIP Serv	192.168.3.18:9900	---	Disconnected	Connect Disconnect Data
3	TCP/UDP_Client2/RTXIP Serv	192.168.3.18:9901	---	Disconnected	Connect Disconnect Data
4	TCP/UDP_Client3/RTXIP Serv	192.168.3.18:9902	---	Disconnected	Connect Disconnect Data
5	TCP/UDP_Client4/RTXIP Serv	192.168.3.18:9903	---	Disconnected	Connect Disconnect Data
6	TCP/UDP_Client5/RTXIP Serv	192.168.3.18:9904	---	Disconnected	Connect Disconnect Data
7	TCP/UDP_Client6/RTXIP Serv	192.168.3.18:9905	---	Disconnected	Connect Disconnect Data
8	TCP Server/RTXIP Cluster1	9901	---	Closed	Connect Disconnect Data
9	TCP Server/RTXIP Cluster2	9902	---	Closed	Connect Disconnect Data
10	TCP Server/RTXIP Cluster3	9903	---	Closed	Connect Disconnect Data
11	TCP Server/RTXIP Cluster4	9904	---	Closed	Connect Disconnect Data
12	Serial Port	9900	---	---	Settings
13	Bluetooth	GNSS-1013103	GPGGA, GPRMC	---	Settings
14	Radio	462.0500Mhz	---	---	Settings
15	GSM	Borer	---	Offline	Settings/Connect

In this submenu, users can configure 6 types of input and output settings.

1. RTK Client

After configuring the settings of RTK client, users can log on CORS or APIS. Tap the **Connect** button to the right → the *IO Settings* screen will appear → choose one of the connection protocols among the NTRIP, APIS_BASE and

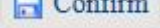
APIS_ROVER → configure the related parameters → click  to log on CORS or APIS.

➤ Connection Protocol: NTRIP

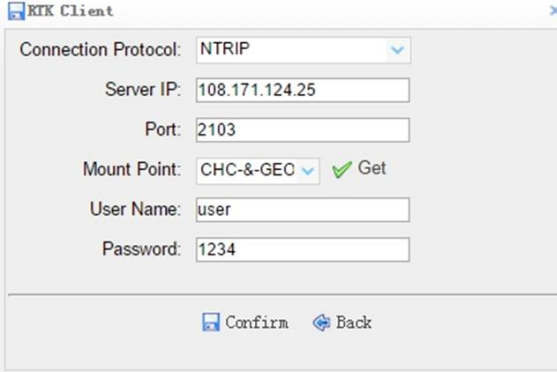

The screenshot shows the 'RTK Client' configuration window with the following settings:

- Connection Protocol: NTRIP
- Server IP: 108.171.124.25
- Port: 2103
- Mount Point: CHC-&-GEC (with a green checkmark and 'Get' text)
- User Name: user
- Password: 1234

At the bottom, there are 'Confirm' and 'Back' buttons.

➤ Connection Protocol: APIS_BASE

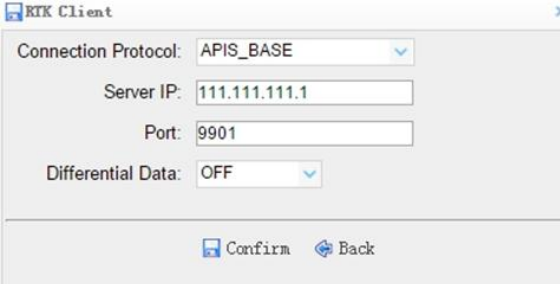

The screenshot shows the 'RTK Client' configuration window with the following settings:

- Connection Protocol: APIS_BASE
- Server IP: 111.111.111.1
- Port: 9901
- Differential Data: OFF

At the bottom, there are 'Confirm' and 'Back' buttons.

➤ Connection Protocol: APIS_ROVER

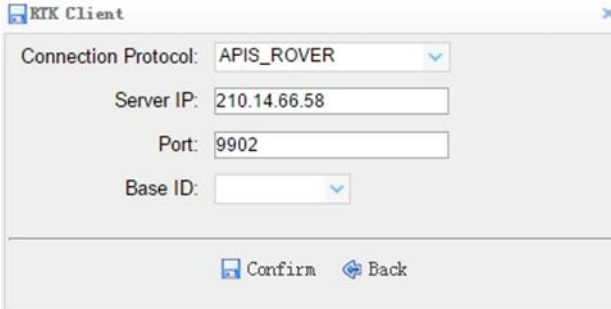

The screenshot shows the 'RTK Client' configuration window with the following settings:

- Connection Protocol: APIS_ROVER
- Server IP: 210.14.66.58
- Port: 9902
- Base ID: (empty dropdown menu)

At the bottom, there are 'Confirm' and 'Back' buttons.

2. TCP/UDP Client

Tap the **Connect** button to the right of required TCP/UDP Client → the *IO Settings* screen will appear → select the connection protocol between TCP and UDP → enter the IP and Port of the target server → configure messages that you want to output to the target server → click  to save and complete the connection.

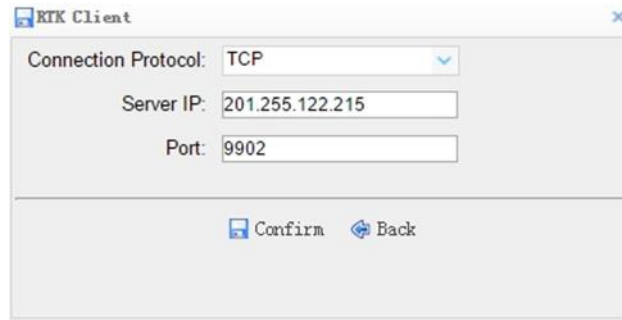

3. TCP Server/NTRIP Caster

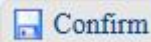
Tap the **Connect** button to the right of required TCP Server/NTRIP Caster → the **IO Settings** screen will appear → select one of the connection protocols between NTRIP and TCP → configure the other related parameters → click  to save the settings and open the server.

➤ Connection Protocol: NTRIP

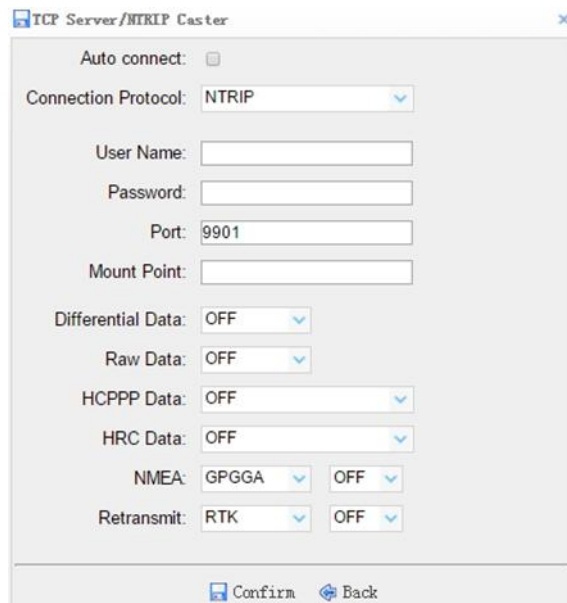

➤ Connection Protocol: TCP

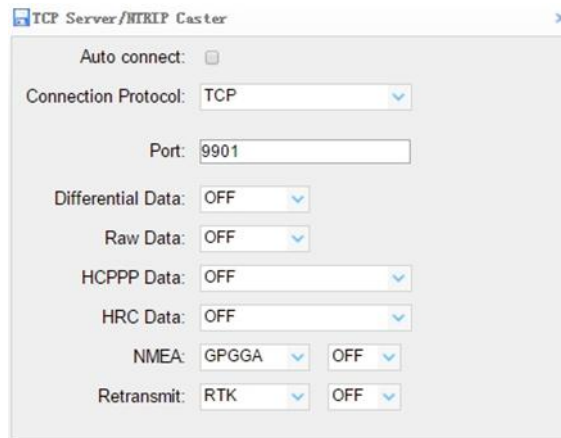

4. Serial Port

Tap the **Settings** button to the right of Serial Port → the *Serial Port Setup* screen will appear → select Baud Rate used to transmit data → configure the messages that you want to output through the serial port → click

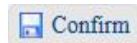

to save the settings and start to transmit.

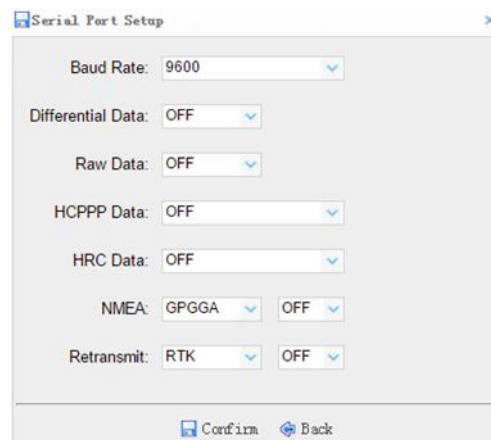

5. Bluetooth

Tap the **Settings** button to the right of Bluetooth → the *Bluetooth Set* screen will appear → configure the messages that you want to transmit through

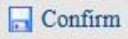
Bluetooth → click  to save the settings and start to transmit.

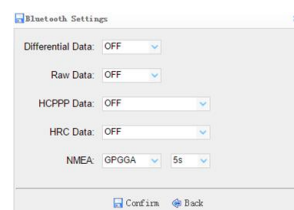

6. Radio

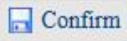
Tap the **Settings** button to the right of Radio → the *Radio Settings* screen will appear → select the format of differential data that you want to transmit through radio from the dropdown list → click  to save the settings and start to transmit.

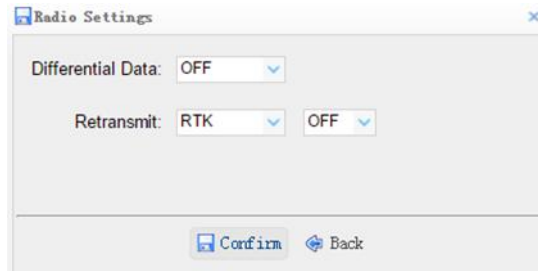

6.6. NETWORK SETTING MENU

Use this menu to view network information, configure the receiver’s mobile network, set email alert for specific situation, configure HTTP or HTTPS port, and the user name and password of internal FTP site:

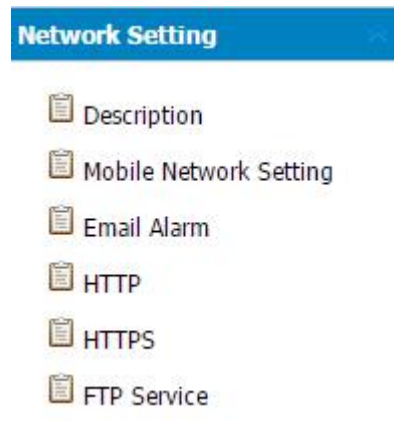

6.6.1. DISRIPTION SUBMENU

Use this submenu to check the information of network setting.

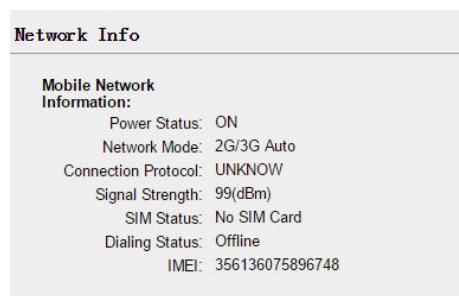

6.6.2. MOBILE NETWORK SETTING SUBMENU

Use this submenu to configure GPRS model, network module and modify dialing status.

The screenshot shows the 'Mobile Network Setting' web interface. It contains several sections:

- GPRS Model Status:** A toggle switch currently set to 'ON', with 'OFF' also visible.
- Auto Start:** Radio buttons for 'Yes' and 'No', with 'No' selected.
- Network Mode:** Radio buttons for '2G Only', '3G Only', and '2G/3G Auto', with '2G/3G Auto' selected.
- Dialing Status:** A toggle switch currently set to 'Offline', with 'Dial' and 'Break' also visible.
- Auto Connect:** Radio buttons for 'Yes' and 'No', with 'No' selected.
- GSM Section:** Includes a 'GSM' checkbox (unchecked), an 'APN' text field with '3gnet', a 'Dialing String' dropdown menu with '99#', a 'User Name' text field with 'card', and a 'Password' text field with masked characters.

 A 'Save' button is located at the bottom right of the form.

6.6.3. EMAIL ALARM SUBMENU

Use this submenu to choose which situation of receiver will be alerted and input the email address.

The screenshot shows the 'Email Alert Settings' web interface, divided into three main sections:

- TO:** Three text input fields for 'Email Address 1', 'Email Address 2', and 'Email Address 3', all containing 'test@huacnav.com'. A 'Save' button is below this section.
- From:** Three text input fields for 'Account', 'Password', and 'Server Address'. A 'Save' button is below this section.
- Email Alert:** A list of five checkboxes:
 - Receiver is powered on
 - External power is off
 - Battery level is low
 - Ftp push is failed
 - Receiver(license) will be expired in 7 days.
 A 'Save' button is at the bottom right of this section.

6.6.4. HTTP SUBMENU

Use this submenu to configure HTTP port.

The screenshot shows the 'HTTP' web interface. It features a single text input field labeled 'HTTP Port' with the value '80'. A 'Save' button is positioned below the input field.

6.6.5. HTTPS SUBMENU

Use this submenu to configure HTTPS port.

HTTPS

Enable HTTPS: Yes No

HTTPS Port:

 Save

6.6.6. FTP SERVICE SUBMENU

Use this submenu to configure the user name and password of internal FTP site.

FTP Settings

User Name:

Password:

 Save

6.7. MODULE SETTING MENU

Use this menu to check module information, configure WiFi, bluetooth, radio related settings, and turn on/off static voice of buzzer:

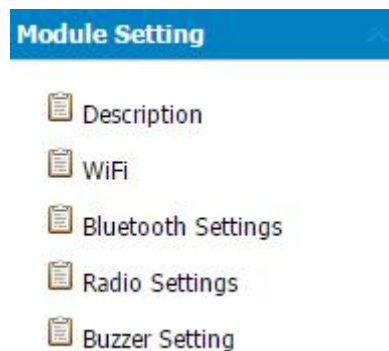

6.7.1. DESCRIPTION SUBMENU

Use this submenu to check the information of WiFi module, bluetooth module and radio module.

Module Abstract	
Wi-Fi Information:	Radio Information:
Power Status: ON	Radio Type: Integrated TR Radio
Wifi Mode: Access Point	Radio Power: 1W
MAC: de:ad:be:01:31:03	OTA Baud Rate: 9600
Access Point Details	Radio Frequency: 462.0500MHz
SSID: GNSS-1013103	Radio Protocol: Transparent
Encryption Type: WAP	Radio Frequency Channel: Full Range
Password: 12345678	Frequency Range: 410MHz--470MHz

6.7.2. WIFI SUBMENU

Use this submenu to turn on/off WiFi function and modify password.

WiFi

Power Status: ON OFF

Auto Start: Yes No
 Internet: Yes No

Wifi Mode: Access Point

SSID: GNSS-1013103
 Encryption Type: WAP
 Password:

[Start](#)

6.7.3. BLUETOOTH SETTINGS SUBMENU

Use this submenu to turn on/off bluetooth function and modify PIN number.

Bluetooth Settings

Local Name: GNSS-1013103
 MAC Address: 84:DD:20:35:14:F2

Visible: Yes No
 PIN: 1234

[Save](#)

6.7.4. RADIO SETTINGS SUBMENU

Use this submenu to turn on/off radio function and configure radio parameters.

Radio Settings

Radio Status: ON ON OFF

Auto Start: Yes No

Radio Protocol: Transparent
 Channel Bandwidth: 25 (MHz)
 OTA Baud Rate: 9600
 Radio Power: 1W
 Radio Frequency: 8 462.0500 (410MHz--470MHz)

[Save](#)

6.7.5. BUZZER SETTING SUBMENU

Use this submenu to turn on/off static voice.

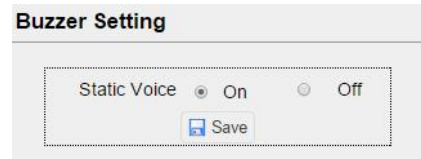

6.8. FIRMWARE MENU

Use this menu to check the current firmware information, download the system log, update the receiver firmware, download or update the configuration file and register the receiver, and more:

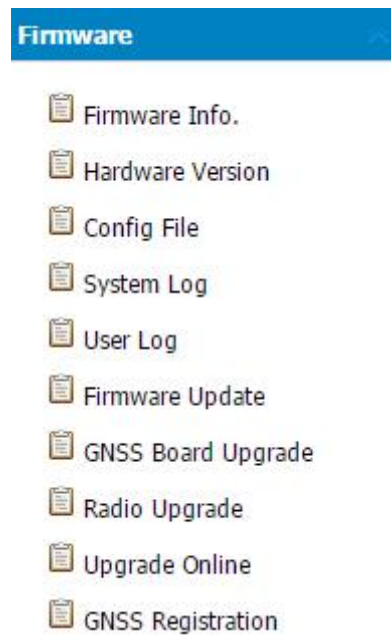

6.8.1. FIRMWARE INFO SUBMENU

Use this submenu to check the current firmware information. The following figure shows an example of the firmware information.



6.8.2. HARDWARE VERSION

Use this submenu to check the hardware information, including main board version and core board version:

Hardware Version	
Main Board:	1.1
Core Board:	1.4
PN:	1180081035142
Board Firmware Version Number:	5.11

6.8.3. CONFIG FILE

Use this submenu to update Configuration File.

Config File	
Download Configuration File :	<input checked="" type="checkbox"/> Download
Update Configuration File:	<input type="button" value="Browse"/>
	<input type="button" value="Confirm"/>

6.8.4. SYSTEM LOG DOWNLOAD SUBMENU

Use this submenu to download the system log of the receiver.

System Log Download	
System Log Type:	Firmware Log <input type="button" value="v"/>
	<input checked="" type="checkbox"/> Download

6.8.5. USER LOG

User Log	
Download User Log:	<input checked="" type="checkbox"/> Download
User Log settings	
<input checked="" type="checkbox"/>	System Starting Time
<input checked="" type="checkbox"/>	External Power Removed
<input checked="" type="checkbox"/>	Satellites Tracking Status Changed
<input checked="" type="checkbox"/>	TCP Client Connection
<input checked="" type="checkbox"/>	TCP Client Disconnect
<input checked="" type="checkbox"/>	Observation Recording Start and End
<input checked="" type="checkbox"/>	FTP file pushed
<input checked="" type="checkbox"/>	Email alert time
<input checked="" type="checkbox"/>	Wi-Fi Status
<input checked="" type="checkbox"/>	Bluetooth status
<input checked="" type="checkbox"/>	Sensor status
<input checked="" type="checkbox"/>	CORS and APIS states
<input checked="" type="checkbox"/>	3g Connection status
	<input type="button" value="Confirm"/>

6.8.6. FIRMWARE UPDATE SUBMENU

Use this submenu to load new firmware to the receiver across the network. Tap the **Browse** button to locate the upgrade file → tap **Confirm** button to confirm the selected upgrading file and start upgrading.

Notes

- *It may take about 3 or 4 minutes to complete the firmware upgrading. Do not touch the power button or unplug the power until the upgrading process is finished, or damage will be caused to the receiver.*
- *The receiver will restart after the firmware upgrading is done, so users need to reconnect the receiver with your computer via Wi-Fi, and then log-in the receiver through a web browser to continue the configuration.*

6.8.7. GNSS BOARD UPGRADE

Use this submenu to upgrade GNSS Board.

6.8.8. RADIO UPGRADE

Use this submenu to browse upgrade file and upgrade radio.

6.8.9. UPGRADE ONLINE

Use this submenu to input Server Address and upgrade online.

6.8.10. GNSS REGISTRATION SUBMENU

Use this submenu to register the receiver. Paste or enter the registration code to the *Registration Code* field → tap **Registration** button to complete the registration.



GNSS Registration

Serial Number:

Registration Limit:

Registration Code:

 Registration

6.9. CLOUD SERVICE SETTING MENU

6.9.1. CLOUD SERVICE SETTING SUBMENU

Cloud Service Setting

 Cloud Service Setting

Use this submenu to turn on or turn off Cloud Service, Auto Start, Remote Control and configure other settings .

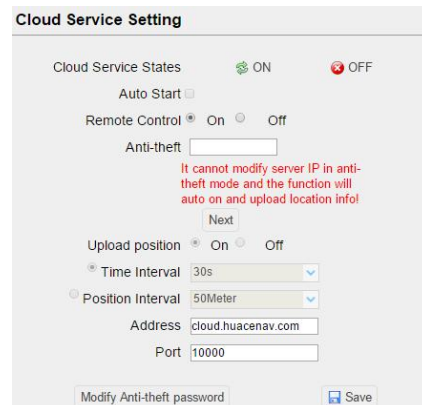

Cloud Service Setting

Cloud Service States ON OFF

Auto Start

Remote Control On Off

Anti-theft

It cannot modify server IP in anti-theft mode and the function will auto on and upload location info!

Next

Upload position On Off

Time Interval

Position Interval

Address

Port

Modify Anti-theft password

A. COMMUNICATION PORTS DEFINITION

A.I. CHC I70 RECEIVER IO PORT (7-PIN LEMO PORT)

DEFINITION



PIN	FUNCTION
1	Ground (-)
2	Ground (-)
3	RS232-TX (Output)
4	PPS
5	Not Used
6	VIN
7	RS232-RX (Input)

CHC - Shanghai Huace Navigation Technology Ltd.

Building C, NO. 599 Gaojing Road,

Qingpu District, 201702 Shanghai, China

Tel: +86 21 542 60 273

Fax: +86 21 649 50 963

Email: sales@chcnav.com | support@chcnav.com

Website: www.chcnav.com

This device complies with Part 15 of the FCC Rules. Operation is subject to the following two conditions: (1) this device may not cause harmful interference, and (2) this device must accept any interference received, including interference that may cause undesired operation.

Changes or modifications not expressly approved by the party responsible for compliance could void the user's authority to operate the equipment.

NOTE: This equipment has been tested and found to comply with the limits for a Class B digital device, pursuant to Part 15 of the FCC Rules. These limits are designed to provide reasonable protection against harmful interference in a residential installation. This equipment generates, uses instructions, may cause harmful interference to radio communications. However, there is no guarantee that interference will not occur in a particular installation. If this equipment does cause harmful interference to radio or television reception, which can be determined by turning the equipment off and on, the user is encouraged to try to correct the interference by one or more of the following measures:

- Reorient or relocate the receiving antenna.
- Increase the separation between the equipment and receiver.
- Connect the equipment into an outlet on a circuit different from that to which the receiver is connected.
- Consult the dealer or an experienced radio/TV technician for help.

The device complies with RF specifications when the device used at 50cm from your body.