

# LT700 SERIES | GETTING STARTED GUIDE

## Handheld GNSS Data Collector

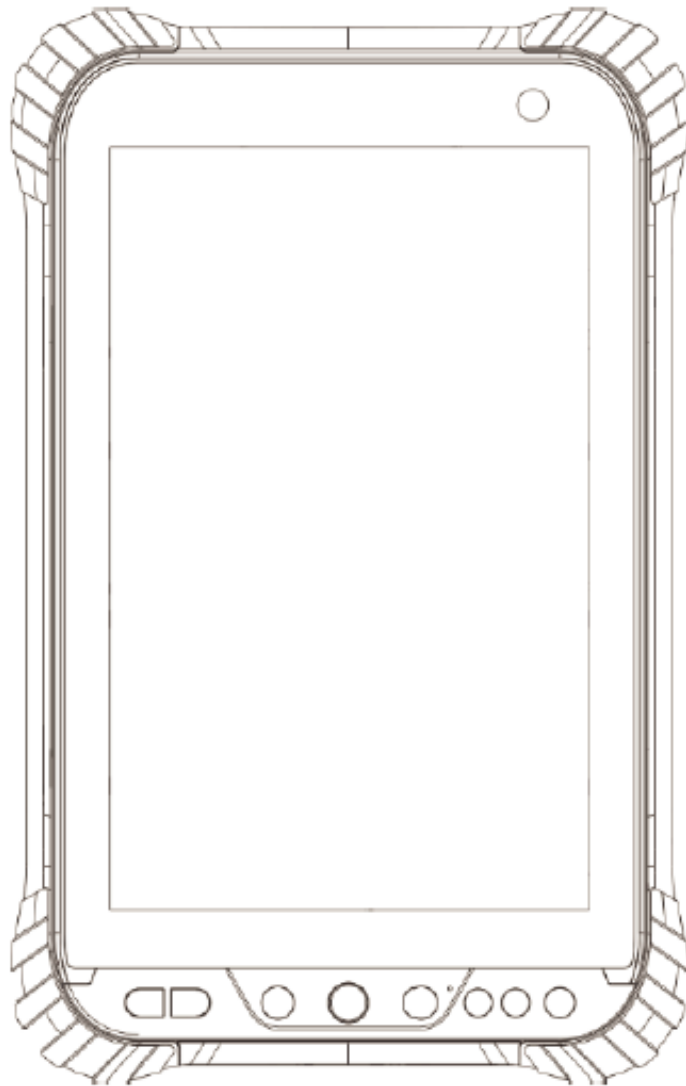

Shanghai Huace Navigation Technology LTD.



# CONTENTS

1.	Introduction.....	2
1.1.	Technical Assistance .....	2
1.2.	Your Comments .....	2
1.3.	Safety Information .....	2
1.4.	Warning and Cautions .....	2
1.5.	Use and Care.....	2
2.	Overview.....	3
2.1.	Features .....	3
2.2.	Specifications.....	3
3.	LT700 Overview .....	5
3.1.	Front View .....	5
3.2.	Back View .....	7
3.3.	Side View .....	8
3.4.	Installation .....	8
4.	Basic Operation .....	9
4.1.	Insert SIM Card and power on.....	9
4.2.	Language & input .....	11
4.3.	Set Date/Time.....	11
4.4.	Display .....	12
4.5.	WIFI .....	13
4.6.	Bluetooth.....	14
4.7.	USB Connection .....	14
4.8.	Use Camera .....	15
4.9.	Log in 4G.....	16
4.10.	Scheduled power on & off.....	16
4.11.	Location .....	18
5.	Getting Started With GnsTool .....	19
5.1.	Connection .....	19
5.2.	CORS Login.....	21
5.3.	Sky Plot .....	21
5.4.	Debugging Data .....	22

# 1. INTRODUCTION

Thank you for choosing CHC LT700 Series GNSS Hand-held Receiver.

This Getting Started Guide will provide useful information about your receiver. It will also guide you through your first steps of using LT700 Series in the field.

## 1.1. TECHNICAL ASSISTANCE

If you have a problem and cannot find the information you need in the product documentation, contact your local dealer from which you purchased the LT700 Series. Alternatively, please request technical support using the CHC Website ([www.chcnav.com](http://www.chcnav.com)) or CHC technical support email ([support@chcnav.com](mailto:support@chcnav.com)).

## 1.2. YOUR COMMENTS

Your feedback about this Getting Started Guide will help us to improve it in future revision. Please e-mail your comments to [support@chcnav.com](mailto:support@chcnav.com).

## 1.3. SAFETY INFORMATION

This manual describes CHC LT700 Series GNSS Data Collecting Terminal. Before using the LT700 Series, please make sure that you have read and understood this Getting Started Guide, as well as the safety requirements.

## 1.4. WARNING AND CAUTIONS

An absence of specific alerts does not mean that there are no safety risks involved.

A Warning or Caution information is intended to minimize the risk of personal injury and/or damage to the equipment.



---

WARNING - A Warning alerts you to a potential misused or wrong setting of the equipment.



CAUTION - A Caution alerts you to a possible risk of serious injury to your person and/or damage to the equipment.

## 1.5. USE AND CARE

The LT700 Series is designed to withstand the rough environment that typically occurs in the field. However, the LT700 Series is high-precision electronic equipment and should be treated with reasonable care.

## 2. OVERVIEW

### 2.1. FEATURES

LT700 is the high-end GNSS tablet which supports Android 7.1 platform. It's a FAD-W high accuracy tablet which can reach 10cm to 2m accuracy as different hardware configuration. Meanwhile, its dust and water proof level is IP67 and can survive 1.2m fall onto concrete. With 8000mAh Li-ion battery, it can continuously work more than 15h. QC 3.0 and fingerprint technology will enormously enhance the speed of charging and the security of data. LT700 can track GPS+GLONASS or GPS+BDS as user wanted.

### 2.2. SPECIFICATIONS

Operating System	Android 7.1
CPU	Eight-core 1.4 GHz
RAM	3GB (4GB optional)
Flash Memory	32GB (64 GB or 128 GB optional)
Memory Extend	Micro SD, up to 128G
GNSS	Support GPS+GLONASS or GPS+BDS
Accuracy	Stand alone: <2.5m; SBAS: 2m
Channel	72
Cold Start	30s
Warm Start	1s
WIFI	802.11 a/b/g/n/ac
Cellular Modem	TDLTE, TDSCDMA, EVDO, GSM, WCDMA
Bluetooth	V4.1
USB	Type C
Li-ion Battery	8000mAh
Voltage	3.8V
Battery Life	>15h(continuous work)
Charging Time	5.5 h
Front Camera	2.0 megapixel
Back Camera	8.0 megapixel
Flash Light	Support

## **Physical specifications**

### **Display**

- Size: 8inch Corning Gorilla Glass touch screen
- Resolution: 1280\*800
- Brightness: 450cd/m<sup>2</sup>
- Touch screen: Capacitance touch, 5 points touch screen
- Point touch pen: Mapping pen with high degree of accuracy

### **Physical**

- Dust proof and waterproof: IP67
- Shock: Survives a 1.2meter drop onto concrete
- Humidity: 5%RH - 95%RH (without condensation)
- Dimension: 235mm\*146mm\* 13mm (L\*W\*H)
- Weight: 560g (with battery)
- Operating temperature:-20°C to + 35°C
- Storage temperature: -30°C to + 70°C

### **Physical Properties**

- NFC: Optional
- G-sensor: Support
- Light sensor: Support
- Distance sensor: Support
- E-compass: Support
- Gyroscope: Support

### 3. LT700 OVERVIEW

#### 3.1. FRONT VIEW

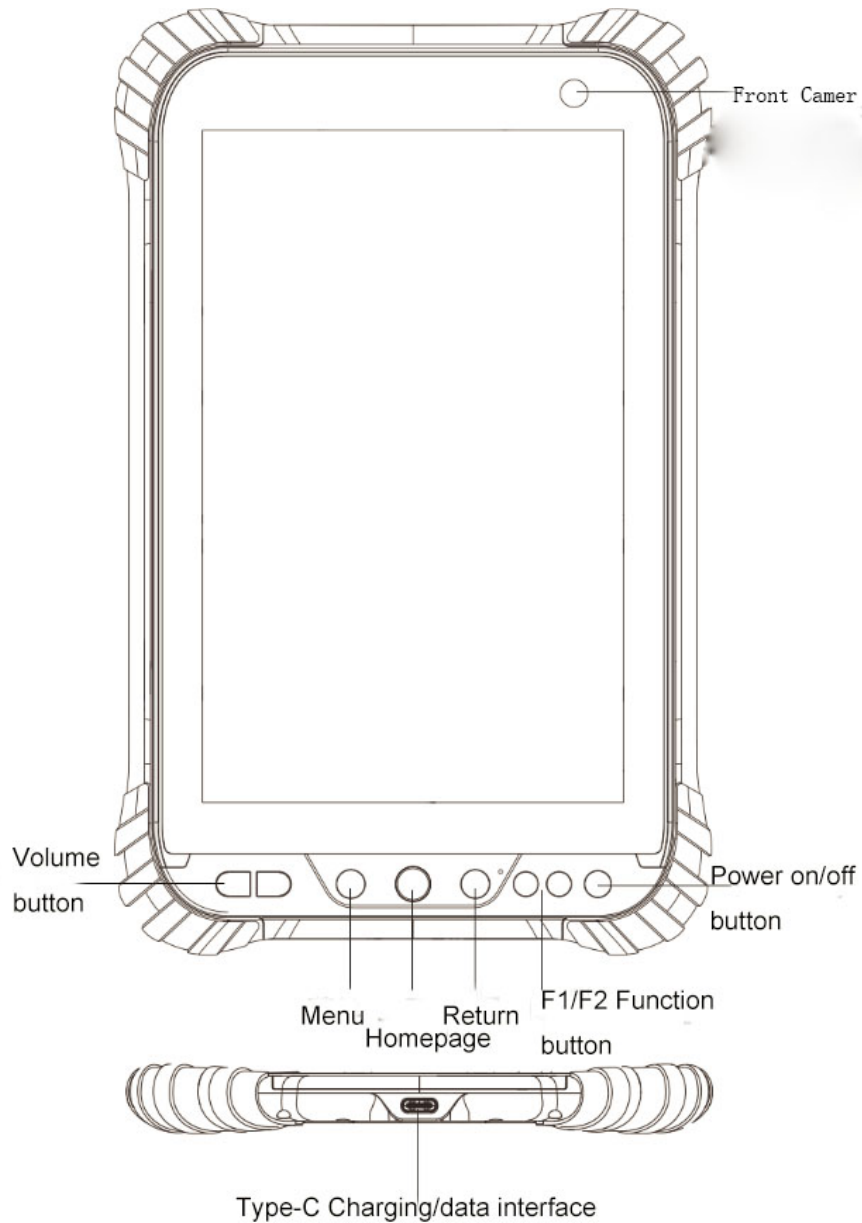

- **Power Button**

- Power ON: Press the button for 1-2 seconds, the Power Indicator will turn on and the boot screen will appear, and then the LT700 will enter the operation system after 30 seconds.
- Power OFF: Press the button for 1-2 seconds, the "SELECT" dialogue box will pop up, select "Power off" to turn off the device.
- Return: Press the button to go back to last menu.

-

- **Menu Button**

Click this button to bring out the start menu.

- **Homepage**

Use the Homepage button to main menu.

- **F1/f2 Function Button**

This key is a shortcut key to the preset function or menu.

- **Type C**

This interface is used for battery charging and data transmission between LT700 and PC using USB cable.

- **Volume button**

This 2 buttons are used for increase/decrease the volume.

### 3.2. BACK VIEW

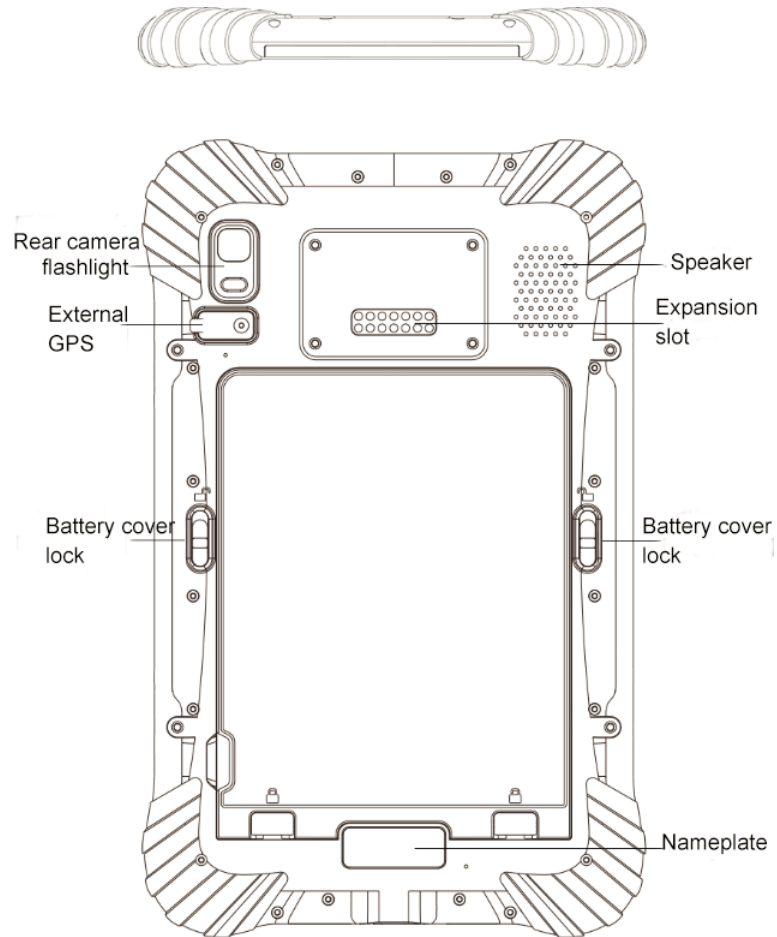



### 3.3. SIDE VIEW

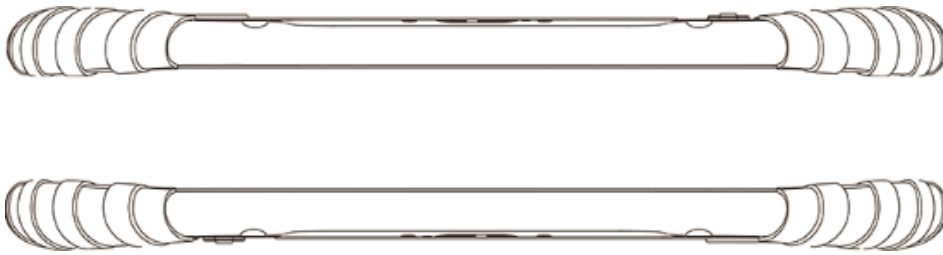

### 3.4. INSTALLATION

Please insert the SIM card and the MicroSD card in the direction of the diagram.

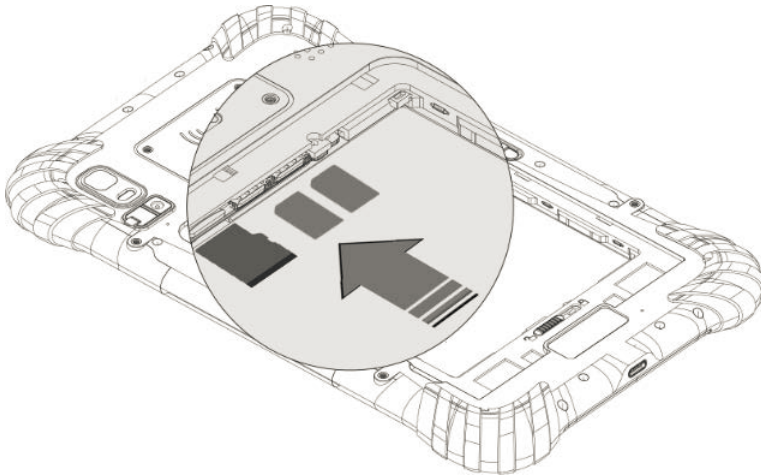



## 4. BASIC OPERATION

### 4.1. INSERT SIM CARD AND POWER ON

- Refer to **3.4 Installation** find the SIM card and TF card slot, and then insert the cards into slots correctly.
- Before powering on LT700, please make sure the battery has plenty of power. Then long press the power button to turn on LT700 and enter its home screen.

Click  to make a phone call.

Click  to access contacts information.

Click  to open message.

Click  to open browser.

Click  to open the drawer to see all the apps that have been installed (**Figure 2**).

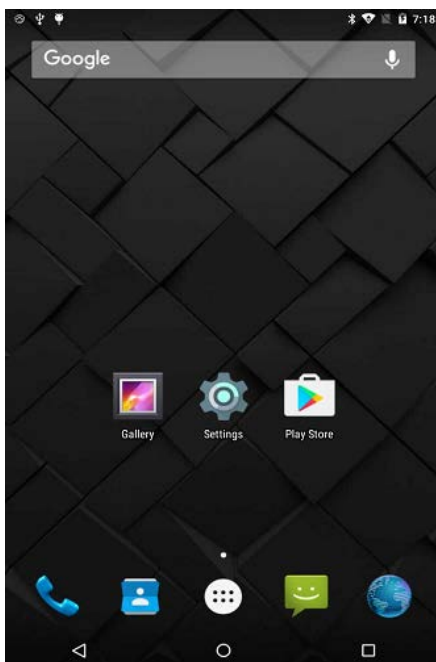

Figure 1

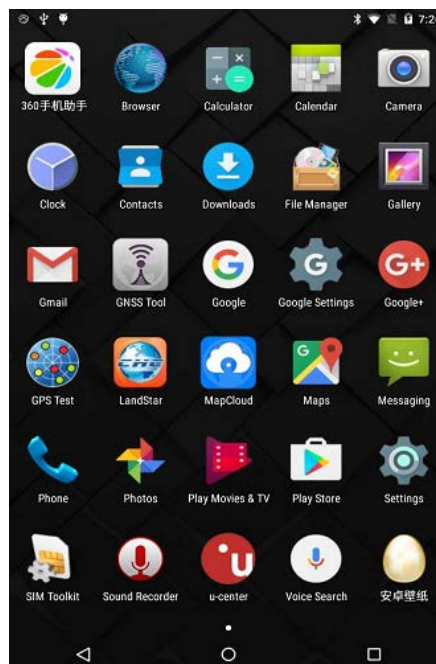

Figure 2

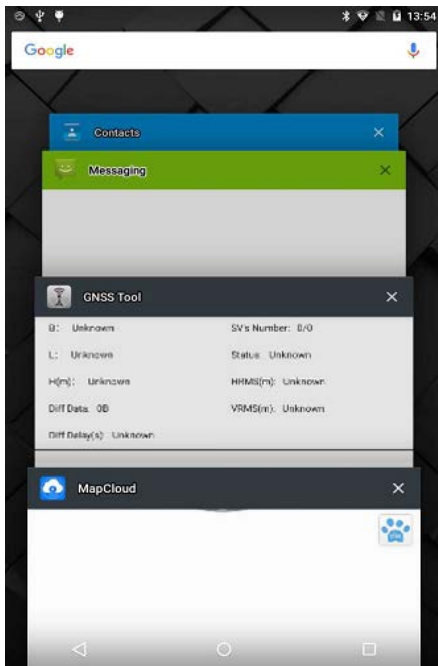

Figure 3

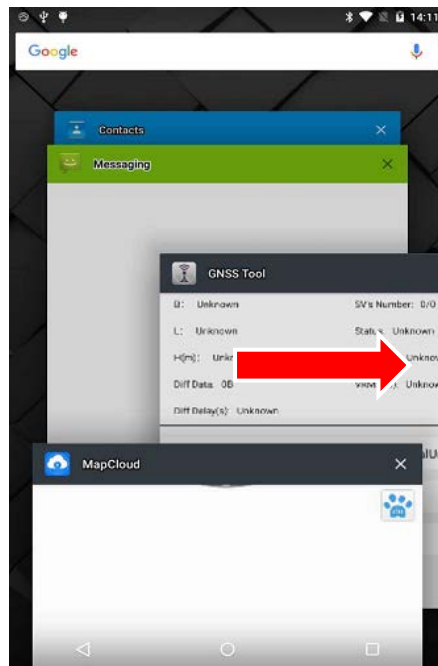





Figure 4

Use virtual button key to facilitate your operation with LT700.

Click  to go back to previous menu.

Click  to return home screen.

Click  to see all the running apps (Fig. 3) and then you can remove apps by sliding them right (Fig. 4).

- After powering on LT700 (refer to 4.2 Power on), Click Settings/SIM card to turn on the SIM cards.

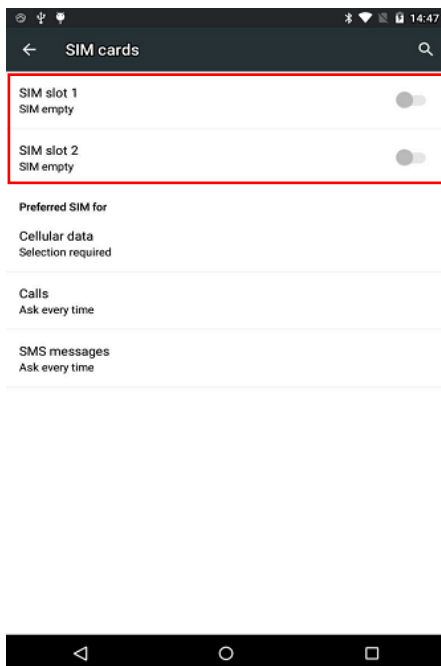

## 4.2. LANGUAGE & INPUT

Click **Settings/Language & input/Language** to select language.

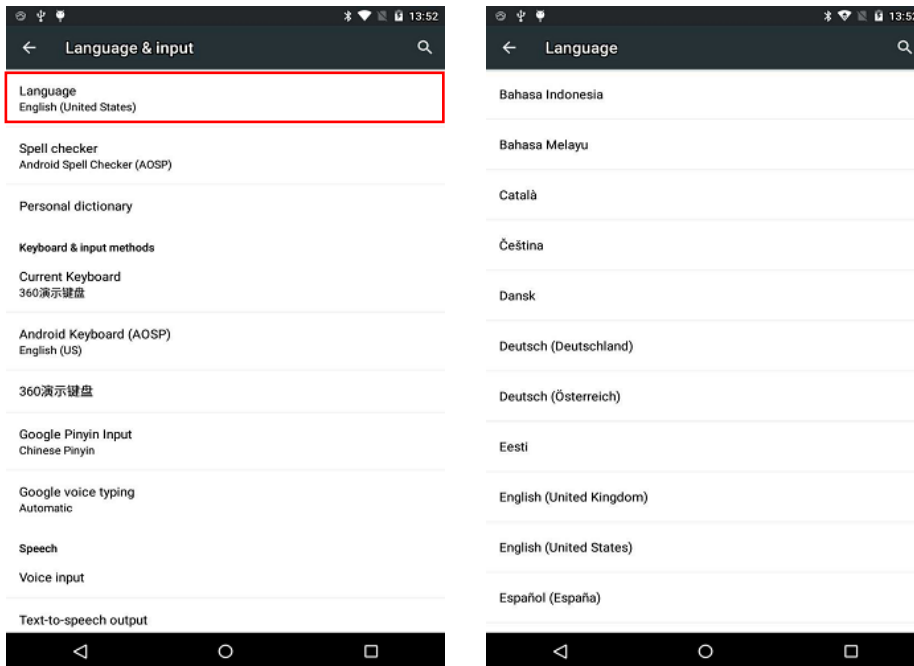

## 4.3. SET DATE/TIME

Click **Settings/Date & time** and enter **Date & time** interface.

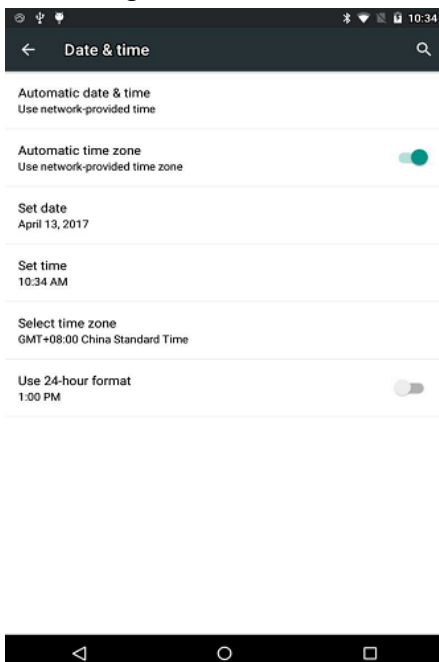

If you want to use date and time from network or GPS, click **Automatic date & time** to select **Use network-provided time** or **Use GPS-provided time**:

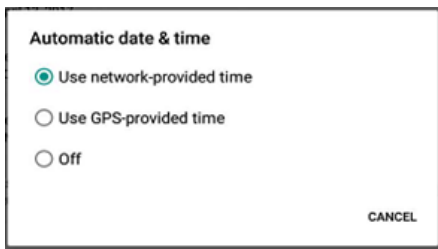

If you want to set date and time by yourself, please turn off the **Automatic date & time** first and then click **Set date** and **Set time** to start your own settings.

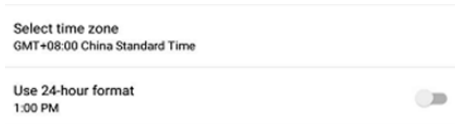

YOU CAN ALSO CUSTOMIZE YOUR TIME ZONE AND CHOOSE WHETHER TO USE 24-HOUR FORMAT IN THIS INTERFACE.

## 4.4. DISPLAY

Click **Settings/Display** to enter **Display** interface.

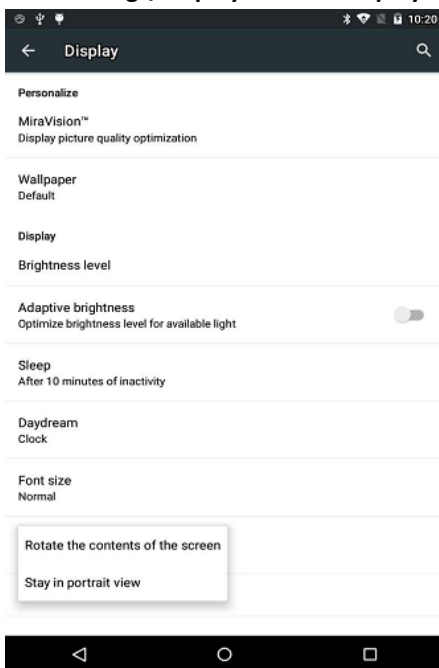

**Brightness adjusting:** Click **Brightness level** to adjust it according to your preference.

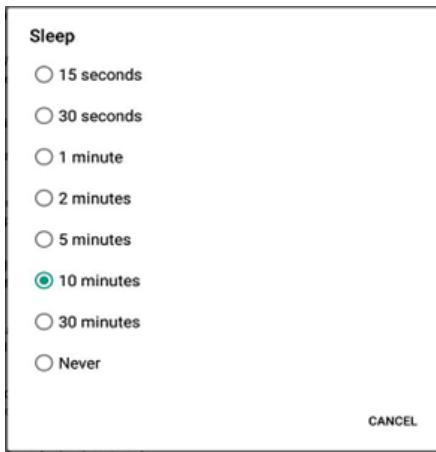

**Sleep:** Click to optimize the inactivity time LT700 needs to close screen.

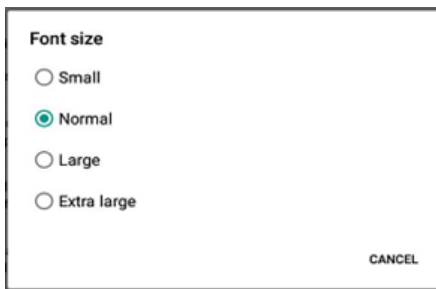

**Font size:** Click to change the font size.

## 4.5. WIFI

Click **Settings/WIFI** to switch on the button.

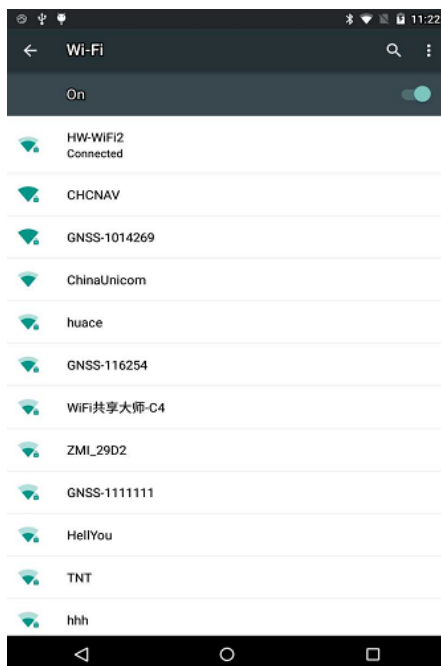

Select WIFI and type in its password to connect.

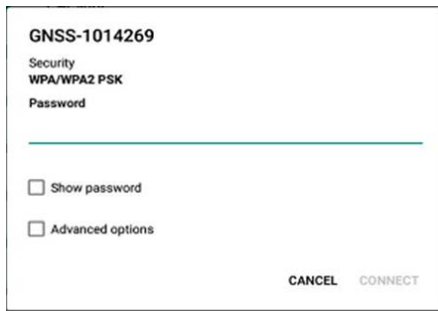

## 4.6. BLUETOOTH

Click Settings/Bluetooth to turn on the Bluetooth.

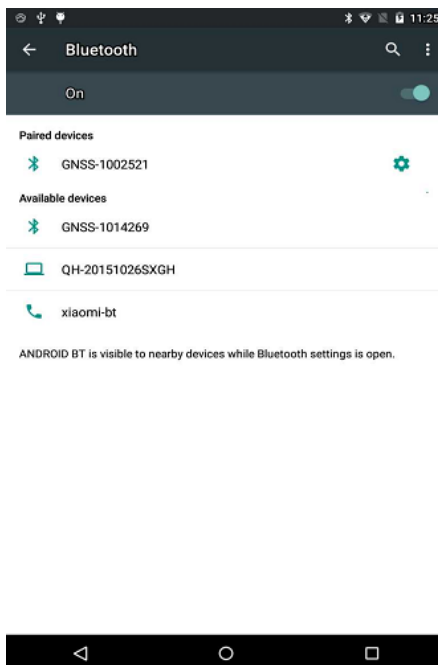

Find nearby devices and pair with it.

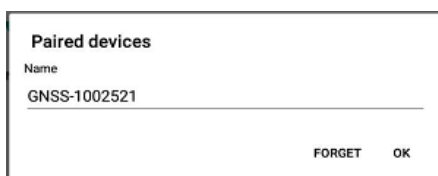

## 4.7. USB CONNECTION

For connection or data transmission between LT700 and office computer, please use the USB data cable as

shown below.

Click **Settings/Developer options/USB debugging** to make sure this function is switched on. After USB data cable is connected with PC, wait until the **Allow USB debugging** dialogue pops up, click OK.

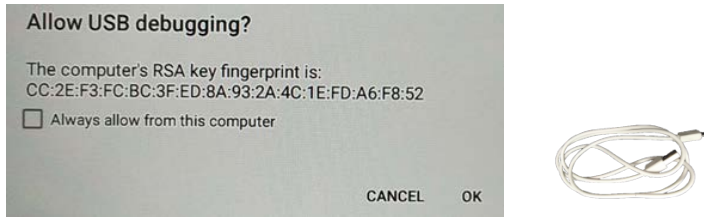



You can also use third party software to manage the documents and data stored in LT700 and install software like GNSS Tool into it.

## 4.8. USE CAMERA

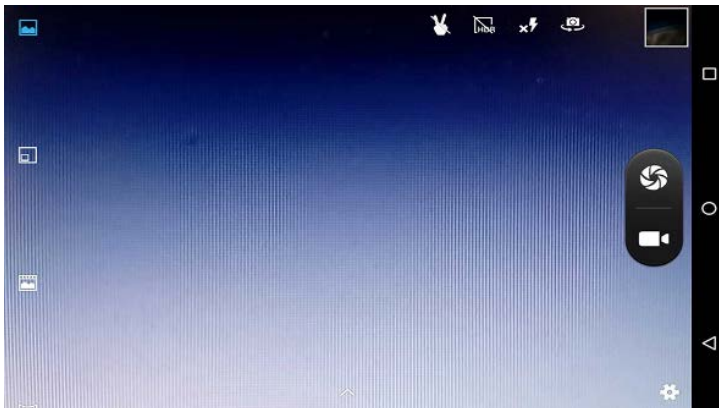
Make sure that the battery is charged and installed in the receiver.





 Click to start recording the video, click again to finish.

 Click to take a photo.

Slide fingers in the left column to switch between 5 different modes:

 Normal mode

 PIP mode

 Live photo mo:

 Panarama mode

 Multi angle view mode





## Camera Settings

Click to configure related parameters.

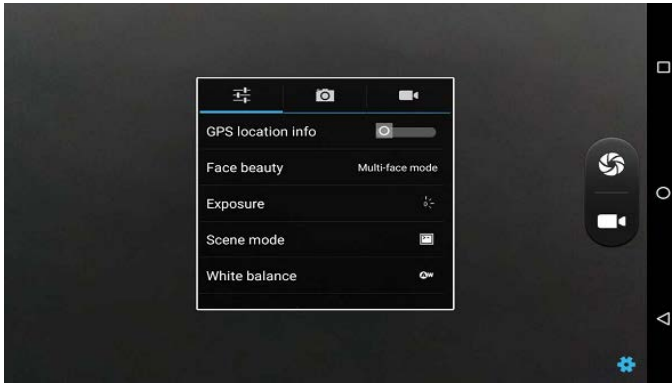

## 4.9. LOG IN 4G

After inserting your SIM card, click **Settings/More/Mobile Networks/Preferred network type** and select corresponding network type of your SIM card. Then Click SIM card icon in the pull down menu and turn on **Mobile data** and click **More Settings** to see data usage.

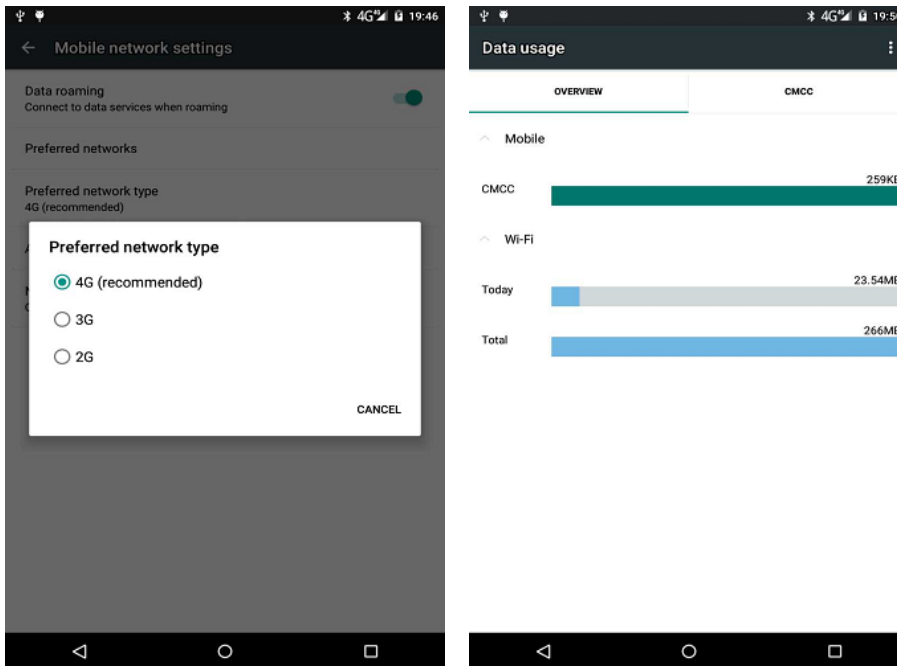

## 4.10. SCHEDULED POWER ON & OFF

LT700 allows users to achieve scheduled power on and off by setting the power up & off time and repeat time beforehand.

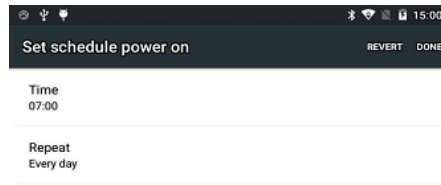
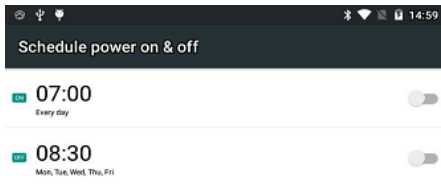

Set the Scheduled power on time and click OK.

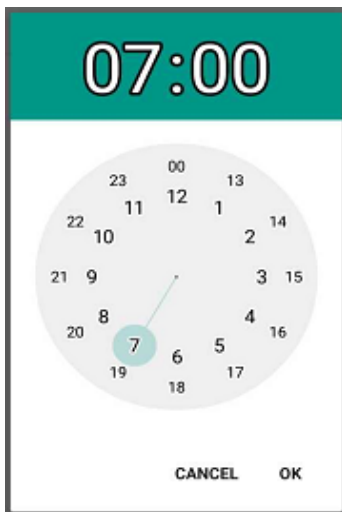

Set scheduled power on repeat time and click OK.

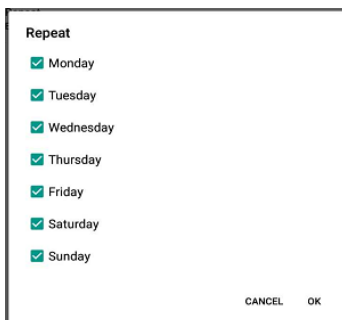

Scheduled power off time settings is the same with Scheduled power on.

## 4.11. LOCATION

Click **Settings/Location** to switch on location service.

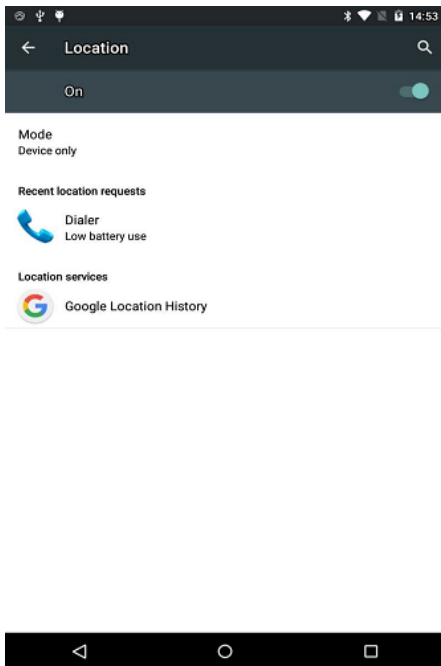

## 5. GETTING STARTED WITH GNSSTOOL

### 5.1. CONNECTION

1. Open GNSSTool and click [Connect] menu and select [Device Type] and [Connection Type] / [Device ID] in connect interface.

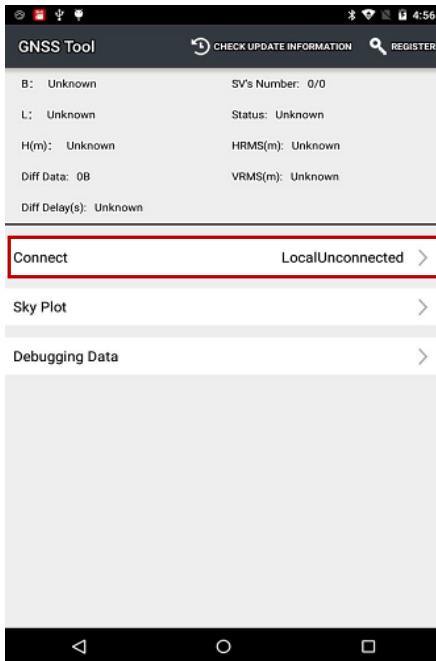

2. **Device Type:** There are 4 types of Device Type: **Smart RTK**, **GNSS RTK**, **Local** and **Peripheral**. Here for LT700, we choose **Local**.

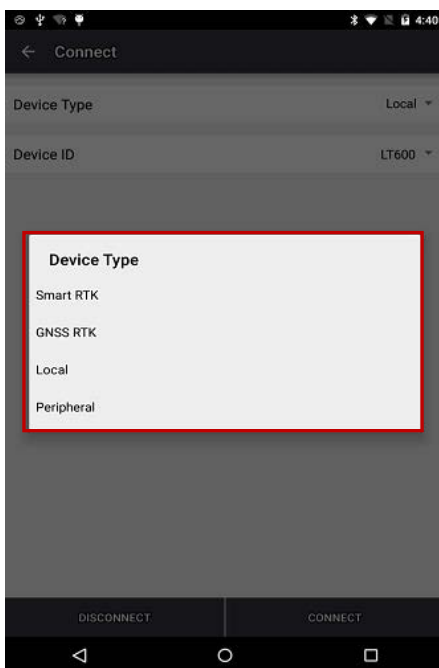

3. **Connection Type:** For smart RTK (like i80), we select **Bluetooth**, **WiFi** or **Demonstration**. For GNSS RTK (like X91), we select **Bluetooth**, and **Demonstration**. For Local and Peripheral, we select the specific device type that we use. Here we select **LT700** for **Connection Type**.

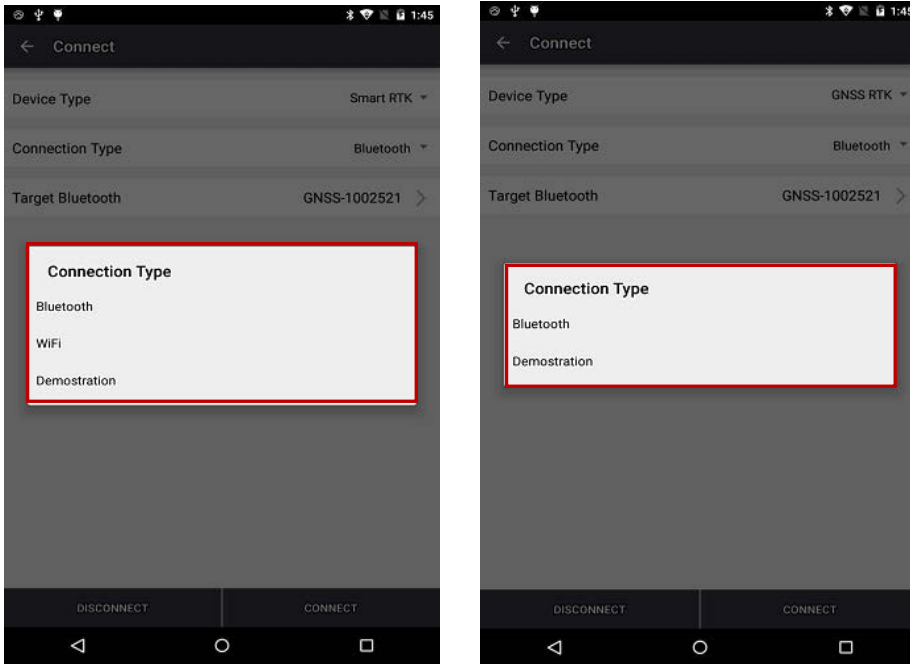

4. Click [Connect] to connect with the receiver successfully and go back to the previous interface.

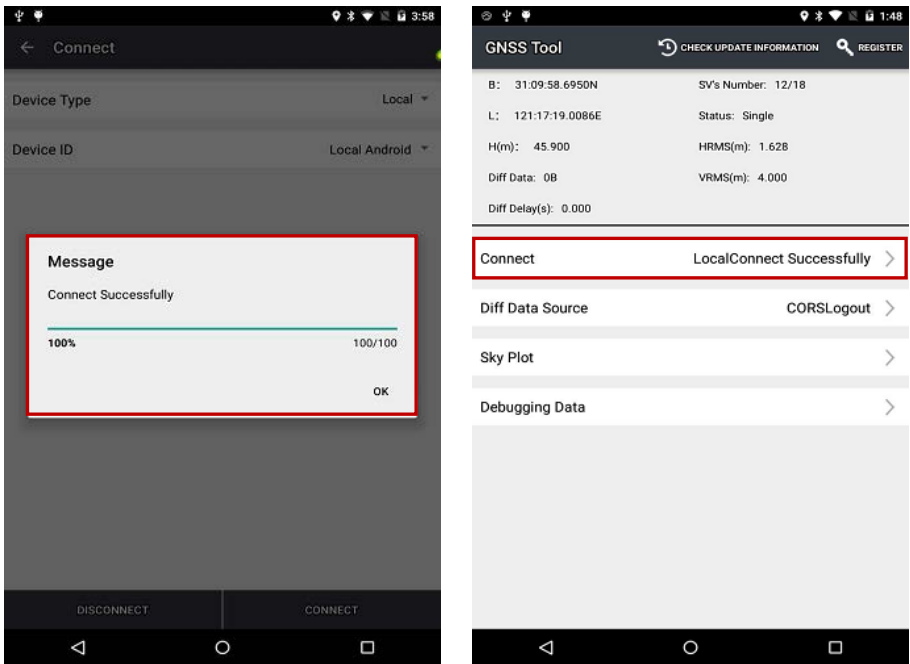

## 5.2. CORS LOGIN

After finishing connection successfully, we can log in CORS to receive differential data.

1. Click **Diff Data Source** in the main interface, type in IP, Port, Source Table and other parameters and then click **LOGIN**.

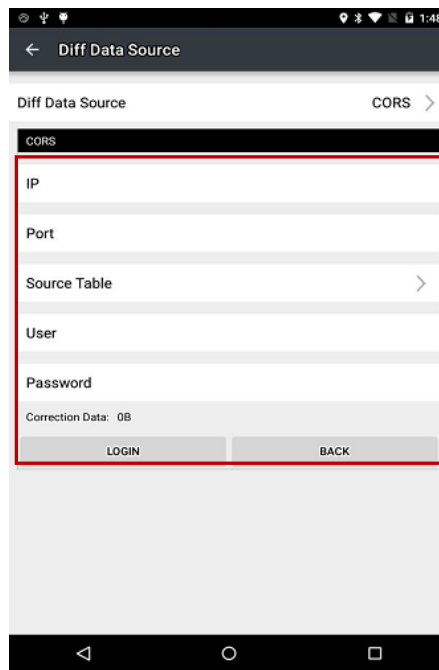
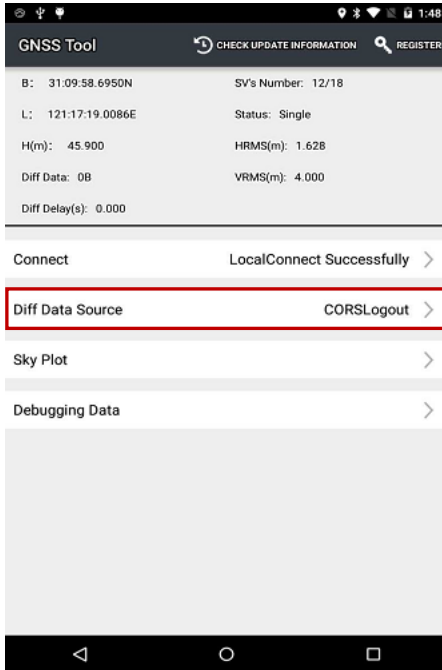

## 5.3. SKY PLOT

Click **Sky Plot** and see how many satellites (including GPS, GLONASS, BDS, GALILEO and SBAS) the device is currently tracking.

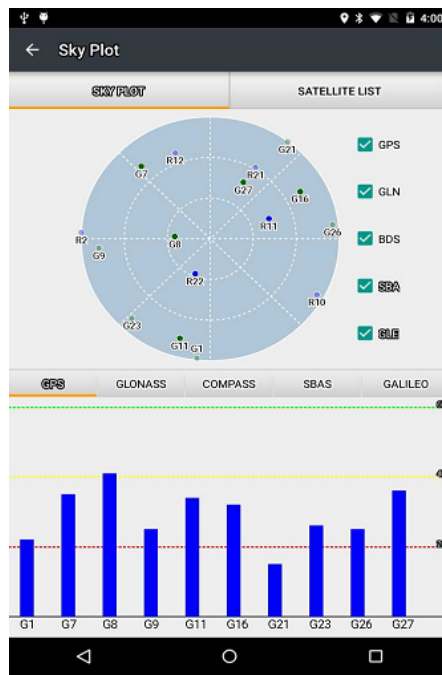
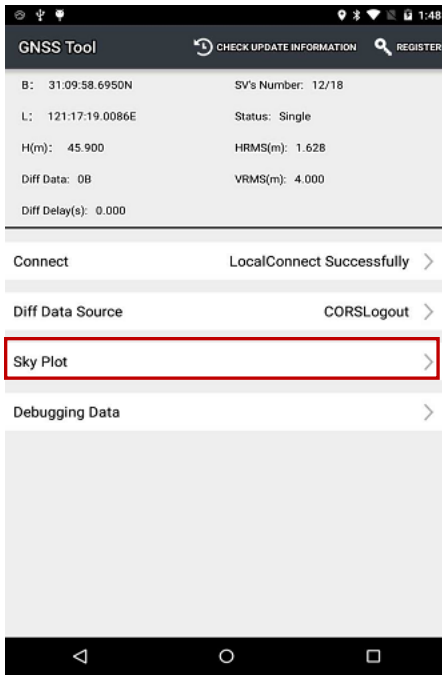

## 5.4. DEBUGGING DATA

Click **Debugging Data** to enter data debugging interface. Click **HEX** to change the data into txt format, you can also pause, save and clear the data using button in the upper side.

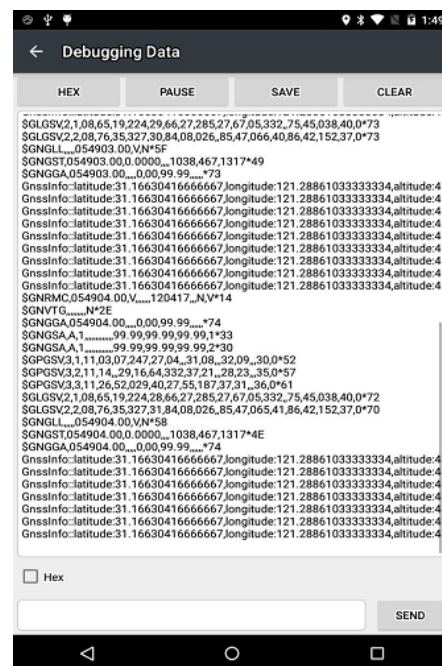
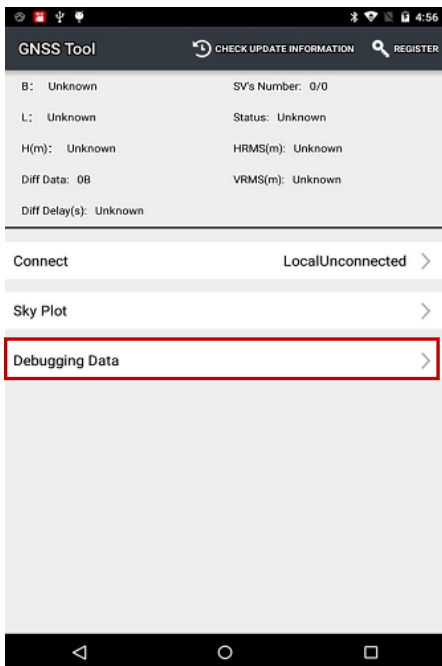

Shanghai Huace Navigation Technology Co., Ltd  
Building C, NO. 599 Gaojing Road,  
Qingpu District, 201702 Shanghai, China  
Tel: +86 21 542 60 273  
Tel: +86 21 649 50 963  
Email: [sales@chcnv.com](mailto:sales@chcnv.com) | [support@chcnv.com](mailto:support@chcnv.com)  
Website: [www.chcnv.com](http://www.chcnv.com)



**FCC ID: SY4-B01012**  
**Shanghai Huace Navigation Technology LTD.**  
Model name: Handheld GNSS Data Collector  
Model No.: LT700

This device complies with Part 15 of the FCC Rules.  
Operation is subject to the following two conditions: (1) this device may not cause harmful interference, and (2) this device must accept any interference received, including interference that may cause undesired operation.

Changes or modifications not expressly approved by the party responsible for compliance could void the user's authority to operate the equipment.

Note: This equipment has been tested and found to comply with the limits for a Class B digital device, pursuant to part 15 of the FCC Rules. These limits are designed to provide reasonable protection against harmful interference in a residential installation. This equipment generates, uses and can radiate radio frequency energy and, if not installed and used in accordance with the instructions, may cause harmful interference to radio communications. However, there is no guarantee that interference will not occur in a particular installation. If this equipment does cause harmful interference to radio or television reception, which can be determined by turning the equipment off and on, the user is encouraged to try to correct the interference by one or more of the following measures:

- Reorient or relocate the receiving antenna.
- Increase the separation between the equipment and receiver.
- Connect the equipment into an outlet on a circuit different from that to which the receiver is connected.
- Consult the dealer or an experienced radio/TV technician for help.

Caution: Any changes or modifications to this device not explicitly approved by manufacturer could void your authority to operate this equipment.

This device complies with part 15 of the FCC Rules. Operation is subject to the following two conditions: (1) This device may not cause harmful interference, and (2) this device must accept any interference received, including interference that may cause undesired operation.

**Specific Absorption Rate (SAR) information:**

This Smart Phone meets the government's requirements for exposure to radio waves. The guidelines are based on standards that were developed by independent scientific organizations through periodic and thorough evaluation of scientific studies. The standards include a substantial safety margin designed to assure the safety of all persons regardless of age or health.

FCC RF Exposure Information and Statement The SAR limit of USA (FCC) is 1.6 W/kg averaged over one gram of tissue. Device types: Smart Phone (FCC ID: SY4-B01012) has also been tested against this SAR limit. The highest SAR value reported under this standard during product certification is 0.903W/kg when properly worn on the body. To maintain compliance with FCC RF exposure requirements, use accessories that maintain a 00cm separation distance between the user's body and the back of the Tablet PC. The use of belt clips, holsters and similar accessories should not contain metallic components in its assembly. The use of accessories that do not satisfy these requirements may not comply with FCC RF exposure requirements, and should be avoided.

The device is restricted to indoor use only when operating in the 5150~5250MHz frequency range.