

HUAWEI P8 lite Quick Start Guide



This document is printed with soy ink.
Huawei is a responsible partner in the
stewardship of our planet and cares about
your well-being.

Model: HUAWEI ALE-L04



31010UFN_01

For more information

Read the Quick Start Guide included with your device.

Go to <http://consumer.huawei.com/en/> to download the user guide for your device (including safety information) and read the FAQ, privacy policy, and other information.

Go to **Settings > About phone > Legal information** to read the legal information.

Please visit <http://consumer.huawei.com/en/support/hotline/> for the most up-to-date contact information for your country or region.

Your phone at a glance

Before you start, let's take a look at your new phone.

Press and hold the power button to turn your phone on or off.

- i** To forcibly restart your phone, press and hold the power button until your phone vibrates.

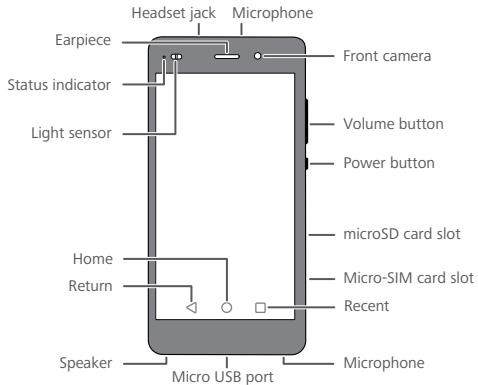

Getting started

Follow the instructions in the following figures to set up your phone. Do not insert or remove a SIM card when your phone is turned on.

- ⊘ Please exercise caution when using the SIM ejector pin to avoid hurting your fingers or damaging your phone. Store your pin in a safe place out of the reach of children to prevent them from swallowing it or injuring themselves by accident.

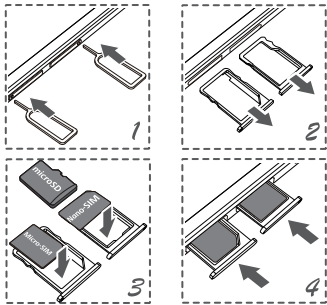

- i** The upper card slot may not support nano-SIM cards. If it does not, you can insert only a microSD card into it.

Locking and unlocking the screen

Press the power button to lock the screen. If your phone is idle for a specified period of time, the screen will automatically lock itself.

If the screen is off, press the power button to turn it on. Slide your finger in any direction to unlock the screen.

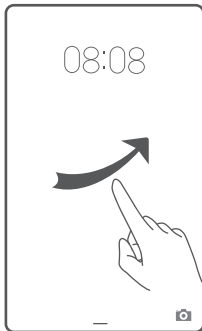

Calling and messaging

Touch  to make a call using the dialer. You can also touch a phone number in your contacts, or a number in a message, email, web page, or other screen to place a call.

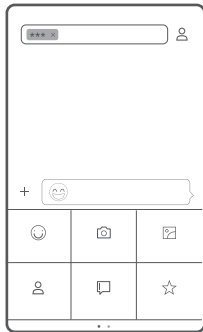
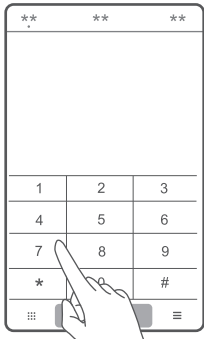

Touch  to send a text or multimedia message. You can save photos, audio clips, videos, and other attachments from received multimedia messages.

Camera

Touch .

Frame the scene you want to capture. Let your camera focus automatically or touch the screen to focus on a specific object. Then touch  to take a photo.

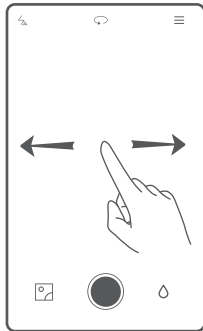

Swipe left or right to switch between different capture modes.

Internet connection

You can access the Internet over Wi-Fi or a mobile data network. Swipe down from the status bar to open the notification panel.

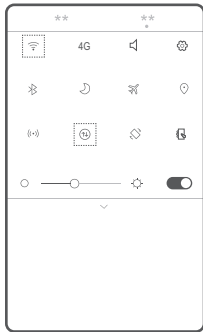
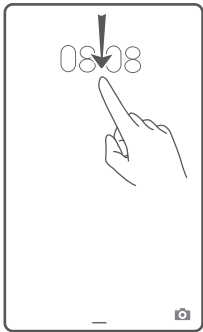

Touch  to turn on mobile data.

Touch and hold  to go to the Wi-Fi settings screen. Turn on Wi-Fi and connect to a Wi-Fi network.

 Turn off mobile data when you don't need it to reduce your mobile data usage.

Phone manager

Touch  .

You can quickly scan your phone for potential risks with one touch. Follow the onscreen instructions to use one-touch optimization, or manually clean the system storage and manage your applications.

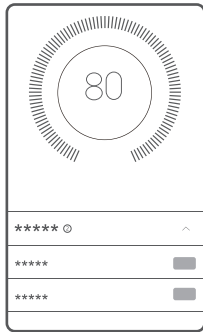
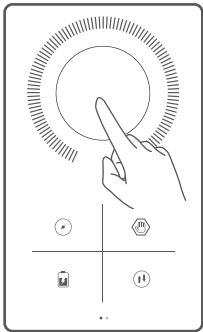

Touch the options on the screen to clear system trash, set the harassment filter, activate power saving mode, manage your applications' notification permissions, and more.

Legal Notice

Copyright © Huawei Technologies Co., Ltd. 2015. All rights reserved.

No part of this manual may be reproduced or transmitted in any form or by any means without prior written consent of Huawei Technologies Co., Ltd. and its affiliates ("Huawei").

The product described in this manual may include copyrighted software of Huawei and possible licensors. Customers shall not in any manner reproduce, distribute, modify, decompile, disassemble, decrypt, extract, reverse engineer, lease, assign, or sublicense the said software, unless such restrictions are prohibited by applicable laws or such actions are approved by respective copyright holders.

Trademarks and Permissions



HUAWEI, , and **HUAWEI** are trademarks or registered trademarks of Huawei Technologies Co., Ltd.

Android™ is a trademark of Google Inc.

LTE is a trade mark of ETSI.

The *Bluetooth*® word mark and logos are registered trademarks owned by *Bluetooth SIG, Inc.* and any use of such marks by Huawei Technologies Co., Ltd. is under license.

Other trademarks, product, service and company names mentioned may be the property of their respective owners.

Notice

Some features of the product and its accessories described herein rely on the software installed, capacities and settings of local

network, and therefore may not be activated or may be limited by local network operators or network service providers.

Thus, the descriptions herein may not exactly match the product or its accessories which you purchase.

Huawei reserves the right to change or modify any information or specifications contained in this manual without prior notice and without any liability.

Third-Party Software Statement

Huawei does not own the intellectual property of the third-party software and applications that are delivered with this product.

Therefore, Huawei will not provide any warranty of any kind for third party software and applications. Neither will Huawei provide support to customers who use third-party software and applications,

nor be responsible or liable for the functions or performance of third-party software and applications.

Third-party software and applications services may be interrupted or terminated at any time, and Huawei does not guarantee the availability of any content or service. Third-party service providers provide content and services through network or transmission tools outside of the control of Huawei. To the greatest extent permitted by applicable law, it is explicitly stated that Huawei shall not compensate or be liable for services provided by third-party service providers, or the interruption or termination of third-party contents or services.

Huawei shall not be responsible for the legality, quality, or any other aspects of any software installed on this product, or for any uploaded or downloaded third-party works in any form, including but not limited to texts, images, videos, or software etc. Customers

shall bear the risk for any and all effects, including incompatibility between the software and this product, which result from installing software or uploading or downloading the third-party works.

This product is based on the open-source Android™ platform.

Huawei has made necessary changes to the platform. Therefore, this product may not support all the functions that are supported by the standard Android platform or may be incompatible with third-party software. Huawei does not provide any warranty or representation in connect with any such compatibility and expressly excludes all liability in connection with such matters.

DISCLAIMER

ALL CONTENTS OF THIS MANUAL ARE PROVIDED "AS IS". EXCEPT AS REQUIRED BY APPLICABLE LAWS, NO WARRANTIES OF ANY KIND, EITHER EXPRESS OR IMPLIED, INCLUDING BUT NOT LIMITED

TO, THE IMPLIED WARRANTIES OF MERCHANTABILITY AND FITNESS FOR A PARTICULAR PURPOSE, ARE MADE IN RELATION TO THE ACCURACY, RELIABILITY OR CONTENTS OF THIS MANUAL.

TO THE MAXIMUM EXTENT PERMITTED BY APPLICABLE LAW, IN NO EVENT SHALL HUAWEI BE LIABLE FOR ANY SPECIAL, INCIDENTAL, INDIRECT, OR CONSEQUENTIAL DAMAGES, OR LOSS OF PROFITS, BUSINESS, REVENUE, DATA, GOODWILL SAVINGS OR ANTICIPATED SAVINGS REGARDLESS OF WHETHER SUCH LOSSES ARE FORSEEABLE OR NOT.

THE MAXIMUM LIABILITY (THIS LIMITATION SHALL NOT APPLY TO LIABILITY FOR PERSONAL INJURY TO THE EXTENT APPLICABLE LAW PROHIBITS SUCH A LIMITATION) OF HUAWEI ARISING FROM THE USE OF THE PRODUCT DESCRIBED IN THIS MANUAL SHALL BE LIMITED TO THE AMOUNT PAID BY CUSTOMERS FOR THE PURCHASE OF THIS PRODUCT.

Import and Export Regulations

Customers shall comply with all applicable export or import laws and regulations and be responsible to obtain all necessary governmental permits and licenses in order to export, re-export or import the product mentioned in this manual including the software and technical data therein.

Privacy Policy

To better understand how we protect your personal information, please see the privacy policy at <http://consumer.huawei.com/privacy-policy>.

Personal Information and Data Security

The use of some functions or third-party applications on your device could result in your personal information and data being lost or becoming accessible to others. Several measures are recommended to help you protect personal and confidential information.

- Place your device in a safe area to prevent it from unauthorized use.
- Set your device screen to lock and create a password or unlock pattern to open it.
- Periodically back up personal information kept on your SIM card, memory card, or stored in your device memory. If you change to a different device, be sure to move or delete any personal information on your old device.

- If you are worried about viruses when you receive messages or emails from a stranger, you can delete them without opening them.
- If you use your device to browse the Internet, avoid websites that might pose a security risk to avoid theft of your personal information.
- If you use services such as Wi-Fi tether or Bluetooth, set passwords for these services to prevent unauthorized access. When these services are not in use, turn them off.
- Install or upgrade device security software and regularly scan for viruses.
- Be sure to obtain third-party applications from a legitimate source. Downloaded third-party applications should be scanned for viruses.
- Install security software or patches released by Huawei or third-party application providers.
- Some applications require and transmit location information. As a result, a third-party may be able to share your location information.
- Your device may provide detection and diagnostic information to third-party application providers. Third party vendors use this information to improve their products and services.

Safety information

This section contains important information about the operation of your device. It also contains information about how to use the device safely. Read this information carefully before using your device.

Electronic device

Do not use your device if using the device is prohibited. Do not use the device if doing so causes danger or interference with other electronic devices.

Interference with medical equipment

- Follow rules and regulations set forth by hospitals and health care facilities. Do not use your device where prohibited.

- Some wireless devices may affect the performance of hearing aids or pacemakers. Consult your service provider for more information.
- Pacemaker manufacturers recommend that a minimum distance of 15 cm be maintained between a device and a pacemaker to prevent potential interference with the pacemaker. If using a pacemaker, hold the device on the side opposite the pacemaker and do not carry the device in your front pocket.

Protecting your hearing when using a headset



- To prevent possible hearing damage, do not listen at high volume levels for long periods.

- Using a headset at high volumes may damage your hearing. To reduce this risk, lower the headset volume to a safe and comfortable level.
- Exposure to high volumes while driving may cause distraction and increase your risk of an accident.

Areas with flammables and explosives

- Do not use the device where flammables or explosives are stored (in a gas station, oil depot, or chemical plant, for example). Using your device in these environments increases the risk of explosion or fire. In addition, follow the instructions indicated in text or symbols.
- Do not store or transport the device in containers with flammable liquids, gases, or explosives.

Traffic security

- Observe local laws and regulations while using the device. To reduce the risk of accidents, do not use your wireless device while driving.
- Concentrate on driving. Your first responsibility is to drive safely.
- Do not hold the device while driving. Use hands-free accessories.
- When you must make or answer a call, pull off the road safely and park the vehicle first.
- RF signals may affect the electronic systems of motor vehicles. For more information, consult the vehicle manufacturer.
- Do not place the device over the air bag or in the air bag deployment area in a motor vehicle. Doing so may hurt you because of the strong force when the air bag inflates.

- Do not use your device while flying in an aircraft or immediately before boarding. Using wireless devices in an aircraft may disrupt wireless networks, present a hazard to aircraft operation, or be illegal.

Operating environment

- Avoid dusty, damp, or dirty environments. Avoid magnetic fields. Using the device in these environments may result in circuit malfunctions.
- Do not use your device during thunderstorms to protect your device against any danger caused by lightning.
- Ideal operating temperatures are 0 °C to 35 °C. Ideal storage temperatures are -20 °C to 70 °C. Extreme heat or cold may damage your device or accessories.

- Do not expose your device to direct sunlight (such as on a car dashboard) for prolonged periods.
- To protect your device or accessories from fire or electrical shock hazards, avoid rain and moisture.
- Keep the device away from sources of heat and fire, such as a heater, microwave oven, stove, water heater, radiator, or candle.
- Do not place sharp metal objects, such as pins, near the earpiece or speaker. The earpiece may attract these objects and result in injury.
- Stop using your device or applications for a while if the device is overheated. If skin is exposed to an overheated device for an extended period, low temperature burn symptoms, such as red spots and darker pigmentation, may occur.

- Do not use your device's camera flash directly in the eyes of people or pets. Otherwise temporary loss of vision or damage to the eyes may occur.
- Do not touch the device's antenna. Otherwise, communication quality may be reduced.
- Do not allow children or pets to bite or suck the device or accessories. Doing so may result in damage or explosion.
- Observe local laws and regulations, and respect the privacy and legal rights of others.

Child's safety

- Comply with all precautions with regard to child's safety. Letting children play with the device or its accessories may be dangerous.

The device includes detachable parts that may present a choking hazard. Keep away from children.

- The device and its accessories are not intended for use by children. Children should only use the device with adult supervision.

Accessories

- Using an unapproved or incompatible power adapter, charger or battery may cause fire, explosion or other hazards.
- Choose only accessories approved for use with this model by the device manufacturer. The use of any other types of accessories may void the warranty, may violate local regulations and laws, and may be dangerous. Please contact your retailer for

information about the availability of approved accessories in your area.

Charger safety

- For pluggable devices, the socket-outlet shall be installed near the devices and shall be easily accessible.
 - Unplug the charger from electrical outlets and the device when not in use.
 - Do not drop or cause an impact to the charger.
 - If the power cable is damaged (for example, the cord is exposed or broken), or the plug loosens, stop using it at once. Continued use may lead to electric shocks, short circuits, or fire.
 - Do not touch the power cord with wet hands or pull the power cord to disconnect the charger.
- Do not touch the device or the charger with wet hands. Doing so may lead to short circuits, malfunctions, or electric shocks.
 - If your charger has been exposed to water, other liquids, or excessive moisture, take it to an authorized service center for inspection.
 - Ensure that the charger meets the requirements of Clause 2.5 in IEC60950-1/EN60950-1/UL60950-1 and has been tested and approved according to national or local standards.
 - Connect the device only to products with the USB-IF logo or with USB-IF compliance program completion.

Battery safety

- Do not connect battery poles with conductors, such as keys, jewelry, or other metal materials. Doing so may short-circuit the battery and cause injuries or burns.
- Keep the battery away from excessive heat and direct sunlight. Do not place it on or in heating devices, such as microwave ovens, stoves, or radiators. Batteries may explode if overheated.
- Do not attempt to modify or remanufacture the battery, insert foreign objects into it, or immerse or expose it to water or other liquids. Doing so may lead to fire, explosion, or other hazards.
- If the battery leaks, ensure that the electrolyte does not make direct contact with your skins or eyes. If the electrolyte touches your skins or splashes into your eyes, immediately flush with clean water and consult a doctor.
- In case of battery deformation, color change, or overheating while charging or storing, immediately stop using the device and remove the battery. Continued use may lead to battery leakage, fire, or explosion.
- Do not put batteries in fire as they may explode. Damaged batteries may also explode.
- Dispose of used batteries in accordance with local regulations. Improper battery use may lead to fire, explosion, or other hazards.
- Do not allow children or pets to bite or suck the battery. Doing so may result in damage or explosion.

- Do not smash or pierce the battery, or expose it to high external pressure. Doing so may lead to a short circuit or overheating.
- Do not drop the device or battery. If the device or battery is dropped, especially on a hard surface, it may be damaged.
- If the device standby time shortens significantly, replace the battery.
- The device has a built-in, non-removable battery. Do not attempt to remove the battery, otherwise the device may be damaged. To replace the battery, take the device to an authorized service center.

Cleaning and maintenance

- Keep the device and accessories dry. Do not attempt to dry it with an external heat source, such as a microwave oven or hair dryer.

- Do not expose your device or accessories to extreme heat or cold. These environments may interfere with proper function and may lead to fire or explosion.
- Avoid collision, which may lead to device malfunctions, overheating, fire, or explosion.
- Before you clean or maintain the device, stop using it, stop all applications, and disconnect all cables connected to it.
- Do not use any chemical detergent, powder, or other chemical agents (such as alcohol and benzene) to clean the device or accessories. These substances may cause damage to parts or present a fire hazard. Use a clean, soft, and dry cloth to clean the device and accessories.

- Do not place magnetic stripe cards, such as credit cards and phone cards, near the device for extended periods of time. Otherwise the magnetic stripe cards may be damaged.
- Do not dismantle or remanufacture the device and its accessories. This voids the warranty and releases the manufacturer from liability for damage. In case of damage, contact an authorized service center for assistance or repair.
- If the device screen is broken in a collision, immediately stop using the device. Do not touch or attempt to remove the broken parts. Promptly contact an authorized service center.

Emergency calls

The availability of emergency calls is subject to your cellular network quality, service provider policy, and local laws and regulations. Never

rely solely on your device for critical communications like medical emergencies.

Environmental protection

- The device and its accessories (if included), such as the power adapter, headset, and battery should not be disposed of with household garbage.
- Disposal of the device and its accessories is subject to local regulations. Support proper collection and recycling.

FCC Regulatory Compliance

Body worn operation

The device complies with RF specifications when used near your ear or at a distance of 1.0 cm from your body. Ensure that the device accessories, such as a device case and device holster, are not

composed of metal components. Keep the device away from your body to meet the distance requirement.

Certification information (SAR)

This device is also designed to meet the requirements for exposure to radio waves established by the Federal Communications Commission (USA).

The SAR limit adopted by the USA is 1.6 W/kg averaged over one gram of tissue. The highest SAR value reported to the FCC for this device type complies with this limit.

The highest SAR value reported to the FCC for this device type when using at the ear is 1.178 W/kg, and when properly worn on the body is 1.017 W/kg, and when using the Wi-Fi hotspot function is 1.120 W/Kg.

FCC statement

This equipment has been tested and found to comply with the limits for a Class B digital device, pursuant to Part 15 of the FCC Rules. These limits are designed to provide reasonable protection against harmful interference in a residential installation. This equipment generates, uses and can radiate radio frequency energy and, if not installed and used in accordance with the instructions, may cause harmful interference to radio communications. However, there is no guarantee that interference will not occur in a particular installation. If this equipment does cause harmful interference to radio or television reception, which can be determined by turning the equipment off and on, the user is encouraged to try to correct the interference by one or more of the following measures:

- Reorient or relocate the receiving antenna.

- Increase the separation between the equipment and receiver.
- Connect the equipment into an outlet on a circuit different from that to which the receiver is connected.
- Consult the dealer or an experienced radio/TV technician for help.

This device complies with Part 15 of the FCC Rules. Operation is subject to the following two conditions: (1) this device may not cause harmful interference, and (2) this device must accept any interference received, including interference that may cause undesired operation.

Caution: Any changes or modifications to this device not expressly approved by Huawei Technologies Co., Ltd. for compliance could void the user's authority to operate the equipment.

 All pictures and illustrations in this guide, including but not limited to the phone color, size, and display content, are for your reference only. The actual product may vary. Nothing in this guide constitutes a warranty of any kind, express or implied.