

AP6010DN-AGN Wireless LAN Access Point Quick Start Guide

Copyright © Huawei Technologies Co., Ltd. 2012. All rights reserved.

No part of this document may be reproduced or transmitted in any form or by any means without prior written consent of Huawei Technologies Co., Ltd.

Trademarks and Permissions



and other Huawei trademarks are trademarks of Huawei Technologies Co., Ltd.

All other trademarks and trade names mentioned in this document are the property of their respective holders.

Notice

The purchased products, services and features are stipulated by the contract made between Huawei and the customer. All or part of the products, services and features described in this document may not be within the purchase scope or the usage scope. Unless otherwise specified in the contract, all statements, information, and recommendations in this document are provided "AS IS" without warranties, guarantees or representations of any kind, either express or implied.

The information in this document is subject to change without notice. Every effort has been made in the preparation of this document to ensure accuracy of the contents, but all statements, information, and recommendations in this document do not constitute the warranty of any kind, express or implied.

Huawei Technologies Co., Ltd.

Address: Administration Building, Huawei Technologies Co.,
Ltd., Bantian, Longgang District, Shenzhen, People's Republic of China



Postcode: 518129

Website: <http://www.huawei.com>

Email: support@huawei.com

Symbol Conventions

The symbols that may be found in this document are defined as follows.

Symbol	Description
 CAUTION	Indicates a potentially hazardous situation, which if not avoided, could result in equipment damage, data loss, performance degradation, or unexpected results.
 NOTE	Provides additional information to emphasize or supplement important points of the main text.

Change History

Changes between document issues are cumulative. Therefore, the latest document issue contains all the changes in previous issues.

Change in Issue 01 (2012-05-30)

Initial commercial release.

AP6010DN-AGN Quick Start Guide



Please download the detailed product documents from "http://support.huawei.com/support".
The detailed path is as follows: Technical Support->Documentation->Access Network -> WLAN -> WLAN -> Product Documentation ->AP6010DN.

Before performing Installation, confirm that the installation accessories and tools are available.

Installation accessories:



Sheetmetal wall-mounting bracket



Expansion bolt

Installation tools:

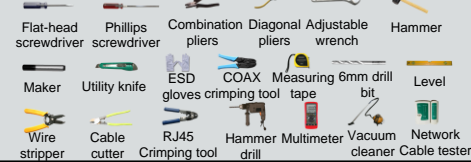

Technical Support

Huawei Technologies Co., Ltd.
Address: Administration Building, Huawei Technologies Co., Ltd., Bantian, Longgang District, Shenzhen, People's Republic of China
Postcode: 518129
Email: support@huawei.com
Website: http://www.huawei.com

Packing List

Unpack the equipment. Ensure that all items listed in the package list are included in the shipment. If any item is missing, contact the supplier.

	Item	Quantity	Unit
1	AP device	1	PCS
2	Power adapter (Optional)	1	PCS
3	Sheetmetal wall-mounting bracket	1	PCS
4	Expansion bolt	3	PCS
5	Quick Start Guide (including the printed packing list)	1	PCS
6	Toxic or Hazardous Substance & Elements Declaration	1	PCS

	Item	Quantity	Unit
7	Warranty card	1	PCS
8	Certificate of Conformance	1	PCS

Device Overview

Indicators

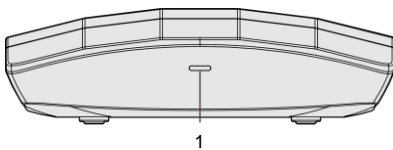

1

Front view

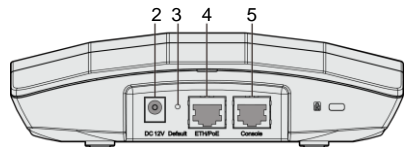

Indicator and Interfaces

No.	Name	Description
1	Indicator	For details about indicator, see the Power-on.
2	DC 12V	Connected to the power adapter.
3	Default	Press and hold down the Reset button for 3 seconds to restore the factory settings and restart the AP.
4	ETH/PoE	Connected to a PoE power supply or switch, or connected to the Ethernet.
5	Console	Connected to the maintenance terminal.

Perspective

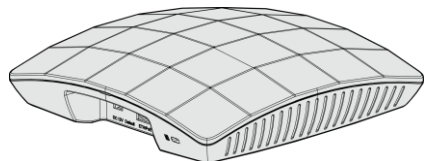

Installing the AP

Select an appropriate installation position and leave 20 cm space above and around the device for cooling air circulation.

AP6010DN dimensions (unit: mm) without a backplane support Recommended AP6010DN installation space (unit: mm)

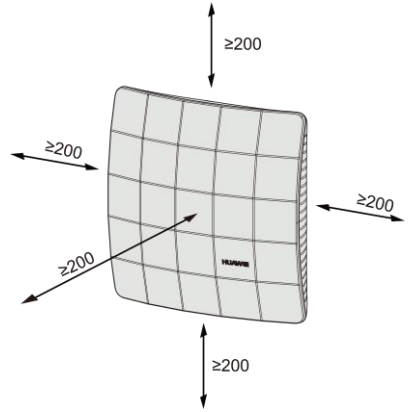
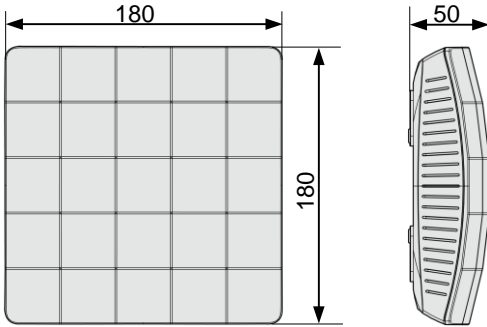

The AP6010DN can be installed onto a workbench or mounted against a wall. In addition, the AP6010DN can be mounted to a T-rail and mounted against the ceiling.

Wall-mount the AP6010DN using the plastic wall-mounting bracket:

1. Fix the wall-mounting bracket to the wall, adjust the installation position, and use the marker to mark the drilling positions where expansion bolts are installed.

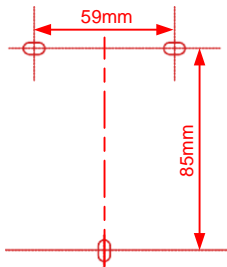

2. Use #6 drill bit to drill 25-30 mm deep holes in the drilling positions. Hammer the expansion tubes into the holes until the expansion tubes are embedded into the wall.

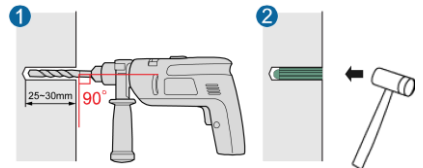

3. Fix the wall-mounting bracket to the wall, use the Phillips screwdriver to fasten three self-tapping screws into the expansion tube.

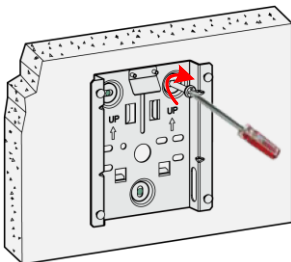

4. Align the holes at the rear side of the AP with the hooks on the bracket and hang the AP on the bracket. Hold the AP with one hand and press the AP downwards with another hand to secure the AP on the wall.

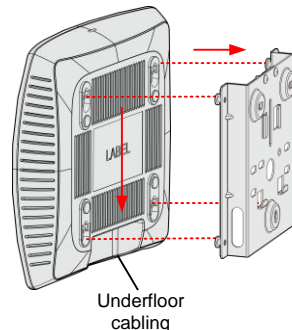

Installing the AP

Ceiling-mount the AP6010DN using the sheetmetal wall-mounting bracket:

1. Remove the ceiling, determine locations of mounting holes based on the distance between two installation holes, use the hammer drill to drill holes, and fix the wall-mounting bracket to the ceiling.

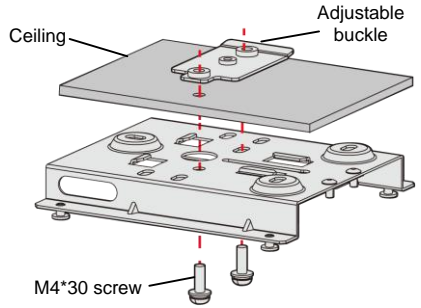
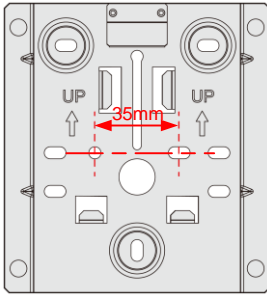

2. Align the cucurbit holes at the rear side of the AP with four screws on the wall-mounting bracket and secure the AP.

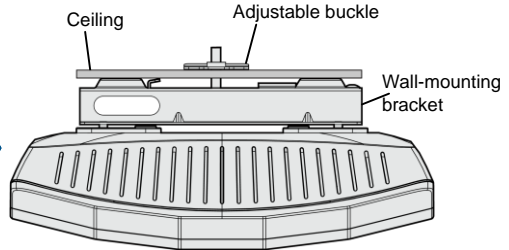
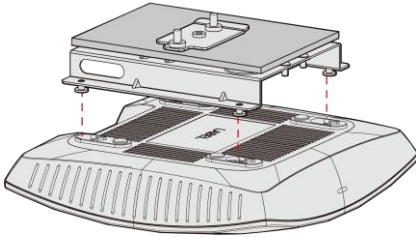

Mounting the AP6010DN to the T-rail using the sheetmetal wall-mounting bracket:

1. Use screws to fix the adjustable buckle to the wall-mounting bracket, hook the adjustable buckle to the T-rail, and secure the screw on the adjustable buckle to fasten the wall-mounting bracket and T-rail.

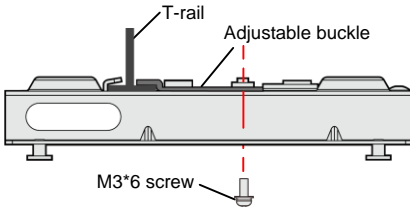

2. Align the cucurbit holes at the rear side of the AP with four screws on the wall-mounting bracket and secure the AP.

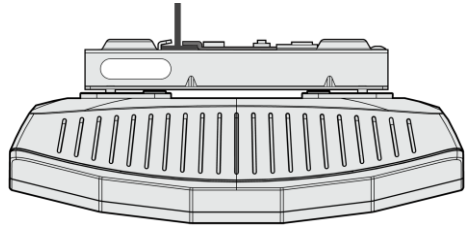

CAUTION

Ensure that the AP is correctly installed on the wall-mounting bracket and there must be 20 cm space above and around the AP for cooling air circulation.



NOTE

To prevent unauthorized personnel from moving the AP, lock the AP using the security lock and determine the position for installing the security lock. When the sheetmetal wall-mounting bracket is used, fasten the security lock to the wall-mounting bracket or other immovable object. The following figure shows the security lock. The carrier should purchase the security lock.

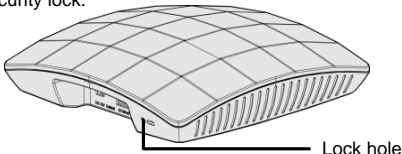

Lock hole

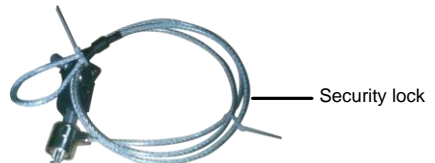

Security lock

Connecting Cables

Connect the network cable to the AP

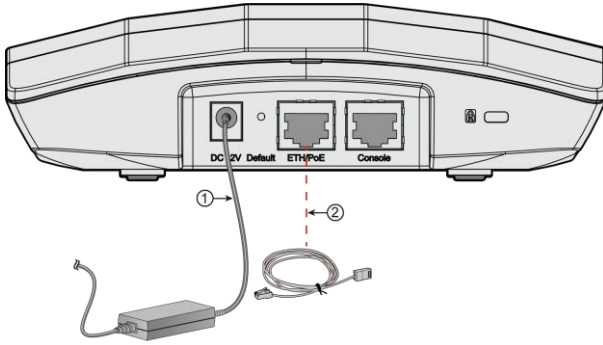

No.	Item	Description
1	Power adapter 12 V DC	<ul style="list-style-type: none"> The AP6010DN supports PoE power supply and DC power supply. When both the PoE power supply and DC power supply are available, the DC power supply is used. When DC power supply is used, use the specified power adapter; otherwise, the device may be damaged.
2	Network cable	If the AP needs to connect to the Ethernet, ensure that the Ethernet cable is working properly. If the Ethernet cable is not working properly, for example, RJ45 connectors are short-circuited, the AP may fail to be powered on or fail to work. Before connecting an Ethernet cable to the AP, use the cable test tool to check whether the cable is qualified. If the cable is unqualified, replace it.

Requirements for making a network cable:

- Cut the cable of proper length based on the distance between the AP and the PSE device, peel the insulation on both ends of the network cable, and crimp the wires to RJ45 connectors.
- Connect RJ45 connectors to the network cable tester to test cable connectivity. The following shows the pin assignment.

X1 Pin	Wire Color	X2 Pin
1	White and orange	1
2	Orange	2
3	White and green	3
4	Blue	4
5	White and blue	5
6	Green	6
7	White and brown	7
8	Brown	8

CAUTION

- The service network cable cannot be connected to the console port. Otherwise, the AP6010DN may be damaged when using PoE power supply.
- Before connecting the cable to the AP, coil the cable around the wall-mounting bracket first. This prevents the cable from being bent.

Power-on

NOTE

Power on the AP6010DN and check the indicator status to determine the System running status.

Type	Color	Frequency	Description
Default status	Green	Steady on	UBOOT: The AP is just powered on.
Running	Green	0.5 Hz	The system is running properly, the Ethernet connection is correct, and STAs are associated with the AP.
		0.2 Hz	The system is running properly, the Ethernet connection is correct, no user is connected, and the system is in low power consumption state.
Alarm	Green	4 Hz	<ol style="list-style-type: none">1. The AP is being upgraded.2. The CAPWAP tunnel is disconnected.3. The AP is running properly, but does not go online.
Error	Red	Steady on	A fault that affects services occurs and cannot be rectified automatically. For example, the system fails to load the DRAM or system software. The fault needs to be rectified manually.

Technical Specifications

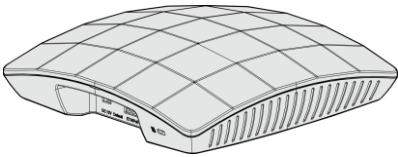

Item	Description
Weight	400g
Dimensions (H x W x D)	50mm×180mm×180mm
12 V DC (Power adapter)	Output: DC 12V ±10%
	Input: 100V ~240V AC
PoE power	-48V
Operating temperature	-10°C to +50°C
Relative humidity	10% to 95%
Pressure	70kPa to 106kPa
Altitude	-60 m to 4000 m

Logging In to the Router

After an AP is powered on, you can log in to the AP using the following methods.

1. Logging In to the AP Through the Console Port

This section describes how to log in to the AP through the console port. After logging in to the AP, you can configure the AP using commands.

2. Logging In to the AP Using Telnet

This section describes how to log in to the AP using Telnet. After logging in to the AP, you can configure the AP using commands.

1. Logging In to the AP Through the Console Port

This section describes how to log in to the AP through the console port. After logging in to the AP, you can configure the AP using commands.

Procedure

Step 1 Connect a PC to the AP with a console cable. Connect the RJ45 connector to the console port of the AP and connect the DB9 connector to the serial port of the PC. Figure 1-1 shows the location of the AP's console port.

Figure 1-1 Location of the AP's console port

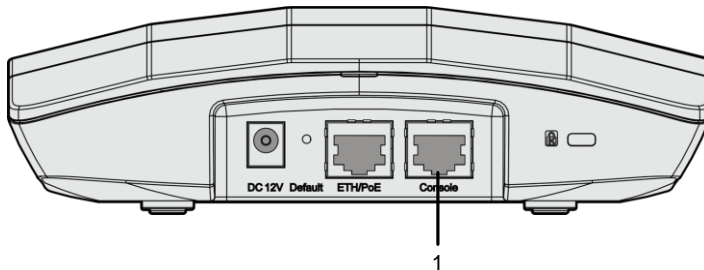

No	Port
1	Console port

Step 2 Run the terminal emulation program on the PC. For example, to open the HyperTerminal of Windows XP on the PC, choose Start > Programs > Accessories > Communications > HyperTerminal. Enter the name of the new connection in the Name text box and click OK, as shown in Figure 1-2.

Figure 1-2 Setting up a connection



Logging In to the Router

Step 3 Select the serial port used on the PC and click OK, as shown in Figure 1-3.

Figure 1-3 Selecting the connected port



Step 4 Click Restore Defaults, select 9600 bit/s from the Bits per second drop-down list box, and click OK, as shown in Figure 1-4.

Figure 1-4 Setting communication parameters

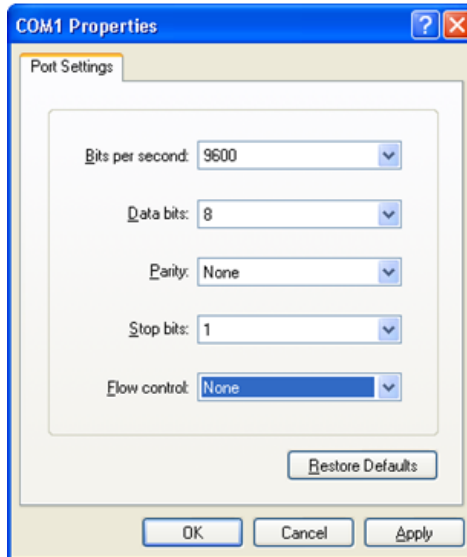

Step 5 Press Enter on the subsequent dialog boxes until the command line prompt of the user view, such as <Enterprise AP>, is displayed.

You can run commands to configure the AP. Enter a question mark (?) whenever you need help.

---End

Logging In to the Router

2. Logging In to the AP Using Telnet

This section describes how to log in to the AP using Telnet. After logging in to the AP, you can configure the AP using Commands.

Procedure

Step 1 Connect a PC to the uplink port of the AP with a network cable. Figure 1-5 shows the location of the AP's uplink port.

Figure 1-1 Location of the AP's uplink port

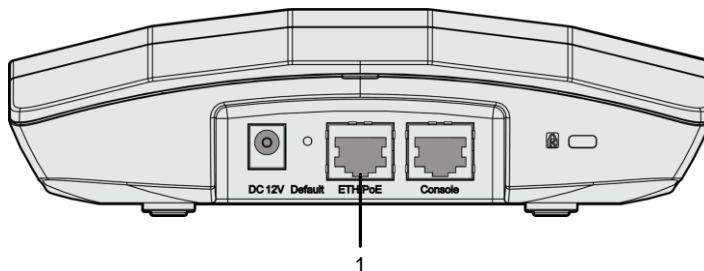

No	Port
1	ETH/PoE

- Step 2 Configure a static IP address for the PC. The IP address must be on the network segment 192.168.0.1/24 (The IP address should not be same as the AP's default IP address 192.168.0.1.) and the subnet mask is 255.255.255.0.
After the configuration is complete, run the ping 192.168.0.1 command on the PC to check whether the PC can be pinged. If the ping operation succeeds, the connection is set up successfully. If the ping operation fails, The connection fails to be set up. Check whether the network cable works properly.
- Step 3 Access the command line window on the PC. For example, if the PC runs Windows XP, choose Start > Run And enter cmd in the displayed dialog box.
- Step 4 Run the telnet 192.168.0.1 command to log in to the AP.
- Step 5 Enter the default user name and password admin. If the user view is displayed, you have logged in Successfully.

When you log in for the first time, the following page is displayed:

Username: super
Password:

Enterprise AP:
----End

AP Local Configuration

WLAN services parameters of an AP are configured on the AC that is connected To the AP, and then delivered to the AP. The following parameters are configured on the AP through Telnet or the console port.

1. Configuring the AP Access Mode

This section describes how to configure the mode in which an AP goes online.

2. Configuring VLANs on Wired Interfaces of an AP

This section describes how to configure VLANs on wired interfaces of an AP.

3. Configuring WDS

This section describes how to configure WDS parameters on an AP.

1 Configuring the AP Access Mode

This section describes how to configure the mode in which an AP goes online.

● AP Access Modes

After an AP starts, going online management module determines the mode in which the AP goes online. Users are unaware of the AP access mode. In the AP startup phase, the AP obtains the its IP address, the gateway IP address, and the AC IP address based on the access mode. After obtaining all the information, the AP sets up a Control And Provisioning of Wireless Access Point (CAPWAP) link with the AC. The process is as follows:

1. The AP reads the configuration file and determines the mode to go online.
2. If the DHCP mode is used, the AP starts the DHCP process.
3. If the static mode is used, the AP starts the AC discovery process based on the static configuration, and establishes a control tunnel with the discovered AC.
4. If the PPPoE mode is used, the AP initiates the PPPoE dial-up process. After obtaining the management IP address and gateway address, the AP uses the statically configured AC IP address to discover the AC, and establishes a control tunnel with the AC.

NOTE

By default, AP's go online in DHCP mode.

● Configuring the Mode for an AP to Go Online

● Configuring the AP to go online in DHCP mode

1. Use Telnet to log in to the AP from a PC.

```
login: admin
```

```
Password: //The default password is admin.
```

```
~ #
```

2. Configure the AP to go online in DHCP mode.

```
~ # cli
```

```
Enterprise AP# configure interface ethernet // Enter the AP interface view.
```

```
Enter Ethernet configuration commands, one per line.
```

```
Enterprise AP (if-ethernet) # ip mode dhcp // Set the mode in which the AP goes online.
```

```
Please reboot the AP, configuration will take effect
```

```
Enterprise AP (if-ethernet) #
```

3. Restart the AP to make the configuration take effect.

```
~ # reboot
```

● Configuring the AP to go online using a static IP address

1. Use Telnet to log in to the AP from a PC.

```
login: admin
```

```
Password: //The default password is admin.
```

```
~ #
```

2. Configure the AP to go online using a static IP address. The configuration items are the IP address of an AC that is connected to the AP, the AP's IP address (mandatory), the mask address (mandatory), and the gateway address (not required when in Layer 2 networking).

```
~ # cli
```

```
Enterprise AP# configure interface ethernet // Enter the AP interface view.
```

```
Enter Ethernet configuration commands, one per line.
```

```
Enterprise AP (if-ethernet) # ip mode static // Set the mode in which the AP goes online.
```

```
Enterprise AP (if-ethernet) # ac iplist 1.1.1.1 // Configure the IP address of an AC that is connected to the AP.
```

```
Enterprise AP (if-ethernet) # ip address 192.168.60.2 255.255.255.0 192.168.60.1 // Configure the IP address of the AP.
```

```
Please reboot the AP, configuration will take effect
```

```
Enterprise AP (if-ethernet) #
```

3. Restart the AP to make the configuration take effect.

```
~ # reboot
```

AP Local Configuration

- **Configuring the AP to go online in PPPoE mode**

1. Use Telnet to log in to the AP from a PC.
login: admin
Password: // The default password is admin.
~ #
2. Configure the AP to go online in PPPoE mode.
~ # cli
Enterprise AP# configure interface ethernet // Enter the AP interface view.
Enter Ethernet configuration commands, one per line.
Enterprise AP (if-ethernet) # ip mode pppoe // Set the mode in which the AP goes online.
Please reboot the AP, configuration will take effect
Enterprise AP (if-ethernet) #
3. Configure a user name and password for going online in PPPoE mode. By default, the user name and password are both wlan@huawei and the password type is simple.
Enterprise AP(if-ethernet) # user admin password simple admin //Set the user name and password to admin.
4. Restart the AP to make the configuration take effect.
~ # reboot

NOTE

- After the configuration is complete, run the reboot command to restart the AP.
- After the configuration is complete, run the show sysinfo command to check the configuration.

Enterprise AP(if-ethernet) # show sysinfo

```
ap_ipmode=pppoe
ap_ipaddr=
ap_ipversion=4
ap_netmask=
ap_gateway=
ac_ip1=
ac_ip2=
ac_ip3=
ac_ip4=
pppoe_username=wlan@huawei
pppoe_pwd_type=simple
pppoe_password=wlan@huawei
```

2. Configuring VLANs on Wired Interfaces of an AP

This section describes how to configure VLANs on wired interfaces of an AP.

- **Introduction to the Wired Interfaces**

A wired interface on an AP is connected to an AC or a switch. When the AP assigns service VLANs to packets, you can configure VLANs on wired interfaces of the AP.

- **Configuring VLANs on a Wired Interface**

NOTE

By default, the PVID of a wired-side interface is 0, and no VLAN is configured on the interface.

1. Use Telnet to log in to the AP from a PC.
login: admin
Password: //The default password is admin.
~ #
2. Configure VLANs and PVID on the wired interface.
~ # cli
Enterprise AP# configure interface ethernet // Enter the AP interface view.
Enter Ethernet configuration commands. one per line.
Enterprise AP (if-ethernet) # ether-port 0 [1-4095] [tag/untag] // Configure the VLANs allowed by the wired interface.
Enterprise AP (if-ethernet) # ether-port 0 pvid [1-4095] //Configure the PVID of the wired interface.

NOTE

The configuration takes effect immediately, and you do not need to restart the AP.

AP Local Configuration

3. Configuring WDS

This section describes how to configure WDS parameters on an AP.

• Introduction to WDS

WDS enables multiple AP6010DNs to establish wireless links to connect two or more wired or wireless LANs. WDS-enabled AP6010DNs can switch data packets between the LANs. WDS facilitates network deployment, and device installation, and allows flexible networking.

• Configuring WDS

Most WDS parameters are configured on the AC. For details, see the AC configuration guides. On an AP, you can enable or disable the radio indicator that indicates the signal strength of the last hop bridge, and configure the WDS keys.

• Enabling/Disabling the radio indicator that indicates the signal strength of the last hop bridge.

NOTE

By default, the radio indicator is enabled on an AP6010DN.

1. Use Telnet to log in to the AP from a PC.
login: admin
Password: // The default password is admin.
~ #
2. Enabling/Disabling the AP's radio indicator
Enterprise AP (config) # configure interface wireless 0 (1) // Enter the 2.4G 5G interface view.
Enter Wireless configuration commands, one per line.
Enterprise AP (if-wireless 0 (1)) # wds led flag 0 (1) // Enable/Disable the AP's radio indicator.
Please reboot the AP, configuration will take effect
3. Restart the AP to make the configuration take effect.
~ # reboot

• Configure the WDS key.

1. Use Telnet to log in to the AP from a PC.
login: admin
Password: // The default password is admin.
~ #
2. Configure the WDS key.
Enterprise AP (config) # configure interface wireless 0 // Enter the 2.4G 5G interface view.
Enter Wireless configuration commands, one per line.
Enterprise AP (if-wireless 0 (1)) # wds psk 0 (1) 111111 // Set the key type to hex (parse) and the key to 111111.
3. Restart the AP to make the configuration take effect.
~ # reboot

NOTE

After the configuration is complete, run the reboot command to restart the AP.

Declaration on Hazardous Substances in Electronic Information Products

Part	Hazardous Substances					
	Pb	Hg	Cd	Cr6+	PBB	PBDE
Mechanical part	O	O	O	O	O	O
Board/circuit module	O	O	O	O	O	O
Signal cable	O	O	O	O	O	O
Cable connector	O	O	O	O	O	O
Power adapter	O	O	O	O	O	O
Auxiliary equipment	O	O	O	O	O	O

O: Indicates that the concentration of the hazardous substance contained in all the homogeneous materials of this part is below the limit requirement of the SJ/T 11363-2006 standard.

X: Indicates that the Concentration of the hazardous substance contained in all the homogeneous materials of this part is above the limit requirement.

QUALIFICATION CARD

合格证/QUALIFICATION CARD	
检验员 / QC: _____	
日期 / DATE: _____	
 HUAWEI	
华为技术有限公司 HUAWEI TECHNOLOGIES CO., LTD	中国制造 MADE IN CHINA



Warranty Card

Thank you for choosing HUAWEI Technologies Co., Ltd-a leading telecom solution provider. To get better services, please read this warranty card carefully, fill in the required information and preserve this card in good condition.

Your Name	
Address/Postal Code	
Telephone	
Product Type	
Product Serial Number	
Purchase Date	
Invoice Number	
Dealer Name	
Dealer's Address/Telephone	

Preserve well. No reissue

Dealer's Seal: Limited Warranty

Subject to the exclusions contained below, Huawei Technologies CO., Ltd. (hereinafter referred to as Huawei) warrants its access terminals ("Products") to be free from defects in materials and workmanship under normal consumer usage for one year from the date of purchase of the product ("Warranty period"). During the warranty period, a Huawei authorized service partner shall remedy defects in materials and workmanship free of charge.

Special Notice:

1. The warranty card shall be applicable only after being stamped by the dealer.
2. The warranty card must be preserved in good condition and free of any scratch or alteration.
3. To claim such service for defects that are not included in The following exclusion terms, the warranty card and the invoice that records the product serial number shall be presented to a Huawei authorized service partner.

Exclusions:

In any of the following cases, the warranty card becomes unenforceable or inapplicable without prior notice:

1. The defects are caused by improper handling in transportation and assembly.
2. The defects are caused by the fact that the product is dismantled or altered by anyone that is not from a Huawei authorized service partner.
3. The defects are caused by the fact that the product is used in a harsh environment that is not suitable for the operation of the product.
4. The defects are caused by any force majeure including but not limited to fire, earthquake, lightning and tsunamis.
5. The defects are caused by the fact that the product is used or handled improperly, roughly or not as instructed in the applicable User Guide.
6. The normal wear and tear, including but not limited to the normal wear and tear of the shell and the power module, shall not be covered by the limited warranty.
7. The warranty card is altered or illegible, or the product serial number recorded on the warranty card is inconsistent with the actual one imprinted or labeled on the product.

In any case that is not covered by this limited warranty or should the warranty expire, Huawei shall charge for the service(s) claimed for the products if the product is still remediable.

Huawei preserves the right for interpretation of this limited warranty.



HUAWEI Huawei Technologies Co., Ltd.
 Huawei Industrial Base, Bantian, Longgang,
 Shenzhen 518129, People's Republic of China
<http://www.huawei.com>

HUAWEI TECHNOLOGIES CO., LTD.

Huawei Industrial Base
Bantian, Longgang
Shenzhen 518129
People's Republic of China

www.huawei.com

Part Number: 31505361 Issue: 01