

Huawei AR1200-S&2200-S Series Enterprise Routers

V200R001C01

Hardware Description

Issue 03

Date 2012-04-20

Copyright © Huawei Technologies Co., Ltd. 2012. All rights reserved.

No part of this document may be reproduced or transmitted in any form or by any means without prior written consent of Huawei Technologies Co., Ltd.

Trademarks and Permissions



HUAWEI and other Huawei trademarks are trademarks of Huawei Technologies Co., Ltd.

All other trademarks and trade names mentioned in this document are the property of their respective holders.

Notice

The purchased products, services and features are stipulated by the contract made between Huawei and the customer. All or part of the products, services and features described in this document may not be within the purchase scope or the usage scope. Unless otherwise specified in the contract, all statements, information, and recommendations in this document are provided "AS IS" without warranties, guarantees or representations of any kind, either express or implied.

The information in this document is subject to change without notice. Every effort has been made in the preparation of this document to ensure accuracy of the contents, but all statements, information, and recommendations in this document do not constitute the warranty of any kind, express or implied.

Huawei Technologies Co., Ltd.

Address: Huawei Industrial Base
Bantian, Longgang
Shenzhen 518129
People's Republic of China

Website: <http://www.huawei.com>

Email: support@huawei.com

About This Document

Intended Audience





This document provides an overall description of the AR routers, details about each chassis and board, cables available to the device, and lists of components.

This document is intended for:

- Network planning engineers
- Hardware installation engineers
- Commissioning engineers
- On-site maintenance engineers
- System maintenance engineers

Symbol Conventions

The symbols that may be found in this document are defined as follows.

Symbol	Description
 DANGER	Indicates a hazard with a high level of risk, which if not avoided, will result in death or serious injury.
 WARNING	Indicates a hazard with a medium or low level of risk, which if not avoided, could result in minor or moderate injury.
 CAUTION	Indicates a potentially hazardous situation, which if not avoided, could result in equipment damage, data loss, performance degradation, or unexpected results.
 TIP	Indicates a tip that may help you solve a problem or save time.
 NOTE	Provides additional information to emphasize or supplement important points of the main text.

Change History

Changes between document issues are cumulative. Therefore, the latest document issue contains all the changes in previous issues.

Changes in Issue 02 (2012-03-30)

Based on issue 01 (2011-12-30), this issue has the following updates:

- The AR2220-S model is added.

Changes in Issue 01 (2011-12-30)

Initial commercial release.

Contents

About This Document.....	ii
1 Version Matching.....	1
1.1 Matching Between Product Models and Software Versions.....	2
1.2 Matching Between Power Supplies and Software Versions.....	2
1.3 Matching Between Cards and Software Versions.....	3
2 Chassis.....	7
2.1 Introduction.....	8
2.2 Naming Convention.....	8
2.3 Device Structure.....	9
2.3.1 AR1200-S Series.....	9
2.3.2 AR2200-S Series.....	12
2.4 System Configuration.....	14
2.5 Physical Specifications.....	14
3 Power Supply Units.....	16
3.1 Power Supply Configuration.....	17
3.2 Power Supply Unit Connection Layouts.....	17
3.2.1 Single Non-PoE AC Power Supply Unit.....	17
3.2.2 Single Non-PoE + PoE AC Power Supply Unit.....	18
3.3 HW-100-48AC14D.....	19
4 Heat Dissipation System.....	23
4.1 Heat Dissipation Process.....	24
5 Cards.....	25
5.1 Introduction.....	26
5.1.1 Relationships Between Cards.....	26
5.1.2 Interface Numbering.....	27
5.1.3 Card Dimensions.....	28
5.2 WLAN Subcard.....	29
5.2.1 Functions and Applications.....	29
5.2.2 Technical Specifications.....	29
5.3 Ethernet LAN Interface Card.....	29
5.3.1 8FE1GE-8-Port 100BASE-RJ45 and 1-Port 1000BASE-RJ45 L2/L3 Ethernet Interface Card.....	30

5.3.2 24GE-24-Port 1000BASE-RJ45 L2/L3 Ethernet Interface Card.....	33
5.4 WAN Interface Card.....	36
5.4.1 1GEC (1-Port-GE Combo WAN Interface Card).....	36
5.4.2 2FE-2-Port-FE WAN Interface Card.....	40
5.4.3 1E1T1-M/2E1T1-M-1/2 Port-Channelized E1/T1/PRI/VE1 Multifunctional Interface Card.....	42
5.4.4 1E1T1-F/2E1T1-F (1/2-Port-Fractional Channelized E1/T1 WAN Interface Card).....	47
5.4.5 1SA/2SA-1/2-Port-Synchronous/Asynchronous WAN Interface Card.....	50
5.4.6 8AS (8-Port-Asynchronous WAN Interface Card).....	54
5.4.7 1BST (1-Port-ISDN S/T WAN Interface Card).....	56
5.4.8 1CPOS-155M (1-Port Channelized POS Interface Card).....	59
5.4.9 3G-HSPA+7 (3G WAN Interface Card).....	62
5.4.10 4GEW-T (4-Port-GE Electrical WAN Interface Card).....	67
5.4.11 4GEW-S (4-Port-GE Optical WAN Interface Card).....	69
5.5 Voice Interface Card.....	73
5.5.1 2BST (2-Port-ISDN S/T Voice Interface Card).....	73
5.5.2 4FXS1FXO-4-Port FXS and 1-Port FXO Voice Interface Card.....	77
5.5.3 16/32/64/128-Channel DSP Module.....	80
5.6 xDSL Interface Card.....	81
5.6.1 ADSL-A/M and ADSL-B-1-Port-ADSL2+ ANNEX A/M and B WAN Interface Card.....	81
5.6.2 4G.SHDSL-1-Port-4-Channel G.SHDSL WAN Interface Card.....	85
5.6.3 1PON (1-Port GPON/EPON Dual-Mode Interface Card).....	87
5.6.4 VDSL (1-Port VDSL2 over POTS WAN Interface Card).....	91
6 Cables.....	95
6.1 AC Power Cable.....	97
6.2 DC Power Cables.....	98
6.3 Ground Cable.....	100
6.4 Console Cable.....	101
6.5 Network Cable.....	102
6.6 Optical Fiber.....	105
6.7 E1/T1 Trunk Cables.....	109
6.8 Synchronous/Asynchronous Serial Interface Cables.....	114
6.9 4G.SHDSL Cables.....	120
6.10 ISDN-ST Cables.....	122
6.11 Regular Telephone Lines.....	126
6.12 8AS Cable.....	127
6.13 3G Antenna.....	132
7 List of Indicators.....	136
7.1 Indicators on the AR1200-S Panel.....	137
7.2 Indicators on the AR2220-S Panel.....	140
7.3 Power Indicators.....	142
8 List of Cards.....	145

8.1 Cards Supported by the AR.....	146
8.2 Power Consumption and Weight.....	149
9 List of Interface Attributes.....	150
9.1 Electrical Interfaces.....	152
9.2 GE/PON Optical Interface Attributes.....	153
9.3 CPOS Interface Attributes.....	155
9.4 E1 Interface Attributes.....	156
9.5 T1 Interface Attributes.....	157
9.6 Synchronous/Asynchronous Serial Interface Attributes.....	158
9.7 ISDN S/T Interface Attributes.....	159
9.8 FXS/FXO Interface Attributes.....	159
9.9 ADSL2/ADSL2+/G.SHDSL Interface Attributes.....	161
9.10 Attributes of the Console Interface.....	162
9.11 Attributes of the USB Interface.....	162
9.12 3G Interface Attributes.....	163
9.13 VDSL Interface Attributes.....	164

1 Version Matching

About This Chapter

This section describes the matching relationships between the chassis, power supplies, cards, and system software versions of AR routers.

 **NOTE**

- AR version roadmap: ARV200R001C01, ARV200R002C00, ARV200R002C01.
- Unless otherwise specified, if a power supply or card is supported by version A, it is also supported by all versions later than version A.

[1.1 Matching Between Product Models and Software Versions](#)

This section describes the matching relationship between AR models and software versions.

[1.2 Matching Between Power Supplies and Software Versions](#)

This section describes the matching relationships between power supplies, power modes, and software versions.

[1.3 Matching Between Cards and Software Versions](#)

This section describes the cards supported by AR routers, including SRUs, Ethernet LAN interface cards, WAN interface cards, voice interface cards, and xDSL/xPON interface cards.

1.1 Matching Between Product Models and Software Versions

This section describes the matching relationship between AR models and software versions.

Table 1-1 Matching between product models and software versions

Model		Software Version		
		ARV200R001C01	ARV200R002C00	ARV200R002C01
AR1200-S series	AR12 20-S	√	√	√
	AR12 20W-S	√	√	√
AR2200-S series	AR22 20-S	√	×	√

1.2 Matching Between Power Supplies and Software Versions

This section describes the matching relationships between power supplies, power modes, and software versions.

Table 1-2 Matching between power supplies and software versions

Model&Version		60 W AC Power Supply Unit in an Open Rack	3.3 HW-100-48AC 14D	PWR150A
ARV200R001C01& ARV200R002C00& ARV200R002C01	AR1220-S	√	×	×
	AR1220W-S	√	√	×
	AR2220-S	×	×	√

Table 1-3 Matching between power modes and software versions

Model&Version		Single DC Power Supply Unit	Dual DC Power Supply Units	Single Non-PoE AC Power Supply Unit	Dual Non-PoE AC Power Supply Units	Single Non-PoE + PoE AC Power Supply Unit
ARV200R001C01&ARV200R002C00&ARV200R002C01	AR1220-S	×	×	√	×	×
	AR1220W-S	×	×	√	×	√
	AR2220-S	×	×	√	×	×

1.3 Matching Between Cards and Software Versions

This section describes the cards supported by AR routers, including SRUs, Ethernet LAN interface cards, WAN interface cards, voice interface cards, and xDSL/xPON interface cards.

Matching between physical cards and software versions

Table 1-4 Matching between physical cards and software versions

Model&Version		SIC	WSIC	XSIC	voice card
ARV200R001C01&ARV200R002C00&ARV200R002C01	AR1220-S	√	√	×	×
	AR1220W-S	√	√	×	×
	AR2220-S	√	√	√	√

Matching between SRUs and software versions

Table 1-5 Matching between SRUs and software versions

Model&Version		SRU	WLAN Subcard
ARV200R001C01&ARV200R002C00	AR1220-S	×	×

Model&Version		SRU	WLAN Subcard
C00&ARV200R002C01	AR1220W-S	×	√
	AR2220-S	×	×

Matching between Ethernet LAN interface cards and software versions

Table 1-6 Matching between Ethernet LAN interface cards and software versions

Model&Version		8FE1GE	24GE
ARV200R001C01&ARV200R002C00&ARV200R002C01	AR1220-S	√	×
	AR1220W-S	√	×
	AR2220-S	√	√

Matching between WAN cards and software versions

Table 1-7 Matching between WAN cards and software versions

Model&Version		2FE	1E1T1-M/2E1T1-M(SIC)	2E1T1-M(WSIC)	1E1T1-F/2E1T1-F	1SA	2SA	1GEC	8AS	1BST	1CPOS-155M	3G-HSPA+7	4GEW-T	4GEW-S
ARV200R001C01	AR1220-S	√	√	×	√	√	√	√	√	√	×	×	×	×
	AR1220W-S	√	√	×	√	√	√	√	√	√	×	×	×	×
	AR2220-S	√	√	×	√	√	√	√	√	√	√	×	×	×
ARV200R002C00	AR1220-S	√	√	√	√	√	√	√	√	√	×	×	×	×

Model&Version		2FE	1E1 T1-M/2E1 T1-M (SIC)	2E1 T1-M (WSIC)	1E1 T1-F/2E1 T1-F	1SA	2SA	1GEC	8AS	1BST	1CPOS-155M	3G-HSPA+7	4GEW-T	4GEW-S
	AR1220W-S	√	√	√	√	√	√	√	√	√	×	×	×	×
	AR2220-S	√	√	√	√	√	√	√	√	√	√	×	×	×
ARV200R002C01	AR1220-S	√	√	√	√	√	√	√	√	√	×	√	√	√
	AR1220W-S	√	√	√	√	√	√	√	√	√	×	√	√	√
	AR2220-S	√	√	√	√	√	√	√	√	√	√	√	√	√

Matching between voice cards and software versions

Table 1-8 Matching between voice cards and software versions

Model&Version		4FXS1FXO	2BST(SIC)	2BST(WSIC)	16/32/64/128-Channel DSP Module
ARV200R001C01	AR1220-S	×	×	×	×
	AR1220W-S	×	×	×	×
	AR2220-S	√	√	×	√
ARV200R002C00&ARV200R002C01	AR1220-S	×	×	×	×
	AR1220W-S	×	×	×	×

Model&Version		4FXS1FXO	2BST(SIC)	2BST(WSIC)	16/32/64/128-Channel DSP Module
	AR220-S	√	√	√	√

Matching between xDSL/xPON cards and software versions

Table 1-9 Matching between xDSL/xPON cards and software versions

Model&Version		ADSL-A/M	ADSL-B	4G.SH DSL	1PON	VDSL
ARV200R001C01	AR1220-S	√	√	√	×	×
	AR1220W-S	√	√	√	×	×
	AR2220-S	√	√	√	×	×
ARV200R002C00	AR1220-S	√	√	√	√	×
	AR1220W-S	√	√	√	√	×
	AR2220-S	√	√	√	√	×
ARV200R002C01	AR1220-S	√	√	√	√	√
	AR1220W-S	√	√	√	√	√
	AR2220-S	√	√	√	√	√

2 Chassis

About This Chapter

This section describes the characteristics, naming rules, appearance, structure, system performance, and technical specifications of the AR routers.

[2.1 Introduction](#)

This section briefly describes the AR routers and the models available.

[2.2 Naming Convention](#)

This section describes the naming conventions used when naming AR routers.

[2.3 Device Structure](#)

This section describes the structure of the AR routers.

[2.4 System Configuration](#)

[2.5 Physical Specifications](#)

2.1 Introduction

This section briefly describes the AR routers and the models available.

Description

Huawei AR Enterprise Router (AR router for short) are the next-generation routers integrating data, voice, security, routing, switching, and virtual private network (VPN) functions. As an egress gateway for enterprises, the AR routers use the multi-core CPU processing capabilities and rapid expansibility.

Models

The AR routers offer the following models.

Model		Characteristics
AR1200-S	AR1220-S	The AR1220-S is 1 U high (1 U = 44.45 mm [1.75 in.]), uses a 60 W open frame AC power supply, and supports two SIC slots. The integrated SRU provides eight fixed FE interfaces and two fixed GE electrical interfaces.
	AR1220W-S	<ul style="list-style-type: none">● Compared with the AR1220-S, the AR1220W-S supports the Wi-Fi function and external PoE power supply unit. The last four FE interfaces (FE4-FE7) on the main control unit support the PoE function.● The silkscreen on the rear side of AR1220W-S chassis is AR1220W-S and two antennas and a PoE power supply port are provided.
AR2200	AR2220-S	The AR2220-S is 1 U high (1 U = 44.45 mm), uses a 150 W AC power supply unit, and supports four SIC cards and two WSIC cards. The integrated SRU supports fixed 3GE interfaces (including one combo interface). The backplane is in the middle of the chassis, and cards are installed on the front and rear sides of the backplane.

NOTE

- SIC: Service Interface Card. This is the smallest card supported by ARs.
- WSIC: Wide SIC. The same height as a SIC, but twice the width.
- XSIC: Extended SIC. Double the height and width of an XSIC and twice those of a SIC.

NOTE

In this document, AR1200-S indicates AR1220-S and AR1220W-S.

2.2 Naming Convention

This section describes the naming conventions used when naming AR routers.

Figure 2-1 Naming convention

【AR】【B1 B2 B3 B4】【C1】【-D1】

Example:

AR1220-S

Table 2-1 Naming convention of AR routers

Field	Description
B1	Product series code. AR routers includes series 1 and 2.
B2	Fixed as 2, indicating enterprise router.
B3	Number of service card slots (dependent on B1): <ul style="list-style-type: none"> ● When B1 is 1, B3 indicates the number of SIC cards. ● When B1 is 2, B3 indicates the number of WSIC and XSIC cards.
B4	The value is fixed as 0.
C1	C1 contains one or two upper-case letters. <ul style="list-style-type: none"> ● W: WLAN ● V: voice
D1	<ul style="list-style-type: none"> ● A: AC (This is the default configuration, so A is not contained in the product name) ● D: DC ● S: Soho

2.3 Device Structure

This section describes the structure of the AR routers.

2.3.1 AR1200-S Series

This section describes the structure of the AR1200-S.

Appearance

Figure 2-2 and Figure 2-3 show front views of AR1200-S.

Figure 2-5 AR1220W-S rear view

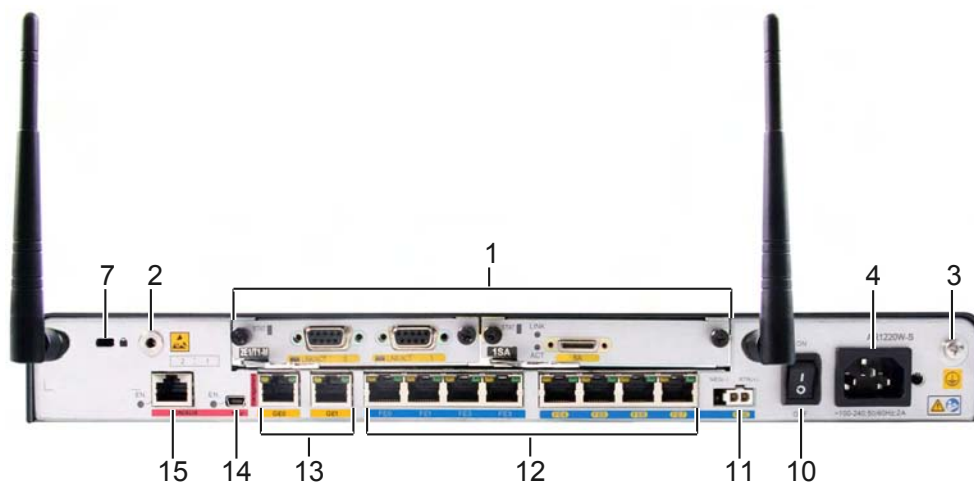

1: Pluggable card	2: ESD jack	3: Ground screw	4: AC jack
7: Security lock	10: AC power switch	11: PoE port	12: Fixed 8FE interface on the panel
13: Two Fixed GE interfaces on the panel	14: Mini USB interface	15: CON/AUX interface	18: USB interfaces NOTE After a 3G USB modem is inserted, install a protection cap on it, as shown in the following figure. 
19: Antenna	20: WLAN switch		

Slot Distribution

Figure 2-6 shows slot distribution on AR1200-S.

NOTE

- Two SIC slots can be combined into one WSIC slot by removing the guide rail.
- Slots can be combined into one, but one slot cannot be divided into multiple slots.
- After two slots are combined into one, the slot ID is the larger number of the two original slots.

Figure 2-6 AR1200-S slot distribution on

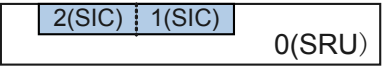
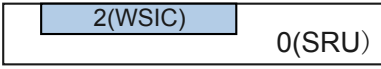
Device Model		Slot Distribution	Slot Combination
AR1200-S	Front view	NA	NA
	Rear view		Two SIC slots are combined into one WSIC slot 

As shown in [Figure 2-6](#), the slots of AR1200-S can be combined :

Slot 1 and slot 2 are combined into new slot 2.

2.3.2 AR2200-S Series

This section describes the structure of the AR2200-S.

Appearance

[Figure 2-7](#) show front views of AR2200-S.

Figure 2-7 AR2200-S front view

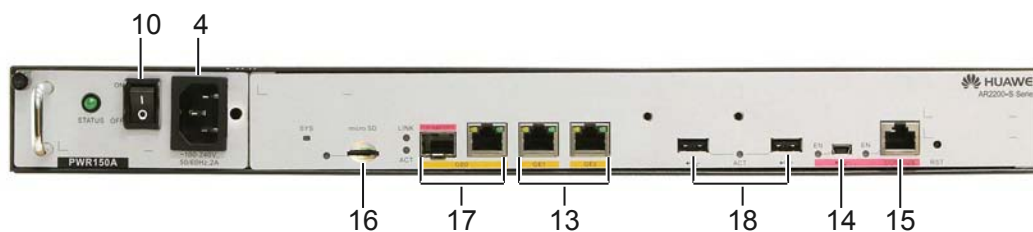

[Figure 2-8](#) show rear views of AR2200-S.

Figure 2-8 AR2200-S rear view

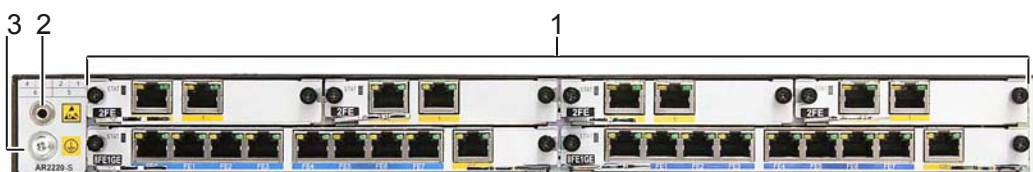

1: Pluggable card	2: ESD jack	3: Ground screw	4: AC jack
-------------------	-------------	-----------------	------------

10: AC power switch	13: Two Fixed GE interfaces on the panel	14: Mini USB interface	15: CON/AUX interface
16: Micro SD card interface	17: GE optical/electrical Combo interface	18: USB interfaces NOTE After a 3G USB modem is inserted, install a protection cap on it, as shown in the following figure. 	

Slot Distribution

Figure 2-9 shows slot distribution on AR2200-S.

 **NOTE**

- Two SIC slots can be combined into one WSIC slot by removing the guide rail.
- Two SIC slots and one WSIC slot can be combined into one XSIC slot by removing the guide rail.
- Two XSIC slots can be combined into one EXSIC slot by removing the guide rail.
- Slots can be combined into one, but one slot cannot be divided into multiple slots.
- After two slots are combined into one, the slot ID is the larger number of the two original slots.

Figure 2-9 AR2200-S slot distribution

Device Model		Slot Distribution		Slot Combination														
AR2220-S	Front view	7(Power)	0(SRU)	NA														
	Rear view	<table border="1" style="width: 100%;"> <tr> <td style="background-color: #e0f0ff;">4(SIC)</td> <td style="background-color: #e0f0ff;">3(SIC)</td> <td>2(SIC)</td> <td>1(SIC)</td> </tr> <tr> <td colspan="2" style="background-color: #e0f0ff;">6(WSIC)</td> <td colspan="2" style="background-color: #e0f0ff;">5(WSIC)</td> </tr> </table>		4(SIC)	3(SIC)	2(SIC)	1(SIC)	6(WSIC)		5(WSIC)		<p>Two SIC slots are combined into one WSIC slot</p> <table border="1" style="width: 100%;"> <tr> <td style="background-color: #e0f0ff;">4(WSIC)</td> <td style="background-color: #e0f0ff;">2(WSIC)</td> </tr> <tr> <td style="background-color: #e0f0ff;">6(WSIC)</td> <td style="background-color: #e0f0ff;">5(WSIC)</td> </tr> </table> <p>Two WSIC slots are combined into one XSIC slot</p> <table border="1" style="width: 100%;"> <tr> <td style="background-color: #e0f0ff;">6(XSIC)</td> <td style="background-color: #e0f0ff;">5(XSIC)</td> </tr> </table>		4(WSIC)	2(WSIC)	6(WSIC)	5(WSIC)	6(XSIC)
4(SIC)	3(SIC)	2(SIC)	1(SIC)															
6(WSIC)		5(WSIC)																
4(WSIC)	2(WSIC)																	
6(WSIC)	5(WSIC)																	
6(XSIC)	5(XSIC)																	

As shown in Figure 2-9, the slots of AR2200-S can be combined :

- AR2220-S
 - Slot 1 and slot 2 are combined into new slot 2.
 - Slot 3 and slot 4 are combined into new slot 4.
 - New slot 2 and slot 5 are combined into new slot 5.
 - New slot 4 and slot 6 are combined into new slot 6.

2.4 System Configuration

Table 2-2 System configuration

Model	Processor	Memory	Flash Memory	Micro SD Card
AR1200-S Series	2-core: 500 MHz	512 MB	256 MB	0
AR2220-S	4-core: 600 MHz	2 GB	16 MB	2 GB

2.5 Physical Specifications

Table 2-3 Physical specifications

Item	Description	
Dimensions (width x depth x height)	<ul style="list-style-type: none"> ● Without rack-mounting ear: <ul style="list-style-type: none"> - AR1200-S: 390.0 mm x 220.0 mm x 44.5 mm (15.35 in. x 8.66 in. x 1.75 in.) - AR2220-S: 442.0 mm x 420.0 mm x 44.5 mm (17.4 in. x 16.54 in. x 1.75 in.) ● With rack-mounting ear: <ul style="list-style-type: none"> - AR1200-S: 482.6 mm x 220.0 mm x 44.5 mm (19 in. x 8.66 in. x 1.75 in.) - AR2220-S: 482.6 mm x 420.0 mm x 44.5 mm (19 in. x 16.54 in. x 1.75 in.) 	
Maximum power consumption	Full configuration	<ul style="list-style-type: none"> ● AR1200-S: 52 W ● AR2220-S: 95 W
	Empty chassis	<ul style="list-style-type: none"> ● AR1200-S: 33.3 W ● AR2220-S: 65.1 W
Weight	Full configuration	<ul style="list-style-type: none"> ● AR1200-S: 3.60 kg (7.94 lb) ● AR2220-S: 8.45 kg (18.63 lb)
	Empty chassis	<ul style="list-style-type: none"> ● AR1200-S: 2.90 kg (6.39 lb) ● AR2220-S: 4.95 kg (10.91 lb)
Operating temperature		0°C to 40°C (0°F to 104°F)
Relative humidity		5% RH to 90% RH, non-condensing

Item		Description
Altitude	Long-term operating altitude	Below 4000 m (13123.2 ft.)
	Storage altitude	Below 4000 m (13123.2 ft.)
AC input voltage	Rated voltage	100 V AC to 240 V AC, 50/60Hz
	Maximum voltage	85 V AC to 264 V AC, 47/63Hz

3 Power Supply Units

About This Chapter

This section describes the power supply units supported by the AR routers.



CAUTION

- Power off the AR routers before removing or performing maintenance on the power supply units.
 - To power off the AR routers, power off all its power supply units.
-

[3.1 Power Supply Configuration](#)

This section describes the configurations of power supply units on the AR routers.

[3.2 Power Supply Unit Connection Layouts](#)

This section illustrates the connection between each power supply unit and the motherboard.

[3.3 HW-100-48AC14D](#)

This section describes the HW-100-48AC14D power supply unit, including the naming convention, functions, appearance, and technical specifications.

3.1 Power Supply Configuration

This section describes the configurations of power supply units on the AR routers.

Table 3-1 describes the power supply units supported by each model.

Table 3-1 Power supply units supported by each model

Power Supply Unit	Description	Installation	Maintenance
60 W AC power supply unit in an open rack	AC power supply unit fixed in the chassis	Fixed in the chassis, does not need to be connected to the chassis using cables.	Maintain together with the chassis.
3.3 HW-100-48AC14D	External PoE AC power supply unit	Connected to the PoE port at the back of the chassis using its own power cable.	Maintain independently from the chassis.
PWR150A	AC power supply unit	Inserted into a power supply slot. The device supports only one power supply unit.	Maintain together with the chassis.

3.2 Power Supply Unit Connection Layouts

This section illustrates the connection between each power supply unit and the motherboard.

3.2.1 Single Non-PoE AC Power Supply Unit

Figure 3-1 shows the layout of single non-PoE AC power supply unit connection to motherboard.

Figure 3-1 Layout of single non-PoE AC power supply unit connection to motherboard

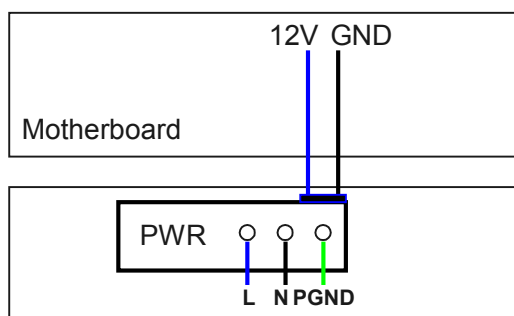

1. L: Live wire 2. N: Neutral wire 3. PGND: PGND wire 4. GND: Grounding

After the AC power is transmitted to the PWR module, the PWR module outputs 12 V voltage, and then the motherboard provides power for the entire device.

3.2.2 Single Non-PoE + PoE AC Power Supply Unit

Figure 3-2 shows the layout of single non-PoE + PoE AC power supply unit connection to motherboard.

Figure 3-2 Layout of single non-PoE + PoE AC power supply unit connection to motherboard

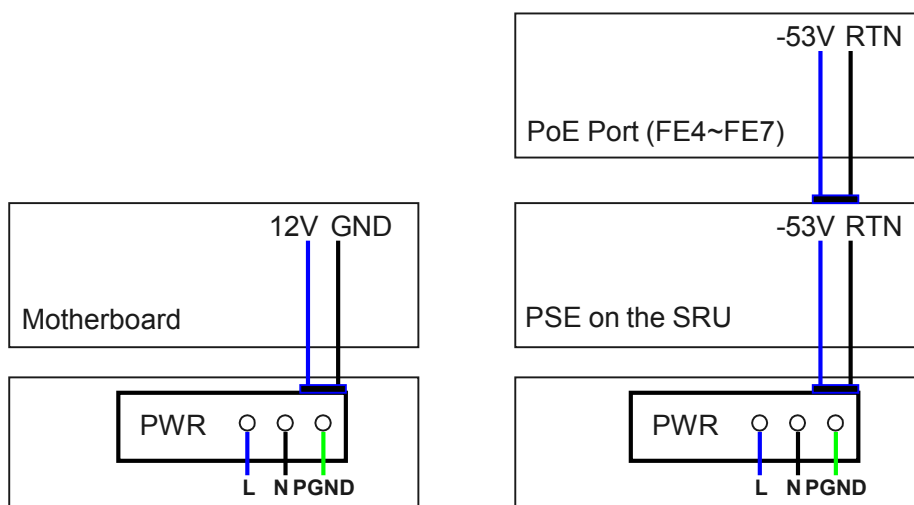

1. L: Live wire 2. N: Neutral wire 3. PGND: PGND wire 4. GND: Grounding 5. RTN: Power ground cable

The non-PoE AC power supply unit and PoE AC power supply unit are independent of each other:

- Non-PoE AC power supply unit: After the AC power is transmitted to the PWR module, the PWR module outputs 12 V voltage, and then the motherboard provides power for the entire device.
- PoE AC power supply unit: After the AC power is transmitted to the PoE module, the PoE module outputs -53 V voltage, and then the PSE on the SRU provides power for the powered devices (PDs) connected to the PoE interface.

3.3 HW-100-48AC14D

This section describes the HW-100-48AC14D power supply unit, including the naming convention, functions, appearance, and technical specifications.

Naming Convention

Figure 3-3 illustrates the naming convention of the HW-100-48AC14D.

Figure 3-3 HW-100-48AC14D naming convention

HW-100-48AC14D
(1) (2) (3) (4) (5)

Number	Description
(1)	Product brand
(2)	Output power parameters <ul style="list-style-type: none">● 100: The output power is 100 W.● 48: The output voltage is 48 V.
(3)	Power supply unit type <ul style="list-style-type: none">● A (Alternate): AC/DC power supply unit● D (Direct): DC/DC power supply unit
(4)	Socket type <ul style="list-style-type: none">● C14 is a type of socket.
(5)	D (Desk), indicating the desktop power supply.

Functions

The HW-100-48AC14D uses 90 V AC-264 V AC input power, and provide 48 V/100 W output power when no fan is used. **Table 3-2** describes the protection functions provided by the HW-100-48AC14D.

Table 3-2 Protection functions of the HW-100-48AC14D

Item		Minimum Value	Typical Value	Maximum Value	Remarks
Input protection	Input undervoltage protection	-	-	62 V	Input voltage can be restored to the normal range automatically.
	Input undervoltage recovery	-	-	80 V	Hysteresis is not smaller than 5 V.
Output protection	Output overvoltage protection	51 V	-	58 V	Output voltage can be restored to the normal range automatically.
	Output overcurrent protection	2.5 A	3 A	3.5 A	Output current can be restored to the normal range automatically.
	Output short-circuit protection	-	-	-	Output short-circuit can be recovered automatically.
Overheating protection		-	-	-	When temperature exceeds the upper limit, the power supply unit automatically shuts down to avoid permanent damage. No smoke will be generated. Temperature is reduced below 55°C (131°F).

Appearance

Figure 3-4 shows the appearance of the HW-100-48AC14D.

Figure 3-4 Appearance of the HW-100-48AC14D



Table 3-3 describes meanings of the indicators.

Table 3-3 Description of the HW-100-48AC14D indicators

Indicator	Color	Description
Power indicator	Blue	If the indicator is steady on, the output power is in the normal range.
		If the indicator is off, the power supply unit does not have output power.

Technical Specifications

Table 3-4 describes the technical specifications of the HW-100-48AC14D.

Table 3-4 Technical specifications of the HW-100-48AC14D

Item	Specification
Dimensions (width x depth x height)	72 mm x 171 mm x 40 mm (2.83 in. x 6.73 in. x 1.57 in.)
Weight	0.65 kg (1.5 lb)
AC input voltage	90 V AC to 264 V AC; typical: 110 V AC/220 V AC
AC input frequency	47 Hz to 63 Hz; typical: 50 Hz/60 Hz

Item	Specification
Rated operating voltage	100 V AC to 240 V AC; typical: 110 V AC/220 V AC
Rated output current	2.08 A
Rated output voltage	48 V
Output power	100 W
Operating temperature	0°C to 40°C (0°F to 104°F)
Humidity	20% RH to 80% RH
Altitude	4000 m (13123.2 ft.)

4 Heat Dissipation System

About This Chapter

This section describes the heat dissipation system of the AR router.

The fan module of the AR router is described as follows:

- The fan module of the AR1200-S and AR2220-S is located on the right side in the chassis.
 - The fan module dimensions of the AR1200-S are 40 mm [1.58 in.] (width) x 20 mm [0.79 in.] (depth).
 - The fan module dimensions of the AR2220-S are 40 mm [1.58 in.] (width) x 20 mm [0.79 in.] (depth).

[4.1 Heat Dissipation Process](#)

The AR routers heat dissipation system uses fans to create a left-to-right air channel.

4.1 Heat Dissipation Process

The AR routers heat dissipation system uses fans to create a left-to-right air channel.

 **NOTE**

The heat dissipation system ensures that the AR routers operates at a normal temperature. For temperature requirements, see [2.5 Physical Specifications](#).

[Figure 4-1](#) shows air circulation through the AR1200-S chassis.

Figure 4-1 Air circulation through the AR1200-S chassis



[Figure 4-2](#) shows air circulation through the AR2220-S chassis.

Figure 4-2 Air circulation through the AR2220-S chassis



5 Cards

About This Chapter

This chapter describes the cards supported by the AR routers.

[5.1 Introduction](#)

This section describes the cards supported by the AR routers, including card types, relationships between cards, the interface numbering scheme, and card dimensions.

[5.2 WLAN Subcard](#)

WLAN subcards are Wi-Fi modules.

[5.3 Ethernet LAN Interface Card](#)

This section describes the types, functions, applications, appearance, interfaces, and technical specifications of the Ethernet LAN interface card.

[5.4 WAN Interface Card](#)

This section describes the types, functions, applications, appearance, interfaces, and technical specifications of the WAN interface card.

[5.5 Voice Interface Card](#)

This section describes the types, functions, applications, appearance, interfaces, and technical specifications of the voice interface card.

[5.6 xDSL Interface Card](#)

This section describes the types, functions, applications, appearance, interfaces, and technical specifications of the xDSL/xPON interface card.

5.1 Introduction

This section describes the cards supported by the AR routers, including card types, relationships between cards, the interface numbering scheme, and card dimensions.

5.1.1 Relationships Between Cards

This section describes the relationships between the cards supported by the AR routers.

 **NOTE**

- On the AR1200, the backplane is at the bottom of the chassis, and cards are installed on the backplane.
- On the AR2220, the backplane is in the middle of the chassis, cards are installed on the rear side of the backplane, and a power supply module is installed on the front side of the backplane.
- On the AR2240, the backplane is in the middle of the chassis, cards are installed on the front and rear sides of the backplane, and a power supply unit is installed on the front side of the backplane.
- On the AR3260, the backplane is in the middle of the chassis, cards are installed on the front and rear sides of the backplane, and a power supply unit is installed on the front side of the backplane.

Figure 5-1 and **Figure 5-2** illustrates the relationships between the cards supported by the AR routers.

 **NOTE**

- On the AR1200-S, the backplane is at the bottom of the chassis, and cards are installed on the backplane.
- On the AR2220-S, the backplane is in the middle of the chassis, cards are installed on the rear side of the backplane, and a power supply module is installed on the front side of the backplane.

Figure 5-1 Relationships between cards on the AR1200-S

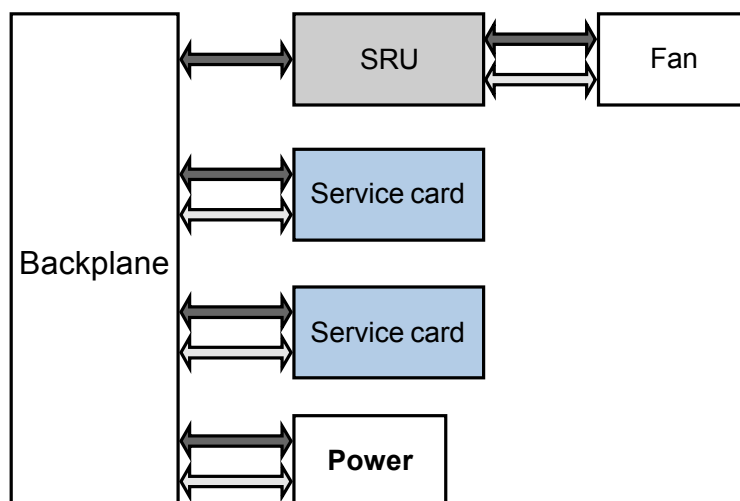
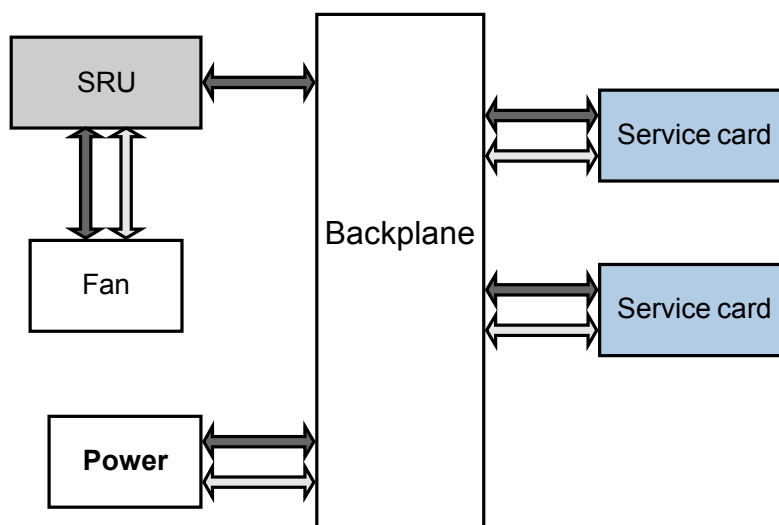

Figure 5-2 Relationships between cards on the AR2220-S



5.1.2 Interface Numbering

This section describes the interface numbering scheme on the AR routers.

On the AR routers, interfaces are numbered in the format of slot ID/subcard ID/interface sequence number.

- Slot ID

The slot ID specifies the ID of the slot where a card resides.

- The SRU of the AR1200-S and 2220-S is integrated with the chassis, so the slot ID is fixed as 0.
- When slots need to be combined into one slot, the greater slot ID is used as the new slot ID. For example, when slot 1 and slot 2 are combined, slot ID 2 is used as the new slot ID.

- Subcard ID

The subcard ID specifies the ID of a subcard. The cards of AR routers series routers do not support subcards. Therefore, the subcard ID of the AR routers is fixed as 0.

- Interface sequence number

The interface sequence number indicates the number of each interface on a card.

- There is only one row of interfaces on the interface card. These interfaces are numbered from left to right starting with 0.

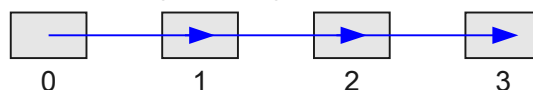

- There are two rows of interfaces on the interface card. These interfaces are numbered from bottom to top and left to right starting with 0.

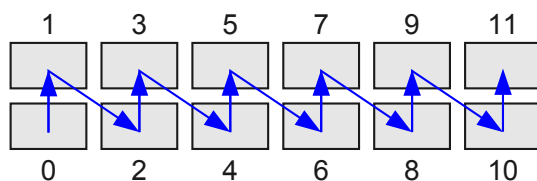

5.1.3 Card Dimensions

This section explains the conventions for measuring cards and lists the dimensions of SIC, WSIC, XSIC card.

Figure 5-3 illustrates the dimensions of a card.

Figure 5-3 Card dimensions description

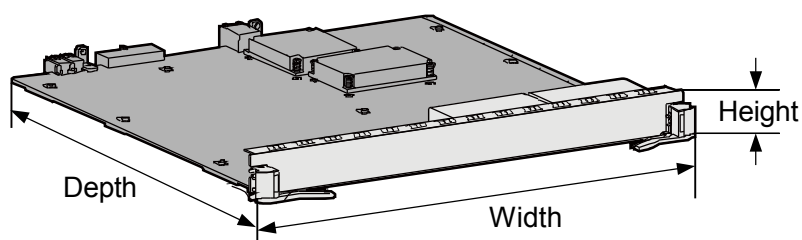

NOTE

The card dimensions are defined as follows:

- Depth: the distance between the handle and the end of Printed Circuit Board (PCB)
- Width: the longest distance between the tops of two handles
- Height: the height of the ejector lever

Figure 5-4 shows the cards supported by the AR routers and **Table 5-1** lists the card dimensions.

Figure 5-4 Card appearances



Table 5-1 Card dimensions

Card Type	Dimensions (Depth x Width x Height)
SIC card	223.5 mm x 100.1 mm x 19.82 mm (8.8 in. x 3.94 in. x 0.78 in.)
WSIC card	223.5 mm x 201 mm x 19.82 mm (8.8 in. x 7.92 in. x 0.78 in.)
XSIC card	223.5 mm x 201 mm x 40.14 mm (8.8 in. x 7.92 in. x 1.58 in.)

5.2 WLAN Subcard

WLAN subcards are Wi-Fi modules.

5.2.1 Functions and Applications

Functions

- WLAN subcards provide Wi-Fi interfaces. Wi-Fi interfaces comply with IEEE 802.11n, 802.11g, and 802.11b, and each of these interfaces provides a maximum of 300 Mbit/s transmission rate.
- WLAN subcards provide a high wireless performance and reliability, and large coverage scope using the multiple-input and multiple-output (MIMO) technology.
- WLAN subcards support 64/128/152-bit WEP encryption, WPA/WPA2 encryption, and WPA-PSK/WPA2-PSK encryption to provide secure data transmission.

Applications

A WLAN subcard has a dedicated WLAN slot on the AR routers.

5.2.2 Technical Specifications

Table 5-2 describes the technical specifications of the WLAN subcard.

Table 5-2 Technical specifications of the WLAN subcard

Item	Specification
Maximum power consumption	7.24 W

5.3 Ethernet LAN Interface Card

This section describes the types, functions, applications, appearance, interfaces, and technical specifications of the Ethernet LAN interface card.

5.3.1 8FE1GE-8-Port 100BASE-RJ45 and 1-Port 1000BASE-RJ45 L2/L3 Ethernet Interface Card

The 8FE1GE is the 8-port 100M+1-port 1000M Ethernet electrical interface card (RJ45). It implements the 9-channel Ethernet Layer 2 and Layer 3 switching functions.

Functions and Applications

Functions

The 8FE1GE provides eight FE electrical interfaces and one GE electrical interface to implement data access and line-speed switching.

- When category 5 twisted pairs (straight-through cables or crossover cables) are used, the maximum transmission distance is 100 meters.
- When category 5 twisted pairs (straight-through cables or crossover cables) are used, 100 Mbit/s line-speed forwarding is supported between the eight FE interfaces.
- The eight FE interfaces work at 10 Mbit/s or 100 Mbit/s, in auto-sensing mode. The GE interface works at 10/100/1000 Mbit/s, in auto-sensing mode.
- These interfaces support the half duplex mode and full duplex mode. The full duplex mode is most commonly used.

Applications

The 8FE1GE can be installed into the WSIC slots of the AR1200-S and AR2220-S, On the AR1200-S, two SIC slots are combined into one WSIC slot.

Panel and Interfaces

Figure 5-5 shows the appearance of the 8FE1GE.

Figure 5-5 Appearance of the 8FE1GE

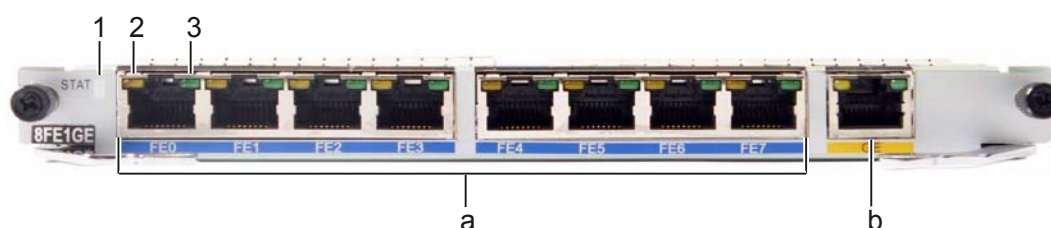

Buttons and Indicators on the Panel

Table 5-3 describes the buttons and indicators on the 8FE1GE panel.

Table 5-3 Buttons and indicators on the 8FE1GE panel

Number in Figure 5-5	Indicator	Color	Description
1	STAT	Green	If the indicator blinks once 2s (0.5 Hz), the system is running properly. If the indicator blinks once 0.25s (4 Hz), the system is powering on or restarting.
		Red	If the indicator is red, a fault that affects services occurs and cannot be rectified automatically. The fault needs to be rectified manually.
		Off	If the indicator is off, the software is not running or is being reset.
2 and 3	FE/GE interface indicators: <ul style="list-style-type: none"> ● The LINK indicator is in green. ● The ACT indicator is in yellow. 	Green	If the indicator is steady on, a link has been established. If the indicator is off, no link is established.
		Yellow	If the indicator is blinking, data is being transmitted or received. If the indicator is off, no data is being transmitted or received.

Interfaces

Table 5-4 describes the types and functions of interfaces on the 8FE1GE.

Table 5-4 Types and functions of interfaces on the 8FE1GE

Letter in Figure 5-5	Name	Quantity	Description	Cable Type
a	10BASE-TX/ 100BASE-TX electrical interface	8	The 8FE1GE provides eight FE electrical interfaces to transmit and receive FE services.	6.5 Network Cable
b	1000BASE-T electrical interface	1	The 8FE1GE provides one GE electrical interface to transmit and receive GE services.	

Interface Attributes

Table 5-5 Attributes of 10BASE-TX/100BASE-TX electrical interfaces

Item	Description
Connector type	RJ45
Interface attribute	MDI/MDIX NOTE <ul style="list-style-type: none"> ● The interfaces of most network cards are medium dependent interfaces (MDIs). ● MDIX interfaces are usually used on hubs or LAN switches.
Standards compliance	IEEE802.3, IEEE802.3u, IEEE802.3ab
Frame format	Ethernet_II, Ethernet_SAP, or Ethernet_SNAP
Network layer protocol	IP

Table 5-6 Attributes of 1000BASE-T electrical interfaces

Item	Description
Connector type	RJ45
Interface attribute	MDI/MDIX NOTE <ul style="list-style-type: none"> ● The interfaces of most network cards are medium dependent interfaces (MDIs). ● MDIX interfaces are usually used on hubs or LAN switches.
Standards compliance	IEEE802.3, IEEE802.3u, IEEE802.3ab
Frame format	Ethernet_II, Ethernet_SAP, or Ethernet_SNAP
Network layer protocol	IP

Technical Specifications

Table 5-7 describes the technical specifications of the 8FE1GE.

Table 5-7 Technical specifications of the 8FE1GE

Item	Specification
Dimensions (depth x width x height)	223.5 mm x 201 mm x 19.82 mm (8.8 in. x 7.92 in. x 0.78 in.)
Maximum power consumption	12.036 W
Weight	0.6 kg (1.33 lb)

5.3.2 24GE-24-Port 1000BASE-RJ45 L2/L3 Ethernet Interface Card

The 24GE is the 24-port 1000M Ethernet electrical interface card (RJ45). It implements the 24-channel Ethernet Layer 2 and Layer 3 switching functions.

Functions and Applications

Functions

The 24GE provides 24 GE electrical interfaces to implement data access and line-speed switching.

- When category 5 twisted pairs (straight-through cables or crossover cables) are used, the maximum transmission distance is 100 meters.
- When category 5 twisted pairs (straight-through cables or crossover cables) are used, 1000 Mbit/s line-speed forwarding is supported between the 24 GE interfaces.
- These interfaces work in 10/100/1000 Mbit/s auto-sensing mode.
- These interfaces support the half duplex mode and full duplex mode. The full duplex mode is most commonly used.

Applications

The 24GE can be installed into the XSIC slot on the AR2220-S. On the AR2220-S, two WSIC slots are combined into one XSIC slot.

Panel and Interfaces

[Figure 5-6](#) shows the appearance of the 24GE.

Figure 5-6 Appearance of the 24GE

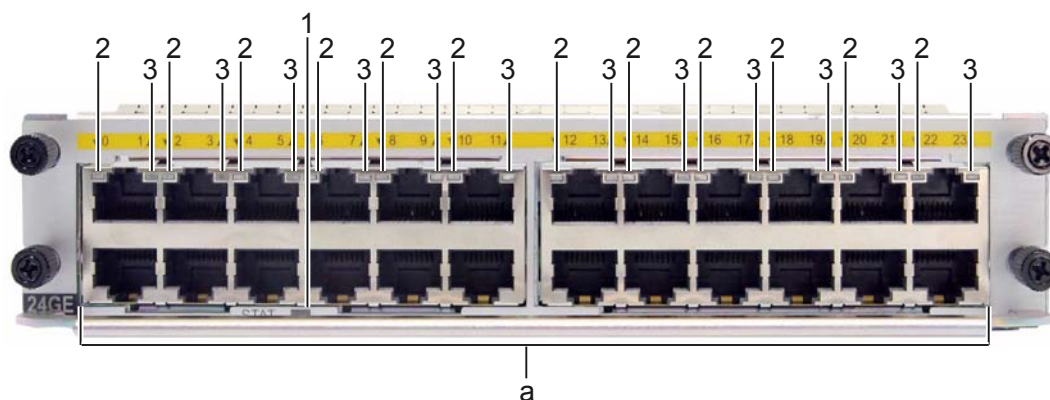

Buttons and Indicators on the Panel

Table 5-8 describes the buttons and indicators on the 24GE panel.

Table 5-8 Buttons and indicators on the 24GE panel

Number in Figure 5-6	Indicator	Color	Description
1	STAT	Green	If the indicator blinks once 2s (0.5 Hz), the system is running properly. If the indicator blinks once 0.25s (4 Hz), the system is powering on or restarting.
		Red	If the indicator is red, a fault that affects services occurs and cannot be rectified automatically. The fault needs to be rectified manually.
		Off	If the indicator is off, the software is not running or is being reset.
2: indicators of interfaces in the second row	LINK	Green	If the indicator is steady on, a link has been established.
3: indicators of interfaces in the first row			If the indicator is blinking, data is being transmitted or received.
			If the indicator is off, the link is not connected.

Interfaces

Table 5-9 describes the types and functions of interfaces on the 24GE.

Table 5-9 Types and functions of interfaces on the 24GE

Letter in Figure 5-6	Name	Quantity	Description	Cable Type
a	1000BASE-T electrical interface	24	The 24GE provides 24 GE electrical interfaces to transmit and receive GE services.	6.5 Network Cable

Interface Attributes

Table 5-10 Attributes of 1000BASE-T electrical interfaces

Item	Description
Connector type	RJ45
Interface attribute	MDI/MDIX NOTE <ul style="list-style-type: none">The interfaces of most network cards are medium dependent interfaces (MDIs).MDIX interfaces are usually used on hubs or LAN switches.
Standards compliance	IEEE802.3, IEEE802.3u, IEEE802.3ab
Frame format	Ethernet_II, Ethernet_SAP, or Ethernet_SNAP
Network layer protocol	IP

Technical Specifications

[Table 5-11](#) describes the technical specifications of the 24GE.

Table 5-11 Technical specifications of the 24GE

Item	Specification
Dimensions (depth x width x height)	223.50 mm x 201.00 mm x 40.14 mm (8.8 in. x 7.92 in. x 1.58 in.)
Maximum power consumption	25 W
Weight	0.85 kg (1.88 lb)

5.4 WAN Interface Card

This section describes the types, functions, applications, appearance, interfaces, and technical specifications of the WAN interface card.

5.4.1 1GEC (1-Port-GE Combo WAN Interface Card)

1GEC is a 1-port 1000M Ethernet optical and electrical Combo interface card (RJ45, SFP). Only one of the optical interface and electrical interface can be used at a time.

1GEC stands for:

- 1: one interface
- GE: 1000M Ethernet
- C: Combo interface

Functions and Applications

Functions

The 1GEC provides one GE optical and electrical Combo interface to implement data access and line-speed switching.

- The Combo interface sends, receives, and processes GE data traffic.
- The electrical interface works at 10/100/1000 Mbit/s in auto-sensing mode.
- The optical interface works at 100/1000 Mbit/s in auto-sensing mode.

Applications

The 1GEC is installed into the SIC slot of the AR1200-S and AR2220-S.

Panel and Interfaces

[Figure 5-7](#) shows the appearance of the 1GEC panel.

Figure 5-7 Appearance of the 1GEC panel

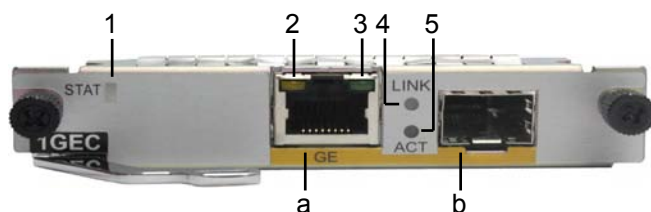

Buttons and Indicators on the Panel

[Table 5-12](#) describes the buttons and indicators on the 1GEC panel.

Table 5-12 Buttons and indicators on the 1GEC panel

Number in Figure 5-7	Indicator	Color	Description
1	STAT	Green	If the indicator blinks once 2s (0.5 Hz), the system is running properly. If the indicator blinks once 0.25s (4 Hz), the system is powering on or restarting.
		Red	If the indicator is red, a fault that affects services occurs and cannot be rectified automatically. The fault needs to be rectified manually.
		Off	If the indicator is off, the software is not running or is being reset.
2 and 3	GE interface indicators: <ul style="list-style-type: none"> ● The LINK indicator is in green. ● The ACT indicator is in yellow. 	Green	If the indicator is steady on, a link has been established. If the indicator is off, no link is established.
		Yellow	If the indicator is blinking, data is being transmitted or received. If the indicator is off, no data is being transmitted or received.
		Green	If the indicator is steady on, a link has been established. If the indicator is off, no link is established.
		Yellow	If the indicator is blinking, data is being transmitted or received. If the indicator is off, no data is being transmitted or received.
4 and 5	SFP interface indicators: <ul style="list-style-type: none"> ● The LINK indicator is in green. ● The ACT indicator is in yellow. 	Green	If the indicator is steady on, a link has been established. If the indicator is off, no link is established.
		Yellow	If the indicator is blinking, data is being transmitted or received. If the indicator is off, no data is being transmitted or received.
		Green	If the indicator is steady on, a link has been established. If the indicator is off, no link is established.
		Yellow	If the indicator is blinking, data is being transmitted or received. If the indicator is off, no data is being transmitted or received.

Interfaces

Table 5-13 describes the types and functions of interface on the 1GEC.

Table 5-13 Types and functions of the interface on the 1GEC

Letter in Figure 5-7	Name	Quantity	Description	Cable Type
a	1000BASE-T electrical interface	1	The 1GEC provides one GE electrical interface to transmit and receive GE services. NOTE Only one of the optical interface and electrical interface can be used at a time.	6.5 Network Cable
b	1000BASE-X optical interface	1	The 1GEC provides one GE optical interface to transmit and receive GE services.	6.6 Optical Fiber

Interface Attributes

Table 5-14 Attributes of 1000BASE-T electrical interfaces

Item	Description
Connector type	RJ45
Interface attribute	MDI/MDIX NOTE <ul style="list-style-type: none"> The interfaces of most network cards are medium dependent interfaces (MDIs). MDIX interfaces are usually used on hubs or LAN switches.
Standards compliance	IEEE802.3, IEEE802.3u, IEEE802.3ab
Frame format	Ethernet_II, Ethernet_SAP, or Ethernet_SNAP
Network layer protocol	IP

Table 5-15 Attributes of the SFP optical module (100/1000 Mbit/s) supported by the GE optical interface

Attribute	Description						
Transmission distance	500 m	10 km	10 km (single-mode bidirectional fiber)	40 km	40 km	80 km	100 km

Attribute	Description							
Center wavelength	850 nm	1310 nm	Tx: 1310 nm Rx: 1490 nm	Tx: 1490 nm Rx: 1310 nm	1310 nm	1550 nm	1550 nm	1550 nm
Transmitting power	-9.5 dBm to -2.5 dBm	-9.0 dBm to -3.0 dBm	-9.0 dBm to -3.0 dBm	-9.0 dBm to -3.0 dBm	-5.0 dBm to 0 dBm	-5.0 dBm to 0 dBm	-2.0 dBm to 5.0 dBm	0 dBm to 5 dBm
Receiver sensitivity	-17.0 dBm	-20.0 dBm	-19.5 dBm	-19.5 dBm	-23 dBm	-22 dBm	-23.0 dBm	-30.0 dBm
Overload optical power	0 dBm	-3.0 dBm	-3.0 dBm	-3.0 dBm	-3.0 dBm	-3.0 dBm	-3.0 dBm	-9.0 dBm
Extinction ratio	9 dB	9 dB	6 dB	6 dB	9 dB	8.5 dB	9 dB	8 dB
Fiber type	Multi-mode	Single-mode						

Technical Specifications

Table 5-16 describes the technical specifications of the 1GEC.

Table 5-16 Technical specifications of the 1GEC

Item	Specification
Dimensions (depth x width x height)	223.5 mm x 100.1 mm x 19.82 mm (8.8 in. x 3.94 in. x 0.78 in.)
Maximum power consumption	2.28 W
Weight	0.25 kg (0.55 lb)

5.4.2 2FE-2-Port-FE WAN Interface Card

The 2FE is the 2-port 100M Ethernet electrical interface card (RJ45).

Functions and Applications

Functions

The 2FE provides two FE electrical interfaces to implement data access and line-speed switching.

- When category 5 twisted pairs (straight-through cables or crossover cables) are used, the maximum transmission distance is 100 meters.
- Two FE electrical interfaces can be bound to function as an upstream interface at the line rate of 200 Mbit/s.
- The two FE interfaces work in 10/100 Mbit/s auto-sensing mode.
- These interfaces support the half duplex mode and full duplex mode. The full duplex mode is most commonly used.

Applications

The 2FE can be installed into the SIC slot of the AR1200-S, AR2220-S.

Panel and Interfaces

Figure 5-8 shows the appearance of the 2FE.

Figure 5-8 Appearance of the 2FE

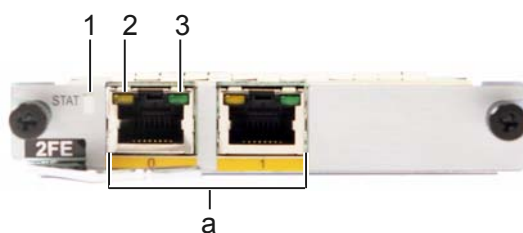

Buttons and Indicators on the Panel

Table 5-17 describes the buttons and indicators on the 2FE panel.

Table 5-17 Buttons and indicators on the 2FE panel

Number in Figure 5-8	Indicator	Color	Description
1	STAT	Green	If the indicator blinks once 2s (0.5 Hz), the system is running properly. If the indicator blinks once 0.25s (4 Hz), the system is powering on or restarting.
		Red	If the indicator is red, a fault that affects services occurs and cannot be rectified automatically. The fault needs to be rectified manually.
		Off	If the indicator is off, the software is not running or is being reset.
2 and 3	FE interface indicators: <ul style="list-style-type: none"> ● The LINK indicator is in green. ● The ACT indicator is in yellow. 	Green	If the indicator is steady on, a link has been established. If the indicator is off, no link is established.
		Yellow	If the indicator is blinking, data is being transmitted or received. If the indicator is off, no data is being transmitted or received.

Interfaces

Table 5-18 describes the types and functions of interfaces on the 2FE.

Table 5-18 Types and functions of interfaces on the 2FE

Letter in Figure 5-8	Name	Quantity	Description	Cable Type
a	FE electrical interface	2	The 2FE provides two FE electrical interfaces to transmit and receive FE services.	6.5 Network Cable

Interface Attributes

Table 5-19 Attributes of 10BASE-TX/100BASE-TX electrical interfaces

Item	Description
Connector type	RJ45
Interface attribute	MDI/MDIX NOTE <ul style="list-style-type: none"> The interfaces of most network cards are medium dependent interfaces (MDIs). MDIX interfaces are usually used on hubs or LAN switches.
Standards compliance	IEEE802.3, IEEE802.3u, IEEE802.3ab
Frame format	Ethernet_II, Ethernet_SAP, or Ethernet_SNAP
Network layer protocol	IP

Technical Specifications

Table 5-20 describes the technical specifications of the 2FE.

Table 5-20 Technical specifications of the 2FE

Item	Specification
Dimensions (depth x width x height)	223.5 mm x 100.1 mm x 19.82 mm (8.8 in. x 3.94 in. x 0.78 in.)
Maximum power consumption	3.01 W
Weight	0.3 kg (0.66 lb)

5.4.3 1E1T1-M/2E1T1-M-1/2 Port-Channelized E1/T1/PRI/VE1 Multifunctional Interface Card

The 1E1T1-M/2E1T1-M is the E1/T1/PRI/VE1 processing unit on the AR routers and provides one or two E1/T1/PRI/VE1 interfaces. Primary Rate Interface (PRI) indicates ISDN primary rate interfaces.

 **NOTE**

- 1/2: indicates one or two interfaces.
- E1: indicates E1 interfaces.
- T1: indicates T1 interfaces.
- M: indicates multiflex trunks.
- VE1: indicates voice E1 interfaces.

Table 5-21 lists the number of interfaces on the 1E1T1-M and 2E1T1-M.

Table 5-21 Number of interfaces on the 1E1T1-M and 2E1T1-M

Card Name	Quantity of Interfaces
1E1T1-M	1
2E1T1-M	2

2E1T1-M cards have two types: SIC and WSIC. **Table 5-22** lists the slots where the SIC card and WSIC card are installed.

Table 5-22 Slots of 2E1T1-M SIC and WSIC cards

Card	Slot
2E1T1-M (SIC)	SIC slot
2E1T1-M (WSIC)	WSIC slot or XSIC slot NOTE In an XSIC slot, the WSIC card is installed in the lower part of the slot. The WSIC card uses the XSIC slot ID as its own slot ID.

Functions and Applications

Functions

The 1E1T1-M/2E1T1-M provides the following functions:

- Sends, receives, and processes E1/T1 data traffic.
- Provides CE1/T1 access.
- Provides the ISDN PRI function.

Applications

1E1T1-M/2E1T1-M(SIC) can be installed into the SIC slot of the AR1200-S and AR2220-S.

2E1T1-M(WSIC) is installed in a WSIC or XSIC slot on the AR2220-S.

Panel and Interfaces

Figure 5-9 shows the appearance of the 1E1T1-M.

Figure 5-9 Appearance of the 1E1T1-M

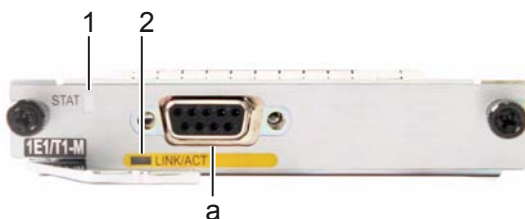

Figure 5-10 shows the appearance of the 2E1T1-M (SIC).

Figure 5-10 Appearance of the 2E1T1-M (SIC)

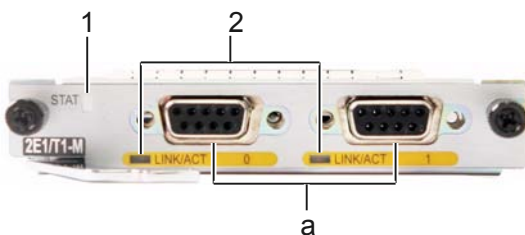

Figure 5-11 shows the appearance of the 2E1T1-M (WSIC).

Figure 5-11 Appearance of the 2E1T1-M (WSIC)



Buttons and Indicators on the Panel

Table 5-23 describes the buttons and indicators on the 1E1T1-M/2E1T1-M panel.

Table 5-23 Buttons and indicators on the 1E1T1-M/2E1T1-M panel

Number in Figure 5-9, Figure 5-10, Figure 5-11	Indicator	Color	Description
1	STAT	Green	If the indicator blinks once 2s (0.5 Hz), the system is running properly. If the indicator blinks once 0.25s (4 Hz), the system is powering on or restarting.
		Red	If the indicator is red, a fault that affects services occurs and cannot be rectified automatically. The fault needs to be rectified manually.
		Off	If the indicator is off, the software is not running or is being reset.
2	LINK/ACT	Green	If the indicator is steady on, a link has been established.
		Yellow (The indicator is in green and blinks red.)	If the indicator is in green and blinks red, data is being transmitted or received.
		Off	If the indicator is off, there is no connection.

Interfaces

Table 5-24 describes the types and functions of interfaces on the 1E1T1-M/2E1T1-M.

Table 5-24 Types and functions of interfaces on the 1E1T1-M/2E1T1-M

Letter in Figure 5-9, Figure 5-10, Figure 5-11	Name	Quantity	Description	Cable Type
a	DB9	1E1T1-M: 1 2E1T1-M: 2	75-ohm or 120-ohm E1 cable or 100-ohm T1 cable	6.7 E1/T1 Trunk Cables

Interface Attributes

Table 5-25 Attributes of channelized E1 interfaces

Attribute	Description
Connector type	DB9
Standards compliance	G.703 or G.704
Transmission rate	2.048 Mbit/s
Cable type	E1 75-ohm unbalanced coaxial cable E1 120-ohm balanced twisted pair cable E1 trunk cable extension
Working mode	CE1, ISDN PRI, or VE1
Function	Backup Terminal access ISDN PRI

Table 5-26 Attributes of channelized T1 interfaces

Attribute	Description
Connector type	DB9
Standards compliance	G.703 or G.704
Transmission rate	1.544 Mbit/s
Cable type	T1 100-ohm coaxial cable
Working mode	CT1, ISDN PRI, or VT1
Function	Backup Terminal access ISDN PRI

Technical Specifications

Table 5-27 describes the technical specifications of the 1E1T1-M/2E1T1-M.

Table 5-27 Technical specifications of the 1E1T1-M/2E1T1-M

Item	Specification
Dimensions (depth x width x height)	1E1T1-M/2E1T1-M (SIC): 223.5 mm x 100.1 mm x 19.82 mm (8.8 in. x 3.94 in. x 0.78 in.) 2E1T1-M (WSIC): 223.5 mm x 201 mm x 19.82 mm (8.8 in. x 7.92 in. x 0.78 in.)
Maximum power consumption	7 W
Weight	0.3 kg (0.66 lb)

5.4.4 1E1T1-F/2E1T1-F (1/2-Port-Fractional Channelized E1/T1 WAN Interface Card)

The 1E1T1-F/2E1T1-F is the E1/T1 processing unit on the AR routers and provides one or two E1/T1 interfaces.

 **NOTE**

1E1T1-F/2E1T1-F stands for:

- 1/2: one or two interfaces
- E1: E1 interface
- T1: T1 interface
- F: fractional E1

Table 5-28 lists the number of interfaces on the 1E1T1-F and 2E1T1-F.

Table 5-28 Number of interfaces on the 1E1T1-F and 2E1T1-F

Card Name	Quantity of Interfaces
1E1T1-F	1
2E1T1-F	2

Functions and Applications

Functions

The 1E1T1-F/2E1T1-F sends, receives, and processes E1/T1 data traffic. **Table 5-29** describes the differences in functions provided by the 1E1T1-F/2E1T1-F and 1E1T1-M/2E1T1-M.

Table 5-29 Differences in functions provided by the 1E1T1-F/2E1T1-F and 1E1T1-M/2E1T1-M

Card Name	Fractional E1 Mode	Whether to Support the PRI Mode
1E1T1-F/2E1T1-F	Timeslots of an E1/T1 interface can only be bundled into one channel at a rate of $n \times 64$ kbit/s (n specifies the number of bundled timeslots and ranges from 1 to 31).	No
1E1T1-M/2E1T1-M	Timeslots of an E1/T1 interface can be bundled into multiple channels.	Yes

Applications

The 1E1T1-F/2E1T1-F is installed into the SIC slot of the AR1200-S and AR2220-S.

Panel and Interfaces

The 1E1T1-F and 1E1T1-M panels are identical except for having different silkscreens. [Figure 5-9](#) shows the appearance of the 1E1T1-F panel.

The 2E1T1-F and 2E1T1-M panels are identical except for having different silkscreens. [Figure 5-10](#) shows the appearance of the 2E1T1-F panel.

Buttons and Indicators on the Panel

[Table 5-23](#) describes the buttons and indicators on the 1E1T1-F/2E1T1-F panel.

Interfaces

[Table 5-24](#) describes the types and functions of interfaces on the 1E1T1-F/2E1T1-F.

Interface Attributes

Table 5-30 Attributes of unchannelized E1 interfaces

Attribute	Description
Connector type	DB9
Standards compliance	G.703 or G.704
Transmission rate	2.048 Mbit/s

Attribute	Description
Cable type	E1 75-ohm unbalanced coaxial cable E1 120-ohm balanced twisted pair cable E1 trunk cable extension
Working mode	Unchannelized E1
Function	Backup Terminal access

Table 5-31 Attributes of unchannelized T1 interfaces

Attribute	Description
Connector type	DB9
Standards compliance	G.703 or G.704
Transmission rate	1.544 Mbit/s
Cable type	T1 100-ohm coaxial cable
Working mode	Unchannelized T1
Function	Backup Terminal access

Technical Specifications

Table 5-32 describes the technical specifications of the 1E1T1-F/2E1T1-F.

Table 5-32 Technical specifications of the 1E1T1-F/2E1T1-F

Item	Specification
Dimensions (depth x width x height)	223.5 mm x 100.1 mm x 19.82 mm (8.8 in. x 3.94 in. x 0.78 in.)
Maximum power consumption	7 W
Weight	0.3 kg (0.66 lb)

5.4.5 1SA/2SA-1/2-Port-Synchronous/Asynchronous WAN Interface Card

The 1SA/2SA is the 1-port/2-port synchronous/asynchronous serial interface module on the AR routers.

NOTE

- 1/2: indicates one interface or two interfaces.
- S: indicates synchronous serial interface.
- A: indicates asynchronous serial interface.

Table 5-33 lists the number of interfaces on the 1SA and 2SA.

Table 5-33 Number of interfaces on the 1SA and 2SA

Card Name	Quantity of Interfaces
1SA	1
2SA	2

Functions and Applications

Functions

The 1SA/2SA provides the following functions:

- A synchronous serial interface can function as a DCE or DTE. It supports multiple physical layer protocols, such as V.24, V.35, and X.21, but does not support X.21 DCE. The maximum rate of V.24 is 64 kbit/s and V.35 is 2.048 Mbit/s.
- An asynchronous serial interface supports the RS232 protocol and provides a maximum transmission rate of 115.2 kbit/s.
- The 1SA/2SA provides system management channels by using in-band GE channels and implements in-service upgrade by using system management channels.
- The system powers on or off the 1SA/2SA and monitors the current of the 1SA/2SA; the backplane provides 12 V voltage for the 1SA/2SA.
- The 1SA/2SA is hot swappable.

Applications

1SA/2SA can be installed into the SIC slot of the AR1200-S, and AR2220-S.

Panel and Interfaces

Figure 5-12 shows the appearance of the 1SA.

Figure 5-12 Appearance of the 1SA

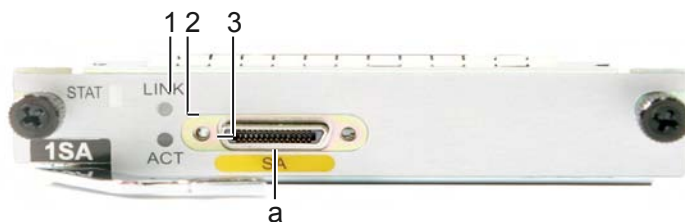
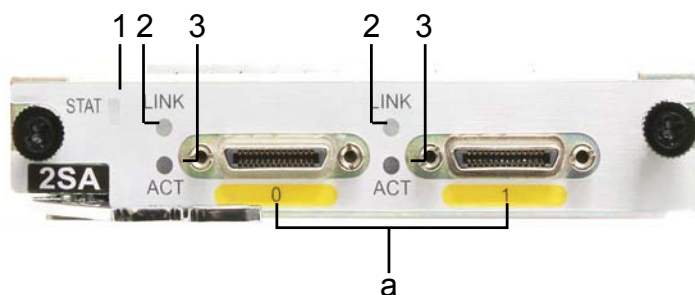

Figure 5-13 shows the appearance of the 2SA.

Figure 5-13 Appearance of the 2SA



Buttons and Indicators on the Panel

Table 5-34 describes the buttons and indicators on the 1SA/2SA panel.

Table 5-34 Buttons and indicators on the 1SA/2SA panel

Number in Figure 5-12 and Figure 5-13	Indicator	Color	Description
1	STAT	Green	If the indicator blinks once 2s (0.5 Hz), the system is running properly. If the indicator blinks once 0.25s (4 Hz), the system is powering on or restarting.
		Red	If the indicator is red, a fault that affects services occurs and cannot be rectified automatically. The fault needs to be rectified manually.

Number in Figure 5-12 and Figure 5-13	Indicator	Color	Description
		Off	If the indicator is off, the software is not running or is being reset.
2 and 3	Synchronous/ Asynchronous serial interface indicators: <ul style="list-style-type: none"> ● The LINK indicator is in green. ● The ACT indicator is in yellow. 	Green	If the indicator is steady on, a link has been established.
			If the LINK indicator is off, the link is not connected.
		Yellow	If the indicator is blinking, data is being transmitted or received.
			If the ACT indicator is off, no data is transmitted or received.

Interfaces

Table 5-35 describes the types and functions of interfaces on the 1SA/2SA.

Table 5-35 Types and functions of interfaces on the 1SA/2SA

Letter in Figure 5-12 and Figure 5-13	Name	Quantity	Description	Cable Type
a	DB28	1SA: 1 2SA: 2	The synchronous/asynchronous serial interface cable is selected according to attributes of the connected line.	6.8 Synchronous/Asynchronous Serial Interface Cables

Interface Attributes

Table 5-36 Attributes of synchronous/asynchronous serial interfaces

Attribute	Description		
	Synchronous Serial Interface		Asynchronous Serial Interface
Connector type	DB28		
Standards compliance and working mode	<ul style="list-style-type: none"> ● V.24 DTE ● V.24 DCE 	<ul style="list-style-type: none"> ● V.35 DTE ● V.35 DCE ● X.21 DTE ● RS449 DTE ● RS449 DCE ● RS530 DTE ● RS530 DCE 	RS232
Minimum baud rate (bit/s)	1200	1200	600
Maximum baud rate (bit/s)	64 k	2.048 M	115.2 k
Cable type	<ul style="list-style-type: none"> ● V.24 DTE cable ● V.24 DCE cable ● V.35 DTE cable ● V.35 DCE cable ● X.21 DTE cable ● RS449 DTE cable ● RS449 DCE cable ● RS530 DTE cable ● RS530 DCE cable 		
Function	DDN leased line	<ul style="list-style-type: none"> ● Modem dial-up ● Backup 	
	Terminal access	<ul style="list-style-type: none"> ● Asynchronous leased line ● Terminal access 	

Technical Specifications

Table 5-37 describes the technical specifications of the 1SA/2SA.

Table 5-37 Technical specifications of the 1SA/2SA

Item	Specification
Dimensions (Depth x Width x Height)	223.5 mm x 100.1 mm x 19.82 mm (8.8 in. x 3.94 in. x 0.78 in.)
Maximum power consumption	<ul style="list-style-type: none"> ● 1SA: 10 W ● 2SA: 11.7 W
Weight	0.3 kg (0.66 lb)

5.4.6 8AS (8-Port-Asynchronous WAN Interface Card)

The 8AS is an 8-port asynchronous serial interface module on the AR routers.

NOTE

8AS stands for:

- 8: eight interfaces
- AS: asynchronous serial interface

Functions and Applications

Functions

The 8AS sends, receives, and processes asynchronous data traffic.

- Supports a maximum of 115.2 kbit/s transmission rate for each asynchronous serial interface.
- Supports terminal access and asynchronous leased lines.
- Functions as a dialup access server for small and medium-sized ISPs when asynchronous serial interfaces are used for dialup.

Applications

The 8AS is installed into the WSIC slot of the AR1200-S and AR2220-S. On the AR1200-S, a WSIC slot consists of two SIC slots.

Panel and Interfaces

Figure 5-14 shows the appearance of the 8AS panel.

Figure 5-14 Appearance of the 8AS panel

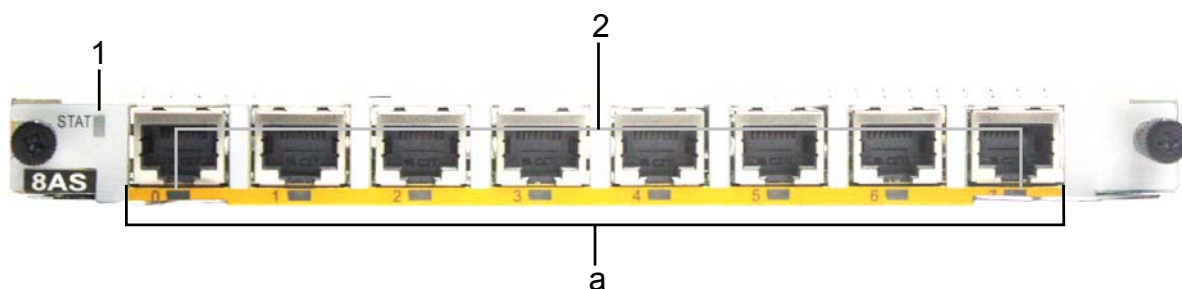

Buttons and Indicators on the Panel

Table 5-38 describes the buttons and indicators on the 8AS panel.

Table 5-38 Buttons and indicators on the 8AS panel

Number in Figure 5-14	Indicator	Color	Description
1	STAT	Green	If the indicator blinks once 2s (0.5 Hz), the system is running properly. If the indicator blinks once 0.25s (4 Hz), the system is powering on or restarting.
		Red	If the indicator is red, a fault that affects services occurs and cannot be rectified automatically. The fault needs to be rectified manually.
		Off	If the indicator is off, the software is not running or is being reset.
2	LINK (interface status indicator)	Green	If the indicator is steady on, a link has been established.
			If the indicator is off, no link is established.

Interfaces

Table 5-39 describes the types and functions of interfaces on the 8AS.

Table 5-39 Types and functions of interfaces on the 8AS

Letter in Figure 5-14	Name	Quantity	Description	Cable Type
a	RJ45	8	Interfaces on the 8AS send, receive, and process asynchronous data traffic using customized RJ45 cables.	6.12 8AS Cable

Interface Attributes

Table 5-40 Attributes of asynchronous serial interfaces

Attribute	Description
Connector type	RJ45
Standards compliance and working mode	RS232
Minimum baud rate (bit/s)	300
Maximum baud rate (bit/s)	115.2 k
Cable type	Customized RJ45 cable
Function	<ul style="list-style-type: none"> ● Modem dial-up ● Backup ● Asynchronous leased line ● Terminal access

Technical Specifications

Table 5-41 describes the technical specifications of the 8AS.

Table 5-41 Technical specifications of the 8AS

Item	Specification
Dimensions (depth x width x height)	223.5 mm x 201 mm x 19.82 mm (8.8 in. x 7.92 in. x 0.78 in.)
Maximum power consumption	8.9 W
Weight	0.6 kg (1.32 lb)

5.4.7 1BST (1-Port-ISDN S/T WAN Interface Card)

The 1BST is the ISDN module on the AR routers and provides one ISDN S/T interface, which transmits data services.

The 1BST transmits, receives, and processes 1-channel ISDN BRI S/T data flow.

Functions and Applications

Functions

The 1BST provides one ISDN S/T interface for data access.

The 1BST consists of the following modules:

- CPU control module: manages the system and loads programs.
- CPLD logic module: provides the working clock and reset signals for the chip, controls the service port status, and monitors the board clock.
- ISDN chip module: provides S/T interface access, supports TE mode, and provides parallel interfaces and serial interfaces.
- Power supply module: conducts power from backplane to card.
- Clock module: provides the working clock for the CPU and working modules.

Applications

The 1BST is installed into the SIC slot of the AR1200-S and AR2220-S.

Panel and Interfaces

Figure 5-15 shows the appearance of the 1BST panel.

Figure 5-15 Appearance of the 1BST panel

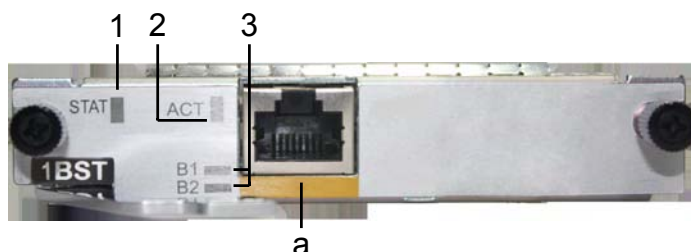

Buttons and Indicators on the Panel

Table 5-42 describes the buttons and indicators on the 1BST panel.

Table 5-42 Buttons and indicators on the 1BST panel

Number in Figure 5-15	Indicator	Color	Description
1	STAT	Green	If the indicator blinks once 2s (0.5 Hz), the system is running properly. If the indicator blinks once 0.25s (4 Hz), the system is powering on or restarting.

Number in Figure 5-15	Indicator	Color	Description
		Red	If the indicator is red, a fault that affects services occurs and cannot be rectified automatically. The fault needs to be rectified manually.
		Off	If the indicator is off, the software is not running or is being reset.
2	ACT (interface status indicator)	Green	If the indicator is steady on, the ISDN channel is activated.
			If the indicator is off, the ISDN channel is deactivated.
3	B1/B2	Green	If the indicator is blinking, the B1/B2 channel of the ISDN channel is being occupied.
			If the indicator is off, the B1/B2 channel of the ISDN channel is idle.

Interfaces

Table 5-43 describes the types and functions of interfaces on the 1BST.

Table 5-43 Types and functions of interfaces on the 1BST

Letter in Figure 5-15	Name	Quantity	Description	Cable Type
a	RJ45	1	ISDN S/T interfaces are provided.	6.10 ISDN-ST Cables

Interface Attributes

Table 5-44 ISDN S/T interface attributes

Item	Description
Connector	RJ45
Standards compliance	ITU-T I.430, Q.921, Q.931
Rate	192 kbit/s
Bandwidth	0 to 100 MHz

Item	Description
Cable	<ul style="list-style-type: none"> ● TE: standard ISDN S/T interface cables (straight-through cables) ● NT: ISDN S/T interface crossover cables

Technical Specifications

Table 5-45 describes the technical specifications of the 1BST.

Table 5-45 Technical specifications of the 1BST

Item	Specification
Dimensions (depth x width x height)	223.5 mm x 100.1 mm x 19.82 mm (8.8 in. x 3.94 in. x 0.78 in.)
Maximum power consumption	12 W
Weight	0.3 kg (0.66 lb)

5.4.8 1CPOS-155M (1-Port Channelized POS Interface Card)

1CPOS-155M provides an STM-1/OC3 optical interface to implement 63-channel E1 or 84-channel T1 transmission in compliance with SDH/SONET.

 **NOTE**

1CPOS-155M stands for:

- 1: one interface
- C: channelized
- POS: Packet Over SDH/SONET
- 155M: a rate of 155.52 Mbit/s

Functions and Applications

Functions

1CPOS-155M has the following functions:

- Supports clear channel (unframed) E1, non-channelized (framed) E1, and channelized CE1.
- Supports non-channelized (framed) T1 and channelized CT1.
- Supports the link layer protocols such as HDLC and PPP and a maximum of 1024 HDLC channels.

- Supports four SFP optical module types: short-distance multi-mode (1310 nm), mid-distance single-mode (1310 nm), long-distance single-mode (1310 nm), and ultra-long-distance single-mode (1550 nm).
- Automatically starts and loads configurations after being powered on, provides the system management function using a GE inband channel, and uses the UART serial interface as the escape channel for subcard.
- Uses the 12 V power provided by the backplane, be powered on and off by the main control board, and monitors voltage and current.
- Be hot swappable.

Applications

1CPOS-155M can be installed in a SIC slot of AR2220-S.

Panel and Interfaces

Figure 5-16 shows the appearance of the 1CPOS-155M.

Figure 5-16 Appearance of the 1CPOS-155M

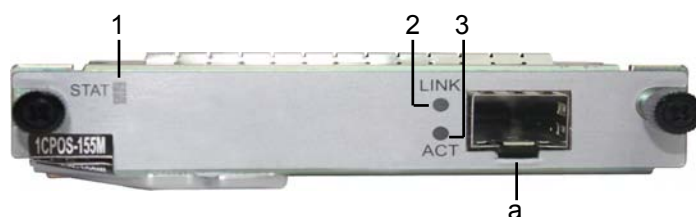

Buttons and Indicators on the Panel

Table 5-46 describes the buttons and indicators on the 1CPOS-155M panel.

Table 5-46 Buttons and indicators on the 1CPOS-155M panel

Number in Figure 5-16	Indicator	Color	Description
1	STAT	Green	If the indicator blinks once 2s (0.5 Hz), the system is running properly. If the indicator blinks once 0.25s (4 Hz), the system is powering on or restarting.
		Red	If the indicator is red, a fault that affects services occurs and cannot be rectified automatically. The fault needs to be rectified manually.

Number in Figure 5-16	Indicator	Color	Description
		Off	If the indicator is off, the software is not running or is being reset.
2	LINK	Green	If the indicator is steady on, a link has been established.
			If the indicator is off, no link is established.
3	ACT	Yellow	If the indicator is blinking, data is being transmitted or received.
			If the indicator is off, no data is being transmitted or received.

Interfaces

Table 5-47 describes the types and functions of interfaces on the 1CPOS-155M.

Table 5-47 Types and functions of interfaces on the 1CPOS-155M

Letter in Figure 5-16	Name	Quantity	Description	Cable Type
a	SFP optical interface	1	The 1CPOS-155M provides one SFP optical interface to transmit and receive SDH/SONET frames.	6.6 Optical Fiber

Interface Attributes

Table 5-48 CPOS interface attributes

Attribute	Description
Connector type	LC/PC
Optical interface attribute	Depending on the SFP optical module
Standards compliance	STM-1
Frame format	SDH/SONET

Attribute	Description
Network layer protocol	IP

Table 5-49 Attributes of the SFP optical module supported by the CPOS interface

Attribute	Description			
Transmission distance	2 km	15 km	40 km	80 km
Center wavelength	1310 nm	1310 nm	1310 nm	1550 nm
Transmitting power	-19.0 dBm to -14.0 dBm	-15.0 dBm to 8.0 dBm	-15.0 dBm to 8.0 dBm	-3.0 dBm to 0 dBm
Receiver sensitivity	-28.0 dBm	-23.0 dBm	-23.0 dBm	-32.98 dBm
Overload optical power	-14.0 dBm	-10.17 dBm	-8.0 dBm	-8.0 dBm
Extinction ratio	>10.0 dB	58.86 dB	14.08 dB	43.09 dB
Fiber type	Multimode	Single-mode		

Technical Specifications

Table 5-50 describes the technical specifications of the 1CPOS-155M.

Table 5-50 Technical specifications of the 1CPOS-155M

Item	Specification
Dimensions (depth x width x height)	223.5 mm x 100.1 mm x 19.82 mm (8.8 in. x 3.94 in. x 0.78 in.)
Maximum power consumption	12 W
Weight	0.3 kg (0.66 lb)

5.4.9 3G-HSPA+7 (3G WAN Interface Card)

A 3G-HSPA+7 interface card provides two 3G antenna interfaces and one mini USB interface.

Functions and Applications

Functions

The 3G-HSPA+7 interface card provides WAN access through WCDMA.

Applications

The 3G-HSPA+7 interface card can be installed in the SIC slot on the AR1200-S and AR2220-S chassis.

Panel and Interfaces

Figure 5-17 shows the appearance of the 3G-HSPA+7 interface card.

Figure 5-17 3G-HSPA+7 panel

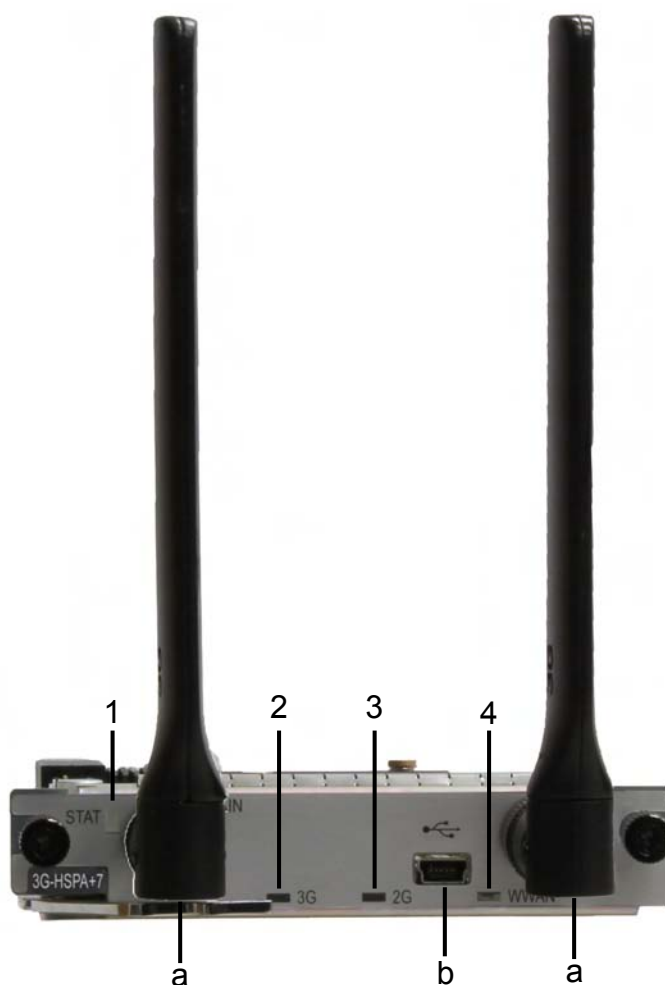

Buttons and Indicators on the Panel

Table 5-51 describes the buttons and indicators on the 3G-HSPA+7 panel.

Table 5-51 Buttons and indicators on the 3G-HSPA+7 panel

Number in Figure 5-17	Indicator	Color	Description
1	STAT	Green	If the indicator is steady on, the router has been powered on, but the system software is not running. If the indicator blinks once every 2s (0.5 Hz), the system is running properly. If the indicator blinks once every 0.25s (4 Hz), the system is loading software after power-on or is restarting.
		Red	If the indicator is steady on, a fault that affects services has occurred and cannot be rectified automatically. The fault needs to be rectified manually.
		Orange	If the indicator is off, the software is not running or is being reset.
2	3G	Green	If the indicator is steady on, the 3G signal strength is high. If the indicator blinks once every 2s (0.5 Hz), the 3G signals strength is low. If the indicator blinks once every 0.25s (4 Hz), the 3G signals strength is medium.
3	2G	Green	If the indicator is steady on, the 2G signal strength is high. If the indicator blinks once every 2s (0.5 Hz), the 2G signals strength is low. If the indicator blinks once every 0.25s (4 Hz), the 2G signals strength is medium.

Number in Figure 5-17	Indicator	Color	Description
4	WWAN	Green	<p>If the indicator is steady on, the 3G/2G connection is being established or is active.</p> <p>If the indicator is blinking, data is being transmitted or received over the 3G/2G connection.</p> <p>If the indicator is off, the 3G/2G connection has not been established or is inactive.</p>

Interfaces

Table 5-52 describes the types and functions of interfaces on the 3G-HSPA+7 interface card.

Table 5-52 Types and functions of interfaces on the 3G-HSPA+7 interface card

Letter in Figure 5-17	Name	Quantity	Description	Cable Type
a	Antenna interface	2	The 3G-HSPA+7 interface card provides two 3G interfaces to transmit and receive 3G service data. One interface is the primary interface, and the other is the secondary interface.	3G antenna
b	Mini USB interface	1	The mini USB interface is used to commission the 3G module.	Mini USB cable

Interface Attributes

Table 5-53 3G interface attributes

Item	Description
Connector	<p>SMA RF: connects to an antenna to provide wireless access.</p> <p>mini USB: connects to a USB flash drive with third-party wireless network test software, for example, Qualcomm CAIT.</p>

Item	Description
Standards compliance and frequency bands supported	GSM/GPRS/EDGE: 850/900/1800/1900 (MHz) HSPA+/HSUPA/HSDPA/WCDMA: 2100/1900/900/850 (MHz)
Rate	GSM CS: <ul style="list-style-type: none"> ● Upstream (Tx): 9.6kbit/s ● Downstream (Rx): 9.6kbit/s GPRS/EDGE: Multi-slot Class 12, Class B WCDMA CS: <ul style="list-style-type: none"> ● Upstream (Tx): 64 kbit/s ● Downstream (Rx): 64 kbit/s WCDMA PS: <ul style="list-style-type: none"> ● Upstream (Tx): 384 kbit/s ● Downstream (Rx): 384 kbit/s HSPA: <ul style="list-style-type: none"> ● Upstream (Tx): 5.76 Mbit/s ● Downstream (Rx): 14.4 Mbit/s HSPA+: <ul style="list-style-type: none"> ● Upstream (Tx): 5.76 Mbit/s ● Downstream (Rx): 21 Mbit/s
Network protocol	WCDMA/HSPA/GPRS/EDGE

Installing a 3G SIM Card

For details on how to installing a 3G SIM card on the 3G-HSPA+7 interface card, see the *AR1200&2200&3200 Quick Installation Guide*.

Technical Specifications

Table 5-54 describes the technical specifications of the 3G-HSPA+7 interface card.

Table 5-54 Technical specifications of the 3G-HSPA+7

Parameter	Description
Dimensions (W x D x H)	100.1 mm x 223.5 mm x 19.82 mm
Maximum power consumption	7 W
Weight	0.2 kg

5.4.10 4GEW-T (4-Port-GE Electrical WAN Interface Card)

The 4GEW-T interface card provides four GE electrical interfaces.

4GEW-T stands for:

- 4: four interfaces
- GE: 1000M Ethernet
- W: WAN
- T: electrical interface

Functions and Applications

Functions

The 4GEW-T interface card provides four GE electrical interfaces to implement data access and line-speed switching.

The 4GEW-T interface card sends, receives, and processes GE data traffic. The four GE electrical interfaces work in 10/100/1000 Mbit/s auto-negotiation mode.

Applications

The 4GEW-T interface card can be installed in the WSIC slot on the AR1200-S and AR2220-S chassis.

Panel and Interfaces

[Figure 5-18](#) shows the appearance of the 4GEW-T interface card.

Figure 5-18 4GEW-T panel

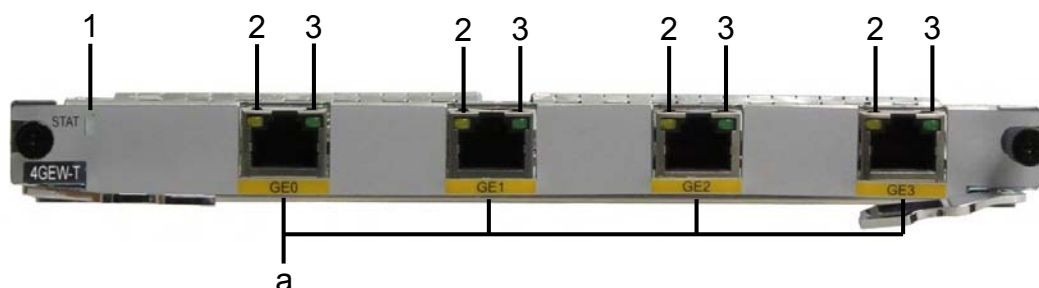

Buttons and Indicators on the Panel

[Table 5-55](#) describes the buttons and indicators on the 4GEW-T panel.

Table 5-55 Buttons and indicators on the 4GEW-T panel

Number in Figure 5-18	Indicator	Color	Description
1	STAT	Green	If the indicator is steady on, the router has been powered on, but the system software is not running. If the indicator blinks once every 2s (0.5 Hz), the system is running properly. If the indicator blinks once every 0.25s (4 Hz), the system is loading software after power-on or is restarting.
		Red	If the indicator is steady on, a fault that affects services has occurred and cannot be rectified automatically. The fault needs to be rectified manually.
		Off	If the indicator is off, the software is not running or is being reset.
2 and 3	GE interface indicators: <ul style="list-style-type: none"> ● The LINK indicator is in green. ● The ACT indicator is in yellow. 	Green	If the indicator is steady on, a link has been established. If the indicator is off, no link is established.
		Yellow	If the indicator is blinking, the interface is transmitting or receiving data. If the indicator is off, no data is being transmitted or received.

Interfaces

Table 5-56 describes the types and functions of interfaces on the 4GEW-T interface card.

Table 5-56 Types and functions of interfaces on the 4GEW-T interface card

Letter in Figure 5-18	Name	Quantity	Description	Cable Type
a	1000BASE-T electrical interface	4	The 4GEW-T interface card provides four 1000M electrical interfaces to transmit and receive GE data traffic.	6.5 Network Cable

Interface Attributes

Table 5-57 Attributes of 1000BASE-T electrical interfaces

Item	Description
Connector type	RJ45
Interface attribute	MDI/MDIX NOTE <ul style="list-style-type: none"> ● The interfaces of most network cards are medium dependent interfaces (MDIs). ● MDIX interfaces are usually used on hubs or LAN switches.
Standards compliance	IEEE802.3, IEEE802.3u, IEEE802.3ab
Frame format	Ethernet_II, Ethernet_SAP, or Ethernet_SNAP
Network layer protocol	IP

Technical Specifications

Table 5-58 describes the technical specifications of the 4GEW-T interface card.

Table 5-58 Technical specifications of the 4GEW-T

Parameter	Description
Dimensions (W x D x H)	201 mm x 223.5 mm x 19.82 mm
Maximum power consumption	11 W
Weight	0.3 kg

5.4.11 4GEW-S (4-Port-GE Optical WAN Interface Card)

The 4GEW-S interface card provides four GE optical interfaces.

4GEW-S stands for:

- 4: four interfaces
- GE: 1000M Ethernet
- W: WAN
- S: optical interface

Functions and Applications

Functions

The 4GEW-S interface card provides four GE optical interfaces to implement data access and line-speed switching.

The 4GEW-S interface card sends, receives, and processes GE data traffic. The four GE optical interfaces work in 100/1000 Mbit/s auto-sensing mode.

Applications

The 4GEW-S interface card can be installed in the WSIC slot on the AR1200-S and AR2220-S chassis.

Panel and Interfaces

Figure 5-19 shows the appearance of the 4GEW-S interface card.

Figure 5-19 4GEW-S panel

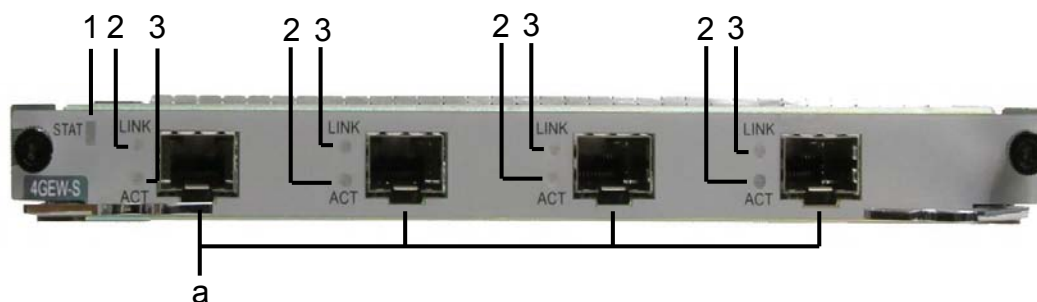

Buttons and Indicators on the Panel

Table 5-59 describes the buttons and indicators on the 4GEW-S panel.

Table 5-59 Buttons and indicators on the 4GEW-S panel

Number in Figure 5-19	Indicator	Color	Description
1	STAT	Green	If the indicator is steady on, the router has been powered on, but the system software is not running. If the indicator blinks once every 2s (0.5 Hz), the system is running properly. If the indicator blinks once every 0.25s (4 Hz), the system is loading software after power-on or is restarting.
		Red	If the indicator is steady on, a fault that affects services has occurred and cannot be rectified automatically. The fault needs to be rectified manually.
		Off	If the indicator is off, the software is not running or is being reset.
2 and 3	GE interface indicators: <ul style="list-style-type: none"> ● The LINK indicator is in green. ● The ACT indicator is in yellow. 	Green	If the indicator is steady on, a link has been established. If the indicator is off, no link is established.
		Yellow	If the indicator is blinking, the interface is transmitting or receiving data. If the indicator is off, no data is being transmitted or received.

Interfaces

Table 5-60 describes the types and functions of interfaces on the 4GEW-S interface card.

Table 5-60 Types and functions of interfaces on the 4GEW-S interface card

Letter in Figure 5-19	Name	Quantity	Description	Cable Type
a	1000BASE-X optical interface	4	The 4GEW-S interface card provides four GE optical interfaces to transmit and receive GE service traffic.	6.6 Optical Fiber

Interface Attributes

Table 5-61 Attributes of the 100/1000BASE-X GE optical interface

Attribute	Description
Connector type	LC/PC
Optical interface attribute	Depending on the SFP optical module.
Standards compliance	IEEE 802.3ab
Frame format	Ethernet_II, Ethernet_SAP, or Ethernet_SNAP
Network layer protocol	IP

Table 5-62 Attributes of the SFP optical module (100/1000 Mbit/s) supported by the GE optical interface

Attribute	Description							
	500 m	10 km	10 km (single-mode bidirectional fiber)		40 km	40 km	80 km	100 km
Transmission distance	500 m	10 km	10 km (single-mode bidirectional fiber)		40 km	40 km	80 km	100 km
Center wavelength	850 nm	1310 nm	Tx: 1310 nm Rx: 1490 nm	Tx: 1490 nm Rx: 1310 nm	1310 nm	1550 nm	1550 nm	1550 nm
Transmitting power	-9.5 dBm to -2.5 dBm	-9.0 dBm to -3.0 dBm	-9.0 dBm to -3.0 dBm	-9.0 dBm to -3.0 dBm	-5.0 dBm to 0 dBm	-5.0 dBm to 0 dBm	-2.0 dBm to 5.0 dBm	0 dBm to 5 dBm
Receiver sensitivity	-17.0 dBm	-20.0 dBm	-19.5 dBm	-19.5 dBm	-23 dBm	-22 dBm	-23.0 dBm	-30.0 dBm

Attribute	Description							
Overload optical power	0 dBm	-3.0 dBm	-3.0 dBm	-3.0 dBm	-3.0 dBm	-3.0 dBm	-3.0 dBm	-9.0 dBm
Extinction ratio	9 dB	9 dB	6 dB	6 dB	9 dB	8.5 dB	9 dB	8 dB
Fiber type	Multi-mode	Single-mode						

Technical Specifications

Table 5-63 describes the technical specifications of the 4GEW-S interface card.

Table 5-63 Technical specifications of the 4GEW-S

Parameter	Description
Dimensions (W x D x H)	201 mm x 223.5 mm x 19.82 mm
Maximum power consumption	8 W
Weight	0.3 kg

5.5 Voice Interface Card

This section describes the types, functions, applications, appearance, interfaces, and technical specifications of the voice interface card.

5.5.1 2BST (2-Port-ISDN S/T Voice Interface Card)

The 2BST is the ISDN module on the AR routers and provides two ISDN S/T interfaces, which transmit voice service.

The 2BST implements the ISDN BRI function and provides the bandwidth of two B channels and one D channel:

- B channel: provides 64 kbit/s bandwidth and transmits voice service.
- D channel: is a signaling channel and provides 16 kbit/s bandwidth.
- The total bandwidth of two B channels and one D channel is 144 kbit/s.

The S/T interface on the 2BST provides a rate of 192 kbit/s, including 144 kbit/s for data transmission and 48 kbit/s for maintenance information transmission.

Table 5-64 lists the number of interfaces on the 1BST and 2BST.

Table 5-64 Number of interfaces on the 1BST and 2BST

Card Name	User Interface	Usage Scenario	Mode	Feed Supported
1BST	One S/T interface	Data services	TE	No
2BST	Two S/T interfaces	Voice services	NT	-40 V feed

 **NOTE**

- TE: terminal equipment
- NT: network termination

2BST cards have two types: SIC and WSIC. **Table 5-65** lists the slots where the SIC card and WSIC card are installed.

Table 5-65 Slots of 2BST SIC and WSIC cards

Card	Slot
2BST (SIC)	SIC slot
2BST (WSIC)	WSIC slot or XSIC slot NOTE In an XSIC slot, the WSIC card is installed in the lower part of the slot. The WSIC card uses the XSIC slot ID as its own slot ID.

Functions and Applications

Functions

The 2BST has the following functions:

- Provides two ISDN S/T interfaces for voice access.
- Implements NT mode.

The 2BST consists of the following modules:

- CPU control module: manages the system and loads programs.
- CPLD logic module: provides the working clock and reset signals for the chip, controls the line -40 V feed, controls the service port status, and monitors the board clock.

- ISDN chip module: provides S/T interface access, supports NT mode, and provides parallel interfaces and serial interfaces.
- Power supply module: conducts power from backplane to card.
- Clock module: provides the working clock for the CPU and working modules.

Applications

2BST (SIC) is installed into the SIC slot of the AR2220-S.

The 2BST (WSIC) is installed in a WSIC slot on the AR2220-S.

Panel and Interfaces

Figure 5-20 shows the appearance of the 2BST (SIC) panel.

Figure 5-20 Appearance of the 2BST (SIC) panel

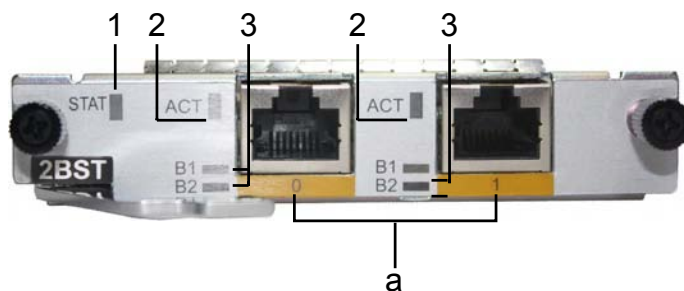
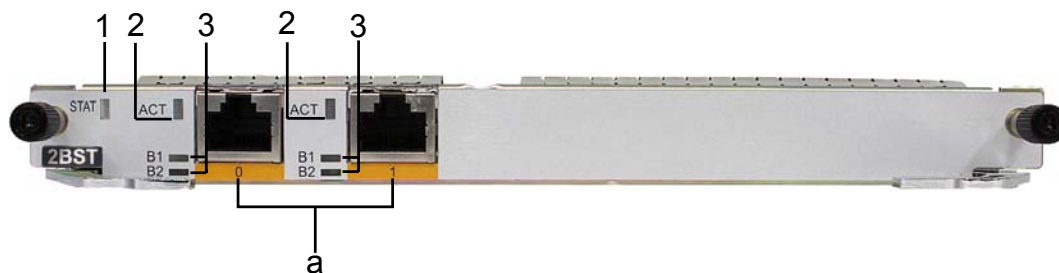

Figure 5-21 shows the appearance of the 2BST (WSIC).

Figure 5-21 Appearance of the 2BST (WSIC) panel



Buttons and Indicators on the Panel

Table 5-66 describes the buttons and indicators on the 2BST panel.

Table 5-66 Buttons and indicators on the 2BST panel

Number in Figure 5-20, Figure 5-21	Indicator	Color	Description
1	STAT	Green	If the indicator blinks once 2s (0.5 Hz), the system is running properly. If the indicator blinks once 0.25s (4 Hz), the system is powering on or restarting.
		Red	If the indicator is red, a fault that affects services occurs and cannot be rectified automatically. The fault needs to be rectified manually.
		Off	If the indicator is off, the software is not running or is being reset.
2	ACT (interface status indicator)	Green	If the indicator is steady on, the ISDN channel is activated.
			If the indicator is off, the ISDN channel is deactivated.
3	B1/B2	Green	If the indicator is blinking, the B1/B2 channel of the ISDN channel is being occupied.
			If the indicator is off, the B1/B2 channel of the ISDN channel is idle.

Interfaces

Table 5-67 describes the types and functions of interfaces on the 2BST.

Table 5-67 Types and functions of interfaces on the 2BST

Letter in Figure 5-20, Figure 5-21	Name	Quantity	Description	Cable Type
a	RJ45	2	ISDN S/T interfaces are provided.	6.10 ISDN-ST Cables

Interface Attributes

Table 5-68 ISDN S/T interface attributes

Item	Description
Connector	RJ45
Standards compliance	ITU-T I.430, Q.921, Q.931
Rate	192 kbit/s
Bandwidth	0 to 100 MHz
Cable	<ul style="list-style-type: none"> ● TE: standard ISDN S/T interface cables (straight-through cables) ● NT: ISDN S/T interface crossover cables

Technical Specifications

Table 5-69 describes the technical specifications of the 2BST.

Table 5-69 Technical specifications of the 2BST

Item	Specification
Dimensions (depth x width x height)	2BST (SIC): 223.5 mm x 100.1 mm x 19.82 mm (8.8 in. x 3.94 in. x 0.78 in.) 2BST (WSIC): 223.5 mm x 201 mm x 19.82 mm (8.8 in. x 7.92 in. x 0.78 in.)
Maximum power consumption	16.8 W
Weight	0.3 kg (0.66 lb)

5.5.2 4FXS1FXO-4-Port FXS and 1-Port FXO Voice Interface Card

The 4FXS1FXO is the voice module on the AR routers. It provides five RJ11 interfaces, including four POTS FXS interfaces and one POTS FXO interface.

 **NOTE**

- An FXS interface is a simulated subscriber line interface and provides access to AT0 loop trunk of the analog phone, fax, and telephone exchange.
- An FXO interface is a loop trunk interface and provides access to the telephone exchange by using regular subscriber lines.

Functions and Applications

Functions

The 4FXS1FXO works with the SRU to implement the voice call function. The first FXS interface works with an FXO interface to implement the power failure survival function.

Applications

The 4FXS1FXO can be installed into the SIC slot of the AR2220-S.

Panel and Interfaces

Figure 5-22 shows the appearance of the 4FXS1FXO.

Figure 5-22 Appearance of the 4FXS1FXO

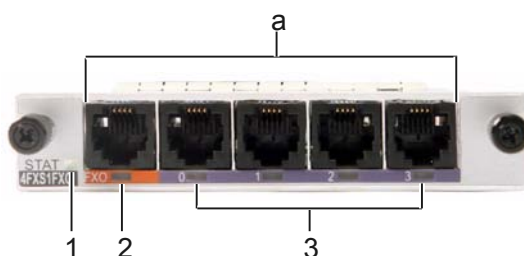

Buttons and Indicators on the Panel

Table 5-70 describes the buttons and indicators on the 4FXS1FXO panel.

Table 5-70 Buttons and indicators on the 4FXS1FXO panel

Number in Figure 5-22	Indicator	Color	Description
1	STAT	Green	If the indicator blinks once 2s (0.5 Hz), the system is running properly. If the indicator blinks once 0.25s (4 Hz), the system is powering on or restarting.
		Red	If the indicator is red, a fault that affects services occurs and cannot be rectified automatically. The fault needs to be rectified manually.
		Off	If the indicator is off, the software is not running or is being reset.
2	ACT (interface status indicator)	Green	If the indicator is steady on, the FXO channel is being occupied by a call.

Number in Figure 5-22	Indicator	Color	Description
			If the indicator is off, the FXO channel is idle.
3	ACT (interface status indicator)	Green	If the indicator is steady on, the FXS channel is being occupied by a call.
			If the indicator is off, the FXS channel is idle.

Interfaces

Table 5-71 describes the types and functions of interfaces on the 4FXS1FXO.

Table 5-71 Types and functions of interfaces on the 4FXS1FXO

Letter in Figure 5-22	Name	Quantity	Description	Cable Type
a	FXS (RJ11)	4	The POTS voice FXS interface uses regular telephone lines.	6.11 Regular Telephone Lines
	FXO (RJ11)	1	The POTS voice FXO interface uses regular telephone lines.	

Interface Attributes

Table 5-72 Attributes of FXS/FXO (RJ11) interfaces

Attribute	Description
Connector type	RJ11
Standards compliance	ITU Q.512 for FXS interfaces ITU Q.552 for FXO interfaces ITU K.20 for protection against overcurrent and overvoltage
Cable type	Regular telephone line
Dialing mode	DTMF in accordance with GB3378 Pulse dialing
Bandwidth	300 Hz to 3400 Hz

Technical Specifications

Table 5-73 describes the technical specifications of the 4FXS1FXO.

Table 5-73 Technical specifications of the 4FXS1FXO

Item	Specification
Dimensions (Depth x Width x Height)	223.5 mm x 100.1 mm x 19.82 mm (8.8 in. x 3.94 in. x 0.78 in.)
Maximum power consumption	12.78 W
Weight	0.3 kg (0.66 lb)

5.5.3 16/32/64/128-Channel DSP Module

The 16/32/64/128-channel DSP module is a VoIP voice processing DIMM.

Functions and Applications

Functions

The 16/32/64/128-channel DSP module provides the voice over IP (VoIP) functions, including:

- Processes the dial tone.
- Parses telephone numbers.
- Generates interactive voice response (IVR) and voice signal.
- Encodes, decodes, and converts voice.
- Implements voice conferences and echo canceler (EC).
- Processes IP packets.

Applications

The 16/32/64/128-channel DSP module is installed into the DSP DIMM of the main control board on the AR2220-S.



CAUTION

Only the DSP module supported by the product can be inserted into the DSP DIMM slot. The DDR3 memory board or unsupported DIMMs cannot be inserted; otherwise, the device may be damaged or does not function properly.

Technical Specifications

Table 5-74 shows the technical specifications of the 16/32/64/128-channel DSP module.

Table 5-74 Technical specifications of the 16/32/64/128-channel DSP module

Item	Specification
Maximum power consumption	2.89 W
Weight	0.05 kg (0.11 lb)

5.6 xDSL Interface Card

This section describes the types, functions, applications, appearance, interfaces, and technical specifications of the xDSL/xPON interface card.

5.6.1 ADSL-A/M and ADSL-B-1-Port-ADSL2+ ANNEX A/M and B WAN Interface Card

The ADSL-A/M and ADSL-B are the ADSL2/ADSL2+ service access modules on the AR routers and support ADSL2+ Annex A, Annex B, and Annex M specifications.

 **NOTE**

- The ADSL-A/M supports both Annex A and Annex M.
- The ADSL-B supports Annex B.

Table 5-75 describes the comparison between Annex A, Annex B, and Annex M.

Table 5-75 Comparison between Annex A, Annex B, and Annex M

Card Name	Usage Scenario
Annex A	Annex A is applied to ADSL over POTS and compatible with POTS services.
Annex B	Annex B is applied to ADSL over ISDN and compatible with ISDN services.

Card Name	Usage Scenario
Annex M	<p>Annex M expands the upstream frequency band of ADSL and provides a higher upstream transmission rate.</p> <p>G.992.3 and G.992.5 each define Annex M:</p> <ul style="list-style-type: none"> ● Annex M defined in G.992.3 and Annex M defined in G.992.5 have the same upstream frequency band. ● They have different downstream frequency bands: <ul style="list-style-type: none"> - The maximum downstream frequency band of Annex M defined in G.992.3 is 1104 kHz. - The maximum downstream frequency band of Annex M defined in G.992.5 is 2208 kHz.

Functions and Applications

Functions

The ADSL-A/M and ADSL-B each provide 1-channel ADSL/ADSL2+ access, provide independent CPU and management interfaces, and support ADSL2+ Annex A, Annex B, and Annex M specifications.

The ADSL-A/M or ADSL-B consists of the following modules:

- CPU control module: manages the system and loads programs.
- ADSL2+ module: implements ADSL2+ modulation and demodulation on CPEs.
- SGMII upstream module: provides one SGMII upstream interface to communicate with the active and standby SRUs.
- Power supply module: conducts power from backplane to card.
- Clock module: provides two types of working clocks for cards.

Applications

The ADSL-A/M and ADSL-B can be installed into the SIC slot of the AR1200-S and AR2220-S.

Panel and Interfaces

NOTE

The ADSL-A/M and ADSL-B panels are identical except for having different silkscreens. The following describes the panel and interfaces of the ADSL-A/M.

Figure 5-23 shows the appearance of the ADSL-A/M.

Figure 5-23 Appearance of the ADSL-A/M

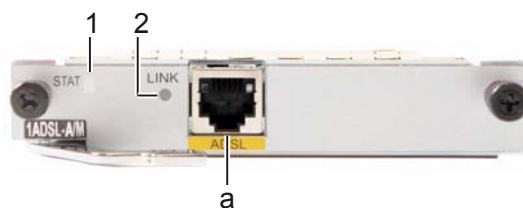

Buttons and Indicators on the Panel

[Table 5-76](#) describes the buttons and indicators on the ADSL-A/M panel.

Table 5-76 Buttons and indicators on the ADSL-A/M panel

Number in Figure 5-23	Indicator	Color	Description
1	STAT	Green	If the indicator blinks once 2s (0.5 Hz), the system is running properly. If the indicator blinks once 0.25s (4 Hz), the system is powering on or restarting.
		Red	If the indicator is red, a fault that affects services occurs and cannot be rectified automatically. The fault needs to be rectified manually.
		Off	If the indicator is off, the software is not running or is being reset.
2	LINK	Green	If the indicator is steady on, the DSL channel has been activated.
			If the indicator is off, the DSL channel is not activated.
			If the indicator blinks once 0.25s (4 Hz), the DSL channel is being activated.

Interfaces

[Table 5-77](#) describes the types and functions of interfaces on the ADSL-A/M.

Table 5-77 Types and functions of interfaces on the ADSL-A/M

Letter in Figure 5-23	Name	Quantity	Description	Cable Type
a	ADSL2+ (RJ11)	1	The ADSL-A/M provides one RJ11 interface, which supports regular telephone lines.	6.11 Regular Telephone Lines

Interface Attributes

Table 5-78 Attributes of ADSL2/ADSL2+ interfaces

Attribute	Description
Connector type	RJ11
Standards compliance	ADSL-A/M: ITU-T 992.1 G.DMT ITU-T 992.3 ITU-T 992.5
	ADSL-B: ITU-T 992.1 G.DMT ANSI T1.413 Issue 2 ITU-T 992.3 ITU-T 992.5
Transmission rate	ADSL-A/M: <ul style="list-style-type: none"> ● ADSL full rate mode (ITU-T 992.1 G.DMT): a downstream transmission rate of 8 Mbit/s and an upstream transmission rate of 1024 kbit/s ● ADSL2 full rate mode (ITU-T 992.3): a downstream transmission rate of 12 Mbit/s and an upstream transmission rate of 1024 kbit/s ● ADSL2+ full rate mode (ITU-T 992.5): a downstream transmission rate of 24 Mbit/s and an upstream transmission rate of 1024 kbit/s
	ADSL-B: A downstream transmission rate of 8 Mbit/s and an upstream transmission rate of 1024 kbit/s
Cable type	Regular telephone line

Technical Specifications

Table 5-79 describes the technical specifications of the ADSL-A/M and ADSL-B.

Table 5-79 Technical specifications of the ADSL-A/M and ADSL-B

Item	Specification
Dimensions (Depth x Width x Height)	223.5 mm x 100.1 mm x 19.82 mm (8.8 in. x 3.94 in. x 0.78 in.)
Maximum power consumption	5.4 W
Weight	0.3 kg (0.66 lb)

5.6.2 4G.SHDSL-1-Port-4-Channel G.SHDSL WAN Interface Card

The 4G.SHDSL is the G.SHDSL service access module on the AR routers.

G.Single-Pair High-Speed Digital Subscriber Line (G.SHDSL) uses trellis coded pulse amplitude modulation (TCPAM), provides up to 5.696 Mbit/s symmetric data rates, and supports 2/3/4-pair binding. The transmission rate can automatically adapt according to the line length and conditions. G.SHDSL provides a longer transmission distance than ADSL.

Functions and Applications

Functions

The 4G.SHDSL provides 4-channel G.SHDSL access and the independent CPU as well as management interfaces.

The 4G.SHDSL consists of the following modules:

- CPU control module: manages the system and loads programs.
- G.SHDSL module: processes G.SHDSL services on CPEs.
- GE upstream module: provides one upstream interface to communicate with the active and standby SRUs.
- Power supply module: conducts power from backplane to card.
- Clock module: provides three types of working clocks for cards.

Applications

The 4G.SHDSL can be installed into the SIC slot of the AR1200-S and AR2220-S.

Panel and Interfaces

Figure 5-24 shows the appearance of the 4G.SHDSL.

Figure 5-24 Appearance of the 4G.SHDSL

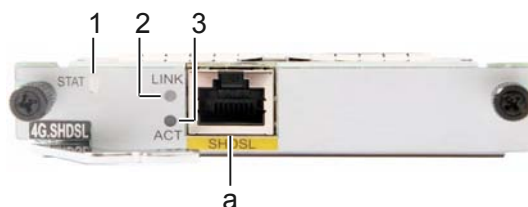

Buttons and Indicators on the Panel

Table 5-80 describes the buttons and indicators on the 4G.SHDSL panel.

Table 5-80 Buttons and indicators on the 4G.SHDSL panel

Number in Figure 5-24	Indicator	Color	Description
1	STAT	Green	If the indicator blinks once 2s (0.5 Hz), the system is running properly. If the indicator blinks once 0.25s (4 Hz), the system is powering on or restarting.
		Red	If the indicator is red, a fault that affects services occurs and cannot be rectified automatically. The fault needs to be rectified manually.
		Off	If the indicator is off, the software is not running or is being reset.
2	LINK	Green	If the indicator is steady on, the four DSL channels have been activated.
			If the indicator is off, the four DSL channels have not been activated.
			<ul style="list-style-type: none"> ● If the indicator is on for 0.25 seconds and blinks three times in the next 0.75 seconds, the DSL channel has been activated. ● If the indicator is on for 0.5 seconds and blinks twice in the next 0.5 seconds, the two DSL channels have been activated. ● If the indicator is on for 0.75 seconds and blinks in the next 0.25 seconds, the three DSL channels have been activated.
3	ACT	Yellow	If the indicator is blinking, data is being transmitted or received.
			If the indicator is off, no data is being transmitted or received.

Interfaces

Table 5-81 describes the types and functions of interfaces on the 4G.SHDSL.

Table 5-81 Types and functions of interfaces on the 4G.SHDSL

Letter in Figure 5-24	Name	Quantity	Description	Cable Type
a	G.SHDSL (RJ45)	1	The 4G.SHDSL provides one RJ45 interface, which supports standard network cables.	6.9 4G.SHDSL Cables or 6.5 Network Cable

Interface Attributes

Table 5-82 Attributes of G.SHDSL interfaces

Attribute	Description
Connector type	One RJ45 connector on one end and four RJ11 connectors on the other end
Standards compliance	G.SHDSL.bit
Transmission rate	5.696 Mbit/s per pair

Technical Specifications

Table 5-83 describes the technical specifications of the 4G.SHDSL.

Table 5-83 Technical specifications of the 4G.SHDSL

Item	Specification
Dimensions (Depth x Width x Height)	223.5 mm x 100.1 mm x 19.82 mm (8.8 in. x 3.94 in. x 0.78 in.)
Maximum power consumption	8.2 W
Weight	0.35 kg (0.78 lb)

5.6.3 1PON (1-Port GPON/EPON Dual-Mode Interface Card)

The 1PON card is the EPON/GPON auto-sensing module on the AR routers.

 **NOTE**

1 port: There are two ports on the 1PON card, one of which is the backup port. Therefore, the 1PON card is also called the 1PON.

The 1PON card functions as the ONU of the EPON/GPON system:

- Receives cells broadcast in TDM mode at a downlink rate of 1.25 Gbit/s (EPON) or 2.488 Gbit/s (GPON).
- Supports burst transmission in TDMA mode at an uplink rate of 1.25 Gbit/s (EPON) or 1.244 Gbit/s (GPON).

Functions and Applications

Functions

The 1PON card works with the main control board and supports two PON SFP uplink interfaces. The 1PON card has the following functions:

- Supports OLT clock synchronization but not the 1588 function.
- Supports EPON/GPON but not GE.
- Supports the DyingGasp function.
- Supports rogue ONT detection and isolation.
- Detects the receiving optical power.
- Supports delayed reset.

Applications

The 1PON card is installed into the SIC slot of the AR1200-S and AR2220-S.

Panel and Interfaces

[Figure 5-25](#) shows the appearance of the 1PON panel.

Figure 5-25 Appearance of the 1PON panel

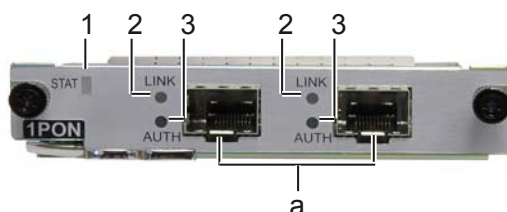

Buttons and Indicators on the Panel

[Table 5-84](#) describes the buttons and indicators on the 1PON panel.

Table 5-84 Buttons and indicators on the 1PON panel

Number in Figure 5-25	Indicator	Color	Description
1	STAT	Green	If the indicator blinks once 2s (0.5 Hz), the system is running properly. If the indicator blinks once 0.25s (4 Hz), the system is powering on or restarting.
		Red	If the indicator is red, a fault that affects services occurs and cannot be rectified automatically. The fault needs to be rectified manually.
		Off	If the indicator is off, the software is not running or is being reset.
2 and 3	PON interface indicators: <ul style="list-style-type: none"> ● The LINK indicator indicates whether the PON card is requesting data transmission. ● The AUTH indicator indicates the authentication status. 	Green	If both the LINK indicator and AUTH indicator are steady on, the 1PON card is registered successfully.
			If the LINK indicator is steady on and the AUTH indicator blinks once 0.25s (4 Hz), the 1PON card is being registered.
			If both the LINK indicator and AUTH indicator blink once 0.25s (4 Hz), the 1PON card keeps requesting data transmission. When this occurs, the 1PON card is a rogue ONU.
			If both the LINK indicator and AUTH indicator are off, the 1PON card does not request data transmission.

Interfaces

Table 5-85 describes the types and functions of interfaces on the 1PON card.

Table 5-85 Types and functions of interfaces on the 1PON card

Letter in Figure 5-25	Name	Quantity	Description	Cable Type
a	PON interface	2	The 1PON card provides EPON/GPON interfaces that are connected using SC/PC fibers.	6.6 Optical Fiber

Interface Attributes

Table 5-86 Attributes of the SFP optical module supported by the PON optical interface

Attribute		Description
Connector type		SC/PC connector (SFP encapsulation)
Transport mode		Single-mode bidirectional
Transmission rate		<ul style="list-style-type: none">● Downstream transmission rate of 2488 Mbit/s● Upstream transmission rate of 1244 Mbit/s
Standards compliance		ITU-T G.984.2 CLASS B+ ITU-T G.984.5 WBF
Sending end	Center wavelength	1290 nm to 1330 nm
	Average transmitting optical power	0.5 dBm to 5 dBm
	Average turn-off optical power	-45 dBm
	Side-mode suppression ratio	30 dB
	Extinction ratio	10 dB to 15 dB
Receiving end	Overload power	-8 dBm
	Input wavelength range	1480 nm to 1500 nm
Operating temperature		0°C to 70°C

Technical Specifications

Table 5-87 describes the technical specifications of the 1PON card.

Table 5-87 Technical specifications of the 1PON card

Item	Specification
Dimensions (depth x width x height)	223.5 mm x 100.1 mm x 19.82 mm
Maximum power consumption	8.72 W

Item	Specification
Weight	0.3 kg

5.6.4 VDSL (1-Port VDSL2 over POTS WAN Interface Card)

The VDSL interface card provides an interface for VDSL2 access.

Functions and Applications

Functions

The VDSL interface card is used for packet switching and device management. It supports the following functions:

- Works in VDSL2 mode that complies with ITU-T G.993.2 and supports profile 17a defined in G.993.2.
- Rolls back to ADSL2+ mode that complies with G.992.5.
- Supports temperature and power measurement.
- Sends a dying gasp alarm in the case of a power failure.

The VDSL interface card consists of the following modules:

- ADSL2/VDSL2 socket: implements ADSL2/VDSL2 modulation and demodulation on customer premises equipment (CPE).
- Storage module: stores data and programs on the interface card.
- GE uplink interface module: provides a GE uplink interface to receive and transmit data. The SRU manages the interface through this GE interface.
- Temperature and power module: measures temperature and power on the interface card.
- Clock resetting module: provides signals to reset the system clock.

Applications

The VDSL interface card can be installed in the SIC slot on the AR1200-S and AR2220-S chassis.

Panel and Interfaces

Figure 5-26 shows the appearance of the VDSL interface card.

Figure 5-26 VDSL panel

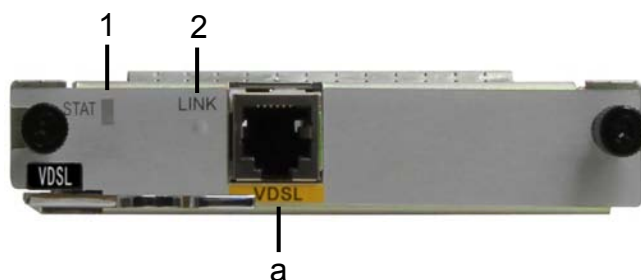

Buttons and Indicators on the Panel

Table 5-88 describes the buttons and indicators on the VDSL panel.

Table 5-88 Buttons and indicators on the VDSL panel

Number in Figure 5-26	Indicator	Color	Description
1	STAT	Green	If the indicator is steady on, the router has been powered on, but the system software is not running. If the indicator blinks once every 2s (0.5 Hz), the system is running properly. If the indicator blinks once every 0.25s (4 Hz), the system is loading software after power-on or is restarting.
		Red	If the indicator is steady on, a fault that affects services has occurred and cannot be rectified automatically. The fault needs to be rectified manually.
		Off	If the indicator is off, the software is not running or is being reset.
2	LINK	Green	If the indicator is steady on, the VDSL channel has been activated.
			If the indicator is off, the VDSL channel has not been activated.
			If the indicator blinks once every 0.25s (4 Hz), the VDSL channel is being activated.

Interfaces

Table 5-89 describes the types and functions of interfaces on the VDSL interface card.

Table 5-89 Types and functions of interfaces on the VDSL interface card

Letter in Figure 5-26	Name	Quantity	Description	Cable Type
a	VDSL2 (RJ11)	1	The VDSL interface card provides an RJ11 interface, which connects to a DSLAM through a telephone cable.	6.11 Regular Telephone Lines

Interface Attributes

Table 5-90 VDSL interface attributes

Item	Description
Connector	RJ11
Standards compliance	VDSL standards: ITU-T 993.2 ITU-T 992.5 ITU-T 992.3 ITU-T 992.1 G.DMT
Rate	<ul style="list-style-type: none"> ● ADSL2+ full rate mode (ITU-T 992.3): a downstream transmission rate of 12 Mbit/s and an upstream transmission rate of 1 Mbit/s ● VDSL2 mode (ITU-T 993.2): a downstream transmission rate of 100 Mbit/s and an upstream transmission rate of 50 kbit/s ● ADSL2 full rate mode (ITU-T 992.5): a downstream transmission rate of 24 Mbit/s and an upstream transmission rate of 1 Mbit/s ● ADSL full rate mode (ITU-T 992.1 G.DMT): a downstream transmission rate of 8 Mbit/s and an upstream transmission rate of 1 Mbit/s
Cable type	Telephone cable

Technical Specifications

[Table 5-91](#) describes the technical specifications of the VDSL interface card.

Table 5-91 Technical specifications of the VDSL interface card

Parameter	Description
Dimensions (W x D x H)	100.1 mm x 223.5 mm x 19.82 mm

Parameter	Description
Maximum power consumption	7.6 W
Weight	0.2 kg

6 Cables

About This Chapter

This chapter describes the cables used by the AR routers, including the structures and technical specifications of the cables.

[6.1 AC Power Cable](#)

An AC power cable transmits AC power to the switch.

[6.2 DC Power Cables](#)

A DC power cable transmits DC power to the switch.

[6.3 Ground Cable](#)

A ground cable protects the device from lightning strike and electromagnetic interference.

[6.4 Console Cable](#)

A console cable is used to debug or maintain a local device.

[6.5 Network Cable](#)

A network cable subtends devices, enables a device to communication with other network devices, and allows users to locally or remotely maintain the device.

[6.6 Optical Fiber](#)

An optical fiber connects the optical interface of a device to an upstream device or optical network terminal.

[6.7 E1/T1 Trunk Cables](#)

This section describes the structure and technical specifications of the E1/T1 trunk cable.

[6.8 Synchronous/Asynchronous Serial Interface Cables](#)

This section describes the categories, structure, and technical specifications of the synchronous/asynchronous serial interface cable.

[6.9 4G.SHDSL Cables](#)

This section describes the structure and technical specifications of the 4G.SHDSL cable.

[6.10 ISDN-ST Cables](#)

This section describes the categories, structure, and technical specifications of the ISDN-ST cable.

[6.11 Regular Telephone Lines](#)

This section describes the structure and technical specifications of the regular telephone line.

[6.12 8AS Cable](#)

An 8AS cable is connected to an 8AS interface card to commission or maintain the 8AS interface card.

[6.13 3G Antenna](#)

A 3G antenna transmits and receives 3G signals to enable an AR router to communicate with a 3G network.

6.1 AC Power Cable

An AC power cable transmits AC power to the switch.

Application

An AC power cable connects the following:

- The AC input power jack on the chassis
- The other end is connected to the AC power supply

Appearance

Figure 6-1 shows the appearance of the AC power cable.

Figure 6-1 Appearance of the AC power cable



Specifications

 **NOTE**

The AC power cables used in different countries and regions may have different specifications. The following are the specifications of the international standard AC power cable.

Table 6-1 lists the specifications of the AC power cable.

Table 6-1 Specifications of the AC power cable

Item	Description
Cable type	External power cable
Function	250 V AC/10 A complying with international standard

Item	Description
Connector 1	PI-straight-male
Connector 2	C13-straight-female
Cable type	<ul style="list-style-type: none">● 227 IEC 53 (RVV)-300 V/500 V● Rated voltage: 300 V/500 V● Standards compliance: 227 IEC 53 (RVV)
Conductor cross-sectional area	3 x 1.0 mm ² (3 x 0.00155 in. ²)
Fireproof level	GB18380.1

6.2 DC Power Cables

A DC power cable transmits DC power to the switch.

Applications

A DC power cable connects the following two interfaces:

- Input power jack on the chassis
- Output power interface on an external power system

 **NOTE**

A black -48 V DC power return wire (RTN) is connected to the RTN(+) end of the DC power supply. A blue -48 V DC power cable is connected to the NEG(-) end of the DC power supply.

Appearance and Structure

The black -48 V DC power return wire and the blue -48 V DC power cable are shown in [Figure 6-2](#) and [Figure 6-3](#).

Figure 6-2 -48 V DC power return wire



Figure 6-3 -48 V DC power cable



Specifications

The technical specifications of a -48 V DC power return wire and a -48 V DC power cable are the same, as described in [Table 6-2](#).

Table 6-2 Specifications of the DC power cables

Item	Description
Cable type	Power cable
Color	Blue for -48 V DC power cable and black for -48 V DC power return wire
Connector 1	OT
Connector 2	Cord end terminal
Impedance	4.95 Ω /km
Conductor cross-sectional area	1.2 mm ² (0.00186 in. ²)

6.3 Ground Cable

A ground cable protects the device from lightning strike and electromagnetic interference.

Application

A ground cable connects the chassis to the ground.

Appearance

Figure 6-4 shows the appearance of the ground cable.

Figure 6-4 Appearance of the ground cable



Specifications

Table 6-3 lists the specifications of the ground cable.

Table 6-3 Specifications of the ground cable

Item	Description
Cable type	Power cable
Color	Green-yellow
Connector type (X1/X2)	OT/OT naked crimping terminal
Gauge	10 AWG (cross-sectional area $\approx 5.2 \text{ mm}^2$ [0.0081 in. ²])
Cable type	<ul style="list-style-type: none"> Standards compliance: H07Z-K UL3386 Length: 0.3 m
Maximum current	50.0 A
Fireproof level	VW-1, CSA FT1

6.4 Console Cable

A console cable is used to debug or maintain a local device.

Application

A console cable connects the console port of the device to the serial port of an operation terminal to transmit configuration data. A shielded cable or an unshielded cable can be used according to the onsite situation.

A console cable connects the device and terminal as follows:

- The 8-pin RJ45 connector is inserted into the console port of the device.
- The DB9 male connector is connected to an operation terminal, which is usually a PC.

Appearance and Structure

Figure 6-5 shows the structure of the console cable.

Figure 6-5 Structure of the console cable

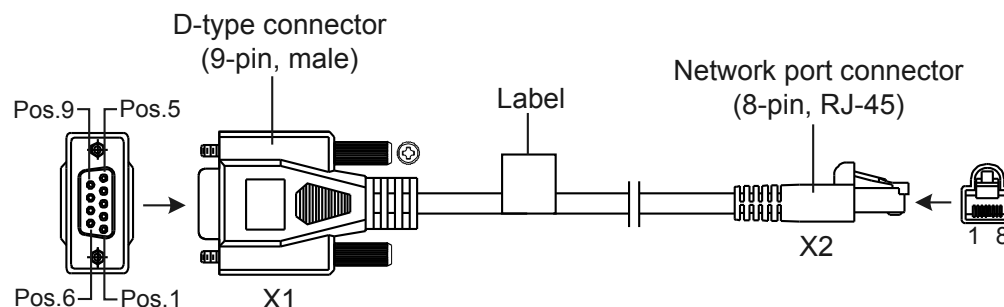

Pin Assignments

Table 6-4 describes the pin assignments of the console cable.

Table 6-4 Pin assignments of the console cable

Connector	X1(DB9)	X2(RJ45)
Pin assignment	2	3
	3	6
	5	5

Specifications

Table 6-5 lists the specifications of the console cable.

Table 6-5 Specifications of the console cable

Item	Description
Connector type	<ul style="list-style-type: none">● Connector X1: cable connector, D-type, 9-pin, male● Connector X2: network interface connector, RJ45, 8-pin, 8-bit, male
Cable type	Twisted pair
Color	PANTONE WARM GRAY 1U
Diameter	0.32 mm (0.13 in.)
Gauge	28 AWG (cross-sectional area $\approx 0.08 \text{ mm}^2$ [0.0002 in. ²])
Pin	2 pairs
Length	3 m (9.85 ft.)

6.5 Network Cable

A network cable subtends devices, enables a device to communication with other network devices, and allows users to locally or remotely maintain the device.

Application

A network cable connects a maintenance terminal to the console port on the main control board for local or remote maintenance.

The network cables are classified into straight-through cables and crossover cables.

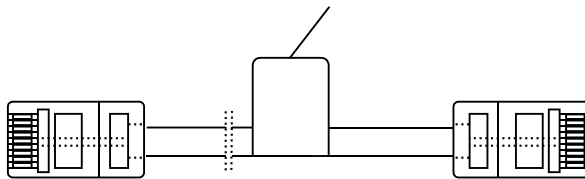

Pin Assignments

Table 6-6 describes the pin assignments of the straight-through cable.

Table 6-6 Pin assignments of the straight-through cable

X1 Pin	Tip Color	X2 Pin
1	White and orange	1
2	Orange	2
3	White and Green	3
4	Blue	4
5	White and Blue	5
6	Green	6
7	White and brown	7
8	Brown	8

Table 6-7 describes the pin assignments of the crossover cable.

Table 6-7 Pin assignments of the crossover cable

X1 Pin	Tip Color	X2 Pin
1	White and orange	3
2	Orange	6
3	White and Green	1
4	Blue	4
5	White and Blue	5
6	Green	2
7	White and brown	7
8	Brown	8

 **NOTE**

To achieve the optimum electrical transmission performance, ensure that the wires connected to pins 1 and 2 and to pins 3 and 6 are twisted pairs.

Specifications

Table 6-8 lists the specifications of the network cable.

Table 6-8 Specifications of the network cable

Item	Description
Connector type (X1/X2)	RJ45 connectors
Cable type	Category-3 and category-5 unshielded twisted pairs (UTP-3 and UTP-5) or shielded twisted pairs (STP)
Color	Dark gray
Characteristic impedance	100.0 Ω
Diameter	0.510 mm (0.02 in.)
Breakdown voltage	500.0 V
Impedance	93.8 Ω
Pin	8 pins
Frequency	0 MHz to 100 MHz
Frequency attenuation	22 dB/100 m@100 MHz
Fireproof level	CM
Length	<ul style="list-style-type: none">● Straight through cable: 5 meters (16.4 ft.), 10 meters (32.8 ft.), 20 meters (65.6 ft.), and 30 meters (98.5 ft.)● Crossover cable: 5 meters (16.4 ft.) and 30 meters (98.5 ft.)

6.6 Optical Fiber

An optical fiber connects the optical interface of a device to an upstream device or optical network terminal.

Application

An optical fiber carries optical signals and transmits them over short distance. An optical fiber connects the following:

- The optical interface on a board
- The optical distribution frame (ODF) or the optical interface on another device

Table 6-9 lists the classification of optical fibers.

Table 6-9 Optical fiber classification

No.	Purpose	Local End Connector	Remote End Connector	Mode
1	To connect LPU of the device to the ODF	LC/PC	FC/PC	Single mode, indoor
2	To connect LPUs of two devices	LC/PC	LC/PC	Single mode/multimode, indoor
3	To connect LPU of the device to another device	LC/PC	SC/PC or LC/PC	Single mode/multimode, indoor

Appearance

The appearances of the single-mode optical fiber and the multimode optical fiber are the same, but their colors are different. The single-mode optical fiber is yellow, and the multi-mode optical fiber is orange.



CAUTION

When connecting or removing the LC/PC optical connector, align the connector with the optical interface, and do not rotate the fiber. Pay attention to the following points:

- Align the head of the fiber jumper with the optical interface and insert the optical fiber into the interface gently.
- To remove the fiber, press the latch on the connector and pull the fiber out.

Figure 6-8 and **Figure 6-9** show the appearances of the single mode fiber.

Figure 6-8 Single mode fiber with LC/PC connectors



Figure 6-9 Single mode fiber with SC/PC connectors



Figure 6-10 shows the appearance of the multimode fiber.

Figure 6-10 Multimode fiber with LC/PC connectors



Pin Assignments

Table 6-10 describes the pin assignments of the optical fiber.

Table 6-10 Pin assignments of the optical fiber

Local End Terminal	Signal Direction	Remote End Terminal
Optical interface Tx terminal	->	Optical interface Rx terminal
Optical interface Rx terminal	<-	Optical interface Tx terminal

Fiber Selection Criterion





Table 6-11 lists the criteria for selecting optical fibers. **Table 6-12** lists common optical connectors.

Table 6-11 Fiber selection criterion

Parameter	Criterion
Length	Onsite survey result

Parameter	Criterion
Single mode or multimode	<p>Optical module type</p> <ul style="list-style-type: none"> ● The optical transmitting module of the multimode mode is connected to the multimode fiber. ● The optical transmitting module of the single-longitudinal mode or multi-longitudinal mode is connected to the single mode fiber. <p>NOTE If the optical fiber jumper is used, the connector connected to the device must be the LC/PC connector, and the connector connected to the remote end must be of the same type as the remote end interface.</p>
Connector shape	<ul style="list-style-type: none"> ● Cube: SC/PC, LC/PC, and MTRJ/PC ● Column: ST/PC and FC/PC

Table 6-12 Common optical connectors

 SC/PC optical connector	 LC/PC optical connector
 FC/PC optical connector	 MTRJ/PC optical connector
 ST/PC optical connector	-

6.7 E1/T1 Trunk Cables

This section describes the structure and technical specifications of the E1/T1 trunk cable.

Introduction

E1 trunk cables are classified into 75-ohm unbalanced coaxial cables and 120-ohm balanced twisted pair cables. The connectors of the cables are as follows:

- 75-ohm unbalanced coaxial cable (DB9 to BNC):
 - One end provides a DB9 connector.
 - The other end provides two BNC connectors.

- 120-ohm balanced twisted pair cable (DB9 to RJ45):
 - One end provides a DB9 connector.
 - The other end provides an RJ45 connector.

A T1 trunk cable is a 100-ohm balanced twisted pair cable. Its appearance is the same as the appearance of an E1 120-ohm balanced twisted pair cable.

Appearance and Structure

Figure 6-11 shows the appearance of an E1 75-ohm unbalanced coaxial cable.

Figure 6-11 Appearance of an E1 75-ohm unbalanced coaxial cable



Figure 6-12 shows the appearance of the E1 120-ohm or T1 100-ohm balanced twisted pair cable.

Figure 6-12 Appearance of the E1 120-ohm or T1 100-ohm balanced twisted pair cable



Figure 6-13 shows the structure of an E1 75-ohm unbalanced coaxial cable.

Figure 6-13 Structure of an E1 75-ohm unbalanced coaxial cable

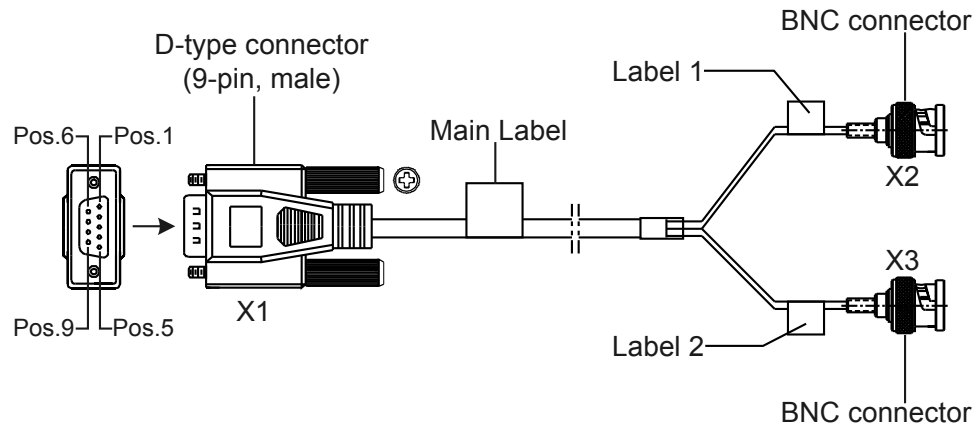
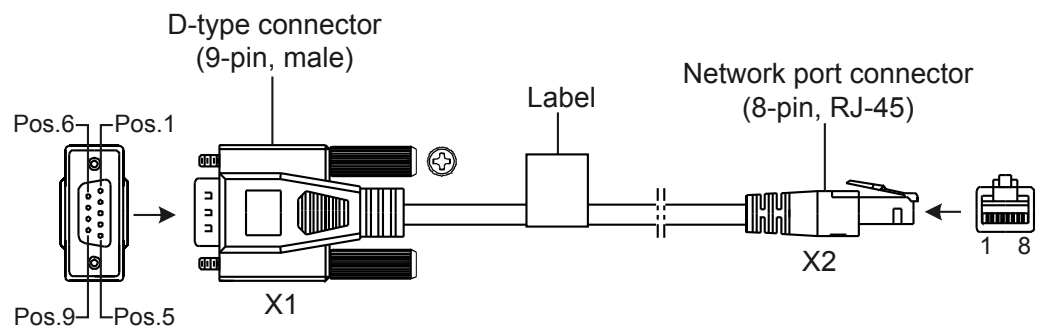

Figure 6-14 shows the structure of the E1 120-ohm or T1 100-ohm balanced twisted pair cable.

Figure 6-14 Structure of the E1 120-ohm or T1 100-ohm balanced twisted pair cable



Pin Assignments

Table 6-13 describes the pin assignments of an E1 75-ohm unbalanced coaxial cable.

Table 6-13 Pin assignments of an E1 75-ohm unbalanced coaxial cable

Connector	X1 (DB9)	BNC Connector
Pin assignment	1	X2
	2	
	6	X3
	7	

Table 6-14 describes the pin assignments of the E1 120-ohm or T1 100-ohm balanced twisted pair cable.

Table 6-14 Pin assignments of the E1 120-ohm or T1 100-ohm balanced twisted pair cable

Connector	X1 (DB9)	X2 (RJ45)	Tip Color
Pin assignment	1	4	White and orange
	2	5	Orange
	6	1	White and Blue
	7	2	Blue

E1/T1 Trunk Cable Extension

NOTE

The E1/T1 trunk cable is 3 m long. If the connection distance is long, a cable extension is required.

- E1 75-ohm unbalanced coaxial cable: BNC to BNC (The two connectors are BNC 75 angle male-II.)
- E1 120-ohm or T1 100-ohm balanced twisted pair cable: RJ45 to RJ45 (The two connectors are RJ45.)

The E1 75-ohm unbalanced coaxial cable is connected as follows:

- If the E1 trunk cable extension is not used, the BNC connector is connected to the remote device.
- If the E1 trunk cable extension is used, the BNC connector is connected to a coaxial connector, and the coaxial connector is connected to the remote device through the cable extension, as shown in [Figure 6-15](#).

CAUTION

The Tx end of the E1 trunk cable is connected to the Rx end of the remote device, and the Rx end is connected to the Tx end.

Figure 6-15 E1 75-ohm unbalanced coaxial cable extension

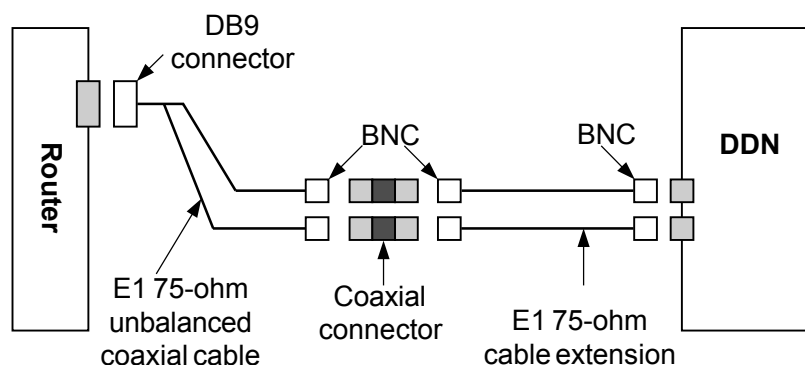

The E1 120-ohm or T1 100-ohm balanced twisted pair cable is connected as follows:

- If the E1/T1 trunk cable extension is not used, the RJ45 connector is connected to the RJ45 interface of the remote device.
- If the E1/T1 trunk cable extension is used, the RJ45 connector is connected to a network interface connector, and the network interface connector is connected to the remote device through the cable extension, as shown in **Figure 6-16**.

Figure 6-16 E1 120-ohm or T1 100-ohm balanced twisted pair cable extension

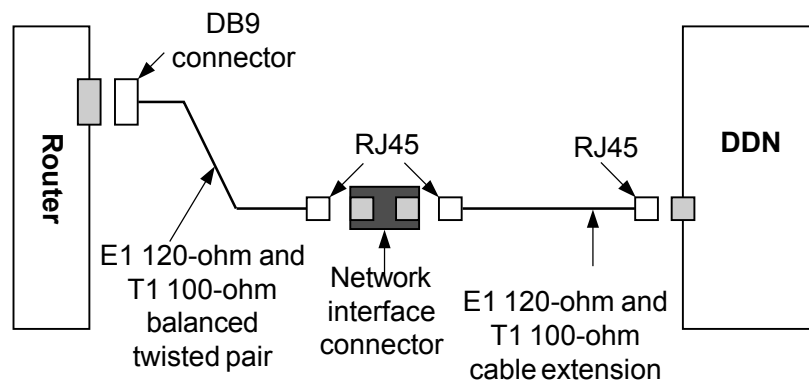

Specifications

Table 6-15 lists the specifications of the E1/T1 trunk cable.

Table 6-15 Specifications of the E1/T1 trunk cable

Item	Description
Characteristic impedance	<ul style="list-style-type: none"> ● E1 75-ohm unbalanced coaxial cable: 75 ohm ● E1 120-ohm balanced twisted pair cable: 120 ohm ● T1 100-ohm balanced twisted pair cable: 100 ohm
Cable type	<ul style="list-style-type: none"> ● E1 75-ohm unbalanced coaxial cable: coaxial cable ● E1 120-ohm or T1 100-ohm balanced twisted pair cable: balanced twisted pair cable
Color	<ul style="list-style-type: none"> ● E1 75-ohm unbalanced coaxial cable: PANTONE WARM GREY 1U ● E1 120-ohm or T1 100-ohm balanced twisted pair cable: PANTONE 430U
Diameter	<ul style="list-style-type: none"> ● E1 75-ohm unbalanced coaxial cable: 0.254 mm (0.01 in.) ● E1 120-ohm or T1 100-ohm balanced twisted pair cable: 0.4 mm (0.016 in.)

Item	Description
Gauge	<ul style="list-style-type: none"> ● E1 75-ohm unbalanced coaxial cable: 30 AWG ● E1 120-ohm or T1 100-ohm balanced twisted pair cable: 26 AWG
Cores	<ul style="list-style-type: none"> ● E1 75-ohm unbalanced coaxial cable: SYFVZP-75-1-1*4 ● E1 120-ohm or T1 100-ohm balanced twisted pair cable: SEYVP-120

6.8 Synchronous/Asynchronous Serial Interface Cables

This section describes the categories, structure, and technical specifications of the synchronous/asynchronous serial interface cable.

Introduction

A synchronous/asynchronous serial interface cable is connected as follows:

- The DB28 connector is connected to the DB28 port on a card.
- Another end depends on the connected device:
 - If the wide area network (WAN) uses the DDN line, the cable is connected to the CSU/DSU.
 - If the WAN uses the dial-up line, the cable is connected to the modem.

Cable Category



CAUTION

Verify that devices are connected using appropriate synchronous/asynchronous serial interface cables. Appropriate cable type is determined based on device connection mode (such as synchronous/asynchronous and DTE/DCE modes), signals used by the connected device, baud rate, and clock.

Table 6-16 lists the categories of synchronous/asynchronous serial interface cables.

Table 6-16 Categories of synchronous/asynchronous serial interface cables

Cable	Local End Connector	Network-side Connector
V.24 DTE cable	DB28 connector	DB25 (male) connector
V.24 DCE cable		DB25 (female) connector
V.35 DTE cable		DB28 (male) connector

Cable	Local End Connector	Network-side Connector
V.35 DCE cable		DB28 (female) connector
X.21 DTE cable		DB15 (male) connector
RS449 DTE cable		DB28 (male) connector
RS449 DCE cable		DB28 (female) connector
RS530 DTE cable		DB25 (male) connector
RS530 DCE cable		DB25 (female) connector

Appearance

Figure 6-17 shows the appearance of the V.24 DTE cable.

Figure 6-17 Appearance of the V.24 DTE cable



Figure 6-18 shows the appearance of the V.24 DCE cable.

Figure 6-18 Appearance of the V.24 DCE cable



Figure 6-19 shows the appearance of the V.35 DTE cable.

Figure 6-19 Appearance of the V.35 DTE cable



Figure 6-20 shows the appearance of the V.35 DCE cable.

Figure 6-20 Appearance of the V.35 DCE cable



Figure 6-21 shows the appearance of the X.21 DTE cable.

Figure 6-21 Appearance of the X.21 DTE cable



Figure 6-22 shows the appearance of the RS449 DTE cable.

Figure 6-22 Appearance of the RS449 DTE cable



Figure 6-23 shows the appearance of the RS449 DCE cable.

Figure 6-23 Appearance of the RS449 DCE cable



Figure 6-24 shows the appearance of the RS530 DTE cable.

Figure 6-24 Appearance of the RS530 DTE cable



Figure 6-25 shows the appearance of the RS530 DCE cable.

Figure 6-25 Appearance of the RS530 DCE cable



Specifications

Table 6-17 lists the specifications of the synchronous/asynchronous serial interface cable.

Table 6-17 Specifications of the synchronous/asynchronous serial interface cable

Item	Description
Characteristic impedance	100 ohm
Cable type	Twisted pair
Transmission rate	<ul style="list-style-type: none">● V.24: 1200 bit/s to 64 kbit/s● V.35/X.21/RS449/RS530: 1200 bit/s to 2.048 Mbit/s
Color	Dark blue (PANTONE 296U)
Diameter	<ul style="list-style-type: none">● V.24 DTE/DCE cable, V.35 DTE/DCE cable, and X.21 DTE cable: 0.38 mm (0.015 in.)● RS449 DTE/DCE cable and RS530 DTE/DCE cable: 0.32 mm (0.013 in.)
Gauge	28 AWG
Pin	<ul style="list-style-type: none">● V.24 DTE/DCE cable, V.35 DTE/DCE cable, X.21 DTE cable: 5 pairs + 8 pins● RS449 DTE/DCE cable and RS530 DTE/DCE cable: 26 pins

6.9 4G.SHDSL Cables

This section describes the structure and technical specifications of the 4G.SHDSL cable.

Introduction

The connectors of a 4G.SHDSL cable are as follows:

- Four RJ11 connectors on the local end
- An RJ45 connector on the network side

Appearance and Structure

[Figure 6-26](#) shows the appearance of the 4G.SHDSL cable.

Figure 6-26 Appearance of the 4G.SHDSL cable



Figure 6-27 shows the structure of the 4G.SHDSL cable.

Figure 6-27 Structure of the 4G.SHDSL cable

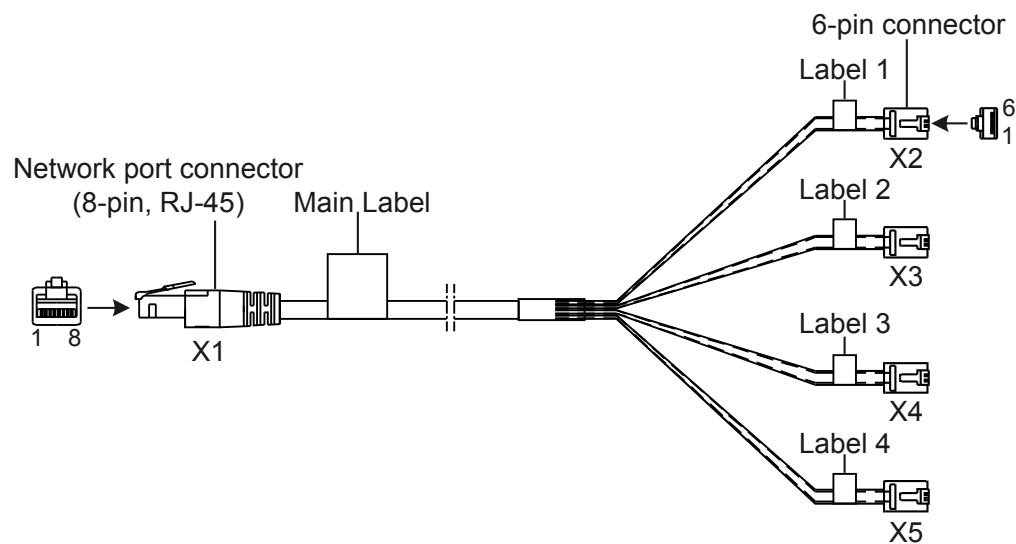

Pin Assignments

Table 6-18 describes the pin assignments of the 4G.SHDSL cable.

Table 6-18 Pin assignments of the 4G.SHDSL cable

Connector	X1 (RJ45)	X2/X3/X4/X5 (RJ11)	Tip Color
Pin assignment	1 (LINE1 A)	2.3	White and orange
	2 (LINE1 B)	2.4	Orange
	3 (LINE2 A)	3.3	White and Green
	6 (LINE2 B)	3.4	Green
	4 (LINE0 A)	4.3	White and Blue
	5 (LINE0 B)	4.4	Blue
	7 (LINE3 A)	5.3	White and brown
	8 (LINE3 B)	5.4	Brown

 **NOTE**

As shown in [Table 6-18](#), the 4G.SHDSL cable uses standard pin assignments. A cable has four ports, each of them has two lines (A/B). The two lines in a port can be assigned in any sequence, but the line pairs must be assigned in certain sequence.

Specifications

[Table 6-19](#) lists the specifications of the 4G.SHDSL cable.

Table 6-19 Specifications of the 4G.SHDSL cable

Item	Description
Characteristic impedance	100 ohm
Cable type	Category 5 twisted pairs
Color	PANTONE 430U
Diameter	0.51 mm (0.02 in.)
Gauge	24 AWG
Pin	8 pins

6.10 ISDN-ST Cables

This section describes the categories, structure, and technical specifications of the ISDN-ST cable.

Introduction

ISDN-ST cables are classified into the following types:

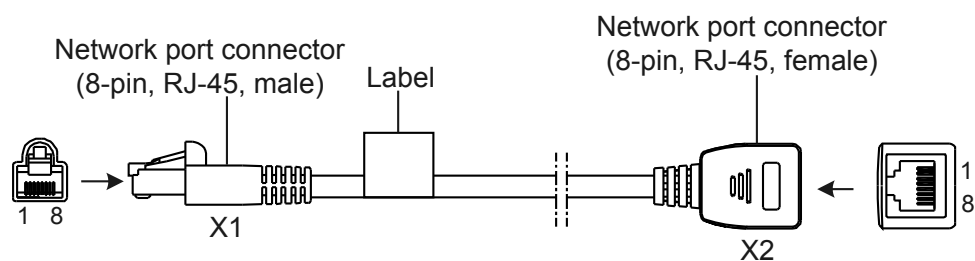

Figure 6-29 Appearance of an ISDN S/T interface crossover cable



Figure 6-30 shows the structure of an ISDN S/T interface crossover cable.

Figure 6-30 Structure of an ISDN S/T interface crossover cable



Pin Assignments

Table 6-20 describes the pin assignments of the standard ISDN S/T interface cable. Pins 3 and 6 are the sending end, and pins 4 and 5 are the receiving end.

Table 6-20 Pin assignments of the standard ISDN S/T interface cable

RJ45	Signal	RJ45
1	-	1

RJ45	Signal	RJ45
2	-	2
3	Tx+	3
4	Rx+	4
5	Rx-	5
6	Tx-	6
7	-	7
8	-	8

Table 6-21 describes the pin assignments of the ISDN S/T interface crossover cable. Pins 4 and 5 are the sending end, and pins 3 and 6 are the receiving end.

Table 6-21 Pin assignments of the standard ISDN S/T interface crossover cable

RJ45 (TE)	Signal	RJ45 (NT)
1	-	1
2	-	2
3	Tx+	4
4	Rx+	3
5	Rx-	6
6	Tx-	5
7	-	7
8	-	8

Technical Specifications

Table 6-22 lists the technical specifications of an ISDN-ST cable.

Table 6-22 Technical specifications of an ISDN-ST cable

Item	Specification
Characteristic impedance	100 ohm
Cable	Category 5 twisted pairs
Color	PANTONE 430U
Diameter	0.51 mm (0.02 in.)

Item	Specification
Gauge	24 AWG
Impedance	93.8 ohm
Pin	8 pins

6.11 Regular Telephone Lines

This section describes the structure and technical specifications of the regular telephone line.

Introduction

The regular telephone line is connected as follows:

- The RJ11 connector is connected to a device such as a phone and fax machine.
- Another RJ11 connector is connected to the voice card of the AR1200-S.

Appearance

Figure 6-31 shows the appearance of the regular telephone line.

Figure 6-31 Appearance of the regular telephone line

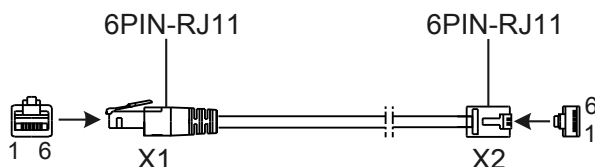

Pin Assignment

Table 6-23 provides the pin assignment of a regular telephone line.

Table 6-23 Pin assignment of a regular telephone line

X1 Pin	Wire Color	X2 Pin	Remarks
3	Red	3	Tip(+)
4	Green	4	Ring(-)

Specifications

Table 6-24 lists the specifications of the regular telephone line.

Table 6-24 Specifications of the regular telephone line

Item	Description
Dielectric strength	150 V
Maximum current	1 A
Impedance	237.25 ohm
Cable type	UL20251
Color	White
Gauge	28 AWG
Pin	2 pins

6.12 8AS Cable

An 8AS cable is connected to an 8AS interface card to commission or maintain the 8AS interface card.

Introduction

An 8AS cable connects the console port on an 8AS interface card to the serial port of an operation terminal. You can use shield cables or unshielded cables as required in different scenarios.

The common usage scenarios of 8AS cables are:

- To connect an 8AS interface card to automatic teller machines in a bank, use shield straight-through cables. You can buy shield straight-through cables from Huawei or made these cables onsite.
- To connect an 8AS interface card to a dumb terminal, use a transit cable and a shield straight-through cable. A transit cable has an RJ45 plug on one end and an RJ45 socket on the other end. The transit cable converts the pin assignments on the dumb terminal to the standard pin assignments, which are the same as those on the straight-through cable. Then the straight-through cable can connect to the dumb terminal.
- To connect an 8AS interface card to a serial port device, such as a PC or modem, use an asynchronous serial cable and a transit cable. One end of an asynchronous serial cable is an RJ45 socket, and the other end has a DB25 plug and a DB9 plug. The asynchronous serial cable connects to the PC or modem through the transit cable.

 **NOTE**

Huawei can customize 8AS cables of specified length.

Straight-through cable

[Figure 6-32](#) shows the appearance of a straight-through cable.

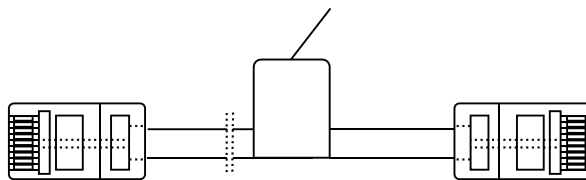

X1 Pin (8AS)	X2 Pin (Console)
5	3
6	6
7	1
8	8

Table 6-8 lists the technical specifications of a straight-through cable.

Transit Cable

Figure 6-34 shows the appearance of a transit cable.

Figure 6-34 Transit cable appearance



Figure 6-35 shows the structure of a transit cable.

Figure 6-35 Transit cable structure

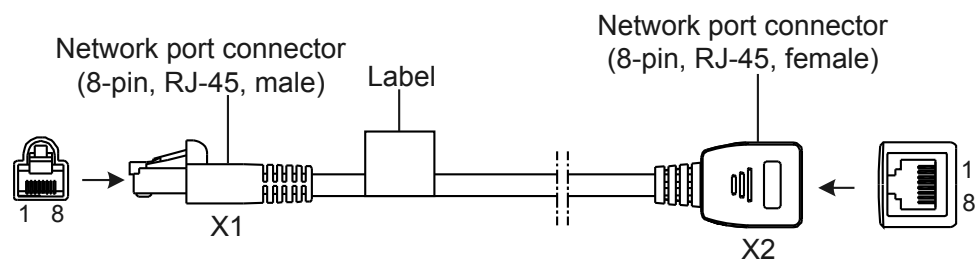

Table 6-26 lists the pin assignments of a transit cable.

Table 6-26 Pin assignments of a transit cable

X1	X2
1	4
2	2
3	7
4	5
5	6
6	3
7	8
8	1

Table 6-27 lists the specifications of a transit cable.

Table 6-27 Specifications of a transit cable

Item	Description
Characteristic impedance	100 ohm
Cable type	Category 5 twisted pairs
Color	PANTONE 430U
Core diameter of the inner conductor	0.51 mm
Wire gauge of the inner conductor	24 AWG
DC resistance of the inner conductor	93.8 ohm
Number of pins	8

Asynchronous Serial Cable

Figure 6-36 shows the appearance of an asynchronous serial cable.

Figure 6-36 Appearance of an asynchronous serial cable



Figure 6-37 shows the structure of an asynchronous serial cable.

Figure 6-37 Structure of an asynchronous serial cable

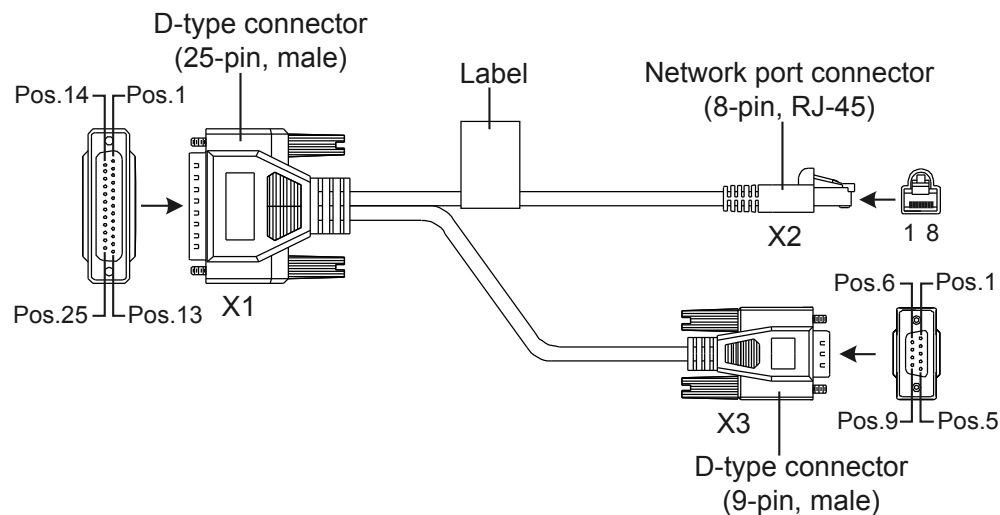

Table 6-28 lists the pin assignments of an asynchronous serial cable.

Table 6-28 Pin assignments of an asynchronous serial cable

X1	X2	X3
4	1	7

X1	X2	X3
20	2	4
2	3	3
8	4	1
7	5	5
3	6	2
6	7	6
5	8	8

Table 6-29 lists the specifications an asynchronous serial cable.

Table 6-29 Specifications of an asynchronous serial cable

Item	Description
Connector	<ul style="list-style-type: none">● Connector X1: cable connector, D-type, 25-pin, male● Connector X2: network interface connector, RJ45, 8-pin, 8-bit● Connector X3: cable connector, D-type, 9-pin, male
Cable type	Symmetrical twisted pair
Color	PANTONE WARM GRAY 1U
Core diameter of the inner conductor	0.32 mm
Wire gauge of the inner conductor	28 AWG (cross-sectional area approximately equal to 0.08 mm ²)
Number of pins	2 pairs
Length	3 m

6.13 3G Antenna

A 3G antenna transmits and receives 3G signals to enable an AR router to communicate with a 3G network.

Introduction

The antenna interfaces on a 3G-HSPA+7 interface card can connect to whip antennas and indoor remote antennas.

- Whip antennas are directly installed on an AR router and are recommended when a router is desk installed or wall mounted.
- Indoor remote antennas have a 3 m long feed line and can use two 6 m feed lines to expand the length to 15 m. Indoor remote antennas are recommended when an AR router is installed in a cabinet or rack. (Indoor remote antennas need to be ordered separately if needed.)

Whip Antenna

Figure 6-38 shows the appearance of a whip antenna.

Figure 6-38 Whip antenna



Table 6-30 lists the technical specifications of a whip antenna.

Table 6-30 Technical specifications of a whip antenna

Item	Description
Connector	SMA-J
Color	Black
Characteristic impedance	50 ohm
Length	150 mm
Frequency	824 MHz to 960 MHz/1710 MHz to 2170 MHz
Maximum power	10 W
Operating temperature	-40°C to +70°C

Item	Description
Relative humidity	5% RH to 90% RH, non-condensing
Gain	<ul style="list-style-type: none">● 824 MHz to 960 MHz: 1d Bi● 1710 MHz to 2170 MHz: 2 dBi
Voltage standing wave ratio	< 3

Remote Antenna

Figure 6-39 shows the appearance of a remote antenna.

Figure 6-39 Remote antenna



Table 6-31 lists the technical specifications of a remote antenna.

Table 6-31 Technical specifications of a remote antenna

Item	Description
Connector	SMA-Male
Color	Black
Characteristic impedance	50 ohm
Height	260 mm
Frequency	824 MHz to 960 MHz/1710 MHz to 2170 MHz
Maximum power	50 W
Operating temperature	-40°C to +90°C
Gain	<ul style="list-style-type: none">● 824 MHz to 960 MHz: 1 dBi● 1710 MHz to 2170 MHz: 2.5 dBi
Voltage standing wave ratio	< 2.5
Attenuation	< 0.3 dB on each meter of feed line (within the working frequency band)

7 List of Indicators

About This Chapter

This chapter describes the status and meanings of indicators on the AR routers, including indicators on the front and rear panels, cards, fan modules, and power supply units.

[7.1 Indicators on the AR1200-S Panel](#)

This section describes the indicators on the AR1200-S panel.

[7.2 Indicators on the AR2220-S Panel](#)

This section describes the indicators on the AR2220-S panel.

[7.3 Power Indicators](#)

This section describes the power indicators.

7.1 Indicators on the AR1200-S Panel

This section describes the indicators on the AR1200-S panel.

 **NOTE**

The indicators on the AR1220W-S and AR1220-S front panels are the same. The AR1220W-S is used as an example to describe the indicators.

Figure 7-1 shows the indicators on the AR1220W-S front panel.

Figure 7-1 Indicators on the AR1220W-S front panel



Table 7-1 describes the indicators on the AR1220W-S front panel.

Table 7-1 Indicators on the AR1220W-S front panel

Number in Figure 7-1	Indicator	Color	Description
1	SYS	Green	If the indicator blinks once 2s (0.5 Hz), the system is running properly. If the indicator blinks once 0.25s (4 Hz), the system is powering on or restarting.
		Red	If the indicator is red, a fault that affects services occurs and cannot be rectified automatically. The fault needs to be rectified manually.
		Off	If the indicator is off, the software is not running or is being reset.
2	WAN	Green	If the indicator is steady on, at least one GE interface has been connected or activated.

Number in Figure 7-1	Indicator	Color	Description
			If the indicator is off, neither GE interface is connected or activated.
3	ACT	Red and green	If the indicator is green, devices have been deployed by using the USB disk.
			If the indicator blinks green, data is being read from the USB disk.
			If the indicator is red, the device cannot be correctly connected to the NMS or cannot be registered with the NMS.
			If the indicator blinks red, an error occurs when configuration files are being executed or data is being read from the USB disk.
			If the indicator is off, the USB disk is not inserted, the USB interface fails, or the indicator fails.
4	RST	CAUTION The Reset button is used for resetting the device manually. Resetting the device will cause service interruption; therefore, confirm the action before you reset the device.	
5	WLAN	Green	If the indicator is steady on, the link has been connected or activated.
			If the indicator blinks (≤ 20 Hz), the link is transmitting data. If the traffic volume of transmitted data increases, the indicator blinks faster.
			If the indicator is off, the link is not connected or activated.
6	WLAN	The button enables and disables the WLAN function.	

Figure 7-2 shows the indicators on the AR1220W-S rear panel.

Figure 7-2 Indicators on the AR1220W-S rear panel

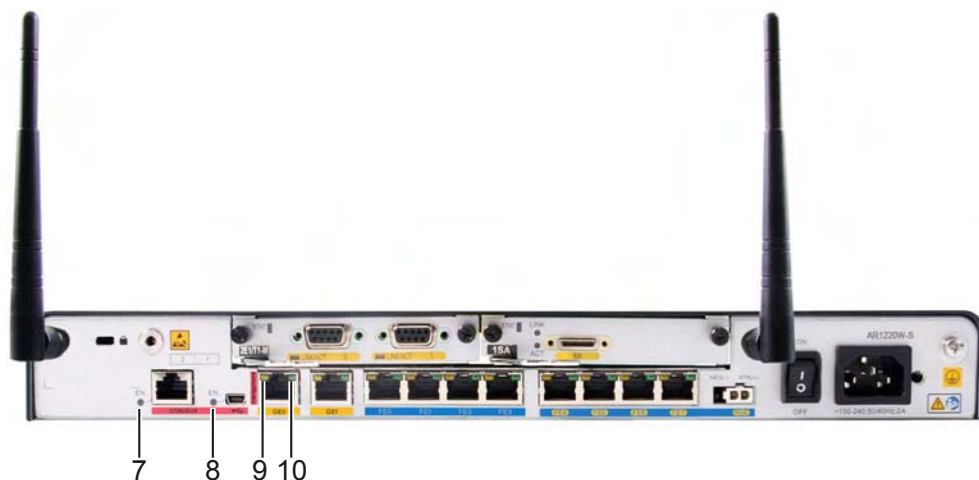

Table 7-2 shows the indicators on the AR1220W-S rear panel.

Table 7-2 Description of indicators on the AR1220W-S rear panel

Number in Figure 7-2	Indicator	Color	Description
7	EN (CON/AUX interface) NOTE <ul style="list-style-type: none"> Either the CON/AUX port or the MiniUSB port can be used at a time. By default, the port is used as the CON/AUX port. The EN indicator is green no matter whether a cable is installed. 	Green	If the indicator is steady on, the port is used as a CON/AUX port.
			If the indicator is off, the port does not function as a CON/AUX port.
8	EN (MiniUSB interface)	Green	If the indicator is steady on, the port is used as a MiniUSB port.
			If the indicator is off, the port does not function as a MiniUSB port.

Number in Figure 7-2	Indicator	Color	Description
9 and 10	GE interface indicators: <ul style="list-style-type: none"> ● The LINK indicator is in green. ● The ACT indicator is in yellow. 	Green	If the indicator is steady on, a link has been established.
			If the indicator is off, no link is established.
		Yellow	If the indicator is blinking, data is being transmitted or received.
			If the indicator is off, no data is being transmitted or received.

7.2 Indicators on the AR2220-S Panel

This section describes the indicators on the AR2220-S panel.

Figure 7-3 shows the indicators on the AR2220-S front panel.

Figure 7-3 Indicators on the AR2220-S front panel

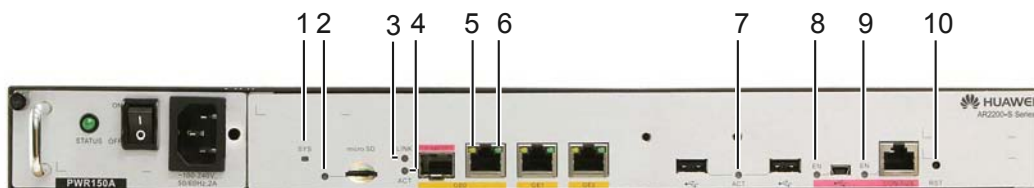

Table 7-3 describes the indicators on the AR2220-S front panel.

Table 7-3 Indicators on the AR2220-S front panel

Number in Figure 7-3	Indicator	Color	Description
1	SYS	Green	If the indicator blinks once 2s (0.5 Hz), the system is running properly. If the indicator blinks once 0.25s (4 Hz), the system is powering on or restarting.
		Red	If the indicator is red, a fault that affects services occurs and cannot be rectified automatically. The fault needs to be rectified manually.
		Off	If the indicator is off, the software is not running or is being reset.

Number in Figure 7-3	Indicator	Color	Description
2	MiniSD card indicator	Green	If the indicator is steady on, a link has been established.
			If the indicator is blinking, data is being transmitted or received.
			If the indicator is off, there is no MiniSD card.
3 and 4	SFP interface indicators: <ul style="list-style-type: none"> ● The LINK indicator is in green. ● The ACT indicator is in yellow. 	Green	If the indicator is steady on, a link has been established.
			If the indicator is off, no link is established.
		Yellow	If the indicator is blinking, data is being transmitted or received.
			If the indicator is off, no data is being transmitted or received.
5 and 6	GE interface indicators: <ul style="list-style-type: none"> ● The LINK indicator is in green. ● The ACT indicator is in yellow. 	Green	If the indicator is steady on, a link has been established.
			If the indicator is off, no link is established.
		Yellow	If the indicator is blinking, data is being transmitted or received.
			If the indicator is off, no data is being transmitted or received.
7	ACT	Red and green	If the indicator is green, devices have been deployed by using the USB disk.
			If the indicator blinks green, data is being read from the USB disk.
			If the indicator is red, the device cannot be correctly connected to the NMS or cannot be registered with the NMS.
			If the indicator blinks red, an error occurs when configuration files are being executed or data is being read from the USB disk.
			If the indicator is off, the USB disk is not inserted, the USB interface fails, or the indicator fails.

Number in Figure 7-3	Indicator	Color	Description
8	EN (MiniUSB interface)	Green	If the indicator is steady on, the port is used as a MiniUSB port.
			If the indicator is off, the port does not function as a MiniUSB port.
9	EN (CON/AUX interface) NOTE <ul style="list-style-type: none"> ● Either the CON/AUX port or the MiniUSB port can be used at a time. ● By default, the port is used as the CON/AUX port. The EN indicator is green no matter whether a cable is installed. 	Green	If the indicator is steady on, the port is used as a CON/AUX port.
			If the indicator is off, the port does not function as a CON/AUX port.
10	RST	CAUTION The Reset button is used for resetting the device manually. Resetting the device will cause service interruption; therefore, confirm the action before you reset the device.	

7.3 Power Indicators

This section describes the power indicators.

HW-100-48AC14D

Figure 7-4 shows the indicator of the HW-100-48AC14D.

Figure 7-4 Indicator of the HW-100-48AC14D



Table 7-4 Description of the HW-100-48AC14D indicators

Indicator	Color	Description
Power indicator	Blue	If the indicator is steady on, the output power is in the normal range.
		If the indicator is off, the power supply unit does not have output power.

PWR150A

Figure 7-5 shows the indicator of the PWR150A.

Figure 7-5 Indicator of the PWR150A



Table 7-5 Description of the PWR150A indicators

Indicator	Color	Description
Power indicator (STATUS)	Green	If the indicator is steady on, the power supply unit functions properly.

Indicator	Color	Description
		If the indicator blinks, the output power is out of range, for example, overvoltage, overcurrent, and short-circuit.
		If the indicator is off, the input power is out of range, for example no AC input, overvoltage, and undervoltage, or the output power is out of range, for example, undervoltage and overtemperature.

8 List of Cards

About This Chapter

This chapter describes the types and technical specifications of cards on the AR routers.

[8.1 Cards Supported by the AR](#)

This section describes the cards supported by AR routers, including SRUs, Ethernet LAN interface cards, WAN interface cards, voice interface cards, and xDSL/xPON interface cards.

[8.2 Power Consumption and Weight](#)

This section describes the power consumption and weight of cards supported by the AR routers.

8.1 Cards Supported by the AR

This section describes the cards supported by AR routers, including SRUs, Ethernet LAN interface cards, WAN interface cards, voice interface cards, and xDSL/xPON interface cards.

Matching between physical cards and software versions

Table 8-1 Matching between physical cards and software versions

Model&Version		SIC	WSIC	XSIC	voice card
ARV200R001C01&ARV200R002C00&ARV200R002C01	AR1220-S	√	√	×	×
	AR1220W-S	√	√	×	×
	AR2220-S	√	√	√	√

Matching between SRUs and software versions

Table 8-2 Matching between SRUs and software versions

Model&Version		SRU	WLAN Subcard
ARV200R001C01&ARV200R002C00&ARV200R002C01	AR1220-S	×	×
	AR1220W-S	×	√
	AR2220-S	×	×

Matching between Ethernet LAN interface cards and software versions

Table 8-3 Matching between Ethernet LAN interface cards and software versions

Model&Version		8FE1GE	24GE
ARV200R001C01&ARV200R002C00&ARV200R002C01	AR1220-S	√	×
	AR1220W-S	√	×
	AR2220-S	√	√

Matching between WAN cards and software versions

Table 8-4 Matching between WAN cards and software versions

Model&Version		2FE	1E1 T1-M/2E1 T1-M (SIC)	2E1 T1-M (WSIC)	1E1 T1-F/2E1 T1-F	1SA	2SA	1GEC	8AS	1BST	1CPOS-155M	3G-HSPA+7	4GEW-T	4GEW-S
ARV 200R 001C 01	AR1 220-S	√	√	×	√	√	√	√	√	√	×	×	×	×
	AR1 220 W-S	√	√	×	√	√	√	√	√	√	×	×	×	×
	AR2 220-S	√	√	×	√	√	√	√	√	√	√	×	×	×
ARV 200R 002C 00	AR1 220-S	√	√	√	√	√	√	√	√	√	×	×	×	×
	AR1 220 W-S	√	√	√	√	√	√	√	√	√	×	×	×	×
	AR2 220-S	√	√	√	√	√	√	√	√	√	√	×	×	×
ARV 200R 002C 01	AR1 220-S	√	√	√	√	√	√	√	√	√	×	√	√	√
	AR1 220 W-S	√	√	√	√	√	√	√	√	√	×	√	√	√
	AR2 220-S	√	√	√	√	√	√	√	√	√	√	√	√	√

Matching between voice cards and software versions

Table 8-5 Matching between voice cards and software versions

Model&Version		4FXS1FXO	2BST(SIC)	2BST(WSIC)	16/32/64/128-Channel DSP Module
ARV200R001C01	AR1220-S	×	×	×	×
	AR1220W-S	×	×	×	×
	AR2220-S	√	√	×	√
ARV200R002C00&ARV200R002C01	AR1220-S	×	×	×	×
	AR1220W-S	×	×	×	×
	AR2220-S	√	√	√	√

Matching between xDSL/xPON cards and software versions

Table 8-6 Matching between xDSL/xPON cards and software versions

Model&Version		ADSL-A/M	ADSL-B	4G.SHDSL	1PON	VDSL
ARV200R001C01	AR1220-S	√	√	√	×	×
	AR1220W-S	√	√	√	×	×
	AR2220-S	√	√	√	×	×
ARV200R002C00	AR1220-S	√	√	√	√	×
	AR1220W-S	√	√	√	√	×
	AR2220-S	√	√	√	√	×

Model&Version		ADSL-A/M	ADSL-B	4G.SHDSL	1PON	VDSL
ARV200R002C01	AR1220-S	√	√	√	√	√
	AR1220W-S	√	√	√	√	√
	AR2220-S	√	√	√	√	√

8.2 Power Consumption and Weight

This section describes the power consumption and weight of cards supported by the AR routers.

Table 8-7 describes the power consumption and weight of cards supported by the AR routers. The table describes the power consumption of the cards operating at 25°C (80°F).

Table 8-7 Power consumption and weight of cards supported by the AR1200-S

Card Name	Maximum Power Consumption	Weight
8FE1GE	12.036 W	0.6 kg (1.33 lb)
1GEC	2.28 W	0.25 kg (0.55 lb)
2FE	3.01 W	0.3 kg (0.67 lb)
1E1T1-M/ 2E1T1-M	7 W	0.3 kg (0.67 lb)
1E1T1-F/2E1T1-F	7 W	0.3 kg (0.67 lb)
1SA/2SA	<ul style="list-style-type: none"> ● 1SA: 10 W ● 2SA: 11.7 W 	0.3 kg (0.67 lb)
8AS	8.9 W	0.6 kg (1.33 lb)
1BST	12 W	0.3 kg (0.67 lb)
2BST	16.8 W	0.3 kg (0.67 lb)
4FXS1FXO	12.78 W	0.3 kg (0.67 lb)
ADSL-A/M ADSL-B	5.4 W	0.3 kg (0.67 lb)
4G.SHDSL	8.2 W	0.35 kg (0.77 lb)

9 List of Interface Attributes

About This Chapter

This section describes the interface attributes supported by the AR routers.

[9.1 Electrical Interfaces](#)

This section describes the attributes of electrical interfaces.

[9.2 GE/PON Optical Interface Attributes](#)

This section describes the attributes of GE/PON optical interfaces.

[9.3 CPOS Interface Attributes](#)

This section describes the CPOS interface attributes.

[9.4 E1 Interface Attributes](#)

This section describes the attributes of E1 interfaces.

[9.5 T1 Interface Attributes](#)

This section describes the attributes of T1 interfaces.

[9.6 Synchronous/Asynchronous Serial Interface Attributes](#)

This section describes the attributes of synchronous/asynchronous serial interfaces.

[9.7 ISDN S/T Interface Attributes](#)

This section describes ISDN S/T interface attributes.

[9.8 FXS/FXO Interface Attributes](#)

This section describes the attributes of FXS/FXO interfaces.

[9.9 ADSL2/ADSL2+/G.SHDSL Interface Attributes](#)

This section describes the attributes of ADSL2/ADSL2+/G.SHDSL interfaces.

[9.10 Attributes of the Console Interface](#)

This section describes the attributes of the console interface.

[9.11 Attributes of the USB Interface](#)

This section describes the attributes of the USB interface.

[9.12 3G Interface Attributes](#)

This section describes the attributes of 3G interfaces.

9.13 VDSL Interface Attributes

This section describes the attributes of the VDSL interface.

9.1 Electrical Interfaces

This section describes the attributes of electrical interfaces.

Table 9-1 describes the attributes of 10BASE-TX/100BASE-TX electrical interfaces.

Table 9-1 Attributes of 10BASE-TX/100BASE-TX electrical interfaces

Item	Description
Connector type	RJ45
Interface attribute	MDI/MDIX NOTE <ul style="list-style-type: none">• The interfaces of most network cards are medium dependent interfaces (MDIs).• MDIX interfaces are usually used on hubs or LAN switches.
Standards compliance	IEEE802.3, IEEE802.3u, IEEE802.3ab
Frame format	Ethernet_II, Ethernet_SAP, or Ethernet_SNAP
Network layer protocol	IP

Table 9-2 describes the attributes of 1000BASE-T electrical interfaces.

Table 9-2 Attributes of 1000BASE-T electrical interfaces

Item	Description
Connector type	RJ45
Interface attribute	MDI/MDIX NOTE <ul style="list-style-type: none">• The interfaces of most network cards are medium dependent interfaces (MDIs).• MDIX interfaces are usually used on hubs or LAN switches.
Standards compliance	IEEE802.3, IEEE802.3u, IEEE802.3ab
Frame format	Ethernet_II, Ethernet_SAP, or Ethernet_SNAP
Network layer protocol	IP

9.2 GE/PON Optical Interface Attributes

This section describes the attributes of GE/PON optical interfaces.

A GE optical interface can be connected to an optical module. [Table 9-3](#) and [Table 9-4](#) describe the attributes of optical interfaces and optical modules.

Table 9-3 Attributes of the 100/1000BASE-X GE optical interface

Attribute	Description
Connector type	LC/PC
Optical interface attribute	Depending on the SFP optical module.
Standards compliance	IEEE 802.3ab
Frame format	Ethernet_II, Ethernet_SAP, or Ethernet_SNAP
Network layer protocol	IP

Table 9-4 Attributes of the SFP optical module (100/1000 Mbit/s) supported by the GE optical interface

Attribute	Description							
	500 m	10 km	10 km (single-mode bidirectional fiber)		40 km	40 km	80 km	100 km
Transmission distance	500 m	10 km	10 km (single-mode bidirectional fiber)		40 km	40 km	80 km	100 km
Center wavelength	850 nm	1310 nm	Tx: 1310 nm Rx: 1490 nm	Tx: 1490 nm Rx: 1310 nm	1310 nm	1550 nm	1550 nm	1550 nm
Transmitting power	-9.5 dBm to -2.5 dBm	-9.0 dBm to -3.0 dBm	-9.0 dBm to -3.0 dBm	-9.0 dBm to -3.0 dBm	-5.0 dBm to 0 dBm	-5.0 dBm to 0 dBm	-2.0 dBm to 5.0 dBm	0 dBm to 5 dBm

Attribute	Description							
Receiver sensitivity	-17.0 dBm	-20.0 dBm	-19.5 dBm	-19.5 dBm	-23 dBm	-22 dBm	-23.0 dBm	-30.0 dBm
Overload optical power	0 dBm	-3.0 dBm	-3.0 dBm	-3.0 dBm	-3.0 dBm	-3.0 dBm	-3.0 dBm	-9.0 dBm
Extinction ratio	9 dB	9 dB	6 dB	6 dB	9 dB	8.5 dB	9 dB	8 dB
Fiber type	Multi-mode	Single-mode						

Table 9-5 Attributes of the SFP optical module supported by the PON optical interface

Attribute	Description	
Connector type	SC/PC connector (SFP encapsulation)	
Transport mode	Single-mode bidirectional	
Transmission rate	<ul style="list-style-type: none"> ● Downstream transmission rate of 2488 Mbit/s ● Upstream transmission rate of 1244 Mbit/s 	
Standards compliance	ITU-T G.984.2 CLASS B+ ITU-T G.984.5 WBF	
Sending end	Center wavelength	1290 nm to 1330 nm
	Average transmitting optical power	0.5 dBm to 5 dBm
	Average turn-off optical power	-45 dBm
	Side-mode suppression ratio	30 dB
	Extinction ratio	10 dB to 15 dB
Receiving end	Overload power	-8 dBm

Attribute		Description
	Input wavelength range	1480 nm to 1500 nm
Operating temperature		0°C to 70°C

9.3 CPOS Interface Attributes

This section describes the CPOS interface attributes.

A CPOS optical interface can be connected to an optical module. [Table 9-6](#) and [Table 9-7](#) describe the attributes of optical interfaces and optical modules.

Table 9-6 CPOS interface attributes

Attribute	Description
Connector type	LC/PC
Optical interface attribute	Depending on the SFP optical module
Standards compliance	STM-1
Frame format	SDH/SONET
Network layer protocol	IP

Table 9-7 Attributes of the SFP optical module supported by the CPOS interface

Attribute	Description			
Transmission distance	2 km	15 km	40 km	80 km
Center wavelength	1310 nm	1310 nm	1310 nm	1550 nm
Transmitting power	-19.0 dBm to -14.0 dBm	-15.0 dBm to 8.0 dBm	-15.0 dBm to 8.0 dBm	-3.0 dBm to 0 dBm
Receiver sensitivity	-28.0 dBm	-23.0 dBm	-23.0 dBm	-32.98 dBm
Overload optical power	-14.0 dBm	-10.17 dBm	-8.0 dBm	-8.0 dBm

Attribute	Description			
Extinction ratio	>10.0 dB	58.86 dB	14.08 dB	43.09 dB
Fiber type	Multimode	Single-mode		

9.4 E1 Interface Attributes

This section describes the attributes of E1 interfaces.

Table 9-8 describes the attributes of channelized E1 interfaces.

Table 9-8 Attributes of channelized E1 interfaces

Attribute	Description
Connector type	DB9
Standards compliance	G.703 or G.704
Transmission rate	2.048 Mbit/s
Cable type	E1 75-ohm unbalanced coaxial cable E1 120-ohm balanced twisted pair cable E1 trunk cable extension
Working mode	CE1, ISDN PRI, or VE1
Function	Backup Terminal access ISDN PRI

Table 9-9 describes the attributes of unchannelized E1 interfaces.

Table 9-9 Attributes of unchannelized E1 interfaces

Attribute	Description
Connector type	DB9
Standards compliance	G.703 or G.704
Transmission rate	2.048 Mbit/s
Cable type	E1 75-ohm unbalanced coaxial cable E1 120-ohm balanced twisted pair cable E1 trunk cable extension

Attribute	Description
Working mode	Unchannelized E1
Function	Backup Terminal access

9.5 T1 Interface Attributes

This section describes the attributes of T1 interfaces.

Table 9-10 describes the attributes of channelized T1 interfaces.

Table 9-10 Attributes of channelized T1 interfaces

Attribute	Description
Connector type	DB9
Standards compliance	G.703 or G.704
Transmission rate	1.544 Mbit/s
Cable type	T1 100-ohm coaxial cable
Working mode	CT1, ISDN PRI, or VT1
Function	Backup Terminal access ISDN PRI

Table 9-11 describes the attributes of unchannelized T1 interfaces.

Table 9-11 Attributes of unchannelized T1 interfaces

Attribute	Description
Connector type	DB9
Standards compliance	G.703 or G.704
Transmission rate	1.544 Mbit/s
Cable type	T1 100-ohm coaxial cable
Working mode	Unchannelized T1
Function	Backup Terminal access

9.6 Synchronous/Asynchronous Serial Interface Attributes

This section describes the attributes of synchronous/asynchronous serial interfaces.

Table 9-12 describes the attributes of synchronous/asynchronous serial interfaces.

Table 9-12 Attributes of synchronous/asynchronous serial interfaces

Attribute	Description		
	Synchronous Serial Interface	Asynchronous Serial Interface	
Connector type	DB28		
Standards compliance and working mode	<ul style="list-style-type: none"> ● V.24 DTE ● V.24 DCE 	<ul style="list-style-type: none"> ● V.35 DTE ● V.35 DCE ● X.21 DTE ● RS449 DTE ● RS449 DCE ● RS530 DTE ● RS530 DCE 	RS232
Minimum baud rate (bit/s)	1200	1200	600
Maximum baud rate (bit/s)	64 k	2.048 M	115.2 k
Cable type	<ul style="list-style-type: none"> ● V.24 DTE cable ● V.24 DCE cable ● V.35 DTE cable ● V.35 DCE cable ● X.21 DTE cable ● RS449 DTE cable ● RS449 DCE cable ● RS530 DTE cable ● RS530 DCE cable 		
Function	DDN leased line	<ul style="list-style-type: none"> ● Modem dial-up ● Backup 	
	Terminal access	<ul style="list-style-type: none"> ● Asynchronous leased line ● Terminal access 	

Table 9-13 describes the attributes of asynchronous serial interfaces.

Table 9-13 Attributes of asynchronous serial interfaces

Attribute	Description
Connector type	RJ45
Standards compliance and working mode	RS232
Minimum baud rate (bit/s)	300
Maximum baud rate (bit/s)	115.2 k
Cable type	Customized RJ45 cable
Function	<ul style="list-style-type: none">● Modem dial-up● Backup● Asynchronous leased line● Terminal access

9.7 ISDN S/T Interface Attributes

This section describes ISDN S/T interface attributes.

Table 9-14 lists ISDN S/T interface attributes.

Table 9-14 ISDN S/T interface attributes

Item	Description
Connector	RJ45
Standards compliance	ITU-T I.430, Q.921, Q.931
Rate	192 kbit/s
Bandwidth	0 to 100 MHz
Cable	<ul style="list-style-type: none">● TE: standard ISDN S/T interface cables (straight-through cables)● NT: ISDN S/T interface crossover cables

9.8 FXS/FXO Interface Attributes

This section describes the attributes of FXS/FXO interfaces.

Table 9-15 describes the attributes of FXS/FXO (RJ11) interfaces on the 4FXS1FXO.

Table 9-15 Attributes of FXS/FXO (RJ11) interfaces

Attribute	Description
Connector type	RJ11
Standards compliance	ITU Q.512 for FXS interfaces ITU Q.552 for FXO interfaces ITU K.20 for protection against overcurrent and overvoltage
Cable type	Regular telephone line
Dialing mode	DTMF in accordance with GB3378 Pulse dialing
Bandwidth	300 Hz to 3400 Hz

Table 9-16 describes the attributes of FXS (DB68) interfaces on the 32FXS/16FXS.

Table 9-16 Attributes of FXS (DB68) interfaces

Attribute	Description
Connector type	DB68
Standards compliance	IEEE 1284C Interface as a 36 contact connector
Cable type	Twisted pair
Dialing mode	DTMF in accordance with GB3378 Pulse dialing
Bandwidth	300 Hz to 3400 Hz

Table 9-17 describes the attributes of FXO (RJ11) interfaces on the 4FXO.

Table 9-17 Attributes of FXO (RJ11) interfaces

Attribute	Description
Connector type	RJ11
Standards compliance	ITU Q.552 for FXO interfaces ITU K.20 for protection against overcurrent and overvoltage
Cable type	Telephone cable
Dialing mode	DTMF in accordance with GB3378 Pulse dialing

Attribute	Description
Bandwidth	300 Hz to 3400 Hz

9.9 ADSL2/ADSL2+/G.SHDSL Interface Attributes

This section describes the attributes of ADSL2/ADSL2+/G.SHDSL interfaces.

Table 9-18 describes the attributes of ADSL2/ADSL2+ interfaces.

Table 9-18 Attributes of ADSL2/ADSL2+ interfaces

Attribute	Description
Connector type	RJ11
Standards compliance	ADSL-A/M: ITU-T 992.1 G.DMT ITU-T 992.3 ITU-T 992.5
	ADSL-B: ITU-T 992.1 G.DMT ANSI T1.413 Issue 2 ITU-T 992.3 ITU-T 992.5
Transmission rate	ADSL-A/M: <ul style="list-style-type: none">● ADSL full rate mode (ITU-T 992.1 G.DMT): a downstream transmission rate of 8 Mbit/s and an upstream transmission rate of 1024 kbit/s● ADSL2 full rate mode (ITU-T 992.3): a downstream transmission rate of 12 Mbit/s and an upstream transmission rate of 1024 kbit/s● ADSL2+ full rate mode (ITU-T 992.5): a downstream transmission rate of 24 Mbit/s and an upstream transmission rate of 1024 kbit/s
	ADSL-B: A downstream transmission rate of 8 Mbit/s and an upstream transmission rate of 1024 kbit/s
Cable type	Regular telephone line

Table 9-19 describes the attributes of G.SHDSL interfaces.

Table 9-19 Attributes of G.SHDSL interfaces

Attribute	Description
Connector type	One RJ45 connector on one end and four RJ11 connectors on the other end
Standards compliance	G.SHDSL.bit
Transmission rate	5.696 Mbit/s per pair

9.10 Attributes of the Console Interface

This section describes the attributes of the console interface.

Table 9-20 lists the attributes of the console interface.

Table 9-20 Attributes of the console interface

Item	Description
Connector type	RJ45
Standards compliance	RS232
Operating mode	Full duplex Universal Asynchronous Receiver/Transmitter (UART)
Data equipment type	Data Circuit-terminating Equipment (DCE)

Table 9-21 lists the attributes of the MiniUSB-B interface.

Table 9-21 Attributes of the MiniUSB-B interface

Item	Description
Connector type	MiniUSB-B, angle
Standards compliance	USB1.0
Operating mode	Device

9.11 Attributes of the USB Interface

This section describes the attributes of the USB interface.

Table 9-22 lists the attributes of the USB-A interface.

Table 9-22 Attributes of the USB-A interface

Item	Description
Connector type	USB-A
Standards compliance	USB2.0, compatible with USB1.0 and USB1.1
Operating mode	Host

9.12 3G Interface Attributes

This section describes the attributes of 3G interfaces.

Table 9-23 lists the attributes of 3G interfaces.

Table 9-23 3G interface attributes

Item	Description
Connector	SMA RF: connects to an antenna to provide wireless access. mini USB: connects to a USB flash drive with third-party wireless network test software, for example, Qualcomm CAIT.
Standards compliance and frequency bands supported	GSM/GPRS/EDGE: 850/900/1800/1900 (MHz) HSPA+/HSUPA/HSDPA/WCDMA: 2100/1900/900/850 (MHz)
Rate	GSM CS: <ul style="list-style-type: none"> ● Upstream (Tx): 9.6kbit/s ● Downstream (Rx): 9.6kbit/s GPRS/EDGE: Multi-slot Class 12, Class B WCDMA CS: <ul style="list-style-type: none"> ● Upstream (Tx): 64 kbit/s ● Downstream (Rx): 64 kbit/s WCDMA PS: <ul style="list-style-type: none"> ● Upstream (Tx): 384 kbit/s ● Downstream (Rx): 384 kbit/s HSPA: <ul style="list-style-type: none"> ● Upstream (Tx): 5.76 Mbit/s ● Downstream (Rx): 14.4 Mbit/s HSPA+: <ul style="list-style-type: none"> ● Upstream (Tx): 5.76 Mbit/s ● Downstream (Rx): 21 Mbit/s
Network protocol	WCDMA/HSPA/GPRS/EDGE

9.13 VDSL Interface Attributes

This section describes the attributes of the VDSL interface.

Table 9-24 lists attributes of the VDSL interface.

Table 9-24 VDSL interface attributes

Item	Description
Connector	RJ11
Standards compliance	VDSL standards: ITU-T 993.2 ITU-T 992.5 ITU-T 992.3 ITU-T 992.1 G.DMT
Rate	<ul style="list-style-type: none">● ADSL2+ full rate mode (ITU-T 992.3): a downstream transmission rate of 12 Mbit/s and an upstream transmission rate of 1 Mbit/s● VDSL2 mode (ITU-T 993.2): a downstream transmission rate of 100 Mbit/s and an upstream transmission rate of 50 kbit/s● ADSL2 full rate mode (ITU-T 992.5): a downstream transmission rate of 24 Mbit/s and an upstream transmission rate of 1 Mbit/s● ADSL full rate mode (ITU-T 992.1 G.DMT): a downstream transmission rate of 8 Mbit/s and an upstream transmission rate of 1 Mbit/s
Cable type	Telephone cable