

Huawei
AR120&AR150&AR160&AR200&AR500&AR510&A
R1200&AR2200&AR3200&AR3600 Series
Enterprise Routers
V200R006C10

Product Description

Issue **01**
Date **2015-02-28**

Copyright © Huawei Technologies Co., Ltd. 2015. All rights reserved.

No part of this document may be reproduced or transmitted in any form or by any means without prior written consent of Huawei Technologies Co., Ltd.

Trademarks and Permissions



HUAWEI and other Huawei trademarks are trademarks of Huawei Technologies Co., Ltd.

All other trademarks and trade names mentioned in this document are the property of their respective holders.

Notice

The purchased products, services and features are stipulated by the contract made between Huawei and the customer. All or part of the products, services and features described in this document may not be within the purchase scope or the usage scope. Unless otherwise specified in the contract, all statements, information, and recommendations in this document are provided "AS IS" without warranties, guarantees or representations of any kind, either express or implied.

The information in this document is subject to change without notice. Every effort has been made in the preparation of this document to ensure accuracy of the contents, but all statements, information, and recommendations in this document do not constitute a warranty of any kind, express or implied.

Huawei Technologies Co., Ltd.

Address: Huawei Industrial Base
Bantian, Longgang
Shenzhen 518129
People's Republic of China

Website: <http://enterprise.huawei.com>

About This Document

Intended Audience



This document helps you understand the characteristics and features of the AR.



This document is intended for:

- Network planning engineers
- Hardware installation engineers
- Commissioning engineer
- Data configuration engineers
- On-site maintenance engineers
- Network monitoring engineers
- System maintenance engineers

Symbol Conventions

The symbols that may be found in this document are defined as follows.

Symbol	Description
 DANGER	Indicates an imminently hazardous situation which, if not avoided, will result in death or serious injury.
 WARNING	Indicates a potentially hazardous situation which, if not avoided, could result in death or serious injury.
 CAUTION	Indicates a potentially hazardous situation which, if not avoided, may result in minor or moderate injury.

Symbol	Description
 NOTICE	Indicates a potentially hazardous situation which, if not avoided, could result in equipment damage, data loss, performance deterioration, or unanticipated results. NOTICE is used to address practices not related to personal injury.
 NOTE	Calls attention to important information, best practices and tips. NOTE is used to address information not related to personal injury, equipment damage, and environment deterioration.

Security Conventions

- Password setting
 - When configuring a password, the cipher text is recommended. To ensure device security, change the password periodically.
 - When you configure a password in plain text that starts and ends with %@%@ (the password can be decrypted by the device), the password is displayed in the same manner as the configured one in the configuration file. Do not use this setting.
 - When you configure a password in cipher text, different features cannot use the same cipher-text password. For example, the cipher-text password set for the AAA feature cannot be used for other features.
- Encryption algorithm

Currently, the device uses the following encryption algorithms: 3DES, AES, RSA, SHA1, SHA2, and MD5. 3DES, RSA and AES are reversible, while SHA1, SHA2, and MD5 are irreversible. The encryption algorithms DES/3DES/RSA (RSA-1024 or lower)/MD5 (in digital signature scenarios and password encryption)/SHA1 (in digital signature scenarios) have a low security, which may bring security risks. If protocols allowed, using more secure encryption algorithms, such as AES/RSA (RSA-2048 or higher)/SHA2/HMAC-SHA2, is recommended. The encryption algorithm depends on actual networking. The irreversible encryption algorithm must be used for the administrator password, SHA2 is recommended.
- Personal data

Some personal data may be obtained or used during operation or fault location of your purchased products, services, features, so you have an obligation to make privacy policies and take measures according to the applicable law of the country to protect personal data.
- The terms mirrored port, port mirroring, traffic mirroring, and mirroring in this manual are mentioned only to describe the product's function of communication error or failure detection, and do not involve collection or processing of any personal information or communication data of users.

Mappings Between Product Software Versions and NMS Versions

The mappings between product software versions and NMS versions are as follows.

AR120&AR150&AR160&AR200&AR500&AR510&AR1200&AR2200&AR3200&AR3600 Product Software Version	eSight	iManager U2000
V200R006C10	V300R003C00	V200R015C50

Change History

Changes between document issues are cumulative. Therefore, the latest document version contains all updates made to previous versions.

Changes in Issue 01 (2015-02-28)

Initial commercial release.

Contents

About This Document.....	ii
1 Product Positioning and Characteristics.....	1
1.1 Product Positioning.....	2
1.2 Product Characteristics.....	2
1.2.1 Carrier-Class Reliability.....	3
1.2.2 Service Integration Capability.....	3
1.2.3 Hardware Extensibility.....	3
1.2.4 Remote Maintenance Capability.....	3
2 Network Applications.....	4
2.1 WAN Access.....	5
2.2 VPN Access.....	6
2.3 Application of Enterprise Intranet Security.....	6
2.4 Voice Application.....	8
2.5 FTTx.....	9
2.6 OSP Application.....	10
2.7 Intelligent Bus Application.....	12
3 Product Characteristics.....	14
3.1 Feature List.....	15
3.2 Key Features.....	31
3.2.1 Voice.....	31
3.2.2 WAN.....	35
3.2.3 VPN.....	37
3.2.4 Security.....	38
3.2.5 QoS.....	40
3.2.6 WLAN.....	41
3.2.7 IPv6.....	43
4 Appearance.....	44
4.1 AR120 Series.....	45
4.2 AR150 Series.....	46
4.3 AR160 Series.....	60
4.4 AR200 Series.....	81

4.5 AR500 Series.....	91
4.6 AR510 Series.....	95
4.7 AR1200 Series.....	104
4.8 AR2200 Series.....	118
4.9 AR3200 Series.....	129
4.10 AR3600 Series.....	131
5 Operation and Maintenance.....	134
5.1 Various Maintenance Methods.....	135
5.1.1 Command Line Maintenance.....	135
5.1.2 Web-based Network Management System.....	135
5.1.3 CWMP Maintenance.....	135
5.1.4 Remote Deployment and Maintenance Using USB.....	135
5.1.5 SNMP-based Maintenance.....	135
5.2 Fault Location.....	136
5.2.1 Device Fault Location.....	136
5.2.2 Service Fault Location.....	136
6 Technical Specifications.....	137
6.1 AR120 Series.....	138
6.2 AR150 Series.....	139
6.3 AR160 Series.....	142
6.4 AR200 Series.....	144
6.5 AR500 Series.....	146
6.6 AR510 Series.....	148
6.7 AR1200 Series.....	151
6.8 AR2200 Series.....	154
6.9 AR3200 Series.....	159
6.10 AR3600 Series.....	162
7 Component Selection Guide.....	165
7.1 Router Purchase List.....	166
7.2 Board Purchase List.....	174

1 Product Positioning and Characteristics

About This Chapter

[1.1 Product Positioning](#)

[1.2 Product Characteristics](#)

1.1 Product Positioning

NOTICE

AR Series Enterprise Routers are class A products. Customers should take preventative measures as the operating devices may cause radio interference.

AR series enterprise routers (ARs) include AR120, AR150, AR160, AR200, AR500, AR510, AR1200, AR2200, AR3200, and AR3600. They are the next-generation routing and gateway devices, which provide the routing, switching, wireless, voice, and security functions.

As shown in [Figure 1-1](#), the ARs are located between an enterprise network and a public network, functioning as the only ingress and egress for data transmitted between the two networks. The deployment of various network services over the ARs reduces operation & maintenance (O&M) costs as well as those associated with establishing an enterprise network. You can select ARs of different specifications as egress gateways based on the user quantity of an enterprise.

Figure 1-1 ARs on the network

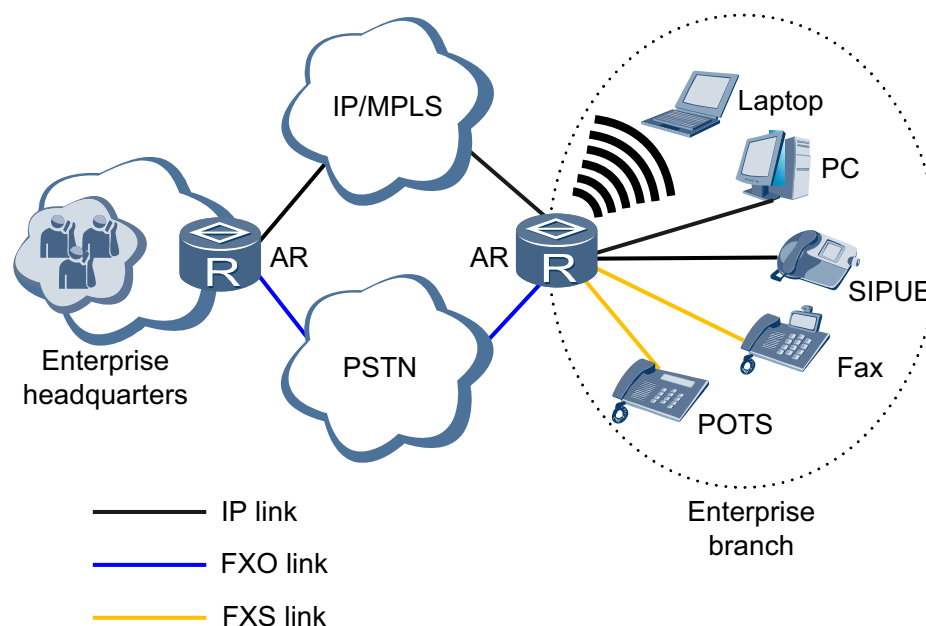

1.2 Product Characteristics

The ARs use leading hardware platforms and software architectures. The ARs provide integrated network solutions to enterprise customers with minimum investment costs; therefore, they can meet the many facets of future business expansion and IT industry developments.

1.2.1 Carrier-Class Reliability

- The boards are hot swappable and guarantee carrier-class reliability.
- The ARs are designed to provide quality service and comply with telecommunication standards.
- The ARs protect networks against attacks.
- The ARs support in-service patching so that the system software can be upgraded during system operation.
- The AR2240, AR3670, and AR3260 support redundant power supply units. If one power supply unit is faulty, the AR2240 and AR3260 will still be able to operate.
- The AR3260 provides dual SRUs in redundancy mode. When a fault occurs on the control, forwarding, or switching plane, services can be smoothly switched to the standby SRU.

1.2.2 Service Integration Capability

The AR series routers integrate various services of routers, switches, and wireless devices, including voice, firewall, WLAN, 3G/LTE, and VPN.

1.2.3 Hardware Extensibility

The ARs provide the highest port density in the industry and flexible slot combination, allowing enterprise customers to connect to LAN, WAN, or wireless networks. The ARs provide the most economical enterprise network solutions.

The ARs support flexible slot combination. For example, two SIC slots can be combined into a wide SIC (WSIC) slot, two SIC slots and one WSIC slot below can be combined into one XSIC slot by removing guide rails, and two multiple-function slots (MFSs) can be combined into an SRU slots by removing the guide rail between them.

NOTE

- AR150&160&200 series, AR510 series, AR2201-48FE and AR2202-48FE do not support subcards.
- The WSIC card can be installed in the WSIC or XSIC slot.

1.2.4 Remote Maintenance Capability

In addition to one-stop deployment, plug and play capability, and remote commissioning functions, the ARs manage the customer premises equipment (CPE) remotely. The remote maintenance function improves efficiency and greatly reduces maintenance costs.

2 Network Applications

About This Chapter

- [2.1 WAN Access](#)
- [2.2 VPN Access](#)
- [2.3 Application of Enterprise Intranet Security](#)
- [2.4 Voice Application](#)
- [2.5 FTTx](#)
- [2.6 OSP Application](#)
- [2.7 Intelligent Bus Application](#)

2.1 WAN Access

Depending on the network environment provided by carriers, users can access the network by using interfaces including FE/GE/10GE interfaces, synchronous/asynchronous serial interface, Async interface, CE1/CT1 PRI interfaces, E1-F interfaces, T1-F interfaces, 3G/LTE cellular interfaces, Integrated Services Digital Network BRI interfaces, PoS interfaces, CPoS interfaces, ADSL interfaces, VDSL interfaces, G.SHDSL interfaces, E1-IMA interfaces, CE3 interfaces, E&M interfaces, and xPON interfaces. The AR provides dual uplinks to implement interface backup and ensure service reliability.

NOTE

WAN interfaces depend on the device model and the boards installed.

As shown in **Figure 2-1**, enterprise A accesses the Internet using ADSL; enterprise B accesses the Internet using FE and E1/CE1 dual-uplink (E1/CE1 link functions as the backup link of the FE link); enterprise C accesses the Internet using G.SHDSL; enterprise D accesses the Internet using 3G. This setting achieves WAN interconnection.

Figure 2-1 WAN access

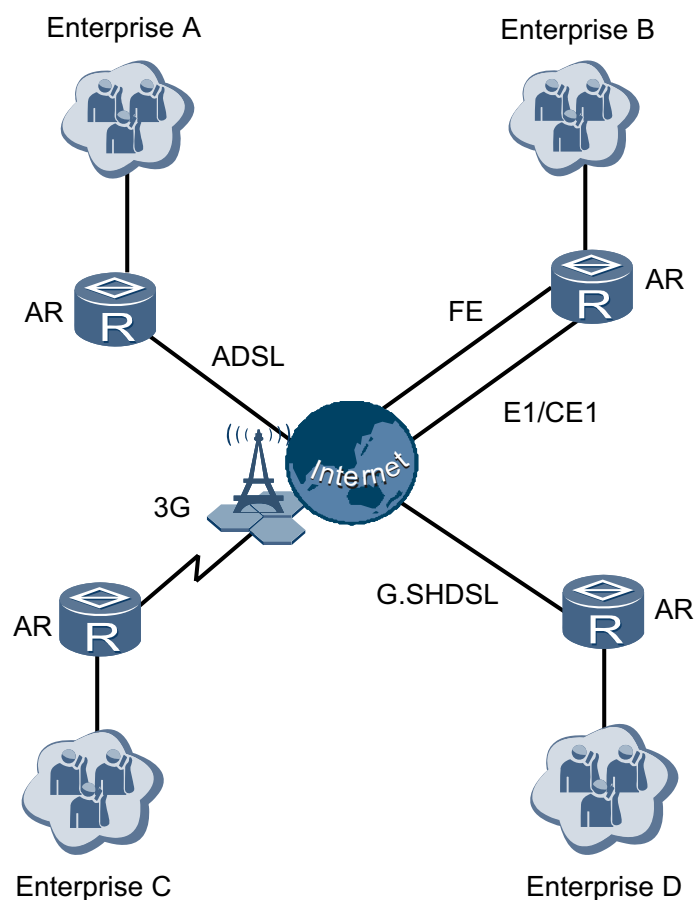

2.2 VPN Access

The headquarters and branches use the ARs to connect to the Internet, establish a VPN, and use VPN tunnels to secure data.

As shown in **Figure 2-2**, the headquarters is connected to the Internet through the AR2200&AR3200&AR3600. LANs of branches connect to the Internet through the AR150&160&200&1200&2200. The headquarters and branches use L2TP/GRE/MPLS/IPSec VPN tunnels, and the headquarters and traveling employees use L2TP/SSL/IPSec VPN tunnels to secure data. After branches and headquarters establish VPN tunnels, branches can communicate with each other through the headquarters. You can also deploy DSVPN to dynamically establish tunnels between branches. This method improves forwarding performance and efficiency, and reduces resource usage of the headquarters.

Figure 2-2 VPN access

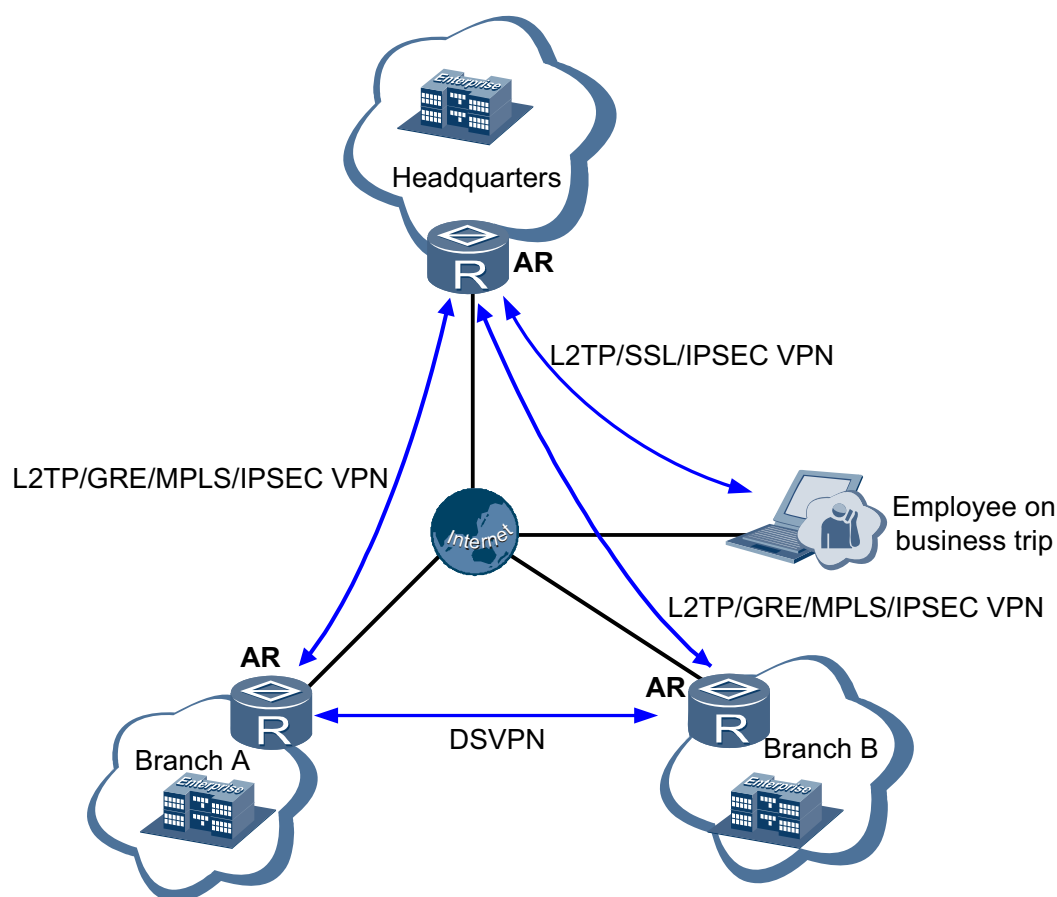

2.3 Application of Enterprise Intranet Security

The AR located between the enterprise intranet and external networks, ensures information security on the entire intranet and intranet LANs.

As shown in **Figure 2-3**, the enterprise intranet is connected to the external network through the AR. The AR can prevent external users from accessing the enterprise intranet. For example, external users can access the enterprise external server but cannot access the enterprise internal server. The financial department and marketing department have individual LANs on the intranet. To allow the users on the intranet to access the external network, configure network address translation (NAT) on the intranet.

The AR ensures information security on the enterprise intranet in the following modes:

- Enabling packet filtering or stateful firewall on the AR to isolate the enterprise intranet from external networks. This prevents unauthorized external users from accessing the intranet.
- The AR provides network access control (NAC) to restrict the access permissions of internal users. This ensures that only authorized users can access the intranet.
- IPS and URL filtering defend against attacks, provide secure environments for enterprise networks, and accurately manage network resources.
- IPS defends against attacks, provides secure environments for enterprise networks, and accurately manages network resources.

Figure 2-3 Application of enterprise intranet security

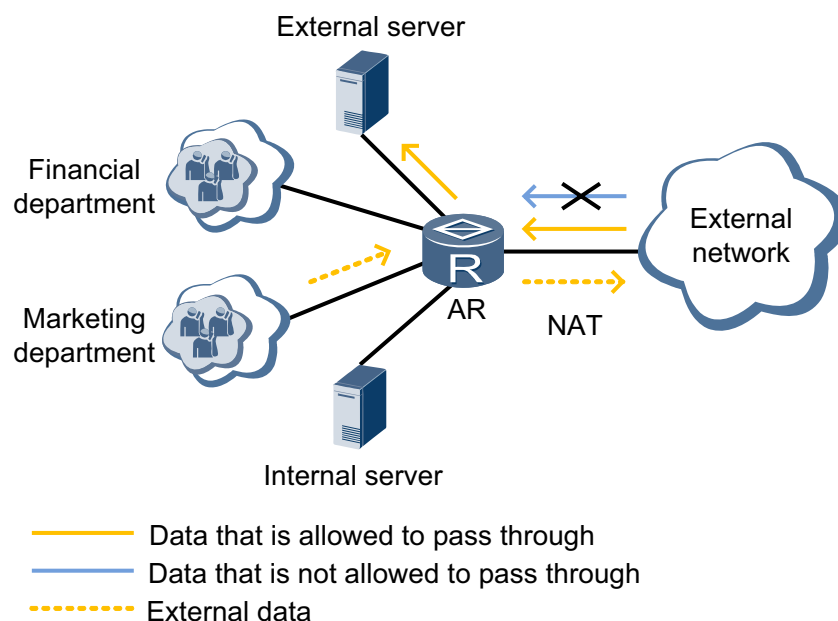

2.4 Voice Application

NOTE

- Among the AR150 series routers, only the AR157VWs and AR158EVWs support the voice features. Among the AR160 series routers, only the AR169FVWs and AR169FGVW-Ls support the voice features. Among the AR200 series routers, only the AR201VW-Ps, AR207Vs, AR207VWs, and AR207V-Ps support the voice features. Among the AR1200 series routers, only the AR1220Vs and AR1220VWs support the voice features. Among the AR2200 series routers, only the AR2204s, AR2220s, and AR2240s support the voice features. AR3200 series routers support the voice features. To use the voice feature on the AR2200 and AR3200 series routers, you must install the DSP module.
- To provide voice services for POTS users on the AR1200, AR2200, and AR3200 series routers, 4FXS1FXO, 16FXS or 32FXS card is required. The AR1200 series routers do not support 32FXS board.
- To provide voice services for ISDN users on the AR1200, AR2200, and AR3200 series routers, 2BST card is required.

An enterprise can build a voice communication system over the IP network, reducing operating expenses (OPEX).

Within the voice communication system, an AR can function as an IP PBX or SIP access gateway (AG). The AR connects to POTS users (analog phones or fax machines) and SIP user equipment (UE) users (IP phones or PC software terminals) through FXS or Ethernet interfaces. The AR connects to the PSTN through FXO or E1 interfaces or to the IP network through Ethernet interfaces.

Based on branch locations, the centralized or distributed call control model can be used. If all branches within an enterprise use the same number segment, the centralized call control model is recommended. If an enterprise has many branches that use different number segments, the distributed call control model is recommended.

As shown in [Figure 2-4](#), the enterprise headquarters and branch A use different number segments. The ARs working in IP PBX mode are deployed at the enterprise headquarters and branch A as egress routers. Voice users in the enterprise headquarters are registered with the AR in the enterprise headquarters, and voice users in each branch are registered with the AR in the branch. Voice traffic is transmitted between the enterprise headquarters and branches over voice routes. The AR of the enterprise headquarters provides voice routes to branches so that users in different branches can call each other.

Branch B and the enterprise headquarters are connected through the MAN. An AR working in IP PBX mode is deployed at the enterprise headquarters and an AR working in SIP AG mode is deployed at branch B. All voice users at the enterprise headquarters and branches are registered with the AR at the enterprise headquarters. The AR in the enterprise headquarters provides call control services for all users in the enterprise.

Figure 2-4 Voice application

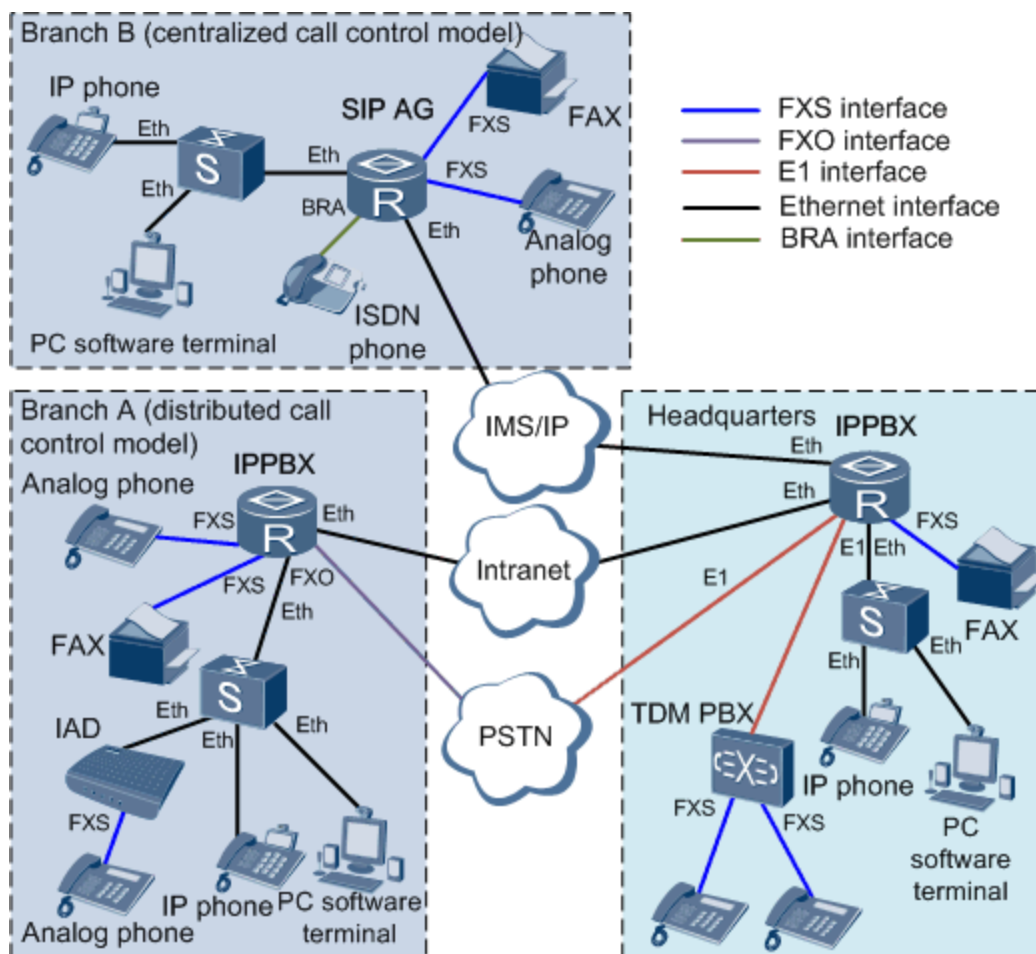

2.5 FTTx

By working with the optical line terminal (OLT), the ARs function as optical network unit (ONU) to provide fiber access to the enterprise. As shown in Figure 2-5, the ARs are connected to upstream devices through a passive optical network (PON), and provide fiber-to-the-home, fiber-to-the-building, and fiber-to-the-enterprise services.

The ARs provide the fiber-to-the-x (FTTx) service by connecting to upstream PON devices. This provides higher bandwidth than twisted-pair cable and guarantees the development of future high-speed services.

Figure 2-5 FTTx

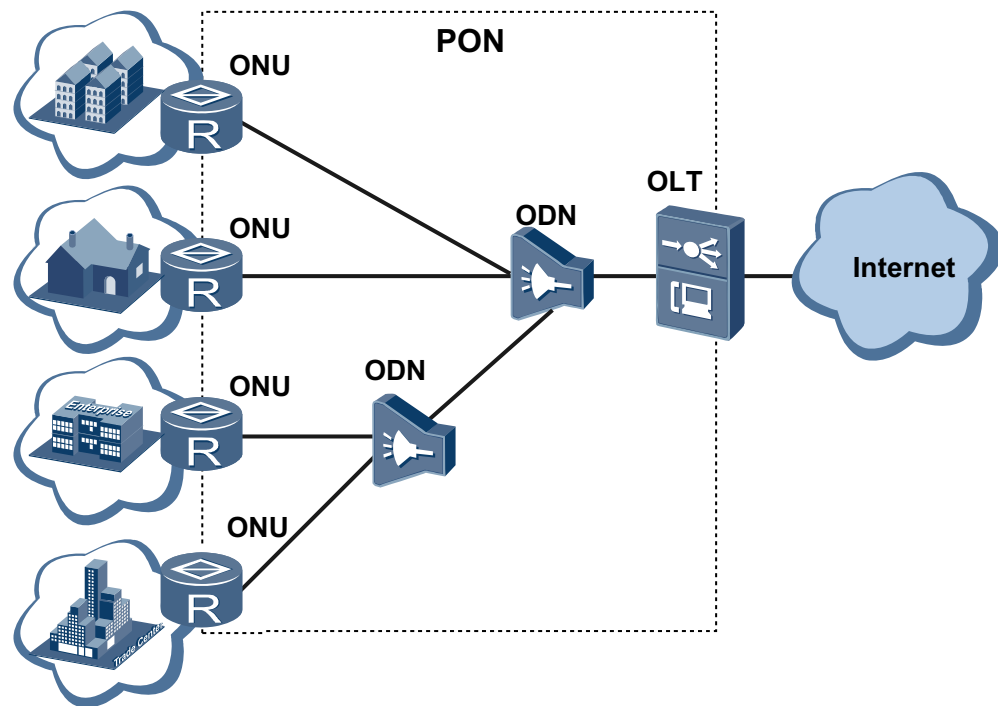

2.6 OSP Application

The AR router provides the open service platform (OSP) and unified hardware and software interfaces, which makes it easy for users to develop services. The OSP allows different vendors' software to be integrated. Customized services can be directly installed on the AR OSP, which saves fees for purchasing servers. In addition, service are uniformly managed by the OSP.

As shown in [Figure 2-6](#), the OSP is installed on the SAE board. Similar to an x86 server, the SAE board has independent CPU, hard disk, and memory, and provides external USB interface, Ethernet interfaces, console interfaces, and VGA interfaces. After the SAE board is installed, the router provides power for the board, manages the board, and implements data communication. After installing VMware, Linux or Windows on the SAE board, you can develop or install third-party software applications.

On the AR169-P-M9 and AR161FW-P-M5, the OSP is installed in the OSP card, as shown in [Figure 2-7](#). The OSP card is integrated in the AR. It has independent CPU and memory, provides external USB interface, audio interface, HDMI interface, and bluetooth interface.

Figure 2-6 OSP architecture (AR1200&2200&3200&AR3600)

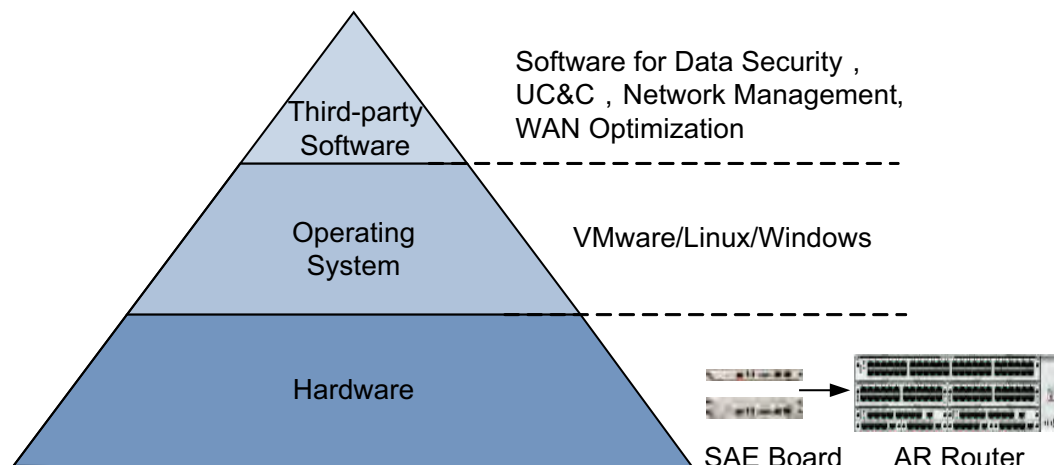
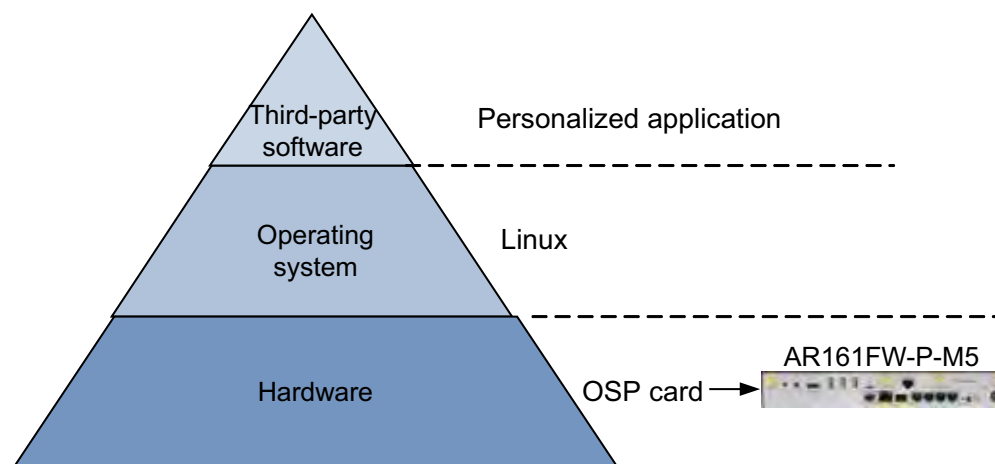

Figure 2-7 OSP architecture (AR169-P-M9&AR161FW-P-M5)



NOTE

SAE boards have two modules: SAE220 (WSIC) and SAE550 (XSIC). Different devices can be equipped with SAE boards of different quantities and models.

Table 2-1 Support for SAE boards

Model	SAE220	SAE550
AR150&160&200 series	0	0
AR1200 series	1	0
AR2201-48FE	0	0
AR2202-48FE	0	0
AR2204	2	0
AR2220	4	2

Model	SAE220	SAE550
AR2220E	4	2
AR2240	4	4
AR3260	4	6

2.7 Intelligent Bus Application

As shown in [Figure 2-8](#), the AR510 series can be deployed in the bus, bus stop, and advertising board. It can connect to the WLAN through 3G/LTE and provide Wi-Fi access. The AR510 provides the following services in the intelligent bus:

- Wi-Fi access charging: provides Wi-Fi access, allows passengers to use mobile terminals to connect to Wi-Fi and performs charging.
- Audio and video service: provides one-channel audio output and audio services by connecting to the station reporter or audio equipment; provides two-channel video output; supports HDMI, YPbPr, and CVBS; provides video services by connecting to the monitor.
- Unified authentication and Portal page pushing: provides Portal authentication for access users, pushes customized media information through the Portal page, and implements uniform access control and accurate advertisement pushing.
- Android open platform: provides the Android open platform that allows third-party applications to be integrated.
- Simplified deployment and upgrade: supports USB-based deployment. You can insert the USB flash drive into the USB interface on the AR510 and power on the device. After being started, the device automatically upgrades software. The AR510 supports automatic upgrade of the SD card and built-in app.
- Remote management: supports eSight. eSight provides visualized management interface and implements remote management.

Figure 2-8 Intelligent bus application

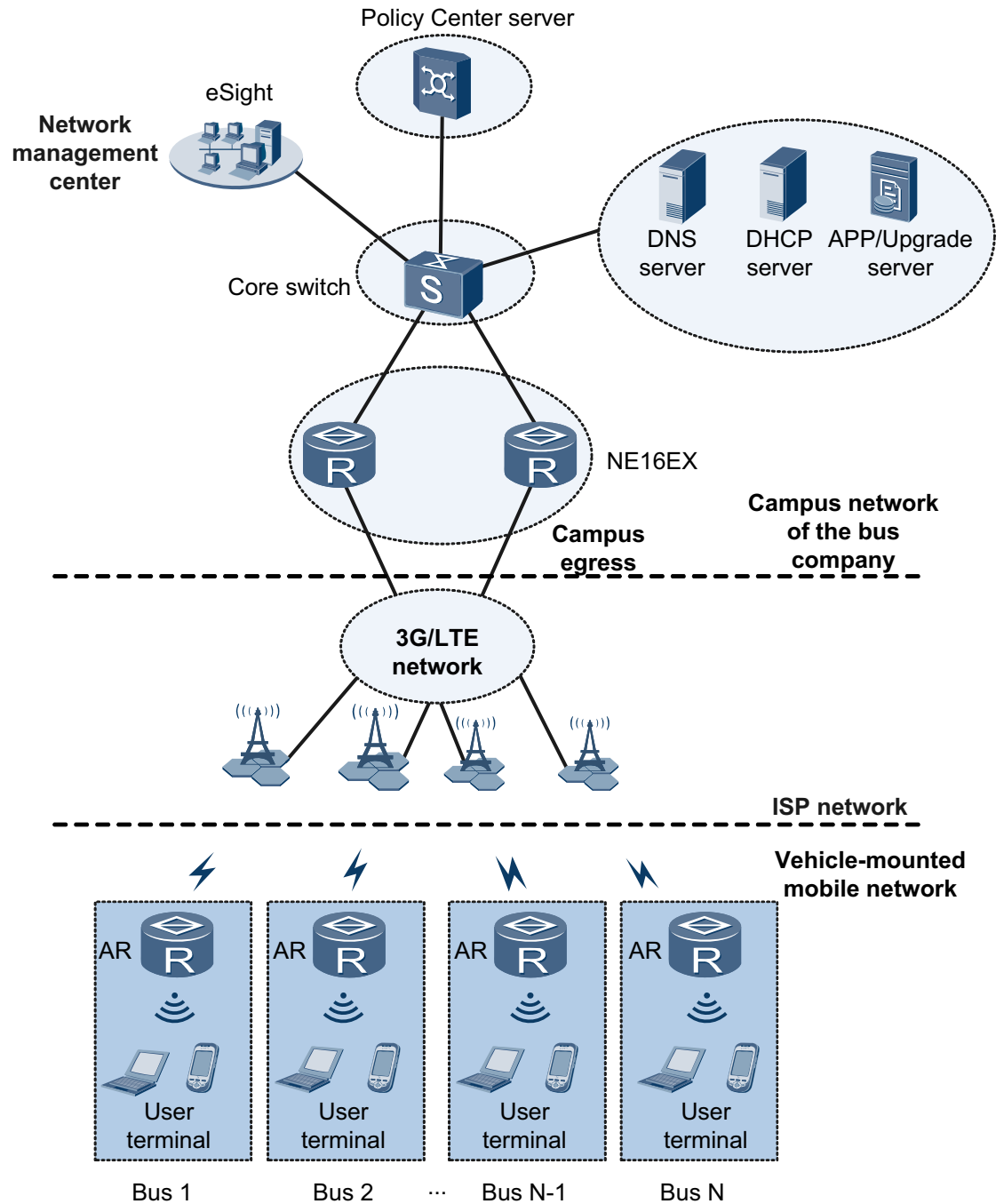

3 Product Characteristics

About This Chapter

[3.1 Feature List](#)

[3.2 Key Features](#)

3.1 Feature List

Table 3-1 and **Table 3-2** list the features supported by the AR.

Table 3-1 Features supported by the
 AR120&AR150&AR160&AR200&AR500&AR510&AR1200&AR2200&AR3200&AR360
 0

Feature	Sub-feature	Description	Difference
LAN	VLAN	VLAN services including basic VLAN, super VLAN, MUX VLAN, voice VLAN, and guest VLAN; dynamic VLAN learning using Generic Attribute Registration Protocol (GVRP)	Only the AR2220, AR2220E, AR3600 series, AR2240, and AR3200 series support MUX VLAN. The AR169-P-M9 and AR161FW-P-M5 do not support Super VLAN, Voice VLAN, or GVRP.
	MAC	Dynamic MAC address learning and static MAC address configuration; MAC address learning limit, blackhole MAC entries, sticky MAC entries, and anti-MAC flapping	None
	STP	Spanning Tree Protocol (STP), Rapid Spanning Tree Protocol (RSTP), Multiple Spanning Tree Protocol (MSTP), and STP security	None
	SEP	Ring network protocol applied to the link layer of an Ethernet network that provides open ring, closed ring, single ring, and multi-ring, and implements link redundancy in these topologies	None
	Link aggregation	Static link aggregation and Link Aggregation Control Protocol (LACP)-based aggregation	None
	LLDP	Neighboring device discovery	None

Feature	Sub-feature	Description	Difference
	QinQ	QinQ technology expands the VLAN space by encapsulating a packet that carries an 802.1Q tag in another 802.1Q tag.	Only the AR120&AR150&AR160&AR200&AR500 support QinQ.
	WLAN	Wireless access to LANs and AC integration	Only the AR151W-P, AR156W, AR157W, AR157VW, AR158EVW, AR161FGW-L, AR161FW, AR169FVW, AR169FGVW-L, AR161FW-P-M5, AR169FGW-L, AR201VW-P, AR207VW, AR1220W, AR1220EVW, and AR1220VW support WLAN-FAT AP features.
WAN	WAN interface	WAN interfaces: FE/GE/10GE interfaces, synchronous and asynchronous serial interfaces, Async interfaces, CE1/CT1 PRI interfaces, CE3 interfaces, E1T1-F interfaces, 3G/LTE cellular interfaces, ISDN BRI interfaces, POS interfaces, CPOS interfaces, ADSL interfaces, VDSL interfaces, G.SHDSL interfaces, E&M interfaces E1-IMA interfaces, and xPON interfaces	WAN interfaces depend on the device model and the boards installed.

Feature	Sub-feature	Description	Difference
	Link layer protocol	Link layer protocols such as Point-to-Point Protocol/Multilink Protocol (PPP/MLPPP), Frame Relay/Multilink Frame Relay (FR/MFR), High-Level Data Link Control (HDLC), LAPB and X.25, and ATM, and Operation, Administration, and Maintenance (OAM) mechanisms complying with link layer protocols Multi-Chassis Multilink PPP and PPP compression FR compression and FR over IP IPv4 PPPoE Server, IPv4 PPPoE Client, and IPv6 PPPoE Client	AR120 series, AR150 series, AR160 series excluding the AR162F, AR500, and AR200 series do not support FR/MFR or HDLC at the link layer.
	Dialing	Dial control center (DCC) function and logical interfaces that transmit the dialing service	None
	PON	EPON and GPON working modes, and connection with an OLT	The AR120 series, AR150 series, AR160 series, AR500, and AR200 series do not support PON.
	Network bridge	Bridge between Ethernet interfaces and WAN interfaces	None
	Terminal access	HDLC over TCP	The AR120&AR150&AR160&AR200&AR500&AR1200 series do not support this function.
	3G/LTE	3G/LTE uplink, allowing access to 3G/LTE networks using the DCC function (the AR provides the 3G/LTE data card and 3G/LTE SIC card)	None

Feature	Sub-feature	Description	Difference
IP application	ARP	The Address Resolution Protocol (ARP) maps IP addresses into MAC addresses.	None
	IPv4/IPv6	IPv4 and Ipv6 address management, TCP/UDP socket, ICMP, ping and tracert, and UDP helper	None
	IP FRR	IP FRR	None
	IPv6 transition technology	IPv6 over IPv4 tunnels and IPv4 over IPv6 tunnels	None
	DNS	DNS client(IPv4/IPv6), DNS proxy(IPv4/IPv6), and dynamic DNS (DDNS) client (IPv4)	None
	DHCP	DHCP client(IPv4/IPv6), DHCP relay(IPv4/IPv6), and DHCP server(IPv4/IPv6), and DHCP security	None
	NAT	NAT, port address translation (PAT), port application mapping (PAM), Easy NAT, and NAT server, providing application layer gateways (ALG) for each application	None
IP routing	IPv4 and IPv6 static route	Basic routing functions	None
	RIP and RIPng	Routing protocol	None
	OSPFv2 and OSPFv3	Routing protocol	None
	ISIS and ISISv6	Routing protocol	None
	BGP and BGP4+	Routing protocol	None
	Routing policy	Basic routing policy functions	None

Feature	Sub-feature	Description	Difference
	PBR	IP unicast PBR (IPv4/IPv6), including local PBR, interface PBR, and smart policy routing (SPR)	None
Multicast	IGMP	IGMP basic function, IGMP snooping, and IGMP proxy	Only the AR2200 series, AR3600 series, and AR3200 series support IGMP snooping.
	MLD	Basic MLD functions and MLD snooping	Only the AR2200 series, AR3600 series, and AR3200 series support MLD snooping.
	Multicast routing	Multicast route management, multicast route load balancing, and multicast NSR	None Only the AR3200 series support multicast NSR.
	PIM (IPv4/IPv6)	PIM-DM (IPv4/IPv6), PIM-SM (IPv4/IPv6), and PIM SSM (IPv4/IPv6)	None
	MSDP	Inter-domain (PIM-SM domain) multicast routing	None
QoS	MQC	Modular traffic classification	None
	Priority mapping	Mapping between local priorities, 802.1p priorities, DSCP priorities, and EXP priorities	Only the AR2201-48FE, AR2202-48FE, AR2220, AR2240, AR3600, and AR3200 support the mapping from 802.1p priorities, DSCP priorities, or EXP priorities to local priorities.
	Traffic policing	Single-rate-two-bucket and two-rate-two bucket policy based on traffic classifiers, permanent virtual circuits (PVCs)/VLANs/data link connection identifiers (DLCIs), and interfaces	None
	Traffic shaping	Traffic shaping based on traffic classifiers, PVCs/VLANs/DLCIs, and ports, traffic shaping adaptation, and three-level traffic shaping	None

Feature	Sub-feature	Description	Difference
	Congestion management	Congestion management based on traffic classifiers, PVCs/VLANs/DLCIs, and ports; queue mechanisms including PQ, WRR, DRR, WFQ, PQ+WRR/PQ+DRR/PQ+WFQ, and CBQ	None
	Congestion avoidance	Priority-based weighted random early detection (WRED) and tail drop	None
	HQoS	Hierarchical Quality of Service (HQoS) implements hierarchical scheduling based on queues and differentiates services and users.	None
	Smart Application Control (SAC)	The device provides SAC-based traffic classifiers to detect and identify Layer 4 to Layer 7 information in packets and packets of dynamic protocols such as HTTP, FTP, and RTP, and implements fine-grained QoS according to the classification result.	None
Security	AAA	AAA for administrators and access users, including local, RADIUS, and TACACS AAA	None
	Firewall	DMZ firewall, packet filtering firewall, stateful firewall, blacklist and whitelist, and attack detection	None
	Traffic suppression	Traffic suppression based on ports	None
	Access security	802.1x authentication, MAC address authentication, MAC address bypass authentication, and direct MAC address authentication based on users and ports; web authentication and guest VLAN for access users	None

Feature	Sub-feature	Description	Difference
	Local attack defense	Device protection measures, including CPU attack defense and attack source tracing.	None
	ARP security	Suppression of ARP packets from the user side and network side, ARP anti-spoofing, ARP gateway attack inspection, and dynamic ARP inspection (DAI)	None
	IP security	ICMP anti-attack, URPF, IP source guard and DHCP snooping	None
	PKI	Certificate request, update, and verification	None
	HTTPS	HTTPS server function, ensuring transmission security between users and devices using SSL features such as data encryption and identity verification	None
	ACL	Traffic classification based on physical ports, Layer 2 information, IP protocols, and TCP/UDP ports.	None
	IPS	Defense against application-layer attacks, such as worms, viruses, Trojan horses, DoS attacks, and code attacks	Only AR169FVW, AR169FGVW-L, AR169FGW-L, AR2204, AR2220E, AR3600 series, AR2220, AR2240, and AR3200 series support IPS.
	Reliability	Interface backup	Backup between WAN interfaces, ensuring service reliability Association between interface backup and NQA/BFD/routing

N
o
n
e

Feature	Sub-feature	Description	Difference
Interface monitoring group		In a dual-device backup scenario, when a specific proportion of network-side interfaces goes down, the user-side interface status goes Down. Then traffic is switched between the master and backup links.	None
NSR		NSR provides smooth switching between master and slave MPUs. During the switchover, the neighbor relationship is not terminated.	Only the AR3200 supports NSR.
HSB		Backup of firewall services	None
BFD		Single-hop and multi-hop BFD, BFD for VRRP, BFD for a routing protocol	None
VRRP		Redundancy backup mechanism for IP services, including IPv4/IPv6 VRRP	None
ETHOAM		P2P Ethernet fault management defined in IEEE 802.3ah	None
Device management	Information center monitoring	Managing boards, power supply units, fans, and e-labels	None
	Version management	In-service upgrade, rollback, and patch installation	None
	Mirroring	Port- and flow-based mirroring	None
	Remote PoE power supply	LAN-side remote power supply	Only the AR151W-P, AR169-P-M9, AR161FW-P-M5, AR201VW-P, AR207V-P, AR1220V, AR1220W, AR1220EV, AR1220EVW, and AR1220VW support the PoE features.
	Web-based network management system	Internal web management system, providing GUI to manage and maintain devices	None

Feature	Sub-feature	Description	Difference
	Deployment	Automatic deployment using a universal serial bus (USB) flash drive; Auto-Config function for the entire network	None
	Energy saving management	Automatic and manual fan speed adjustment Automatic laser shutdown (ALS) Energy Efficient Ethernet (EEE)	<ul style="list-style-type: none"> ● The AR120&AR150&AR160&AR200&AR510 do not support manual fan speed adjustment. ● Ethernet electrical interfaces of the AR120, AR160, AR1220F, AR2201-48FE, AR2202-48FE, AR2220E, AR2204, and AR2220L support EEE. ● GE electrical interfaces of the 4ES2G-S card support EEE. None
	Active/Standby switchover	Active/Standby switchover	Only the AR3260 provides the active/standby switchover of dual SRUs.
Network management	SNMP	SNMP agent, fault management (FM), and trap switch control (TSC)	None
	Ping and Tracert	Network connectivity detection	None
	NTP	NTPv4/v6 and time synchronization for traditional IP networks	None
	RMON	Monitoring and traffic statistics for traffic on a network segment	None
	CWMP	CWMP for remotely managing AR devices	None
	NetStream	Fixed packet sampling and packet statistics collection, with flow output in V5, V8, V9, or V10 format	None

Feature	Sub-feature	Description	Difference
	Network Quality Analysis (NQA)	Detecting the performance of protocols running on the network	None
	IP accounting	Information statistics: <ul style="list-style-type: none"> ● Collecting statistics on all IPv4 data flows passing the device ● Collecting statistics on the IPv4 data flows with specified attributes ● Collecting statistics on all IPv4 data flows passing the device based on IP precedence 	None
MPLS	Basic MPLS functions	Static label switched path (LSP) and penultimate hop popping (PHP)	The AR120&AR150&AR160&AR200 series routers do not support MPLS.
	MPLS LDP	MPLS LDP	
	MPLS TE	MPLS TE	
	MPLS FRR	LDP FRR, TE FRR, and VPN FRR	
	MPLS over GRE	MPLS LDP over GRE, L2VPN over GRE, and L3VPN over GRE	
VPN	L2TP	Functioning as the LAC or LNS and allowing concurrent user access on multiple channels	None
	GRE	GRE tunnel for interconnecting the headquarters and branches Used together with IPSec. IPSec cannot protect multicast data, but GRE VPN can protect multicast data	None
	DSVPN	Dynamic setup of a data forwarding channel between hubs	None

Feature	Sub-feature	Description	Difference
	IPSec	Interconnecting headquarters and branches using IKE V1/V2 IPSec tunnels; hardware-based MD5 and SHA algorithms; AES, DES, and 3DES algorithms	None
	SSL VPN	Virtual gateway for management of SSL VPN users and SSL VPN services	None
	L3VPN	BGP L3VPN	None
	MCE IPv6	A multi-VPN-instance CE (MCE) device uses routing multi-instance to isolate services or users of IPv6	None
	MPLS L2VPN	VLL and PWE3	AR120&AR150&AR160&AR200 series routers do not support VLL or PWE3.
	A2A VPN	A VPN solution which manages keys and GDOI policies in a centralized manner.	None
	SVPN	IVPN binds multiple WAN access lines to provide high-bandwidth and reliable Internet access.	None
Voice	Line configuration	Foreign exchange station (FXS), foreign exchange office (FXO), VE1, ISDN, BRI and PRI line access and configuration	Only the AR157VW, AR158EVW, AR169FVW, AR169FGVW-L, AR201VW-P, AR207V, AR207VW, AR207V-P, AR1220V, AR1220VW, AR1220EV, AR1220EVW, AR2220E AR2204, AR2220, AR2240, and AR3200 support voice features.
	SIP AG	The upper-layer device such as soft switch performs call control and management. The AR communicates with the soft switch by using the SIP protocol. The AR provides the Branch Exchange for Survivable Telephony (BEST) function. The AR provides SIP over TLS.	

Feature	Sub-feature	Description	Difference
	H.248AG	The upper-layer device such as soft switch performs call control and management. The AR communicates with the soft switch by using the H.248 protocol.	
	PBX	Voice mailbox Foreign exchange station (FXS) access and configuration SIP signaling Call Waiting	

Table 3-2 Features supported by the AR510

Feature	Sub-feature	Description	Difference
Android open platform	Android open platform	External USB interface, audio interface, HDMI/YPbPr/CVBS interface, GPS interface, and bluetooth interface Support for integration of third-party applications	None
LAN	VLAN	Basic VLAN	None
	MAC	Dynamic MAC address learning and static MAC address configuration; MAC address learning limit, blackhole MAC entries, sticky MAC entries, and anti-MAC flapping	None
	Link aggregation	Static link aggregation and Link Aggregation Control Protocol (LACP)-based aggregation	None
	LLDP	Neighboring device discovery	None
	WLAN	Wireless access to LANs and AC integration Device as the STA to connect to the WLAN	None

Feature	Sub-feature	Description	Difference
WAN	WAN interface	WAN interfaces: GE interface, 3G/LTE cellular interfaces	None
	Link layer protocol	Link layer protocols such as Point-to-Point Protocol. IPv4 PPPoE Server and IPv4 PPPoE Client	None
	Dialing	Dial control center (DCC) function and logical interfaces that transmit the dialing service	None
	Network bridge	Bridge between Ethernet interfaces and WAN interfaces	None
	3G/LTE	3G/LTE uplink, allowing access to 3G/LTE networks using the DCC function	None
IP application	ARP	The Address Resolution Protocol (ARP) maps IP addresses into MAC addresses.	None
	IPv4	IPv4 address management, TCP/UDP socket, ICMP, ping and tracert, and UDP helper	None
	IP FRR	IP FRR	None
	DNS	DNS client(IPv4), DNS proxy(IPv4), and dynamic DNS (DDNS) client(IPv4)	None
	DHCP	DHCP client(IPv4), DHCP relay(IPv4), and DHCP server(IPv4), and DHCP security	None
	NAT	NAT, port address translation (PAT), port application mapping (PAM), Easy NAT, and NAT server, providing application layer gateways (ALG) for each application	None
IP routing	IPv4 Static route	Basic routing functions	None
	RIP	Routing protocol	None
	OSPFv2	Routing protocol	None

Feature	Sub-feature	Description	Difference
	ISIS	Routing protocol	None
	BGP	Routing protocol	None
	Routing policy	Basic routing policy functions	None
	PBR	IP unicast PBR (IPv4), including local PBR, interface PBR, and smart policy routing (SPR)	None
Multicast	IGMP	IGMP basic function, and IGMP proxy	None
	Multicast routing	Multicast route management, multicast route load balancing, and source-specific multicast (SSM) mapping	None
	PIM (IPv4)	PIM-DM (IPv4), PIM-SM (IPv4), and PIM SSM (IPv4)	None
	MSDP	Inter-domain (PIM-SM domain) multicast routing	None
QoS	MQC	Modular traffic classification	None
	Priority mapping	Mapping between local priorities, 802.1p priorities, DSCP priorities, and EXP priorities	None
	Traffic policing	Single-rate-two-bucket and two-rate-two bucket policy based on traffic classifiers, permanent virtual circuits (PVCs)/ VLANs/data link connection identifiers (DLCIs), and interfaces	None
	Traffic shaping	Traffic shaping based on traffic classifiers, PVCs/VLANs/DLCIs, and ports, traffic shaping adaptation, and three-level traffic shaping	None
	Congestion management	Congestion management based on traffic classifiers, PVCs/VLANs/DLCIs, and ports; queue mechanisms including PQ, WRR, DRR, WFQ, PQ+WRR/PQ+DRR/PQ+WFQ, and CBQ	None

Feature	Sub- featur e	Description	Difference
	Conges tion avoida nce	Priority-based weighted random early detection (WRED) and tail drop	None
	HQoS	Hierarchical Quality of Service (HQoS) implements hierarchical scheduling based on queues and differentiates services and users.	None
Security	AAA	AAA for administrators and access users, including local, RADIUS, and TACACS AAA	None
	Firewa ll	DMZ firewall, packet filtering firewall, stateful firewall, blacklist and whitelist, and attack detection	None
	Access securit y	802.1x authentication, MAC address authentication, MAC address bypass authentication, and direct MAC address authentication based on users and ports; web authentication and guest VLAN for access users	None
	Local attack defens e	Device protection measures, including CPU attack defense and attack source tracing.	None
	ARP securit y	Suppression of ARP packets from the user side and network side, and ARP anti-spoofing	None
	IP securit y	ICMP anti-attack, and URPF	None
	PKI	Certificate request, update, and verification	None
	HTTP S	HTTPS server function, ensuring transmission security between users and devices using SSL features such as data encryption and identity verification	None
	ACL	Traffic classification based on physical ports, Layer 2 information, IP protocols, and TCP/UDP ports.	None

Feature	Sub-feature	Description	Difference
Reliability	Interface backup	Backup between WAN interfaces, ensuring service reliability Association between interface backup and NQA/BFD/routing	None
	Interface monitoring group	In a dual-device backup scenario, when a specific proportion of network-side interfaces goes down, the user-side interface status goes Down. Then traffic is switched between the master and backup links.	None
	HSB	Backup of firewall services	None
	BFD	Single-hop and multi-hop BFD, BFD for VRRP, BFD for a routing protocol	None
	VRRP	Redundancy backup mechanism for IP services, IPv4 VRRP supported only.	None
Device management	Information center monitoring	Managing boards, power supply units, fans, and e-labels	None
	Version management	In-service upgrade, rollback, and patch installation	None
	Mirroring	Port- and flow-based mirroring	None
	Web-based network management system	Internal web management system, providing GUI to manage and maintain devices	None
	Deployment	Automatic deployment using a universal serial bus (USB) flash drive; Auto-Config function for the entire network	None
Network management	SNMP	SNMP agent, fault management (FM), and trap switch control (TSC)	None

Feature	Sub- featur e	Description	Difference
	Ping and Tracert	Network connectivity detection	None
	CWM P	CWMP for remotely managing AR devices	None
	NQA	Detecting the performance of protocols running on the network	None
VPN	L2TP	Functioning as the LAC or LNS and allowing concurrent user access on multiple channels	None
	GRE	GRE tunnel for interconnecting the headquarters and branches	None
	DSVP N	Dynamic setup of a data forwarding channel between hubs	None
	SSL VPN	Virtual gateway for management of SSL VPN users and SSL VPN services	None
	IPSec	Efficient VPN supported only	None

3.2 Key Features

3.2.1 Voice

In addition to broadband services, such as video on demand (VOD) and live data and video, the AR provides high-quality voice service for terminal users.

NOTE

- Among the AR150 series routers, only the AR157VWs and AR158EVWs support the voice features. Among the AR160 series routers, only the AR169FVWs and AR169FGVW-Ls support the voice features. Among the AR200 series routers, only the AR201VW-Ps, AR207Vs, AR207VWs and AR207V-Ps support the voice features. Among the AR1200 series routers, only the AR1220Vs and AR1220VWs support the voice features. Among the AR2200 series routers, only the AR2204s, AR2220s, AR2240s support the voice features. To use the voice feature on the AR2200 and AR3200 series routers, you are advised to install the DSP module.
- To provide voice services for POTS users on AR1200, AR2200 ,and AR3200 series routers, 4FXS1FXO, 16FXS or 32FXS board is required. Thereinto, the AR1200 series routers does not support 32FXS board.
- To provide voice services for ISDN users on AR1200, AR2200 ,and AR3200 series routers, 2BST board is required.

SIP AG

Access gateway (AG) devices provide various access modes and convert various services into a uniform format that can be transmitted. The AG communicates with the soft switch by using the SIP protocol. SIP-based AGs are called SIP AGs.

When an AR functions as the SIP AG, the upper-layer devices such as soft switch control and manage calls. The AR supports the following services.

Service Type	Introduction	Configure d on the SIP AG or Not
Basic voice service	The basic voice service is the basic call connection function, including intra-office calls, local calls, national toll calls, international toll calls, and transit calls.	Yes
Three-party service	The third-party service allows a calling party or called party in a conversation to call a third party without ending the current conversation. Then the calling party or original called party can implement a three-party conversation or talk to the other two parties.	Yes
Call waiting service	When UserA is talking with UserB over the phone and at this moment UserC is calling UserA, UserA hears a call waiting tone, indicating that there is a call waiting for UserA.	Yes
MWI service	The message waiting indicator (MWI) service allows a user to read unread messages or leave messages. When the called user is busy, the MWI is on, indicating that there are leave messages.	Yes
Malicious call identification (MCID) service	The user that registers the MCID service with the carrier can query the phone number of the attacker that initiates malicious calls after performing relevant operations.	Yes
Call transfer service	The call transfer service allows the called party to transfer an incoming call to a third party by pressing the hookflash so that the calling party establishes a connection with a new called party.	Yes
Call conference service	The call conference service allows more than three parties to communicate together.	Yes
Calling line identification presentation (CLIP) service	The CLIP service displays the calling number in onhook state or offhook state (for call waiting). The displayed information includes the phone number, name, date, and time.	No

Service Type	Introduction	Configured on the SIP AG or Not
Calling line identification restriction (CLIR) service	The CLIR service displays the phone number of a calling party on the terminal of a called party.	No
Distinctive ringing service	The distinctive ringing service plays different ring tones for incoming calls.	No
Differentiated ringback tone service	The differentiated ringback tone service enables the SIP AG to play different ring tones for ringback tones.	No
Advice of charge (AoC) service	The AoC service enables the SIP AG to display the charge rate, fee notification during a call, and the total fee of the call.	No
Urgent call process	If the SIP AG finds an urgent call, the SIP AG inserts the urgent call flag into the SIP message.	No
Completion of Calls to Busy Subscriber (CCBS) service	When the called number is busy, the CCBS service enables the SIP AG to monitor the called party status. When the called party is idle, the SIP AG notifies the calling party and determines whether to make a call according to the status of the calling and called parties.	No
Multiple MSN numbers on a POTS interface	Multiple MSN numbers can be configured on a POTS interface.	No
Hotline service	<ul style="list-style-type: none"> ● Instant hotline service: After a user picks up a phone, the SIP AG dials the hotline number for the user. ● No dialing within a long time after picking up the phone: If a user does not dial any number within the specified period of time after picking up the phone, the SIP AG dials the hotline number for the user. 	Yes
Anonymous call service	The anonymous call service enables the called party not to view information about incoming calls.	No

H.248AG

H.248 is a media gateway control protocol through which the media gateway controller (MGC) controls the media gateway (MG) so that interoperability is implemented between different media.

The H.248 AG supports the basic voice service and developed services such as the three-party service and call waiting service. These services need to be configured on the softswitch.

Service Type	Introduction
Basic voice service	The basic voice service provides call connections, including intra-office calls, local calls, national long-distance calls, international long-distance calls, and transit calls.
Three-party service	The third-party service allows a calling party or called party in a conversation to call a third party without ending the current conversation. Then the calling party or original called party can make a three-party conversation or talk to the other two parties separately.
Call waiting	If user C calls user A when user A is talking with user B, user A hears a call waiting tone indicating that there is an incoming call.
MWI service	The message waiting indicator (MWI) service allows a user to read unread or leave messages. When the called user is busy, the MWI is on indicating that there are messages.
Malicious call identification (MCID) service	The MCID service allows users to perform certain operations to find the phone number of an attacker that initiates malicious calls.
Call transfer service	The call transfer service allows the called party to transfer an incoming call to a third party by pressing the hookflash so that the calling party establishes a connection with a new called party.
Call conference service	The call conference service allows more than three parties to talk to each other.
Calling line identification presentation (CLIP) service	The CLIP service displays the calling number in onhook state or offhook state (for call waiting). The displayed information includes the phone number, name, date, and time.
Calling line identification restriction (CLIR) service	The CLIR service shields the calling number on the terminal of a called party.
Distinctive ringing service	The distinctive ringing service plays different ring tones for incoming calls from different calling parties.
Differentiated ringback tone service	The differentiated ringback tone service plays different ringback tones for different users.
Advice of charge (AoC) service	The AoC service displays the charge rate, fee notification during a call, and total fee of the call.
Emergency call process	If the H.248 AG detects an emergency call, it inserts an emergency call flag into the H.248 message.

Service Type	Introduction
Completion of Calls to Busy Subscriber (CCBS) service	The CCBS service enables the H.248 AG to monitor the called party status when the called party is busy. When the called party is idle, the H.248 AG notifies the calling party so that the calling party can determine whether to make a call to the called party again.
Multiple MSN numbers on a POTS interface	Multiple MSN numbers can be configured on a POTS interface.
Hotline service	The hotline service is classified into: <ul style="list-style-type: none">● Instant hotline service: After a user picks up a phone, the H.248 AG dials the hotline number for the user.● Delayed hotline service: If a user does not dial any number within the specified period of time after picking up a phone, the H.248 AG dials the hotline number for the user.
Anonymous call service	The anonymous call service prevents the called party from viewing information about incoming calls.

For details about voice features, see Configuration Guide - Voice.

PBX

PBXs are widely used in enterprises. They manage incoming and outgoing calls of enterprises.

For details about voice features, see Configuration Guide - Voice.

3.2.2 WAN

WAN uses the interfaces such as Ethernet, E1-F, T1-F, CE1/CT1, ADSL, VDSL, G.SHDSL, CPOS, POS, 3G, CE3, LTE, and synchronous/asynchronous serial interfaces. The following link layer protocols are supported: FR, PPP, PPPoE, ATM, HDLC, LAPB and X.25, and ISDN.

Frame Relay

Working at the data link layer of the Open System Interconnection (OSI) model, Frame Relay (FR) uses simple methods to transmit and exchange data. On a frame relay (FR) network, virtual circuits connect two FR devices. A physical line on the FR network provides multiple VCs. A VC defines an FR channel by using the data link connection identifier (DLCI), and detects and maintains the VC status by using the local management interface (LMI).

Multilink frame relay (MFR) is a cost-effective solution provided for FR users. MFR (FRF.16) implements the multilink frame relay function on the user-to-network interfaces (UNIs).

The FR compression technologies compress FR packets to save network bandwidth, reduce network load, and improve data forwarding on the FR network. The AR supports FRF.9 (FRF.9 stac) and FRF.20 (FRF.20 IPHC).

PPP

The point-to-point protocol (PPP) is used at the data link layer of the OSI model as well as at the link layer of TCP/IP. PPP transmits data from one point to another through synchronous links and asynchronous links that support full duplex.

PPP provides a complete authentication mechanism. To set up a PPP connection, users must pass authentication, ensuring a secured connection.

Multilink PPP (MP) is a technique that bundles multiple PPP links together to increase bandwidth. It can be applied to the interfaces that support PPP, such as serial interfaces and low-speed Packet over SDH (POS) interfaces.

PPP links support VJHC, IPHC, and STAC-LZS compression that compress the TCP/IP packet header, TCP/IP/RTP/UDP/IP packet header, and packet payload respectively, improving the transmission efficiency.

PPPoE

A Point-to-Point Protocol over Ethernet (PPPoE) network consists of an Ethernet containing many hosts. It accesses the Internet through a remote access device.

An AR can create a PPP session with the remote end by using PPPoE, and implement access control and accounting.

An AR can function as the PPPoE server to connect to different types of PPPoE clients on the Ethernet or function as a dial-up PPPoE client.

ATM

ATM is connection-oriented. Each VC is identified by a Virtual Path Identifier (VPI) and a Virtual Channel Identifier (VCI). One pair of VPI/VCI values is useful only on a link segment between ATM nodes. If a connection is broken, the relevant VPI/VCI values are released.

The Asymmetric Digital Subscriber Line (ADSL), VDSL, E1-IMA and G.Single-pair High Speed Digital Subscriber Line (G.SHDSL) interfaces of the ARs support the Asynchronous Transfer Mode (ATM).

HDLC

The High-level Data Link Control (HDLC) is a typical bit-oriented synchronization data control protocol. It adopts the full-duplex mode and CRC check. Its transmission control function is independent of the processing function, and it features control capabilities and can be flexibly used.

In HDLC, Keepalive packets are used to detect the link status. On the AR, you can set the interval for sending Keepalive packets by setting the polling interval.

ISDN

The ISDN protocol references the Open Systems Interconnection (OSI) model and implements functions of the physical layer, data link layer, and network layer on UNI interfaces.

ISDN physical interfaces are classified into ISDN BRI and ISDN PRI interfaces. When the AR accesses an ISDN network by using an ISDN PRI interface, the AR is directly connected to

an ISDN network-side device. When the AR accesses an ISDN network by using an ISDN BRI interface, the AR connects to an NT1 device, and the NT1 device connects to an ISDN network-side device.

LAPB and X.25

LAPB is a bit-oriented data link layer that defines the process of exchanging frames between the data terminal equipment (DTE) and data circuit-terminating equipment (DCE). It ensures that frames are transmitted in the right sequence without errors.

The X.25 protocol stack defines the interfaces between the DTE and DCE on public data networks (PDNs). The protocol stack has three layers, physical layer, data link layer, and packet layer. LAPB is used on the data link layer.

In addition to the second layer of X.25, LAPB can function as an independent data link layer protocol to transmit non-X.25 data of upper-layer protocols. LAPB can be configured on synchronous serial interfaces for simple local data transmission.

An X.25 network is deployed on a WAN that allows for low transmission costs and does not have high requirements for the remote transmission speed or delay. Currently, X.25 networks are still used as dedicated networks in some countries or regions. As IP networks are widely applied, X.25 data is transmitted on IP networks. X.25 over TCP (XOT) technology is introduced to connect X.25 networks over IP networks. This technology encapsulates X.25 packets in TCP packets to transmit X.25 packets across an IP network.

For details about WAN features, see Configuration Guide - WAN.

3.2.3 VPN

The ARs support IP Security Virtual Private Network (IPSec VPN) and provide an IP security (IPSec) mechanism to ensure high quality, interoperable, and cryptology-based security for communication processes. The two parties in communication can encrypt data and authenticate the data source at the IP layer to ensure the confidentiality and integrity of the data and prevent replay on the network.

IPSec implements these functions by using two security protocols: Authentication Header (AH) protocol and Encapsulating Security Payload (ESP). Internet Key Exchange (IKE) provides the automatic key negotiation, SA establishment, and SA maintenance functions to simplify IPSec use and management.

In addition, the ARs use Generic Routing Encapsulation (GRE) and Layer 2 Tunneling Protocol (L2TP) to support VPN services except IPSec VPN.

The VPN services supported by the ARs are listed as follows:

- GRE VPN
- IPSec VPN
- BGP/MPLS IP VPN
- VLL
- SSL VPN
- L2TP VPN
- DSVPN

- GRE over IPsec VPN
- L2TP over IPsec VPN
- IPsec over L2TP VPN
- SVPN
- A2A VPN
- IPsec over GRE
- PWE3

For details about VPN features, see Configuration Guide - VPN.

3.2.4 Security

ACL

An access control list (ACL) defines a series of filtering rules based on certain policy, the ACL permits or forbids the passage of data packets.

The ARs can use ACL rules to filter packets.

NAC

Network Admission Control (NAC) is an end-to-end access security framework and includes 802.1x authentication, MAC address authentication, and Portal authentication.

Traditional network security technologies focus on threats from external computers, but typically neglect threats from internal computers. In addition, current network devices cannot prevent attacks initiated by devices on internal networks.

The NAC security framework was developed to ensure the security of network communication services. The NAC security framework improves internal network security by focusing on user terminals, and implement security control over access users to provide end-to-end security.

Firewall

- ACL-based packet filtering
ACL-based packet filtering is used to analyze the information of the packets to be forwarded, including source/destination IP addresses, source/destination port numbers, and IP protocol numbers. The ARs compare the packet information with the ACL rules and determine whether to forward or discard the packets.
In addition, the ARs can filter the fragmented IP packets to prevent the non-initial fragment attack.
- ASPF
Application Specific Packet Filter (ASPF) filters packets of the application layer based on packet status. ASPF, used for security policies, detects the session information of the application layer protocol packets, which attempt to pass the AR and prevent the unsatisfied packets.
- Attack defense
With the attack defense feature, the ARs can detect various network attacks and protect the internal network against attacks.

Network attacks are classified into three types: DoS attacks, scanning and snooping attacks, and malformed packet attacks.

- DoS attack

The DoS attack is an attack to a system by using a large number of data packets. This prevents the system from receiving requests from authorized users or suspends the host. DoS attacks include SYN Flood attacks and Fraggle attacks. DoS attacks are different from other attacks because DoS attackers do not search for the ingress of a network, but prevent authorized users from accessing resources or routers.

- Scanning and snooping attack

The scanning and snooping attack is to identify the existing systems on a network by using ping scanning (including ICMP and TCP scanning), and then find out potential targets. By using TCP scanning, attackers can identify the operating system and the potential services. By scanning and snooping, an attacker can know the service type and security vulnerability of the system and prepare for further intrusion to the system.

- Malformed packet attack

The malformed packet attack is to send malformed packets to the system. If such an attack occurs, the system breaks down when processing the malformed IP packets. Malformed packet attacks include Ping of Death and Teardrop.

ARP Security

There are various ARP attacks on networks, including attacks targeting hosts and gateways, address spoofing attacks and violent attacks, virus attacks, and malicious software attacks.

The ARs ensure ARP security by discarding untrusted ARP packets, suppressing ARP packets by using timestamps, discarding invalid ARP packets, and performing dynamic CAR on the packets sent to the CPU. In addition to preventing ARP protocol attacks, the ARs also prevent ARP-based network scanning attacks.

IP Source Guard

Some attacks on networks aim at source IP addresses by accessing and using network resources through spoofing IP addresses, stealing users' information or blocking authorized users from accessing networks.

The ARs support IP Source Guard (IPSG) and Unicast Reverse Path Forwarding (URPF).

- IPSG prevents source address spoof attacks, so attackers cannot access network resources and authorized users' rights are protected.
- URPF blocks packets sent from bogus source addresses.

Local Attack Defense

The Internet technology and size develop quickly and various network applications emerge. Many enterprises try to boost their own development by using their networks. They are concerned about how to protect confidential data and resources in an open network environment. Some unconscious operations may attack network devices and degrade device performance or even cause device failure.

A large number of packets including valid packets and malicious attack packets on a network must be processed by devices' CPUs. The malicious attack packets affect services and may even

cause a system breakdown. In addition, excessive normal packets can also lead to high CPU usage, which degrades the CPUs' performance and interrupts services. Therefore, protecting the CPU is a necessary and important factor for processing services and system response.

The local attack defense and source tracing functions protect the ARs against attacks. When an attack occurs, these functions ensure non-stop service transmission and minimize the impact of the attack on network services.

PKI

The public key infrastructure (PKI) is a system that generates public keys and digital certificates, and verifies identities of certificate subjects to ensure information security. PKI issues digital certificates that bind public keys to respective user identities by means of a certificate authority (CA).

AAA

The ARs support Authentication, Authorization, and Accounting (AAA).

- Authentication
Verifies users' identities.
- Authorization
Grants different rights for different users to authorize the services that can be used by users.
- Accounting
Records information about network service usage of users, including service type, start time, and traffic volume.

IPS

IPS accurately analyzes and determines network attack behaviors, blocks malicious traffic from vulnerability attacks, and provides virtual patches for enterprise networks. It can detect web security threats such as SQL injection attacks, XSS attacks, and webpage linked to Trojan attacks, providing web security defense for enterprises. It can malicious attacks such as Trojan horses, worms, Botnet network attacks, and spy software, cleaning malicious traffic and providing anti-spy capability.

3.2.5 QoS

Traffic Policing

Traffic policing discards excess traffic to limit the traffic within a specified range and to protect network resources as well as the carriers' interests.

The device uses committed access rate (CAR) to perform traffic policing. They support dual-rate-three-color markers and precise bandwidth management.

Traffic Shaping

When the rate of an interface on a downstream device is slower than that of an interface on an upstream device or burst traffic occurs, traffic congestion may occur on the downstream device

interface. Traffic shaping can be configured on the interface of an upstream device so that outgoing traffic is sent at even rates and congestion is avoided.

The device supports traffic shaping adaptation and level-3 traffic shaping. Three-level shapers include the flow queue shaper, subscriber queue shaper, and port queue shaper.

Congestion Management

If a network transmitting both delay-sensitive and delay-insensitive services is congested intermittently, congestion management is required. However, if a network is always congested, bandwidth needs to be increased. Congestion management sends packet flows by using queuing and scheduling.

An interface on AR has four or eight default queues for outgoing packets. LAN-side interfaces support the scheduling modes of priority queuing (PQ), deficit round robin (DRR), weighted round robin (WRR), PQ+DRR, and PQ+WRR. The fixed LAN-side interfaces of AR150&200&1200 series routers do not support the DRR mode. WAN-side interfaces support the scheduling modes of PQ, WFQ, PQ+WFQ, and class-based WFQ (CBQ). Each scheduling algorithm schedules specific types of traffic, and affects bandwidth allocation, delay, and jitter.

Congestion Avoidance

Congestion avoidance is a flow control mechanism. A system configured with congestion avoidance monitors network resource usage such as queues and memory buffers. When congestion occurs or aggravates, the system discards packets.

The device supports tail drop and WRED.

- Tail drop

When the queue length reaches the upper limit, the excess packets (buffered at the queue tail) are discarded.

- WRED

WRED sets the upper and lower drop thresholds and the maximum drop probability for each queue. When the queue length is smaller than the lower threshold, no packets are discarded. When the length of the queue exceeds the upper threshold, all packets are discarded. When the queue length is between the lower threshold and the upper threshold, incoming packets are discarded randomly. The drop probability cannot be greater than the maximum drop probability.

The device uses the WRED based on queue profiles or traffic policies.

 **NOTE**

LAN-side subcards do not support WRED.

For details about QoS features, see Configuration Guide - QoS.

3.2.6 WLAN

A wireless local area network (WLAN) connects two or more computers or devices and enables the devices to communicate by using the wireless telecommunication technology. WLAN uses the wireless technology to implement fast Ethernet access. The primary advantage of WLAN is that terminals, such as computers, can access a network through a wireless medium rather than a physical cable. This facilitates network construction and allows users to move around without interrupting communication. WLAN is more flexible than traditional wired access.

WLAN is widely used in public areas such as on campuses, business centers, and airports. The WLAN uses cables at the backbone layer, and users access the WLAN through one or more access points (APs) using radio waves. The transmission distance of an AP is tens of meters.

IEEE 802.11 is widely used by WLANs. The device can function as an access controller (AC) or a Fat access point (FAT AP). The device as the AC or Fat AP supports 802.11a, 802.11b, 802.11g, and 802.11n.

 **NOTE**

Only AR151W-P, AR156W, AR157W, AR157VW, AR158EVW, AR169FVW, AR169FGVW-L, AR169FGW-L, AR161FW-P-M5, AR201VW-P, AR207VW, AR1220W, AR1220EVW, and AR1220VW support WLAN-FAT AP.

The device supports the following WLAN features:

- WLAN user management
 - Dot1X access authentication
 - MAC address authentication
 - Pre-share-key (PSK) authentication
 - EAPOL-Key negotiation
 - User access control
 - AAA for WLAN users
- Radio frequency (RF) management
 - Country code
 - RF type
 - Setting radio transmission rate
 - Setting radio transmission power
 - Setting radio working channels
 - Monitoring and eliminating radio interference
 - Configurable wireless MAC layer parameters
 - Configuring and querying radio attributes
 - Collecting and querying performance statistics of radio frequency interfaces
- WLAN security
 - WEP Open-System link authentication and encryption
 - WEP Share-Key link authentication and encryption
 - WPA PSK authentication and encryption
 - WPA Dot1X authentication and encryption
 - WPA2 PSK authentication and encryption
 - WPA2 Dot1X authentication and encryption
 - WAPI authentication and encryption
 - TKIP/CCMP encryption
 - HMAC-MD5 algorithm
 - User blacklist and whitelist

- WLAN QoS
 - WMM (802.11e)
 - Mapping wireless-side priority to the wired-side priority
 - Bandwidth limit based on users
 - Bandwidth limit based on SSIDs

For details about WLAN features, see Configuration Guide - WLAN-AC and Configuration Guide - WLAN-FAT AP.

3.2.7 IPv6

The AR provides the IPv6 host function, which maximizes customers' return on investment (ROI) and prevents repeated investment during network upgrade.

The AR supports the following IPv6 functions:

- IPv6 ND
- IPv6 PMTU
- TCP6, UDP6, RawIP6, Ping IPv6, and Tracert IPv6
- ICMP6 and Socket6
- IPv6 unicast routing protocols: RIPng, OSPFv3, IS-IS, BGP, and IPv6 static route
- IPv6 multicast protocols: MLD, PIM-DM, PIM-SM, and PIM-SSM
- TFTP IPv6 client, FTP IPv6 client, FTP IPv6 server, Telnet IPv6 client, and Telnet IPv6 server
- IPv6 over IPv4 manual tunnel, IPv6 over IPv4 GRE tunnel, IPv6 over IPv4 automatic tunnel, 6to4 tunnel, ISATAP tunnel, and IPv4 over IPv6 tunnel
- DHCPv6 client, DHCPv6 server, DHCPv6 relay, DHCPv6 snooping, and DHCPv6 PD
- MLD snooping

For details about IPv6 functions, see Configuration Guide - IP Service and Configuration Guide - IP Unicast Routing.

4 Appearance

About This Chapter

- [4.1 AR120 Series](#)
- [4.2 AR150 Series](#)
- [4.3 AR160 Series](#)
- [4.4 AR200 Series](#)
- [4.5 AR500 Series](#)
- [4.6 AR510 Series](#)
- [4.7 AR1200 Series](#)
- [4.8 AR2200 Series](#)
- [4.9 AR3200 Series](#)
- [4.10 AR3600 Series](#)

4.1 AR120 Series

AR121

Figure 4-1 shows the appearance of the AR121 router.

Figure 4-1 AR121 appearance

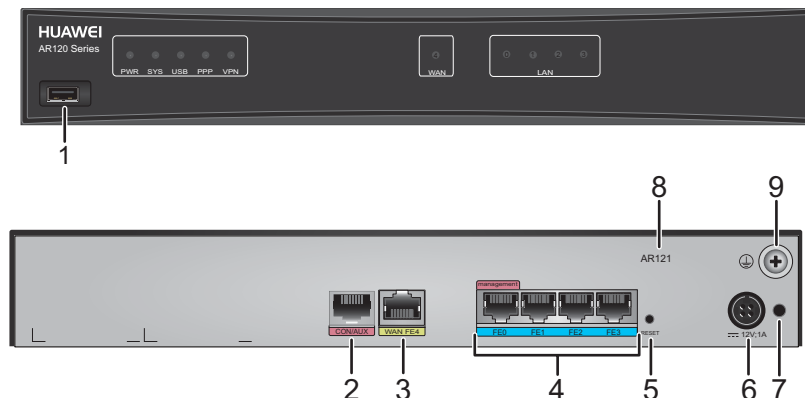

1	USB interface (host)	2	CON/AUX interface NOTE The AR121 does not support AUX login.
3	WAN interface: FE electrical interface	4	LAN interface: FE electrical interface
5	RESET button NOTICE This button is used to reset the router. <ul style="list-style-type: none"> To restore the factory settings, hold down the button for at least 3 seconds. To reset the system, press the button. Resetting the router will interrupt services. Exercise caution when deciding to press this button.	6	Power jack NOTE Use a 24 W power adapter to connect the router to a power source.
7	Jack for power cable locking strap NOTE Insert a power cable locking strap in this jack to secure the power cable.	8	Product model silkscreen
9	Ground point NOTE Reliably ground the router by connecting a ground cable to the ground point to protect the router against lightning and interference.	-	-

AR129

Figure 4-2 shows the appearance of the AR129 router.

Figure 4-2 AR129 appearance

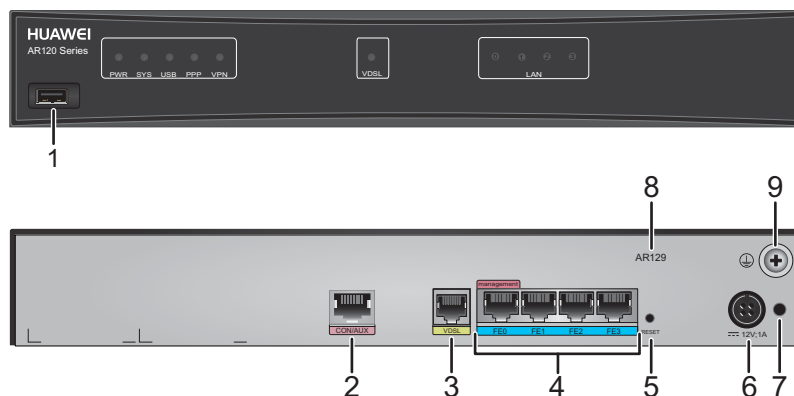

1	USB interface (host)	2	CON/AUX interface NOTE The AR129 does not support AUX login.
3	WAN interface: VDSL interface	4	LAN interface: FE electrical interface
5	RESET button NOTICE This button is used to reset the router. <ul style="list-style-type: none"> To restore the factory settings, hold down the button for at least 3 seconds. To reset the system, press the button. Resetting the router will interrupt services. Exercise caution when deciding to press this button.	6	Power jack NOTE Use a 24 W power adapter to connect the router to a power source.
7	Jack for power cable locking strap NOTE Insert a power cable locking strap in this jack to secure the power cable.	8	Product model silkscreen
9	Ground point NOTE Reliably ground the router by connecting a ground cable to the ground point to protect the router against lightning and interference.	-	-

4.2 AR150 Series

AR151

Figure 4-3 shows the appearance of the AR151 router.

Figure 4-3 AR151 appearance

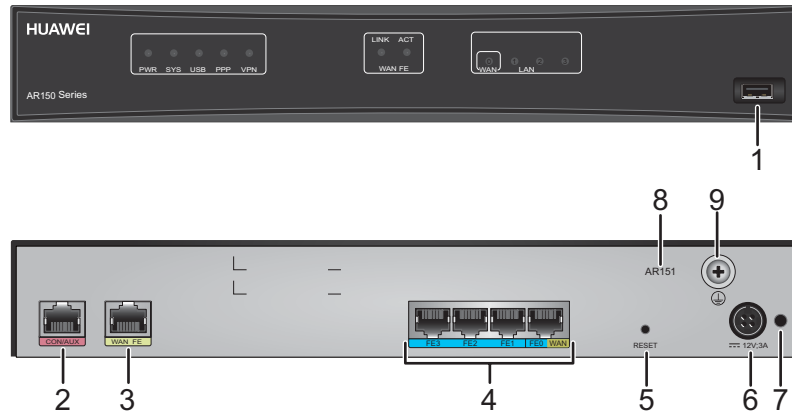

1	USB interface	2	CON/AUX interface NOTE The AR151 does not support AUX login.
3	WAN interface: FE electrical interface	4	LAN interfaces: four FE electrical interfaces NOTE LAN interface FE0 can be used as a WAN interface.
5	RESET button NOTICE This button is used to reset the router. <ul style="list-style-type: none"> To restore the factory settings, hold down the button for at least 5 seconds. To reset the system, press the button. Resetting the router will interrupt services. Exercise caution when deciding to press this button.	6	Power jack NOTE Use a 36 W power adapter to connect the router to a power source.
7	Jack for power cable locking strap NOTE Insert a power cable locking strap in this jack to secure the power cable.	8	Product model silkscreen
9	Ground point NOTE Reliably ground the router by connecting a ground cable to the ground point to protect the router against lightning and interference.	-	-

AR157

Figure 4-4 shows the appearance of the AR157 router.

Figure 4-4 AR157 appearance

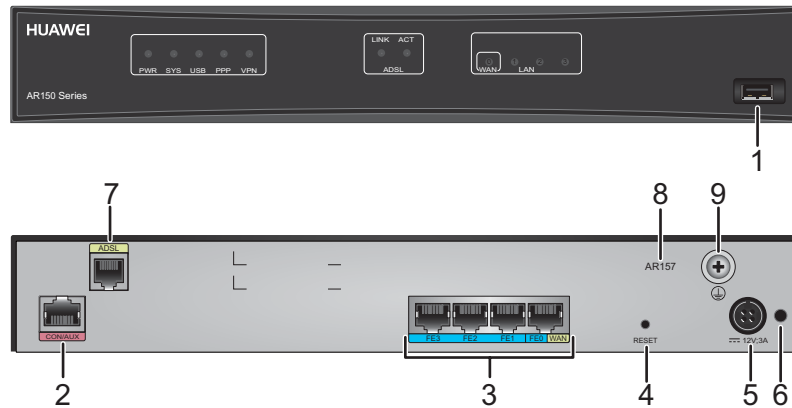

1	USB interface	2	CON/AUX interface NOTE The AR157 does not support AUX login.
3	LAN interfaces: four FE electrical interfaces NOTE LAN interface FE0 can be used as a WAN interface.	4	RESET button NOTICE This button is used to reset the router. <ul style="list-style-type: none"> To restore the factory settings, hold down the button for at least 5 seconds. To reset the system, press the button. Resetting the router will interrupt services. Exercise caution when deciding to press this button.
5	Power jack NOTE Use a 36 W power adapter to connect the router to a power source.	6	Jack for power cable locking strap NOTE Insert a power cable locking strap in this jack to secure the power cable.
7	WAN interface: ADSL-A/M interface	8	Product model silkscreen
9	Ground point NOTE Reliably ground the router by connecting a ground cable to the ground point to protect the router against lightning and interference.	-	-

AR156

Figure 4-5 shows the appearance of the AR156 router.

Figure 4-5 AR156 appearance

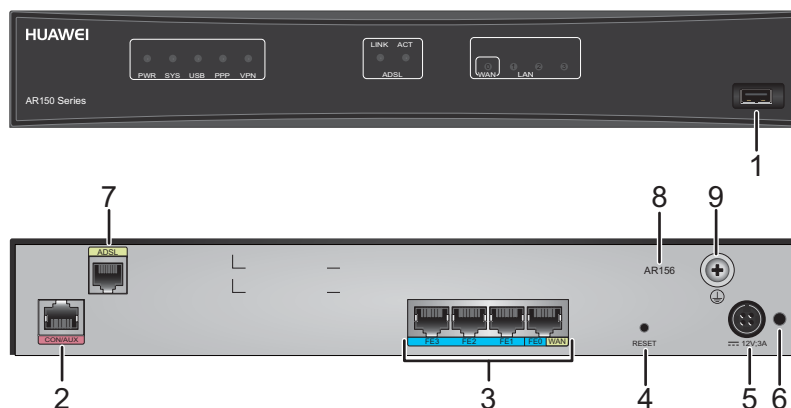

1	USB interface	2	CON/AUX interface NOTE The AR156 does not support AUX login.
3	LAN interfaces: four FE electrical interfaces NOTE LAN interface FE0 can be used as a WAN interface.	4	RESET button NOTICE This button is used to reset the router. <ul style="list-style-type: none"> To restore the factory settings, hold down the button for at least 5 seconds. To reset the system, press the button. Resetting the router will interrupt services. Exercise caution when deciding to press this button.
5	Power jack NOTE Use a 36 W power adapter to connect the router to a power source.	6	Jack for power cable locking strap NOTE Insert a power cable locking strap in this jack to secure the power cable.
7	WAN interface: ADSL-B/J interface	8	Product model silkscreen
9	Ground point NOTE Reliably ground the router by connecting a ground cable to the ground point to protect the router against lightning and interference.	-	-

AR158E

Figure 4-6 shows the appearance of the AR158E router.

Figure 4-6 AR158E appearance

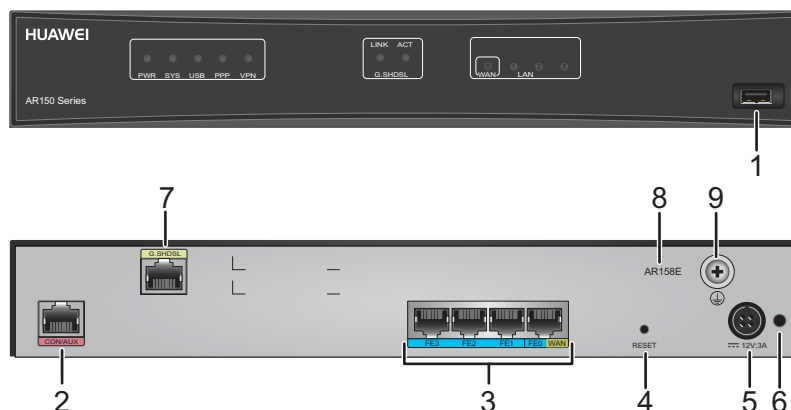

1	USB interface	2	CON/AUX interface NOTE The AR158E does not support AUX login.
3	LAN interfaces: four FE electrical interfaces NOTE LAN interface FE0 can be used as a WAN interface.	4	RESET button NOTICE This button is used to reset the router. <ul style="list-style-type: none"> To restore the factory settings, hold down the button for at least 5 seconds. To reset the system, press the button. Resetting the router will interrupt services. Exercise caution when deciding to press this button.
5	Power jack NOTE Use a 36 W power adapter to connect the router to a power source.	6	Jack for power cable locking strap NOTE Insert a power cable locking strap in this jack to secure the power cable.
7	WAN interface: G.SHDSL interface	8	Product model silkscreen
9	Ground point NOTE Reliably ground the router by connecting a ground cable to the ground point to protect the router against lightning and interference.	-	-

AR151W-P

Figure 4-7 shows the appearance of the AR151W-P router.

Figure 4-7 AR151W-P appearance

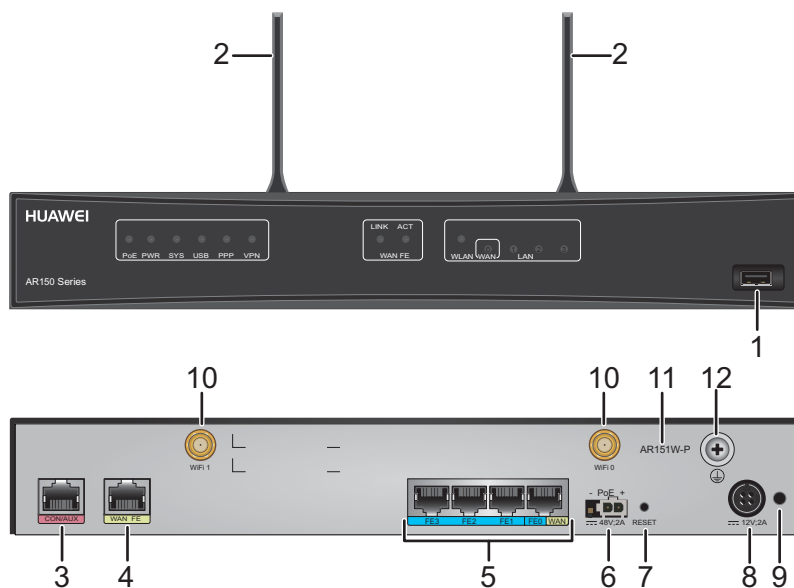

1	USB interface	2	Wi-Fi antenna
3	CON/AUX interface NOTE The AR151W-P does not support AUX login.	4	WAN interface: FE electrical interface
5	LAN interfaces: four FE electrical interfaces NOTE LAN interface FE0 can be used as a WAN interface.	6	PoE power jack NOTE The PoE power jack connects to a 100 W AC PoE power module to provide power for PDs (such as IP phones, WLAN APs, and cameras) connected to FE interfaces of the router.
7	RESET button NOTICE This button is used to reset the router. <ul style="list-style-type: none"> To restore the factory settings, hold down the button for at least 5 seconds. To reset the system, press the button. Resetting the router will interrupt services. Exercise caution when deciding to press this button.	8	Power jack NOTE Use a 24 W power adapter to connect the router to a power source.
9	Jack for power cable locking strap NOTE Insert a power cable locking strap in this jack to secure the power cable.	10	Two Wi-Fi antenna interfaces

11	Product model silkscreen	12	Ground point NOTE Reliably ground the router by connecting a ground cable to the ground point to protect the router against lightning and interference.
----	--------------------------	----	--

AR151G-HSPA+7

Figure 4-8 shows the appearance of the AR151G-HSPA+7 router.

Figure 4-8 AR151G-HSPA+7 appearance

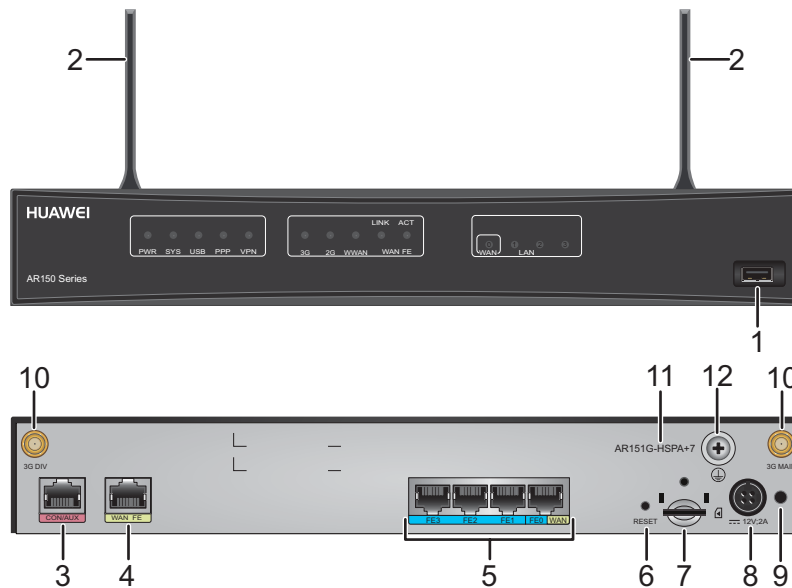

1	USB interface	2	3G antenna
3	CON/AUX interface NOTE The AR151G-HSPA+7 does not support AUX login.	4	WAN interface: FE electrical interface
5	LAN interfaces: four FE electrical interfaces NOTE LAN interface FE0 can be used as a WAN interface.	6	RESET button NOTICE This button is used to reset the router. <ul style="list-style-type: none"> ● To restore the factory settings, hold down the button for at least 5 seconds. ● To reset the system, press the button. Resetting the router will interrupt services. Exercise caution when deciding to press this button.

7	SIM card slot NOTE The mounting hole above the SIM card slots is used to fix the SIM card cover with a screw.	8	Power jack NOTE Use a 24 W power adapter to connect the router to a power source.
9	Jack for power cable locking strap NOTE Insert a power cable locking strap in this jack to secure the power cable.	10	Two 3G-HSPA+7 antenna interfaces
11	Product model silkscreen	12	Ground point NOTE Reliably ground the router by connecting a ground cable to the ground point to protect the router against lightning and interference.

AR157W

Figure 4-9 shows the appearance of the AR157W router.

Figure 4-9 AR157W appearance

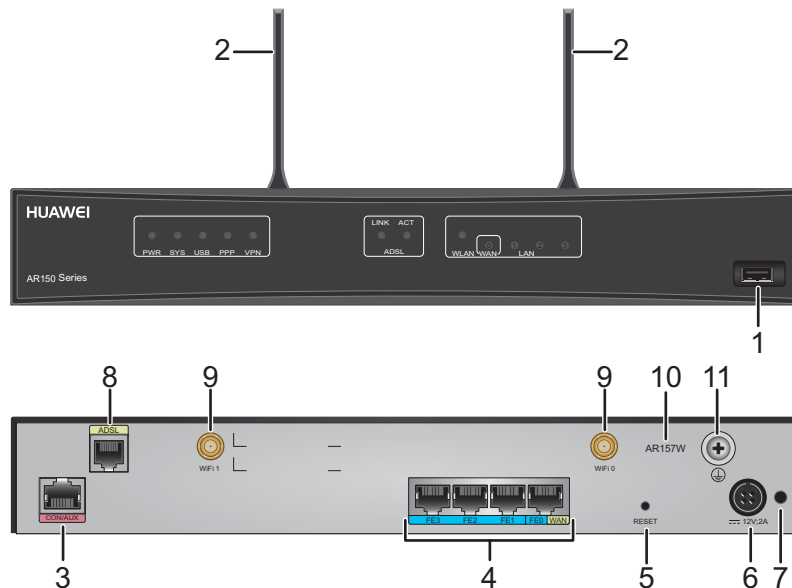

1	USB interface	2	Wi-Fi antenna
3	CON/AUX interface NOTE The AR157W does not support AUX login.	4	LAN interfaces: four FE electrical interfaces NOTE LAN interface FE0 can be used as a WAN interface.

5	RESET button NOTICE This button is used to reset the router. <ul style="list-style-type: none"> To restore the factory settings, hold down the button for at least 5 seconds. To reset the system, press the button. Resetting the router will interrupt services. Exercise caution when deciding to press this button.	6	Power jack NOTE Use a 36 W power adapter to connect the router to a power source.
7	Jack for power cable locking strap NOTE Insert a power cable locking strap in this jack to secure the power cable.	8	WAN interface: ADSL-A/M interface
9	Two Wi-Fi antenna interfaces	10	Product model silkscreen
11	Ground point NOTE Reliably ground the router by connecting a ground cable to the ground point to protect the router against lightning and interference.	-	-

AR157VW

Figure 4-10 shows the appearance of the AR157VW router.

Figure 4-10 AR157VW appearance

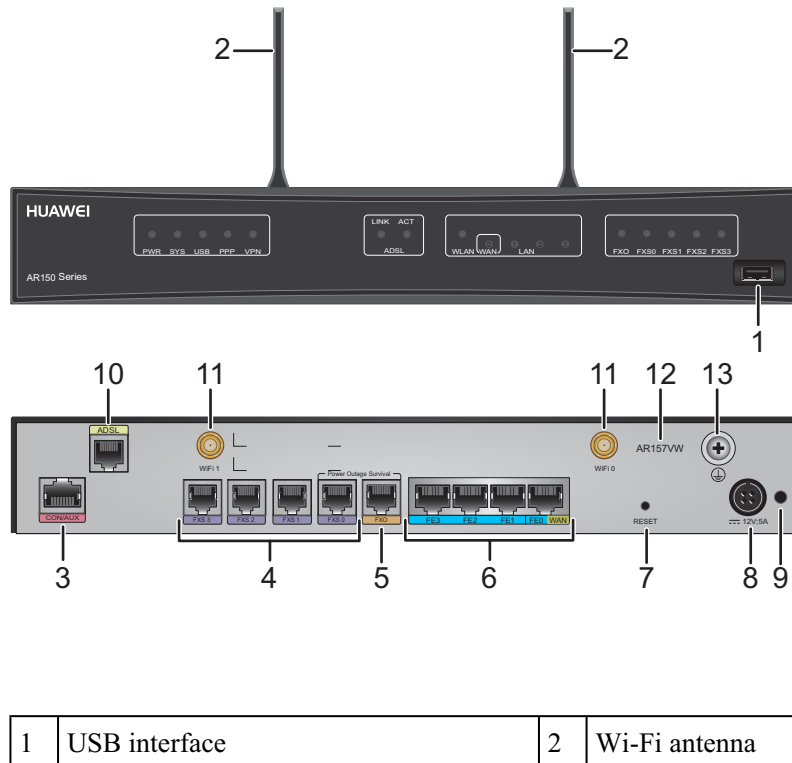

3	<p>CON/AUX interface</p> <p>NOTE</p> <p>The AR157VW does not support AUX login.</p>	4	<p>Four FXS interfaces</p> <p>NOTE</p> <p>The FXS interfaces can be connected to analog telephones using standard telephone cables.</p>
5	<p>One FXO interface</p> <p>NOTE</p> <p>The FXO interface can be connected to a public switched telephone network (PSTN) using a standard telephone cable.</p>	6	<p>LAN interfaces: four FE electrical interfaces</p> <p>NOTE</p> <p>LAN interface FE0 can be used as a WAN interface.</p>
7	<p>RESET button</p> <p>NOTICE</p> <p>This button is used to reset the router.</p> <ul style="list-style-type: none"> ● To restore the factory settings, hold down the button for at least 5 seconds. ● To reset the system, press the button. <p>Resetting the router will interrupt services. Exercise caution when deciding to press this button.</p>	8	<p>Power jack</p> <p>NOTE</p> <p>Use a 60 W power adapter to connect the router to a power source.</p>
9	<p>Jack for power cable locking strap</p> <p>NOTE</p> <p>Insert a power cable locking strap in this jack to secure the power cable.</p>	10	<p>WAN interface: ADSL-A/M interface</p>
11	<p>Two Wi-Fi antenna interfaces</p>	12	<p>Product model silkscreen</p>
13	<p>Ground point</p> <p>NOTE</p> <p>Reliably ground the router by connecting a ground cable to the ground point to protect the router against lightning and interference.</p>	-	-

AR157G-HSPA+7

Figure 4-11 shows the appearance of the AR157G-HSPA+7 router.

Figure 4-11 AR157G-HSPA+7 appearance

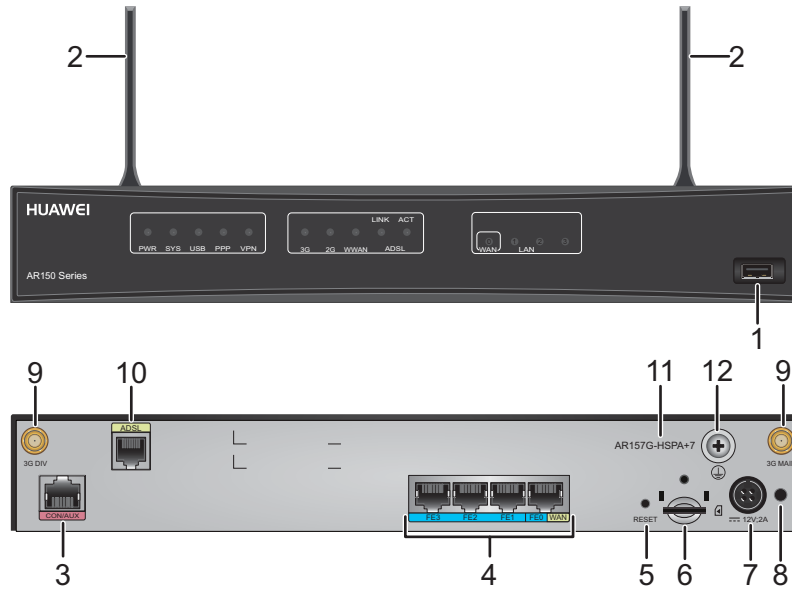

1	USB interface	2	3G antenna
3	CON/AUX interface NOTE The AR157G-HSPA+7 does not support AUX login.	4	LAN interfaces: four FE electrical interfaces NOTE LAN interface FE0 can be used as a WAN interface.
5	RESET button NOTICE This button is used to reset the router. <ul style="list-style-type: none"> To restore the factory settings, hold down the button for at least 5 seconds. To reset the system, press the button. Resetting the router will interrupt services. Exercise caution when deciding to press this button.	6	SIM card slot NOTE The mounting hole above the SIM card slots is used to fix the SIM card cover with a screw.
7	Power jack NOTE Use a 36 W power adapter to connect the router to a power source.	8	Jack for power cable locking strap NOTE Insert a power cable locking strap in this jack to secure the power cable.
9	Two 3G-HSPA+7 antenna interfaces	10	WAN interface: ADSL-A/M interface
11	Product model silkscreen	12	Ground point NOTE Reliably ground the router by connecting a ground cable to the ground point to protect the router against lightning and interference.

AR158EVW

Figure 4-12 shows the appearance of the AR158EVW router.

Figure 4-12 AR158EVW appearance

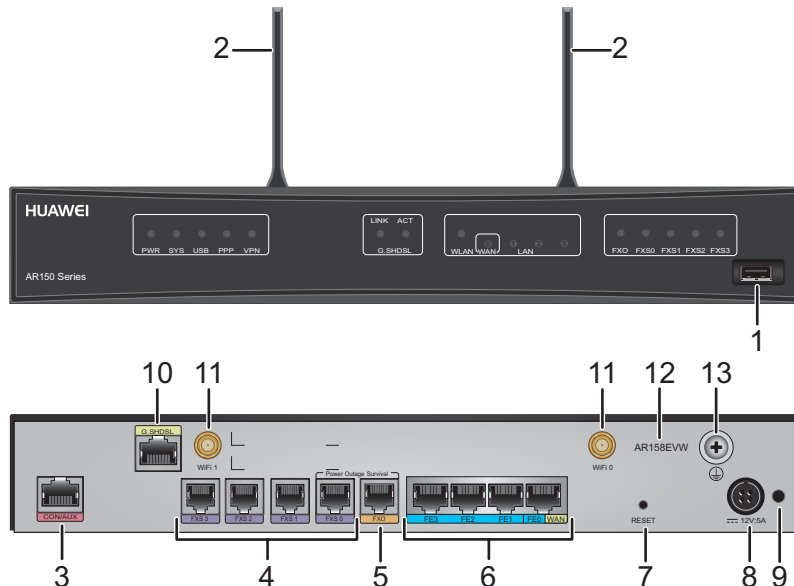

1	USB interface	2	Wi-Fi antenna
3	CON/AUX interface NOTE The AR158EVW does not support AUX login.	4	Four FXS interfaces NOTE The FXS interfaces can be connected to analog telephones using standard telephone cables.
5	One FXO interface NOTE The FXO interface can be connected to a public switched telephone network (PSTN) using a standard telephone cable.	6	LAN interfaces: four FE electrical interfaces NOTE LAN interface FE0 can be used as a WAN interface.
7	RESET button NOTICE This button is used to reset the router. <ul style="list-style-type: none"> To restore the factory settings, hold down the button for at least 5 seconds. To reset the system, press the button. Resetting the router will interrupt services. Exercise caution when deciding to press this button.	8	Power jack NOTE Use a 60 W power adapter to connect the router to a power source.

9	Jack for power cable locking strap NOTE Insert a power cable locking strap in this jack to secure the power cable.	10	WAN interface: G.SHDSL interface
11	Two Wi-Fi antenna interfaces	12	Product model silkscreen
13	Ground point NOTE Reliably ground the router by connecting a ground cable to the ground point to protect the router against lightning and interference.	-	-

AR151G-C

Figure 4-13 shows the appearance of the AR151G-C router.

Figure 4-13 AR151G-C appearance

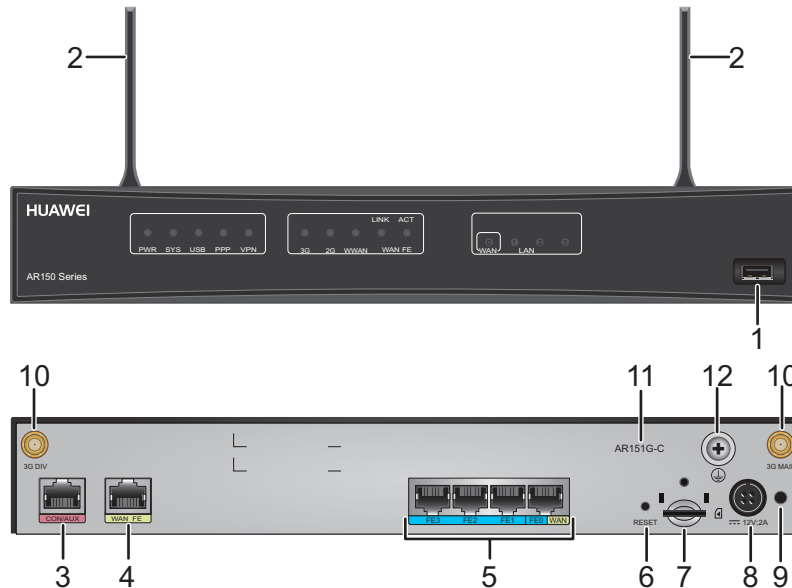

1	USB interface	2	3G antenna
3	CON/AUX interface NOTE The AR151G-C does not support AUX login.	4	WAN interface: FE electrical interface

5	LAN interfaces: four FE electrical interfaces NOTE LAN interface FE0 can be used as a WAN interface.	6	RESET button NOTICE This button is used to reset the router. ● To restore the factory settings, hold down the button for at least 5 seconds. ● To reset the system, press the button. Resetting the router will interrupt services. Exercise caution when deciding to press this button.
7	SIM card slot NOTE The mounting hole above the SIM card slots is used to fix the SIM card cover with a screw.	8	Power jack NOTE Use a 36 W power adapter to connect the router to a power source.
9	Jack for power cable locking strap NOTE Insert a power cable locking strap in this jack to secure the power cable.	10	Two 3G-EVDO antenna interfaces
11	Product model silkscreen	12	Ground point NOTE Reliably ground the router by connecting a ground cable to the ground point to protect the router against lightning and interference.

AR156W

Figure 4-14 shows the appearance of the AR156W router.

Figure 4-14 AR156W appearance

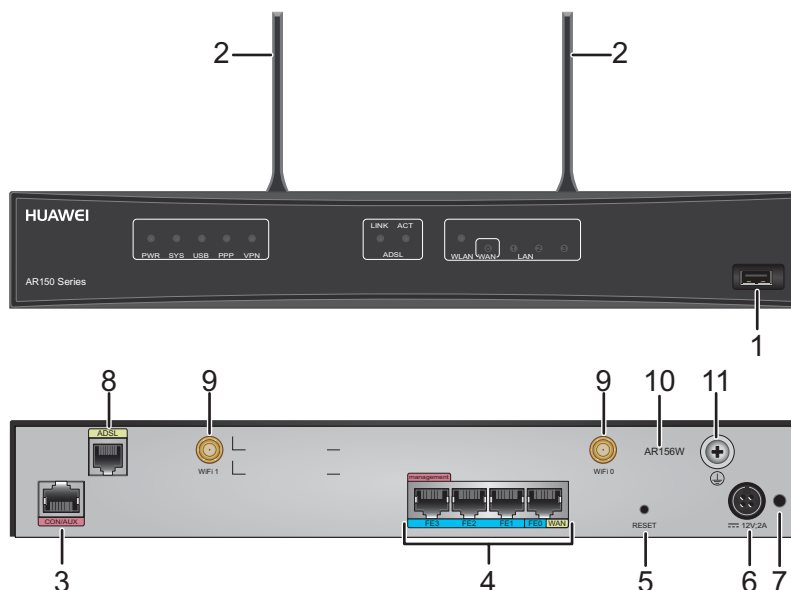

1	USB interface	2	Wi-Fi antenna
3	CON/AUX interface NOTE The AR156W does not support AUX login.	4	LAN interfaces: four FE electrical interfaces NOTE LAN interface FE0 can be used as a WAN interface.
5	RESET button NOTICE This button is used to reset the router. <ul style="list-style-type: none"> To restore the factory settings, hold down the button for at least 5 seconds. To reset the system, press the button. Resetting the router will interrupt services. Exercise caution when deciding to press this button.	6	Power jack NOTE Use a 36 W power adapter to connect the router to a power source.
7	Jack for power cable locking strap NOTE Insert a power cable locking strap in this jack to secure the power cable.	8	WAN interface: ADSL-B/J interface
9	Two Wi-Fi antenna interfaces	10	Product model silkscreen
11	Ground point NOTE Reliably ground the router by connecting a ground cable to the ground point to protect the router against lightning and interference.	-	-

4.3 AR160 Series

AR168F

Figure 4-15 shows the appearance of the AR168F router.

Figure 4-15 AR168F appearance

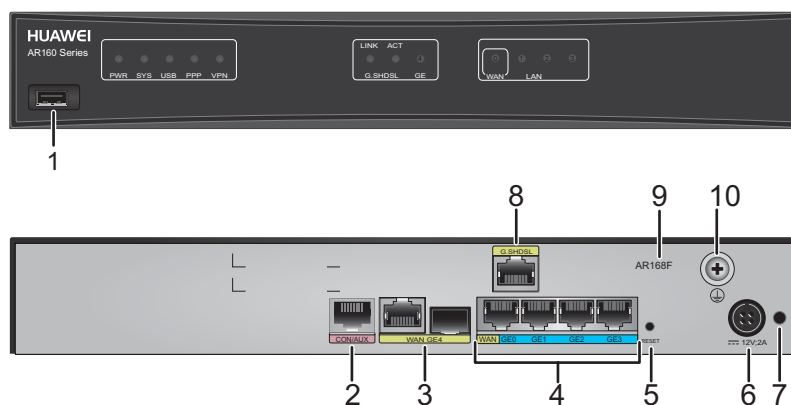

1	USB interface	2	CON/AUX interface NOTE The AR168F does not support AUX login.
3	WAN interface: GE combo interface	4	LAN interfaces: four GE electrical interfaces NOTE GE0 is a management interface and is used to upgrade the router. It can be configured as a WAN interface.
5	RESET button NOTICE This button is used to reset the router. <ul style="list-style-type: none"> To restore the factory settings, hold down the button for at least 5 seconds. To reset the system, press the button. Resetting the router will interrupt services. Exercise caution when deciding to press this button.	6	Power jack NOTE Use a 24 W power adapter to connect the router to a power source.
7	Jack for power cable locking strap NOTE Insert a power cable locking strap in this jack to secure the power cable.	8	WAN interface: G.SHDSL interface NOTE The G.SHDSL interface supports the dying gasp function.
9	Product model silkscreen	10	Ground point NOTE Reliably ground the router by connecting a ground cable to the ground point to protect the router against lightning and interference.

AR169F

Figure 4-16 shows the appearance of the AR169F router.

Figure 4-16 AR169F appearance

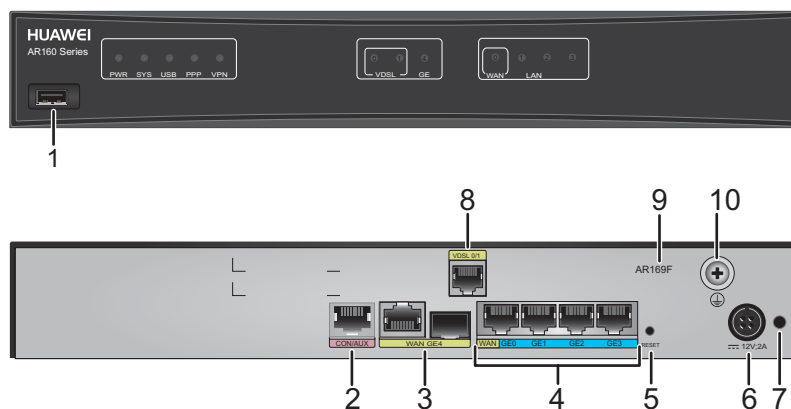

1	USB interface	2	CON/AUX interface NOTE The AR169F does not support AUX login.
3	WAN interface: GE combo interface	4	LAN interfaces: four GE electrical interfaces NOTE GE0 is a management interface and is used to upgrade the router. It can be configured as a WAN interface.
5	RESET button NOTICE This button is used to reset the router. <ul style="list-style-type: none"> ● To restore the factory settings, hold down the button for at least 5 seconds. ● To reset the system, press the button. Resetting the router will interrupt services. Exercise caution when deciding to press this button.	6	Power jack NOTE Use a 24 W power adapter to connect the router to a power source.
7	Jack for power cable locking strap NOTE Insert a power cable locking strap in this jack to secure the power cable.	8	WAN interface: VDSL interface NOTE The VDSL0 and VDSL1 interfaces must be used together as two VDSL bonding interfaces.
9	Product model silkscreen	10	Ground point NOTE Reliably ground the router by connecting a ground cable to the ground point to protect the router against lightning and interference.

AR161FG-L

Figure 4-17 shows the appearance of the AR161FG-L router.

Figure 4-17 AR161FG-L appearance

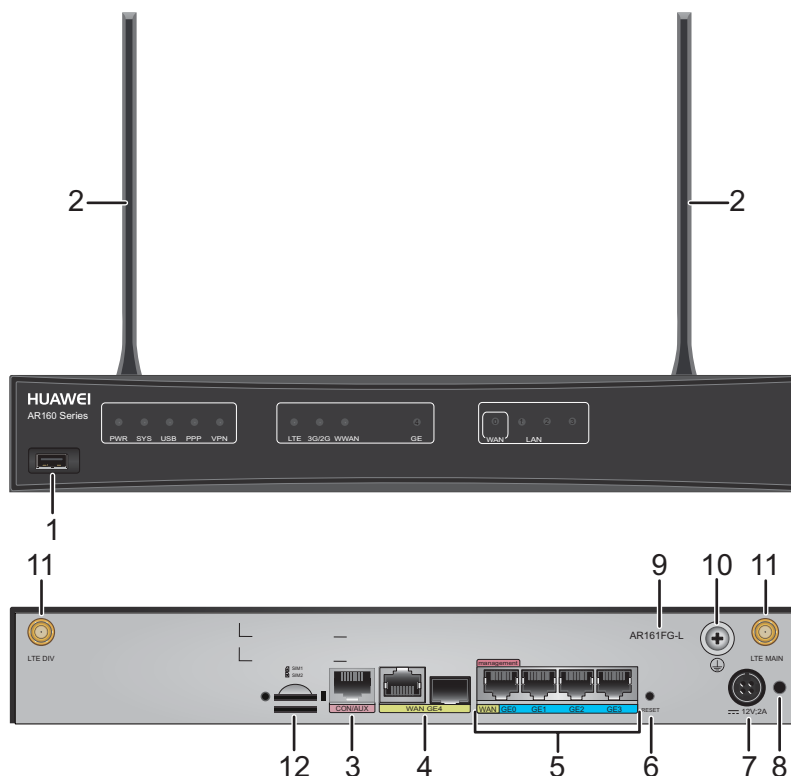

1	USB interface	2	LTE antenna
3	CON/AUX interface NOTE The AR161FG-L does not support AUX login.	4	WAN interface: GE combo interface
5	LAN interfaces: four GE electrical interfaces NOTE GE0 is a management interface and is used to upgrade the router. It can be configured as a WAN interface.	6	RESET button NOTICE This button is used to reset the router. <ul style="list-style-type: none"> To restore the factory settings, hold down the button for at least 5 seconds. To reset the system, press the button. Resetting the router will interrupt services. Exercise caution when deciding to press this button.
7	Power jack NOTE Use a 24 W power adapter to connect the router to a power source.	8	Jack for power cable locking strap NOTE Insert a power cable locking strap in this jack to secure the power cable.

9	Product model silkscreen	10	Ground point NOTE Reliably ground the router by connecting a ground cable to the ground point to protect the router against lightning and interference.
11	Two LTE antenna interfaces	12	Two SIM card slots NOTE The mounting holes at two sides of the SIM card slots are used to fix the SIM card cover with screws.

AR161FGW-L

Figure 4-18 shows the appearance of the AR161FGW-L router.

Figure 4-18 AR161FGW-L appearance

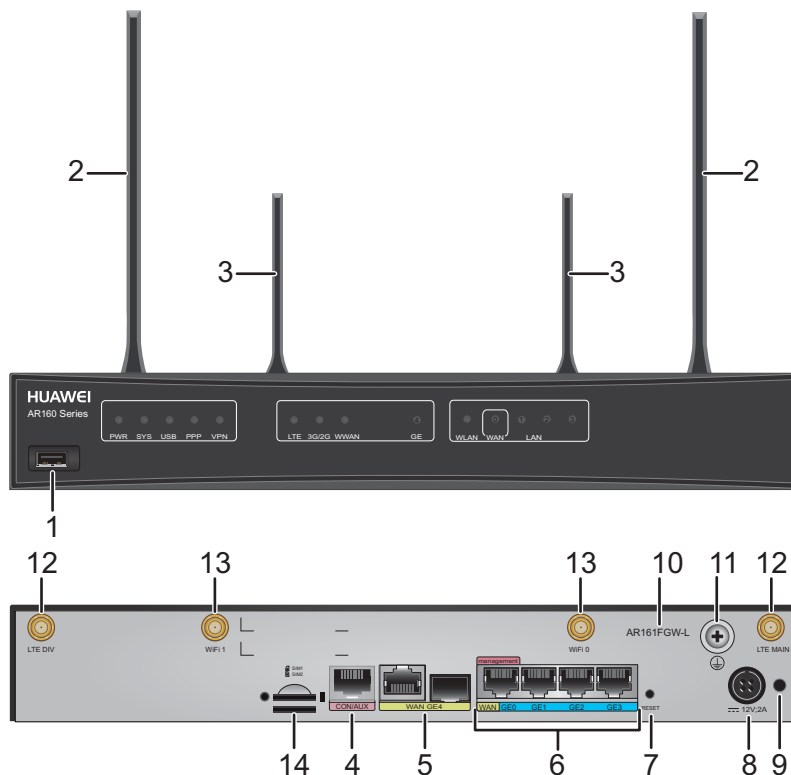

1	USB interface	2	LTE antenna
3	Wi-Fi antenna	4	CON/AUX interface NOTE The AR161FGW-L does not support AUX login.

5	WAN interface: GE combo interface	6	LAN interfaces: four GE electrical interfaces NOTE GE0 is a management interface and is used to upgrade the router. It can be configured as a WAN interface.
7	RESET button NOTICE This button is used to reset the router. <ul style="list-style-type: none"> To restore the factory settings, hold down the button for at least 5 seconds. To reset the system, press the button. Resetting the router will interrupt services. Exercise caution when deciding to press this button.	8	Power jack NOTE Use a 24 W power adapter to connect the router to a power source.
9	Jack for power cable locking strap NOTE Insert a power cable locking strap in this jack to secure the power cable.	10	Product model silkscreen
11	Ground point NOTE Reliably ground the router by connecting a ground cable to the ground point to protect the router against lightning and interference.	12	Two LTE antenna interfaces
13	Two Wi-Fi antenna interfaces	14	Two SIM card slots NOTE The mounting holes at two sides of the SIM card slots are used to fix the SIM card cover with screws.

AR162F

Figure 4-19 shows the appearance of the AR162F router.

Figure 4-19 AR162F appearance

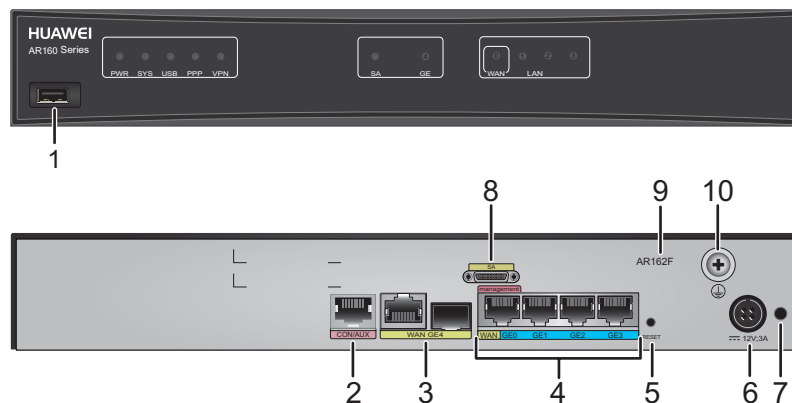

1	USB interface	2	CON/AUX interface NOTE The AR162F does not support AUX login.
3	WAN interface: GE combo interface	4	LAN interfaces: four GE electrical interfaces NOTE GE0 is a management interface and is used to upgrade the router. It can be configured as a WAN interface.
5	RESET button NOTICE This button is used to reset the router. <ul style="list-style-type: none"> ● To restore the factory settings, hold down the button for at least 5 seconds. ● To reset the system, press the button. Resetting the router will interrupt services. Exercise caution when deciding to press this button.	6	Power jack NOTE Use a 36 W power adapter to connect the router to a power source.
7	Jack for power cable locking strap NOTE Insert a power cable locking strap in this jack to secure the power cable.	8	WAN interface: SA interface
9	Product model silkscreen	10	Ground point NOTE Reliably ground the router by connecting a ground cable to the ground point to protect the router against lightning and interference.

AR161FW

Figure 4-20 shows the appearance of the AR161FW router.

Figure 4-20 AR161FW appearance

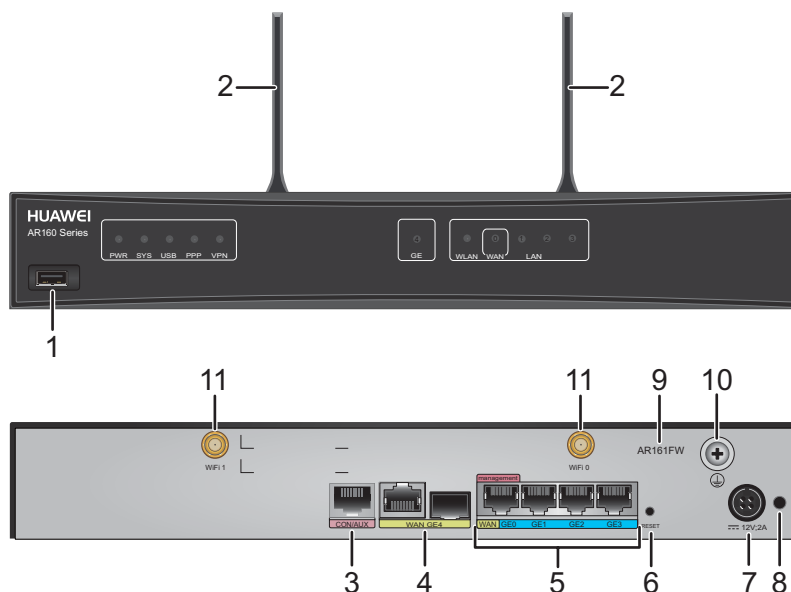

1	USB interface	2	Wi-Fi antenna
3	CON/AUX interface NOTE The AR161FW does not support AUX login.	4	WAN interface: GE combo interface
5	LAN interfaces: four GE electrical interfaces NOTE GE0 is a management interface and is used to upgrade the router. It can be configured as a WAN interface.	6	RESET button NOTICE This button is used to reset the router. <ul style="list-style-type: none"> To restore the factory settings, hold down the button for at least 5 seconds. To reset the system, press the button. Resetting the router will interrupt services. Exercise caution when deciding to press this button.
7	Power jack NOTE Use a 24 W power adapter to connect the router to a power source.	8	Jack for power cable locking strap NOTE Insert a power cable locking strap in this jack to secure the power cable.
9	Product model silkscreen	10	Ground point NOTE Reliably ground the router by connecting a ground cable to the ground point to protect the router against lightning and interference.
11	Two Wi-Fi antenna interfaces	-	-

AR161FW-P-M5

Figure 4-21 shows the appearance of the AR161FW-P-M5 router.

Figure 4-21 AR161FW-P-M5 appearance

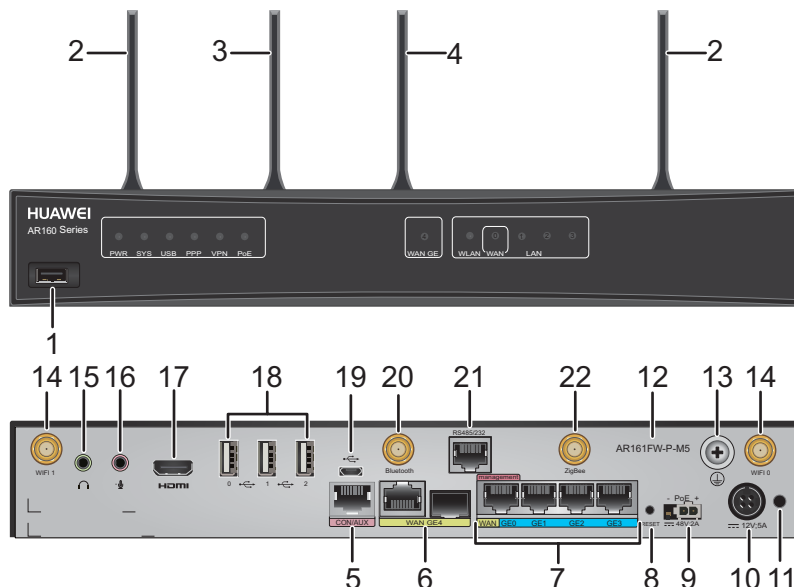

1	USB interface	2	Wi-Fi antenna
3	ZigBee antenna	4	Bluetooth antenna
5	CON/AUX interface NOTE The AR161FW-P-M5 does not support AUX login.	6	WAN interface: GE combo interface
7	LAN interfaces: four GE electrical interfaces NOTE GE0 is a management interface and is used to upgrade the router. It can be configured as a WAN interface.	8	RESET button NOTICE This button is used to reset the router. <ul style="list-style-type: none"> To restore the factory settings, hold down the button for at least 5 seconds. To reset the system, press the button. Resetting the router will interrupt services. Exercise caution when deciding to press this button.
9	PoE power jack NOTE The PoE power jack connects to a 100 W AC PoE power module to provide power for PDs (such as IP phones, WLAN APs, and cameras) connected to FE interfaces of the router.	10	Power jack NOTE Use a 60 W power adapter to connect the router to a power source.

11	Jack for power cable locking strap NOTE Insert a power cable locking strap in this jack to secure the power cable.	12	Product model silkscreen
13	Ground point NOTE Reliably ground the router by connecting a ground cable to the ground point to protect the router against lightning and interference.	14	Two Wi-Fi antenna interfaces
15	Headset jack	16	Microphone jack
17	HDMI video interface	18	Three USB interfaces (host)
19	USB interface (OTG)	20	Bluetooth antenna interface
21	RS485/232 interface	22	ZigBee antenna interface

AR169FVW

Figure 4-22 shows the appearance of the AR169FVW router.

Figure 4-22 AR169FVW appearance

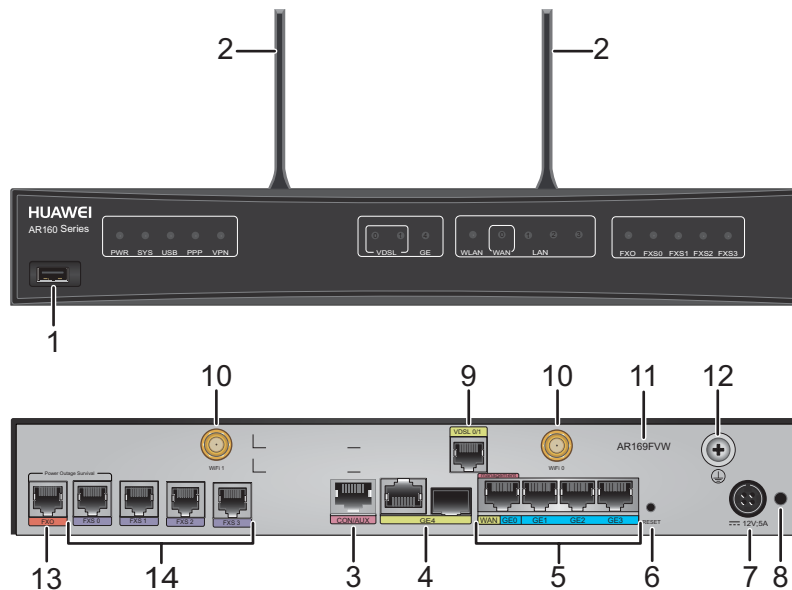

1	USB interface	2	Wi-Fi antenna
3	CON/AUX interface NOTE The AR169FVW does not support AUX login.	4	WAN interface: GE combo interface

5	LAN interfaces: four GE electrical interfaces NOTE GE0 is a management interface and is used to upgrade the router. It can be configured as a WAN interface.	6	RESET button NOTICE This button is used to reset the router. <ul style="list-style-type: none"> ● To restore the factory settings, hold down the button for at least 5 seconds. ● To reset the system, press the button. Resetting the router will interrupt services. Exercise caution when deciding to press this button.
7	Power jack NOTE Use a 60 W power adapter to connect the router to a power source.	8	Jack for power cable locking strap NOTE Insert a power cable locking strap in this jack to secure the power cable.
9	WAN interface: VDSL interface NOTE The VDSL0 and VDSL1 interfaces must be used together as two VDSL bonding interfaces.	10	Two Wi-Fi antenna interfaces
11	Product model silkscreen	12	Ground point NOTE Reliably ground the router by connecting a ground cable to the ground point to protect the router against lightning and interference.
13	One FXO interface NOTE The FXO interface can be connected to a public switched telephone network (PSTN) using a standard telephone cable.	14	Four FXS interfaces NOTE The FXS interfaces can be connected to analog telephones using standard telephone cables.

AR169FGVW-L

Figure 4-23 shows the appearance of the AR169FGVW-L router.

Figure 4-23 AR169FGVW-L appearance

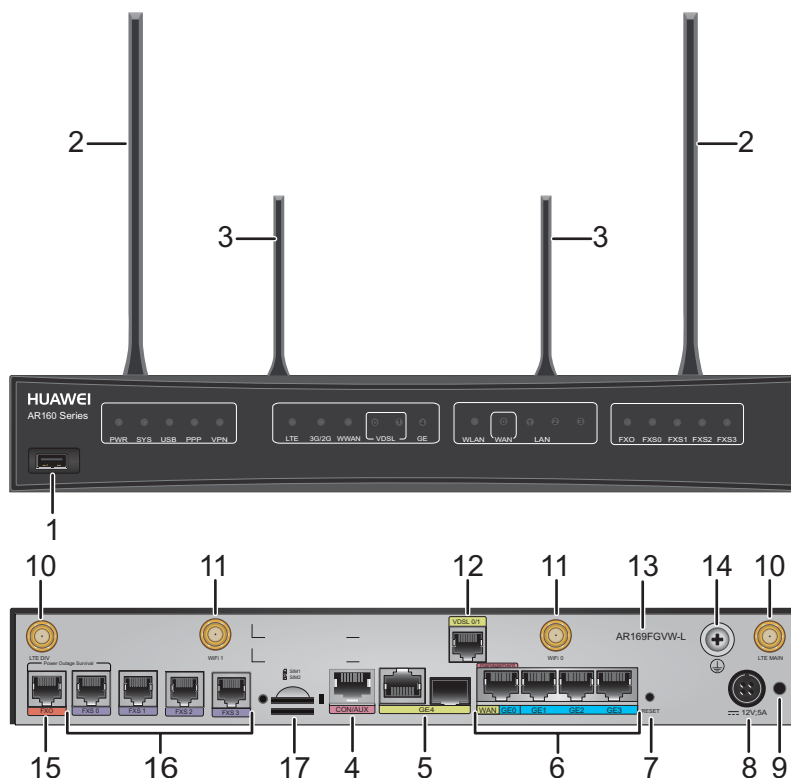

1	USB interface	2	LTE antenna
3	Wi-Fi antenna	4	CON/AUX interface NOTE The AR169FGVW-L does not support AUX login.
5	WAN interface: GE combo interface	6	LAN interfaces: four GE electrical interfaces NOTE GE0 is a management interface and is used to upgrade the router. It can be configured as a WAN interface.
7	RESET button NOTICE This button is used to reset the router. <ul style="list-style-type: none"> To restore the factory settings, hold down the button for at least 5 seconds. To reset the system, press the button. Resetting the router will interrupt services. Exercise caution when deciding to press this button.	8	Power jack NOTE Use a 60 W power adapter to connect the router to a power source.

9	Jack for power cable locking strap NOTE Insert a power cable locking strap in this jack to secure the power cable.	10	Two LTE antenna interfaces
11	Two Wi-Fi antenna interfaces	12	WAN interface: VDSL interface NOTE The VDSL0 and VDSL1 interfaces must be used together as two VDSL bonding interfaces.
13	Product model silkscreen	14	Ground point NOTE Reliably ground the router by connecting a ground cable to the ground point to protect the router against lightning and interference.
15	One FXO interface NOTE The FXO interface can be connected to a public switched telephone network (PSTN) using a standard telephone cable.	16	Four FXS interfaces NOTE The FXS interfaces can be connected to analog telephones using standard telephone cables.
17	Two SIM card slots NOTE The mounting holes at two sides of the SIM card slots are used to fix the SIM card cover with screws.	-	-

AR161F

Figure 4-24 shows the appearance of the AR161F router.

Figure 4-24 AR161F appearance

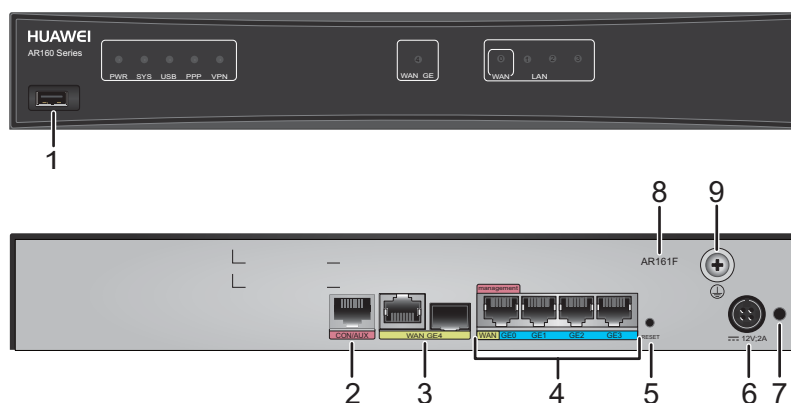

1	USB interface	2	CON/AUX interface NOTE The AR161F does not support AUX login.
3	WAN interface: GE combo interface	4	LAN interfaces: four GE electrical interfaces NOTE GE0 is a management interface and is used to upgrade the router. It can be configured as a WAN interface.
5	RESET button NOTICE This button is used to reset the router. <ul style="list-style-type: none"> ● To restore the factory settings, hold down the button for at least 5 seconds. ● To reset the system, press the button. Resetting the router will interrupt services. Exercise caution when deciding to press this button.	6	Power jack NOTE Use a 24 W power adapter to connect the router to a power source.
7	Jack for power cable locking strap NOTE Insert a power cable locking strap in this jack to secure the power cable.	8	Product model silkscreen
9	Ground point NOTE Reliably ground the router by connecting a ground cable to the ground point to protect the router against lightning and interference.	-	-

AR169FGW-L

Figure 4-25 shows the appearance of the AR169FGW-L router.

Figure 4-25 AR169FGW-L appearance

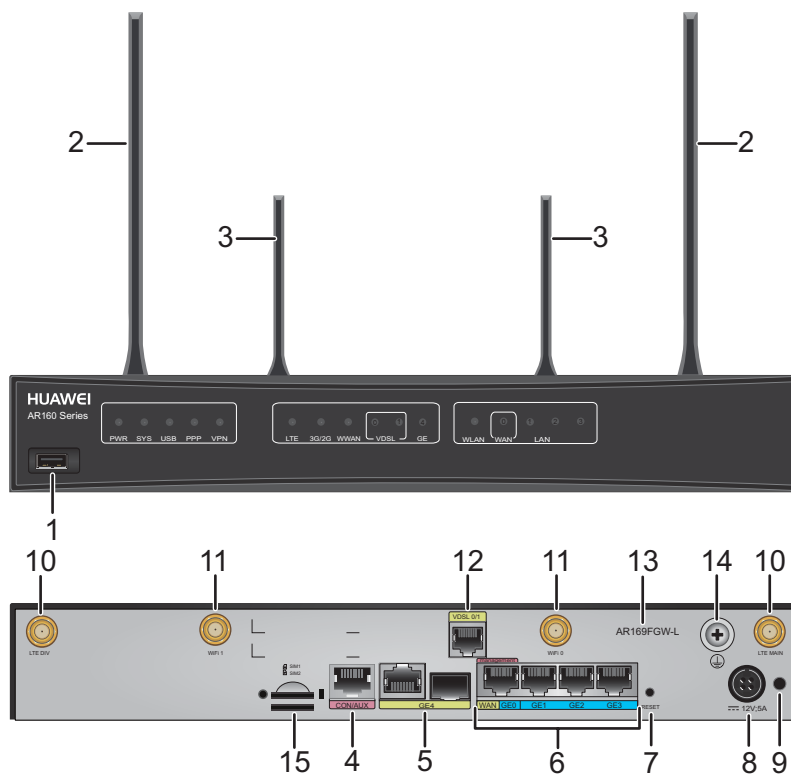

1	USB interface	2	LTE antenna
3	Wi-Fi antenna	4	CON/AUX interface NOTE The AR169FGW-L does not support AUX login.
5	WAN interface: GE combo interface	6	LAN interfaces: four GE electrical interfaces NOTE GE0 is a management interface and is used to upgrade the router. It can be configured as a WAN interface.
7	RESET button NOTICE This button is used to reset the router. <ul style="list-style-type: none"> To restore the factory settings, hold down the button for at least 5 seconds. To reset the system, press the button. Resetting the router will interrupt services. Exercise caution when deciding to press this button.	8	Power jack NOTE Use a 60 W power adapter to connect the router to a power source.

9	Jack for power cable locking strap NOTE Insert a power cable locking strap in this jack to secure the power cable.	10	Two LTE antenna interfaces
11	Two Wi-Fi antenna interfaces	12	WAN interface: VDSL interface NOTE The VDSL0 and VDSL1 interfaces must be used together as two VDSL bonding interfaces.
13	Product model silkscreen	14	Ground point NOTE Reliably ground the router by connecting a ground cable to the ground point to protect the router against lightning and interference.
15	Two SIM card slots NOTE The mounting holes at two sides of the SIM card slots are used to fix the SIM card cover with screws.	-	-

AR161

Figure 4-26 shows the appearance of the AR161 router.

Figure 4-26 AR161 appearance

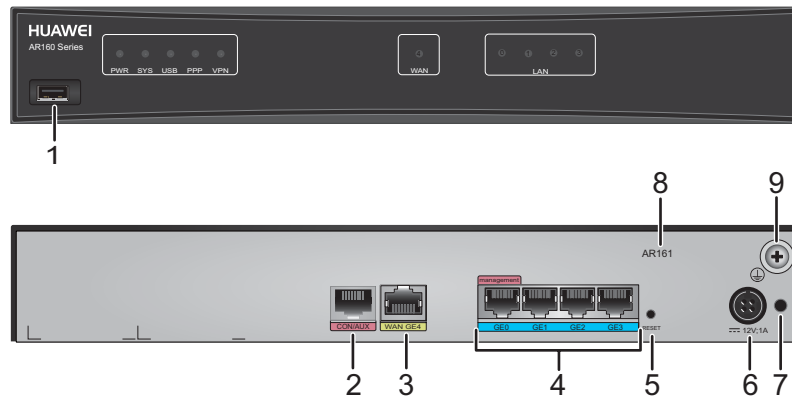

1	USB interface	2	CON/AUX interface NOTE The AR161 does not support AUX login.
---	---------------	---	---

3	WAN interface: GE electrical interface	4	LAN interfaces: four GE electrical interfaces NOTE GE0 is a management interface and is used to upgrade the router.
5	RESET button NOTICE This button is used to reset the router. <ul style="list-style-type: none"> To restore the factory settings, hold down the button for at least 3 seconds. To reset the system, press the button. Resetting the router will interrupt services. Exercise caution when deciding to press this button.	6	Power jack NOTE Use a 24 W power adapter to connect the router to a power source.
7	Jack for power cable locking strap NOTE Insert a power cable locking strap in this jack to secure the power cable.	8	Product model silkscreen
9	Ground point NOTE Reliably ground the router by connecting a ground cable to the ground point to protect the router against lightning and interference.	-	-

AR169

Figure 4-27 shows the appearance of the AR169 router.

Figure 4-27 AR169 appearance

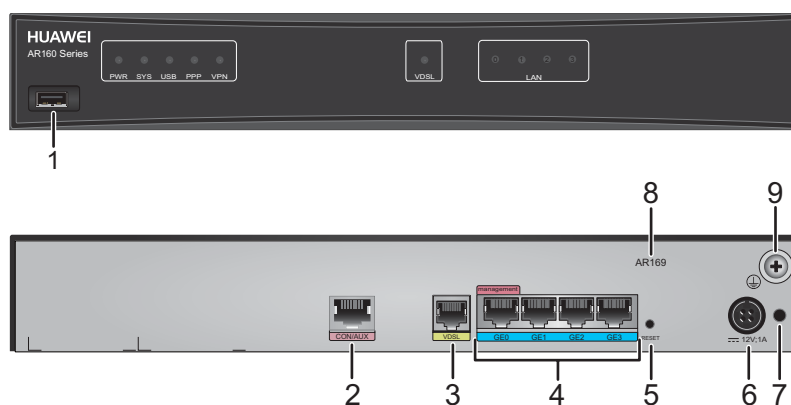

1	USB interface	2	CON/AUX interface NOTE The AR169 does not support AUX login.
3	WAN interface: VDSL interface	4	LAN interfaces: four GE electrical interfaces NOTE GE0 is a management interface and is used to upgrade the router.
5	RESET button NOTICE This button is used to reset the router. <ul style="list-style-type: none"> ● To restore the factory settings, hold down the button for at least 3 seconds. ● To reset the system, press the button. Resetting the router will interrupt services. Exercise caution when deciding to press this button.	6	Power jack NOTE Use a 24 W power adapter to connect the router to a power source.
7	Jack for power cable locking strap NOTE Insert a power cable locking strap in this jack to secure the power cable.	8	Product model silkscreen
9	Ground point NOTE Reliably ground the router by connecting a ground cable to the ground point to protect the router against lightning and interference.	-	-

AR161G-L

Figure 4-28 shows the appearance of the AR161G-L router.

Figure 4-28 AR161G-L appearance

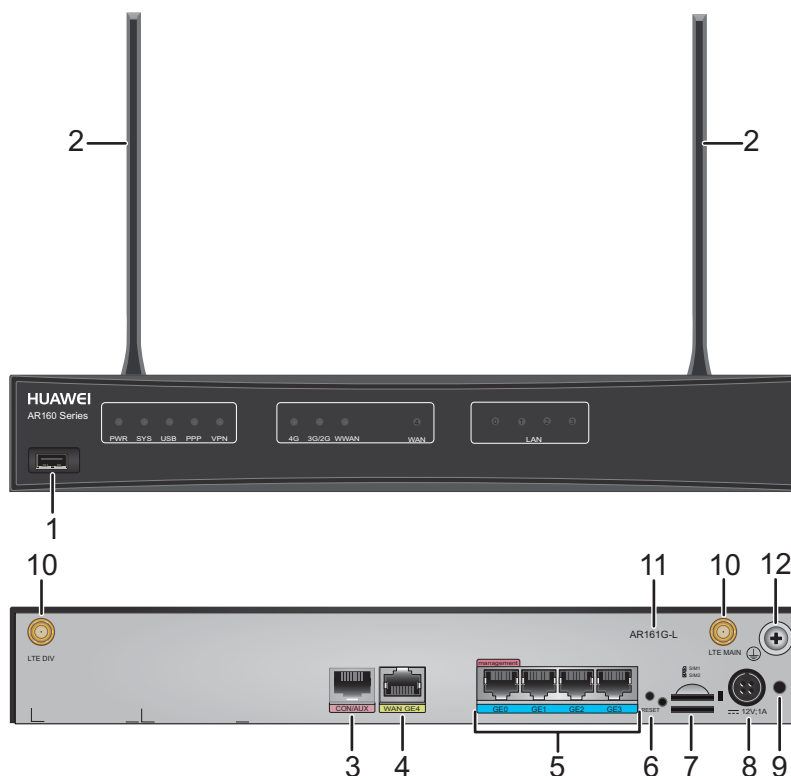

1	USB interface	2	LTE antenna
3	CON/AUX interface NOTE The AR161G-L does not support AUX login.	4	WAN interface: GE electrical interface
5	LAN interfaces: four GE electrical interfaces NOTE GE0 is a management interface and is used to upgrade the router.	6	RESET button NOTICE This button is used to reset the router. <ul style="list-style-type: none"> To restore the factory settings, hold down the button for at least 3 seconds. To reset the system, press the button. Resetting the router will interrupt services. Exercise caution when deciding to press this button.
7	Two SIM card slots NOTE The mounting holes at two sides of the SIM card slots are used to fix the SIM card cover with screws.	8	Power jack NOTE Use a 24 W power adapter to connect the router to a power source.

9	Jack for power cable locking strap NOTE Insert a power cable locking strap in this jack to secure the power cable.	10	Two LTE antenna interfaces
11	Product model silkscreen	12	Ground point NOTE Reliably ground the router by connecting a ground cable to the ground point to protect the router against lightning and interference.

AR169G-L

Figure 4-29 shows the appearance of the AR169G-L router.

Figure 4-29 AR169G-L appearance

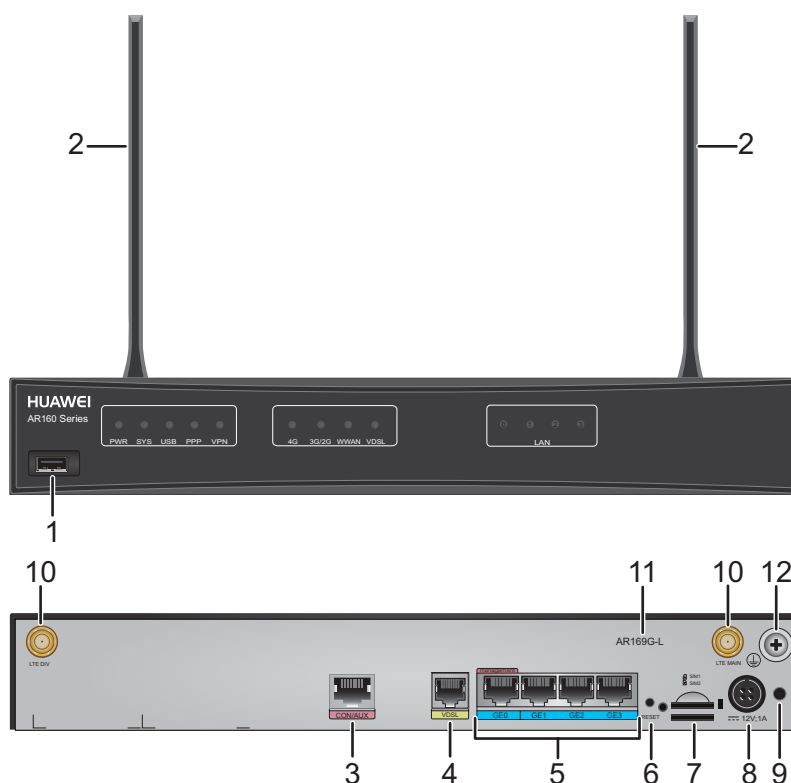

1	USB interface	2	LTE antenna
3	CON/AUX interface NOTE The AR169G-L does not support AUX login.	4	WAN interface: VDSL interface

5	<p>LAN interfaces: four GE electrical interfaces</p> <p>NOTE</p> <p>GE0 is a management interface and is used to upgrade the router.</p>	6	<p>RESET button</p> <p>NOTE</p> <p>This button is used to reset the router.</p> <ul style="list-style-type: none"> To restore the factory settings, hold down the button for at least 3 seconds. To reset the system, press the button. <p>Resetting the router will interrupt services. Exercise caution when deciding to press this button.</p>
7	<p>Two SIM card slots</p> <p>NOTE</p> <p>The mounting holes at two sides of the SIM card slots are used to fix the SIM card cover with screws.</p>	8	<p>Power jack</p> <p>NOTE</p> <p>Use a 24 W power adapter to connect the router to a power source.</p>
9	<p>Jack for power cable locking strap</p> <p>NOTE</p> <p>Insert a power cable locking strap in this jack to secure the power cable.</p>	10	<p>Two LTE antenna interfaces</p>
11	<p>Product model silkscreen</p>	12	<p>Ground point</p> <p>NOTE</p> <p>Reliably ground the router by connecting a ground cable to the ground point to protect the router against lightning and interference.</p>

AR169-P-M9

Figure 4-30 shows the appearance of the AR169-P-M9 router.

Figure 4-30 AR169-P-M9 appearance

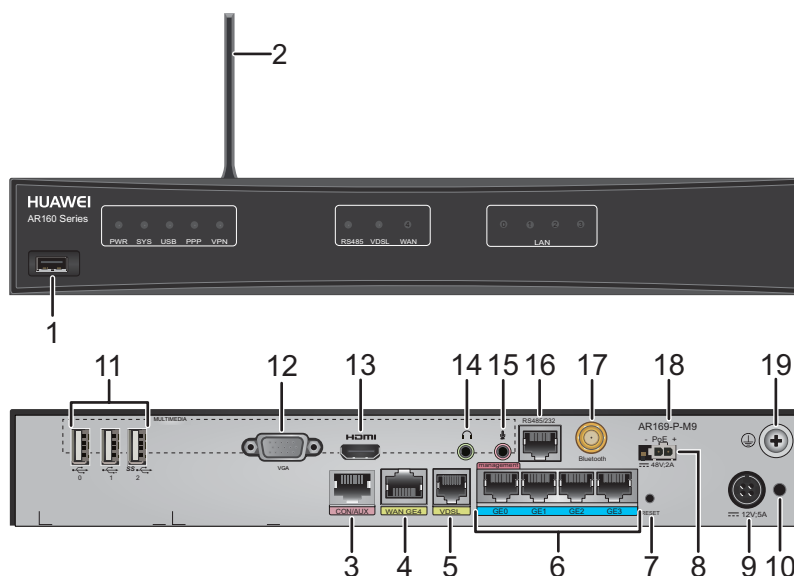

1	USB interface	2	Bluetooth antenna
3	CON/AUX interface NOTE The AR169-P-M9 does not support AUX login.	4	WAN interface: GE electrical interface
5	WAN interface: VDSL interface	6	LAN interfaces: four GE electrical interfaces NOTE GE0 is a management interface and is used to upgrade the router.
7	RESET button NOTICE This button is used to reset the router. <ul style="list-style-type: none"> To restore the factory settings, hold down the button for at least 3 seconds. To reset the system, press the button. Resetting the router will interrupt services. Exercise caution when deciding to press this button.	8	PoE power jack NOTE The PoE power jack connects to a 100 W AC PoE power module to provide power for PDs (such as IP phones, WLAN APs, and cameras) connected to FE interfaces of the router.
9	Power jack NOTE Use a 60 W power adapter to connect the router to a power source.	10	Jack for power cable locking strap NOTE Insert a power cable locking strap in this jack to secure the power cable.
11	Three USB interfaces (host)	12	VGA interface
13	HDMI video interface	14	Headset jack
15	Microphone jack	16	RS485/232 interface
17	Bluetooth antenna interface	18	Product model silkscreen
19	Ground point NOTE Reliably ground the router by connecting a ground cable to the ground point to protect the router against lightning and interference.	-	-

4.4 AR200 Series

AR201

[Figure 4-31](#) shows the appearance of the AR201 router.

Figure 4-31 AR201 appearance

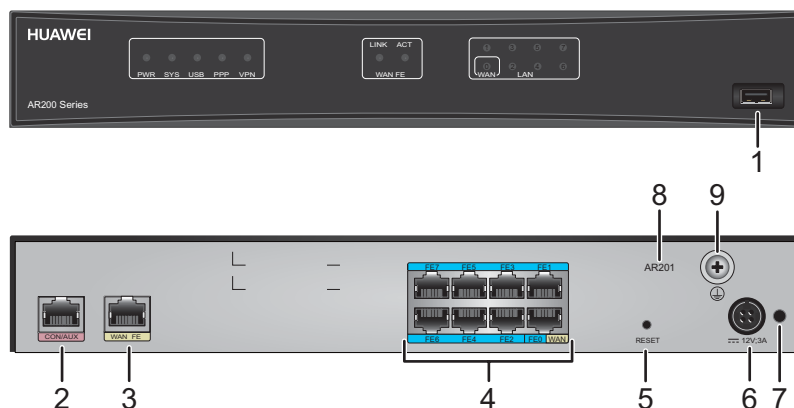

1	USB interface	2	CON/AUX interface NOTE The AR201 does not support AUX login.
3	WAN interface: FE electrical interface	4	LAN interfaces: eight FE electrical interfaces NOTE <ul style="list-style-type: none"> LAN interface FE0 can be used as a WAN interface. FE6 is a management interface and is used to upgrade the router.
5	RESET button NOTICE This button is used to reset the router. <ul style="list-style-type: none"> To restore the factory settings, hold down the button for at least 5 seconds. To reset the system, press the button. Resetting the router will interrupt services. Exercise caution when deciding to press this button.	6	Power jack NOTE Use a 36 W power adapter to connect the router to a power source.
7	Jack for power cable locking strap NOTE Insert a power cable locking strap in this jack to secure the power cable.	8	Product model silkscreen
9	Ground point NOTE Reliably ground the router by connecting a ground cable to the ground point to protect the router against lightning and interference.	-	-

AR206

Figure 4-32 shows the appearance of the AR206 router.

Figure 4-32 AR206 appearance

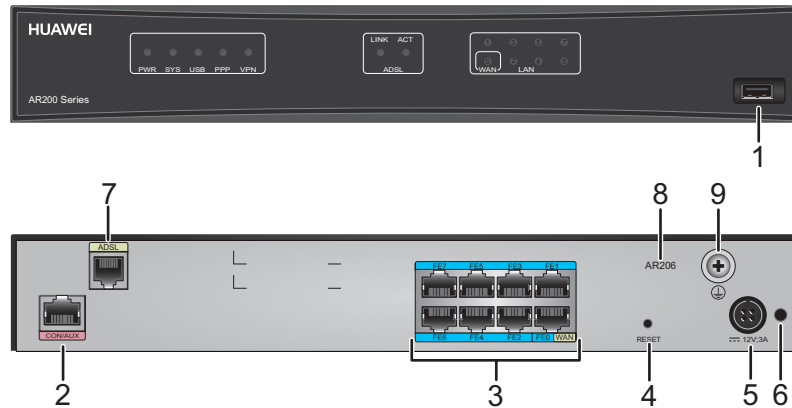

1	USB interface	2	CON/AUX interface NOTE The AR206 does not support AUX login.
3	LAN interfaces: eight FE electrical interfaces NOTE <ul style="list-style-type: none"> LAN interface FE0 can be used as a WAN interface. FE6 is a management interface and is used to upgrade the router. 	4	RESET button NOTICE This button is used to reset the router. <ul style="list-style-type: none"> To restore the factory settings, hold down the button for at least 5 seconds. To reset the system, press the button. Resetting the router will interrupt services. Exercise caution when deciding to press this button.
5	Power jack NOTE Use a 36 W power adapter to connect the router to a power source.	6	Jack for power cable locking strap NOTE Insert a power cable locking strap in this jack to secure the power cable.
7	WAN interface: ADSL-B/J interface	8	Product model silkscreen
9	Ground point NOTE Reliably ground the router by connecting a ground cable to the ground point to protect the router against lightning and interference.	-	-

AR207

Figure 4-33 shows the appearance of the AR207 router.

Figure 4-33 AR207 appearance

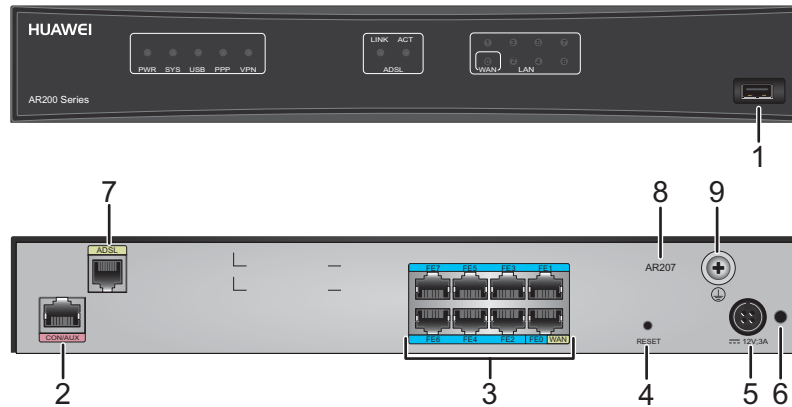

1	USB interface	2	CON/AUX interface NOTE The AR207 does not support AUX login.
3	LAN interfaces: eight FE electrical interfaces NOTE <ul style="list-style-type: none"> LAN interface FE0 can be used as a WAN interface. FE6 is a management interface and is used to upgrade the router. 	4	RESET button NOTICE This button is used to reset the router. <ul style="list-style-type: none"> To restore the factory settings, hold down the button for at least 5 seconds. To reset the system, press the button. Resetting the router will interrupt services. Exercise caution when deciding to press this button.
5	Power jack NOTE Use a 36 W power adapter to connect the router to a power source.	6	Jack for power cable locking strap NOTE Insert a power cable locking strap in this jack to secure the power cable.
7	WAN interface: ADSL-A/M interface	8	Product model silkscreen
9	Ground point NOTE Reliably ground the router by connecting a ground cable to the ground point to protect the router against lightning and interference.	-	-

AR207V

Figure 4-34 shows the appearance of the AR207V router.

Figure 4-34 AR207V appearance

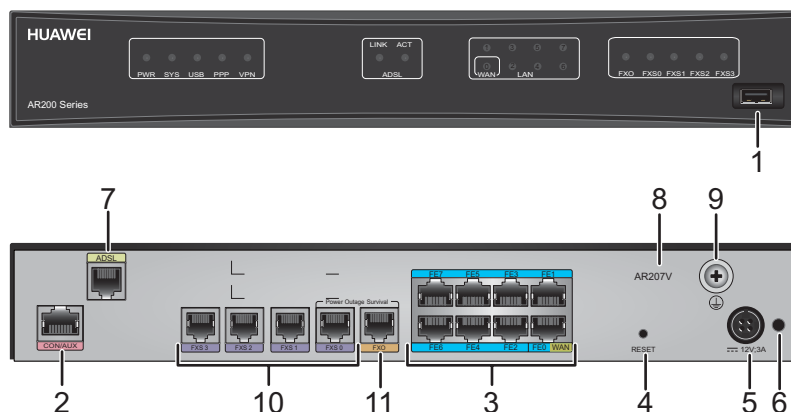

1	USB interface	2	CON/AUX interface NOTE The AR207V does not support AUX login.
3	LAN interfaces: eight FE electrical interfaces NOTE <ul style="list-style-type: none"> LAN interface FE0 can be used as a WAN interface. FE6 is a management interface and is used to upgrade the router. 	4	RESET button NOTICE This button is used to reset the router. <ul style="list-style-type: none"> To restore the factory settings, hold down the button for at least 5 seconds. To reset the system, press the button. Resetting the router will interrupt services. Exercise caution when deciding to press this button.
5	Power jack NOTE Use a 36 W power adapter to connect the router to a power source.	6	Jack for power cable locking strap NOTE Insert a power cable locking strap in this jack to secure the power cable.
7	WAN interface: ADSL-A/M interface	8	Product model silkscreen
9	Ground point NOTE Reliably ground the router by connecting a ground cable to the ground point to protect the router against lightning and interference.	10	Four FXS interfaces NOTE The FXS interfaces can be connected to analog telephones using standard telephone cables.
11	One FXO interface NOTE The FXO interface can be connected to a public switched telephone network (PSTN) using a standard telephone cable.	-	-

AR207V-P

Figure 4-35 shows the appearance of the AR207V-P router.

Figure 4-35 AR207V-P appearance

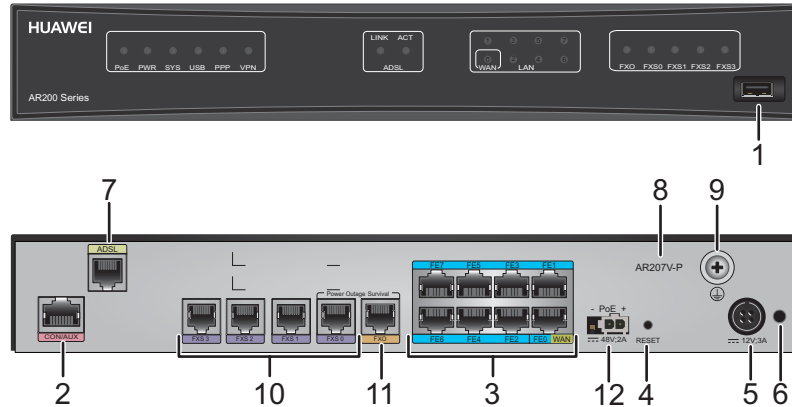

1	USB interface	2	CON/AUX interface NOTE The AR207V-P does not support AUX login.
3	LAN interfaces: eight FE electrical interfaces NOTE <ul style="list-style-type: none"> LAN interface FE0 can be used as a WAN interface. FE6 is a management interface and is used to upgrade the router. 	4	RESET button NOTICE This button is used to reset the router. <ul style="list-style-type: none"> To restore the factory settings, hold down the button for at least 5 seconds. To reset the system, press the button. Resetting the router will interrupt services. Exercise caution when deciding to press this button.
5	Power jack NOTE Use a 36 W power adapter to connect the router to a power source.	6	Jack for power cable locking strap NOTE Insert a power cable locking strap in this jack to secure the power cable.
7	WAN interface: ADSL-A/M interface	8	Product model silkscreen
9	Ground point NOTE Reliably ground the router by connecting a ground cable to the ground point to protect the router against lightning and interference.	10	Four FXS interfaces NOTE The FXS interfaces can be connected to analog telephones using standard telephone cables.
11	One FXO interface NOTE The FXO interface can be connected to a public switched telephone network (PSTN) using a standard telephone cable.	12	PoE power jack NOTE The PoE power jack connects to a 100 W AC PoE power module to provide power for PDs (such as IP phones, WLAN APs, and cameras) connected to FE interfaces of the router.

AR208E

Figure 4-36 shows the appearance of the AR208E router.

Figure 4-36 AR208E appearance

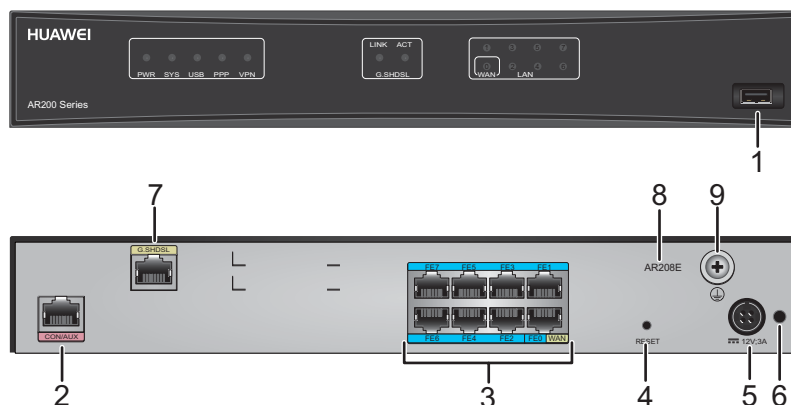

1	USB interface	2	CON/AUX interface NOTE The AR208E does not support AUX login.
3	LAN interfaces: eight FE electrical interfaces NOTE <ul style="list-style-type: none"> LAN interface FE0 can be used as a WAN interface. FE6 is a management interface and is used to upgrade the router. 	4	RESET button NOTICE This button is used to reset the router. <ul style="list-style-type: none"> To restore the factory settings, hold down the button for at least 5 seconds. To reset the system, press the button. Resetting the router will interrupt services. Exercise caution when deciding to press this button.
5	Power jack NOTE Use a 36 W power adapter to connect the router to a power source.	6	Jack for power cable locking strap NOTE Insert a power cable locking strap in this jack to secure the power cable.
7	WAN interface: G.SHDSL interface	8	Product model silkscreen
9	Ground point NOTE Reliably ground the router by connecting a ground cable to the ground point to protect the router against lightning and interference.	-	-

AR207G-HSPA+7

Figure 4-37 shows the appearance of the AR207G-HSPA+7 router.

Figure 4-37 AR207G-HSPA+7 appearance

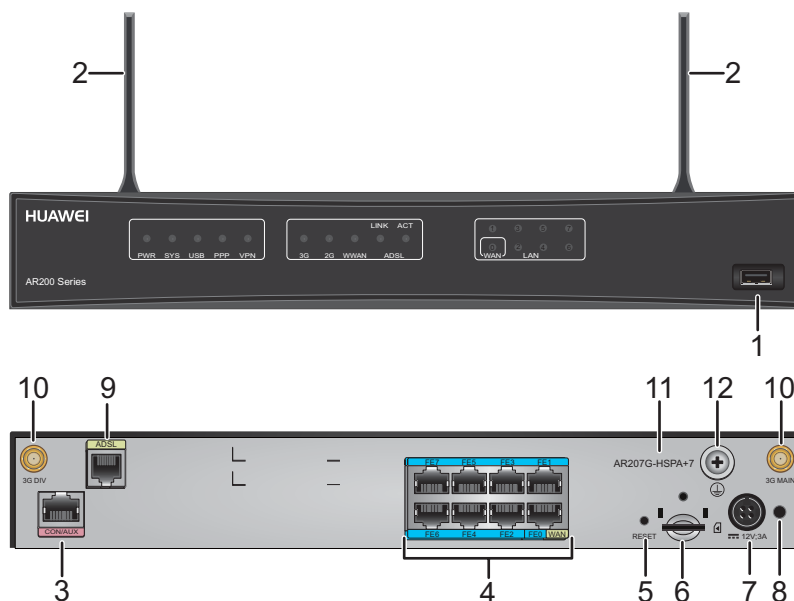

1	USB interface	2	3G antenna
3	CON/AUX interface NOTE The AR207G-HSPA+7 does not support AUX login.	4	LAN interfaces: eight FE electrical interfaces NOTE <ul style="list-style-type: none"> LAN interface FE0 can be used as a WAN interface. FE6 is a management interface and is used to upgrade the router.
5	RESET button NOTICE This button is used to reset the router. <ul style="list-style-type: none"> To restore the factory settings, hold down the button for at least 5 seconds. To reset the system, press the button. Resetting the router will interrupt services. Exercise caution when deciding to press this button.	6	SIM card slot NOTE The mounting hole above the SIM card slots is used to fix the SIM card cover with a screw.
7	Power jack NOTE Use a 36 W power adapter to connect the router to a power source.	8	Jack for power cable locking strap NOTE Insert a power cable locking strap in this jack to secure the power cable.
9	WAN interface: ADSL-A/M interface	10	Two 3G-HSPA+7 antenna interfaces

<p>11 Product model silkscreen</p>	<p>12 Ground point NOTE Reliably ground the router by connecting a ground cable to the ground point to protect the router against lightning and interference.</p>
------------------------------------	--

AR201VW-P

Figure 4-38 shows the appearance of the AR201VW-P router.

Figure 4-38 AR201VW-P appearance

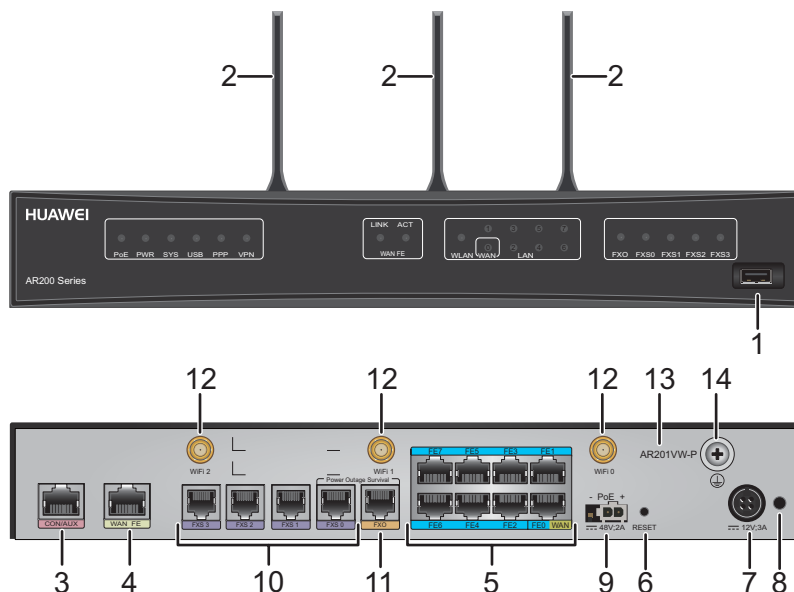

<p>1 USB interface</p>	<p>2 Wi-Fi antenna</p>
<p>3 CON/AUX interface NOTE The AR201VW-P does not support AUX login.</p>	<p>4 WAN interface: FE electrical interface</p>
<p>5 LAN interfaces: eight FE electrical interfaces NOTE</p> <ul style="list-style-type: none"> LAN interface FE0 can be used as a WAN interface. FE6 is a management interface and is used to upgrade the router. 	<p>6 RESET button NOTICE This button is used to reset the router.</p> <ul style="list-style-type: none"> To restore the factory settings, hold down the button for at least 5 seconds. To reset the system, press the button. <p>Resetting the router will interrupt services. Exercise caution when deciding to press this button.</p>

7	Power jack NOTE Use a 36 W power adapter to connect the router to a power source.	8	Jack for power cable locking strap NOTE Insert a power cable locking strap in this jack to secure the power cable.
9	PoE power jack NOTE The PoE power jack connects to a 100 W AC PoE power module to provide power for PDs (such as IP phones, WLAN APs, and cameras) connected to FE interfaces of the router.	10	Four FXS interfaces NOTE The FXS interfaces can be connected to analog telephones using standard telephone cables.
11	One FXO interface NOTE The FXO interface can be connected to a public switched telephone network (PSTN) using a standard telephone cable.	12	Three Wi-Fi antenna interfaces
13	Product model silkscreen	14	Ground point NOTE Reliably ground the router by connecting a ground cable to the ground point to protect the router against lightning and interference.

AR207VW

Figure 4-39 shows the appearance of the AR207VW router.

Figure 4-39 AR207VW appearance

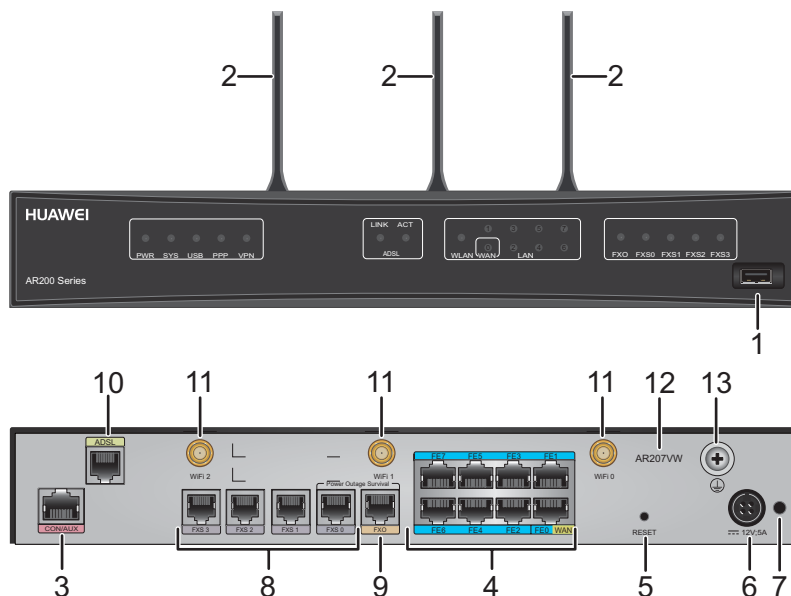

1	USB interface	2	Wi-Fi antenna
---	---------------	---	---------------

3	<p>CON/AUX interface</p> <p>NOTE</p> <p>The AR207VW does not support AUX login.</p>	4	<p>LAN interfaces: eight FE electrical interfaces</p> <p>NOTE</p> <ul style="list-style-type: none"> ● LAN interface FE0 can be used as a WAN interface. ● FE6 is a management interface and is used to upgrade the router.
5	<p>RESET button</p> <p>NOTICE</p> <p>This button is used to reset the router.</p> <ul style="list-style-type: none"> ● To restore the factory settings, hold down the button for at least 5 seconds. ● To reset the system, press the button. <p>Resetting the router will interrupt services. Exercise caution when deciding to press this button.</p>	6	<p>Power jack</p> <p>NOTE</p> <p>Use a 60 W power adapter to connect the router to a power source.</p>
7	<p>Jack for power cable locking strap</p> <p>NOTE</p> <p>Insert a power cable locking strap in this jack to secure the power cable.</p>	8	<p>Four FXS interfaces</p> <p>NOTE</p> <p>The FXS interfaces can be connected to analog telephones using standard telephone cables.</p>
9	<p>One FXO interface</p> <p>NOTE</p> <p>The FXO interface can be connected to a public switched telephone network (PSTN) using a standard telephone cable.</p>	10	<p>WAN interface: ADSL-A/M interface</p>
11	<p>Three Wi-Fi antenna interfaces</p>	12	<p>Product model silkscreen</p>
13	<p>Ground point</p> <p>NOTE</p> <p>Reliably ground the router by connecting a ground cable to the ground point to protect the router against lightning and interference.</p>	-	-

4.5 AR500 Series

AR503GW-LM7

Figure 4-40 shows the appearance of the AR503GW-LM7 router.

Figure 4-40 AR503GW-LM7 appearance



Figure 4-41 shows the panel of the AR503GW-LM7 router.

Figure 4-41 AR503GW-LM7 panel

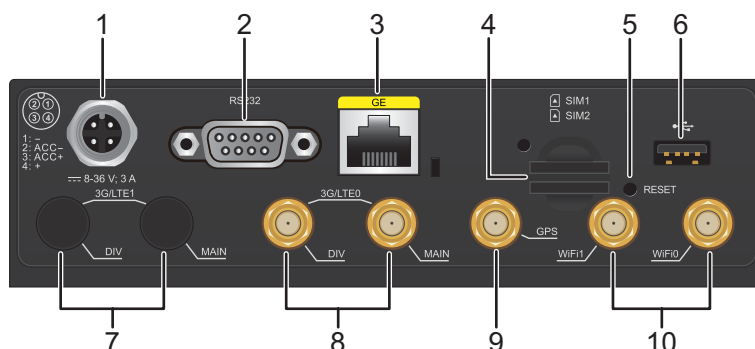

1	Power jack NOTE Use a DC power cable to connect the router to a power source.	2	RS232 interface (commissioning serial interface)
3	GE electrical interface	4	Two SIM card slots NOTE <ul style="list-style-type: none"> ● The SIM card slots support double-card single-standby. ● Industrial SIM cards are recommended for the AR routers. ● The mounting hole above the SIM card slots is used to fix the SIM card cover with a screw.

5	RESET button NOTICE This button is used to reset the router. <ul style="list-style-type: none"> To restore the factory settings, hold down the button for at least 5 seconds. To reset the system, press the button. Resetting the router will interrupt services. Exercise caution when deciding to press this button.	6	USB interface (host)
7	Two reserved 3G/LTE1 antenna interfaces	8	Two 3G/LTE0 antenna interfaces
9	GPS antenna interface	10	Two Wi-Fi antenna interfaces

AR509G-L-D-H

Figure 4-42 shows the appearance of the AR509G-L-D-H router.

Figure 4-42 AR509G-L-D-H appearance

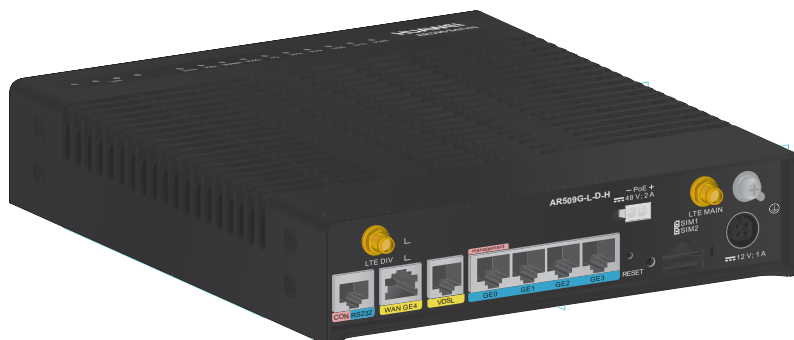
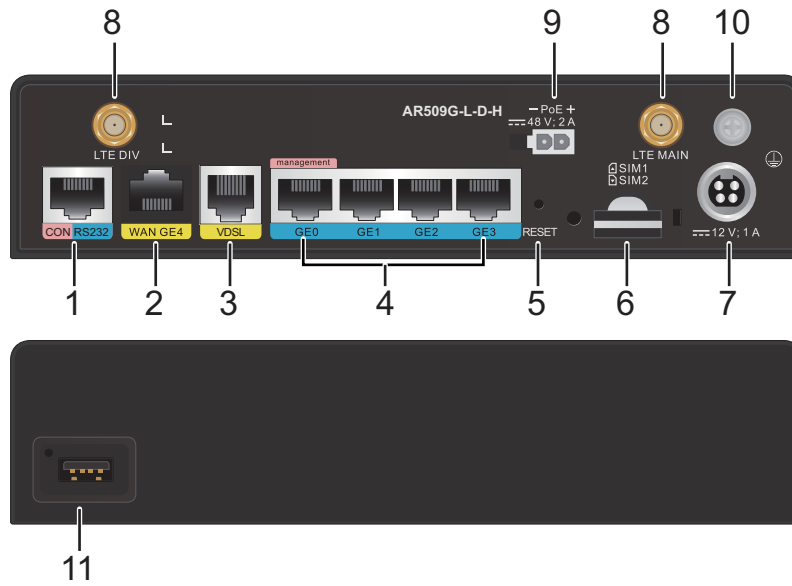

Figure 4-43 shows the panel of the AR509G-L-D-H router.

Figure 4-43 AR509G-L-D-H panel



1	CON/RS232 interface	2	WAN interface: GE electrical interface
3	VDSL interface	4	LAN interface: GE electrical interface
5	RESET button NOTICE This button is used to reset the router. <ul style="list-style-type: none"> To reset the system, press the button. To restore the factory settings, hold down the button for a period longer than 3 seconds and shorter than 10 seconds. To enable the RS232 function, hold down the button for 10 seconds or longer. Resetting the router will interrupt services. Exercise caution when deciding to press this button.	6	Two SIM card slots NOTE <ul style="list-style-type: none"> The SIM card slots support double-card single-standby. Industrial SIM cards are recommended for the AR routers. The mounting hole above the SIM card slots is used to fix the SIM card cover with a screw.
7	Power jack NOTE Use a DC power cable to connect the router to a power source.	8	LTE antenna interface
9	PoE power jack NOTE The PoE power jack connects to a 100 W AC PoE power module to provide power for PDs (such as IP phones, WLAN APs, and cameras) connected to GE interfaces of the router.	10	Ground point NOTE Reliably ground the router by connecting a ground cable to the ground point to protect the router against lightning and interference.
11	USB interface (host)	-	-

4.6 AR510 Series

AR511GW-LAV2M3

Figure 4-44 shows the appearance of the AR511GW-LAV2M3 router.

Figure 4-44 AR511GW-LAV2M3 appearance



Figure 4-45 shows the panel of the AR511GW-LAV2M3 router.

Figure 4-45 AR511GW-LAV2M3 panel

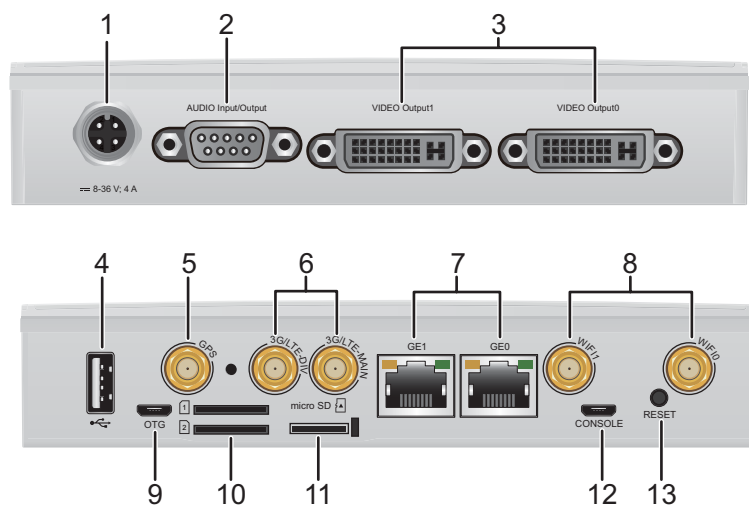

1	Power terminals NOTE They connect to an external power source through DC power cables.	2	Audio interface
3	Two video interfaces	4	USB interface (host)
5	GPS antenna interface	6	Two LTE antenna interfaces NOTE LTE is backward compatible with 3G and 2G standards.
7	Two GE electrical interfaces	8	Two Wi-Fi antenna interfaces
9	USB interface (OTG)	10	Two SIM card slots NOTE <ul style="list-style-type: none"> ● The SIM card slots support double-card single-standby. ● Industrial SIM cards are recommended. ● The mounting holes above the SIM card slots are used to fix the SIM card cover with screws.
11	Micro SD card slot	12	Console interface
13	RESET button NOTICE This button is used to reset the device. <ul style="list-style-type: none"> ● To restore the factory settings, hold the button for at least 5 seconds. ● To reset the system, press the button. Resetting the device interrupts services. Confirm your action before you press the RESET button.	-	-

AR511GW-LcM7

Figure 4-46 shows the appearance of the AR511GW-LcM7 router.

Figure 4-46 AR511GW-LcM7 appearance



Figure 4-47 shows the panel of the AR511GW-LcM7 router.

Figure 4-47 AR511GW-LcM7 panel

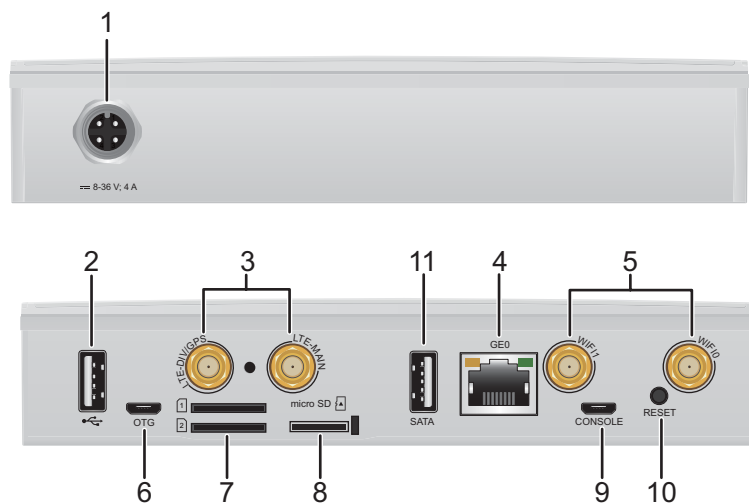

1	Power terminals NOTE They connect to an external power source through DC power cables.	2	USB interface (host)
---	---	---	----------------------

3	Two LTE antenna interfaces NOTE LTE is backward compatible with 3G and 2G standards.	4	One GE electrical interface
5	Two Wi-Fi antenna interfaces	6	USB interface (OTG)
7	Two SIM card slots NOTE <ul style="list-style-type: none"> ● The SIM card slots support double-card single-standby. ● Industrial SIM cards are recommended. ● The mounting holes above the SIM card slots are used to fix the SIM card cover with screws. 	8	Micro SD card slot
9	Console interface	10	RESET button NOTICE This button is used to reset the device. <ul style="list-style-type: none"> ● To restore the factory settings, hold the button for at least 5 seconds. ● To reset the system, press the button. Resetting the device interrupts services. Confirm your action before you press the RESET button.
11	SATA interface NOTICE It is a reserved interface and cannot connect to an external SATA hard disk now.	-	-

AR511GW-LM7

Figure 4-48 shows the appearance of the AR511GW-LM7 router.

Figure 4-48 AR511GW-LM7 appearance



Figure 4-49 shows the panel of the AR511GW-LM7 router.

Figure 4-49 AR511GW-LM7 panel

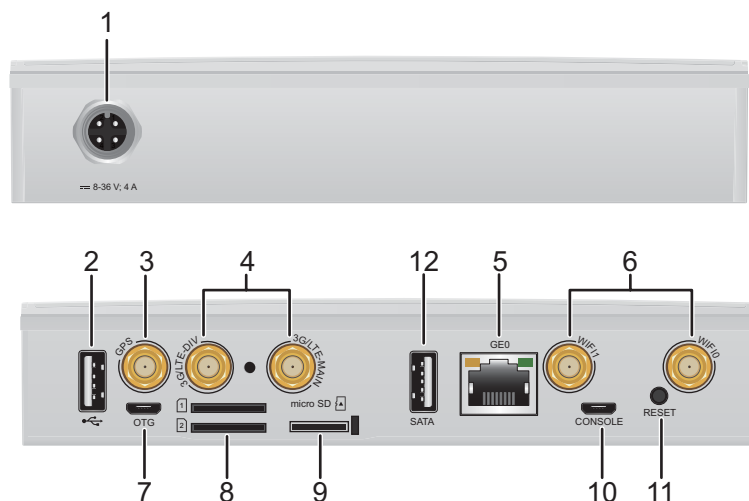

1	Power terminals NOTE They connect to an external power source through DC power cables.	2	USB interface (host)
---	---	---	----------------------

3	GPS antenna interface	4	Two LTE antenna interfaces NOTE LTE is backward compatible with 3G and 2G standards.
5	One GE electrical interface	6	Two Wi-Fi antenna interfaces
7	USB interface (OTG)	8	Two SIM card slots NOTE <ul style="list-style-type: none"> ● The SIM card slots support double-card single-standby. ● Industrial SIM cards are recommended. ● The mounting holes above the SIM card slots are used to fix the SIM card cover with screws.
9	Micro SD card slot	10	Console interface
11	RESET button NOTICE This button is used to reset the device. <ul style="list-style-type: none"> ● To restore the factory settings, hold the button for at least 5 seconds. ● To reset the system, press the button. Resetting the device interrupts services. Confirm your action before you press the RESET button.	12	SATA interface NOTICE This interface can connect to an external mSATA hard disk, which is not hot swappable.

AR511GW-L-B3

Figure 4-50 shows the appearance of the AR511GW-L-B3 router.

Figure 4-50 AR511GW-L-B3 appearance



Figure 4-51 shows the panel of the AR511GW-L-B3 router.

Figure 4-51 AR511GW-L-B3 panel

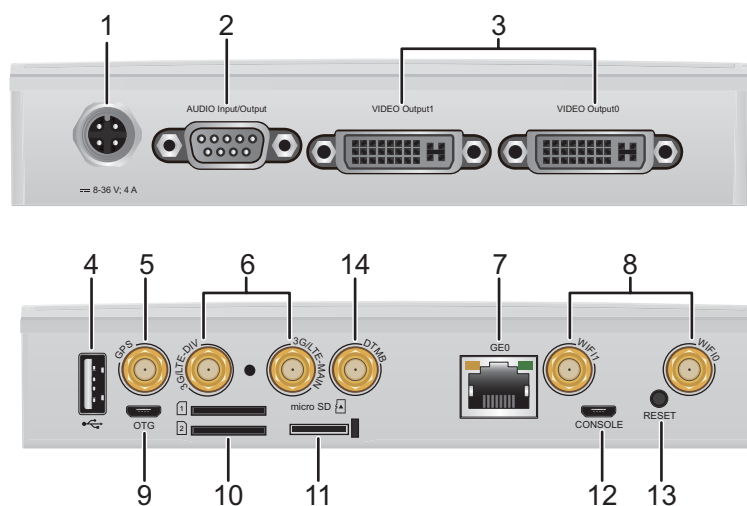

1	Power terminals NOTE They connect to an external power source through DC power cables.	2	Audio interface
3	Two video interfaces	4	USB interface (host)

5	GPS antenna interface	6	Two LTE antenna interfaces NOTE LTE is backward compatible with 3G and 2G standards.
7	One GE electrical interface	8	Two Wi-Fi antenna interfaces
9	USB interface (OTG)	10	Two SIM card slots NOTE <ul style="list-style-type: none"> ● The SIM card slots support double-card single-standby. ● Industrial SIM cards are recommended. ● The mounting holes above the SIM card slots are used to fix the SIM card cover with screws.
11	Micro SD card slot	12	Console interface
13	RESET button NOTICE This button is used to reset the device. <ul style="list-style-type: none"> ● To restore the factory settings, hold the button for at least 5 seconds. ● To reset the system, press the button. Resetting the device interrupts services. Confirm your action before you press the RESET button.	14	DTMB interface

AR513W-V3M8

Figure 4-52 shows the appearance of the AR513W-V3M8 router.

Figure 4-52 AR513W-V3M8 appearance



Figure 4-53 shows the panel of the AR513W-V3M8 router.

Figure 4-53 AR513W-V3M8 panel

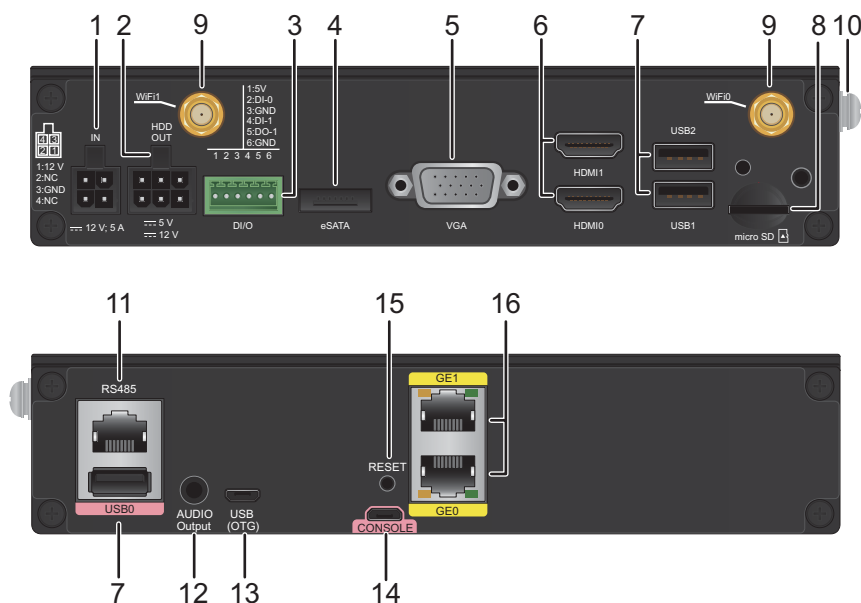

1	Power terminals NOTE They connect to an external power source through DC power cables.	2	SATA hard disk power jack
3	DI/O interface NOTE Connect cables according to the signal flags above the interface.	4	eSATA interface NOTICE This interface can have an SATA hard disk connected. The SATA hard disk and its data cable and power cable are hot swappable.
5	VGA interface	6	Two HDMI interfaces
7	Three USB interfaces (host)	8	Micro SD card slot NOTE The mounting holes above the SD card slots are used to fix the SD card cover with screws.
9	Two Wi-Fi antenna interfaces	10	Ground point NOTE The router must be reliably grounded using a Ground Cable to protect the router from lightning and interference.
11	RS485 interface NOTE The router does not support RS485 serial interface functions. This interface is reserved for future use.	12	Audio interface (output)
13	USB interface (OTG)	14	Console interface
15	RESET button NOTICE This button is used to reset the device. <ul style="list-style-type: none"> ● To restore the factory settings, hold the button for at least 5 seconds. ● To reset the system, press the button. Resetting the device interrupts services. Confirm your action before you press the RESET button.	16	Two GE electrical interfaces

4.7 AR1200 Series

AR1220 AC Model

Figure 4-54 shows the appearance of the AR1220 AC model.

Figure 4-54 AR1220 AC model appearance

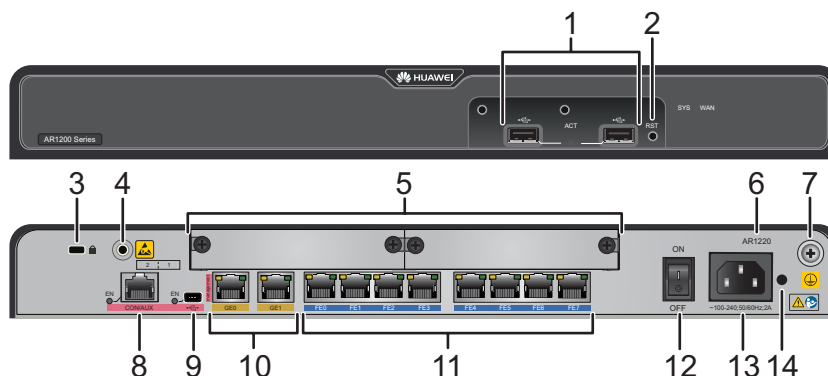

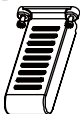
<p>1 Two USB interfaces (host)</p> <p>NOTE</p> <p>After a 3G USB modem is inserted, you are advised to install a plastic USB protection cap (optional) on it. There are two tapped holes above a USB interface. Insert screws in the tapped holes to fix the plastic protection cap. The following figure shows a plastic USB protection cap.</p> 	<p>2 RST button</p> <p>NOTICE</p> <ul style="list-style-type: none"> ● This button is used to reset the router. ● Resetting the router will interrupt services. Exercise caution when deciding to press this button.
<p>3 Security lock</p>	<p>4 ESD Jack</p> <p>NOTE</p> <p>When maintaining the router, wear an ESD wrist strap and insert the other end of the ESD wrist strap in the ESD jack.</p>
<p>5 Two SIC slots</p>	<p>6 Product model silkscreen</p>
<p>7 Ground point</p> <p>NOTE</p> <p>Reliably ground the router by connecting a ground cable to the ground point to protect the router against lightning and interference.</p>	<p>8 CON/AUX interface</p> <p>NOTE</p> <p>The AR1220 AC model does not support AUX login.</p>
<p>9 Mini USB interface</p> <p>NOTE</p> <p>The Mini USB interface and console interface cannot be used at the same time.</p>	<p>10 Two GE electrical interfaces</p>
<p>11 Eight FE electrical interfaces</p>	<p>12 Power switch</p>

<p>13 AC power jack</p> <p>NOTE</p> <p>Use an AC power cable to connect the router to an external power source.</p>	<p>14 Jack for power cable locking strap</p> <p>NOTE</p> <p>Insert a power cable locking strap in this jack to secure the power cable.</p>
--	---

AR1220V

Figure 4-55 shows the appearance of the AR1220V router.

Figure 4-55 AR1220V appearance

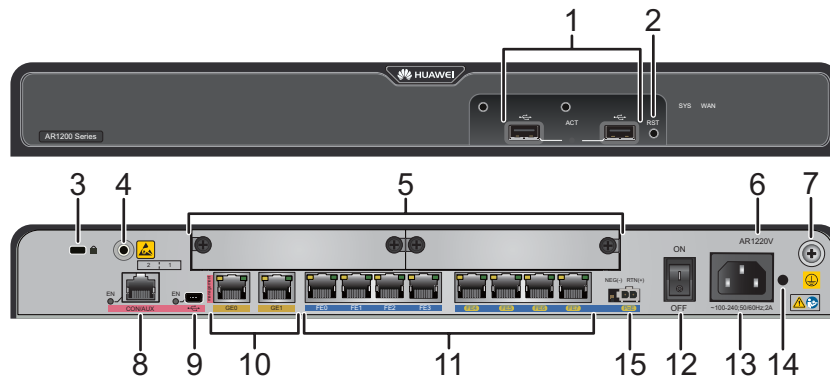

<p>1 Two USB interfaces (host)</p> <p>NOTE</p> <p>After a 3G USB modem is inserted, you are advised to install a plastic USB protection cap (optional) on it. There are two tapped holes above a USB interface. Insert screws in the tapped holes to fix the plastic protection cap. The following figure shows a plastic USB protection cap.</p> 	<p>2 RST button</p> <p>NOTICE</p> <ul style="list-style-type: none"> This button is used to reset the router. Resetting the router will interrupt services. Exercise caution when deciding to press this button.
<p>3 Security lock</p>	<p>4 ESD Jack</p> <p>NOTE</p> <p>When maintaining the router, wear an ESD wrist strap and insert the other end of the ESD wrist strap in the ESD jack.</p>
<p>5 Two SIC slots</p>	<p>6 Product model silkscreen</p>
<p>7 Ground point</p> <p>NOTE</p> <p>Reliably ground the router by connecting a ground cable to the ground point to protect the router against lightning and interference.</p>	<p>8 CON/AUX interface</p> <p>NOTE</p> <p>The AR1220V does not support AUX login.</p>

9	Mini USB interface NOTE The Mini USB interface and console interface cannot be used at the same time.	10	Two GE electrical interfaces
11	Eight FE electrical interfaces	12	Power switch
13	AC power jack NOTE Use an AC power cable to connect the router to an external power source.	14	Jack for power cable locking strap NOTE Insert a power cable locking strap in this jack to secure the power cable.
15	PoE power jack NOTE The PoE power jack connects to a 100 W AC PoE power module to provide power for PDs (such as IP phones, WLAN APs, and cameras) connected to FE interfaces of the router.	-	-

AR1220 DC Model

Figure 4-56 shows the appearance of the AR1220 DC model.

Figure 4-56 AR1220 DC model appearance

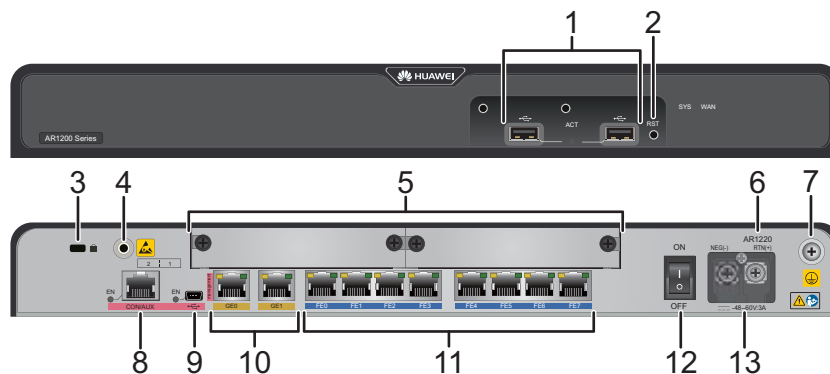

1	Two USB interfaces (host) NOTE After a 3G USB modem is inserted, you are advised to install a plastic USB protection cap (optional) on it. There are two tapped holes above a USB interface. Insert screws in the tapped holes to fix the plastic protection cap. The following figure shows a plastic USB protection cap. 	2	RST button NOTICE <ul style="list-style-type: none"> This button is used to reset the router. Resetting the router will interrupt services. Exercise caution when deciding to press this button.
---	--	---	---

3	Security lock	4	ESD Jack NOTE When maintaining the router, wear an ESD wrist strap and insert the other end of the ESD wrist strap in the ESD jack.
5	Two SIC slots	6	Product model silkscreen
7	Ground point NOTE Reliably ground the router by connecting a ground cable to the ground point to protect the router against lightning and interference.	8	CON/AUX interface NOTE The AR1220 DC model does not support AUX login.
9	Mini USB interface NOTE The Mini USB interface and console interface cannot be used at the same time.	10	Two GE electrical interfaces
11	Eight FE electrical interfaces	12	Power switch
13	DC power terminals NOTE Use DC power cables to connect the router to an external power source.	-	-

AR1220W

Figure 4-57 shows the appearance of the AR1220W router.

Figure 4-57 AR1220W appearance

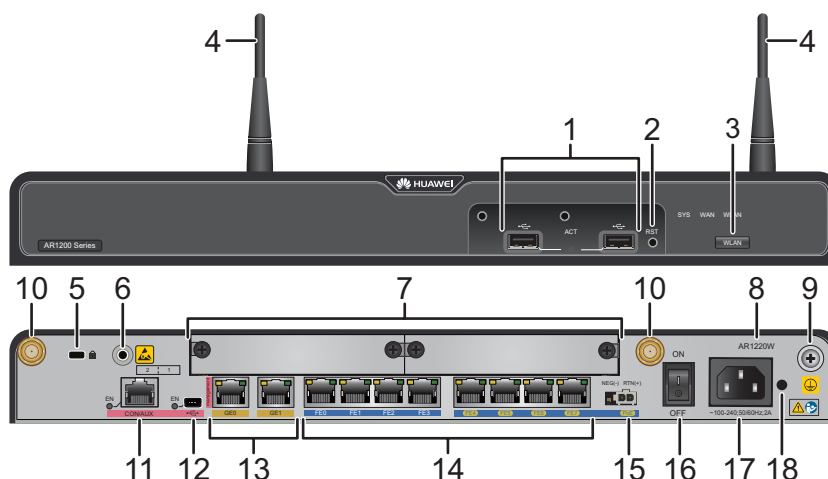



1	<p>Two USB interfaces (host)</p> <p>NOTE</p> <p>After a 3G USB modem is inserted, you are advised to install a plastic USB protection cap (optional) on it. There are two tapped holes above a USB interface. Insert screws in the tapped holes to fix the plastic protection cap. The following figure shows a plastic USB protection cap.</p> 	2	<p>RST button</p> <p>NOTICE</p> <ul style="list-style-type: none"> ● This button is used to reset the router. ● Resetting the router will interrupt services. Exercise caution when deciding to press this button.
3	<p>WLAN button</p> <p>NOTE</p> <p>Press this button to enable or disable the WLAN function.</p>	4	<p>Wi-Fi antennas</p>
5	<p>Security lock</p>	6	<p>ESD Jack</p> <p>NOTE</p> <p>When maintaining the router, wear an ESD wrist strap and insert the other end of the ESD wrist strap in the ESD jack.</p>
7	<p>Two SIC slots</p>	8	<p>Product model silkscreen</p>
9	<p>Ground point</p> <p>NOTE</p> <p>Reliably ground the router by connecting a ground cable to the ground point to protect the router against lightning and interference.</p>	10	<p>Wi-Fi antenna interfaces</p>
11	<p>CON/AUX interface</p> <p>NOTE</p> <p>The AR1220W does not support AUX login.</p>	12	<p>Mini USB interface</p> <p>NOTE</p> <p>The Mini USB interface and console interface cannot be used at the same time.</p>
13	<p>Two GE electrical interfaces</p>	14	<p>Eight FE electrical interfaces</p>
15	<p>PoE power jack</p> <p>NOTE</p> <p>The PoE power jack connects to a 100 W AC PoE power module to provide power for PDs (such as IP phones, WLAN APs, and cameras) connected to FE interfaces of the router.</p>	16	<p>Power switch</p>
17	<p>AC power jack</p> <p>NOTE</p> <p>Use an AC power cable to connect the router to an external power source.</p>	18	<p>Jack for power cable locking strap</p> <p>NOTE</p> <p>Insert a power cable locking strap in this jack to secure the power cable.</p>

AR1220VW

Figure 4-58 shows the appearance of the AR1220VW router.

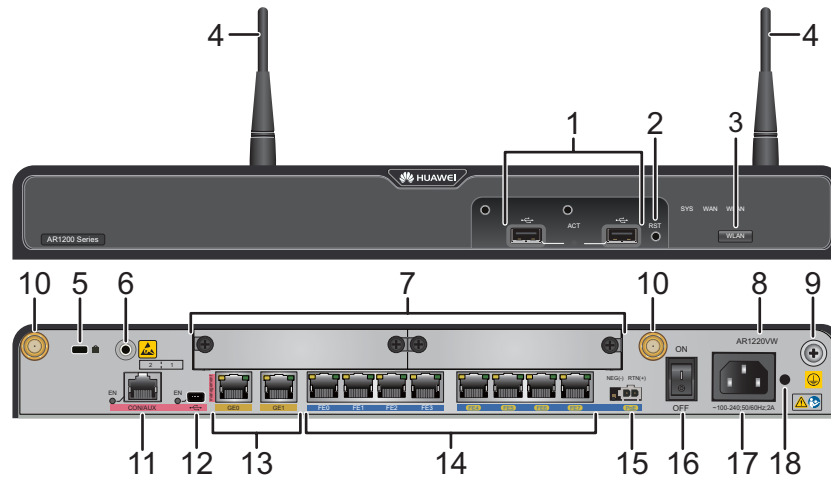
Figure 4-58 AR1220VW appearance



1	<p>Two USB interfaces (host)</p> <p>NOTE</p> <p>After a 3G USB modem is inserted, you are advised to install a plastic USB protection cap (optional) on it. There are two tapped holes above a USB interface. Insert screws in the tapped holes to fix the plastic protection cap. The following figure shows a plastic USB protection cap.</p> 	2	<p>RST button</p> <p>NOTICE</p> <ul style="list-style-type: none"> ● This button is used to reset the router. ● Resetting the router will interrupt services. Exercise caution when deciding to press this button.
3	<p>WLAN button</p> <p>NOTE</p> <p>Press this button to enable or disable the WLAN function.</p>	4	<p>Wi-Fi antennas</p>
5	<p>Security lock</p>	6	<p>ESD Jack</p> <p>NOTE</p> <p>When maintaining the router, wear an ESD wrist strap and insert the other end of the ESD wrist strap in the ESD jack.</p>
7	<p>Two SIC slots</p>	8	<p>Product model silkscreen</p>

9	Ground point NOTE Reliably ground the router by connecting a ground cable to the ground point to protect the router against lightning and interference.	10	Wi-Fi antenna interfaces
11	CON/AUX interface NOTE The AR1220VW does not support AUX login.	12	Mini USB interface NOTE The Mini USB interface and console interface cannot be used at the same time.
13	Two GE electrical interfaces	14	Eight FE electrical interfaces
15	PoE power jack NOTE The PoE power jack connects to a 100 W AC PoE power module to provide power for PDs (such as IP phones, WLAN APs, and cameras) connected to FE interfaces of the router.	16	Power switch
17	AC power jack NOTE Use an AC power cable to connect the router to an external power source.	18	Jack for power cable locking strap NOTE Insert a power cable locking strap in this jack to secure the power cable.

AR1220L

Figure 4-59 shows the appearance of the AR1220L router.

Figure 4-59 AR1220L appearance

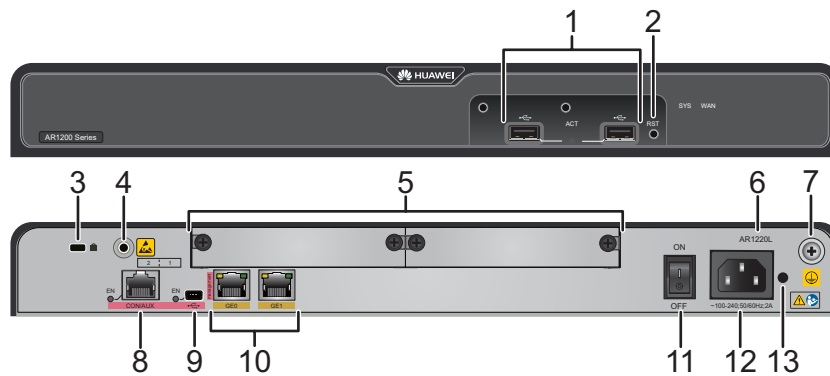



1	<p>Two USB interfaces (host)</p> <p>NOTE</p> <p>After a 3G USB modem is inserted, you are advised to install a plastic USB protection cap (optional) on it. There are two tapped holes above a USB interface. Insert screws in the tapped holes to fix the plastic protection cap. The following figure shows a plastic USB protection cap.</p> 	2	<p>RST button</p> <p>NOTICE</p> <ul style="list-style-type: none"> ● This button is used to reset the router. ● Resetting the router will interrupt services. Exercise caution when deciding to press this button.
3	<p>Security lock</p>	4	<p>ESD Jack</p> <p>NOTE</p> <p>When maintaining the router, wear an ESD wrist strap and insert the other end of the ESD wrist strap in the ESD jack.</p>
5	<p>Two SIC slots</p>	6	<p>Product model silkscreen</p>
7	<p>Ground point</p> <p>NOTE</p> <p>Reliably ground the router by connecting a ground cable to the ground point to protect the router against lightning and interference.</p>	8	<p>CON/AUX interface</p> <p>NOTE</p> <p>The AR1220L does not support AUX login.</p>
9	<p>Mini USB interface</p> <p>NOTE</p> <p>The Mini USB interface and console interface cannot be used at the same time.</p>	10	<p>Two GE electrical interfaces</p>
11	<p>Power switch</p>	12	<p>AC power jack</p> <p>NOTE</p> <p>Use an AC power cable to connect the router to an external power source.</p>
13	<p>Jack for power cable locking strap</p> <p>NOTE</p> <p>Insert a power cable locking strap in this jack to secure the power cable.</p>	-	-

AR1220F

Figure 4-60 shows the appearance of the AR1220F router.

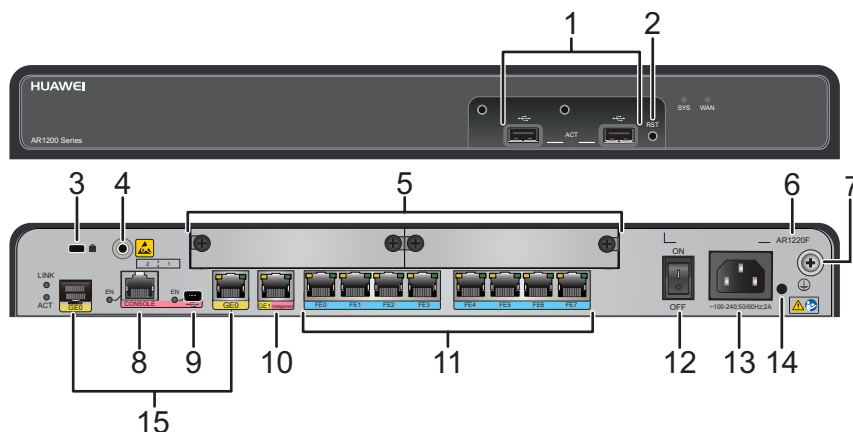
Figure 4-60 AR1220F appearance



1	<p>Two USB interfaces (host)</p> <p>NOTE</p> <p>After a 3G USB modem is inserted, you are advised to install a plastic USB protection cap (optional) on it. There are two tapped holes above a USB interface. Insert screws in the tapped holes to fix the plastic protection cap. The following figure shows a plastic USB protection cap.</p> 	2	<p>RST button</p> <p>NOTICE</p> <ul style="list-style-type: none"> ● This button is used to reset the router. ● Resetting the router will interrupt services. Exercise caution when deciding to press this button.
3	Security lock	4	<p>ESD Jack</p> <p>NOTE</p> <p>When maintaining the router, wear an ESD wrist strap and insert the other end of the ESD wrist strap in the ESD jack.</p>
5	Two SIC slots	6	Product model silkscreen
7	<p>Ground point</p> <p>NOTE</p> <p>Reliably ground the router by connecting a ground cable to the ground point to protect the router against lightning and interference.</p>	8	Console interface
9	<p>Mini USB interface</p> <p>NOTE</p> <p>The Mini USB interface and console interface cannot be used at the same time.</p>	10	One GE electrical interface
11	Eight FE electrical interfaces	12	Power switch

13	AC power jack NOTE Use an AC power cable to connect the router to an external power source.	14	Jack for power cable locking strap NOTE Insert a power cable locking strap in this jack to secure the power cable.
15	GE combo interface	-	-

AR1220E

Figure 4-61 shows the appearance of the AR1220E router.

Figure 4-61 AR1220E appearance

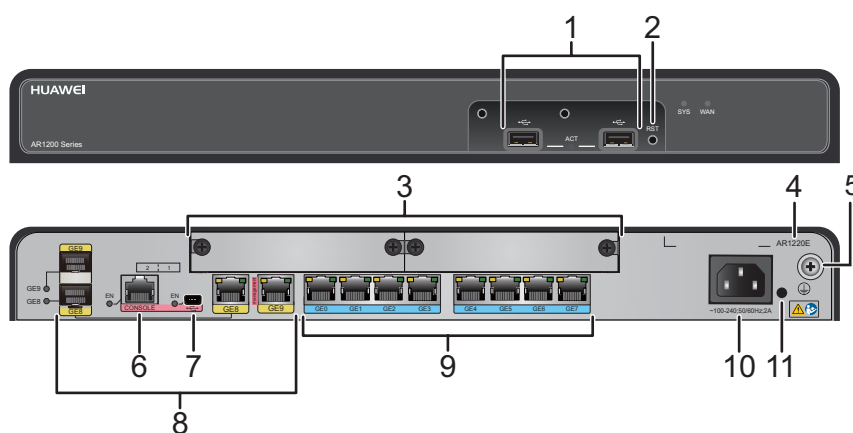

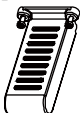
1	Two USB interfaces (host) NOTE After a 3G USB modem is inserted, you are advised to install a plastic USB protection cap (optional) on it. There are two tapped holes above a USB interface. Insert screws in the tapped holes to fix the plastic protection cap. The following figure shows a plastic USB protection cap. 	2	RST button NOTICE <ul style="list-style-type: none"> This button is used to reset the router. Resetting the router will interrupt services. Exercise caution when deciding to press this button.
3	Two SIC slots	4	Product model silkscreen
5	Ground point NOTE Reliably ground the router by connecting a ground cable to the ground point to protect the router against lightning and interference.	6	Console interface

7	Mini USB interface NOTE The Mini USB interface and console interface cannot be used at the same time.	8	Two GE combo interfaces
9	Eight GE electrical interfaces	10	AC power jack NOTE Use an AC power cable to connect the router to an external power source.
11	Jack for power cable locking strap NOTE Insert a power cable locking strap in this jack to secure the power cable.	-	-

AR1220EV

Figure 4-62 shows the appearance of the AR1220EV router.

Figure 4-62 AR1220EV appearance

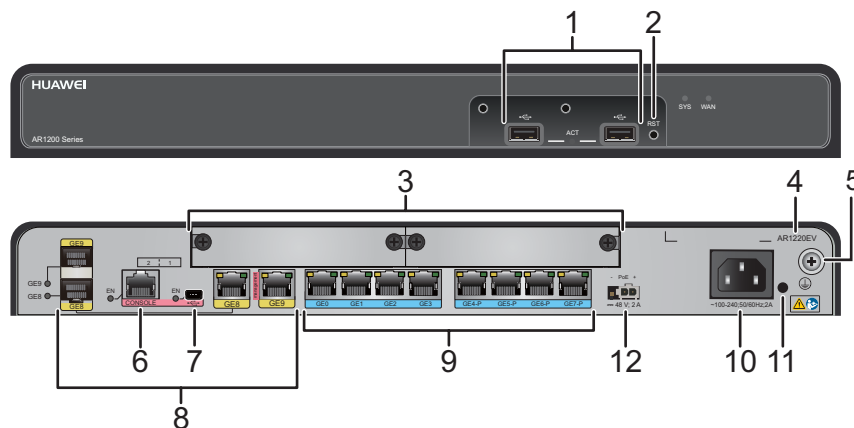

1	Two USB interfaces (host) NOTE After a 3G USB modem is inserted, you are advised to install a plastic USB protection cap (optional) on it. There are two tapped holes above a USB interface. Insert screws in the tapped holes to fix the plastic protection cap. The following figure shows a plastic USB protection cap. 	2	RST button NOTICE <ul style="list-style-type: none"> This button is used to reset the router. Resetting the router will interrupt services. Exercise caution when deciding to press this button.
3	Two SIC slots	4	Product model silkscreen

5	Ground point NOTE Reliably ground the router by connecting a ground cable to the ground point to protect the router against lightning and interference.	6	Console interface
7	Mini USB interface NOTE The Mini USB interface and console interface cannot be used at the same time.	8	Two GE combo interfaces
9	Eight GE electrical interfaces NOTE Electrical interfaces GE4 to GE7 support the PoE function.	10	AC power jack NOTE Use an AC power cable to connect the router to an external power source.
11	Jack for power cable locking strap NOTE Insert a power cable locking strap in this jack to secure the power cable.	12	PoE power jack NOTE The PoE power jack connects to a 100 W AC PoE Power Module to provide power for PDs (such as IP phones, WLAN APs, and cameras) connected to GE interfaces of the router.

AR1220EVW

Figure 4-63 shows the appearance of the AR1220EVW router.

Figure 4-63 AR1220EVW appearance

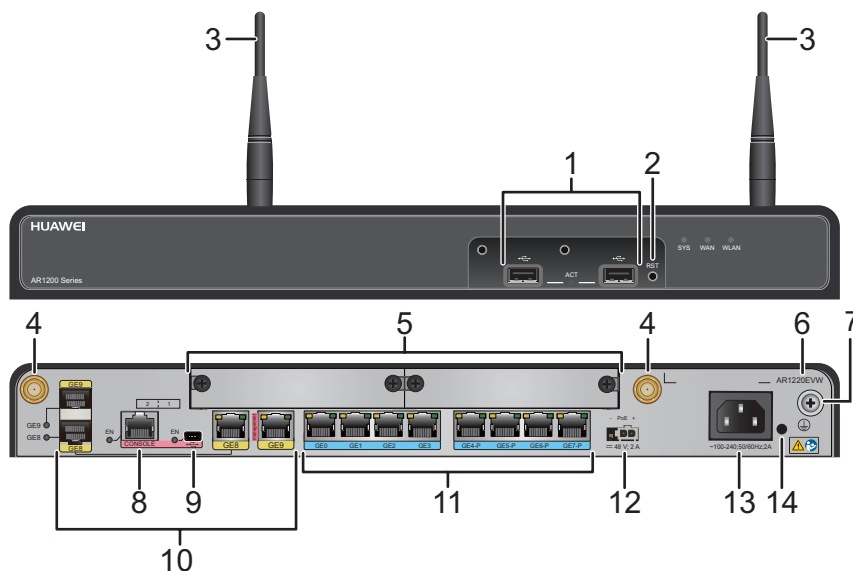

1	Two USB interfaces (host) NOTE After a 3G USB modem is inserted, you are advised to install a plastic USB protection cap (optional) on it. There are two tapped holes above a USB interface. Insert screws in the tapped holes to fix the plastic protection cap. The following figure shows a plastic USB protection cap. 	2	RST button NOTICE <ul style="list-style-type: none"> ● This button is used to reset the router. ● Resetting the router will interrupt services. Exercise caution when deciding to press this button.
3	Wi-Fi antennas	4	Wi-Fi antenna interfaces
5	Two SIC slots	6	Product model silkscreen
7	Ground point NOTE Reliably ground the router by connecting a ground cable to the ground point to protect the router against lightning and interference.	8	Console interface
9	Mini USB interface NOTE The Mini USB interface and console interface cannot be used at the same time.	10	Two GE combo interfaces
11	Eight GE electrical interfaces NOTE Electrical interfaces GE4 to GE7 support the PoE function.	12	PoE power jack NOTE The PoE power jack connects to a 100 W AC PoE Power Module to provide power for PDs (such as IP phones, WLAN APs, and cameras) connected to GE interfaces of the router.
13	AC power jack NOTE Use an AC power cable to connect the router to an external power source.	14	Jack for power cable locking strap NOTE Insert a power cable locking strap in this jack to secure the power cable.

Slot Distribution

Figure 4-64 shows the slot distribution of the AR1200 series routers.

NOTE

- Two SIC slots can be combined into one WSIC slot by removing the guide rail.
- After two slots are combined into one, the slot ID is the larger one between the original two slots.

Figure 4-64 Slot distribution of the AR1200 series routers

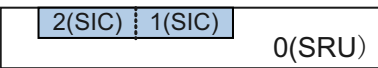
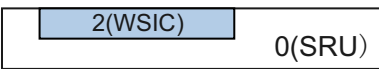
Device Model		Slot Distribution	Slot Combination
AR1200	Front view	NA	NA
	Rear view		Two SIC slots are combined into one WSIC slot 

As shown in **Figure 4-64**, slot 1 and slot 2 of an AR1200 series router can be combined into new slot 2.

4.8 AR2200 Series

AR2220 AC Model

Figure 4-65 shows the appearance of the AR2220 AC model.

Figure 4-65 AR2220 AC model appearance

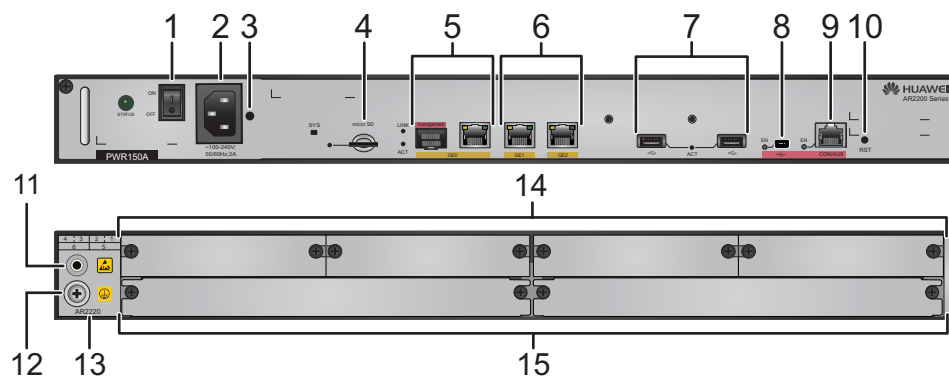

1	Power switch	2	AC power jack NOTE Use an AC power cable to connect the router to an external power source.
3	Jack for power cable locking strap NOTICE Insert a power cable locking strap in this jack to secure the power cable.	4	Micro SD card interface
5	GE combo interface	6	Two GE electrical interfaces

7	<p>Two USB interfaces (host)</p> <p>NOTE</p> <p>After a 3G USB modem is inserted, you are advised to install a plastic USB protection cap (optional) on it. There are two tapped holes above a USB interface. Insert screws in the tapped holes to fix the plastic protection cap. The following figure shows a plastic USB protection cap.</p> 	8	<p>Mini USB interface</p> <p>NOTE</p> <p>The Mini USB interface and console interface cannot be used at the same time.</p>
9	<p>CON/AUX interface</p> <p>NOTE</p> <p>The AR2220 AC model does not support AUX login.</p>	10	<p>RST button</p> <p>NOTICE</p> <ul style="list-style-type: none"> ● This button is used to reset the router. ● Resetting the router will interrupt services. Exercise caution when deciding to press this button.
11	<p>ESD Jack</p> <p>NOTE</p> <p>When maintaining the router, wear an ESD wrist strap and insert the other end of the ESD wrist strap in the ESD jack.</p>	12	<p>Ground point</p> <p>NOTE</p> <p>Reliably ground the router by connecting a ground cable to the ground point to protect the router against lightning and interference.</p>
13	Product model silkscreen	14	Four SIC slots
15	Two WSIC slots	-	-

AR2240

Figure 4-66 shows the appearance of the AR2240 router.

Figure 4-66 AR2240 appearance

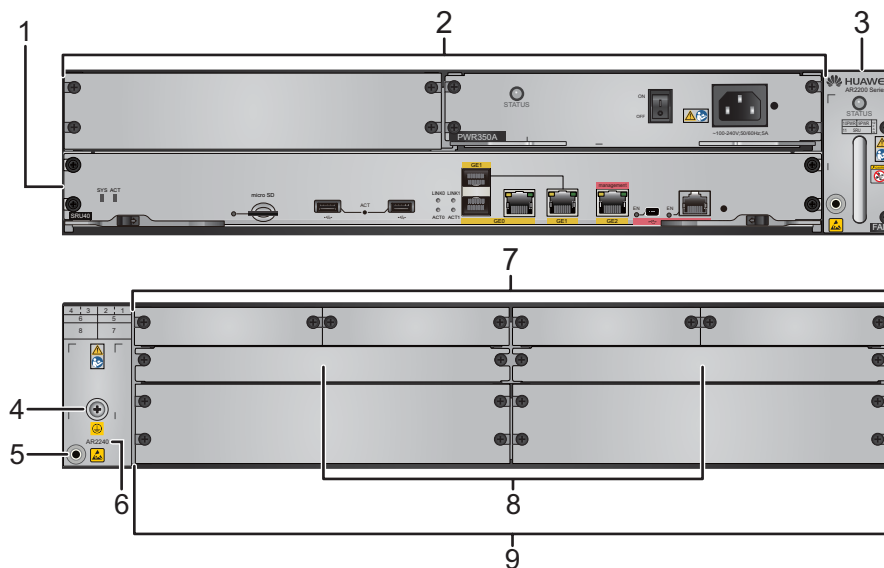



1	SRU slot	2	Two power module slots Applicable power modules: <ul style="list-style-type: none"> ● 350 W AC Power Module ● 350 W DC Power Module NOTE AC and DC power modules cannot be used together in a router.
3	Fan module slots	4	Ground point NOTE Reliably ground the router by connecting a ground cable to the ground point to protect the router against lightning and interference.
5	ESD Jack NOTE When maintaining the router, wear an ESD wrist strap and insert the other end of the ESD wrist strap in the ESD jack.	6	Product model silkscreen
7	Four WSIC slots	8	Two WSIC slots
9	Two XSIC slots	-	-

AR2220 DC Model

Figure 4-67 shows the appearance of the AR2220 DC model.

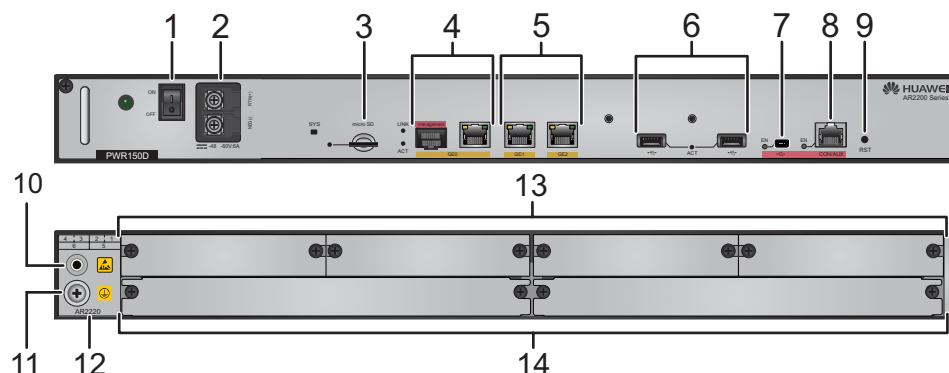
Figure 4-67 AR2220 DC model appearance



1	Power switch	2	DC power terminals NOTE Use DC power cables to connect the router to an external power source.
3	Micro SD card interface	4	GE combo interface
5	Two GE electrical interfaces	6	Two USB interfaces (host) NOTE After a 3G USB modem is inserted, you are advised to install a plastic USB protection cap (optional) on it. There are two tapped holes above a USB interface. Insert screws in the tapped holes to fix the plastic protection cap. The following figure shows a plastic USB protection cap. 
7	Mini USB interface NOTE The Mini USB interface and console interface cannot be used at the same time.	8	CON/AUX interface NOTE The AR2220 DC model does not support AUX login.
9	RST button NOTICE <ul style="list-style-type: none"> ● This button is used to reset the router. ● Resetting the router will interrupt services. Exercise caution when deciding to press this button. 	10	ESD Jack NOTE When maintaining the router, wear an ESD wrist strap and insert the other end of the ESD wrist strap in the ESD jack.
11	Ground point NOTE Reliably ground the router by connecting a ground cable to the ground point to protect the router against lightning and interference.	12	Product model silkscreen

13	Four SIC slots	14	Two WSIC slots
----	----------------	----	----------------

AR2201-48FE

Figure 4-68 shows the appearance of the AR2201-48FE router.

Figure 4-68 AR2201-48FE appearance

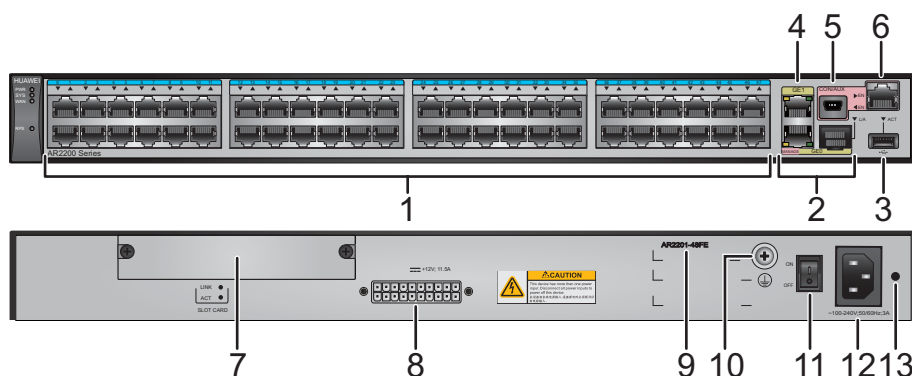

1	48 FE electrical interfaces	2	GE combo interface
3	One USB interface (host)	4	One GE electrical interface
5	Mini USB interface NOTE The Mini USB interface and console interface cannot be used at the same time.	6	CON/AUX interface NOTE The AR2201-48FE does not support AUX login.
7	Extended card slot NOTE The slot is reserved, and no extended card is supported currently.	8	RPS power socket NOTE Use an RPS150 power and communication cable to connect the router to a 150 W RPS power supply system.
9	Product model silkscreen	10	Ground point NOTE Reliably ground the router by connecting a ground cable to the ground point to protect the router against lightning and interference.
11	Power switch	12	AC power jack NOTE Use an AC power cable to connect the router to an external power source.
13	Jack for power cable locking strap NOTICE Insert a power cable locking strap in this jack to secure the power cable.	-	-

AR2202-48FE

Figure 4-69 shows the appearance of the AR2202-48FE router.

Figure 4-69 AR2202-48FE appearance

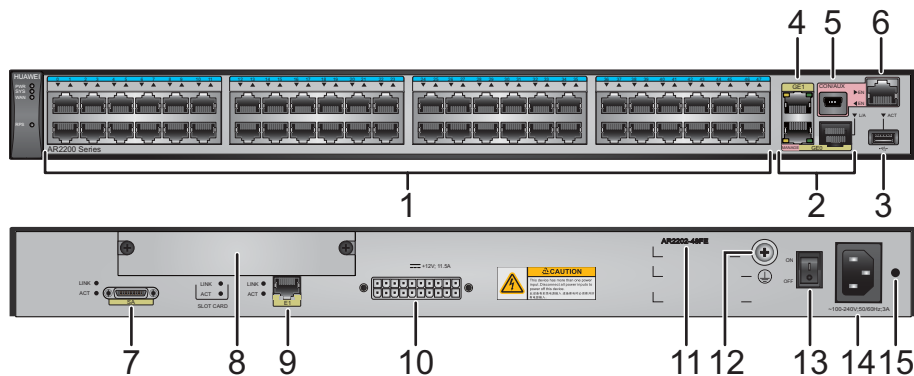

1	48 FE electrical interfaces	2	GE combo interface
3	One USB interface (host)	4	One GE electrical interface
5	Mini USB interface NOTE The Mini USB interface and console interface cannot be used at the same time.	6	CON/AUX interface NOTE The AR2202-48FE does not support AUX login.
7	Synchronous/Asynchronous serial (SA) interface NOTE The SA interface can be connected to a wide area network using an SA cable.	8	Extended card slot NOTE The slot is reserved, and no extended card is supported currently.
9	E1 Interface NOTE The E1 interface can be connected to a wide area network using an E1/T1 cable.	10	RPS power socket NOTE Use an RPS150 power and communication cable to connect the router to a 150 W RPS power supply system.
11	Product model silkscreen	12	Ground point NOTE Reliably ground the router by connecting a ground cable to the ground point to protect the router against lightning and interference.
13	Power switch	14	AC power jack NOTE Use an AC power cable to connect the router to an external power source.

15	Jack for power cable locking strap NOTICE Insert a power cable locking strap in this jack to secure the power cable.	-	-
----	---	---	---

AR2204

Figure 4-70 shows the appearance of the AR2204 router.

Figure 4-70 AR2204 appearance

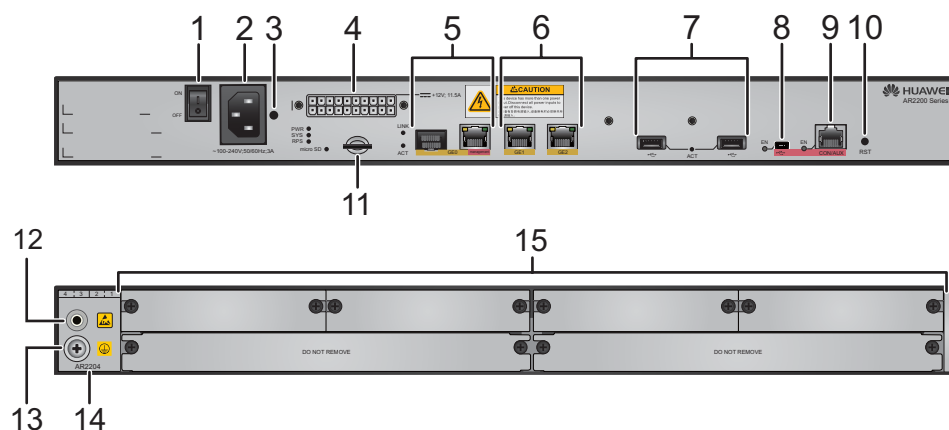

1	Power switch	2	AC power jack NOTE Use an AC power cable to connect the router to an external power source.
3	Jack for power cable locking strap NOTICE Insert a power cable locking strap in this jack to secure the power cable.	4	RPS power socket NOTE Use an RPS150 power and communication cable to connect the router to a 150 W RPS power supply system.
5	GE combo interface	6	Two GE electrical interfaces

7	<p>Two USB interfaces (host)</p> <p>NOTE</p> <p>After a 3G USB modem is inserted, you are advised to install a plastic USB protection cap (optional) on it. There are two tapped holes above a USB interface. Insert screws in the tapped holes to fix the plastic protection cap. The following figure shows a plastic USB protection cap.</p> 	8	<p>Mini USB interface</p> <p>NOTE</p> <p>The Mini USB interface and console interface cannot be used at the same time.</p>
9	<p>CON/AUX interface</p> <p>NOTE</p> <p>The AR2204 does not support AUX login.</p>	10	<p>RST button</p> <p>NOTICE</p> <ul style="list-style-type: none"> ● This button is used to reset the router. ● Resetting the router will interrupt services. Exercise caution when deciding to press this button.
11	<p>Micro SD card interface</p>	12	<p>ESD Jack</p> <p>NOTE</p> <p>When maintaining the router, wear an ESD wrist strap and insert the other end of the ESD wrist strap in the ESD jack.</p>
13	<p>Ground point</p> <p>NOTE</p> <p>Reliably ground the router by connecting a ground cable to the ground point to protect the router against lightning and interference.</p>	14	<p>Product model silkscreen</p>
15	<p>Four SIC slots</p>	-	-

AR2220E

Figure 4-71 shows the appearance of the AR2220E router.

Figure 4-71 AR2220E appearance

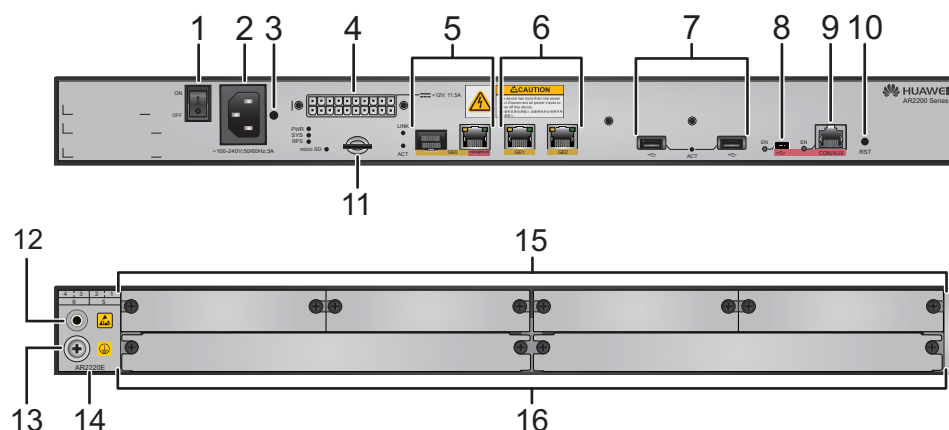

1	Power switch	2	AC power jack NOTE Use an AC power cable to connect the router to an external power source.
3	Jack for power cable locking strap NOTICE Insert a power cable locking strap in this jack to secure the power cable.	4	RPS power socket NOTE Use an RPS150 power and communication cable to connect the router to a 150 W RPS power supply system.
5	GE combo interface	6	Two GE electrical interfaces
7	Two USB interfaces (host) NOTE After a 3G USB modem is inserted, you are advised to install a plastic USB protection cap (optional) on it. There are two tapped holes above a USB interface. Insert screws in the tapped holes to fix the plastic protection cap. The following figure shows a plastic USB protection cap. 	8	Mini USB interface NOTE The Mini USB interface and console interface cannot be used at the same time.
9	CON/AUX interface NOTE The AR2220E does not support AUX login.	10	RST button NOTICE <ul style="list-style-type: none"> ● This button is used to reset the router. ● Resetting the router will interrupt services. Exercise caution when deciding to press this button.

11	Micro SD card interface	12	ESD Jack NOTE When maintaining the router, wear an ESD wrist strap and insert the other end of the ESD wrist strap in the ESD jack.
13	Ground point NOTE Reliably ground the router by connecting a ground cable to the ground point to protect the router against lightning and interference.	14	Product model silkscreen
15	Four SIC slots	16	Two WSIC slots

Slot Distribution

Figure 4-72 and Figure 4-73 show slot distribution of AR2200 series routers.

NOTE

- Two SIC slots can be combined into one WSIC slot by removing the guide rail.
- The two SIC slots and the WSIC slot below them can be combined into one XSIC slot by removing the guide rail.
- After two slots are combined into one, the slot ID is the larger one between the original two slots.
- Since V200R002C00, a WSIC card can be inserted into an XSIC slot with a special component. The WSIC card is in the lower side of the slot and uses the XSIC slot ID as its own slot ID.
- The AR2201-48FE and AR2202-48FE have no SIC/WSIC/XSIC slots.

Figure 4-72 Slot distribution of the AR2204

Device Model		Slot Distribution	Slot Combination
AR2204	Front view	NA	NA
	Rear view		Two SIC slots are combined into one WSIC slot

Figure 4-73 Slot distribution of the AR2220, AR2220E and AR2240

Device Model		Slot Distribution	Slot Combination
AR2220 AR2220E	Front view	NA	NA
	Rear view		<p>Two SIC slots are combined into one WSIC slot</p> <p>Two WSIC slots are combined into one XSIC slot</p>
AR2240	Front view		NA
	Rear view		<p>Two SIC slots are combined into one WSIC slot</p> <p>Two WSIC slots are combined into one XSIC slot</p>

As shown in [Figure 4-72](#) and [Figure 4-73](#), slots of AR2200 series routers can be combined.

- AR2204:
 - Slot 1 and slot 2 are combined into new slot 2.
 - Slot 3 and slot 4 are combined into new slot 4.
- AR2220 and AR2220E:
 - Slot 1 and slot 2 are combined into new slot 2.
 - Slot 3 and slot 4 are combined into new slot 4.
 - New slot 2 and slot 5 are combined into new slot 5.
 - New slot 4 and slot 6 are combined into new slot 6.
- AR2240:
 - Slot 1 and slot 2 are combined into new slot 2.
 - Slot 3 and slot 4 are combined into new slot 4.

- New slot 2 and slot 5 are combined into new slot 5.
- New slot 4 and slot 6 are combined into new slot 6.

4.9 AR3200 Series

AR3260

Figure 4-74 shows the appearance of the AR3260 router.

Figure 4-74 AR3260 appearance

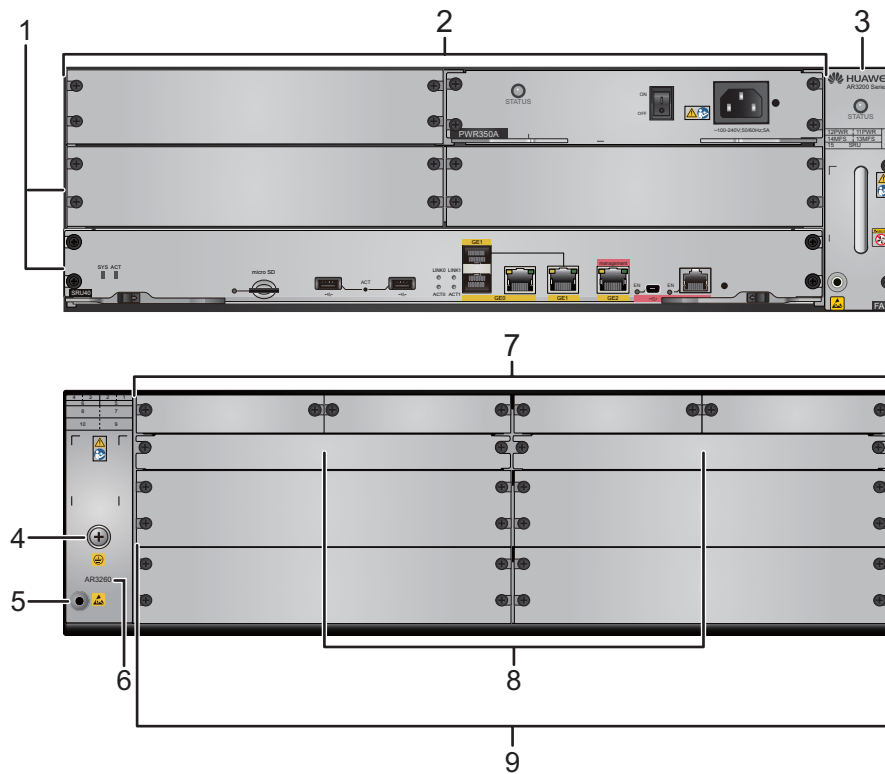

1	<p>Two SRU slots</p> <p>NOTE</p> <ul style="list-style-type: none"> • Versions earlier than V200R005C00: support a single SRU and reserve the capability to support double SRUs. • V200R005C00 and later versions: support double SRUs working in hot standby mode. 	<p>2</p> <p>Two power module slots</p> <p>Applicable power modules:</p> <ul style="list-style-type: none"> • 350 W AC Power Module • 350 W DC Power Module <p>NOTE</p> <p>AC and DC power modules cannot be used together in a router.</p>
---	--	---

3	AR3260 Fan Module slot	4	Ground point NOTE Reliably ground the router by connecting a ground cable to the ground point to protect the router against lightning and interference.
5	ESD jack NOTE When maintaining the router, wear an ESD wrist strap and insert the other end of the ESD wrist strap in the ESD jack.	6	Product model silkscreen
7	Four SIC slots	8	Two WSIC slots
9	Four XSIC slots	-	-

Slot Distribution

Figure 4-75 shows slot distribution of AR3200 series routers.

NOTE

- Two SIC slots can be combined into one WSIC slot by removing the guide rail between them.
- Two SIC slots and one WSIC slot can be combined into one XSIC slot by removing guide rails.
- The two multiple-function slots (MFSs) can be combined into an SRU slot by removing the guide rail between them.
- After two slots are combined, the larger slot ID of the two slots becomes the ID of the new slot.
- Since V200R002C00, a WSIC card can be inserted into an XSIC slot with a special component. The WSIC card is in the lower side of the slot and uses the XSIC slot ID as its own slot ID.

Figure 4-75 Slot distribution of the AR3200 series routers

Device Model		Slot Distribution			Slot Combination																																
AR3260	Front view	12(Power)	11(Power)	F A N	12(Power)	11(Power)	F A N																														
		14(MFS)	13(MFS)		14(SRU)																																
		15(SRU)			15(SRU)																																
	Rear view	<table border="1"> <tr> <td>4(SIC)</td> <td>3(SIC)</td> <td>2(SIC)</td> <td>1(SIC)</td> </tr> <tr> <td colspan="2">6(WSIC)</td> <td colspan="2">5(WSIC)</td> </tr> <tr> <td colspan="2">8(XSIC)</td> <td colspan="2">7(XSIC)</td> </tr> <tr> <td colspan="2">10(XSIC)</td> <td colspan="2">9(XSIC)</td> </tr> </table>			4(SIC)	3(SIC)	2(SIC)	1(SIC)	6(WSIC)		5(WSIC)		8(XSIC)		7(XSIC)		10(XSIC)		9(XSIC)		<p>Two SIC slots are combined into one WSIC slot</p> <table border="1"> <tr> <td>4(WSIC)</td> <td>2(WSIC)</td> </tr> <tr> <td>6(WSIC)</td> <td>5(WSIC)</td> </tr> <tr> <td>8(XSIC)</td> <td>7(XSIC)</td> </tr> <tr> <td>10(XSIC)</td> <td>9(XSIC)</td> </tr> </table> <p>Two WSIC slots are combined into one XSIC slot</p> <table border="1"> <tr> <td>6(XSIC)</td> <td>5(XSIC)</td> </tr> <tr> <td>8(XSIC)</td> <td>7(XSIC)</td> </tr> <tr> <td>10(XSIC)</td> <td>9(XSIC)</td> </tr> </table>			4(WSIC)	2(WSIC)	6(WSIC)	5(WSIC)	8(XSIC)	7(XSIC)	10(XSIC)	9(XSIC)	6(XSIC)	5(XSIC)	8(XSIC)	7(XSIC)	10(XSIC)	9(XSIC)
4(SIC)	3(SIC)	2(SIC)	1(SIC)																																		
6(WSIC)		5(WSIC)																																			
8(XSIC)		7(XSIC)																																			
10(XSIC)		9(XSIC)																																			
4(WSIC)	2(WSIC)																																				
6(WSIC)	5(WSIC)																																				
8(XSIC)	7(XSIC)																																				
10(XSIC)	9(XSIC)																																				
6(XSIC)	5(XSIC)																																				
8(XSIC)	7(XSIC)																																				
10(XSIC)	9(XSIC)																																				

As shown in **Figure 4-75**, the slots of the AR3200 series routers can be combined.

- Slot 1 and slot 2 are combined into new slot 2.
- Slot 3 and slot 4 are combined into new slot 4.
- New slot 2 and slot 5 are combined into new slot 5.
- New slot 4 and slot 6 are combined into new slot 6.
- Slot 7 and slot 8 are combined into new slot 8.
- Slot 9 and slot 10 are combined into new slot 10.
- Slot 13 and slot 14 are combined into new slot 14, which is used for the backup SRU.

4.10 AR3600 Series

AR3670

Figure 4-76 shows the appearance of the AR3670 router.

Figure 4-76 AR3670 appearance

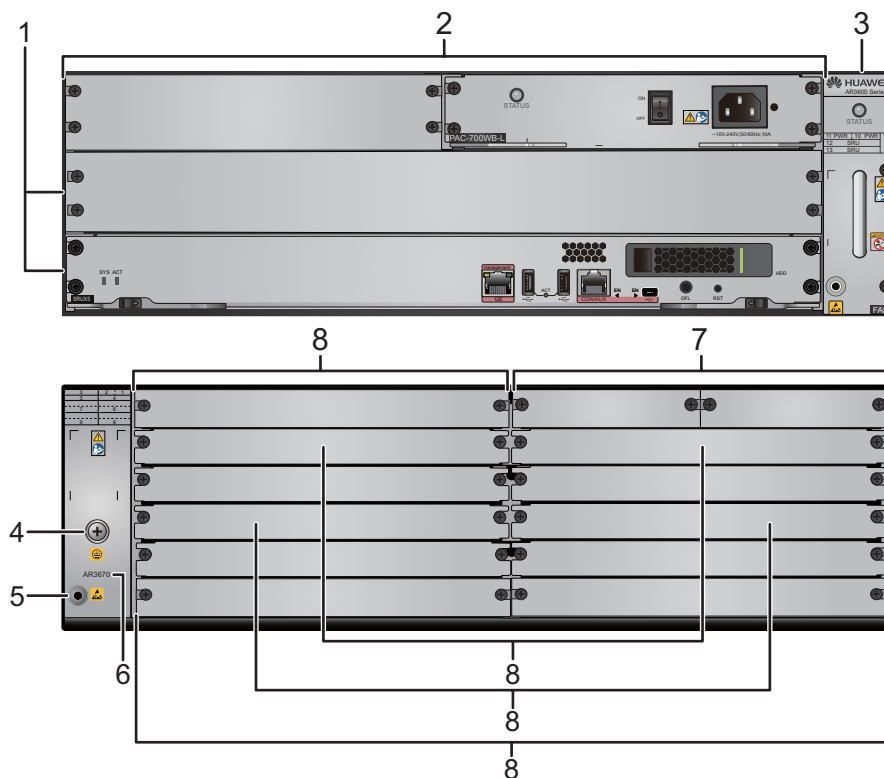

1	Two SRU slots	2	Two power module slots Applicable power module: 700 W AC Power Module
3	Fan module slot	4	Ground point NOTE Reliably ground the router by connecting a ground cable to the ground point to protect the router against lightning and interference.
5	ESD Jack NOTE When maintaining the router, wear an ESD wrist strap and insert the other end of the ESD wrist strap in the ESD jack.	6	Product model silkscreen
7	Two SIC slots	8	Seven WSIC slots

Slot Distribution

Figure 4-77 shows the slot distribution of the AR3600 series routers.

 NOTE

- Two SIC slots can be combined into one WSIC slot by removing the guide rail.
- Two SIC slots and the WSIC slot below them can be combined into one XSIC slot by removing the guide rail.
- One WSIC slot and the vacant WSIC slot above it can be combined into an XSIC slot.
- After two slots are combined into one, the slot ID is the larger one between the original two slots.

Figure 4-77 Slot distribution of the AR3600 series routers

Device Model		Slot Distribution			Slot Combination																			
AR3670	Front view	11(Power)	10(Power)	14	NA																			
		12(SRU)		F																				
		13(SRU)		A	Two SIC slots are combined into one WSIC slot <table border="1" style="margin-left: 20px;"> <tr> <td>3(WSIC)</td> <td>2(WSIC)</td> </tr> <tr> <td>5(WSIC)</td> <td>4(WSIC)</td> </tr> <tr> <td>7(WSIC)</td> <td>6(WSIC)</td> </tr> <tr> <td>9(WSIC)</td> <td>8(WSIC)</td> </tr> </table>		3(WSIC)	2(WSIC)	5(WSIC)	4(WSIC)	7(WSIC)	6(WSIC)	9(WSIC)	8(WSIC)										
3(WSIC)	2(WSIC)																							
5(WSIC)	4(WSIC)																							
7(WSIC)	6(WSIC)																							
9(WSIC)	8(WSIC)																							
	Rear view	<table border="1" style="margin-left: 20px;"> <tr> <td>3(WSIC)</td> <td>2(SIC)</td> <td>1(SIC)</td> </tr> <tr> <td>5(WSIC)</td> <td>4(WSIC)</td> <td></td> </tr> <tr> <td>7(WSIC)</td> <td>6(WSIC)</td> <td></td> </tr> <tr> <td>9(WSIC)</td> <td>8(WSIC)</td> <td></td> </tr> </table>			3(WSIC)	2(SIC)	1(SIC)	5(WSIC)	4(WSIC)		7(WSIC)	6(WSIC)		9(WSIC)	8(WSIC)		Two WSIC slots are combined into one XSIC slot <table border="1" style="margin-left: 20px;"> <tr> <td>5(XSIC)</td> <td>4(XSIC)</td> </tr> <tr> <td>7(XSIC)</td> <td>6(XSIC)</td> </tr> <tr> <td>9(XSIC)</td> <td>8(XSIC)</td> </tr> </table>		5(XSIC)	4(XSIC)	7(XSIC)	6(XSIC)	9(XSIC)	8(XSIC)
3(WSIC)	2(SIC)	1(SIC)																						
5(WSIC)	4(WSIC)																							
7(WSIC)	6(WSIC)																							
9(WSIC)	8(WSIC)																							
5(XSIC)	4(XSIC)																							
7(XSIC)	6(XSIC)																							
9(XSIC)	8(XSIC)																							

As shown in [Figure 4-77](#), the slots of the AR3600 series routers can be combined.

- Slot 1 and slot 2 are combined into new slot 2.
- New slot 2 and slot 4 are combined into new slot 4.
- Slot 3 and slot 5 are combined into new slot 5.
- Slot 6 and the vacant slot above it are combined into new slot 6.
- Slot 7 and the vacant slot above it are combined into new slot 7.
- Slot 8 and the vacant slot above it are combined into new slot 8.
- Slot 9 and the vacant slot above it are combined into new slot 9.

5 Operation and Maintenance

About This Chapter

[5.1 Various Maintenance Methods](#)

[5.2 Fault Location](#)

5.1 Various Maintenance Methods

The device supports various local and remote maintenance methods.

5.1.1 Command Line Maintenance

The ARs provide the command line mode for local or remote maintenance:

- Local maintenance using the console interface
- Local or remote maintenance using Telnet
- Secure shell (SSH) maintenance: guarantees security and provides authentication for login users on an insecure network, and defends against various attacks, including IP address spoofing, plain text password interception, and denial of service (DoS).

5.1.2 Web-based Network Management System

The device supports the web-based network management system, which provides GUI for device configuration and management.

Users can use the web-based system to manage network devices on the GUI. A junior engineer can use the GUI easily.

5.1.3 CWMP Maintenance

The CPE WAN Management Protocol (CWMP) is drafted by the Digital Subscriber's Line (DSL) forum. It is also called TR-069 standard. CWMP standardizes the communication between customer premises equipment (CPE) and auto-configuration server (ACS).

There are a lot of user devices separated on the access network. They are difficult to manage and maintain. The ARs are the CPE deployed at the user network side. The ACS uses CWMP to remotely manage the CPE. This reduces maintenance cost and improves troubleshooting efficiency.

5.1.4 Remote Deployment and Maintenance Using USB

As the network expands, more and more network devices are used and software commissioning costs increase. USB-based deployment does not require software commissioning, which reduces deployment costs.

Before using a USB flash drive to configure the device, store software package and configuration files on the USB flash drive. Software engineers do not need to commission devices onsite. After installing the device, hardware engineers will insert the USB flash drive into the USB interface on the device and power on it. After being started, the device automatically loads and upgrades the software.

5.1.5 SNMP-based Maintenance

The device supports the Simple Network Management Protocol (SNMP) v1/v2c/v3 and the Client/Server model. The ARs can be managed by the network management system (NMS), such as iManager U2000 and eSight.

5.2 Fault Location

5.2.1 Device Fault Location

The ARs support the following functions to locate device faults:

- Log
After detecting a device error or recovery event, the AR logs the event and sends the information to the background server.
- Fast information collection
A system administrator can use **display diagnostic-information** to collect device fault information.
- Device monitoring
The AR can monitor all the key indexes and components such as voltage, temperature, fan, power supply unit and board. In addition, the AR can send a trap if an error occurs.

5.2.2 Service Fault Location

The ARs support the following functions to locate service faults:

- Locating Ethernet interface faults
The ARs support interface status display, line tests, and loopback tests on interfaces. The ARs test packet sending and receiving on interfaces and collect packet statistics, assisting administrators to locate network faults and Ethernet interface connection faults.
- Network-side interface faults
The ARs support WAN interface tests, which collect traffic statistics and event statistics on WAN interfaces and perform tests such as ATM OAM, and interface loopback.
- Port mirroring and traffic mirroring
The ARs support packet mirroring on Ethernet interfaces, mirroring of packets from a network-side interface to a user-side Ethernet interface, and mirroring of protocol packets sent to the CPU.
- Connection fault
The ARs test connections and display connection status on network-side interfaces, and collect connection statistics.
- Voice signal fault
The ARs record the entire signal interaction process and test signal online. In addition, the ARs test the quality of VoIP services and locate dialing and service faults.

6 Technical Specifications

About This Chapter

- [6.1 AR120 Series](#)
- [6.2 AR150 Series](#)
- [6.3 AR160 Series](#)
- [6.4 AR200 Series](#)
- [6.5 AR500 Series](#)
- [6.6 AR510 Series](#)
- [6.7 AR1200 Series](#)
- [6.8 AR2200 Series](#)
- [6.9 AR3200 Series](#)
- [6.10 AR3600 Series](#)

6.1 AR120 Series

Table 6-1 lists technical specifications of the AR120 series routers.

Table 6-1 AR120 series routers technical specifications

Item		Specification
Processor		Dual-core, 1 GHz
Memory		512 MB
Flash memory		512 MB
Dimensions (W x D x H)		<ul style="list-style-type: none"> ● With no mounting bracket installed: 300.0 mm x 216.4 mm x 44.0 mm (11.81 in. x 8.52 in. x 1.73 in.) ● With mounting brackets installed: 482.6 mm x 216.4 mm x 44.0 mm (19.00 in. x 8.52 in. x 1.73 in.)
Weight (standard configuration)		2.8 kg (6.2 lb)
Maximum power consumption		<ul style="list-style-type: none"> ● AR121: 9.3 W ● AR129: 9.7 W
Power parameters	AC power input	<ul style="list-style-type: none"> ● Rated voltage: 100 V AC/240 V AC, 50/60 Hz ● Maximum voltage range: 90 V AC to 264 V AC, 47 Hz to 63 Hz
	Maximum output power	24 W
Environment parameters	Operating Temperature	0°C to 45°C (32°F to +113°F)
	Storage temperature	-40°C to +70°C (-104°F to +158°F)
	Operating relative humidity	5% to 95%, noncondensing
	Operating altitude	< 5000 m (16404 ft.)

Item	Specification
Safety standards compliance	<ul style="list-style-type: none"> ● UL 60950-1 ● EN 60950-1 ● IEC 60950-1 ● BS EN 60950-1 ● CSA C22.2 No 60950-1 ● AS/NZS 60950.1 ● IS 13252 <p>For details, see the <i>Huawei AR150&AR160&AR200&AR510 Series Enterprise Routers Safety and Regulatory Compliance Information.</i></p>
EMC standards compliance	<ul style="list-style-type: none"> ● FCC 47CFR Part15 Class A ● ICES 003 Class A ● EN55022 Class A ● CISPR22 Class A ● CISPR24 ● AS/NZS CISPR22 Class A ● VCCI Class A ● ETSI EN 300 386 Class A ● EN55024 <p>For details, see the <i>Huawei AR150&AR160&AR200&AR510 Series Enterprise Routers Safety and Regulatory Compliance Information.</i></p>
Environmental standards compliance	<ul style="list-style-type: none"> ● RoHS ● ETSI EN 300 019-2-1 ● ETSI EN 300 019-2-2 ● ETSI EN 300 019-2-3 <p>For details, see the <i>Huawei AR150&AR160&AR200&AR510 Series Enterprise Routers Safety and Regulatory Compliance Information.</i></p>

6.2 AR150 Series

Table 6-2 lists the technical specifications of the AR150 series routers.

Table 6-2 AR150 series routers technical specifications

Item		Specification
Processor		Dual-core 533 MHz
Memory		512 MB
Flash memory		512 MB
Dimensions (W x D x H)		<ul style="list-style-type: none"> ● Without mounting bracket installed: 300.0 mm x 216.4 mm x 44.0 mm (11.81 in. x 8.52 in. x 1.73 in.) ● With mounting brackets installed: 482.60 mm x 216.40 mm x 44.0 mm (19 in. x 8.52 in. x 1.73 in.)
Weight (standard configuration)		2.8 kg (7.5 lb)
Maximum power consumption		<ul style="list-style-type: none"> ● AR151: 11.6 W ● AR151W-P: 10.4 W ● AR151G-HSPA+7: 12.4 W ● AR151G-C: 12.4 W ● AR156: 16.1 W ● AR156W: 16.7 W ● AR157: 15.2 W ● AR157W: 16.7 W ● AR157VW: 20.8 W ● AR157G-HSPA+7: 16.9 W ● AR158E: 14.7 W ● AR158EVW: 19.9 W
Power specifications	AC power input	<ul style="list-style-type: none"> ● Rated voltage: 100 V AC or 240 V AC, 50 Hz or 60 Hz ● Maximum voltage range: 90 V AC to 264 V AC, 47 Hz to 63 Hz
	Maximum output power	<ul style="list-style-type: none"> ● AR151W-P, AR151G-HSPA+7, AR151G-C, AR156W, AR157W and AR157G-HSPA+7: 24 W ● AR151, AR156, AR157 and AR158E: 36 W ● AR157VW and AR158EVW: 60 W
	PoE power supply	Only AR151W-P supported
Environment parameters	Operating environment temperature	0°C to 45°C

Item		Specification
	Storage temperature	-40°C to +70°C
	Operating relative humidity	5% to 95%, noncondensing
	Operating altitude	< 5000 m
Safety standards compliance		<ul style="list-style-type: none"> ● UL 60950-1 ● EN 60950-1 ● IEC 60950-1 ● BS EN 60950-1 ● CSA C22.2 No 60950-1 ● AS/NZS 60950.1 ● IS 13252 <p>For details, see the <i>Huawei AR150&AR160&AR200&AR510 Series Enterprise Routers Safety and Regulatory Compliance Information.</i></p>
EMC standards compliance		<ul style="list-style-type: none"> ● FCC 47CFR Part15 Class A ● ICES 003 Class A ● EN55022 Class A ● CISPR22 Class A ● CISPR24 ● AS/NZS CISPR22 Class A ● VCCI Class A ● ETSI EN 300 386 Class A ● EN55024 <p>For details, see the <i>Huawei AR150&AR160&AR200&AR510 Series Enterprise Routers Safety and Regulatory Compliance Information.</i></p>
Environmental standards compliance		<ul style="list-style-type: none"> ● RoHS ● ETSI EN 300 019-2-1 ● ETSI EN 300 019-2-2 ● ETSI EN 300 019-2-3 <p>For details, see the <i>Huawei AR150&AR160&AR200&AR510 Series Enterprise Routers Safety and Regulatory Compliance Information.</i></p>

6.3 AR160 Series

Table 6-3 lists technical specifications of the AR160 series routers.

Table 6-3 AR160 series routers technical specifications

Item	Specification
Processor	<ul style="list-style-type: none"> ● AR168F, AR169F, AR161FG-L, AR161FGW-L, AR161FW-P-M5, AR162F, AR161F, AR169FVW, AR169FGVW-L, AR169FGW-L, and AR161FW: dual-core, 533 MHz ● AR161, AR161G-L, AR169, AR169G-L, and AR169-P-M9: dual-core, 1 GHz
Memory	<ul style="list-style-type: none"> ● AR168F, AR169F, AR161FG-L, AR161FGW-L, AR161FW-P-M5, AR162F, AR161F, AR161, AR161G-L, AR169, AR169G-L, and AR169-P-M9: 512 MB ● AR169FVW, AR169FGVW-L, AR169FGW-L, and AR161FW: 1 GB
Flash memory	512 MB
Dimensions (W x D x H)	<ul style="list-style-type: none"> ● Without rack-mounting brackets: 300.0 mm x 216.4 mm x 44.0 mm (11.81 in. x 8.52 in. x 1.73 in.) ● With rack-mounting brackets: 482.6 mm x 216.4 mm x 44.0 mm (19 in. x 8.52 in. x 1.73 in.)
Weight (standard configuration)	2.8 kg (6.17 lb)

Item		Specification
Maximum power consumption		<ul style="list-style-type: none"> ● AR168F: 17.8 W ● AR169F: 17.8 W ● AR161FG-L: 17 W ● AR161FW: 15.2 W ● AR161FGW-L: 18.8 W ● AR161FW-P-M5: 32.4 W ● AR162F: 11.1 W ● AR169FVW: 25.3 W ● AR169FGVW-L: 28.9 W ● AR161F: 17.8 W ● AR169FGW-L: 22 W ● AR161: 9.3 W ● AR161G-L: 11.9 W ● AR169: 9.7 W ● AR169G-L: 11.5 W ● AR169-P-M9: 30.2 W
Power parameters	AC power input	<ul style="list-style-type: none"> ● Rated voltage: 100 V AC or 240 V AC, 50 Hz or 60 Hz ● Maximum voltage range: 90 V AC to 264 V AC, 47 Hz to 63 Hz
	Maximum output power	<ul style="list-style-type: none"> ● AR168F, AR169F, AR161FG-L, AR161FGW-L, AR161F, AR161FW, AR161, AR161G-L, AR169, and AR169G-L: 24 W ● AR162F: 36 W ● AR161FW-P-M5, AR169FVW, AR169FGVW-L, AR169FGW-L, and AR169-P-M9: 60 W
Environment parameters	Operating environment temperature	<ul style="list-style-type: none"> ● AR160 series (except AR161FW-P-M5): 0°C to 45°C (32°F to +113°F) ● AR161FW-P-M5: 0°C to 40°C (32°F to +104°F)
	Operating storage temperature	-40°C to +70°C (-104°F to +158°F)
	Operating relative humidity	5% to 95%, noncondensing
	Operating altitude	< 5000 m (16404 ft.)

Item	Specification
Safety standards compliance	<ul style="list-style-type: none"> ● UL 60950-1 ● EN 60950-1 ● IEC 60950-1 ● BS EN 60950-1 ● CSA C22.2 No 60950-1 ● AS/NZS 60950.1 ● IS 13252 <p>For details, see the <i>Huawei AR150&AR160&AR200&AR510 Series Enterprise Routers Safety and Regulatory Compliance Information</i>.</p>
EMC standards compliance	<ul style="list-style-type: none"> ● FCC 47CFR Part15 Class A ● ICES 003 Class A ● EN55022 Class A ● CISPR22 Class A ● CISPR24 ● AS/NZS CISPR22 Class A ● VCCI Class A ● ETSI EN 300 386 Class A ● EN55024 <p>For details, see the <i>Huawei AR150&AR160&AR200&AR510 Series Enterprise Routers Safety and Regulatory Compliance Information</i>.</p>
Environmental standards compliance	<ul style="list-style-type: none"> ● RoHS ● ETSI EN 300 019-2-1 ● ETSI EN 300 019-2-2 ● ETSI EN 300 019-2-3 <p>For details, see the <i>Huawei AR150&AR160&AR200&AR510 Series Enterprise Routers Safety and Regulatory Compliance Information</i>.</p>

6.4 AR200 Series

Table 6-4 lists the technical specifications of the AR200 series routers.

Table 6-4 AR200 series routers technical specifications

Item		Specification
Processor		Dual-core 533 MHz
Memory		512 MB
Flash memory		512 MB
Dimensions (W x D x H)		<ul style="list-style-type: none"> ● Without mounting bracket installed: 300.0 mm x 216.4 mm x 44.0 mm (11.81 in. x 8.52 in. x 1.73 in.) ● With mounting brackets installed: 482.60 mm x 216.40 mm x 44.0 mm (19 in. x 8.52 in. x 1.73 in.)
Weight (standard configuration)		2.8 kg (7.5 lb)
Maximum power consumption		<ul style="list-style-type: none"> ● AR201: 12.3 W ● AR201VW-P: 23 W ● AR206: 16.1 W ● AR207: 16.1 W ● AR207V: 22.8 W ● AR207VW: 20.7 W ● AR207V-P: 22.6 W ● AR207G-HSPA+7: 17.1 W ● AR208E: 14.7 W
Power specifications	AC power input	<ul style="list-style-type: none"> ● Rated voltage: 100 V AC or 240 V AC, 50 Hz or 60 Hz ● Maximum voltage range: 90 V AC to 264 V AC, 47 Hz to 63 Hz
	Maximum output power	<ul style="list-style-type: none"> ● AR200 series (except AR207VW): 36W ● AR207VW: 60W
	PoE power supply	Only AR201VW-P and AR207V-P supported
Environment parameters	Operating environment temperature	0°C to 45°C
	Operating storage temperature	-40°C to +70°C
	Operating relative humidity	5% to 95%, noncondensing
	Operating altitude	< 5000 m

Item	Specification
Safety standards compliance	<ul style="list-style-type: none"> ● UL 60950-1 ● EN 60950-1 ● IEC 60950-1 ● BS EN 60950-1 ● CSA C22.2 No 60950-1 ● AS/NZS 60950.1 ● IS 13252 <p>For details, see the <i>Huawei AR150&AR160&AR200&AR510 Series Enterprise Routers Safety and Regulatory Compliance Information</i>.</p>
EMC standards compliance	<ul style="list-style-type: none"> ● FCC 47CFR Part15 Class A ● ICES 003 Class A ● EN55022 Class A ● CISPR22 Class A ● CISPR24 ● AS/NZS CISPR22 Class A ● VCCI Class A ● ETSI EN 300 386 Class A ● EN55024 <p>For details, see the <i>Huawei AR150&AR160&AR200&AR510 Series Enterprise Routers Safety and Regulatory Compliance Information</i>.</p>
Environmental standards compliance	<ul style="list-style-type: none"> ● RoHS ● ETSI EN 300 019-2-1 ● ETSI EN 300 019-2-2 ● ETSI EN 300 019-2-3 <p>For details, see the <i>Huawei AR150&AR160&AR200&AR510 Series Enterprise Routers Safety and Regulatory Compliance Information</i>.</p>

6.5 AR500 Series

Table 6-5 lists technical specifications of the AR500 series routers.

Table 6-5 AR500 series routers technical specifications

Item		Specification
Processor		Dual-core, 1 GHz
Memory		512 MB
Nand flash memory		<ul style="list-style-type: none"> ● AR503GW-LM7: 256 MB ● AR509G-L-D-H: 512 MB
Storage		<ul style="list-style-type: none"> ● AR503GW-LM7: mSATA hard disk (120 GB) ● AR509G-L-D-H: not supported
Dimensions (W x D x H)		<ul style="list-style-type: none"> ● AR503GW-LM7: 200 mm x 160 mm x 44 mm (7.87 in. x 6.30 in. x 1.73 in.) ● AR509G-L-D-H: 190 mm x 220 mm x 44 mm (7.5 in. x 8.7 in. x 1.7 in.)
Weight		<ul style="list-style-type: none"> ● AR503GW-LM7: 1.4 kg (3.1 lb) ● AR509G-L-D-H: 1.52 kg (3.35 lb)
Maximum power consumption		<ul style="list-style-type: none"> ● AR503GW-LM7: 13 W ● AR509G-L-D-H: 12 W
Power parameters		<ul style="list-style-type: none"> ● AR503GW-LM7: <ul style="list-style-type: none"> - Rated voltage: 12 V/24 V - Maximum voltage range: 8 V to 36 V ● AR509G-L-D-H: <ul style="list-style-type: none"> - Rated voltage: 12 V - Maximum voltage range: 10.8 V to 13.2 V
Environment parameters	Operating Temperature	<ul style="list-style-type: none"> ● AR503GW-LM7: 0°C to +50°C (32°F to 122°F) ● AR509G-L-D-H: <ul style="list-style-type: none"> - PoE power supply used: -25°C to +60°C (-13°F to +140°F) - PoE power supply not used: 0°C to +40°C (32°F to 104°F)
	Storage temperature	-40°C to +85°C (-40°F to 185°F)
	Operating relative humidity	5% to 95%, noncondensing
	Operating altitude	≤ 5000 m (16404 ft.)
	Ingress protection	<ul style="list-style-type: none"> ● AR503GW-LM7: IP41 ● AR509G-L-D-H: N/A

Item	Specification
Safety standards compliance	<ul style="list-style-type: none"> ● IEC 60950-1 ● EN 60950-1 ● UL60950-1 ● GB4943 ● EN50155 ● IEC 60255-5
EMC standards compliance	<ul style="list-style-type: none"> ● EN300386 Class B ● EN55024 ● EN55022 Class B ● EN301489-1 ● EN301489-17
Environmental standards compliance	<ul style="list-style-type: none"> ● RoHS ● WEEE
Vibration standards compliance	<ul style="list-style-type: none"> ● EN61373 ● QC/T 413-2002 ● SAE J1455 Category 3

6.6 AR510 Series

Table 6-6 lists the technical specifications of the AR510 series routers.

Table 6-6 AR510 series routers technical specifications

Item	Parameter
Processor	Quad-core, 1.2 GHz
Memory	2 GB
Nand flash memory	1 GB
EMMC flash memory	4 GB
Dimensions (W x D x H)	<ul style="list-style-type: none"> ● AR511GW-LAV2M3, AR511GW-LcM7, AR511GW-LM7, and AR511GW-L-B3: 275.0 mm x 160.0 mm x 30.0 mm (10.8 in. x 6.3 in. x 1.2 in.) ● AR513W-V3M8: 275.0 mm x 180.0 mm x 40.0 mm (10.9 in. x 7.1 in. x 1.6 in.)

Item		Parameter
Weight		<ul style="list-style-type: none"> ● AR511GW-LAV2M3, AR511GW-LcM7, AR511GW-LM7, and AR511GW-L-B3: 1.3 kg (2.87 lb) ● AR513W-V3M8: 2.3 kg (5.07 lb)
Maximum power consumption		<ul style="list-style-type: none"> ● AR511GW-LAV2M3: 30W ● AR511GW-LcM7 and AR511GW-LM7: 25W ● AR511GW-L-B3: 30W ● AR513W-V3M8: 30W
Power parameters		<ul style="list-style-type: none"> ● AR511GW-LAV2M3, AR511GW-LcM7, AR511GW-LM7, and AR511GW-L-B3: <ul style="list-style-type: none"> - Rated voltage: 12 V/24 V DC - Maximum voltage range: 8 V DC to 36 V DC NOTE The router has two power terminals for DC power supply and supports power supply control using a power key. ● AR513W-V3M8: <ul style="list-style-type: none"> - Rated voltage: 12 V DC - Maximum voltage range: 11.4 V DC to 12.6 V DC
Environment parameters	Operating temperature	<ul style="list-style-type: none"> ● AR511GW-LAV2M3, and AR511GW-LcM7: -10°C to +60°C ● AR511GW-L-B3: -10°C to +60°C ● AR511GW-LM7: 0°C to +50°C (with hard disk) ● AR513W-V3M8: -10°C to +60°C (with hard disk)
	Storage temperature	-40°C to +85°C
	Operating relative humidity	5% to 95%, noncondensing
	Operating altitude	≤ 5000 m (16404 ft.)

Item		Parameter
	Ingress protection	<ul style="list-style-type: none"> ● Chassis: <ul style="list-style-type: none"> - AR511GW-LAV2M3, and AR511GW-LcM7: IP40 - AR511GW-L-B3: IP40 - AR511GW-LM7: installed on the support and not delivered independently ● Chassis + support: <ul style="list-style-type: none"> - AR511GW-LAV2M3, and AR511GW-LcM7: IP54 - AR511GW-L-B3: IP54 - AR511GW-LM7: IP41
Safety standards compliance		<ul style="list-style-type: none"> ● AR511GW-LAV2M3, AR511GW-LcM7, AR511GW-LM7, and AR511GW-L-B3: <ul style="list-style-type: none"> - IEC 60950-1 - EN 60950-1 - UL60950-1 - GB4943 ● AR513W-V3M8: <ul style="list-style-type: none"> - IEC 60950 - IEC 60065
EMC standards compliance		<ul style="list-style-type: none"> ● AR511GW-LAV2M3, AR511GW-LcM7, AR511GW-LM7, and AR511GW-L-B3: <ul style="list-style-type: none"> - EN300328 - EN301893 - EN300386 Class B - EN301489-1 - EN301489-17 ● AR513W-V3M8: <ul style="list-style-type: none"> - EN55022 - EN300386 - N301489-1/17 - FCC Part15 Class A
Environmental standards compliance		<ul style="list-style-type: none"> ● RoHS ● WEEE

Item	Parameter
Vibration standards compliance	<ul style="list-style-type: none"> ● AR511GW-LAV2M3, AR511GW-LcM7, AR511GW-LM7, and AR511GW-L-B3: <ul style="list-style-type: none"> - ISO16750-3: 2007 - EN61373 - QC/T 413-2002 (chassis) - ISO 16750-3: 2007 (chassis + support) ● AR513W-V3M8: ETSI EN 300019-1-3

6.7 AR1200 Series

Table 6-7 lists technical specifications of the AR1200 series routers.

Table 6-7 AR1200 series routers technical specifications

Item	Specification
Processor	<ul style="list-style-type: none"> ● AR1220 AC model, AR1220 DC model, AR1220V, AR1220W, AR1220VW, and AR1220L: dual-core, 500 MHz ● AR1220F, AR1220E, AR1220EV, and AR1220EVW: dual-core, 1 GHz
Switching capacity	8 Gbit/s
Memory	<ul style="list-style-type: none"> ● AR1220 AC model, AR1220 DC model, AR1220V, AR1220W, AR1220VW, AR1220L, and AR1220F: 512 MB ● AR1220E, AR1220EV, and AR1220EVW: 1 GB
Flash memory	<ul style="list-style-type: none"> ● AR1220 AC model, AR1220 DC model, AR1220V, AR1220W, AR1220VW, and AR1220L: 256 MB ● AR1220F, AR1220E, AR1220EV, and AR1220EVW: 512 MB
Dimensions (W x D x H)	<ul style="list-style-type: none"> ● Without rack-mounting brackets: 390.0 mm x 232.5 mm x 44.5 mm (15.35 in. x 9.2 in. x 1.75 in.) ● With rack-mounting brackets: 482.6 mm x 232.5 mm x 44.5 mm (19 in. x 9.2 in. x 1.75 in.)
Weight (empty chassis)	2.9 kg

Item		Specification
PoE		<ul style="list-style-type: none"> ● AR1220V, AR1220W, AR1220VW, AR1220EV, and AR1220EVW: supported ● AR1220 AC model, AR1220 DC model, AR1220L, AR1220F, and AR1220E: not supported
Power consumption (empty chassis)	Typical power consumption	<ul style="list-style-type: none"> ● AR1220 AC model: 27 W ● AR1220 DC model: 27 W ● AR1220V: 29 W ● AR1220W: 36 W ● AR1220VW: 37 W ● AR1220L: 25 W ● AR1220F: 20 W ● AR1220E: 18 W ● AR1220EV: 21 W ● AR1220EVW: 22 W
	Maximum power consumption	<ul style="list-style-type: none"> ● AR1220 AC model: 32 W ● AR1220 DC model: 32 W ● AR1220V: 34 W ● AR1220W: 42 W ● AR1220VW: 42 W ● AR1220L: 30 W ● AR1220F: 25 W ● AR1220E: 20 W ● AR1220EV: 22 W ● AR1220EVW: 25 W
Power parameters	AC power input	<ul style="list-style-type: none"> ● Rated voltage: 100 V AC or 240 V AC, 50 Hz or 60 Hz ● Maximum voltage range: 90 V AC to 264 V AC, 47 Hz to 63 Hz
	DC power input	<ul style="list-style-type: none"> ● Rated voltage: -48 V DC or -60 V DC ● Maximum voltage range: -38.4 V DC to -72 V DC
	Maximum output power	<ul style="list-style-type: none"> ● AR1220 AC model, AR1220V, AR1220W, AR1220VW, AR1220L, AR1220F, AR1220E, AR1220EV, and AR1220EVW: 60 W ● AR1220 DC model: 54 W

Item		Specification
Environment parameters	Operating environment temperature	0°C to 45°C (32°F to +113°F)
	Operating storage temperature	-40°C to +70°C (-104°F to +158°F)
	Operating relative humidity	5% to 95%, noncondensing
	Operating altitude	< 4000 m (13123 ft.)
Safety standards compliance		<ul style="list-style-type: none"> ● UL 60950-1 ● EN 60950-1 ● IEC 60950-1 ● BS EN 60950-1 ● CSA C22.2 No 60950-1 ● AS/NZS 60950.1 ● IS 13252 <p>For details, see the <i>Huawei AR1200&AR2200&AR3200 Series Enterprise Routers Safety and Regulatory Compliance Information</i>.</p>
EMC standards compliance		<ul style="list-style-type: none"> ● FCC 47CFR Part15 Class A ● ICES 003 Class A ● EN55022 Class A ● CISPR22 Class A ● CISPR24 ● AS/NZS CISPR22 Class A ● VCCI Class A ● ETSI EN 300 386 Class A ● EN55024 <p>For details, see the <i>Huawei AR1200&AR2200&AR3200 Series Enterprise Routers Safety and Regulatory Compliance Information</i>.</p>

Item	Specification
Environmental standards compliance	<ul style="list-style-type: none"> ● RoHS ● ETSI EN 300 019-2-1 ● ETSI EN 300 019-2-2 ● ETSI EN 300 019-2-3 <p>For details, see the <i>Huawei AR1200&AR2200&AR3200 Series Enterprise Routers Safety and Regulatory Compliance Information</i>.</p>

6.8 AR2200 Series

Table 6-8 lists technical specifications of the AR2200 series routers.

Table 6-8 AR2200 series routers technical specifications

Item	Specification
Processor	<ul style="list-style-type: none"> ● AR2201-48FE: 2-core 533 MHz ● AR2202-48FE: 2-core 533 MHz ● AR2204: 2-core 800 MHz ● AR2220: 4-core 600 MHz ● AR2220E: 4-core 1 GHz ● AR2240: <ul style="list-style-type: none"> - SRU40 and SRU60: 8-core 600 MHz - SRU80: 12-core 750 MHz - SRU200/SRU400: 32-core 1.2 GHz
Switching capacity	<ul style="list-style-type: none"> ● AR2201-48FE: N/A ● AR2202-48FE: N/A ● AR2204: 10 Gbit/s ● AR2220: 32 Gbit/s ● AR2220E: 32 Gbit/s ● AR2240: 80 Gbit/s

Item	Specification
Memory	<ul style="list-style-type: none"> ● AR2201-48FE: 512 MB ● AR2202-48FE: 512 MB ● AR2204: 1 GB ● AR2220: 2 GB ● AR2220E: 1 GB ● AR2240: <ul style="list-style-type: none"> - SRU40/SRU60/SRU80: 2 GB - SRU200/SRU400: 4 GB
Flash memory	<ul style="list-style-type: none"> ● AR2201-48FE: 512 MB ● AR2202-48FE: 512 MB ● AR2204: 512 MB ● AR2220: 16 MB ● AR2220E: 512 MB ● AR2240: 16 MB
Micro SD card (default sd1)	<ul style="list-style-type: none"> ● AR2201-48FE: N/A ● AR2202-48FE: N/A ● AR2204: N/A ● AR2220: 2 GB ● AR2220E: 2 GB ● AR2240: 2 GB

Item	Specification
Dimensions (W x D x H)	<ul style="list-style-type: none"> ● With no mounting bracket installed <ul style="list-style-type: none"> - AR2201-48FE: 442.0 mm x 314.9 mm x 43.6 mm (17.4 in. x 12.4 in. x 1.71 in.) - AR2202-48FE: 442.0 mm x 314.9 mm x 43.6 mm (17.4 in. x 12.4 in. x 1.71 in.) - AR2204: 442.0 mm x 420.0 mm x 44.5 mm (17.4 in. x 16.5 in. x 1.73 in.) - AR2220: 442.0 mm x 420.0 mm x 44.5 mm (17.4 in. x 16.5 in. x 1.73 in.) - AR2220E: 442.0 mm x 420.0 mm x 44.5 mm (17.4 in. x 16.5 in. x 1.73 in.) - AR2240: 442.0 mm x 470.0 mm x 88.1 mm (17.4 in. x 16.5 in. x 3.47 in.) ● With mounting brackets installed <ul style="list-style-type: none"> - AR2201-48FE: 482.6 mm x 314.9 mm x 43.6 mm (19.00 in. x 12.4 in. x 1.71 in.) - AR2202-48FE: 482.6 mm x 314.9 mm x 43.6 mm (19.00 in. x 12.4 in. x 1.71 in.) - AR2204: 482.6 mm x 420.0 mm x 44.5 mm (19 in. x 16.5 in. x 1.73 in.) - AR2220: 482.6 mm x 420.0 mm x 44.5 mm (19 in. x 16.5 in. x 1.73 in.) - AR2220E: 482.6 mm x 420.0 mm x 44.5 mm (19 in. x 16.5 in. x 1.73 in.) - AR2240: 482.6 mm x 470.0 mm x 88.1 mm (19 in. x 18.5 in. x 3.47 in.)
Weight (empty chassis)	<ul style="list-style-type: none"> ● AR2201-48FE: 4.5 kg ● AR2202-48FE: 4.5 kg ● AR2204: 6 kg ● AR2220: 7 kg ● AR2220E: 6 kg ● AR2240: 8.85 kg
RPS power supply	<ul style="list-style-type: none"> ● AR2201-48FE, AR2202-48FE, AR2204, and AR2220E: supported ● AR2220, and AR2240: not supported

Item		Specification
Power consumption (empty chassis)	Typical power consumption	<ul style="list-style-type: none"> ● AR2201-48FE: 35 W ● AR2202-48FE: 35 W ● AR2204: 35 W ● AR2220: 47 W ● AR2220E: 27 W ● AR2240: <ul style="list-style-type: none"> - SRU40: 67 W - SRU60: 67 W - SRU80: 100 W - SRU200: 130 W - SRU400: 130 W
	Maximum power consumption	<ul style="list-style-type: none"> ● AR2201-48FE: 40 W ● AR2202-48FE: 40 W ● AR2204: 55 W ● AR2220: 65 W ● AR2220E: 29 W ● AR2240: <ul style="list-style-type: none"> - SRU40: 97 W - SRU60: 97 W - SRU80: 129 W - SRU200: 185 W - SRU400: 185 W
Power specifications	AC power input	<ul style="list-style-type: none"> ● Rated voltage: 100 V AC or 240 V AC, 50 Hz or 60 Hz ● Maximum voltage range: 90 V AC to 264 V AC, 47 Hz to 63 Hz
	DC power input	<ul style="list-style-type: none"> ● Rated voltage: -48 V DC or -60 V DC ● Maximum voltage range: -38.4 V DC to -72 V DC

Item		Specification
	Maximum power	<ul style="list-style-type: none"> ● AR2201-48FE: 60 W ● AR2202-48FE: 60 W ● AR2204: 150 W ● AR2220: 150 W ● AR2220E: 150 W ● AR2240: <ul style="list-style-type: none"> - One power module configured: 350 W - Two power modules configured: <ul style="list-style-type: none"> - 1+1 backup: 350 W - Non 1+1 backup: 700 W
Environment parameters	Operating environment temperature	0°C to 45°C
	Operating storage temperature	-40°C to +70°C
	Operating relative humidity	5% to 95%, noncondensing
	Operating altitude	< 4000 m
Safety standards compliance		<ul style="list-style-type: none"> ● UL 60950-1 ● EN 60950-1 ● IEC 60950-1 ● BS EN 60950-1 ● CSA C22.2 No 60950-1 ● AS/NZS 60950.1 ● IS 13252 <p>For details, see the <i>Huawei AR1200&AR2200&AR3200 Series Enterprise Routers Safety and Regulatory Compliance Information</i>.</p>

Item	Specification
EMC standards compliance	<ul style="list-style-type: none"> ● FCC 47CFR Part15 Class A ● ICES 003 Class A ● EN55022 Class A ● CISPR22 Class A ● CISPR24 ● AS/NZS CISPR22 Class A ● VCCI Class A ● ETSI EN 300 386 Class A ● EN55024 <p>For details, see the <i>Huawei AR1200&AR2200&AR3200 Series Enterprise Routers Safety and Regulatory Compliance Information</i>.</p>
Environmental standards compliance	<ul style="list-style-type: none"> ● RoHS ● ETSI EN 300 019-2-1 ● ETSI EN 300 019-2-2 ● ETSI EN 300 019-2-3 <p>For details, see the <i>Huawei AR1200&AR2200&AR3200 Series Enterprise Routers Safety and Regulatory Compliance Information</i>.</p>

6.9 AR3200 Series

Table 6-9 lists technical specifications of the AR3200 series router.

Table 6-9 AR3200 series router technical specifications

Item		AR3260
System parameters		<ul style="list-style-type: none"> ● Processor <ul style="list-style-type: none"> - SRU40: 8-core 600 MHz - SRU60: 8-core 600 MHz - SRU80: 12-core 750 MHz - SRU200/SRU400: 32-core 1.2 GHz ● Switching capacity: 160 Gbit/s ● memory <ul style="list-style-type: none"> - SRU40/SRU60/SRU80: 2 GB - SRU200/SRU400: 4 GB ● Flash memory: 16 MB ● Micro SD card (default sd1): 2 GB
Physical specifications		<ul style="list-style-type: none"> ● Dimensions (W x D x H) <ul style="list-style-type: none"> - With no mounting bracket installed: 442.0 mm x 470.0 mm x 130.5 mm (17.4 in. x 18.5 in. x 5.14 in.) - With mounting brackets installed: 482.6 mm x 470.0 mm x 130.5 mm (19 in. x 18.5 in. x 5.14 in.) ● Weight (empty chassis): 11 kg (29.47 lb)
Power consumption (empty chassis)	Typical power consumption	<ul style="list-style-type: none"> ● SRU40: 67 W ● SRU60: 67 W ● SRU80: 104 W ● SRU200/SRU400: 140 W
	Maximum power consumption	<ul style="list-style-type: none"> ● SRU40: 97 W ● SRU60: 97 W ● SRU80: 179 W ● SRU200/SRU400: 210 W
Power specifications	AC power input	<ul style="list-style-type: none"> ● Rated voltage: 100 V AC or 240 V AC, 50 Hz or 60 Hz ● Maximum voltage range: 90 V AC to 264 V AC, 47 Hz to 63 Hz
	DC power input	<ul style="list-style-type: none"> ● Rated voltage: -48 V DC or -60 V DC ● Maximum voltage range: -38.4 V DC to -72 V DC

Item		AR3260
	Maximum power	<ul style="list-style-type: none"> ● One power module configured: 350 W ● Two power modules configured: <ul style="list-style-type: none"> - 1+1 backup: 350 W - Non 1+1 backup: 700 W
Environment parameters	Operating environment temperature	0°C to 45°C
	Operating storage temperature	-40°C to +70°C
	Operating relative humidity	5% to 95%, noncondensing
	Operating altitude	< 4000 m
Safety standards compliance		<ul style="list-style-type: none"> ● UL 60950-1 ● EN 60950-1 ● IEC 60950-1 ● BS EN 60950-1 ● CSA C22.2 No 60950-1 ● AS/NZS 60950.1 ● IS 13252 <p>For details, see the <i>Huawei AR1200&AR2200&AR3200 Series Enterprise Routers Safety and Regulatory Compliance Information</i>.</p>
EMC standards compliance		<ul style="list-style-type: none"> ● FCC 47CFR Part15 Class A ● ICES 003 Class A ● EN55022 Class A ● CISPR22 Class A ● CISPR24 ● AS/NZS CISPR22 Class A ● VCCI Class A ● ETSI EN 300 386 Class A ● EN55024 <p>For details, see the <i>Huawei AR1200&AR2200&AR3200 Series Enterprise Routers Safety and Regulatory Compliance Information</i>.</p>

Item	AR3260
Environmental standards compliance	<ul style="list-style-type: none"> ● RoHS ● ETSI EN 300 019-2-1 ● ETSI EN 300 019-2-2 ● ETSI EN 300 019-2-3 <p>For details, see the <i>Huawei AR1200&AR2200&AR3200 Series Enterprise Routers Safety and Regulatory Compliance Information</i>.</p>

6.10 AR3600 Series

Table 6-10 lists technical specifications of the AR3600 series routers.

Table 6-10 AR3600 series routers technical specifications

Item	AR3670	
System parameters	<ul style="list-style-type: none"> ● Processor: hex-core, 2.2 GHz ● Switching capacity: 360 Gbit/s ● Memory: 24 GB ● Flash: 8 GB 	
Physical specifications	<ul style="list-style-type: none"> ● Dimensions (W x D x H) <ul style="list-style-type: none"> - With no mounting bracket installed: 442.0 mm x 470.0 mm x 130.5 mm (17.40 in. x 18.50 in. x 5.14 in.) - With mounting brackets installed: 482.6 mm x 470.0 mm x 130.5 mm (19.00 in. x 8.50 in. x 5.14 in.) ● Weight (empty cabinet): 11 kg (24.3 lb) 	
Power consumption (empty chassis)	Typical power consumption	128 W
	Maximum power consumption	184 W
Power parameters	AC power input	<ul style="list-style-type: none"> ● Rated voltage: 100 V AC/240 V AC, 50/60 Hz ● Maximum voltage range: 90 V AC to 264 V AC, 47 Hz to 63 Hz

Item		AR3670
	Maximum output power	<ul style="list-style-type: none"> ● One power module configured: 700 W ● Two power modules configured: <ul style="list-style-type: none"> - 1+1 backup: 700 W - No backup: 1400 W
Environment parameters	Operating temperature	0°C to 45°C (32°F to +113°F)
	Storage temperature	-40°C to +70°C (-104°F to +158°F)
	Operating relative humidity	5% to 95%, noncondensing
	Operating altitude	< 5000 m (16404 ft.)
Safety standards compliance		<ul style="list-style-type: none"> ● UL 60950-1 ● EN 60950-1 ● IEC 60950-1 ● BS EN 60950-1 ● CSA C22.2 No 60950-1 ● AS/NZS 60950.1 ● IS 13252 <p>For details, see the <i>Huawei AR1200&AR2200&AR3200 Series Enterprise Routers Safety and Regulatory Compliance Information</i>.</p>
EMC standards compliance		<ul style="list-style-type: none"> ● FCC 47CFR Part15 Class A ● ICES 003 Class A ● EN55022 Class A ● CISPR22 Class A ● CISPR24 ● AS/NZS CISPR22 Class A ● VCCI Class A ● ETSI EN 300 386 Class A ● EN55024 <p>For details, see the <i>Huawei AR1200&AR2200&AR3200 Series Enterprise Routers Safety and Regulatory Compliance Information</i>.</p>

Item	AR3670
Environmental standards compliance	<ul style="list-style-type: none">● RoHS● ETSI EN 300 019-2-1● ETSI EN 300 019-2-2● ETSI EN 300 019-2-3 <p>For details, see the <i>Huawei AR1200&AR2200&AR3200 Series Enterprise Routers Safety and Regulatory Compliance Information</i>.</p>

7 Component Selection Guide

About This Chapter

[7.1 Router Purchase List](#)

[7.2 Board Purchase List](#)

7.1 Router Purchase List

Table 7-1 Purchase list of AR120 series

Component	Typical Configuration	Remarks
AR121	AR121,1FE WAN,4FE LAN	Mandatory
AR129	AR129,1VDSL WAN,4FE LAN	Mandatory

Table 7-2 Purchase list of AR150 series

Component	Typical Configuration	Remarks
AR151	AR151,1FE WAN,4FE LAN,1USB	Mandatory
AR151W-P	AR151W-P,1FE WAN,4FE LAN(PoE),802.11b/g/n AP,1 USB	Mandatory
AR151G-HSPA+7	AR151G-HSPA+7,1FE WAN,WCDMA HSPA +7,4FE LAN,1 USB	Mandatory
AR151G-C	AR151G-C,1FE WAN,CDMA2000 EVDO,4FE LAN,1 USB	Mandatory
AR156	AR156,ADSL2+ ANNEX B WAN,4FE LAN,1USB	Mandatory
AR156W	AR156W,ADSL2+ ANNEX B WAN,4FE LAN,802.11b/g/n AP,1USB	Mandatory
AR157	AR157,ADSL2+ ANNEX A/M WAN,4FE LAN,1USB	Mandatory
AR157W	AR157W,ADSL2+ ANNEX A/M WAN,4FE LAN,802.11b/g/n AP,1 USB	Mandatory
AR157VW	AR157VW,ADSL2+ ANNEX A/M WAN,4FE LAN,802.11b/g/n AP,4FXS+1FXO,1 USB	Mandatory
AR157G-HSPA+7	AR157G-HSPA+7,ADSL2+ ANNEX A/M WAN,WCDMA HSPA+7,4FE LAN,1 USB	Mandatory
AR158E	AR158E,4 copper pair G.SHDSL WAN,4FE LAN,1USB	Mandatory
AR158EVW	AR158EVW,4 copper pair G.SHDSL WAN,4FE LAN,802.11b/g/n AP,4FXS+1FXO,1 USB	Mandatory
PoE power supply unit	100 W PoE power supply adapter module	Optional NOTE Only applied to AR151W-P.

Component	Typical Configuration	Remarks
3G extended antenna	Omni antenna	Optional NOTE Only the AR151G-HSPA+7, AR151G-C, and AR157G-HSPA+7 can be configured with the Omni antenna.

Table 7-3 Purchase list of AR160 series

Component	Typical Configuration	Remarks
AR161	AR161,1GE WAN,4GE LAN	Mandatory
AR161G-L	AR161G-L,1GE WAN,4GE LAN,LTE	Mandatory
AR169	AR169,1VDSL WAN,4GE LAN	Mandatory
AR169G-L	AR169G-L,1VDSL WAN,4GE LAN,LTE	Mandatory
AR169-P-M9	AR169-P-M9,1VDSL WAN,1GE WAN,4GE LAN (POE+),1RS485/RS232/RS422,Multimedia Card,3 USB	Mandatory
AR168F	AR168F,4 copper pair G.SHDSL WAN,1GE COMB WAN,4GE LAN,1 USB	Mandatory
AR169F	AR169F,VDSL over POTS with bonding WAN,1GE COMB WAN,4GE LAN,1 USB	Mandatory
AR161FG-L	AR161FG-L,1GE COMB WAN,4GE LAN,1 USB,1 FDD LTE	Mandatory
AR161FGW-L	AR161FGW-L,1GE COMB WAN,4GE LAN,1 USB,1 FDD LTE,1 WLAN	Mandatory

Component	Typical Configuration	Remarks
AR161FW-P-M5	AR161FW-P-M5, Multimedia Card, 1GE COMB WAN, 4GE LAN, 1 USB	Mandatory
AR162F	AR162F, 1SA, 1GE COMB WAN, 4GE LAN, 1 USB	Mandatory
AR169FVW	AR169FVW, 1GE COMBO WAN, 4GE LAN, 1 USB, 4 FXS, 1FXO, 1 WLAN	Mandatory
AR169FGVW-L	AR169FGVW-L, 1GE COMBO WAN, 4GE LAN, 1 USB, 4 FXS, 1FXO, 1 WLAN	Mandatory
AR169FGW-L	AR169FGW-L, 1GE COMBO WAN, 4GE LAN, 1 USB, 1 WLAN	Mandatory
LTE indoor remote antenna	Omni antenna	Optional NOTE Only the AR161G-L, AR169G-L, AR161FG-L, AR161FGW-L, AR169FGW-L, and AR169FGVW-L can be configured with the Omni antenna.
PoE power supply unit	100 W PoE power supply adapter module	Optional NOTE Only applied to AR169-P-M9 and AR161FW-P-M5.

Table 7-4 Purchase list of AR200 series

Component	Typical Configuration	Remarks
AR201	AR201, 1FE WAN, 8FE LAN, 1USB	Mandatory
AR201VW-P	AR201VW-P, 1FE WAN, 8FE LAN(PoE), 802.11a/b/g/n AP, 4FXS+1FXO, 1 USB	Mandatory
AR206	AR206, ADSL2+ ANNEX B WAN, 8FE LAN, 1USB	Mandatory
AR207	AR207, ADSL2+ ANNEX A/M WAN, 8FE LAN, 1USB	Mandatory
AR207V	AR207V, ADSL2+ ANNEX A/M WAN, 8FE LAN, 4FXS+1FXO, 1USB	Mandatory
AR207VW	AR207VW, ADSL2+ ANNEX A/M WAN, 8FE LAN, 802.11a/b/g/n AP, 4FXS+1FXO, 1 USB	Mandatory

Component	Typical Configuration	Remarks
AR207V-P	AR207V-P,ADSL2+ ANNEX A/M WAN,8FE LAN (PoE),4FXS+1FXO,1USB	Mandatory
AR207G-HSPA+7	AR207G-HSPA+7,WCDMA HSPA+7,ADSL2+ ANNEX A/M WAN,8FE LAN,1USB	Mandatory
AR208E	AR208E,4 copper pair G.SHDSL WAN,8FE LAN, 1USB	Mandatory
PoE power supply unit	100 W PoE power supply adapter module	Optional NOTE Only applied to AR201VW-P and AR207V-P.
3G extended antenna	Omni antenna	Optional NOTE Only the AR207G-HSPA +7 can be configured with the Omni antenna.

Table 7-5 Purchase list of AR500 series

Component	Typical Configuration	Remarks
AR503GW-LM7	AR503GW-LM7,1*GE,WIFI 2.4G+5G,LTE, 1*USB2.0,1*mSATA,DC Input(8-36V)	Mandatory
AR509G-L-D-H	AR509G-L-D-H,1GE WAN,1VDSL WAN,4GE LAN (POE+),LTE,1 AS	Mandatory

Table 7-6 Purchase list of AR510 series

Component	Typical Configuration	Remarks
AR511GW-LAV2M3	AR511GW-LAV2M3,2*GE,WIFI 2.4G +5G,LTE,2*Video Output (HDMI/CVBS/YPbPr), 2*Audio Output+1*Audio Input,2*USB2.0,2*DC Input (8-36V)	Mandatory

Component	Typical Configuration	Remarks
AR511GW-LM7	AR511GW-LM7,1*GE,WIFI 2.4G+5G,WCDMA,2*USB2.0,1*sata,2*DC Input(8-36V)	Mandatory
AR511GW-LcM7	AR511GW-LcM7,1*GE,WIFI 2.4G+5G,LTE TDD,2*USB2.0,1*sata,2*DC Input(8-36V)	Mandatory
AR511GW-L-B3	AR511GW-L-B3,1*GE,WIFI 2.4G+5G,LTE,DTMB,2*Video Output(HDMI/CVBS/YPbPr),2*Audio Output+1*Audio Input,2*USB2.0,2*DC Input (8-36V)	Mandatory
AR513W-V3M8	AR513W-V3M8,2*GE,2*2 MIMO WIFI(2.4G/5G supported),3*Video Output (2*HDMI+1*VGA),1*Audio Output,1*eSATA,1*DI/O,3*USB+1*USB OTG,DC 12V Input	Mandatory
LTE/GPS cable	LTE/GPS cable	Optional
AR510 Box Mount Angle	AR510 Box Mount Angle	Optional
AR510 Protection support	AR510 Protection support	Optional
GPS+LTE Antenna	GPS+LTE Antenna	Optional
wifi cable	3m wifi cable	Optional
wifi cable	0.5m wifi cable	Optional

Table 7-7 Purchase list of AR1200 series

Component	Typical Configuration	Remarks
AR1220	<ul style="list-style-type: none"> ● AR1220,2GE WAN,8FE LAN,2 USB,2 SIC ● AR1220,2GE WAN,8FE LAN,2 USB,2 SIC,DC -48V 	Mandatory

Component	Typical Configuration	Remarks
AR1220V	AR1220V,2GE WAN,8FE LAN,2 USB,2 SIC,build-in 32-channel DSP	Mandatory
AR1220E	AR1220E,2GE COMBO,8GE LAN,2 USB,2 SIC	Mandatory
AR1220EV	AR1220EV,2GE COMBO,8GE LAN,2 USB,2 SIC,build-in 32-channel DSP,PoE Power Adapter	Mandatory
AR1220EVW	AR1220EVW,2GE COMBO,8GE LAN,802.11b/g/n AP,2 USB,2 SIC,build-in 32-channel DSP,PoE Power Adapter	Mandatory
AR1220W	AR1220W,2GE WAN,8FE LAN,802.11b/g/n AP,2 USB,2 SIC	Mandatory
AR1220VW	AR1220VW,2GE WAN,8FE LAN,802.11b/g/n AP,2 USB,2 SIC,build-in 32-channel DSP	Mandatory
AR1220L	AR1220L,2GE WAN,2 USB,2 SIC	Mandatory
AR1220F	AR1220F, 1GE WAN, 1GE COMBO, 8FE LAN, 2 USB, 2 SIC	Mandatory
PoE power supply unit	100 W PoE power supply adapter module	Optional NOTE Only applied to AR1220V, AR1220VW, and AR1220W.

Table 7-8 Purchase list of AR2201

Component	Typical Configuration	Remarks
AR2201-48FE	AR2201-48FE,2GE WAN(1GE Combo),1 USB,48FE LAN,60W AC Power	Mandatory

Table 7-9 Purchase list of AR2202

Component	Typical Configuration	Remarks
AR2202-48FE	AR2202-48FE,2GE WAN(1GE Combo),1 E1,1 SA,1 USB,48FE LAN,60W AC Power	Mandatory

Table 7-10 Purchase list of AR2204

Component	Typical Configuration	Remarks
AR2204	AR2204,3GE WAN(1GE Combo),2 USB,4 SIC,2 DSP DIMM,150W AC Power	Mandatory
DSP module	16/32/64/128-channel voice DSP module	Optional

Table 7-11 Purchase list of AR2220

Component	Typical Configuration	Remarks
AR2220	AR2220,3GE WAN(1GE Combo),2 USB,4 SIC,2 WSIC,1 DSP Slot,150W AC Power AR2220,3GE WAN(1GE Combo),2 USB,4 SIC,2 WSIC,1 DSP Slot,150W DC Power	Mandatory
DSP module	16/32/64/128-channel voice DSP module	Optional

Table 7-12 Purchase list of AR2220E

Component	Typical Configuration	Remarks
AR2220E	AR2220E,3GE WAN(1GE Combo),2 USB,4 SIC,2 WSIC,1 DSP DIMM,150W AC Power	Mandatory
DSP module	16/32/64/128-channel voice DSP module	Optional

Table 7-13 Purchase list of AR2240

Component	Typical Configuration	Remarks
AR2240	<ul style="list-style-type: none"> ● AR2240,Service and Router Unit 40,4 SIC,2 WSIC, 2 XSIC,350W AC Power ● AR2240,Service and Router Unit 40,4 SIC,2 WSIC, 2 XSIC,350W DC Power ● AR2240,Service and Router Unit 60,4 SIC,2 WSIC, 2 XSIC,350W AC Power ● AR2240,Service and Router Unit 60,4 SIC,2 WSIC, 2 XSIC,350W DC Power ● AR2240,Service and Router Unit 80,4 SIC,2 WSIC, 2 XSIC,350W AC Power ● AR2240,Service and Router Unit 80,4 SIC,2 WSIC, 2 XSIC,350W DC Power 	Mandatory

Component	Typical Configuration	Remarks
Fan	AR2240 Fan module	Mandatory
AC power supply unit	350 W AC power supply unit	Optional. By default, a router has one AC power supply unit. To perform load balancing, two AC power supply units can be installed.
DC power supply unit	350 W DC power supply unit	Optional. By default, a DC router has one DC power supply unit. To perform load balancing, two DC power supply units can be installed.
DSP module	16/32/64/128-channel voice DSP module	Optional

Table 7-14 Purchase list of AR3260

Component	Typical Configuration	Remarks
AR3260	<ul style="list-style-type: none"> ● AR3260,Service and Router Unit 40,4 SIC,2 WSIC, 4 XSIC,350W AC Power ● AR3260,Service and Router Unit 40,4 SIC,2 WSIC, 4 XSIC,350W DC Power ● AR3260,Service and Router Unit 60,4 SIC,2 WSIC, 4 XSIC,350W AC Power ● AR3260,Service and Router Unit 60,4 SIC,2 WSIC, 4 XSIC,350W DC Power ● AR3260,Service and Router Unit 80,4 SIC,2 WSIC, 4 XSIC,350W AC Power ● AR3260,Service and Router Unit 80,4 SIC,2 WSIC, 4 XSIC,350W DC Power 	Mandatory
Fan	AR3260 fan module	Mandatory

Component	Typical Configuration	Remarks
AC power supply unit	350 W AC power supply unit	Optional. By default, an AC router has one AC power supply unit. To perform load balancing, two AC power supply units can be installed.
DC power supply unit	350 W DC power supply unit	Optional. By default, a DC router has one DC power supply unit. To perform load balancing, two DC power supply units can be installed.
DSP module	16/32/64/128-channel voice DSP module	Optional

Table 7-15 Purchase list of AR3670

Component	Typical Configuration	Remarks
AR3670	AR3670,SRUX5 Service and Router Unit,2 SIC,2 WSIC,700W AC Power	Mandatory
Fan	AR3670 fan module	Mandatory
AC power supply unit	700 W AC power supply unit	Optional. By default, an AC router has one AC power supply unit. To perform load balancing, two AC power supply units can be installed.

7.2 Board Purchase List

Table 7-16 describes the cards supports by the AR series router.

Table 7-16 cards supports by the AR series router

Card Type	Card Name	Card Description	Maximum Power Consumption	Weight
MPU	SRU40	Service and Router Unit 40	66.9 W	2.1 kg (4.63 lb)
	SRU60	Service and Router Unit 60	66.9 W	2.1 kg (4.63 lb)
	SRU80	Service and Router Unit 80	96.2 W	2.1 kg (4.63 lb)
	SRU200	Service and Router Unit 200	123 W	2.3 kg (5.07 lb)
	SRU400	Service and Router Unit 400	123 W	2.3 kg (5.07 lb)
	SRUX5	Service and Router Unit X5	130 W	2.0 kg (4.4 lb)
Ethernet LAN interface card	8FE1GE	8-port 100M-RJ45+1-port 1000M-RJ45-L2/L3 Ethernet electrical interface card	11.2 W	0.6 kg (1.33 lb)
	9ES2	8 Port 100BASE-RJ45 and 1 Port 1000BASE-RJ45 L2 Ethernet Interface Card	7.6 W	0.6 kg (1.33 lb)
	24GE	24-port 1000M-RJ45-L2/L3 Ethernet electrical interface card	25.7 W	0.85 kg (1.88 lb)
	4GE-2S	4-Port 1000BASE-SFP-L2 Ethernet Interface Card	8 W	0.3 kg (0.66 lb)

Card Type	Card Name	Card Description	Maximum Power Consumption	Weight
	4ES2G-S	4-Port 1000BASE-RJ45 L2 Ethernet Interface Card	6.7 W	0.3 kg (0.66 lb)
	4ES2GP-S	4-Port 1000BASE-RJ45 L2 with PoE Ethernet Interface Card	6.7 W	0.3 kg (0.66 lb)
WAN interface card	1GEC	1-port-GE combo WAN interface card	3.2 W	0.25 kg (0.55 lb)
	4GECS	4-port-GE combo WAN interface card	14 W	0.6 kg (1.33 lb)
	2FE	2-port-FE WAN interface card	3.1 W	0.3 kg (0.66 lb)
	1E1/T1-M/2E1/T1-M/4E1/T1-M/8E1/T1-M NOTE 2E1/T1-M-W will be replaced by 2E1/T1-M after December 31, 2013.	1/2/4/8-port-channelized E1/T1/PRI/VE1 multifunctional interface card	<ul style="list-style-type: none"> ● 1E1/T1-M: 4.7 W ● 2E1/T1-M : 4.8 W ● 2E1/T1-M-W: 4.8 W ● 4E1/T1-M: 11 W ● 8E1/T1-M: 12 W 	<ul style="list-style-type: none"> ● 1E1/T1-M/2E1/T1-M/2E1/T1-M-W: 0.3 kg (0.66 lb) ● 4E1/T1-M/8E1/T1-M: 0.6 kg (1.33 lb)
	1E1/T1-F/2E1/T1-F/4E1/T1-F/8E1/T1-F	1/2/4/8-port-fractional channelized E1/T1 WAN interface card	<ul style="list-style-type: none"> ● 1E1/T1-F: 4.7 W ● 2E1/T1-F: 4.8 W ● 4E1/T1-F: 11 W ● 8E1/T1-F: 12 W 	<ul style="list-style-type: none"> ● 1E1/T1-F/2E1/T1-F: 0.3 kg (0.66 lb) ● 4E1/T1-F/8E1/T1-F: 0.6 kg (1.33 lb)

Card Type	Card Name	Card Description	Maximum Power Consumption	Weight
	1E3/CE3/T3/CT3	1-Port Channelized/Unchannelized E3/T3 WAN Interface Card	11.2 W	0.6 kg (1.33 lb)
	1SA/2SA	1/2-port-synchronous/asynchronous WAN interface card	<ul style="list-style-type: none"> ● 1SA: 5.5 W ● 2SA: 6.2 W 	0.3 kg (0.66 lb)
	8SA	8-Port Synchronous/Asynchronous WAN Interface Card	25 W	0.6 kg (1.33 lb)
	6E&M	6-Port E&M-RJ45 Analog Trunk Interface Card	21 W	0.6 kg (1.33 lb)
	8AS	8-port-asynchronous WAN interface card	4.7 W	0.6 kg (1.33 lb)
	1BST	1-port ISDN S/T WAN interface card	7.4 W	0.3 kg (0.66 lb)
	1CPOS-155M NOTE This card will be replaced by 1CPOS-155M-W after June 30, 2014.	1-port CPOS interface card	12 W	0.3 kg (0.66 lb)
	1CPOS-155M-W NOTE This card will replace 1CPOS-155M after June 30, 2014.	1-port CPOS interface card	12 W	0.3 kg (0.66 lb)

Card Type	Card Name	Card Description	Maximum Power Consumption	Weight
	3G-HSPA+7	3G interface card	6.5 W	0.2 kg (0.44 lb)
	3G-EVDO	3G CDMA2000 EVDO Interface Card	7 W	0.2 kg (0.44 lb)
	1LTE-H 1LTE-L	WCDMA LTE Data Card	7 W	0.2 kg (0.44 lb)
	1LTEC	TDD LTE/FDD LTE/HSPA+/ TD-SCDMA/ GSM Data Card	10.1 W	0.2 kg (0.44 lb)
	4GEW-T	4-port-GE electrical WAN interface card	10.2 W	0.3 kg (0.66 lb)
	4GEW-S	4-port-GE optical WAN interface card	8 W	0.3 kg (0.66 lb)
	1STM1/1STM	1-Port-155M/ 622M POS Optical Interface Card	12 W	0.6 kg (1.33 lb)
	4STM1	4-Port 155M Packet over SDH/SONET Optical Interface Card	16.6 W	0.6 kg (1.33 lb)
	4E1-IMA	4-port-E1 ATM IMA interface card	12 W	0.6 kg (1.33 lb)
Voice interface card	2BST NOTE This card will replace 2BST-W after December 31, 2013.	2-port-ISDN S/ T voice interface card	14.2 W	0.3 kg (0.66 lb)

Card Type	Card Name	Card Description	Maximum Power Consumption	Weight
	2BST-W NOTE This card will be replaced by 2BST after December 31, 2013.	2-port-ISDN S/T voice interface card	14.2 W	0.3 kg (0.66 lb)
	4FXS1FXO	4-port FXS + 1-port FXO voice interface card	12.78 W	0.3 kg (0.66 lb)
	16/32/64/128-channel DSP module	DSP module	2.89 W	0.05 kg (0.11 lb)
	16/32FXS	16/32-port-FXS voice interface card	<ul style="list-style-type: none"> ● 16FXS: 29 W ● 32FXS: 37.24 W 	0.6 kg (1.33 lb)
	4FXO	4-port-FXO voice interface card	6.6 W	0.1 kg (0.22 lb)
	1VE1	1-Port Voice E1 Interface Card	4.7 W	0.3 kg (0.66 lb)
xDSL/xPON interface card	1ADSL-A/M and 1ADSL-B/J	1-port-ADSL2+ ANNEX A/M and B/J WAN interface card	<ul style="list-style-type: none"> ● 1ADSL-A/M: 5.5 W ● 1ADSL-B/J: 5.5 W 	<ul style="list-style-type: none"> ● 1ADSL-A/M: 0.3 kg (0.66 lb) ● 1ADSL-B/J: 0.3 kg (0.66 lb)
	4G.SHDSL	1-port-4G.SHDSL WAN interface card	8.2 W	0.35 kg (0.77 lb)
	1GBIS4W	1-Port 4 Pair G.SHDSL WAN Interface Card (WSIC)	7.8 W	0.35 kg (0.77 lb)
	1PON	1-port-EPON/GPON interface card	8.72 W	0.3 kg (0.66 lb)

Card Type	Card Name	Card Description	Maximum Power Consumption	Weight
	VDSL2	1-port-VDSL2 over POTS WAN interface card	9.5 W	0.2 kg (0.44 lb)

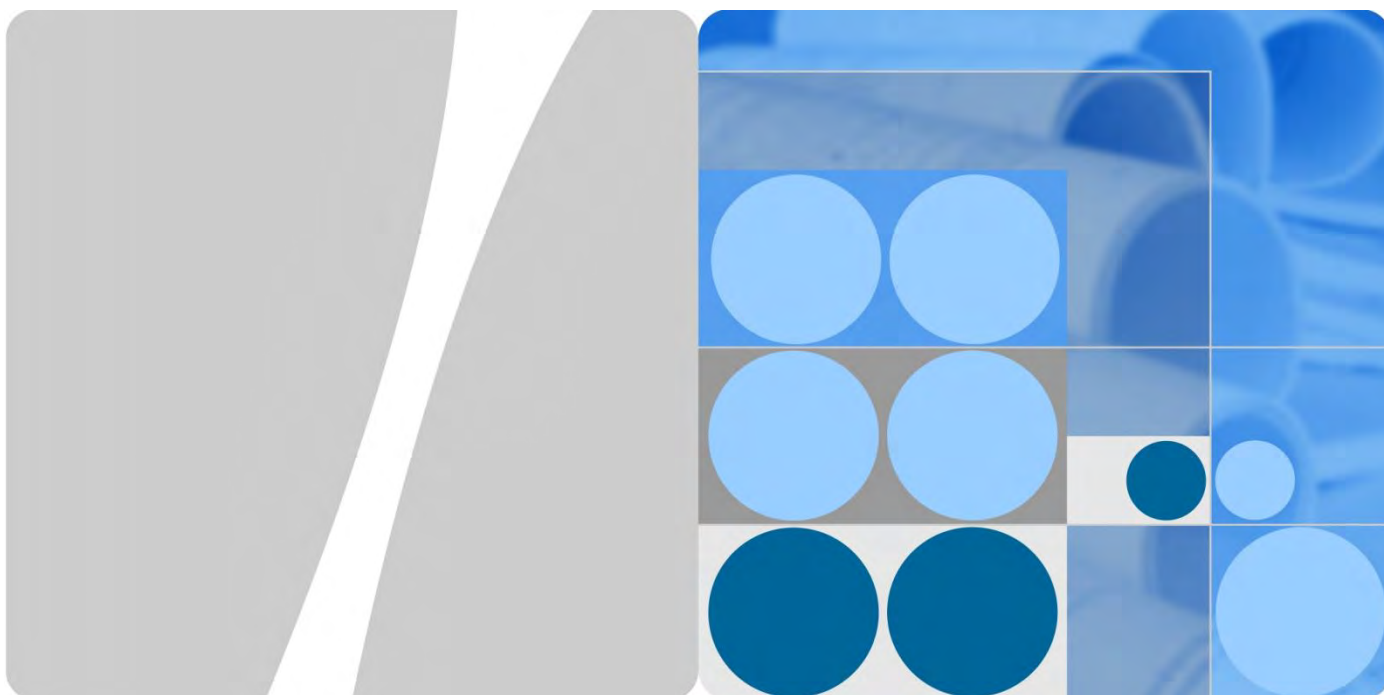

Huawei AR120&AR150&AR160&AR200&AR510 Series Enterprise Routers

Safety and Regulatory Compliance Information

Issue 06
Date 2015-05-08

Copyright © Huawei Technologies Co., Ltd. 2015. All rights reserved.

No part of this document may be reproduced or transmitted in any form or by any means without prior written consent of Huawei Technologies Co., Ltd.

Trademarks and Permissions



and other Huawei trademarks are trademarks of Huawei Technologies Co., Ltd.

All other trademarks and trade names mentioned in this document are the property of their respective holders.

Notice

The purchased products, services and features are stipulated by the contract made between Huawei and the customer. All or part of the products, services and features described in this document may not be within the purchase scope or the usage scope. Unless otherwise specified in the contract, all statements, information, and recommendations in this document are provided "AS IS" without warranties, guarantees or representations of any kind, either express or implied.

The information in this document is subject to change without notice. Every effort has been made in the preparation of this document to ensure accuracy of the contents, but all statements, information, and recommendations in this document do not constitute a warranty of any kind, express or implied.

Huawei Technologies Co., Ltd.

Address: Huawei Industrial Base
Bantian, Longgang
Shenzhen 518129
People's Republic of China

Website: <http://enterprise.huawei.com>

About This Document

Intended Audience

This document describes Electromagnetic Compatibility (EMC) and other safety standards compliance and information about the AR120&AR150&AR160&AR200&AR510 series enterprise routers.





This document provides the general safety guidelines for handling, installing or operating the AR120&AR150&AR160&AR200&AR510 series enterprise routers.

This document is intended for:

- Maintenance engineers
- Technical support engineers
- Installation engineers
- Network planning engineers

Symbol Conventions

The symbols that may be found in this document are defined as follows.

Symbol	Description
 DANGER	Indicates a hazard with a high level of risk, which if not avoided, will result in death or serious injury.
 WARNING	Indicates a hazard with a medium or low level of risk, which if not avoided, could result in minor or moderate injury.
 CAUTION	Indicates a potentially hazardous situation, which if not avoided, could result in equipment damage, data loss, performance degradation, or unexpected results.
 TIP	Indicates a tip that may help you solve a problem or save time.
 NOTE	Provides additional information to emphasize or supplement important points of the main text.

Change History

Changes between document issues are cumulative. Therefore, the latest document issue contains all the changes in previous issues.

Changes in Issue 06 (2015-05-08)

- The CE certificate of AR169-P-M9 is added.
- The CE certificates of AR120&AR150&AR160&AR200 are updated.
- The CE certificates of AR150&AR160&AR200 Series 3G Model are updated.

Changes in Issue 05 (2014-10-20)

- The CE certificate of AR511GW-LAV2M3 is added.
- The CE certificates of AR150&AR160&AR200 are updated.

Changes in Issue 04 (2013-09-30)

The CE certificates of AR150&AR160 are updated.

Changes in Issue 03 (2012-12-31)

The CE certificates of AR150&AR160&AR200 are updated.

Changes in Issue 02 (2012-06-30)

The following content is added:

- Warning on the injuries that misoperation on fans may cause
- FCC warning information
- 3G antenna warning information

The following content is modified:

- Contact information on the title page

Changes in Issue 01 (2011-12-30)

Initial commercial release.

Contents

1 Regulatory Compliance Statement	7
1.1 European Community CE Certification	8
2 Regulatory Compliance Information	16
2.1 Regulatory Compliance Standards	16
2.2 European Directives Compliance	18
2.3 USA Regulatory Compliance	19
2.3.1 FCC Part 15.....	19
2.4 Canada Regulatory Compliance	20
2.4.1 RSS-Gen & RSS-210 statement.....	20
2.4.2 RSS-102 statement.....	20
2.5 Japanese Compliance	20
2.5.1 VCCI.....	20
2.6 CISPR 22 Compliance	21
2.7 Taiwan Compliance	21
2.8 A-Tick Compliance	21
3 Safety Information	22
3.1 Overview	22
3.1.1 Safety Precautions.....	22
3.1.2 General Requirements.....	23
3.2 Electricity Safety	24
3.2.1 High Voltage	24
3.2.2 Thunderstorm.....	25
3.2.3 Tools.....	25
3.2.4 High Electrical Leakage.....	25
3.2.5 Power Cable.....	26
3.2.6 Fuse.....	26
3.2.7 Electrostatic Discharge.....	26
3.3 Inflammable Environment.....	27
3.4 Battery	28
3.4.1 Storage Battery.....	28
3.4.2 Lithium Battery.....	30
3.5 Laser.....	30

3.5.1 General Laser Information	30
3.5.2 Laser Safety Guidelines	30
3.5.3 Handling Fibers	31
3.6 Working at Heights	31
3.6.1 Weight Lifting	32
3.6.2 Safety Guide on Ladder Use	33
3.7 Mechanical Safety	33
3.7.1 Drilling	33
3.7.2 Sharp Objects	34
3.7.3 Handling Fans	34
3.7.4 Lifting Heavy Objects	34
3.8 Miscellaneous	34
3.8.1 Inserting and Removing a Board	34
3.8.2 Bundling Signal Cables	35
3.8.3 Cabling Requirements	35
3.9 3G Antenna	35
4 Sicherheitsinformationen	36
4.1 Überblick	37
4.1.1 Sicherheitsmaßnahmen	37
4.1.2 Allgemeine Anforderungen	37
4.2 Elektrische Sicherheit	39
4.2.1 Hochspannung	39
4.2.2 Gewitter	39
4.2.3 Werkzeuge	40
4.2.4 Hoher Kriechstrom	40
4.2.5 Zuleitung	40
4.2.6 Sicherung	41
4.2.7 Elektrostatische Entladung	41
4.3 Feuergefährliche Umgebung	42
4.4 Batterie	43
4.4.1 Speicherbatterie	43
4.4.2 Lithium-Batterie	45
4.5 Laser	45
4.5.1 Allgemeine Informationen zum Laser	45
4.5.2 Sicherheitsrichtlinien für Laser	46
4.5.3 Umgang mit Fasern	46
4.6 Arbeiten in großen Höhen	47
4.6.1 Heben von großen Gewichten	47
4.6.2 Sicherheitsleitfaden zur Verwendung von Leitern	48
4.7 Mechanische Sicherheit	49
4.7.1 Bohren	49

4.7.2 Scharfkantige Gegenstände	49
4.7.3 Umgang mit Ventilatoren	49
4.7.4 Heben schwerer Gegenstände	50
4.8 Verschiedenes	50
4.8.1 Einsetzen und Entfernen von Leiterplatten	50
4.8.2 Bündeln von Signalleitungen	51
4.8.3 Verkabelungsanforderungen	51
4.9 3G Antenne	51

1 Regulatory Compliance Statement

About This Chapter

This chapter provides the certification details for AR120&AR150&AR160&AR200&AR510 Series Products.

- European Community CE Certification Declaration of Conformity (DoC)

1.1 European Community CE Certification

Figure 1-1 European community CE certification of AR120&AR150&AR160&AR200 Series Products.

Doc NO.: CE-01704918

Declaration of Conformity

For EU Directives and Regulations

For the following equipment

Product : Access Router

Model/Trademark : AR151, AR201, AR201-S, AR207, AR208E, AR156
AR207V, AR206, AR157, AR207-S, AR158E, AR207V-P
AR151-S, AR168F, AR169F, AR121-S, AR161F-S
AR161F, AR162F, AR121, AR129, AR161, AR169,
AR169BF / HUAWEI

Manufacturer's Name : Huawei Technologies Co., Ltd.

Manufacturer's Address : Administration Building, Headquarters of
Huawei Technologies Co., Ltd., Bantian,
Longgang District, Shenzhen, 518129, P.R.C

is herewith confirmed to comply with the requirements which are set out in 2006/95/EC(Low Voltage Directive), 2004/108/EC(EMC Directive), 2002/95/EC & 2011/65/EU (RoHS Directive), 2002/96/EC&2012/19/EU (WEEE Directive) and 2006/1907/EC(REACH Regulation). For the evaluation of the compliance with these Directives and Regulations, the following standards/requirements were applied:

Safety	EN60950-1:2006+A11:2009+A1:2010+A12:2011+A2:2013
EMC	EN55022:2010 EN55024:2010 ETSI EN 300 386 V1.6.1:2012 EN 61000-3-2:2006+A1:2009+A2:2009 EN 61000-3-3:2013
RoHS	2002/95/EC, 2011/65/EU, EN 50581: 2012
REACH	EC NO. 1907/2006
WEEE	2002/96/EC, 2012/19/EU

CE Marking Date: 2015-4-14

Responsible for making this declaration is the:

Manufacturer Authorised representative established within the EU

Person responsible for making this declaration

Name/Title : Liu Haili Regulation Compliance Manager

Place/ Date : Shenzhen, China Apr. 14, 2015

Doc NO.: CE-01771642

Declaration of Conformity

For EU Directives and Regulations

For the following equipment

Product Access Router
Model/Trademark AR169-P-M9 / HUAWEI
Manufacturer's Name Huawei Technologies Co., Ltd.
Manufacturer's Address Administration Building, Headquarters of
Huawei Technologies Co., Ltd., Bantian,
Longgang District, Shenzhen, 518129, P.R.C

is herewith confirmed to comply with the requirements which are set out in 1999/5/EC(R&TTE Directive), 2002/95/EC & 2011/65/EU (RoHS Directive), 2002/96/EC&2012/19/EU (WEEE Directive) and 2006/1907/EC(REACH Regulation). For the evaluation of the compliance with these Directives and Regulations, the following standards/requirements were applied:

Safety	EN 60950-1:2006+A11:2009+A1:2010+A12:2011
EMC	EN 55022:2010 EN 55024:2010 ETSI EN 300 386 V1.6.1 ETSI EN 301 489-1 V1.9.2 ETSI EN 301 489-17 V2.2.1 EN 61000-3-2:2006+A1:2009+A2:2009 EN 61000-3-3:2013
Radio & Health	ETSI EN 300 328 V1.7.1 Council Recommendation 1999/519/EC EN 62311:2008 EN 62479:2010
RoHS	2002/95/EC, 2011/65/EU, EN 50581: 2012
REACH	EC NO. 1907/2006
WEEE	2002/96/EC, 2012/19/EU

CE Marking Date: 2015-4-20

Responsible for making this declaration is the:

Manufacturer Authorised representative established within the EU

Person responsible for making this declaration

Name/Title : Liu Haili Regulation Compliance Manager

Place/ Date Shenzhen, China Apr.20, 2015

Figure 1-2 European community CE certification of AR150 Series Wlan Model.

Doc NO.: CE-01163672-2

Declaration of Conformity

For EU Directives and Regulations

For the following equipment

Product Access Router

Model/Trademark AR157W,AR157VW,AR158EVW,AR151W-P
AR151W-P-S, AR156W / HUAWEI

Manufacturer's Name Huawei Technologies Co., Ltd.

Manufacturer's Address Administration Building, Headquarters of
Huawei Technologies Co., Ltd., Bantian,
Longgang District, Shenzhen, 518129, P.R.C

is herewith confirmed to comply with the requirements which are set out in 1999/5/EC(R&TTE Directive), 2002/95/EC & 2011/65/EU (RoHS Directive), 2002/96/EC&2012/19/EU (WEEE Directive) and 2006/1907/EC(REACH Regulation). For the evaluation of the compliance with these Directives and Regulations, the following standards/requirements were applied:

Safety	EN 60950-1:2006+A11:2009+A1:2010+A12:2011
EMC	EN 55022:2010 EN 55024:2010 ETSI EN 300 386 V1.6.1:2012 ETSI EN 301 489-1 V1.9.2:2011 ETSI EN 301 489-17 V2.1.1:2009 EN 61000-3-2:2006+A1:2009+A2:2009 EN 61000-3-3:2008
Radio & Health	ETSI EN 300 328 V1.7.1 (2006-10) Council Recommendation 1999/519/EC EN 62311:2008
RoHS	2002/95/EC, 2011/65/EU, EN 50581: 2012
REACH	EC NO. 1907/2006
WEEE	2002/96/EC, 2012/19/EU

Responsible for making this declaration is the:

Manufacturer Authorised representative established within the EU

Person responsible for making this declaration

Name/Title : Li Haili Regulation Compliance Manager

Place/ Date Shenzhen, China Dec 20, 2013

Figure 1-3 European community CE certification of AR160 Series Wlan Model.

Doc NO.: CE-01523178-2

Declaration of Conformity

For EU Directives and Regulations

For the following equipment

Product : Access Router
Model/Trademark : AR169FVW, AR169FGVW-L, AR169FGW / HUAWEI
Manufacturer's Name : Huawei Technologies Co., Ltd.
Manufacturer's Address : Administration Building, Headquarters of
Huawei Technologies Co., Ltd., Bantian,
Longgang District, Shenzhen, 518129, P.R.C

is herewith confirmed to comply with the requirements which are set out in 1999/5/EC(R&TTE Directive), 2002/95/EC & 2011/65/EU (RoHS Directive), 2002/96/EC&2012/19/EU (WEEE Directive) and 2006/1907/EC(REACH Regulation). For the evaluation of the compliance with these Directives and Regulations, the following standards/requirements were applied:

Safety	EN 60950-1:2006+A11:2009+A1:2010+A12:2011
EMC	EN 55022:2010+AC:2011; EN 55024:2010 ETSI EN 301 489-1 V1.9.2 ETSI EN 301 489-17 V2.2.1 ETSI EN 301 489-7 V1.3.1 (for A169FGVW-L and AR169FGW-L) ETSI EN 301 489-24 V1.5.1 (for A169FGVW-L and AR169FGW-L) EN 61000-3-2:2006+A1:2009+A2:2009 EN 61000-3-3:2013
Radio & Health	ETSI EN 300 328 V1.8.1 ETSI EN 301 511 V9.0.2 (for A169FGVW-L and AR169FGW-L) ETSI EN 901 908-1 V5.2.1 (for A169FGVW-L and AR169FGW-L) ETSI EN 901 908-2 V5.2.1 (for A169FGVW-L and AR169FGW-L) ETSI EN 901 908-13 V5.2.1 (for A169FGVW-L and AR169FGW-L) Council Recommendation 1999/519/EC EN 62311:2008; EN 50385:2002
RoHS	2002/95/EC, 2011/65/EU, EN 50581: 2012
REACH	EC NO. 1907/2006
WEEE	2002/96/EC, 2012/19/EU

CE Marking Date: 2014-9-29

Responsible for making this declaration is the:

Manufacturer **Authorised representative established within the EU**

Person responsible for making this declaration

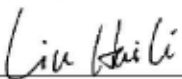
Name/Title :  Regulation Compliance Manager

Place/ Date : Shenzhen, China Sep 29,2014

Figure 1-4 European community CE certification of AR200 Series Wlan Model.

Doc No: E-00781148-3

Declaration of Conformity

For EU Directives and Regulations

For the following equipment

Product	<u>Access Router</u>
Model/Trademark	<u>AR207VW, AR201VW-P/ HUAWEI</u>
Manufacturer's Name	<u>Huawei Technologies Co., Ltd.</u>
Manufacturer's Address	<u>Administration Building, Headquarters of</u> <u>Huawei Technologies Co., Ltd., Bantian,</u> <u>Longgang District, Shenzhen, 518129, P.R.C</u>

is herewith confirmed to comply with the requirements which are set out in 1999/5/EC(R&TTE Directive), 2002/95/EC & 2011/65/EU (RoHS Directive), 2002/96/EC&2012/19/EU (WEEE Directive) and 2006/1907/EC(REACH Regulation). For the evaluation of the compliance with these Directives and Regulations, the following standards/requirements were applied:

Safety	EN 60950-1:2006+A11:2009+A1:2010+A12:2011
EMC	EN 55022:2010 EN 55024:2010 ETSI EN 300 386 V1.6.1:2012 ETSI EN 301 489-1 V1.9.2:2011 ETSI EN 301 489-17 V2.1.1:2009 EN 61000-3-2:2006+A1:2009+A2:2009 EN 61000-3-3:2008
Radio & Health	ETSI EN 300 328 V1.7.1 (2006-10) ETSI EN 301 893 V1.6.1 (2011-11) Council Recommendation 1999/519/EC EN 62311:2008
RoHS	2002/95/EC, 2011/65/EU, EN 50581: 2012
REACH	EC NO. 1907/2006
WEEE	2002/96/EC, 2012/19/EU

Responsible for making this declaration is the:

Manufacturer **Authorised representative established within the EU**

Person responsible for making this declaration

Name/Title : Liu Hai Li Regulation Compliance Manager

Place/ Date : Shenzhen, China Nov 30, 2012

Figure 1-5 European community CE certification of AR150&AR160&AR200 Series 3G Model.

Doc NO.: CE-01704299-2

Declaration of Conformity

For EU Directives and Regulations

For the following equipment

Product : Access Router

Model/Trademark : AR151G-HSPA+7, AR157G-HSPA+7, AR207G-HSPA+7
AR151G-U-S, AR161G-L, AR169G-L / HUAWEI

Manufacturer's Name : Huawei Technologies Co., Ltd.

Manufacturer's Address : Administration Building, Headquarters of
Huawei Technologies Co., Ltd., Bantian,
Longgang District, Shenzhen, 518129, P.R.C

is herewith confirmed to comply with the requirements which are set out in 1999/5/EC(R&TTE Directive), 2002/95/EC & 2011/65/EU (RoHS Directive), 2002/96/EC&2012/19/EU (WEEE Directive) and 2006/1907/EC(REACH Regulation). For the evaluation of the compliance with these Directives and Regulations, the following standards/requirements were applied:

Safety	EN 60950-1:2006+A11:2009+A1:2010+A12:2011
EMC	EN 55022:2010, EN 55024:2010 ETSI EN 301 489-1 V1.9.2:2011 ETSI EN 301 489-7 V1.3.1:2005 ETSI EN 301 489-24 V1.5.1:2010 ETSI EN 301 489-25 V2.3.2:2005 EN 61000-3-2:2006+A1:2009+A2:2009 EN 61000-3-3:2013
Radio & Health	ETSI EN 304 511 V9.0.2 ETSI EN 301 908-1 V6.2.1 ETSI EN 301 908-2 V5.4.1 ETSI EN 301 908-13 V5.2.1 Council Recommendation 1999/519/EC EN 62311:2008, EN50383:2010; EN50385:2002
RoHS	2002/95/EC, 2011/65/EU, EN 50581: 2012
REACH	EC NO. 1907/2006
WEEE	2002/96/EC, 2012/19/EU

CE Marking Date: 2015-3-24

Responsible for making this declaration is the:

Manufacturer **Authorised representative established within the EU**

Person responsible for making this declaration

Name/Title : Liu Haili **Regulation Compliance Manager**

Place/ Date : Shenzhen, China Mar. 24, 2015

Doc NO.: CE-01376884

Declaration of Conformity

For EU Directives and Regulations

For the following equipment

Product Access Router
Model/Trademark AR161FG-L, AR161FGW-L, AR161FW-P-M5 / HUAWEI
Manufacturer's Name Huawei Technologies Co., Ltd.
Manufacturer's Address Administration Building, Headquarters of
Huawei Technologies Co., Ltd., Bantian,
Longgang District, Shenzhen, 518129, P.R.C

is herewith confirmed to comply with the requirements which are set out in 1999/5/EC(R&TTE Directive), 2002/95/EC & 2011/65/EU (RoHS Directive), 2002/96/EC&2012/19/EU (WEEE Directive) and 2006/1907/EC(REACH Regulation). For the evaluation of the compliance with these Directives and Regulations, the following standards/requirements were applied:

Safety	EN 60950-1:2006+A11:2009+A1:2010+A12:2011+A2:2013
EMC	EN 55022:2010, EN 55024:2010 ETSI EN 300 386 V1.6.1 ETSI EN 301 489-1 V1.9.2 ETSI EN 301 489-7 V1.3.1 (for AR161FG-L and AR161FGW-L) ETSI EN 301 489-17 V2.1.1 (for AR161FGW-L and AR161FW-P-M5) ETSI EN 301 489-24 V1.5.1 (for AR161FG-L and AR161FGW-L) ETSI EN 301 489-25 V2.3.2 (for AR161FG-L and AR161FGW-L) EN 61000-3-2:2006+A1:2009+A2:2009 EN 61000-3-3:2008
Radio & Health	ETSI EN 300 328 V1.7.1 (for AR161FGW-L and AR161FW-P-M5) ETSI EN 301 511 V9.0.2 (for AR161FG-L and AR161FGW-L) ETSI EN 301 908-1 V5.2.1 (for AR161FG-L and AR161FGW-L) ETSI EN 301 908-2 V5.2.1 (for AR161FG-L and AR161FGW-L) ETSI EN 301 908-13 V5.2.1 (for AR161FG-L and AR161FGW-L) Council Recommendation 1999/519/EC EN 62311:2008, EN 50383:2010, EN 50385:2002
RoHS	2002/95/EC, 2011/65/EU, EN 50581: 2012
REACH	EC NO. 1907/2006
WEEE	2002/96/EC, 2012/19/EU

CE Marking Date: 2014-08-15

Responsible for making this declaration is the:

Manufacturer Authorised representative established within the EU

Person responsible for making this declaration

Name/Title : Liu Haili Regulation Compliance Manager

Place/ Date Shenzhen, China Aug 15, 2014

Figure 1-6 European community CE certification of AR510 Series Products.

Doc NO.: CE-01456551

Declaration of Conformity

For EU Directives and Regulations

For the following equipment

Product	<u>Access Router</u>
Model/Trademark	<u>AR511GW-LAV2M3 / HUAWEI</u>
Manufacturer's Name	<u>Huawei Technologies Co., Ltd.</u>
Manufacturer's Address	<u>Administration Building, Headquarters of</u> <u>Huawei Technologies Co., Ltd., Bantian,</u> <u>Longgang District, Shenzhen, 518129, P.R.C</u>

is herewith confirmed to comply with the requirements which are set out in 1999/5/EC(R&TTE Directive), 2002/95/EC & 2011/65/EU (RoHS Directive), 2002/96/EC&2012/19/EU (WEEE Directive) and 2006/1907/EC(REACH Regulation). For the evaluation of the compliance with these Directives and Regulations, the following standards/requirements were applied:

Safety	EN 60950-1:2006+A11:2009+A1:2010+A12:2011+A2:2013
EMC	EN 55022:2010/AC:2011 ; EN 55024:2010 ETSI EN 301 489-1 V1.9.2 ; ETSI EN 301 489-3 V1.4.1 ETSI EN 301 489-7 V1.3.1 ; ETSI EN 301 489-17 V2.2.1 ETSI EN 301 489-24 V1.5.1 ; ETSI EN 300 386 V1.6.1 EN 61000-3-2:2006+A1:2009+A2:2009 EN 61000-3-3:2008
Radio & Health	ETSI EN 300 328 V1.8.1 ETSI EN 301 893 V1.7.1 ETSI EN 301 511 V9.0.2 ETSI EN 301 908-1 V5.2.1 ETSI EN 301 908-2 V5.2.1 ETSI EN 301 908-13 V5.2.1 EN 300 440-2 V1.4.1 Council Recommendation 1999/519/EC EN 62311:2008, EN 50383:2010, EN 50385:2002
RoHS	2002/95/EC, 2011/65/EU, EN 50581: 2012
REACH	EC NO. 1907/2006
WEEE	2002/96/EC, 2012/19/EU

CE Marking Date: 2014-10-10

Responsible for making this declaration is the:

Manufacturer **Authorised representative established within the EU**

Person responsible for making this declaration

Name/Title : Liu Haili **Regulation Compliance Manager**

Place/ Date : Shenzhen, China Oct. 10, 2014

2 Regulatory Compliance Information

About This Chapter

The following table lists the contents of this chapter.

Title	Description
2.1 Regulatory Compliance Standards	The regulatory compliance standards on EMC, safety, NEBS, telecom, Laser Radiation, RF, health, and environmental protection.
2.2 European Directives Compliance	The compliance with European directives, including RoHS compliance and device recycling guide.
2.3 USA Regulatory Compliance	The USA regulatory compliance, including FCC part 15.
2.5 Japanese Compliance	The Japan regulatory compliance, including VCCI Class A.
2.6 CISPR 22 Compliance	The CISPR 22 regulatory compliance.
2.7 Taiwan Compliance	BSMI Class A by Information Technology Equipment (ITE)

2.1 Regulatory Compliance Standards

AR120&AR150&AR160&AR200&AR510 Series Products comply with the standards listed in Table 2-1.

Table 2-1 Regulatory compliance standards

Discipline	Standards
EMC	<ul style="list-style-type: none"> • CISPR22 Class A • CISPR24 • EN55022 Class A • EN50024 • ETSI EN 300 386 Class A • CFR 47 FCC Part 15 Class A • ICES 003 Class A • AS/NZS CISPR22 Class A • GB9254 Class A • VCCI Class A • CNS 13438 Class A • IEC61000-3-2 • IEC61000-3-3 • EN61000-3-2 • EN61000-3-3 • ITU-T K.20 • ITU-T K.44 • ITU-T K.45
Safety	<ul style="list-style-type: none"> • IEC 60950-1 • IEC/EN41003 • EN 60950-1 • UL 60950-1 • CSA C22.2 No 60950-1 • AS/NZS 60950.1 • BS EN 60950-1 • IS 13252 • GB4943
Laser safety	<ul style="list-style-type: none"> • FDA rules, 21 CFR 1040.10 and 1040.11 • IEC60825-1, IEC60825-2, EN60825-1, EN60825-2 • GB7247
Health	<ul style="list-style-type: none"> • ICNIRP Guideline • 1999-519-EC • EN 50385 • OET Bulletin 65 • IEEE Std C95.1 • EN 60215
Environmental protection	RoHS

Discipline	Standards
Grounding	<ul style="list-style-type: none">• ITU-T K.27• ETSI EN 300 253
<p>Note:</p> <p>EMC: electromagnetic compatibility</p> <p>NEBS: Network Equipment Build Standard</p> <p>RF: radio frequency</p> <p>CISPR: International Special Committee on Radio Interference</p> <p>EN: European Standard</p> <p>ETSI: European Telecommunications Standards Institute</p> <p>CFR: Code of Federal Regulations</p> <p>FCC: Federal Communication Commission</p> <p>IEC: International Electrotechnical Commission</p> <p>AS/NZS: Australian/New Zealand Standard</p> <p>VCCI: Voluntary Control Council for Interference</p> <p>CNS: Chinese National Standard</p> <p>UL: Underwriters Laboratories</p> <p>CSA: Canadian Standards Association</p> <p>BS: British Standard</p> <p>IS: Indian Standard</p> <p>GR: general requirement</p> <p>FDA: Food and Drug Administration</p> <p>BTS: base transceiver station</p> <p>GSM: Global System for Mobile communications</p> <p>WLAN: wireless local area network</p> <p>ICNIRP: International Commission on Non-Ionizing Radiation Protection</p> <p>OET: Office of Engineering Technology</p> <p>IEEE: Institute of Electrical and Electronics Engineers</p> <p>RoHS: restriction of the use of certain hazardous substances</p>	

2.2 European Directives Compliance

AR120&AR150&AR160&AR200&AR510 Series Products comply with the following European directives.

- 89/336/EC (EMC)
- 2006/95/EC (low voltage)
- 1999/5/EC (R&TTE)

Refer to Figure 1-1 for Huawei Declaration of Conformity.

AR120&AR150&AR160&AR200&AR510 Series Products comply with Directive 2002/95/EC, on the RoHS in electrical and electronic equipment. The device does not contain lead, mercury, cadmium, and hexavalent chromium and brominated flame retardants (polybrominated biphenyls (PBB) or polybrominated diphenyl ethers (PBDE)) except for those exempted applications allowed by RoHS directive for technical reasons.

AR120&AR150&AR160&AR200&AR510 Series Products comply with Directive 2002/96/EC on waste electrical and electronic equipment. Huawei is responsible for recycling its end-of-life devices. Contact Huawei local service center when recycling is required.

The main materials in the device are steel, plastics, copper, and electronic components. Most of the materials are recyclable.

Comply with the following rules for recycling at the end of life of the device.

- Remove power first in the disassembly.
- Remove and send battery, PCB, fans and cables to special institution for disposal because it contains chemical substance.
- Dispose of battery separately because it contains hazardous substance.
- No hazardous substance is contained in the label printing ink and plastic paint, and no hazardous gas is emitted when the label printing ink and plastic paint is burning.
- Dispose of the yellow chromate conversion coating screw separately because it contains Cr^{6+} .
- Provide the plastic marking reference, such as ISO1043, and EN50419.

2.3 USA Regulatory Compliance

2.3.1 FCC Part 15

AR120&AR150&AR160&AR200&AR510 Series Products comply with Part 15 of the FCC Rules. Operation is subject to the following two conditions:

- This device does not cause harmful interference.
- This device must accept any interference received, including interference that may cause undesired operation.



WARNING

- This device has been tested and found to comply with the limits for a Class A digital device, pursuant to Part 15 of the FCC Rules. These limits are designed to provide reasonable protection against harmful interference when the device is operated in a commercial environment.
 - This equipment complies with FCC RF radiation exposure limits set forth for an uncontrolled environment. This transmitter must not be co-located or operating in conjunction with any other antenna or transmitter. This equipment should be installed and operated with a minimum distance of 20 centimeters between the radiator and your body.
-

If this device is modified without authorization from Huawei, the device may no longer comply with FCC requirements for Class A digital devices. In that a case, your right to use the device may be limited by FCC regulations. Moreover, you may be required to correct any interference to radio or television communications at your own expense.

This device has been tested and found to comply with the limits for a Class A digital device, pursuant to Part 15 of the FCC Rules. These limits are designed to provide reasonable protection against harmful interference when the device is operated in a commercial environment.

This device generates, uses and radiates radio frequency energy. If it is not installed and used in accordance with the instructions, it may cause harmful interference to radio communications.

Operation of this device in a residential area is likely to cause harmful interference. In this case the user will be requested to correct the interference at his or her own expense.

2.4 Canada Regulatory Compliance

2.4.1 RSS-Gen & RSS-210 statement

This device complies with Industry Canada licence-exempt RSS standard(s). Operation is subject to the following two conditions: (1) this device may not cause interference, and (2) this device must accept any interference, including interference that may cause undesired operation of the device.

Le présent appareil est conforme aux CNR d'Industrie Canada applicables aux appareils radio exempts de licence. L'exploitation est autorisée aux deux conditions suivantes : (1) l'appareil ne doit pas produire de brouillage, et (2) l'utilisateur de l'appareil doit accepter tout brouillage radioélectrique subi, même si le brouillage est susceptible d'en compromettre le fonctionnement.

2.4.2 RSS-102 statement

This equipment complies with IC radiation exposure limits set forth for an uncontrolled environment. This equipment should be installed and operated with minimum distance 20 cm between the radiator and your body.

Cet équipement est conforme à l'exposition aux rayonnements IC limites établies pour un environnement non contrôlé. Cet équipement doit être installé et utilisé avec un minimum de 20 cm de distance entre le radiateur et votre corps.

2.5 Japanese Compliance

2.5.1 VCCI

AR120&AR150&AR160&AR200&AR510 Series Products comply with VCCI Class A by Information Technology Equipment (ITE).

この装置は、クラス A 情報技術装置です。この装置を家庭環境で使用すると電波妨害を引き起こすことがあります。この場合には使用者が適切な対策を講ずるよう要求されることがあります。 VCCI-A

2.6 CISPR 22 Compliance

AR120&AR150&AR160&AR200&AR510 Series Products comply with CISPR 22 for Class A by the ITE.

Class A ITE is a category of all other ITE that satisfies only the Class A ITE regulations, and not the Class B ITE regulations. Such equipment should not be restricted in its sale but the following warning shall be included in the instructions for use:



WARNING

This is Class A Product. In a domestic environment this product may cause radio interference; therefore, the user is required to take appropriate measures.

2.7 Taiwan Compliance

The AR151G-HSPA+7 complies with NCC Regulation and is certified.

減少電磁波影響，請妥適使用

The AR151G-HSPA+7 complies with BSMI Class A by Information Technology Equipment (ITE).

警告使用者：

此為甲類資訊技術設備，於居住環境中使用時，可能會造成射頻擾動，在此種情況下，使用者會被要求採取某些適當的對策。

2.8 A-Tick Compliance

Statement: The cables connected to voice interfaces of this product model must have a ferrite bead to meet A-Tick requirements. The normal temperature inductance factor of a ferrite bead ranges from **7200 nH/N² to 13300 nH/N²**.

3 Safety Information

About This Chapter

The following table lists the contents of this chapter.

Title	Description
3.1 Overview	Safety precautions to be taken before installing and maintaining the Huawei device.
3.2 Electricity Safety	Information about the electricity safety.
3.3 Inflammable Environment	Information about the inflammable environment safety.
3.4 Battery	Information about the battery safety.
3.5 Laser	Safety precautions on the Electromagnetic Field Exposure of the device and laser.
3.6 Working at Heights	Safety precautions to be taken before using the ladders or hoisting heavy objects.
3.7 Mechanical Safety	Safety precautions on drilling, on sharp objects, on handling fans, and on lifting heavy objects.
3.8 Miscellaneous	Safety precautions on inserting and removing boards, on bundling signal cables, and cabling requirements.

3.1 Overview

3.1.1 Safety Precautions

This section describes the safety precautions to be taken before installing and maintaining the Huawei device.

- Before performing an operation, read the operation instructions and precautions to be taken, and follow them to prevent accidents. The Caution, Warning and Danger items in other documents do not cover all the safety precautions that must be followed. They are only supplementary information. The installation and maintenance personnel need to understand the basic safety precautions to be taken.
- When operating the device, obey the local safety regulations. The safety precautions provided in the documents are supplementary and shall be in compliance with the local safety regulations.
- When operating the Huawei device, in addition to the precautions, follow the specific safety instructions given by Huawei.
- The installation and maintenance personnel must receive training in safety precautions. Only qualified personnel can install or maintain the device.

3.1.2 General Requirements

To minimize the technically residual risk, it is imperative to obey the following rules. Read all the instructions before operation.

Installation

- The device (or system) must be installed or used in the restricted access location.
- Be care the hot surface when the device is operating. When touching the surface or operating the handle of the device by hands, wear gloves to protect your hands from scalding.
- Before operation, the device must be fixed securely on the floor or to other reliable objects, such as the walls and the mounting racks.
- When installing the unit, always make the ground connection first and disconnect it at the end.
- Do not block the ventilation while the device is running. Keep a minimum distance of 5 cm from the ventilation to the walls or the other objects that block the ventilation.
- Tighten the thumbscrews by using a tool after both initial installation and subsequent access to the panel.

Ground

- Do not damage the ground conductor or operate the device in the absence of well installed ground conductor. Conduct the appropriate electrical inspection.
- The device (or system) must be connected permanently to the protection ground before an operation. The cross sectional area of protective ground conductor shall be at least 1.0 mm².

Power Supply

- For AC supplied model: The socket-outlet shall be installed near the equipment and shall be easily accessible.
- For AC supplied model: The device applies to TN, TT power systems.
- Prepared conductors are connected to the terminal block, and only appropriate AWG/Type of wire is secured in the listed lug terminals.
- This device relies on the building's installation for short-circuit (overcurrent) protection. Ensure that a fuse or circuit breaker no larger than 240 V AC, 20 A for AC supplied model.

- For AC supplied model: The plug-socket combination must be accessible at all times because it serves as the main disconnect device.
- Because the device has several power supplies, disconnect all of them to switch off the device.
- The AC power supply has double pole/neutral fusing.
- To reduce the risk of fire, use only No. 26 AWG or larger telecommunication line cord.

Human Safety

- Do not operate the device or cables at lightning strikes.
- To avoid electric shock, do not connect safety extra-low voltage (SELV) circuits to telecommunication network voltage (TNV) circuits.
- Do not look directly into the optical port to prevent the laser radiation from injuring your eyes.
- Do not wear jewelry or watches when you operate the device.

Operator

- Only qualified and skilled personnel must install, configure, and disassemble the device.
- Only the personnel authorized must operate the device.
- Any replacement or change to the device or parts of the device (including the software) must be done by qualified or authorized personnel of Huawei.
- Any fault or error that might cause safety problems must be reported immediately to the person in charge.
- Only qualified personnel must remove or disable the safety facilities, or to troubleshoot and maintain the device.

Ensure that the instructions provided in this document are followed completely. The document also provides guidelines in selecting the measuring and testing device.

3.2 Electricity Safety

3.2.1 High Voltage



DANGER

The high voltage power supply offers power for the device operation. Direct or indirect contact (through damp objects) with high voltage and AC mains supply may result in fatal danger.

-
- During the installation of the AC power supply facility, follow the local safety regulations. The personnel who install the AC facility must be qualified to perform high voltage and AC operations.
 - Do not wear conductive articles, such as watches, hand chains, bracelets and rings during the operation.

- When water is found in the rack or the rack is damp, switch off the power supply immediately.
- When the operation is performed in a damp environment, make sure that the device is dry.



WARNING

Non-standard and improper high voltage operations may result in fire and electric shock. Therefore, you must obey the local rules and regulations when bridging and wiring AC cables. Only qualified personnel must perform high voltage and AC operations.

3.2.2 Thunderstorm



DANGER

High voltage and AC operations, or operations on a steel tower and a mast are prohibited during thunderstorm.

During thunderstorm, the electromagnetic field generated in the thunderstorm area may damage the electronic parts. To prevent damage to the device during lightning, ground the device properly.

3.2.3 Tools



WARNING

Suggestion: Dedicated tools must be used during high voltage and AC operations. Avoid using ordinary tools.

3.2.4 High Electrical Leakage



WARNING

Ground the device before powering on the device. Otherwise, the personnel and device are in danger.

If the "high electrical leakage" flag is stuck to the power terminal of the device, you must ground the device before powering it on.

3.2.5 Power Cable



WARNING

Installation and removal of live line are prohibited. Transient contact between the core of the power cable and the conductor may generate electric arc or spark, which may cause fire or eye injury.

-
- Before installing or removing the power cable, turn off the power switch.
 - Before connecting the power cable, confirm that the power cable and label comply with the requirements of the actual installation.
-



CAUTION

-
- For AC power supplied device, use 1.0 mm² or 16 AWG minimum power supply cord.
 - Use the type H03VV-F or light PVC sheathed flexible cord based on IEC 60227.
-

3.2.6 Fuse



WARNING

If a fuse is to be replaced, the new fuse shall be of the same type and specifications.

3.2.7 Electrostatic Discharge



CAUTION

The static electricity generated by the human body may damage the electrostatic sensitive components on the circuit board, such as the large-scale integrated circuit (LSI).

In the following situations, the human body will generate a static electromagnetic field:

- Human body moving
- Clothes friction
- Friction between shoes and the ground
- Holding ordinary plastic in hand

The static electromagnetic field will remain within the human body for a long time.

Before touching the device, hand-operating parts, circuit boards, or ASICs, wear a grounded electrostatic discharge (ESD) wrist strap. It can prevent the sensitive components from damage by the static electricity in the human body.

Figure 3-1 shows the wearing of an ESD wrist strap.

Figure 3-1 Wearing an ESD wrist strap

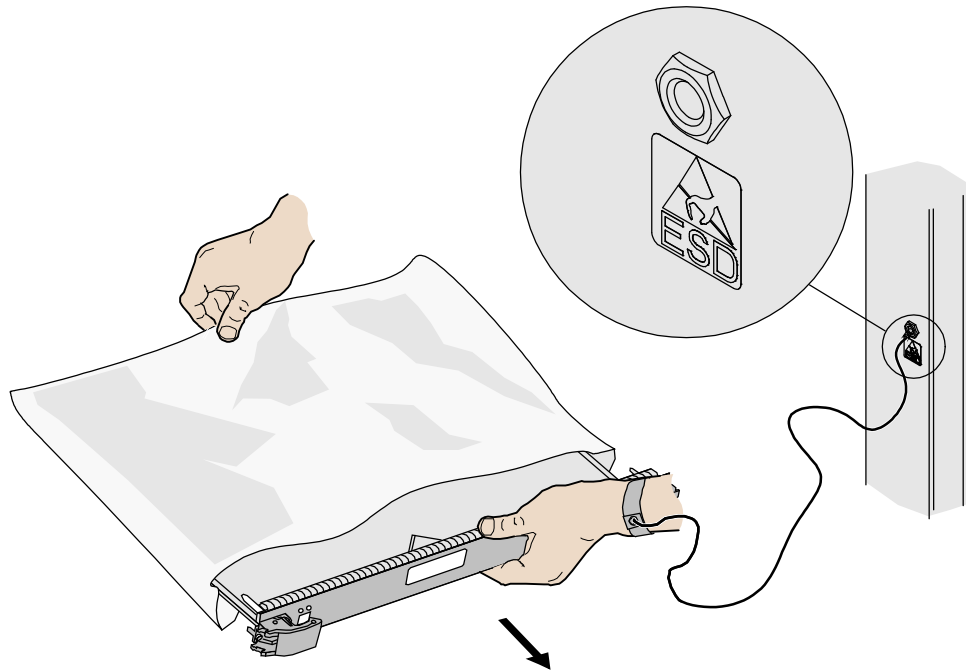

3.3 Inflammable Environment

Operating the electrical device in inflammable environment can be fatal.



DANGER

Do not place the device in the environment that has inflammable and explosive air or fog. Do not perform any operation in this environment.

3.4 Battery

3.4.1 Storage Battery



DANGER

Before handling the battery, read carefully the safety precautions to be taken for battery handling and connections.



CAUTION

Non-standard operation on batteries may result in danger.

During operation:

- Protect the battery against short-circuit
- Prevent electrolyte overflow and leakage

Electrolyte overflow may damage the device. It will corrode the metal parts and the circuit boards, and ultimately damage the device and cause short-circuit of the circuit boards.

General Operations

Before installing and maintaining the battery, note the following:

- Do not wear metal articles such as wristwatch, hand chain, bracelet and ring.
- Use special-purpose insulation tools.
- Take care to protect you eyes when operating the device.
- Wear rubber gloves and an apron in the case of electrolyte overflow.
- Always keep the electrode front upright when handling the battery. Do not place the battery upside down or tilt it.

Short-Circuit



WARNING

Battery short-circuit may cause physical injury. Though voltage of a general battery is low, high transient current generated by short-circuit will release a large amount of power.

There is danger of explosion if the battery is incorrectly replaced. Therefore, replace the battery only with the same or equivalent type recommended by the manufacturer.



CAUTION

Keep away metal objects, which may cause battery short-circuit, from batteries. If they have to be used, first disconnect the batteries in use before performing any other operations.

Harmful Gas



CAUTION

- Do not use unsealed lead-acid batteries, because the gas emitted from the battery may result in fire or device corrosion.
 - Lay the battery horizontally and fix it properly.
 - The battery in use will emit flammable gas. Therefore, put the battery in a place with good ventilation, and take fire precautions.
-

High Temperature



CAUTION

High temperature may result in distortion, damage and electrolyte overflow of the battery.

When the temperature of the battery exceeds 60°C, check whether there is acid liquid overflow. If acid liquid overflow occurs, handle the acid liquid immediately.

Acid Liquid



CAUTION

In case of acid liquid overflow, absorb and neutralize the liquid immediately.

When moving or removing a leaky battery, note the possible damage caused by the acid liquid. Once the acid liquid spill is found, use the following materials to absorb and neutralize it.

- Sodium bicarbonate (baking soda): NaHCO_3
- Sodium carbonate (soda): Na_2CO_3

The use of antacids must follow the guide provided by the battery supplier.

3.4.2 Lithium Battery



WARNING

- There is danger of explosion if the battery is incorrectly replaced. Therefore, replace the battery only with the same or equivalent type recommended by the manufacturer.
 - Dispose the used batteries according to the manufacturer's instructions.
 - Do not dispose of lithium battery in fire.
-

3.5 Laser

The laser hazard level of this device is *Class 1*.



WARNING

When handling optical fibers, do not stand close to, or look at the optical fiber outlet directly with unaided eyes.

3.5.1 General Laser Information

Laser transceivers or transmitters are used in the optical transmission system and associated test tools. The wavelength of the laser is between 780 nm and 1600 nm. Because the laser is transmitted through the optical fiber, it has very high power density and is invisible to human eyes. When a beam of light enters the eye, the retina may be damaged.

Laser of wavelengths used in telecommunications can cause thermal damage to the retina.

Lasers used in lightwave systems have a larger beam divergence, typically 10 to 20 degrees. Viewing an un-terminated fiber or damaged fiber with the unaided eye at distances greater than 150 mm (6 inches) will normally not cause eye injury. However, damage may occur if an optical tool such as a microscope, magnifying glass or eye loupe is used to view the energized fiber end.

In its normal operating mode, a lightwave system is totally enclosed and presents no risk of eye injury. Additional safety is achieved by an automatic laser shut-down (ALS) of the system. The ALS, however, can be applied for bi-directional transmission only. If the receiver side does not detect the laser from the transmission side, it will give the transmission side a signal. Upon receiving the signal, the ALS will shut down the laser emission within 100 ms.

3.5.2 Laser Safety Guidelines

Read the following guidelines to avoid laser radiation:

- Read the instructions before installing, operating and maintaining the device. Ignoring the instructions can cause exposure to dangerous laser radiation.
- Wear a pair of eye-protective glasses when you are handling lasers or fibers.
- All the operation shall be performed by personnel who have completed the approved training courses.
- Make sure that the optical source is switched off before disconnecting optical fiber connectors.
- Before opening the front door of an optical transmission system, make sure that you are not exposed to laser radiation.
- Do not look at the end of an exposed fiber or an open connector when you are not sure whether the optical source is switched off or not.
- Use an optical power meter to check and ensure that the optical source is switched off by measuring the optical power.
- Do not use an optical tool such as a microscope, a magnifying glass or an eye loupe to view the optical connector or fiber.

3.5.3 Handling Fibers

Read the instructions before handling fibers.

- Cutting and splicing fibers must be performed by the trained personnel only.
- Before cutting or splicing a fiber, ensure the fiber is disconnected from the optical source. After disconnecting the fiber, use protecting caps to protect all the optical connectors.

3.6 Working at Heights



WARNING

When working at heights, be careful to prevent objects from falling.

When working at heights, shall comply with the following requirements.

- The personnel who work at heights must be trained.
- The operating machines and tools shall be carried and handled safely to avoid falling.
- Safety protection measures, such as wearing a helmet and a safety belt, shall be taken.
- In cold regions, wear warm clothes when performing high-altitude operation.
- All lifting appliances must be thoroughly checked before the work is started.

3.6.1 Weight Lifting



WARNING

Do not access the areas under the jib arm and the goods in suspension when lifting weight.

- Ensure the operators have completed the related training and are qualified.
- Check the weight lifting tools and confirm that the tools are in good condition.
- Lift the weight only when the weight lifting tools are firmly fixed onto the weight-bearing object or the wall.
- Use a concise command to avoid incorrect operation.
- Ensure the angle between the two cables is less than or equal to 90 degrees during the lift. (see Figure 3-2).

Figure 3-2 Weight lifting

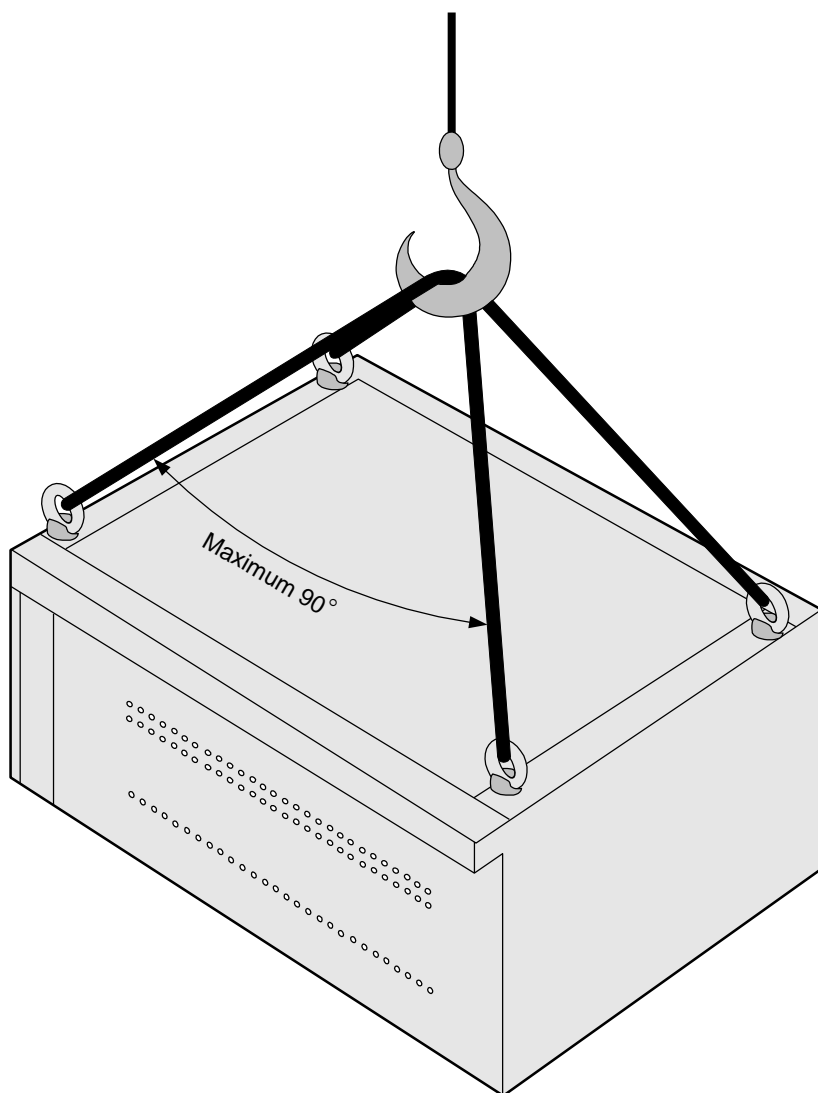

3.6.2 Safety Guide on Ladder Use

Checking the Ladder

Before using the ladder, first check if the ladder is in good condition. Make sure that you know the maximum weight that the ladder can support; overweight on the ladder is strictly prohibited.

Placing the Ladder

Slant angle is suggested to be 75 degrees. The slant can be measured with the angle square or with arms. When using a ladder, place the wider end of the ladder on the ground. Otherwise, take protective measures on the base part of the ladder to avoid skidding. Place the ladder on stable ground.

Climbing the Ladder

When climbing the ladder, note the following.

- Ensure the gravity center of your body does not deviate from the ladder edge.
- To lessen the danger and ensure the safety, hold your balance on the ladder before any operation.
- Do not climb higher than the fourth highest step of the ladder.
- If you are about to climb to the top, the length of the ladder shall be one meter higher than the eave.

3.7 Mechanical Safety

3.7.1 Drilling



WARNING

Drilling on the rack without permission is strictly prohibited. Drilling that does not satisfy the requirements concerned may damage the wires and cables inside the rack. If the metal shavings from the drilling fall into the rack, it may result in short circuit of the circuit boards.

-
- Before drilling a hole on the rack, wear insulation gloves, and remove the cables inside the rack.
 - During the drilling, ensure that your eyes are well protected. The hot shavings may injury to your eyes.
 - Ensure that the metal shavings do not get into the rack.
 - Non-standard drilling may damage the electromagnetic shielding performance of the rack.
 - After drilling, clean the metal shavings in time.

3.7.2 Sharp Objects



WARNING

When carrying the device by hand, wear protection gloves to avoid injury by sharp objects.

3.7.3 Handling Fans

Ensure the following:

- When replacing a component, place the component, screw, and tool at a safe place to prevent them from falling into the running fan.
 - When replacing the ambient equipment around the fan, do not place the finger or board into the running fan until the fan is switched off and stops running.
-



WARNING

- Only Huawei can open the device shell to maintain the fans.
 - Disconnect the power source prior to open case, and close case before restoring power which stated in the instruction.
 - Failure unit should be sent back to the manufacturer for repair by skilled person which stated in the instruction.
-

3.7.4 Lifting Heavy Objects



WARNING

When lifting heavy objects, do not stand or walk under the arm or the lifted object.

3.8 Miscellaneous

3.8.1 Inserting and Removing a Board

To insert or remove a board, abide by the following requirements:



CAUTION

When inserting a board, handle it gently to avoid distorting pins on the backplane.

- Insert the board along the slot guide.
- The two sides of one board should not contact another board to avoid short-circuit or scratch.
- When holding a board in hand, do not touch the board circuit, components, connectors, or connection slots.

3.8.2 Bundling Signal Cables



CAUTION

- Bundle the signal cables separately from the strong current cables or high voltage cables.
- Maintain a minimum space of 150 mm between adjacent ties.

3.8.3 Cabling Requirements

At a very low temperature, movement of the cable may damage the plastic skin of the cable. To ensure the construction safety, comply with the following requirements:

- When installing cables, ensure that the environment temperature is above 0°C.
- If cables are stored in the place below 0°C, move the cables into a place at a room temperature and store the cables for more than 24 hours before installation.
- Move the cables with care, especially at a low temperature. Do not drop the cables directly from the vehicle.

3.9 3G Antenna



CAUTION

- The product uses standard 3G antenna. Only qualified personnel can install and maintain the antennas.

4 Sicherheitsinformationen

Über dieses Kapitel

In der folgenden Tabelle ist der Inhalt dieses Kapitels aufgeführt.

Titel	Beschreibung
4.1 Überblick	Sicherheitsvorkehrungen, die vor der Installation und Wartung des Huawei-Geräts ergriffen werden müssen.
4.2 Elektrische Sicherheit	Informationen über die elektrische Sicherheit.
4.3 Feuergefährliche Umgebung	Informationen über die Sicherheit feuergefährlicher Umgebungen.
4.4 Batterie	Informationen über die Sicherheit der Batterie.
4.5 Laser	Sicherheitsmaßnahmen, wenn das Gerät und der Laser elektromagnetischen Feldern ausgesetzt sind.
4.6 Arbeiten in großen Höhen	Sicherheitsmaßnahmen, die vor Verwendung von Leitern oder vor dem Heben schwerer Gegenstände ergriffen werden müssen.
4.7 Mechanische Sicherheit	Sicherheitsmaßnahmen beim Bohren, bei scharfkantigen Gegenständen, beim Umgang mit Lüftern und beim Heben schwerer Gegenstände.
4.8 Verschiedenes	Sicherheitsmaßnahmen beim Einsetzen und Entfernen von Leiterplatten, beim Bündeln von Signalleitungen sowie Verkabelungsanforderungen.

4.1 Überblick

4.1.1 Sicherheitsmaßnahmen

Dieser Abschnitt beschreibt die Sicherheitsvorkehrungen, die vor der Installation und Wartung des Huawei-Geräts ergriffen werden müssen.

- Lesen Sie vor der Durchführung von Arbeiten die Bedienungsanleitung und die zu ergreifenden Vorsichtsmaßnahmen durch und befolgen Sie sie, um Unfälle zu verhindern. Die in anderen Dokumenten aufgeführten Symbole für Achtung, Warnung und Gefahr beinhalten nicht alle zu beachtenden Sicherheitsvorschriften. Sie dienen nur als Zusatzinformationen. Das Installations- und Wartungspersonal muss die grundlegenden Sicherheitsmaßnahmen kennen, die ergriffen werden müssen.
- Beachten Sie beim Betrieb des Geräts die örtlichen Sicherheitsvorschriften. Die in diesen Dokumenten angegebenen Sicherheitsmaßnahmen dienen nur als Ergänzung und müssen den örtlichen Sicherheitsvorschriften entsprechen.
- Befolgen Sie beim Betrieb des Huawei-Geräts neben den Vorsichtsmaßnahmen auch die von Huawei angegebenen spezifischen Sicherheitsanweisungen.
- Das Installations- und Wartungspersonal muss in den Sicherheitsmaßnahmen geschult werden. Nur qualifiziertes Fachpersonal darf das Gerät installieren oder warten.

4.1.2 Allgemeine Anforderungen

Um das technische Restrisiko zu minimieren, müssen die folgenden Regeln befolgt werden. Lesen Sie alle Anweisungen sorgfältig durch, bevor Sie mit dem Arbeiten beginnen.

Aufstellen

- Das Gerät (oder das System) darf nur an Orten mit beschränktem Zugang aufgestellt oder benutzt werden.
- Seien Sie vorsichtig, da die Oberfläche des Geräts während des Betriebs heiß wird. Wenn Sie die Oberfläche mit den Händen berühren oder den Griff des Geräts betätigen, sollten Sie zum Schutz Handschuhe tragen.
- Vor dem Betrieb muss das Gerät sicher auf dem Boden oder an anderen zuverlässigen Gegenständen befestigt sein, zum Beispiel an Wänden oder Montagegestellen.
- Beim Aufstellen der Einheit ist zuerst der Erdleiter anzuschließen. Beim Trennen ist er als letzter zu entfernen.
- Decken Sie Lüftungsöffnungen während des Betriebes nicht ab. Sorgen Sie für einen Abstand der Belüftungsöffnungen von mindestens 5 cm von Wänden oder anderen Gegenständen, die die Belüftung blockieren.
- Flügelmuttern und -schrauben sind nach der Erstinstallation und nach Wiederanbringung von Abdeckungen mit Hilfe von Werkzeug festzuziehen.

Erdung

- Beschädigen Sie den Erdleiter nicht und betreiben Sie das Gerät niemals ohne Erdung. Nehmen Sie Kontakt mit einem prüfenden Elektriker auf.
- Das Gerät (oder das System) muss vor der Inbetriebnahme permanent geerdet werden. Der Querschnitt des Schutzleiters muss mindestens 1,0 mm² betragen.

Energieversorgung

- Mit Wechselstrom betriebenes Modell: Die Steckdose muss sich in der Nähe des Geräts befinden und leicht zugänglich sein.
- Mit Wechselstrom betriebenes Modell: Das Gerät arbeitet mit einem TN oder TT-Stromversorgungssystem.
- Vorbereitete Leiter werden an den Klemmenblock angeschlossen und nur die entsprechende AWG/Kabelart wird mit den Kabelschuhen gesichert.
- Dieses Gerät benötigt eine Sicherung vor Kurzschluss (Überstrom) in der Gebäudeinstallation. Stellen Sie sicher, dass die Sicherungswerte auf allen Phasenleitern (alle stromführenden Leiter) nicht größer als 240 VAC, 20 A bei den mit Wechselstrom betriebenen Modellen sowie 80 VDC, 10 A bei den mit Gleichstrom betriebenen Modellen sind.
- Mit Wechselstrom betriebenes Modell: Die Stecker-Steckdosen-Verbindung muss jederzeit zugänglich sein, da sie die Netztrennstelle ist.
- Das Gerät hat mehrere Energiequellen, daher ist es notwendig, stets alle Verbindungen zu unterbrechen, um den energiefreien Zustand zu erreichen.
- Das mit Wechselstrom betriebene Modell hat eine Zweiphasen-Sicherung.
- Um die Brandgefahr zu minimieren, dürfen ausschließlich Nr. 26 AWG oder leistungsfähigere Telekommunikationskabel verwendet werden.

Personensicherheit

- Betreiben Sie das Gerät und die Kabel nicht während eines Gewitters.
- Um einen elektrischen Schlag zu vermeiden, dürfen Kleinspannungsschaltungen (SELV) nicht mit Telefonnetzwerken (TNV) verbunden werden.
- Blicken Sie nicht direkt in den optischen Anschluss, da die Laserstrahlung zu Augenverletzungen führen kann.
- Tragen Sie keinen Schmuck oder Uhren, wenn Sie am Gerät arbeiten.

Bediener

- Das Gerät darf nur von qualifiziertem Fachpersonal installiert, konfiguriert und zerlegt werden.
- Das Gerät darf nur von autorisierten Personen betrieben werden.
- Ein Austausch oder eine Änderung des Geräts oder der Teile des Geräts (einschl. der Software) darf nur von qualifiziertem Fachpersonal oder von Personen durchgeführt werden, die von Huawei autorisiert sind.
- Jeder Fehler und jede Störung, die die Sicherheit verletzen könnten, sind sofort den verantwortlichen Personen zu melden.
- Nur qualifiziertes Fachpersonal darf Sicherheitseinrichtungen beseitigen oder außer Betrieb setzen, und Fehlersuche oder Wartungsarbeiten durchführen.

Lesen und befolgen Sie alle Anweisungen sorgfältig, bevor Sie mit dem Arbeiten beginnen. Das Dokument enthält auch Richtlinien zur Auswahl der Mess- und Prüfinstrumente.

4.2 Elektrische Sicherheit

4.2.1 Hochspannung



GEFAHR

Hochspannungsleitungen stellen die für den Betrieb des Geräts erforderliche Energie zur Verfügung. Direkter oder indirekter Kontakt (durch feuchte Gegenstände) mit Hochspannung und Wechselstromversorgung kann zu tödlichen Unfällen führen.

- Während des Aufstellens der Wechselstromversorgungseinheit sind die lokalen Sicherheitsvorschriften einzuhalten. Das Personal für das Aufstellen der Wechselstromeinheit muss für Arbeiten an Hochspannung und Wechselstrom qualifiziert sein.
- Tragen Sie während der Arbeiten keine leitfähigen Gegenstände wie Uhren, Armreifen, Ketten oder Ringe.
- Sollte sich Wasser im Gestell befinden oder das Gestell feucht sein, ist die Energiezufuhr sofort zu unterbrechen.
- Stellen Sie sicher, dass das Gerät trocken ist, wenn die Arbeiten in einer feuchten Umgebung durchgeführt werden.



WARNUNG

Die Nichtbeachtung der Sicherheitsvorschriften bei der Arbeit mit Hochspannung kann zu Feuer und elektrischem Schlag führen. Deshalb muss die Verlegung von Leitungen und Verbindungen den örtlichen Anforderungen und Sicherheitsvorschriften entsprechen. Arbeiten mit Hochspannung dürfen nur von qualifiziertem Fachpersonal durchgeführt werden.

4.2.2 Gewitter



GEFAHR

Hochspannung und Betrieb mit Wechselstrom oder Arbeiten auf einem Stahlturm und -mast sind während Gewittern verboten.

Das elektromagnetische Feld, das während eines Gewitters entsteht, kann die Elektronik beschädigen. Um die Ausrüstung vor Beschädigung durch Blitzschlag zu schützen, ist eine ordnungsgemäße Erdung erforderlich.

4.2.3 Werkzeuge



WARNUNG

Vorschlag: Für Arbeiten mit Hochspannung und Wechselstrom sind Spezialwerkzeuge zu verwenden. Normale Werkzeuge dürfen nicht verwendet werden.

4.2.4 Hoher Kriechstrom



WARNUNG

Erden Sie das Gerät bevor Sie es anschalten. Es besteht sonst Gefahr für Menschen und das Gerät.

Wenn sich die Markierung „hoher Kriechstrom" am Leistungsanschluss des Gerätes befindet, müssen Sie das Gerät erden, bevor Sie es anschalten.

4.2.5 Zuleitung



WARNUNG

Eine Installation und ein Entfernen stromführender Leitungen ist verboten. Kurzschlüsse zwischen innerem und äußerem Leiter können Lichtbögen oder Funkenflug verursachen, was zu Feuer oder einer Augenverletzung führen kann.

- Das System muss stets abgeschaltet werden, bevor die Zuleitung angebracht oder entfernt wird.
 - Überprüfen Sie vor dem Anbringen der Zuleitung immer, ob das von Ihnen verwendete Kabel den Anforderungen entspricht.
-



VORSICHT

- Verwenden Sie für ein mit Wechselstrom betriebenes Gerät ein Stromversorgungskabel mit mind. 1,0 mm² oder 16 AWG.
 - Es sind Typ H03VVF oder eine leichte PVC-Schlauchleitung entsprechend IEC 60227 zu benutzen.
-

4.2.6 Sicherung



WARNUNG

Ersetzen Sie die Sicherung bei Bedarf immer nur mit einem Sicherungstyp, der die gleichen technischen Daten besitzt.

4.2.7 Elektrostatische Entladung



VORSICHT

Die vom menschlichen Körper erzeugte elektrostatische Elektrizität kann sensible elektrostatische Bauteile auf der Leiterplatte beschädigen, zum Beispiel integrierte Schaltkreise (ICs).

Der menschliche Körper erzeugt in den folgenden Situationen ein statisches elektromagnetisches Feld:

- Bei Bewegung
- Durch Reibung der Kleidung
- Durch Reibung zwischen den Schuhen und dem Boden
- Beim Halten von normalem Kunststoff in der Hand

Das statische elektromagnetische Feld bleibt lange Zeit im Körper.

Tragen Sie beim Berühren des Geräts, mit der Hand zu bedienenden Teilen, Leiterplatten oder ASICs ein geerdetes Armband zur elektrostatischen Entladung (ESD). Dies kann verhindern, dass empfindliche Bauteile durch statische Elektrizität im menschlichen Körper beschädigt werden.

Figure 4-1 zeigt das Tragen eines ESD-Armbandes.

Figure 4-1 Tragen eines ESD-Armbandes

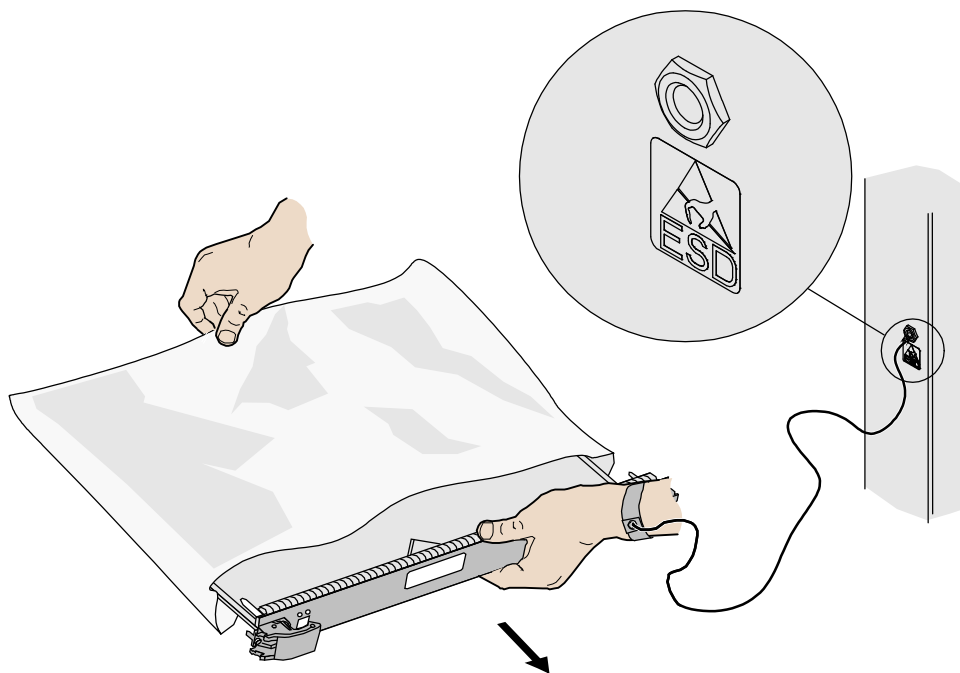

4.3 Feuergefährliche Umgebung

Jegliches Betreiben des elektrischen Gerätes in einer feuergefährlichen Umgebung verursacht Gefahr.



GEFAHR

Stellen Sie das Gerät nicht bei Umgebungsbedingungen auf, wo brennbare und explosive Luft oder Gase vorherrschen. Nehmen Sie bei diesen Umgebungsbedingungen das Gerät nicht in Betrieb.

4.4 Batterie

4.4.1 Speicherbatterie



GEFAHR

Lesen Sie vor dem Umgang mit der Batterie die Sicherheitsmaßnahmen sorgfältig durch, die beim Umgang mit der Batterie und beim Anschließen ergriffen werden sollen.



VORSICHT

Nicht vorschriftgemäße Arbeiten an den Batterien können Gefahren beinhalten.

Während des Betriebs:

- Schützen Sie die Batterie vor Kurzschluss.
- Verhindern Sie Überlaufen und Auslaufen der Elektrolytflüssigkeit.

Das Überlaufen von Elektrolytflüssigkeit kann das Gerät beschädigen. Es kann Metallteile und die Leiterplatten korrodieren und das Gerät beschädigen, sowie zu Kurzschlüssen in den Leiterplatten führen.

Allgemeiner Betrieb

Beachten Sie Folgendes während der Montage und Wartung von Batterien:

- Tragen Sie keine metallischen Gegenstände wie Uhren, Armreifen, Ketten und Ringe.
- Benutzen Sie isoliertes Spezialwerkzeug.
- Tragen Sie eine Schutzbrille während der Bedienung des Geräts.
- Tragen Sie Gummihandschuhe und eine Schürze für den Fall des Überlaufens von Elektrolytflüssigkeit.
- Halten Sie die Elektrode beim Umgang mit der Batterie immer senkrecht vor sich. Drehen Sie Batterie nicht um und kippen Sie sie nicht.

Kurzschluss



WARNUNG

Der Kurzschluss der Batterie kann Verletzungen zur Folge haben. Auch wenn die Spannung einer normalen Batterie gering ist, setzt hoher Übergangstrom, der durch einen Kurzschluss verursacht wird, eine große Menge Energie frei.

Bei unsachgemäßem Einsetzen der Batterie besteht die Gefahr einer Explosion. Ersetzen Sie die Batterie daher nur mit dem gleichen oder einem ähnlichem, vom Hersteller empfohlenen Batterietyp.



VORSICHT

Halten Sie metallische Gegenstände von der Batterie fern, die einen Kurzschluss verursachen könnten. Wenn sie verwendet werden müssen, trennen Sie zuerst die verwendeten Batterien, bevor Sie andere Arbeiten durchführen.

Gefährliches Gas



VORSICHT

- Verwenden Sie keine unversiegelten Bleisäurebatterien, da das Gas, das von der Batterie abgegeben wird, zu einem Feuer oder einer Korrosion des Geräts führen kann.
 - Legen Sie die Batterie horizontal hin und befestigen Sie sie richtig.
 - Die verwendete Batterie gibt brennbares Gas ab. Stellen Sie die Batterie deshalb an einem Ort mit guter Belüftung auf und ergreifen Sie Vorsichtsmaßnahmen gegen Feuer.
-

Hohe Temperatur



VORSICHT

Hohe Temperatur kann zu einem Verziehen, Schaden oder Überlaufen der Elektrolytflüssigkeit der Batterie führen.

Wenn die Temperatur der Batterie 60 °C übersteigt, sollten Sie prüfen, ob Säureflüssigkeit überläuft. Falls Säureflüssigkeit überläuft, beseitigen Sie die Säureflüssigkeit sofort.

Säureflüssigkeit



VORSICHT

Falls Säureflüssigkeit überläuft, absorbieren und neutralisieren Sie die Flüssigkeit sofort.

Beachten Sie beim Bewegen oder Entfernen einer auslaufenden Batterie den möglichen Schaden, der durch die Säureflüssigkeit verursacht werden kann. Wenn Sie verschüttete Säureflüssigkeit gefunden haben, verwenden Sie die folgenden Materialien, um sie zu absorbieren und zu neutralisieren.

- Natriumbikarbonat (Backpulver): NaHCO_3
- Natriumkarbonat (Soda): Na_2CO_3

Bei Verwendung von säurebindenden Mitteln müssen die Anweisungen des Batterielieferanten befolgt werden.

4.4.2 Lithium-Batterie



WARNUNG

- Bei unsachgemäßem Einsetzen der Batterie besteht die Gefahr einer Explosion. Ersetzen Sie die Batterie daher nur mit dem gleichen oder einem ähnlichem, vom Hersteller empfohlenen Batterietyp.
 - Entsorgen Sie verbrauchte Batterien gemäß den Anweisungen des Herstellers.
 - Verbrennen Sie Lithium-Batterien nicht.
-

4.5 Laser

Die von diesem Laser ausgehende Gefahr entspricht der *Klasse 1*.



WARNUNG

Halten Sie bei der Handhabung von optischen Fasern Abstand und schauen Sie nicht ohne Augenschutz in das Ende von optischen Fasern.

4.5.1 Allgemeine Informationen zum Laser

Lasersender und -empfänger werden in optischen Übertragungs- und Überwachungssystemen eingesetzt. Die Wellenlänge des Lasers beträgt zwischen 780 nm und 1600 nm. Die Laserenergie, die durch optische Fasern übertragen wird, hat eine sehr hohe Energiedichte. Das Laserlicht ist aber nicht sichtbar für das menschliche Auge. Wenn ein Lichtstrahl in das Auge eindringt, kann die Retina beschädigt werden.

Bei der im Telekommunikationsbereich genutzten Wellenlänge von Lasern kann die Retina durch Wärme geschädigt werden.

Laser, die in Lichtwellenleitersystemen verwendet werden, weisen eine größere Streuung des Lichtstrahls auf, typisch sind Werte zwischen 10° und 20°. Der versehentliche Blick in eine beschädigte oder nicht abgeschlossene optische Faser ohne Augenschutz aus einer Entfernung von mehr als 150 mm verursacht keine Verletzung der Augen. Es kann aber zu Augenverletzungen kommen, wenn optische Instrumente, wie z. B. ein Mikroskop, Vergrößerungsglas oder eine Lupe verwendet werden, um das spannungsführende Faserende zu betrachten.

Im normalen Betriebszustand ist ein LWL-System komplett abgeschlossen und stellt keine Gefahr von Augenverletzungen dar. Zusätzliche Sicherheit wird durch eine automatische Laserabschaltung (ALS) des Systems erreicht werden. Die ALS kann jedoch nur für bidirektionale Übertragung angewendet werden. Wenn die Empfängerseite den Laser von der Senderseite nicht erkennt, gibt er ein Signal an die Senderseite aus. Die ALS beendet die Lasersendung in weniger als 100 ms nach Erhalt des Signals.

4.5.2 Sicherheitsrichtlinien für Laser

Beachten Sie die folgenden Richtlinien, um Laserstrahlung zu vermeiden:

- Lesen Sie alle Anweisungen, bevor Sie das Gerät installieren, warten und in Betrieb nehmen. Die Nichtbeachtung dieser Anweisungen kann zu gefährlicher Laserstrahlung führen.
- Tragen Sie während des Umgangs mit den optischen Fasern oder mit dem Laser eine Schutzbrille.
- Die Bedienung darf nur durch Personal erfolgen, das die entsprechenden Schulungen absolviert hat.
- Vergewissern Sie sich, dass die optische Quelle abgeschaltet ist, bevor Sie die Verbindungen der optischen Fasern abklemmen.
- Bevor Sie die vordere Tür eines optischen Übertragungssystems öffnen, müssen Sie sicherstellen, dass Sie keiner Laserstrahlung ausgesetzt werden können.
- Sehen Sie niemals in das Ende einer freigelegten Faser oder in eine offene Verbindung, wenn Sie nicht sicher sind, dass die optische Quelle auch tatsächlich abgeschaltet ist.
- Messen Sie mit einem optischen Leistungsmesser die optische Leistung, um festzustellen, ob die optische Quelle ausgeschaltet ist.
- Benutzen Sie keine optischen Instrumente, wie z. B. ein Mikroskop, Vergrößerungsglas oder eine Lupe, um die Fasern oder die Verbindungen anzusehen.

4.5.3 Umgang mit Fasern

Lesen Sie die Anweisungen, bevor Sie mit den Fasern arbeiten.

- Schneiden und Verbinden von Fasern darf nur von geschultem Personal durchgeführt werden.
- Vergewissern Sie sich stets vor dem Trennen und Verbinden von Fasern, dass diese auch wirklich von der optischen Quelle getrennt wurden. Nach dem Abklemmen der Fasern müssen alle optischen Verbindungen durch spezielle Verschlusskappen geschützt werden.

4.6 Arbeiten in großen Höhen



WARNUNG

Achten Sie beim Arbeiten in großen Höhen darauf, dass keine Gegenstände herunterfallen.

Bei Arbeiten in großen Höhen sind folgende Anforderungen einzuhalten.

- Das in großer Höhe arbeitende Personal muss geschult sein.
- Der Betrieb von Maschinen und Werkzeugen muss sicher ausgeführt werden, um ein Herunterfallen zu vermeiden.
- Es müssen Sicherheitsmaßnahmen ergriffen werden, zum Beispiel das Tragen eines Helms und eines Sicherheitsgurts.
- Tragen Sie in kalten Gegenden warme Kleidung, wenn Sie Arbeiten in großer Höhe durchführen.
- Alle Hebegeräte müssen vor Beginn der Arbeiten sorgfältig überprüft werden.

4.6.1 Heben von großen Gewichten



WARNUNG

Betreten Sie beim Heben von großen Gewichten keine Bereiche unter dem Ausleger und hängenden Gegenständen.

- Stellen Sie sicher, dass die Bediener die entsprechenden Schulungen abgeschlossen haben und qualifiziert sind.
- Überprüfen Sie die Werkzeuge zum Heben des Gewichts und vergewissern Sie sich, dass die Werkzeuge in gutem Zustand sind.
- Heben Sie das Gewicht nur, wenn die Werkzeuge zum Heben des Gewichts fest an einem Gegenstand, der das Gewicht aushält, oder an einer Wand befestigt sind.
- Verwenden Sie einen knappen Befehl, um Fehlbedienung zu vermeiden.
- Stellen Sie sicher, dass der Winkel zwischen den zwei Kabeln während des Hebens höchstens 90 Grad beträgt. (siehe Figure 4-2).

Figure 4-2 Heben von großen Gewichten

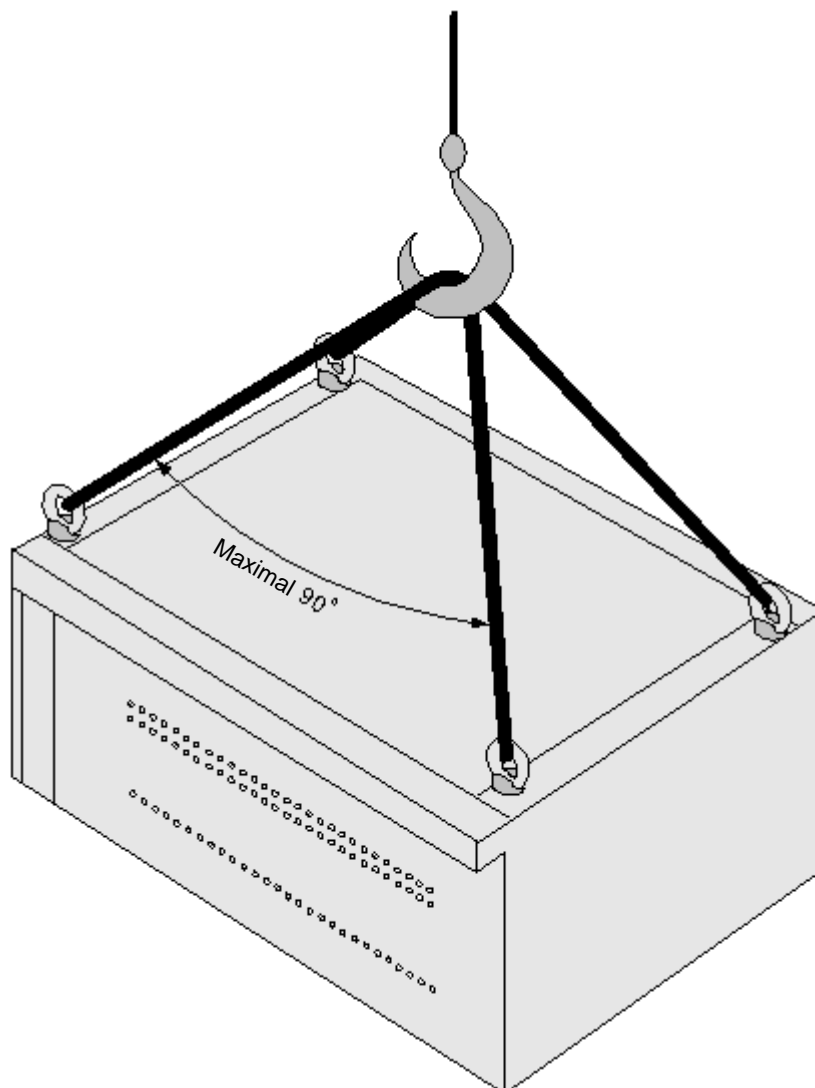

4.6.2 Sicherheitsleitfaden zur Verwendung von Leitern

Überprüfen der Leiter

Überprüfen Sie vor Verwendung der Leiter zuerst, ob die Leiter in gutem Zustand ist. Stellen Sie sicher, dass Sie das maximale Gewicht kennen, das die Leiter tragen kann. Ein Überlasten der Leiter ist strengstens verboten.

Aufstellen der Leiter

Der Neigungswinkel sollte 75 Grad sein. Die Neigung kann mit einem Winkelmesser oder mit den Armen gemessen werden. Stellen Sie bei Verwendung einer Leiter das breitere Ende der Leiter auf den Boden. Ergreifen Sie ansonsten Schutzmaßnahmen am unteren Teil der Leiter, um ein Rutschen zu verhindern. Stellen Sie die Leiter auf einen stabilen Boden.

Besteigen der Leiter

Beachten Sie beim Besteigen der Leiter Folgendes.

- Stellen Sie sicher, dass der Schwerpunkt Ihres Körper nicht jenseits des Randes der Leiter liegt.
- Um die Gefahr zu verringern und die Sicherheit zu gewährleisten, sollten Sie vor der Durchführung irgendwelchen Arbeiten sicher auf der Leiter stehen.
- Steigen Sie nicht höher als die vierthöchste Stufe der Leiter.
- Wenn Sie ganz nach oben klettern, sollte die Länge der Leiter einen Meter höher als die Traufe sein.

4.7 Mechanische Sicherheit

4.7.1 Bohren



WARNUNG

Bohren auf dem Gestell ohne Erlaubnis ist strengstens verboten. Bohren, das die entsprechenden Anforderungen nicht erfüllt, kann die Drähte und Kabel im Gestell beschädigen. Wenn Metallspäne aufgrund des Bohrens in das Gestell fallen, kann dies zu einem Kurzschluss der Leiterplatten führen.

- Tragen Sie beim Bohren eines Lochs am Gestell isolierte Handschuhe und entfernen Sie die Kabel im Gestell.
- Stellen Sie während des Bohrens sicher, dass Ihre Augen geschützt sind. Heiße Späne können Ihre Augen verletzen.
- Stellen Sie sicher, dass keine Metallspäne in das Gestell gelangen.
- Nicht vorschriftsgemäßes Bohren kann die elektromagnetische Abschirmung des Gestells beschädigen.
- Entfernen Sie die Metallspäne nach dem Bohren umgehend.

4.7.2 Scharfkantige Gegenstände



WARNUNG

Tragen Sie, wenn Sie das Gerät von Hand transportieren, Schutzhandschuhe, um Verletzungen durch scharfkantige Gegenstände zu vermeiden.

4.7.3 Umgang mit Ventilatoren

Stellen Sie Folgendes sicher:

- Stellen Sie beim Austauschen eines Bauteils das Bauteil, die Schrauben und das Werkzeug an einen sicheren Ort, um zu verhindern, dass sie in den laufenden Lüfter fallen.
- Stecken Sie beim Austauschen der Umgebungsvorrichtungen rund um den Lüfter nicht Ihre Finger oder die Leiterplatte in den laufenden Lüfter. Warten Sie, bis der Lüfter ausgeschaltet ist und nicht mehr läuft.



WARNUNG

- Nur Huawei kann das Gerätegehäuse zur Wartung der Gebläse öffnen.
 - Vor dem Öffnen des Gehäuses muss die Stromversorgung getrennt werden. Vor der Wiederherstellung der Stromversorgung muss das Gehäuse wieder geschlossen werden.
 - Die defekte Einheit muss zurück zum Hersteller geschickt werden, damit sie von fachlich qualifizierten Techniker repariert werden kann.
-

4.7.4 Heben schwerer Gegenstände



WARNUNG

Stehen oder gehen Sie beim Heben schwerer Gegenstände nicht unter dem Arm oder dem gehobenen Gegenstand.

4.8 Verschiedenes

4.8.1 Einsetzen und Entfernen von Leiterplatten

Beachten Sie beim Einsetzen und Entfernen von Leiterplatten die folgenden Anforderungen:



VORSICHT

Behandeln Sie Leiterplatten beim Einsetzen vorsichtig, um ein Verdrehen der Stifte auf der Rückseite zu verhindern.

- Setzen Sie Leiterplatten nur entlang der Führungsschlitze ein.
- Die zwei Seiten einer Leiterplatte sollten keine andere Leiterplatte berühren, um Kurzschlüsse oder Kratzer zu verhindern.
- Berühren Sie die Leiterplatte, Bauteile, Anschlüsse oder Anschlussschlitze nicht, wenn Sie eine Leiterplatte in der Hand halten.

4.8.2 Bündeln von Signalleitungen



VORSICHT

- Bündeln Sie die Signalleitungen getrennt von Starkstromkabeln oder Hochspannungskabeln.
 - Benutzen Sie Kabelbinder in einen Abstand von maximal 150 mm.
-

4.8.3 Verkabelungsanforderungen

Bei sehr niedrigen Temperaturen kann eine Bewegung der Kabel die Kunststoffhülle der Kabel beschädigen. Um die Bausicherheit zu gewährleisten, befolgen Sie die nachfolgenden Anordnungen:

- Stellen Sie beim Installieren von Kabeln sicher, dass die Umgebungstemperatur über 0 °C liegt.
- Wenn Kabel an Orten unter 0 °C aufbewahrt werden, sollten Sie die Kabel an einen Ort mit Raumtemperatur transportieren und dort die Kabel vor der Installation mindestens 24 Stunden aufbewahren.
- Bewegen Sie die Kabel vorsichtig, besonders bei niedrigen Temperaturen. Lassen Sie die Kabel nicht direkt vom Fahrzeug fallen.

4.9 3G Antenne



VORSICHT

- Das Produkt verwendet eine Standard-3G-Antenne. Antennen dürfen nur von qualifiziertem Personal montiert und gewartet werden.
-