



HUAWEI C5610
CDMA 1X Mobile Phone

USER GUIDE

**Copyright © Huawei Technologies Co., Ltd.
2010. All rights reserved.**

No part of this document may be reproduced or transmitted in any form or by any means without prior written consent of Huawei Technologies Co., Ltd.

The product described in this manual may include copyrighted software of Huawei Technologies Co., Ltd and possible licensors. Customers shall not in any manner reproduce, distribute, modify, decompile, disassemble, decrypt, extract, reverse engineer, lease, assign, or sublicense the said software, unless such restrictions are prohibited by applicable laws or such actions are approved by respective copyright holders under licenses.

Trademarks and Permissions



HUAWEI, HUAWEI, and



are trademarks or registered trademarks of Huawei Technologies Co., Ltd.

Other trademarks, product, service and company names mentioned are the property of their respective owners.

Notice

Some features of the product and its accessories described herein rely on the software installed, capacities and settings of local network, and may not be activated or may be limited by local network operators or network service providers, thus the descriptions herein may not exactly match the product or its accessories you purchase.

Huawei Technologies Co., Ltd reserves the right to change or modify any information or specifications contained in this manual without prior notice or obligation.

NO WARRANTY

THE CONTENTS OF THIS MANUAL ARE PROVIDED "AS IS". EXCEPT AS REQUIRED BY APPLICABLE LAWS, NO WARRANTIES OF ANY KIND, EITHER EXPRESS OR IMPLIED, INCLUDING BUT NOT LIMITED TO, THE IMPLIED WARRANTIES OF MERCHANTABILITY AND FITNESS FOR A PARTICULAR PURPOSE, ARE MADE IN RELATION TO THE ACCURACY, RELIABILITY OR CONTENTS OF THIS MANUAL.

TO THE MAXIMUM EXTENT PERMITTED BY APPLICABLE LAW, IN NO CASE SHALL HUAWEI TECHNOLOGIES CO., LTD BE LIABLE FOR ANY SPECIAL, INCIDENTAL, INDIRECT, OR CONSEQUENTIAL DAMAGES, OR LOST PROFITS, BUSINESS, REVENUE, DATA, GOODWILL OR ANTICIPATED SAVINGS.

Import and Export Regulations

Customers shall comply with all applicable export or import laws and regulations and will obtain all necessary governmental permits and licenses in order to export, re-export or import the product mentioned in this manual including the software and technical data therein.

Conventions

Term Conventions

This manual refers to HUAWEI C5610 CDMA 1X mobile phone as "the phone" or "your phone".



Operation Conventions

Operation	Meaning
Press and hold	Press a key for two to three seconds and then release it.
Press	Press a key and release it quickly.

GUI Conventions

Format	Meaning
Bold	Any string displayed on the phone screen is in boldface, such as " Menu ".
>	Multi-level menus are separated by ">". For example, " Menu > Messages " indicates " Messages " is the submenu of " Menu ".

Symbols

Symbol	Description	Meaning
	Caution	Warnings and precautions for operations
	Note	Complementary descriptions for operations

Contents

1 Getting to Know Your Phone	1
Your Phone.....	1
Interfaces.....	2
Keys and Functions.....	3
Screen Icons.....	5
2 Getting Started	7
Installing the Battery.....	7
Installing the MicroSD Card.....	7
Charging the Battery.....	8
Powering On/Off the Phone.....	9
Using a Function Menu.....	9
3 Voice Services	11
Making a Call.....	11
Answering a Call.....	12
Operations During a Call.....	12
4 Text Entry.....	14
Text Input Modes.....	14
Entering English.....	14
Entering Spanish.....	16
Entering Numbers.....	16
Entering Symbols.....	16

5 SMS	18
Writing and Sending a Text Message	18
Reading a Text Message	19
6 MMS.....	21
Writing and Sending a Multimedia Message.....	21
Receiving a Multimedia Message.....	21
Viewing a Multimedia Message	22
7 Contacts	23
Adding a Contact	23
Searching for a Contact.....	23
8 Music	25
Adding the Playlist.....	25
Playing Music	25
Setting the Playing Mode and Effect	26
Listening to Music Through a Bluetooth Stereo Headset.....	27
9 Video Player.....	28
Selecting a Video File	28
Playing a Video File.....	28
10 Camera.....	30
Taking a Photo	30
Viewing a Photo.....	32

11 Video Camera	34
Recording a Video Clip.....	34
Playing a Video Clip	36
12 Recorder	37
Recording a Sound Clip.....	37
Playing a Sound Clip	37
13 Radio	39
Switching On/Off the FM Radio	39
14 Bluetooth®	41
Sending Data Through the Bluetooth Connection.....	42
Receiving Data Through the Bluetooth Connection.....	43
Other Bluetooth Operations	44
15 Alarm Clock	45
Enabling an Alarm Clock.....	45
Disabling an Alarm Clock.....	46
16 Security	47
Enabling/Disabling the Phone Lock	47
Changing the Phone Lock Code	47
Locking the Keypad	48
17 Warnings and Precautions	49

1 Getting to Know Your Phone

Your Phone

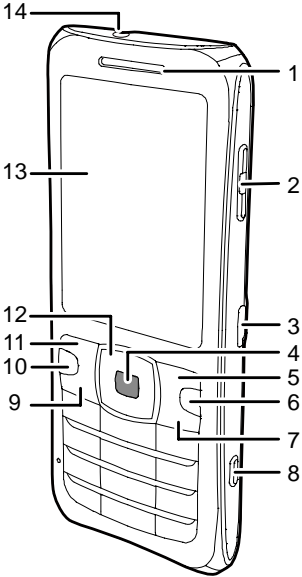







- | | |
|-----------------------|--------------------|
| 1 Earpiece | 8 Camera key |
| 2 Volume control keys | 9 Talk/Send key |
| 3 Charger interface | 10 Media key |
| /Data cable connector | |
| 4 Confirm key | 11 Left soft key |
| 5 Right soft key | 12 Navigation keys |
| 6 Delete key | 13 Screen |
| 7 End/Power key | 14 Headset jack |

Interfaces

Interface	Description
Charger interface /Data cable connector	Located on the right side of the phone. You can connect the charger or the data cable to it.
Headset jack	Located on the top of the phone. You can connect the headset with the 3.5 mm connector to it.
MicroSD card slot	Located on the left side of the phone. You can insert a micro Secure Digital (microSD) card into it.

Keys and Functions

Press...	To...
	<ul style="list-style-type: none">• View the call log in standby mode.• Make a call or answer an incoming call.
	<ul style="list-style-type: none">• Power on or off the phone (by pressing and holding it).• End a call or reject an incoming call.• Return to the standby mode.
 (Left)	<ul style="list-style-type: none">• Select the option displayed in the lower left corner of the screen.• Display Menu in standby mode.
 (Right)	<ul style="list-style-type: none">• Select the option displayed in the lower right corner of the screen.• Display Contacts in standby mode.
	Delete a character in editing mode or delete a selected item in an application.
	<ul style="list-style-type: none">• Enter *, +, P, or T by pressing it once, twice, three times, or four times.• Switch between the Meeting profile and the current profile (by pressing and holding it).
	<ul style="list-style-type: none">• Enter #.• Lock the keypad (by pressing and holding it).• Change the text input mode when editing text.



Display **Media Player** in standby mode.



- Enter numbers, letters, and symbols.



- Call the voice mail center in standby mode (by pressing and holding the **1** key).



- Speed-dial phone numbers in standby mode (by pressing and holding the **2-9** keys).

- Select a submenu item labeled with the corresponding number.





- Display **Menu** in standby mode.

- Confirm a selection.

















: Access **Blue Tooth** in standby mode; increase the volume during a call.







: Access **Messages** or access **Create Message** (by pressing and holding it) in standby mode; decrease the volume during a call.

: Access **BREW** in standby mode; decrease the volume during a call.

: Access **WAP** in standby mode; increase the volume during a call.

Screen Icons

Icon	Indicates...
	Signal strength. The more the bars are, the stronger the signal is.
	CDMA2000 1X network is activated.
	There is an incoming call; a call is being set up; there is an ongoing call.
	The SMS inbox is full.
	A new text message is received.
	A new multimedia message is received.
	The MMS inbox is full.
	A new voice mail is received.
	A new emergent message is received.
	The microSD card is properly installed.
	The microSD card is not properly installed or is damaged.
	The Bluetooth function is enabled.
	An alarm clock is enabled.
	The General profile is enabled.
	The Silence profile is enabled.

Icon	Indicates...
	The Meeting profile is enabled.
	The Outdoor profile is enabled.
	The My Profile 1 profile is enabled.
	The My Profile 2 profile is enabled.
	Battery power level. The more the bars are, the more the battery power is.
	The battery power level is extremely low.

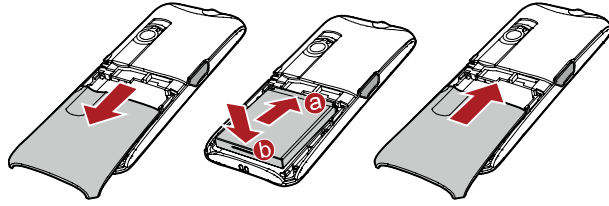

2 Getting Started

Installing the Battery

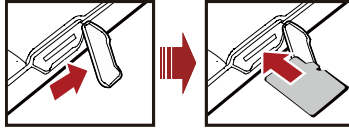

Installing the microSD Card



After the microSD card is properly installed,  is displayed on the screen. If  is displayed, it indicates that the microSD card is not installed properly or is damaged. Then you need to check your microSD card.



- Install the microSD card properly to prevent your phone or microSD card from being damaged.

Your phone can work with a microSD card of up to 2 GB.

Charging the Battery

To charge the battery, do as follows:

1. Connect the charger to the charger interface at the bottom of the phone.

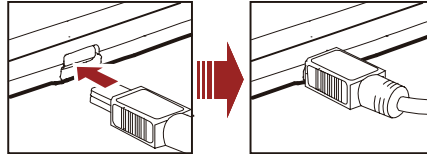

2. Connect the charger to an AC power socket.

During the charging,  appears in the upper right corner of the screen in an animated status.

3. Wait until the phone is fully charged.

When  becomes static, the battery is fully charged.



4. Disconnect the charger from the AC power socket.

5. Disconnect the charger from the phone.











- Do not use a damaged battery or charger.
- Before charging the battery with the travel charger, ensure that the battery is installed in your phone.

Powering On/Off the Phone

- When the phone is powered off, press and hold  to power it on.
- When the phone is powered on, press and hold  to power it off.

Using a Function Menu











To use a function menu, do as follows:

1. In standby mode, press  (**Menu**).
2. Press  to select the desired function menu.
3. Press  (**Select**) or  to display the selected menu.
4. Display the submenu in either of the following ways:
 - Press  to select a submenu, and then press  (**Select**) or  to display the selected submenu.
 - Press the number key corresponding to the serial number of a submenu to display the submenu.
5. Press  (**Back**) to return to the previous menu or exit the function menu.





To return to the standby mode, press .





3 Voice Services

Making a Call

- In standby mode, enter the phone number.
 - To make an international call, press  twice consecutively to enter a plus sign (+). Then enter the international long-distance code, country code or region code, area code, and phone number in sequence.
 - To call an extension, enter the phone number, press  three times consecutively to insert **P** or press  four times consecutively to insert **T**, and then enter the extension number.
 - Press  to dial the number.
 - Press  or  (**End**) to end the call.
-  • In standby mode, press  to select the required number from **All Calls**. Then press  to dial the number.
- When the phone is locked, enter the lock code to unlock the phone first; otherwise, you can only make emergency calls or answer calls.
 - Select a contact from the phonebook and press  to dial the number.
 - Select a message from the inbox and press  to dial the number.



Answering a Call

When there is an incoming call, you can press ,  (**Answer**), or  to answer it; press  to reject it.

- When there is an incoming call, you can press  (**Silence**) to mute the speaker, and then press  (**Reject**) again to reject it. If the phone is in **Silence** mode, you can press  (**Reject**) to reject it.
- If the any-key answer function is enabled, you can press any key except  and  to answer an incoming call.
- If the headset auto-answer function is enabled and the headset is connected to the phone, the incoming call is answered automatically.

 To set the any-key answer function, select **Settings > Call Settings > Answer Mode**. To set the headset auto-answer function, select **Settings > Call Settings > Headset Auto Answer**.

Operations During a Call

You can press  to enable or disable the speaker, and press  (**Options**) for the following options:

- **Mute/Unmute**: allows you to mute or unmute your voice during a call. When you access the **Options** menu for the first time, the option is **Mute**. If you select it, the other party cannot hear you. If you access the **Options** menu again, the option is **Unmute**. If you select it, the other party can hear you again. This function is available only after the call is set up. You cannot mute/unmute the ringtone.





- **Start Record:** allows you to record the call. You can select **This Side** or **The Other Side**.
- **Save Number:** allows you to enter a phone number and save it to the phonebook.
- **Contacts:** allows you to search for or create a contact.
- **Messages:** allows you to access the **Messages** screen.
- **Call Memo:** allows you to access the **Call Memo** screen.
- **Voice privacy:** allows you to set the privacy mode, including **Activate** and **Deactivate**.

4 Text Entry

Text Input Modes

The indicator of the current input mode is displayed in the upper left corner of the screen. You can press  to change the input mode.

Indicator	Text Input Mode
En	Smart English input mode
Smsp	Smart Spanish input mode
Es	Traditional Spanish input mode
Abc	Traditional English input mode
123	Number input mode

 In editing mode, press  once to delete the character on the left of the cursor. Alternatively, press and hold  to clear all characters at a time. If there is no character to delete, you can press  (**Back**) to return to the previous menu.

Entering English



■ Smart English Input Mode (En)

You can enter English letters as follows:



1. Based on the sequence of the word, press the key labeled with the desired letter once.
Then the phone displays the commonly used words according to the numeric sequence of key presses.

2. Press  to view alternative words.

3. Press  to switch between uppercase and lowercase letters.

4. Press  or  to confirm the selection.

You can also press  to confirm the selection followed by a space.



- Press  to enter a full stop or another commonly used punctuation.
- Press  to enter a space, and press and hold it to enter 0.
- Press  to display the symbol list. Then you can select and enter a symbol.

■ Traditional English Input Mode (Abc)

The alphabetical text input mode allows you to enter uppercase or lowercase English letters. You can press the key labeled with the desired letter once to enter the first letter on the key, twice to enter the second letter on the key, and so on.

When you enter letters, press  to switch between uppercase and lowercase of the highlighted letter.

If the letter you want to enter is on the same key as the previous one, you can enter the latter only after the cursor appears again or press  to move the cursor to the next space.

- Press  consecutively to enter a commonly used punctuation.
- Press  once to enter a space, twice to enter 0.

Entering Spanish

You can enter Spanish words in Spanish text input mode.

The traditional Spanish input mode (Es) and the smart Spanish (Smsp) input mode are similar to the traditional English input mode and the smart English input mode. For details, see "Entering English" on page 14.





Entering Numbers

- In "123" input mode, press number keys to enter numbers.
- In "Abc" or "Es" input mode, press a number key consecutively until the number appears.
- In "En" or "Smsp" input mode, press a number key and then press

 until the number appears.

Entering Symbols

In any input mode, you can enter a symbol as follows:

1. Press  to display a symbol list.
2. Press  to select a symbol.
3. Press  (**Select**) or , or press the corresponding number key to enter the symbol.

5 SMS

Writing and Sending a Text Message

To write and send a text message, do as follows:

1. Select **Menu** > **Messages** > **SMS** > **Create Message**.

You can also access the **Create Message** screen by pressing and holding



in standby mode.





2. Write a text message with up to 160 English letters or 160 Spanish letters.

When writing a text message, press  (**Options**) for the following options:

- **Send:** allows you to send the message.
- **Save:** allows you to save the message to **Drafts**.
- **Insert Quick Text:** allows you to insert a commonly used phrase.
- **Insert Contact:** allows you to select a contact from the phonebook and insert the phone number into the message.
- **Insert Special Symbol:** allows you to insert a website-related symbol, such as **http://**.
- **Priority:** allows you to set the priority of messages sent to the recipients. The priorities are **Normal** and **Urgent**. This function is network dependent.
- **Callback Number:** allows you to set the callback number. The callback number is sent to the message recipient by default. You



can set it to either your phone number or other numbers. When the recipient receives your message, the callback number can be viewed for calling you back.

Select **Activate** and enter the phone number.

3. On the text editing screen, press  or select **Options > Send**.
4. Enter the phone number of a recipient.
Up to 100 recipients can be added by using one of the following methods:
 - Enter the phone number(s) directly.
 - Press  (**Search**). Then select **Contacts** to select the phone number(s).
 - Press  (**Search**). Then select **Groups** to select a group.
5. Press  to send the message.

Reading a Text Message

To read a text message stored in the inbox, do as follows:



1. Select **Menu > Messages > SMS > Inbox**.
2. Press  to select a message.
3. Press  to read the message, or press  (**Options**) for the following options:
 - **View**: allows you to read the message.
 - **Reply**: allows you to edit a message to reply to the message sender.

- **Delete:** allows you to delete the message.
 - **Delete Multiple:** allows you to delete multiple messages at a time.
 - **Forward:** allows you to forward the message.
 - **Extract:** allows you to extract the numbers contained in the message or the number of the message sender. Then you can select **Edit Before Call, Call, or Save.**
-  • Your phone supports sending and receiving of long text messages beyond the character limit for a single message. The duration of receiving a complete long message depends on the network condition. When a long message cannot be completely displayed, select and read the long message again until the whole message content is received.
- Long messages can be saved in the phone memory only.

6 MMS

Writing and Sending a Multimedia Message

1. Select **Menu** > **Messages** > **MMS** > **Create MMS**.
2. Edit a multimedia message by setting the following fields:
 - **Recipient:** allows you to enter recipients of the message. You can add up to 20 recipients.
 - **Subject:** allows you to enter the subject of the message.
 - **Slide:** allows you to insert images, audio files, video files, and texts into a slide. You can set the duration of displaying each slide for your preview.
 - **Timing:** allows you to set the duration of switching the slides.

 The capacity of a multimedia message can be up to 300 KB, including the slides.
3. After you write the message, select **Options** > **Send** or press  to send it.

Receiving a Multimedia Message

If you select **MMS** > **Settings** > **Receive options** > **Download timing** > **Manual**, a notification is sent to the inbox before you receive a multimedia message. Then you can press  to view the notification and select **Options** > **Receive** to receive the multimedia message.



If you select **MMS > Settings > Receive options > Download timing > Automatic**, the multimedia message is downloaded to the inbox directly.

Viewing a Multimedia Message

To view a multimedia message stored in the inbox, do as follows:

1. Select **Menu > Messages > MMS > Inbox**.

2. Press  to select a message.



3. Press  to view details of the message, or press  (**Options**) for the following options:

- **Open:** allows you to view details of the message.
- **Reply:** allows you to reply the message to the message sender.
- **Reply all:** allows you to reply the messages to the message sender and all other message recipients.
- **Forward:** allows you to forward the message.
- **Move:** allows you to move the message(s) to **My folders**.
- **Delete:** allows you to delete the message.
- **Delete all:** allows you to delete all the messages in the inbox.
- **Sort:** allows you to sort the messages in the inbox according to **Date** or **Address**.
- **Filter view:** allows you to specify the message(s) to be viewed.

7 Contacts



Adding a Contact





To add a contact, do as follows:

1. Select **Menu** > **Contacts** > **Add New**.
2. Press  to enter information in **Name**, and then press  (**OK**).
3. Enter the necessary information of a contact.
You can enter information in **Mobile Number**, **Home Number**, **Office Number**, and **Fax Number** (at least one of the fields should be entered with a number). You can also enter the email and notes of the contact, and select a group, a custom tone, and an image for the contact.
4. Press  (**Save**) to save the contact to the phonebook.









Searching for a Contact

To search for a contact, do as follows:

1. Select **Menu** > **Contacts** > **Search**.
2. Enter the name of the contact. Then press  (**Search**) or .
3. After the search, press  (**Options**) for the following options:
 - **View**: allows you to view details of the contact.
 - **Edit**: allows you to edit the contact.
 - **Add New**: allows you to add a new contact.



- **Send Message:** allows you to send a message to the contact.
 - **Send Via Bluetooth:** allows you to send the contact through Bluetooth.
 - **Delete:** allows you to delete the contact.
 - **Call:** allows you to call the contact.
 - **Edit Before call:** allows you to modify the number before you call it.
-  • In standby mode, press  to access **Contacts List**.
- To quickly search for a contact, you can press the number key (except  and ) to enter the first letter of the contact name. Then the phone lists contacts that start with the letter.











Adding the Playlist

1. In standby mode, select **Menu > Multimedia > Media Player** or press  to launch the media player.
2. Press  (**Options**) and select **Current playlist** to set the current playlist.
3. Press  (**Options**) and select **Refresh** to refresh the playlist.
4. On the **All Tracks** screen, press  to select a song. Then press  to add the selected song to the playlist. Press  again to cancel the selection.
5. Press  (**Play**) to save and start playing the playlist.
Press  (**Add to Playlist**) to create a new playlist or add songs to an existing playlist.



Playing Music

On the **Media Player** screen, you can do as follows:

1. Press  to play a song.
- Press  to play the next song.

- Press and hold  to fast forward the song.
 - Press  to play the previous song.
 - Press and hold  to rewind the song.
 - Press  to pause the song; press  again to continue playing.
 - Press  to load the current playlist.
 - Press  to stop playing.
2. Press  (**Minimize**) to return to the **Multimedia** screen.
You can use other functions while the phone is playing .mp3 files.
 3. Press  to return to the standby mode and the music is still playing.
 4. On the **Media Player** screen, select **Options** < **Off** to switch off the media player.
-  When the media player is paused or stopped, you can press  to directly exit the media player.



Setting the Playing Mode and Effect

1. In standby mode, select **Menu** > **Multimedia** > **Media Player** or press  to launch the media player.
 2. Press  (**Options**) and select **Settings** for the following options:
- 26

- **Equalizer:** allows you to set the equalizer.
- **Loop:** allows you to set the loop mode.
- **Shuffle:** allows you to enable or disable the shuffle mode.
- **GUI style:** allows you to select a GUI style that can be **Simple Mode**, **Waveform Mode**, or **Lyric Mode**.







Listening to Music Through a Bluetooth Stereo Headset

You can listen to music on the phone through a Bluetooth stereo headset.

1. In **standby mode**, select **Menu > Multimedia > Media Player** or press  to launch the media player. Then switch on your Bluetooth headset for pairing.
2. Select **Options > Play via Bluetooth**.
3. When the phone displays "**Switch On Bluetooth?**", select **Yes** to access the device list.
4. Press  (**Search**) to begin searching for new Bluetooth devices. In the list of newly found devices, select the corresponding Bluetooth headset. Then select **Options > Pair** to access the screen for pairing devices.
5. Enter the password for pairing the Bluetooth headset and press **OK**.
6. After the phone sets up a Bluetooth connection, you can listen to music through the Bluetooth stereo headset.



9 Video Player









Selecting a Video File

1. In standby mode, select **Menu > Multimedia > Gallery > Videos**.
 2. Press  to select the phone or the microSD card as the memory in use.
 3. Press  (**Options**) and select **Open**, or press  to open the video folder.
 4. Press  to select the video file to be played. Then press  (**Options**) and select **Play**, or press  to play the selected video file.
-  If you want to select a video file from the microSD card, the microSD card must be inserted into your phone beforehand.

Playing a Video File

On the video player screen, you can do as follows:

- Press  to play a video file.
- Press  to play the next video file.

- Press and hold  to fast forward the video file.
- Press  to play the previous video file.
- Press and hold  to rewind the video file.
- Press  to pause the video file; press  again to continue playing.
- Press  to stop playing.
- Press  to play the video file in full screen mode.
- Press  (**Back**) to switch off the video player and return to the previous menu.

10 Camera

Taking a Photo

1. In standby mode, select **Menu > Camera** to access the preview mode.

-  The phone can memorize the screen (camera or video camera screen) that it displayed last time.



For example, you launch the camera, press  to enter the video camera screen, and then exit. When you launch the camera next time, the phone displays the video camera screen.

2. Press  (**Options**) for the following options:



- **Switch to Video Camera:** allows you to use the video camera on your phone. For details, see "Video Camera" on page 34.

You can also switch to the video camera by pressing  in preview mode.

- **Shot Mode:** allows you to set the shot mode. If you select **4 Shots** or **9 Shots**, the phone takes photos sequentially; if you select **Normal**, the multi-shot mode is disabled.
- **Resolution:** allows you to select a resolution.
- **Frame:** allows you to select a fun frame for photos.
- **Self Timer:** allows you to set the countdown for the phone to take a photo automatically. You can set the self timer to **5 Seconds**, **10 Seconds**, or **Off**.







- **Night Mode:** allows you to enable or disable the night mode.
 - **Effect:** allows you to set the effect.
 - **Shortcut Guide:** allows you to view the shortcut keys.
 - **Settings:** allows you to set **Quality, Shot Tone, Timer Reminder, Save Location, and Reset All.**
 - **Goto Gallery:** allows you to access the **Menu > Multimedia > Gallery > Pictures** directory to view pictures.
3. Focus the camera on the scene and press  to take a photo.
Then you can preview the photo and save it.
4. Press  (**Options**) for the following options:
- **Delete:** allows you to delete the photo.
 - **Send:** allows you to select **Send as MMS, Send to album,** and **Bluetooth.**
 - **Set:** allows you to set the photo as the wallpaper or a contact image.



In preview mode, you can press  to zoom out or press  to zoom in (for the resolutions of 1600×1200 and 1280×960 , the camera can be neither zoomed in nor zoomed out).

In the upper left corner of the camera screen, the number **0–1000** indicates the approximate number of photo(s) that can be taken. **1000+** indicates that the number of photos that can be taken is more than 1000.

Viewing a Photo

1. In standby mode, select **Menu > Camera** to access the preview mode.
2. Press  (**Options**). Then select **Goto Gallery** to access the photo folder.
3. Press  to select a photo storage location: **Phone** or **microSD card**.
4. Press  to select a photo.
5. Press  to view the photo, and then press  to switch photos.
6. Press  (**Back**) to return to the photo list.
7. Press  (**Options**) for the following options:
 - **Full Screen**: allows you to view the photo in full screen mode.
 - **Slide Show**: allows the phone to play all photos in the current folder as a slide show.

- **Rotate:** allows you to rotate the photo.
- **Set as:** allows you to set the photo as the wallpaper or a contact image.
- **Send:** allows you to select **Send as MMS**, **Send to album**, and **Bluetooth**.
- **Delete:** allows you to delete the photo.
- **File Info:** allows you to view the name, size, resolution, DRM information, and creation time of the photo.

11 Video Camera

Recording a Video Clip

1. In standby mode, select **Menu > Camera** to access the preview mode to

launch the camera, and then press  to switch to the video camera.

 The phone can memorize the screen (camera or video camera screen) that it displayed last time.

For example, you launch the camera, press  to enter the video camera screen, and then exit. When you launch the camera next time, the phone displays the video camera screen.

2. Press  (**Options**) for the following options:

- **Switch To Camera:** allows you to use the functions of the camera on your phone. For details, see "Camera" on page 30.

You can also switch to the camera by pressing  in preview mode.

- **Video Size:** allows you to set the video size. You can select **MMS Limit**, **3 Minutes**, or **5 Minutes**.
- **Night Mode:** allows you to enable or disable the night mode.
- **Effect:** allows you to set the effect.
- **Shortcut Guide:** allows you to view the shortcut keys.
- **Settings:** allows you to set the **Video Quality**, **Audio Set**, and **Reset All**.

- **Goto Gallery:** allows you to access the **Menu > Multimedia > Gallery > Videos** directory to view video clips.

3. Press  to start recording.







4. Press  (**Stop**) to stop recording, and save the video clip to **Menu > Multimedia > Gallery > Videos** automatically.

5. Press  (**Options**) for the following options:

- **Play:** allows you to play the video clip.
- **Send As MMS:** allows you to send the video clip through the MMS.
- **Sent To Album:** allows you to log in to the specified websites provided by your network service provider after your phone activates the WAP function. For details, contact your network service provider.
- **Send Via Bluetooth:** allows you to send the video clip through Bluetooth.
- **Delete:** allows you to delete the video clip.
- **Goto Gallery:** allows you to access the **Menu > Multimedia > Gallery > Videos** directory to view video clips.







 Your phone supports video recording for up to five minutes. When five minutes pass, video recording is stopped and the video is saved automatically. Then the phone returns to the video preview screen.

Playing a Video Clip

1. In standby mode, select **Menu** > **Camera** to access the camera preview screen to launch the camera, and then press  to switch to the video camera.
2. Press  (**Options**). Then select **Goto Gallery** to access the **Videos** screen.
3. Press  to select a video storage location: **Phone** or **microSD card**.
4. Press  to select a video clip.
5. Press  to play the video clip, or press  (**Options**) and select **Play**.
6. Press  (**Back**) to return to the video clip list.







12 Recorder

Recording a Sound Clip

1. In standby mode, select **Menu > Multimedia > Recorder**.
 2. Press  to start recording and press  again to pause the recording.
 3. Press  (**Back**) to stop recording, with a prompt for confirmation being displayed.
 4. Press  (**Yes**) to save the sound clip to **Menu > Multimedia > Gallery > Musics > recorder**.
Press  (**No**) to return to the previous menu.
-  • During recording of a sound clip, if you press  (**Stop**), the sound clip can be automatically saved to **Menu > Multimedia > Gallery > Musics > recorder**.
- When recording a sound clip, keep the microphone of your phone near the sound source for a better recording effect.

Playing a Sound Clip

1. In standby mode, select **Menu > Multimedia > Recorder**.
2. Press  (**Options**) and select **Voice Folder**.

3. Press  to select the sound storage location, **Phone** or **microSD card**.
4. Press  to select a sound clip and then press  to play it, or press  (**Options**) and select **Play**.
5. Press  (**Minimize**) to view the sound clip list.
6. Press  (**Options**) for the following options:
- **Play**: allows you to play the sound clip.
 - **Set as**: allows you to set the sound clip as the ringtone, contact tone, SMS tone, or MMS tone.
 - **Send**: allows you to select **Send As MMS**, **Sent To Album**, and **Bluetooth**.
 - **Move To Memory Card/Move To Phone**: allows you to move the sound clip to the microSD card or the phone.
 - **Copy To Memory Card/Copy To Phone**: allows you to copy the sound clip to the microSD card or the phone.
 - **Delete**: allows you to delete the sound clip.
 - **Manage Multiple**: allows you to perform operations to multiple sound clips at a time by selecting the following options: **Play**, **Move To Memory Card/Move To Phone**, **Copy To Memory Card/Copy To Phone**, and **Delete**.
 - **Rename**: allows you to rename the sound clip.
 - **Sort**: allows you to sort the sound clips according to name, size, or date.
 - **File Info**: allows you to view the name, size, and creation time of the sound clip.

13 Radio



Your phone integrates a frequency modulation (FM) radio. Before listening to the radio, insert the headset to the headset jack.

-  The headset cable functions as an antenna. When listening to the radio, do not bind or wind the headset cable. Keep the headset cable straight for a better effect.

Switching On/Off the FM Radio

■ Switching On the FM Radio

1. Insert the headset into the headset jack properly.
2. In standby mode, select **Menu > Multimedia > Radio**. The phone plays the program on the channel you listened to last time.

-  When you listen to the radio for the first time, because no channel is saved on the phone, you need to press  and select **Auto Tuning, Manual Tuning, Fine Tuning, Set Frequency, or Set Frequency** to search for channels.

3. Press  (**Options**) and select **Speaker On/Speaker Off** to enable or disable the speaker.

4. On the **Radio** screen, you can do as follows:

- Press  to switch the channel.

- Press  to adjust the frequency with a precision of 0.1 MHz.

 After the FM radio is switched on, when the phone returns to the standby mode, it still plays the program and displays the current frequency.

■ Switching Off the FM Radio

On the **Radio** screen, press  (**Option**) and select **Switch Off** to switch off the radio and return to the previous screen.

 In standby mode or on the **Radio** screen, you can press the button on the headset to switch the channel, and press and hold the button on the headset to switch off the FM radio.

14 Bluetooth®

You can use the built-in Bluetooth function of your phone to synchronize data between a PC and your phone, or exchange data with other Bluetooth devices. You can also talk by using a Bluetooth headset or a Bluetooth loudspeaker.

You can set up a wireless connection between Bluetooth devices within a distance of 10 meters. The Bluetooth wireless connection, however, can be disturbed by other electronic devices and blocked by obstacles such as walls.

 The Bluetooth function supported by your phone meets the requirements of Bluetooth Specification 2.0. Your phone can work normally only if you use it with compatible Bluetooth devices. For more information, see the user manuals of related devices, or consult the manufacturers of related devices.

-  • In certain areas, the use of Bluetooth devices might be restricted or prohibited. Observe local laws and regulations.
- Do not accept the connection request of an unknown device. Thus you can prevent your mobile phone from the intrusion of harmful contents.

Sending Data Through the Bluetooth Connection

 You can set up only one Bluetooth connection each time.

1. Select **Menu** > **Settings** > **Connectivity Settings** > **Blue Tooth** >



Switch On, or press  and select **Switch On** to enable the Bluetooth function



2. Launch the application in which the contents need to be sent are saved. For example, if you want to send an image to another device, you need to launch the **Multimedia** > **Gallery** > **Pictures** application.

3. Select the content you want to send. Then press  (**Options**) and select **Send** > **Bluetooth**.



 If the Bluetooth function is not enabled yet, the phone displays "Switch On Bluetooth?" on the screen.

- Select **Yes** to enable Bluetooth and access the **Device List** screen.
- Select **No** to reject enabling of Bluetooth and return to the previous screen.

4. Press  to select a Bluetooth device that you want to connect with from the device list. Then press  and select **Send** to send contents through Bluetooth. If another Bluetooth device requires verification before connection, your phone displays **Input pair password** on the screen. Then create a password that is to be used together with the other party. After both parties enter the same password, the Bluetooth connection can be set up.

- If the devices on the device list are already paired with your phone, select the device you want to connect with and press  to transmit data.
 - When the device list is empty or the device to be connected with is not on the list, press  (**Search**) to search for other Bluetooth-enabled devices in the effective range. The names of the found devices will be displayed on the phone screen. Press  (**Back**) to stop searching.
 - Wait patiently when the phone searches for devices, which may last a period of time.
5. After the connection is set up, information about the data being transmitted and the sending progress are displayed on your phone.

Receiving Data Through the Bluetooth Connection

1. When another device sends data to your phone through Bluetooth, your phone displays "Receive?" on the screen. Press  (**Yes**) to receive the data. The filename and receiving progress are displayed on the screen. Press  (**No**) to reject the data.
- When your phone sets up a Bluetooth connection with another device for the first time, the phone displays **Input pair password** on the screen for verification. After a password of one to eight digits is entered the same as the other party, press  (**OK**) to receive the data.

2. The phone displays "Receive Successful!" on the screen, indicating that the data is received and saved to **Multimedia > Gallery**.

 If a microSD card is installed on your phone, the phone saves the received data to the microSD card by default; otherwise, the phone saves the received data in the phone memory.

Other Bluetooth Operations

You can perform the basic settings for the Bluetooth functions. Select **Menu > Settings > Connectivity Settings > Blue Tooth** for the following options:

- **Switch On/Off:** allows you to set the Bluetooth function to **On** or **Off**.
- **Search new device:** allows you to search for new Bluetooth devices.
- **Device List:** allows you to view all paired Bluetooth devices.
- **My device properties:** allows you to view the device name, visibility, hardware address, type, and supported mode of the phone.



15 Alarm Clock

After an alarm clock is enabled, the phone notifies you at the specified time. You can set up to five alarm clocks.

Enabling an Alarm Clock







1. Select **Menu** > **Tools** > **Alarms**.

2. Press  to select an alarm clock.



3. Press  (**On**) to turn on the alarm clock, or press  for the following options:

- **Title:** allows you to set the title of the alarm clock.
- **Time:** allows you to set the time.
- **Cycle:** allows you to set the alert cycle (days).
- **Ring:** allows you to set the alert tone.

4. Press  (**Save**) to save the alarm clock.

- When the alarm clock alerts, press  (**Stop**) to stop it or press  (**Snooze**) to snooze it for five minutes.
- If nothing is done to the alarm clock when it alerts, it stops temporarily after 45-second ringing and alerts again five minutes later. The alarm clock alerts five times before it stops thoroughly.
- If you select **Cycle > Custom**, press  to scroll from Sunday to Saturday and press  to select the days; press  again to deselect the days, and then press  (**OK**) to confirm.

Disabling an Alarm Clock

1. Select **Menu > Tools > Alarms**.
2. Press  to select an alarm clock.
3. Press  (**Off**) to disable the alarm clock.
You can also select **Menu > Tools > Alarms > Cancel All** to disable all alarm clocks.

16 Security

Enabling/Disabling the Phone Lock

The phone lock protects your phone from unauthorized use. The phone lock function is not enabled when you purchase the phone. You can change the default phone lock code **1234** to any numeric string of 4 to 8 digits.

1. Select **Menu > Settings > Security Settings > Phone Lock**.
2. Select one of the following phone lock modes:
 - **Immediate:** Lock the phone immediately.
 - **Power On:** Enable the phone lock when the phone is powered on next time.
 - **Off:** Disable your phone lock.

Changing the Phone Lock Code

Do remember your phone lock code. If you forget it, contact your local dealer.

1. Select **Menu > Settings > Security Settings > Change Phone Code**.
2. Enter the correct phone lock code and press (OK).
3. Enter the new phone lock code and press (OK).
4. Enter the new phone lock code again and press (OK).

Locking the Keypad

When the keypad is locked, you can still answer incoming calls or make emergency calls by pressing .

■ Manually Locking the Keypad

In standby mode, press and hold  to lock the keypad.

■ Automatically Locking the Keypad

If the auto keyguard function is enabled, after the phone has been idle for a preset period of time in standby mode, the keypad is locked automatically.



1. Select **Menu > Settings > Phone Settings > Auto Keyguard**.

2. Press  for the following options:

- **Off:** Disable the auto keyguard function.
- **15 Seconds, 30 Seconds, or 1 Minute:** When the phone has been idle for the selected time in standby mode, the keypad is locked automatically.

3. Press  (**Select**) to save the settings.

■ Unlocking the Keypad

In standby mode, press  (**Unlock**) and then press  to unlock the keypad.

17 Warnings and Precautions

This section contains important information pertaining to the operating instructions of your device. It also contains information about how to use the mobile safely. Read this information carefully before using your device.

■ Electronic Device

Power off your device if using the device is prohibited. Do not use the device when it causes danger or interference with electronic devices.

■ Medical Device

- Power off your device and follow the rules and regulations set forth by the hospitals and health care facilities.
- Pacemaker manufacturers recommend that a minimum distance of 15 cm be maintained between a device and a pacemaker to prevent potential interference with the pacemaker. If you are using a pacemaker, use the device on the opposite side of the pacemaker and do not carry the device in your front pocket.
- Some wireless devices may affect the performance of the hearing aids. For any such problems, consult your service provider.

■ Potentially Explosive Atmospheres

Switch off your device in any area with a potentially explosive atmosphere, and comply with all signs and instructions. Areas that may have potentially explosive atmospheres include the areas where you would normally be advised to turn off your vehicle engine. Triggering of sparks in such areas could cause an explosion or fire, resulting in bodily injuries or even deaths. Do not switch on the device at refueling points such as service stations.

Comply with restrictions on the use of radio equipment in fuel depots, storage, and distribution areas, and chemical plants. Also, adhere to restrictions in areas where blasting operations are in progress. Before using the device, watch out for areas that have potentially explosive atmosphere that are often, but not always, clearly marked. Such locations include areas below the deck on boats, chemical transfer or storage facilities and areas where the air contains chemicals or particles such as grain, dust, or metal powders. Ask the manufacturers of vehicles using liquefied petroleum gas (such as propane or butane) if this device can be safely used in their vicinity.

■ Traffic Security

Observe local laws and regulations while using the device. Also, if using the device while driving a vehicle, please comply with the following guidelines:

- Concentrate on driving. Your first responsibility is to drive safely.
- Do not talk on the device while driving. Use hands-free accessories.
- When you have to make or answer a call, park the vehicle at the road side before using your device.
- RF signals may affect electronic systems of motor vehicles. For more information, consult the vehicle manufacturer.
- In a motor vehicle, do not place the device over the air bag or in the air bag deployment area. Otherwise, the device may hurt you owing to the strong force when the air bag inflates.
- Do not use your device while flying in an aircraft. Switch off your device before boarding an aircraft. Using wireless devices in an aircraft may be dangerous to the operation of the aircraft, disrupt the wireless telephone network, and may be considered illegal.

■ Operating Environment

- Do not use or charge the device in dusty, damp or dirty places or places with magnetic fields. Otherwise, the circuit may not function properly.
- The device complies with the RF specifications when the device is used near your ear or at a distance of 1.5 cm from your body. Ensure that the device accessories such as a device case and a device holster are not composed of metal components. Keep your device 1.5 cm away from your body to meet the requirement earlier mentioned.
- On a thunder and stormy day, do not use your device when it is being charged, to prevent any danger caused by lightning.
- When you are on a call, do not touch the antenna. Touching the antenna affects the call quality and results in increase in power consumption. As a result, the talk time and standby time are reduced.
- While using the device, observe the local laws and regulations, and respect others' privacy and legal rights.
- Use accessories authorized by manufacturers. Using unauthorized accessories will render the warranty null and void.
- Keep the ambient temperature between 0°C and 45°C while the device is being charged. Keep the ambient temperature between -10°C to 60°C for using the device powered by battery.

■ Preventing Hearing Damage

Using the receiver, earbuds, headphones, speakerphone, or earpieces at high volume can result in permanent hearing loss. Be extremely careful when listening at high decibel levels. Set the volume to a safe level. If you experience strange sounds in your ears like ringing or if you hear muffled speech, get your hearing checked. If you continue to use high volume, your hearing will soon get affected.

Hearing experts offer the following suggestions to protect your hearing:

- Reduce the time you use the receiver, earbuds, headphones, speakerphone, or earpieces at high volume.

- Do not increase the volume to block noisy surroundings.
- Reduce the volume if you can't hear people speaking near you.

■ **Safety of Children**

Please comply with all precautions with regard to children's safety. Letting the child play with your device or its accessories, which may include parts that can be detached from the device, may prove dangerous, as it may present a choking hazard. Make sure that small children are kept away from the device and accessories.

■ **Environment Protection**

Follow all the local regulations regarding the disposal of your devices or electrical accessories (such as chargers, headsets, or batteries). Recycle them. Do not dispose of an exhausted battery or a used device in a garbage can.

■ **Accessories**

Use only the accessories, such as the charger, battery, and headset, delivered by manufacturer. Using accessories of other manufacturers or vendors with this device model might invalidate any approval or warranty applicable to the device, might result in the non-operation of the device, and might be dangerous.

■ **Battery and Charger**

- The battery can be charged and discharged hundreds of times before it eventually wears out. When the standby time and talk time are shorter than normal, replace the battery.
- Use the AC power supply defined in the specifications of the charger. An improper power voltage may cause fire or the charger may not function properly.

- Do not connect two poles of the battery with conductors such as metal materials, keys or jewelries. Otherwise, the battery may be short-circuiting and may cause injuries and burns on your body.
- Do not disassemble the battery or solder the battery poles. Otherwise, it may lead to electrolyte leakage, overheating, fire, or explosion.
- If battery electrolyte leaks out, make sure that the electrolyte does not touch your skin and eyes. When the electrolyte touches your skin or splashes into your eyes, wash your eyes with clean water immediately and consult a doctor.
- If the battery is damaged, or the color changes or gets abnormally heated while you charge or store the battery, remove the battery immediately and stop using it. Otherwise, it may lead to battery leakage, overheating, explosion, or fire.
- If the power cable is damaged (for example, the lead is exposed or broken), or the plug loosens, stop using the cable at once. Otherwise, it may lead to electric shock, short-circuit of the charger, or a fire.
- The travel charger of this device can meet safety requirements of the UL60950-1 certification. Comply with the security specifications in the UL manual.
- Do not dispose of batteries in fire as they may explode. Batteries may also explode if damaged.

■ **Clearing and Maintenance**

- The device, battery, and charger are not water-resistant. Keep them dry. Protect the device, battery and charger from water or vapor. Do not touch the device and charger with a wet hand. Otherwise, it may lead to short-circuit or malfunction of the device and electric shock to the user.
- Do not place your device, battery, or charger in places where it can get damaged because of collision. Otherwise, it may lead to battery leakage, device malfunction, overheating, fire, or explosion.

- If the ambient temperature is considerably low or high, the capacity and life of the battery is reduced. When the temperature is lower than 0°C, performance of the battery is affected.
- Do not place magnetic storage media such as magnetic cards and floppy disks near the device. Radiation from the device may erase the information stored on them.
- Do not leave your device, battery, or charger in a very hot or cold place. Otherwise, they may not function properly and may lead to a fire or an explosion.
- Do not place sharp metal objects such as pins near the earpiece. The earpiece may attract these objects and hurt you when you are using the device.
- Before you clean or maintain the device, power off the device and disconnect it from the charger.
- Do not use any chemical detergent, powder, or other chemical agents (such as alcohol and benzene) to clean the device and the charger. Otherwise, parts of the device may get damaged or a fire can be caused. You can clean the device and the charger with a piece of damp and soft antistatic cloth.
- Do not dismantle the device or accessories. Otherwise, manufacturer is not liable to pay for damages as the device and accessories are not covered by warranty.

■ Emergency Call

You can use your device for emergency calls in the service area. The connection, however, cannot be guaranteed in all conditions. You should not rely solely on the device for essential communications.

■ Certification Information (SAR)

THIS DEVICE MEETS THE GOVERNMENT'S REQUIREMENTS FOR EXPOSURE TO RADIO FREQUENCY ELECTROMAGNETIC FIELD.

Your device is a low-power radio transmitter and receiver. When it is turned on, it emits low levels of radio frequency energy (also known as radio waves or radio frequency fields).

Governments around the world have adopted comprehensive international safety guidelines, developed by scientific organizations, e.g. International Commission on Non-Ionizing Radiation Protection (ICNIRP) and Institute of Electrical and Electronics Engineers Inc. (IEEE), through periodic and thorough evaluation of scientific studies. These guidelines establish permitted levels of radio wave exposure for the general population. The levels include a safety margin designed to assure the safety of all persons, regardless of age and health, and to account for any variations in measurements.

Specific Absorption Rate (SAR) is the unit of measurement for the amount of radio frequency energy absorbed by the body when using a device. The SAR value is determined at the highest certified power level in laboratory conditions, but the actual SAR level of the device while being operated can be well below the value. This is because the device is designed to use the minimum power required to reach the network.

Before a device model is available for sale to the public, it must be tested and certified by the Federal Communications Commission (FCC), ensuring that it does not exceed the limit established by the government-adopted requirement for safe exposure. The tests are performed in positions and locations (that is, at the ear and worn on the body) as required by the FCC for each model. For body worn operation, this device has been tested and meets FCC RF exposure guidelines when the handset is positioned a minimum of 15 mm from the body with an accessory that contains no metal part. Use of other accessories may not ensure compliance with FCC RF exposure guidelines.

The SAR limit adopted by USA and Canada is 1.6 watts/kilogram (W/kg) averaged over one gram of tissue. The highest SAR value reported to the

FCC and IC for this device type when tested for use at the ear is 0.708 W/kg, and when properly worn on the body is 1.11 W/kg.

The SAR limit adopted by the CNIRP is 2.0 W/kg over one gram of tissue. The value guarantees a safe distance to protect device users and the difference caused by measurement errors. Under different test requirements and frequency, the value varies.

■ Statement

This equipment has been tested and found to comply with the limits for a Class B digital device, pursuant to Part 15 of the FCC Rules.

This device complies with part 15 of the FCC Rules. Operation is subject to the following two conditions: (1) This device may not cause harmful interference, and (2) this device must accept any interference received, including interference that may cause undesired operation.

These limits are designed to provide reasonable protection against harmful interference in a residential installation. The operation is subject to the condition that this device does not cause harmful interface.

This equipment generates, uses and can radiate radio frequency energy and, if not installed and used in accordance with the instructions, may cause harmful interference to radio communications. There is no guarantee, however, that interference does not occur in a particular installation. If this equipment does cause harmful interference to radio or television reception, which can be determined by turning the equipment off and on, the user is encouraged to try to correct the interference by one or more of the following measures:

- Reorient or relocate the receiving antenna.
- Increase the separation between the equipment and receiver.
- Connect the equipment into an outlet on a circuit different from that to which the receiver is connected.
- Consult the dealer or an experienced radio/TV technician for help.

Warning: Changes or modifications made to this equipment not expressly approved by manufacturer may void the FCC authorization to operate this equipment.

Version: V100R001_01 Part number: 3140xxxx