



HUAWEI M580

CDMA Mobile Phone

User Guide

1	Copyright	1
2	Getting Started	4
	Your Phone at a Glance	4
	Keys and Functions	5
	Inserting the Battery	7
	Inserting the microSD Card	8
	Charging the Battery	8
	Status Icons	9
	Using the Touch Screen	10
3	Text Entry	12
	Entering English	12
	Entering Spanish	13
	Entering a Digit	13
4	Voice Services	14
	Making a Call	14
	Answering a Call	15
5	Contacts	16
	Adding a Contact	16
	Searching for a Contact	16
6	SMS & MMS	17
	Writing and Sending a Message	17
	Reading a Message	17
7	@metro	18

Accessing @metro App Store	18
Changing Your @metro Settings	19
Using On-line Help	20
8 Media Applications	22
Camera	22
Music Player	23
Playing a Video	24
Picture Viewer	24
Recorder	25
9 Bluetooth	26
Bluetooth-based Data Transfer	26
Using Bluetooth Headset	26
10 Security	28
Enabling/Disabling the Phone Lock	28
PIN and PUK	28
Locking the Keypad	29
11 TTY Operation	30
Using the TTY Device	30
Setting the TTY Mode	30
12 Troubleshooting	32
13 Warnings and Precautions	34
14 Futurewei Technologies, Inc. Limited Warranty	46



1 Copyright

Copyright © Huawei Technologies Co., Ltd. 2011. All rights reserved.

No part of this document may be reproduced or transmitted in any form or by any means without prior written consent of Huawei Technologies Co., Ltd.

The product described in this manual may include copyrighted software of Huawei Technologies Co., Ltd and possible licensors. Customers shall not in any manner reproduce, distribute, modify, decompile, disassemble, decrypt, extract, reverse engineer, lease, assign, or sublicense the said software, unless such restrictions are prohibited by applicable laws or such actions are approved by respective copyright holders under licenses.

Trademarks and Permissions

 HUAWEI, and  are trademarks or registered trademarks of Huawei Technologies Co., Ltd.

Other trademarks, product, service and company names mentioned are the property of their respective owners.

Notice

Some features of the product and its accessories described herein rely on the software installed, capacities and settings of local network, and may not be activated or may be limited by local network operators or network service providers, thus the descriptions herein may not exactly match the product or its accessories you purchase.

Huawei Technologies Co., Ltd reserves the right to change or modify any information or specifications contained in this manual without prior notice or obligation.

NO WARRANTY

THE CONTENTS OF THIS MANUAL ARE PROVIDED “AS IS”. EXCEPT AS REQUIRED BY APPLICABLE LAWS, NO WARRANTIES OF ANY KIND, EITHER EXPRESS OR IMPLIED, INCLUDING BUT NOT LIMITED TO, THE IMPLIED WARRANTIES OF MERCHANTABILITY AND FITNESS FOR A PARTICULAR PURPOSE, ARE MADE IN RELATION TO THE ACCURACY, RELIABILITY OR CONTENTS OF THIS MANUAL.

TO THE MAXIMUM EXTENT PERMITTED BY APPLICABLE LAW, IN NO CASE SHALL HUAWEI TECHNOLOGIES CO., LTD BE LIABLE FOR ANY SPECIAL, INCIDENTAL, INDIRECT, OR CONSEQUENTIAL

DAMAGES, OR LOST PROFITS, BUSINESS, REVENUE, DATA, GOODWILL OR ANTICIPATED SAVINGS.

Import and Export Regulations

Customers shall comply with all applicable export or import laws and regulations and will obtain all necessary governmental permits and licenses in order to export, re-export or import the product mentioned in this manual including the software and technical data therein.

DTS Envelo



Manufactured under license from DTS licensing Limited. DTS, the Symbol & DTS and the Symbol together are registered trademarks & DTS Envelo is a trademark of DTS, Inc. Product includes software. © DTS, Inc. All Rights Reserved.

2 Getting Started

Your Phone at a Glance

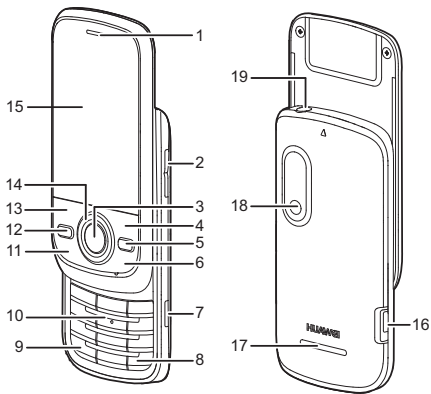

1 Earpiece

2 Volume key

3	Confirm key	4	Right soft key
5	Clear key	6	End key
7	Camera key	8	# key
9	* key	10	Numeric keys
11	Send key	12	Speaker key
13	Left soft key	14	Navigation keys
15	Screen	16	Charger/Data cable connector
17	Speaker	18	Main camera
19	Headset jack		

Keys and Functions

Send key

- Make or answer a call.
 - Access call logs in standby mode.
-

	<ul style="list-style-type: none">• Power on or power off the phone by pressing and holding it.
End key	<ul style="list-style-type: none">• End or reject a call.• Return to the standby mode.• Lock the screen in the standby mode.
Left soft key	Select the option displayed in the lower left corner of the screen.
Right soft key	Select the option displayed in the lower right corner of the screen.
Clear key	Delete a character in editing mode or delete a selected item in an application.
Speaker key	Press and hold to turn on or off the speaker mode.
* key	Switch between the current mode and the Vibrate Only mode by pressing and holding it.
# key	Switch between text input methods when editing text.

	<ul style="list-style-type: none">• Enter numbers, letters, and symbols.
0 key	<ul style="list-style-type: none">• Call the voicemail in standby mode by pressing and holding the 1 key.
...	
9 key	<ul style="list-style-type: none">• Speed-dial phone numbers in standby mode by pressing and holding the desired key 2–9 after a phone numbers are assigned to the number key.

Confirm key	<ul style="list-style-type: none">• Confirm a selection.
key	<ul style="list-style-type: none">• Access Menu in standby mode.

Volume key	Increase or decrease the volume.
-------------------	----------------------------------

Inserting the Battery

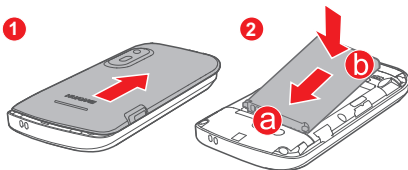

Inserting the microSD Card

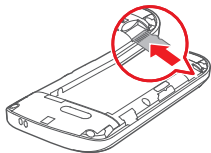

























Charging the Battery

Before charging the battery with the travel charger, ensure that the battery is installed in your phone. Do not use a damaged battery or charger.

1. Connect the charger to a power outlet.
2. Connect the charger to the charger connector of the phone. The phone begins charging. When the battery icon changes to fully charged, it indicates that your phone is fully charged.
3. When the phone is fully charged, disconnect the charger from the phone and then from the power outlet.

Status Icons

	Signal strength		Roaming
	Call in progress		Missed calls
	New push message received		The memory for text messages is full
	New text message received		New multimedia message received
	The memory for multimedia messages is full		New voicemail message received
	New emergency message received		microSD card inserted
	Alarm clock enabled		Bluetooth on
	Bluetooth headset connected		The phone is receiving date through Bluetooth

	The phone is sending data through Bluetooth		Battery level
	Battery charging		The battery power level is extremely low
	The alert type is Ring .		The alert type is Silence
	The alert type is Ring and Vibrate		The alert type is Vibrate Only
	Headset connected		

Using the Touch Screen

You can use your finger to select an item by tapping on the touch screen of your phone.

Touch Operations

- Tap: Select an item or display a menu by touching your finger to the screen.
- Drag: Move an object by moving your finger on the screen.

Screen Calibration

When operating the phone with the touch screen, if the phone cannot respond to your operation correctly, you can calibrate the screen as follows:

- Select **Settings > Display > Screen Calibration** to access the screen for calibration.
- Calibrate the screen by tapping the center of + displayed on the screen according to the instructions.

Note: During the calibration, tap the center of + accurately, to ensure that the phone can respond to your tap and text entry on the screen correctly after the calibration.

Dragging and Flicking

On following screens, you can perform some operations conveniently through dragging on the touch screen:

- On the standby screen, flick right or left to switch between the home screens.
- In the menu list, drag up or down to scroll. Then tap a submenu to select it.
- When viewing pictures, flick right or left to switch a picture to the next or previous one.

3 Text Entry

Entering English

Smart English Input Method

1. Based on the sequence of the word, press the key labeled with the desired letter once. Then the phone predicts the commonly used words according to the numeric sequence of key presses.
2. Select the desired word, and press **Confirm key** or **0 key** to enter the word.
3. Press **1 key** to enter a full stop or another commonly used punctuation. Press *** key** to display the symbol list. Then you can select and enter a symbol.

Note:

The indicator of the current input method is displayed in the upper left corner of the screen. You can press **# key** to change the input method.

Traditional English Input Method

The traditional text input method allows you to enter uppercase or lowercase English letters. You can press the key labeled with the desired letter once to enter the first letter on the key, twice to enter the second letter on the key, and so on.

- Press **1 key** to enter a full stop or another commonly used punctuation.
- Press *** key** once to enter a space, twice to enter a carriage return, and three times to enter 0.

Entering Spanish

You can enter Spanish words using Spanish text input methods.

The traditional Spanish input method and the smart Spanish input method are similar to the traditional English input method and the smart English input method. For details, see "Entering English".

Entering a Digit

- In "123" input mode, press the key labeled with your desired digit.
- In "Abc" input mode, press a number key consecutively until the digit appears.
- In "En" input mode, press a number key and then press **Navigation keys** to scroll to the digit and press **Confirm key** to enter it.
- In any text input mode, except the "123" input mode, press and hold a number key to enter the digit.

4 Voice Services

Making a Call

Dialing via Keypad

1. In standby mode, enter the phone number.
 - To make an international call, press * **key** twice consecutively to enter the international long-distance code (+), and then enter the country code or region code, area code, and phone number in sequence.
 - To dial an extension number, enter the phone number, press * **key** three times consecutively to insert P or press * **key** four times consecutively to insert W, and then enter the extension number.
2. Press **Send key** to dial the number.
3. Press **End key** or tap  to end the call.

Dialing via Contacts

Select  > **Contacts**, Select a contact, and press **Send key** to make a call.

Dialing via Call Log

Select  > **Call Logs** or press **Send key** to select the required number from call logs. Then press **Send key** to dial the number

Answering a Call

When there is an incoming call, you can press **Send key** to answer it, press **End key** to reject it.

- If the any-key answer function is enabled, you can press any key except **End key** and **Right soft key** to answer an incoming call.
- If the headset auto-answer function is enabled, when the headset is connected to the phone, the incoming call is answered automatically.

5 Contacts

Adding a Contact



1. Select  > **Contacts** > **Add New**.
2. On the Edit screen, enter the information about the contact. (For each contact, at least one number needs to be entered.)
3. Select **Save** to save the contact.

Searching for a Contact

1. Select  > **Contacts** > **Search**.
2. Enter the name of the contact in the text box. The automatically lists the contacts that comply with the search information you entered.

6 SMS & MMS

Writing and Sending a Message

1. Select  > **Messages** > **Create Message**.
2. Enter one or more recipient's numbers directly, or press **Confirm key** and select  to access the contact list and then select one or multiple recipients.
3. Enter text contents in the text box. You can Select **Options** > **Add Attachment** to add picture, video, audio or slide to the message, and the message will be converted to MMS mode automatically.
4. Select **Options** > **Send** to send the message

Note:

Your phone supports a multimedia message of a maximum size of 290 KB.

Reading a Message

To read a text message stored in the inbox, do the following:

1. Select  > **Messages** > **Inbox**.
2. Press **Navigation keys** to scroll to a message. Press **Confirm key** to read the message.

7 @metro

With @metro App Store, you can download full featured applications over the air including games, personalized ring tones, pictures, and more. You can send and receive instant messages and email, or browse the web to catch up on all the latest news.

This section outlines how to obtain games and other applications for your phone. For more information about this function, consult your service provider.

Accessing @metro App Store

Download games, ring tones, e-mail, and more using the App Store. For information on airtime charges, consult your service provider.

1. In the standby mode, select **@metro App Store**.
2. Select the **@metro App Store**, then press **Confirm key**. Your phone takes a moment to connect, then the App Store Catalog menu appears in the display.

Note: The first time you access the App Store, an "airtime warning" message appears in the display along with instructions on how to remove this message.

3. Follow the instructions in your phone's display.

Note: Please check with your Wireless Carrier for availability of applications.

Changing Your @metro Settings

Use the Settings menu in App Store to manage, move, order applications, and much more.

1. In the standby mode, select **@metro App Store**.
2. At the **@metro App Store** menu, Select **Settings**, then press **Confirm key**. The following options appear in the display:
 - **Order Apps:** Download applications over the network.
 - **Move Apps:** Move previously downloaded applications between available folders.
 - **Manage Apps:** View used and available memory.
 - **Main Menu View:** Select whether you wish to view the **@metro App Store** menu in a list or icon format.
 - **View Log:** View the App Store log, which displays information about recent activity using App Store.
3. Press **Navigation keys** to select the desired option.
4. Press **Confirm key** to enter the option's sub-menu and view or change settings.

Using On-line Help

The Help sub-menu within @metro App Store is a short tutorial on several @metro App Store features. View information about charges, cancelling subscriptions, buying apps, disabling apps, and more.

1. Within in the @metro menu, Select **Help**.
2. Press **Confirm key**. The Help subjects described in the following subsections appear in the display.
3. Use **Navigation keys** to select the desired Help subject.
4. Press **Confirm key** to view the selected Help information.

Buying New Apps

To buy new and exciting apps, visit the App Store. It provides you with a variety of apps you can choose from.

What do I pay?

When you buy an app, you will be charged for the purchase cost of the app.

Demo Apps

A Demo app is free and is designed to demonstrate the app's main features. It usually expires after a certain period of time or a number of uses and often has limited functions. When you run a demo app,

you will be presented with a purchase option so you won't have to look for the app in the App Store.

Removing Apps

You may remove apps that are no longer needed. When you remove an app, you cannot use the application unless you purchase it again. To remove an app, choose **Settings > Manage Apps**. Then, select the app you want to remove.

Disabled Apps

You can install new apps even if the memory of your phone is full by partially removing (disabling) apps you haven't used recently. When you need to use a disabled app, you can restore it at no additional purchase cost.

Restoring Apps

Disabled apps can be quickly restored at no additional purchase cost. To restore an app, run the application you want to restore from the Main Menu. You will be guided through the restoration process.

Expired Apps

Apps that were purchased based on the number of uses or for a specified period of time expire. You can purchase additional uses from the App Store.



8 Media Applications

Camera

Taking a Photo

1. Press **Camera key** to access camera.
2. In the viewfinder screen, Select  > **Shortcut Guide** to view the help information of camera.
3. Focus the camera on the scene. Press **Confirm key** to take a photo.
4. Your photo is automatically saved to the album of the default storage that you select.

Recording a Video

1. Select  > **Camcorder**.
2. In the viewfinder screen, Select  > **Shortcut Guide** to view the help information of camera.
3. Press **Confirm key** to start recording. Press **Confirm key** to pause. Press **Confirm key** to stop recording. The video is automatically saved to the Videos folder of the storage that you select.

Music Player

Starting the Music Player

To start the music player, select  > **Music player**.

Adding a Playlist







1. Select  > **Music player**.
2. Select **Options** > **Music Library** > **Playlist**.
3. Select **Options** > **Add New Playlist** to create a new playlist. Open the playlist and add songs to the playlist.

Note:

You can also select  > **Multimedia** to select music to play.

Playing music

When the music is played, you can do the following:

- Tap  to pause the song; Tap  to continue playing.
- Tap  to play the next song. Tap and hold  to fast-forward the song.
- Tap  to play the previous song. Tap and hold  to rewind the song.
- Select **Options** > **Off** to exit the media player.







Note:

When a song is played, you can select **Minimize** or press **End key** to minimize the media player screen. In this case, the media player is running in the background.

Playing a Video

1. In standby mode, select  > **Multimedia** > **My Videos**.
2. 3.Press **Navigation keys** to scroll to the video to be played. Then press **Confirm key** to play the video.





When the video is played, you can do the following:

- Tap  to pause; Tap  to continue playing.
- Tap  to play the next video. Tap and hold  to fast-forward.
- Tap  to play the previous video. Tap and hold  to rewind.

Picture Viewer

1. Select  > **Multimedia** > **My Images**.
2. Press **Navigation keys** to scroll to a picture and then press **Confirm key** to view the picture, and press **Confirm key** again to view the picture in full-screen mode.

Recorder

1. In standby mode, select  > **Tools** > **Voice Record**
2. Tap  to start recording. Tap  to pause.
3. Tap  to stop recording. The sound clip is automatically saved to the Recorders folder of the default storage that you select.
4. Tap  to play the sound clip.

Note:

When recording a sound clip, keep the microphone of your phone near the sound source for a better recording effect.

9 Bluetooth

Bluetooth-based Data Transfer

You can exchange data between your Bluetooth phone and other Bluetooth devices. If you want to exchange data between your phone and another device, that device must support Bluetooth and the Bluetooth function must be enabled.

1. Select **Power On** to enable the Bluetooth function.
2. Select **Search New Devices** to search a Bluetooth device. When a Bluetooth device is found for the first time, authentication is required.
3. After the authentication, you can exchange data between your phone and the other Bluetooth device.

Using Bluetooth Headset

You can talk by using the Bluetooth headset or Bluetooth loudspeaker. For more information, refer to the user manuals of the relevant devices.

1. Open the Bluetooth headset and keep it in the discoverable state.
2. Select **Power On** to enable the Bluetooth function.

3. Select **Search New Devices** to search for a Bluetooth device. When a Bluetooth device is found for the first time, authentication is required.

10 Security

Enabling/Disabling the Phone Lock

The phone lock protects your phone from unauthorized use. By default, the phone lock is not enabled. You can change the default phone lock code (Last four number of the MDN) to any numeric string of four to eight digits.

To enable or disable the phone lock, select  > **Settings** > **Security** > **Phone Lock**.

PIN and PUK

The personal identification number (PIN) protects your SIM card from unauthorized use. The PIN unblocking key (PUK) can unlock the blocked PIN. Both PIN and PUK are delivered with the SIM card. For details, contact your service provider.

If you enter wrong PINs for a specified number of times consecutively, the phone asks you to enter the PUK.

If you enter wrong PUKs for a specified number of times consecutively, the SIM card is invalidated permanently. Contact your service provider for a new one.

Locking the Keypad

When the keypad is locked, you can still answer incoming calls or make emergency calls by pressing **Send key**.

1. Press **End key** to lock the key pad.
2. Slide the unlock block, or press **Left soft key**, and then press **Confirm key** to unlock the keypad.

11 TTY Operation

Using the TTY Device

The Teletypewriter (TTY) is a typewriting device. By connecting the phone to the TTY device, you can use the TTY functions to send/receive messages.

When you use the TTY function, do as follows:

1. Set the phone to the TTY mode and connect the TTY device to the headset jack of the phone.
2. Make or answer calls as normal.
3. When the call is put through, use the TTY device to send or receive the letters.
4. Press **End key** or tap  to end the call.

Setting the TTY Mode

Connecting your phone to the PC with the USB cable enables the PC to use the phone as a modem. This helps to set up a dial-up connection to the Internet.

Only Windows 2000, Windows XP and Windows Vista are supported.

1. Select  > **Settings** > **Phone** > **TTY Setup**.
2. Select **TTY** mode.
 - **Voice**: The standard voice speaking mode and the listening mode.
 - **TTY**: Transmit and receive the TTY characters.
 - **VCO**: Receive TTY characters but transmit by speaking into the microphone.
 - **HCO**: Transmit TTY characters but receive by listening to the earpiece.

12 Troubleshooting

If you encounter any problem when using your phone, try to rectify the problem according to the following table. If the problem persists, contact the service provider or the dealer.

The battery cannot be charged.

The charger is properly connected to your phone and the power socket.

The phone cannot be powered on.

- The battery power is sufficient.
 - The battery is properly installed.
 - Press and hold **End key**.
-

You cannot make a call except an emergency call.

- The phone number is correct.
 - You are in the network service area.
 - You have not enabled the call restriction function.
-

Bad call quality.

- The signal strength is strong enough.
 - If you are staying indoors, move close to a window.
-

During a call, the other side cannot hear your voice.

The microphone is not covered.

The signal strength is not strong enough or your phone is often off line.

- The antenna is in a good condition.
- Move close to a place with strong signal strength.

Your phone displays "No service found", "Service unavailable" or "Network problem".

- You are not in an area with weak magnetic field (in a tunnel or surrounded by buildings). If so, move to another area and try again.
 - Do not visit the service option without obtaining authorization from your service provider.
-

13 Warnings and Precautions

This section contains important information pertaining to the operating instructions of your device. It also contains information about how to use the device safely. Read this information carefully before using your device.

Electronic Device

Power off your device if using the device is prohibited. Do not use the device when using the device causes danger or interference with electronic devices.

Medical Device

- Follow rules and regulations set forth by hospitals and health care facilities. Do not use your device when using the device is prohibited.
- Pacemaker manufacturers recommend that a minimum distance of 15 cm be maintained between a device and a pacemaker to prevent potential interference with the pacemaker. If you are using a pacemaker, use the device on the opposite side of the pacemaker and do not carry the device in your front pocket.

Potentially Explosive Atmosphere

Power off your device in any area with a potentially explosive atmosphere, and comply with all signs and instructions. Areas that may have potentially explosive atmospheres include the areas where you would normally be advised to turn off your vehicle engine. Triggering of sparks in such areas could cause an explosion or a fire, resulting in bodily injuries or even deaths. Do not power on your device at refueling points such as service stations. Comply with restrictions on the use of radio equipment in fuel depots, storage, and distribution areas, and chemical plants. In addition, adhere to restrictions in areas where blasting operations are in progress. Before using the device, watch out for areas that have potentially explosive atmospheres that are often, but not always, clearly marked. Such locations include areas below the deck on boats, chemical transfer or storage facilities, and areas where the air contains chemicals or particles such as grain, dust, or metal powders. Ask the manufacturers of vehicles using liquefied petroleum gas (such as propane or butane) whether this device can be safely used in their vicinity.

Traffic Security

Observe local laws and regulations while using the device. In addition, if using the device while driving a vehicle, comply with the following guidelines:

- Concentrate on driving. Your first responsibility is to drive safely.
- Do not talk on the device while driving. Use hands-free accessories.
- When you have to make or answer a call, park the vehicle at the road side before using your device.
- RF signals may affect electronic systems of motor vehicles. For more information, consult the vehicle manufacturer.
- In a motor vehicle, do not place the device over the air bag or in the air bag deployment area. Otherwise, the device may hurt you owing to the strong force when the air bag inflates.
- Do not use your device while flying in an aircraft. Power off your device before boarding an aircraft. Using wireless devices in an aircraft may cause danger to the operation of the aircraft and disrupt the wireless telephone network. It may also be considered illegal.

Operating Environment

- Do not use or charge the device in dusty, damp, and dirty places or places with magnetic fields. Otherwise, it may result in a malfunction of the circuit.

- The device complies with the RF specifications when the device is used near your ear or at a distance of 1.5 cm from your body. Ensure that the device accessories such as a device case and a device holster are not composed of metal components. Keep your device 1.5 cm away from your body to meet the requirement earlier mentioned.
- On a stormy day with thunder, do not use your device when it is being charged, to prevent any danger caused by lightning.
- When you are on a call, do not touch the antenna. Touching the antenna affects the call quality and results in increase in power consumption. As a result, the talk time and the standby time are reduced.
- While using the device, observe the local laws and regulations, and respect others' privacy and legal rights.
- Keep the ambient temperature between 0°C and 40°C while the device is being charged. Keep the ambient temperature between 0°C to 40°C for using the device powered by a battery.

Prevention of Hearing Damage

Using a headset at high volume can damage your hearing. To reduce the risk of damage to hearing, lower the headset volume to a safe and comfortable level.

Safety of Children

Comply with all precautions with regard to children's safety. Letting the child play with your device or its accessories, which may include parts that can be detached from the device, may be dangerous, as it may present a choking hazard. Ensure that small children are kept away from the device and accessories.

Accessories

Use the accessories delivered only by the manufacturer. Using accessories of other manufacturers or vendors with this device model may invalidate any approval or warranty applicable to the device, result in the non-operation of the device, and cause danger.

Battery and Charger

- Unplug the charger from the electrical plug and the device when not in use.
- The battery can be charged and discharged hundreds of times before it eventually wears out. When the standby time and the talk time are shorter than the normal time, replace the battery.
- Use the AC power supply defined in the specifications of the charger. An improper power voltage may cause a fire or a malfunction of the charger.
- Do not connect two poles of the battery with conductors, such as metal materials, keys, or jewelries. Otherwise, the battery

may be short-circuited and may cause injuries and burns on your body.

- Do not disassemble the battery or solder the battery poles. Otherwise, it may lead to electrolyte leakage, overheating, fire, or explosion.
- If battery electrolyte leaks out, ensure that the electrolyte does not touch your skin and eyes. When the electrolyte touches your skin or splashes into your eyes, wash your eyes with clean water immediately and consult a doctor.
- If there is a case of battery deformation, color change, or abnormal heating while you charge or store the battery, remove the battery immediately and stop using it. Otherwise, it may lead to battery leakage, overheating, explosion, or fire.
- If the power cable is damaged (for example, the cord is exposed or broken), or the plug loosens, stop using the cable at once. Otherwise, it may lead to an electric shock, a short circuit of the charger, or a fire.
- Do not dispose of batteries in fire as they may explode. Batteries may also explode if damaged.

Cleaning and Maintenance

- The device, battery, and charger are not water-resistant. Keep them dry. Protect the device, battery, and charger from water or vapor. Do not touch the device or the charger with a wet hand. Otherwise, it may lead to a short circuit, a malfunction of the device, and an electric shock to the user.

- Do not place your device, battery, and charger in places where they can get damaged because of collision. Otherwise, it may lead to battery leakage, device malfunction, overheating, fire, or explosion.
- Do not place magnetic storage media such as magnetic cards and floppy disks near the device. Radiation from the device may erase the information stored on them.
- Do not leave your device, battery, and charger in a place with an extreme high or low temperature. Otherwise, they may not function properly and may lead to a fire or an explosion. When the temperature is lower than 0°C, performance of the battery is affected.
- Do not place sharp metal objects such as pins near the earpiece. The earpiece may attract these objects and hurt you when you are using the device.
- Before you clean or maintain the device, power off the device and disconnect it from the charger.
- Do not use any chemical detergent, powder, or other chemical agents (such as alcohol and benzene) to clean the device and the charger. Otherwise, parts of the device may be damaged or a fire can be caused. You can clean the device and the charger with a piece of damp and soft antistatic cloth.
- Do not dismantle the device or accessories. Otherwise, the warranty on the device and accessories is invalid and the manufacturer is not liable to pay for the damage.

Emergency Call

You can use your device for emergency calls in the service area. The connection, however, cannot be guaranteed in all conditions. You should not rely solely on the device for essential communications.

Certification Information (SAR)

This mobile device meets guidelines for exposure to radio waves.

Your device is a low-power radio transmitter and receiver. As recommended by international guidelines, the device is designed not to exceed the limits for exposure to radio waves. These guidelines were developed by the independent scientific organization International Commission on Non-Ionizing Radiation Protection (ICNIRP) and include safety measures designed to ensure safety for all users, regardless of age and health.

The Specific Absorption Rate (SAR) is the unit of measurement for the amount of radio frequency energy absorbed by the body when using a device. The SAR value is determined at the highest certified power level in laboratory conditions, but the actual SAR level of the device when being operated can be well below the value. This is because the device is designed to use the minimum power required to reach the network.

The SAR limit adopted by USA and Canada is 1.6 watts/kilogram (W/kg) averaged over one gram of tissue. The highest SAR value reported to the FCC and IC for this device type when tested for use at the ear is xxx W/kg, and when properly worn on the body is xxx W/kg.

Hearing Aid Compatibility (HAC) regulations for Mobile phones

In 2003, the FCC adopted rules to make digital wireless telephones compatible with hearing aids and cochlear implants. Although analog wireless phones do not usually cause interference with hearing aids or cochlear implants, digital wireless phones sometimes do because of electromagnetic energy emitted by the phone's antenna, backlight, or other components.

Your phone is compliant with FCC HAC regulations (ANSI C63.19). While some wireless phones are used near some hearing devices (hearing aids and cochlear implants), users may detect a buzzing, humming, or whining noise.

Some hearing devices are more immune than others to this interference noise, and phones also vary in the amount of interference they generate. The wireless telephone industry has developed a rating system for wireless phones, to assist hearing device users find phones that may be compatible with their hearing devices. Not all phones have been rated. Phones that are rated have

the rating on their box or a label located on the box. The ratings are not guarantees. Results will vary depending on the user's hearing device and hearing loss. If your hearing device happens to be vulnerable to interference, you may not be able to use a rated phone successfully. Trying out the phone with your hearing device is the best way to evaluate it for your personal needs.

M-Ratings: Phones rated M3 or M4 meet FCC requirements and are likely to generate less interference to hearing devices than phones that are not labeled.

M4 is the better/higher of the two ratings. Your phone meets the Mxxx level rating. Hearing devices may also be rated. Your hearing device manufacturer or hearing health professional may help you find this rating. For more information about the FCC Hearing Aid Compatibility please go to

<http://www.fcc.gov/cgb/dro>

FCC Statement

This equipment has been tested and found to comply with the limits for a Class B digital device, pursuant to Part 15 of the FCC Rules. These limits are designed to provide reasonable protection against harmful interference in a residential installation. This equipment generates, uses and can radiate radio frequency energy and, if not

installed and used in accordance with the instructions, may cause harmful interference to radio communications. However, there is no guarantee that interference will not occur in a particular installation. If this equipment does cause harmful interference to radio or television reception, which can be determined by turning the equipment off and on, the user is encouraged to try to correct the interference by one or more of the following measures:

- Reorient or relocate the receiving antenna.
- Increase the separation between the equipment and receiver.
- Connect the equipment into an outlet on a circuit different from that to which the receiver is connected.
- Consult the dealer or an experienced radio/TV technician for help.

This device complies with Part 15 of the FCC Rules. Operation is subject to the following two conditions: (1) this device may not cause harmful interference, and (2) this device must accept any interference received, including interference that may cause undesired operation.

Caution:

Changes or modifications made to this device not expressly approved by Huawei Technologies Co., Ltd. may void the FCC authorization to operate this device.

Proposition 65 Compliance Statement

Caution:

This product contains chemicals known to the State of California to cause cancer and birth defects or other reproductive harm. Wash hands after handling.

14 Futurewei Technologies, Inc. Limited Warranty

Futurewei Technologies, Inc. (“Huawei”) represents and warrants to the original purchaser (“Purchaser”) that Huawei’s phones and accessories (“Product”) are free from material defects, including improper or inferior workmanship, materials, and design, during the designated warranty period, and subject to the following terms and conditions, when used normally and in accordance with all operating instructions:

1. **Warranty Period:** Coverage under this warranty is limited to the following time periods:
 - a Phone: a period of 12 months from the date of purchase.
 - b Battery and Charger: a period of 12 months from the date of purchase.
 - c Other accessories (If included in the box set): a period of 3 months from the date of purchase.
2. This limited warranty only applies to products manufactured by or for Huawei and that can be identified by the “Huawei” trademark, trade name, or logo affixed to them. The limited

warranty does not apply to any non-Huawei products or software.

3. The Warranty extends only to Purchasers who purchased the Product in the United States of America and is not assignable or transferable to any subsequent purchaser/customer.
4. During the limited warranty period, Huawei will repair or replace at Huawei's sole option, any parts of the Product that are defective or malfunction during normal usage. Huawei reserves the right to use new or refurbished replacement parts in repair of the Product.
5. This limited warranty covers only the costs of parts and labor. Other related costs such as shipping and delivery costs may be born by purchaser at Huawei's option.
6. At Huawei's request, Purchaser must prove the date of the original purchase of the Product by a dated bill of sale or dated itemized receipt.

7. This warranty does not cover damage resulting from:
- a Abuse, accident, misuse, improper storage, exposure to liquid, moisture, or dampness;
 - b External causes such as from collision, fire, flooding, sand, dirt, windstorm, lightning, or earthquake;
 - c Exposure to extreme weather conditions, Acts of God, theft, blown fuse, or improper use of any electrical source;
 - d Computer or internet viruses, bugs, worms, Trojan Horses, cancelbots;
 - e Use with non-Huawei products or products not recommended for use with Huawei products;
 - f normal wear and tear of the equipment;
 - g Usage of equipment other than its normal and customary manner;
 - h Improper testing, operation, maintenance, installation, or any alteration or modification of Product;
 - i Consumable parts, such as batteries, unless damage has occurred due to a defect in Huawei materials and workmanship;
 - j Service performed by anyone who is not a Huawei representative or an authorized Huawei service provider;
 - k Other acts which are not the fault of Huawei, including damage caused by shipping;

- l Cosmetic damages, including but not limited to dents or scratches in decorative, structural, or non-operative parts resulting from normal customer use;
 - m Spillage of food or liquid, corrosion, rust or incorrect voltage; and
 - n The defective function of the cellular system or inadequate signal reception by the external antenna, or viruses or other software problems introduced into the Product.
8. Huawei does not warrant that the operation of this product will be uninterrupted or error-free.
9. This warranty will also be null and void in any of the following events:
- a The serial number or warranty seal on the equipment has been altered, defaced or removed;
 - b Any term contained in this warranty has been altered or modified in any way without prior written consent of Huawei;
 - c Huawei has not been notified by Purchaser of the alleged defect or malfunction of the Product during the applicable warranty period.

10. If Product is returned to Huawei after the expiration of the warranty period, Huawei's normal service policies shall apply and Purchaser will be charged accordingly.
 - a Huawei assumes no obligation or liability beyond that which is expressly provided for in this limited warranty.
 - b All warranty information, pricing, product features and specifications are subject to change.
11. This limited warranty provides Purchaser's sole and exclusive remedy to be provided by Huawei. The agents, employees, distributors, and dealers of Huawei products are not authorized to make modifications to this limited warranty, or make additional warranties binding on Huawei.

LIMIT OF LIABILITY

12. HUAWEI'S LIMIT OF LIABILITY UNDER THIS LIMITED WARRANTY SHALL BE THE ACTUAL CASH VALUE OF THE PRODUCT AT THE TIME PURCHASER RETURNS THE PRODUCT FOR REPAIR, AS DETERMINED BY THE PRICE PAID BY THE PURCHASER FOR THE PRODUCT LESS A REASONABLE AMOUNT OF USAGE. HUAWEI SHALL NOT BE LIABLE FOR ANY OTHER LOSSES OR DAMAGES SUCH AS SPECIAL, INCIDENTAL, CONSEQUENTIAL, OR PUNITIVE DAMAGES (INCLUDING BUT NOT LIMITED TO LOSS OF

ANTICIPATED BENEFITS OR PROFITS, LOSS OF SAVINGS OR REVENUE, LOSS OF DATA, LOSS OF USE OF THE PRODUCT OR ANY ASSOCIATED EQUIPMENT, COST OF CAPITAL, COST OF ANY SUBSTITUTE EQUIPMENT OR FACILITIES, DOWNTIME, ANY COSTS OF RECOVERING, REPROGRAMMING, OR REPRODUCING ANY PROGRAM OR DATA, ANY FAILURE TO MAINTAIN THE CONFIDENTIALITY OF DATA STORED ON THE PRODUCT, THE CLAIMS OF ANY THIRD PARTIES, INCLUDING SUBSEQUENT PURCHASERS, AND INJURY TO PROPERTY, RESULTING FROM THE PURCHASE OR USE OF THE PRODUCT OR ARISING FROM BREACH OF THIS WARRANTY, BREACH OF CONTRACT, NEGLIGENCE, STRICT LIABILITY, OR ANY OTHER LEGAL OR EQUITABLE THEORY, EVEN IF HUAWEI KNEW OF THE LIKELIHOOD OF SUCH DAMAGES). HUAWEI SHALL NOT BE LIABLE FOR DELAY IN RENDERING SERVICE UNDER THE LIMITED WARRANTY, OR LOSS OF USE DURING THE PERIOD THAT THE PRODUCT IS BEING REPAIRED.

DISCLAIMER OF WARRANTY

13. HUAWEI'S LIABILITY UNDER EITHER THE IMPLIED WARRANTY OF MERCHANTABILITY OR FITNESS FOR A PARTICULAR PURPOSE, SHALL BE LIMITED TO THE DURATION OF THE FOREGOING LIMITED WRITTEN WARRANTY. OTHERWISE, THE FOREGOING LIMITED

WARRANTY IS PURCHASER'S SOLE AND EXCLUSIVE REMEDY AND IS IN LIEU OF ALL OTHER WARRANTIES, EXPRESS OR IMPLIED.

14. Some states do not allow exclusion or limitation of incidental, consequential, or punitive damages, or permit limitations on the length of implied warranties, so certain of these warranty limitations may not apply to Purchaser. This limited warranty gives Purchaser specific legal rights; Purchaser may also have other rights which vary from state to state. If any term of this limited warranty is held to be illegal or unenforceable, the legality or enforceability of the remaining terms shall not be affected or impaired.
15. This limited warranty allocates risk of Product failure between Purchaser and Huawei, and Huawei's Product pricing reflects this allocation of risk and the limitations of liability contained in this limited warranty.

Contact Huawei

WEB SITE: [HTTP://WWW.HUAWEIDEVICE.COM](http://www.huaweidevice.com)

EMAIL: SUPPORTUSA@HUAWEI.COM

This contact information may change without notice. Please contact your authorized Huawei retailer for updated contact information.

By selecting a rate plan and activating your phone, you agree to the MetroPCS Terms and Conditions of Service available at metropcs.com.

Please refer color and shape to product.

Huawei reserves the right to make changes or improvements to any of the products without prior notice.

Huawei Technologies Co., Ltd.

Address: Huawei Industrial Base, Bantian, Longgang, Shenzhen 518129, People's Republic of China

Website: WWW.HUAWEIDEVICE.COM

Tel: 1877 - 4 - HUAWEI