

Copyright

**Copyright © Huawei Technologies Co., Ltd. 2011.
All rights reserved.**

No part of this document may be reproduced or transmitted in any form or by any means without prior written consent of Huawei Technologies Co., Ltd.

The product described in this manual may include copyrighted software of Huawei Technologies Co., Ltd. and possible licensors. Customers shall not in any manner reproduce, distribute, modify, decompile, disassemble, decrypt, extract, reverse engineer, lease, assign, or sublicense the said software, unless such restrictions are prohibited by applicable laws or such actions are approved by respective copyright holders under licenses.

Trademarks and Permissions



, HUAWEI, and  are trademarks or registered trademarks of Huawei Technologies Co., Ltd.

Other trademarks, product, service and company names mentioned are the property of their respective owners.

Notice

Some features of the product and its accessories described herein rely on the software installed, capacities and settings of local network, and may not be activated or may be limited by local network operators or network service providers, thus the descriptions herein may not exactly match the product or its

accessories you purchase.

Huawei Technologies Co., Ltd. reserves the right to change or modify any information or specifications contained in this manual without prior notice or obligation.

NO WARRANTY

THE CONTENTS OF THIS MANUAL ARE PROVIDED "AS IS". EXCEPT AS REQUIRED BY APPLICABLE LAWS, NO WARRANTIES OF ANY KIND, EITHER EXPRESS OR IMPLIED, INCLUDING BUT NOT LIMITED TO, THE IMPLIED WARRANTIES OF MERCHANTABILITY AND FITNESS FOR A PARTICULAR PURPOSE, ARE MADE IN RELATION TO THE ACCURACY, RELIABILITY OR CONTENTS OF THIS MANUAL.

TO THE MAXIMUM EXTENT PERMITTED BY APPLICABLE LAW, IN NO CASE SHALL HUAWEI TECHNOLOGIES CO., LTD. BE LIABLE FOR ANY SPECIAL, INCIDENTAL, INDIRECT, OR CONSEQUENTIAL DAMAGES, OR LOST PROFITS, BUSINESS, REVENUE, DATA, GOODWILL OR ANTICIPATED SAVINGS.

Import and Export Regulations

Customers shall comply with all applicable export or import laws and regulations and will obtain all necessary governmental permits and licenses in order to export, re-export or import the product mentioned in this manual including the software and technical data therein.

Contents

1 Getting Started	3
Your Phone at a Glance.....	3
Keys and Functions	4
Sport armband	6
Removing the Back Cover and the Battery Cover.....	7
Inserting the USIM/SIM Card and the Battery	8
Inserting the microSD Card.....	8
Charging the Battery.....	8
Status Icons	9
2 Text Input	11
Entering English	11
Entering Numbers.....	12
Entering a Symbol.....	12
3 Emergency Settings	13
Setting an Emergency Number	13
Making an Emergency Call	13
4 Voice Services	14
Making a Call.....	14
Answering a Call.....	14
5 Contacts	15
Adding a Contact.....	15
Searching for a Contact.....	15
6 Messaging	15
Creating and Sending a Message.....	15
Email	16
7 Media Applications	17
Taking a Photo.....	17

Recording a Video.....	18
Music Player	18
Playing a Video	19
FM Radio.....	19
Recorder.....	20
GPS Location	20
8 Organizer Applications.....	21
Compass	21
Alarms.....	22
Weather Forecast.....	22
9 Connectivity	23
Connecting via USB.....	23
Bluetooth	26
10 Security.....	27
Phone Lock.....	27
PIN and PUK.....	28
Keypad Lock	28
11 Warnings and Precautions	28

1 Getting Started

Your Phone at a Glance

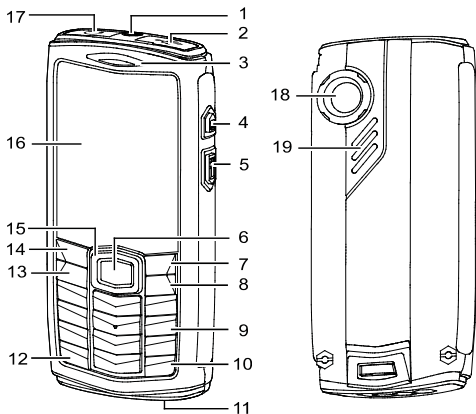

1	Flashlight	2	Charger/Data cable connector
3	Earpiece	4	Volume up key
5	Volume down key	6	Confirm key
7	Right soft key	8	End key

9	Number keys	10	# key
11	External antenna connector	12	* key
13	Call key	14	Left soft key
15	Navigation keys	16	Screen
17	Headset jack	18	Camera
19	Speaker		



Note

The preceding figure is provided for your reference only.

Keys and Functions

Call key	<ul style="list-style-type: none"> • Make or answer a call. • Access call logs in standby mode.
End key	<ul style="list-style-type: none"> • Power the phone on or off (press and hold the key). • End or reject a call. • Return to standby mode. • Turn the screen backlight on or off.
Left soft key	Select the option displayed in the lower left corner of the screen.
Right soft key	Select the option displayed in the lower right corner of the screen.

* key	Switch between the current profile and the Meeting profile (by press and hold the key).
# key	Switch between text input methods when editing text.
0 key - 9 key	<ul style="list-style-type: none"> • Enter numbers, letters, and symbols. • Call the voicemail in standby mode (press and hold the 1 key). • Speed-dial phone numbers in standby mode (press and hold the keys 2-9 if speed dial numbers are assigned).
Confirm key	Confirm a selection.
Navigation keys	<ul style="list-style-type: none"> • Switch between shortcuts when the standby screen is set to Functional mode. • Access the corresponding functions in standby mode when the standby screen is set to Concise mode.
Volume up key	<ul style="list-style-type: none"> • Increase the volume. • Access Compass in standby mode (press and hold the key).
Volume down key	<ul style="list-style-type: none"> • Decrease the volume. • Turn the flashlight on or turn off in standby mode (press and hold the key).

Sport armband

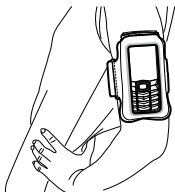
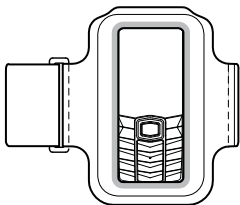

Note

- Wear the sport armband correctly by following the illustrations in the manual. Adjust the tightness till it fits well.
- Do not iron the sport armband to avoid its deformation.

Removing the Back Cover and the Battery Cover

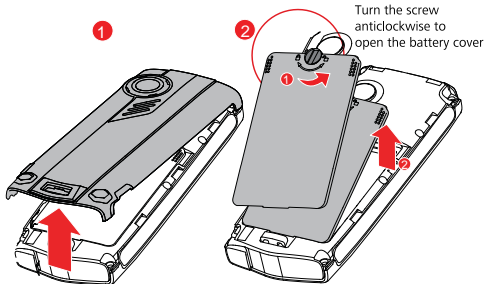

Note

Use a coin or a screwdriver to unscrew the battery cover. Do not use your fingernail.

Inserting the USIM/SIM Card and the Battery

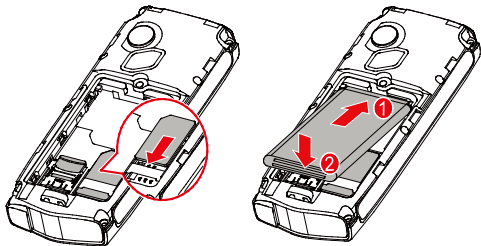

Inserting the microSD Card

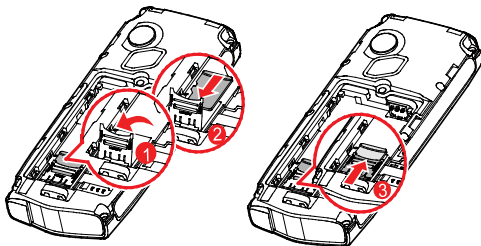

Charging the Battery

Before charging the battery ensure that it is installed in your





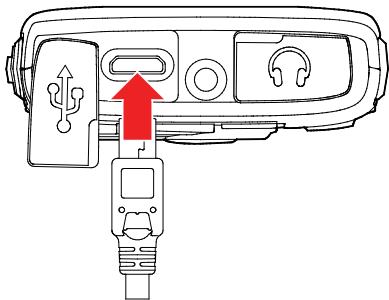















phone. Do not use a damaged battery or charger.







1. Connect the charger to a power outlet.
2. Connect the charger to the phone's charger connector.
3. Wait until the battery is fully charged. When the battery is charging, the charging icon scrolls. When the charging icon stops blinking, the battery is fully charged.
4. Unplug the charger from the power outlet.
5. Disconnect the charger from the phone.



Status Icons

	Signal strength		Roaming
	2G network available		3G network available

	Receiving and sending data on a 2G network		Receiving and sending data on a 3G network
	Call in progress		Text message memory full
	New text message received		New multimedia message received
	Multimedia message memory full		New voicemail message received
	New emergency message received		microSD card inserted
	Alarm clock enabled		Bluetooth on
	Bluetooth headset connected		Receiving data via Bluetooth
	Sending data via Bluetooth		Battery level
	Battery charging		Music player playing in the background
	General profile activated		Silent profile activated

	Meeting mode activated		Outdoor mode activated
	My profile 1 profile activated		My profile 2 profile activated
	Headset connected		Offline profile activated

2 Text Input

Entering English

Predictive English Input Mode (En)

1. Press each number key once according to the spelling of the desired word. The phone displays possible words based on the keystroke sequence.
2. Select the desired word, and press **Confirm key** or **0 key** to enter the word.
3. Press **1 key** to enter a full stop or another commonly used symbol. Press *** key** to display the symbol list. Then select and enter a symbol.



Note

- The current input mode indicator is displayed in the upper left corner of the screen. Press *** key** to change the input mode.
- On the main menu screen, select **Settings > Phone > Text input settings > Predictive input** to enable or disable predictive input mode.

When this mode is disabled, you can only enter English words in multi-tap English mode.

Multi-Tap English Input Mode (Abc)

Each number key displays letters. Press the number key once to enter the first letter displayed on the key, twice to enter the second letter, and so on.

Entering Numbers

- In **123** input mode, press the number key labeled with your desired number.
- In **Abc** input mode, repeatedly press the desired number key until the number appears on the screen.
- In **En** input mode, press the desired number key. Then use **Navigation keys** to scroll to the number and press **Confirm key** to enter it.
- In any text input mode, except the **123** input mode, press and hold a number key to enter the number.

Entering a Symbol

1. In any text input mode, press *** key** to display the symbol list.
2. Use **Navigation keys** to scroll to the desired symbol, and press **Confirm key** to enter the symbol.

Tip

- In **En** and **Abc** mode, press the **0 key** once to enter a space, twice to start a new line, and three times to enter 0.
- In **Abc** mode, repeatedly press the **1 key** to enter the commonly used

symbols. In **En** mode, press the **1 key** to display the commonly used symbols list.

3 Emergency Settings

Setting an Emergency Number

Select **Menu > Settings > Emergency** for the following options.

- **Contact 1:** Set the number of emergency contact 1.
- **Contact 2:** Set the number of emergency contact 2.
- **Number:** Set an emergency number.
- **SMS:** Set the content of the emergency message.

Making an Emergency Call

You can set two emergency contacts and one emergency number on the phone. After an emergency contact or number is set, press and hold **0 key** to make an emergency call.

If the emergency contacts and number are set, when you press and hold **0 key**:

1. The phone calls **Contact 1** and sends the emergency message to **Contact 1**.
2. If the call to **Contact 1** cannot be connected, the phone automatically calls and sends an emergency message to **Contact 2**.
3. If the call to **Contact 2** cannot be connected, the phone automatically dials **Number**.

4 Voice Services

Making a Call

Dialing a Number Using the Keypad

1. In standby mode, press the number keys to enter a phone number.
 - To make an international call, press *** key** twice to enter the international long-distance code (+). Then enter the country or region code, area code, and phone number.
 - To call an extension number, enter the switchboard number, press *** key** three times to insert P or four times to insert W, and then enter the extension number.
2. Press **Call key** to dial the number.
3. Press **End key** or select **End** to end the call.

Dialing from Contacts

Select **Menu > Contacts**, select a contact, and press **Call key** to make a call.

Dialing from Call Logs

Select **Menu > Call log** or press **Call key** to select the required number from call logs. Then press **Call key** to dial the number.

Answering a Call

When there is an incoming call, press **Call key** to answer or press **End key** to reject it.

- If the any-key answer function is enabled, you can press any

key except **End key** and **Right soft key** to answer an incoming call.

- If the headset auto-answer function is enabled and the headset is connected to the phone, incoming calls will be answered automatically.

5 Contacts

Adding a Contact

1. Select **Menu > Contacts > Create contact**.
2. Enter the contact information (at least one number for each contact).
3. Select **Save** to save the contact.

Searching for a Contact

1. Select **Menu > Contacts**.
2. Enter the contact's name in the text box. The phone automatically lists the contacts that match the search information you enter.

6 Messaging

Creating and Sending a Message

1. Select **Menu > Messages > Create message**.
2. Enter one or more recipient's numbers directly, or press **Confirm key** to access the contact list and then select one or multiple recipients.
3. Enter the message text in the text box. Press **Confirm key** to

add a picture, video, audio, or slide to the message. Doing so automatically enters MMS mode.

4. Select **Options** > **Send** to send the message.



Note

Your phone supports a maximum multimedia message size of 290 KB.

Email

Creating an Email Account

Before sending or receiving an email, you must create an email account. You are prompted to do so the first time you open the Email application.

1. Select **Menu** > **Email**, and then select **Yes** to create an email account.
2. Select the desired server from the email server list.
3. On the setup wizard screens, enter email account information.
4. Select **Done**. The email account is now created and the account name is displayed in the email menu.
5. When you want to create another email account, select **Email** > **Settings** > **Account management** > **Create account**.



Note

The server parameters are automatically set on the preset server. You only need to enter the correct email address, user name, and password.

Creating and Sending an Email

1. Select **Email**, and select the account you created.

2. Select **Create** to create an email.
3. Enter the recipient's email address, subject, and contents in the corresponding text box.
4. On the email editing screen, select **Options > Send** to send the email.

Receiving an Email

1. Select **Menu > Email > Get new emails**.
2. By default, only the email heading (sender, theme, and send time) is received. To download the email content, select **Options > Download**.



Note

To change the download mode, select an email account, and then select **Account settings > Download settings**.

7 Media Applications

Taking a Photo

1. Select **Menu > Multimedia > Camera**.
2. On the viewfinder screen, select **Options** to access the camera settings.
3. Frame the picture you want to take on the viewfinder screen. Press **Confirm key** to take a photo.
4. Your photo is automatically saved to the photo folder of the default storage that you have selected.

Recording a Video

1. Select **Menu > Multimedia > Camera > Options > Shooting mode** to switch the camera to the video camera.
2. On the viewfinder screen, select **Options** for the video camera settings.
3. Press **Confirm key** to start recording. Select **Pause/Continue** to pause or continue. Select **Stop** to stop recording.
4. Your video is automatically saved to the video folder of the storage that you have selected.

Music Player

Adding a Playlist

1. Select **Menu > Multimedia > Music player**.
2. Select **Options > Media library > Playlist**.
3. Select **Options > Create** to create a new playlist. Open the playlist and select **Add** to add songs to the playlist.



Note

You can also select **Menu > File mgmt** to select a track to play.

Playing Music

When a track is playing:

- Press **Confirm key** to pause the track. Press it again to resume playing.
- Press **Right navigation key** to play the next track. Press and hold **Right navigation key** to fast-forward the track.

- Press **Left navigation key** to play the previous track. Press and hold **Left navigation key** to rewind the track.
- Select **Options > Exit** to exit the media player.



Note

When a track is playing, select **Minimize** or press **End key** to minimize the media player screen. The media player will run in the background and the track will continue to play.

Playing a Video

1. In standby mode, select **Menu > Multimedia > Video player**.
2. Select **Options**, then **All videos** or **Playlist** to access a video list.
3. Use **Navigation keys** to scroll to the video you want to play. Then press **Confirm key** to play the video.



Note

After you select **All videos**, to display all videos saved on the phone, select **Options > Refresh** to refresh the video library.

FM Radio

The channel list is empty when you first use the FM radio. Select **Options** and then select **Automatic tuning**, **Manual tuning**, **Precise tuning**, or **Set frequency** to search for channels.

1. Select **Menu > Multimedia > FM radio** to switch on the FM radio.
2. On the FM screen:
 - Press **Confirm key** to switch between the headset and the

loudspeaker.

- Press **Left navigation key** to adjust the frequency.
- Press **Right navigation key** to switch between the channels saved in the channel list.
- Select **Minimize** to minimize the radio screen. The radio program will continue to play in the background.

To switch off the FM radio, select **Options > Exit**, or press and hold the button on the headset cable.

Recorder

1. In standby mode, select **Menu > Multimedia > Recorder**.
2. Press **Confirm key** to start recording. Select **Pause/Continue** to pause or continue.
3. Select **Stop** to stop recording. The sound clip is automatically saved to the recording folder of the default storage that you have selected.
4. Press **Confirm key** to play the sound clip.



Note

When recording a sound clip, keep your phone's microphone close to the sound source for better recording quality.

GPS Location

Select **Menu > Organizer > Location**.

The phone starts Global Positioning System (GPS) location. Once your phone has determined its location, it displays its position with latitude, longitude, and altitude information.



Note

GPS was developed and is maintained by the United States (U.S.) Government. Any adjustment to the GPS system performed by the U.S. Government may affect the accuracy of the location determined by your GPS receiver.

Generally, acquiring GPS signals outdoors takes some time, depending on the physical environment in which you are using your phone. Signal acquisition will take longer if you are in a car or an area with complicated geographical conditions, or experiencing adverse weather conditions. Buildings also affect satellite signal acquisition. Therefore, GPS location may fail if you attempt to use it indoors, in built-up areas, or in areas such as tunnels or underground garages.

GPS location is network-dependent. Before using the function, ensure that you have subscribed to your service provider's Internet access service, your USIM/SIM card supports that function, and you are in a service area. GPS location may incur data traffic charges. For details, contact your service provider.

8 Organizer Applications

Compass

1. In standby mode, select **Menu > Organizer > Compass** to access the compass.
2. Calibrate the compass when you use it for the first time, by waving the phone in the figure 8 motion until the calibration message is no longer displayed.



Note

- To ensure the direction accuracy, avoid using the compass near metal objects or magnetic fields.
- The compass provides general measurements for personal use. Avoid using the compass for any purpose that is prohibited. Inappropriate use may cause damage or danger.

Alarms

You can set a maximum of five alarms. To set an alarm, select

Menu > Organizer > Alarm.

1. On the **Alarm** screen, select an alarm. Then set the alarm time, repeat days, and alarm tone.
2. Save the settings to enable the alarm.

On the **Alarm** screen, select an alarm and then select **Off** to disable the alarm, or select **Cancel all** to disable all alarms.



Note

- When the alarm sounds, select **Stop** to stop it. If you select **Snooze**, the alarm will stop temporarily, and then sound again after five minutes.
- You can customize the repeat days by selecting the days that you want the alarm to sound.

Weather Forecast

Adding a City

1. In standby mode, select **Menu > Weather.**

2. Select **Options > Add** (or select **Add** when the city list is empty).
3. Select the desired city, update the city's weather information, and add the city to your city list.

Updating Weather Information

1. In standby mode, select **Menu > Weather**.
2. Press **Left navigation key** or **Right navigation key** to select the desired city and select **Options > Update** to update the city's weather information.

9 Connectivity

Connecting via USB

Installing PC Suite

The PC Suite software supplied with your phone runs automatically after you connect your phone to a PC with the USB cable. To install PC Suite:

1. Connect your phone to a PC with the USB cable.
2. Double-click **My Computer**. Find and double-click the disk named **HUAWEI ASSITANT**. Wait for the dialog box to appear on your PC. If the dialog box does not appear automatically, choose **My Computer > HUAWEI ASSITANT > Setup.exe** to run the installation program and display the dialog box.

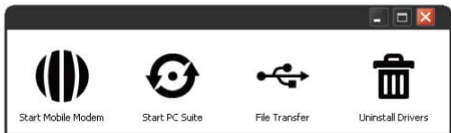

3. Click **Start PC Suite** to install PC Suite.
4. Follow the wizard to complete installation.
5. PC Suite starts automatically after installation is complete. After your phone is detected, you can manage your contacts, files, and calendar, synchronize emails, and send messages on PC Suite.



Note

- To download the general edition of PC Suite, choose **Support > Downloads** on Huawei Device website:
<http://www.huaweidevice.com>.
- To find out how to transfer files using PC Suite, see the help document embedded in the software.

Using the microSD Card as the USB Mass Storage

1. Connect your phone to a PC using the USB cable.
2. Double-click **My Computer**. Find and double-click the disk named **HUAWEI ASSITANT**. Wait for the dialog box to appear on your PC.

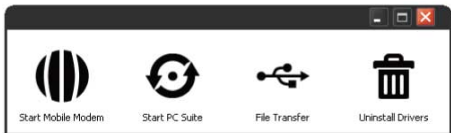

3. Click **File Transfer**. Your PC will identify the microSD card as a removable device. You can then transfer files between your PC and the microSD card.
4. After you have finished transferring files, safely remove your phone from the PC as prompted.



Note

Some functions may not be available on your phone when you use it as a USB mass storage.

Using the Phone as a Modem

When you connect your phone to a PC with the USB cable, you can use the phone as a modem for Internet access.

You can use this function on a PC that runs Windows 2000, Windows XP, Windows Vista, or Windows 7.

1. Connect your phone to a PC with the USB cable.
2. Double-click **My Computer**. Find and double-click the disk named **HUAWEI ASSITANT**. Wait for the dialog box to appear on your PC.

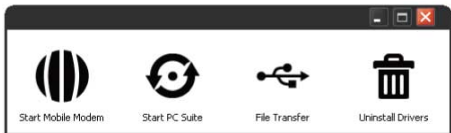

3. Click **Start Mobile Modem** and follow the wizard to complete installation. Click **Connect** on the displayed dialog box to set up a connection and access the Internet.



Note

For details, contact your service provider.

Bluetooth

Transferring Data via Bluetooth

You can transfer data between your phone and other Bluetooth devices. To do so, ensure that the target device supports Bluetooth and its Bluetooth function is enabled.

1. Select **Menu > Settings > Bluetooth** to enable the Bluetooth function.
2. Select **Search for devices** to search for available Bluetooth devices.
3. Scroll to the desired Bluetooth device and select **Pair**. When you pair your phone with the device for the first time, a password is required.
4. Transfer data between your phone and the Bluetooth device.

Using a Bluetooth Headset

You can talk using a Bluetooth headset or a Bluetooth loudspeaker. For more information, see the user manual for the relevant device.

1. Switch on the Bluetooth headset and keep it in the discoverable state.
2. Select **Menu > Settings > Bluetooth** to enable the phone's Bluetooth function.
3. Select **Search for devices** to search for available Bluetooth devices.
4. Scroll to the desired Bluetooth headset and select **Pair**. When you pair your phone with the headset for the first time, a password is required.
5. Use the Bluetooth headset.

10 Security

Phone Lock

The phone lock protects your phone from unauthorized use. By default, the phone lock is disabled. You can change the preset phone password **000000** to a numeric string of 4 to 8 digits.

1. Select **Menu > Settings > Security > Phone lock**.
2. Use **Navigation keys** to select:
 - **On**: Enable the phone lock when the phone is next powered on.
 - **Off**: Disable the phone lock.

PIN and PUK

The personal identification number (PIN) protects your USIM/SIM card from unauthorized use. The PIN unblocking key (PUK) can unlock a blocked PIN. Both the PIN and the PUK are delivered with the USIM/SIM card. For details, contact your service provider.

If you incorrectly enter the PIN three times, the PIN is blocked and the phone prompts you to enter the PUK.

If you incorrectly enter the PUK 10 times, the USIM/SIM card become permanently invalid, and you must contact your service provider for a new card.

Keypad Lock

When the keypad is locked, you can still answer incoming calls or make emergency calls by pressing **Call key**.

1. Press and hold **# key** to lock the key pad.
2. Press **Left soft key**, then **Right soft key** to unlock the keypad.

11 Warnings and Precautions

This section contains important information pertaining to the operating instructions of your device. It also contains information about how to use the device safely. Read this information carefully before using your device.

Electronic Device

Power off your device if using the device is prohibited. Do not use the device when using the device causes danger or interference with electronic devices.

Medical Device

- Follow rules and regulations set forth by hospitals and health care facilities. Do not use your device when using the device is prohibited.
- Pacemaker manufacturers recommend that a minimum distance of 15 cm be maintained between a device and a pacemaker to prevent potential interference with the pacemaker. If you are using a pacemaker, use the device on the opposite side of the pacemaker and do not carry the device in your front pocket.

Potentially Explosive Atmosphere

Power off your device in any area with a potentially explosive atmosphere, and comply with all signs and instructions. Areas that may have potentially explosive atmospheres include the areas where you would normally be advised to turn off your vehicle engine. Triggering of sparks in such areas could cause an explosion or a fire, resulting in bodily injuries or even deaths. Do not power on your device at refueling points such as service stations. Comply with restrictions on the use of radio equipment in fuel depots, storage, and distribution areas, and chemical plants. In addition, adhere to restrictions in areas where blasting operations are in progress. Before using the device, watch out for areas that have potentially explosive atmospheres that are often, but not always, clearly marked. Such locations include areas below the deck on boats, chemical transfer or storage facilities, and areas where the air contains chemicals or particles such as grain, dust,

or metal powders. Ask the manufacturers of vehicles using liquefied petroleum gas (such as propane or butane) whether this device can be safely used in their vicinity.

Traffic Security

Observe local laws and regulations while using the device. In addition, if using the device while driving a vehicle, comply with the following guidelines:

- Concentrate on driving. Your first responsibility is to drive safely.
- Do not talk on the device while driving. Use hands-free accessories.
- When you have to make or answer a call, park the vehicle at the road side before using your device.
- RF signals may affect electronic systems of motor vehicles. For more information, consult the vehicle manufacturer.
- In a motor vehicle, do not place the device over the air bag or in the air bag deployment area. Otherwise, the device may hurt you owing to the strong force when the air bag inflates.
- Do not use your device while flying in an aircraft. Power off your device before boarding an aircraft. Using wireless devices in an aircraft may cause danger to the operation of the aircraft and disrupt the wireless telephone network. It may also be considered illegal.

Operating Environment

- Do not use or charge the device in dusty, damp, and dirty places or places with magnetic fields. Otherwise, it may result

in a malfunction of the circuit.

- The device complies with the RF specifications when the device is used near your ear or at a distance of 1.5 cm from your body. Ensure that the device accessories such as a device case and a device holster are not composed of metal components. Keep your device 1.5 cm away from your body to meet the requirement earlier mentioned.
- On a stormy day with thunder, do not use your device when it is being charged, to prevent any danger caused by lightning.
- When you are on a call, do not touch the antenna. Touching the antenna affects the call quality and results in increase in power consumption. As a result, the talk time and the standby time are reduced.
- While using the device, observe the local laws and regulations, and respect others' privacy and legal rights.
- Keep the ambient temperature between 0°C and 40°C while the device is being charged. Keep the ambient temperature between 0°C to 40°C for using the device powered by a battery.

Prevention of Hearing Damage

Using a headset at high volume can damage your hearing. To reduce the risk of damage to hearing, lower the headset volume to a safe and comfortable level.

Safety of Children

Comply with all precautions with regard to children's safety.

Letting the child play with your device or its accessories, which

may include parts that can be detached from the device, may be dangerous, as it may present a choking hazard. Ensure that small children are kept away from the device and accessories.

Accessories

Use the accessories delivered only by the manufacturer. Using accessories of other manufacturers or vendors with this device model may invalidate any approval or warranty applicable to the device, result in the non-operation of the device, and cause danger.

Battery and Charger

- Unplug the charger from the electrical plug and the device when not in use.
- The battery can be charged and discharged hundreds of times before it eventually wears out. When the standby time and the talk time are shorter than the normal time, replace the battery.
- Use the AC power supply defined in the specifications of the charger. An improper power voltage may cause a fire or a malfunction of the charger.
- Do not connect two poles of the battery with conductors, such as metal materials, keys, or jewelries. Otherwise, the battery may be short-circuited and may cause injuries and burns on your body.
- Do not disassemble the battery or solder the battery poles. Otherwise, it may lead to electrolyte leakage, overheating, fire, or explosion.
- If battery electrolyte leaks out, ensure that the electrolyte does

not touch your skin and eyes. When the electrolyte touches your skin or splashes into your eyes, wash your eyes with clean water immediately and consult a doctor.

- If there is a case of battery deformation, color change, or abnormal heating while you charge or store the battery, remove the battery immediately and stop using it. Otherwise, it may lead to battery leakage, overheating, explosion, or fire.
- If the power cable is damaged (for example, the cord is exposed or broken), or the plug loosens, stop using the cable at once. Otherwise, it may lead to an electric shock, a short circuit of the charger, or a fire.
- Do not dispose of batteries in fire as they may explode. Batteries may also explode if damaged.

Cleaning and Maintenance

- The device, battery, and charger are not water-resistant. Keep them dry. Protect the device, battery, and charger from water or vapor. Do not touch the device or the charger with a wet hand. Otherwise, it may lead to a short circuit, a malfunction of the device, and an electric shock to the user.
- Do not place your device, battery, and charger in places where they can get damaged because of collision. Otherwise, it may lead to battery leakage, device malfunction, overheating, fire, or explosion.
- Do not place magnetic storage media such as magnetic cards and floppy disks near the device. Radiation from the device

may erase the information stored on them.

- Do not leave your device, battery, and charger in a place with an extreme high or low temperature. Otherwise, they may not function properly and may lead to a fire or an explosion. When the temperature is lower than 0°C, performance of the battery is affected.
- Do not place sharp metal objects such as pins near the earpiece. The earpiece may attract these objects and hurt you when you are using the device.
- Before you clean or maintain the device, power off the device and disconnect it from the charger.
- Do not use any chemical detergent, powder, or other chemical agents (such as alcohol and benzene) to clean the device and the charger. Otherwise, parts of the device may be damaged or a fire can be caused. You can clean the device and the charger with a piece of damp and soft antistatic cloth.
- Do not dismantle the device or accessories. Otherwise, the warranty on the device and accessories is invalid and the manufacturer is not liable to pay for the damage.

Emergency Call

You can use your device for emergency calls in the service area. The connection, however, cannot be guaranteed in all conditions. You should not rely solely on the device for essential communications.

Certification Information (SAR)

This device meets guidelines for exposure to radio waves.

Your device is a low-power radio transmitter and receiver. As recommended by international guidelines, the device is designed not to exceed the limits for exposure to radio waves. These guidelines were developed by the independent scientific organization International Commission on Non-Ionizing Radiation Protection (ICNIRP) and include safety measures designed to ensure safety for all users, regardless of age and health.

The Specific Absorption Rate (SAR) is the unit of measurement for the amount of radio frequency energy absorbed by the body when using a device. The SAR value is determined at the highest certified power level in laboratory conditions, but the actual SAR level of the device when being operated can be well below the value. This is because the device is designed to use the minimum power required to reach the network.

The SAR limit adopted by USA and Canada is 1.6 watts/kilogram (W/kg) averaged over one gram of tissue. The highest SAR value reported to the FCC and IC for this device type when tested for use at the ear is 1.080/kg, and when properly worn on the body is 0.569 W/kg.

FCC Statement

This equipment has been tested and found to comply with the limits for a Class B digital device, pursuant to Part 15 of the FCC Rules. These limits are designed to provide reasonable protection

against harmful interference in a residential installation. This equipment generates, uses and can radiate radio frequency energy and, if not installed and used in accordance with the instructions, may cause harmful interference to radio communications.

However, there is no guarantee that interference will not occur in a particular installation. If this equipment does cause harmful interference to radio or television reception, which can be determined by turning the equipment off and on, the user is encouraged to try to correct the interference by one or more of the following measures:

- Reorient or relocate the receiving antenna.
- Increase the separation between the equipment and receiver.
- Connect the equipment into an outlet on a circuit different from that to which the receiver is connected.
- Consult the dealer or an experienced radio/TV technician for help.

This device complies with Part 15 of the FCC Rules. Operation is subject to the following two conditions: (1) this device may not cause harmful interference, and (2) this device must accept any interference received, including interference that may cause undesired operation.

Caution

Changes or modifications made to this device not expressly approved by Huawei Technologies Co., Ltd. may void the FCC authorization to operate this device.