

# INSPIRON™

## SETUP GUIDE



YOURS IS HERE



# INSPIRON™

## SETUP GUIDE

Regulatory Model P04T series

Regulatory Type P04T001

# Notes, Cautions, and Warnings



**NOTE:** A NOTE indicates important information that helps you make better use of your computer.



**CAUTION:** A CAUTION indicates either potential damage to hardware or loss of data and tells you how to avoid the problem.



**WARNING:** A WARNING indicates a potential for property damage, personal injury, or death.

If you purchased a Dell™ n Series computer, any references in this document to Microsoft® Windows® operating systems are not applicable.

---

**Information in this document is subject to change without notice.**

© 2009 Dell Inc. All rights reserved.

Reproduction of these materials in any manner whatsoever without the written permission of Dell Inc. is strictly forbidden.

Trademarks used in this text: *Dell*, the *DELL* logo, *Inspiron*, *YOURS IS HERE*, *Dell On Call*, and *DellConnect* are trademarks of Dell Inc.; *Intel* is a registered trademark, *Core* and *Atom* are the trademarks of Intel Corporation in the U.S. and other countries; *Microsoft*, *Windows*, and *Windows* start button logo are either trademarks or registered trademarks of Microsoft Corporation in the United States and/or other countries; *Ubuntu* is a registered trademark of Canonical Ltd.

Other trademarks and trade names may be used in this document to refer to either the entities claiming the marks and names or their products. Dell Inc. disclaims any proprietary interest in trademarks and trade names other than its own.

# Contents

<b>Setting Up Your Inspiron Laptop</b> . . . . .	<b>5</b>	Display Features . . . . .	28
Before Setting Up Your Computer . . . . .	5	Removing and Replacing the Battery . . . . .	30
Connect the AC Adapter . . . . .	6	Software Features . . . . .	32
Connect the Network Cable (Optional) . . . . .	7	Dell DataSafe Online Backup . . . . .	35
Press the Power Button . . . . .	8	Dell Dock . . . . .	36
Set Up the Operating System . . . . .	9	<b>Solving Problems</b> . . . . .	<b>37</b>
Install the SIM Card (Optional) . . . . .	10	Beep Codes . . . . .	37
Enable or Disable Wireless (Optional) . . . . .	12	Network Problems . . . . .	38
Connect to the Internet (Optional) . . . . .	14	Power Problems . . . . .	39
Set Up the TV Tuner . . . . .	17	Memory Problems . . . . .	40
<b>Using Your Inspiron Laptop</b> . . . . .	<b>18</b>	Lockups and Software Problems . . . . .	41
Right Side Features . . . . .	18	<b>Using Support Tools</b> . . . . .	<b>43</b>
Left Side Features . . . . .	20	Dell Support Center . . . . .	43
Back Side Features . . . . .	22	System Messages . . . . .	44
Computer Base Features . . . . .	24	Hardware Troubleshooter . . . . .	45
Touch Pad Gestures . . . . .	27	Dell Diagnostics . . . . .	46

## Contents

<b>Restoring Your Operating System</b> .....	<b>50</b>	<b>Appendix</b> .....	<b>73</b>
System Restore .....	51	Macrovision Product Notice.....	73
Dell Factory Image Restore .....	52	Information for NOM, or Official Mexican Standard (Only for Mexico).....	74
Operating System Reinstallation .....	54	<b>Index</b> .....	<b>75</b>
<b>Getting Help</b> .....	<b>57</b>		
Technical Support and Customer Service .....	58		
DellConnect™ .....	58		
Online Services .....	59		
Automated Order-Status Service.....	60		
Product Information.....	60		
Returning Items for Repair Under Warranty or for Credit .....	61		
Before You Call.....	63		
Contacting Dell.....	65		
<b>Finding More Information and Resources</b> .....	<b>66</b>		
<b>Basic Specifications</b> .....	<b>68</b>		

# Setting Up Your Inspiron Laptop

This section provides information about setting up your Inspiron™ laptop.

## Before Setting Up Your Computer

When positioning your computer, ensure that you allow easy access to a power source, adequate ventilation, and a level surface to place your computer.

Restricting airflow around your Inspiron laptop may cause it to overheat. To prevent overheating ensure that you leave at least 10.2 cm (4 inches) at the back of the computer and a minimum of 5.1 cm (2 inches) on all other sides. You should never place your computer in an enclosed space, such as a cabinet or drawer when it is powered on.

 **WARNING:** Do not block, push objects into, or allow dust to accumulate in the air vents. Do not store your Dell™ computer in a low-airflow environment, such as a closed briefcase, while it is powered on. Restricting the airflow can damage the computer or cause a fire.

 **CAUTION:** Placing or stacking heavy or sharp objects on the computer may result in permanent damage to the computer.

## Connect the AC Adapter

Connect the AC adapter to the computer and then plug it into an electrical outlet or surge protector.

 **WARNING:** The AC adapter works with electrical outlets worldwide. However, power connectors and power strips vary among countries. Using an incompatible cable or improperly connecting the cable to a power strip or electrical outlet may cause fire or permanent damage to your computer.

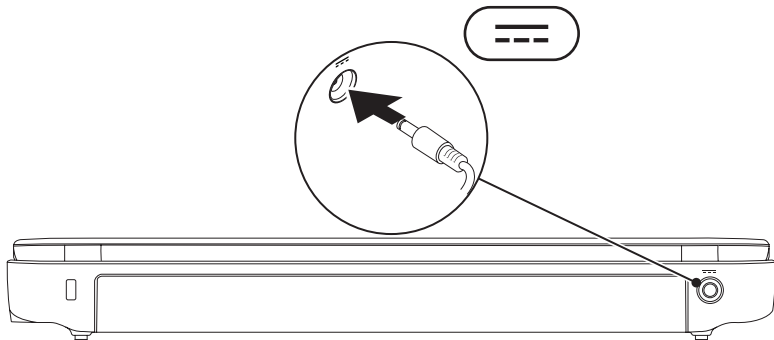



## Connect the Network Cable (Optional)

To use a wired network connection, connect the network cable.

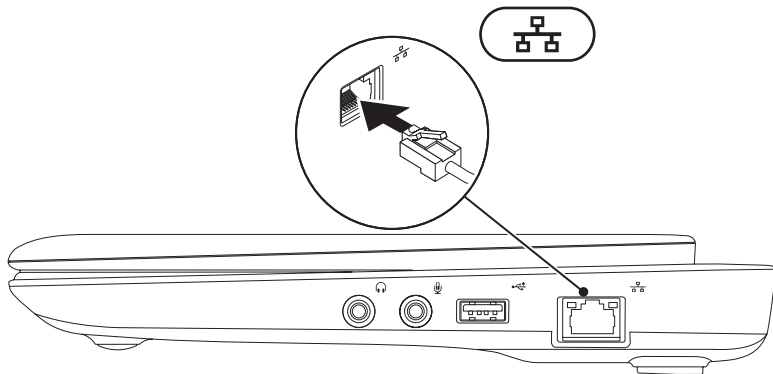

## Press the Power Button

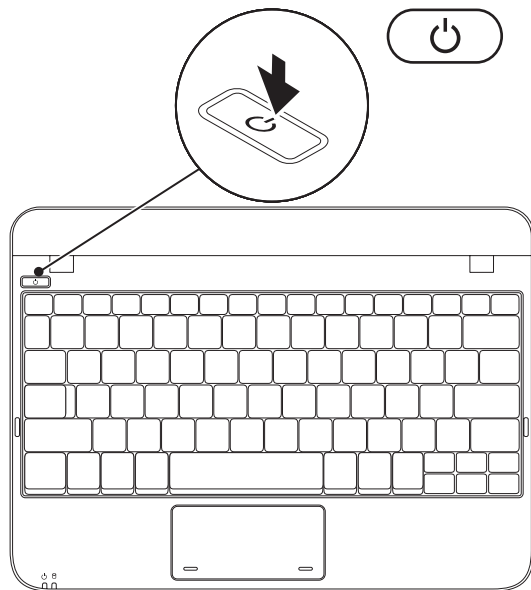

## Set Up the Operating System

Your Dell computer is preconfigured with the operating system you selected at the time of purchase.

### Microsoft® Windows®

To set up Windows for the first time, follow the instructions on the screen. These steps are mandatory and may take some time to complete. The Windows setup screens will take you through several procedures including accepting license agreements, setting preferences, and setting up an Internet connection.

 **CAUTION:** Do not interrupt the operating system's setup process. Doing so may render your computer unusable and you will need to reinstall the operating system.

### Ubuntu®

To set up Ubuntu for the first time, follow the instructions on the screen. See the Ubuntu documentation that shipped with your computer for more operating system specific information.

 **NOTE:** For optimal performance of your computer, it is recommended that you download and install the latest BIOS and drivers for your computer available at [support.dell.com](http://support.dell.com).

## Install the SIM Card (Optional)

Installing a Subscriber Identity Module (SIM) card allows you to browse the Internet, check e-mail, and connect to a Virtual Private Network. To access these features, you must be within the network of your cellular service provider.

- 1 battery bay
- 2 SIM card
- 3 SIM card slot

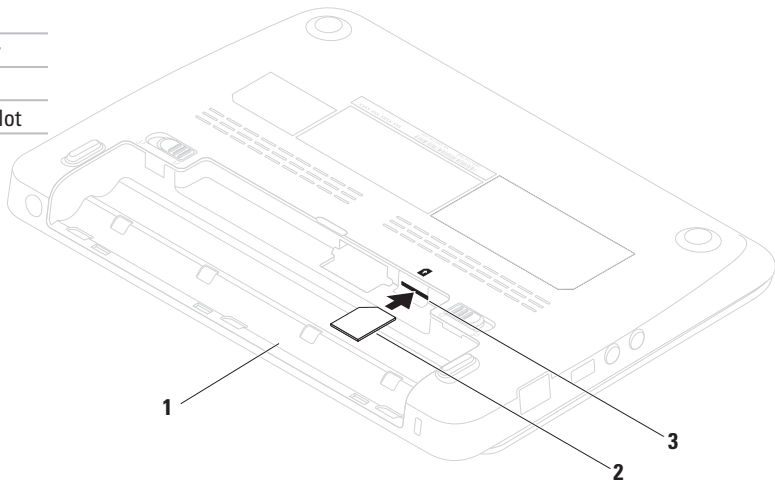

To install the SIM card:

1. Turn off your computer.
2. Remove the battery (see “Removing and Replacing the Battery” on page XX).
3. In the battery bay, slide the SIM card into the SIM card slot.
4. Replace the battery (see “Removing and Replacing the Battery” on page XX).
5. Turn on your computer.

To remove the SIM card, press and eject the SIM card.

## Enable or Disable Wireless (Optional)

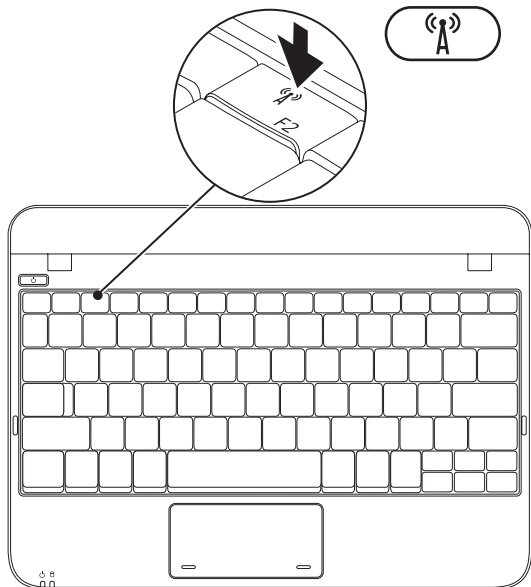

To enable wireless:

1. Turn on your computer.
2. Double-click the  icon on the system tray or press <F2>.

The **Wireless Enable/Disable** dialog box appears.

3. Select the option(s) you want to enable:
  - **Enable Bluetooth**
  - **Enable Wireless LAN**
  - **Enable Wireless WAN/GPS**
4. Click **OK**.

To disable wireless:

1. Double-click the  icon on the system tray or press <F2>.

The **Wireless Enable/Disable** dialog box appears.

2. Clear the option(s) you want to disable:
  - **Enable Bluetooth**
  - **Enable Wireless LAN**
  - **Enable Wireless WAN/GPS**
3. Click **OK**.

### Connect to the Internet (Optional)

To connect to the Internet, you need an external modem or network connection and an Internet service provider (ISP).

If an external USB modem or WLAN adapter is not a part of your original order, you can purchase one at [www.dell.com](http://www.dell.com).

#### Setting Up a Wired Connection

- If you are using a dial-up connection, connect the telephone line to the external USB modem (optional) and to the telephone wall jack before you set up your Internet connection.
- If you are using a DSL or cable/satellite modem connection, contact your ISP or cellular telephone service for setup instructions.

#### Setting Up a Wireless Connection

Before you can use your wireless Internet connection, you need to connect to your wireless router.

To set up your connection to a wireless router:

*Windows XP*

 **NOTE:** The following steps were written for the Windows default view, so they may not apply if you set your Dell™ computer to the Windows Classic view.

1. Ensure that wireless is enabled on your computer (see “Enable or Disable Wireless” on page XX).
2. Save and close any open files, and exit any open programs.
3. Click **Start** → **Control Panel** → **Network and Internet Connections** → **Wireless Network Setup**.
4. Follow the instructions on the screen to complete the setup.



### Windows 7

1. Ensure that wireless is enabled on your computer (see “Enable or Disable Wireless” on page XX).
2. Save and close any open files, and exit any open programs.
3. Click **Start**  → **Control Panel** → **Network and Sharing Center** → **Connect to a network**.
4. Follow the instructions on the screen to complete the setup.

### Setting Up Your Internet Connection

ISPs and ISP offerings vary by country. Contact your ISP for offerings available in your country.

If you cannot connect to the Internet but have successfully connected in the past, the ISP might have a service outage. Contact your ISP to check the service status, or try connecting again later.

Have your ISP information ready. If you do not have an ISP, the **Connect to the Internet** wizard can help you get one.

## Setting Up Your Inspiron Laptop

To setup your Internet connection:

### *Windows XP*

 **NOTE:** The following steps were written for the Windows default view, so they may not apply if you set your Dell™ computer to the Windows Classic view.

1. Save and close any open files, and exit any open programs.
2. Click **Start**→ **Control Panel**.
3. Under **Network and Internet Connections**, select **Setup or Change Your Internet Connection**.
4. Click **Setup**.  
The **New Connection Wizard** appears.
5. Click **Connect to the Internet**.

 **NOTE:** Your computer does not have an internal optical drive. Use an external optical drive or any external storage device for the procedures that involve discs.

6. In the next window, click the appropriate option:

- If you do not have an ISP, click **Choose from a list of Internet service providers (ISPs)**.
- If you have already obtained setup information from your ISP but you did not receive a setup CD, click **Set up my connection manually**.
- If you have a setup CD, click **Use the CD I got from an ISP**.

7. Click **Next**.

If you selected **Set up my connection manually** in step 6, continue to step 8. Otherwise, follow the instructions on the screen to complete the setup.

 **NOTE:** If you do not know which type of connection to select, contact your ISP.

8. Click the appropriate option under **How do you want to connect to the Internet?**, and click **Next**.

9. Use the setup information provided by your ISP to complete the setup.

### Windows 7

1. Save and close any open files, and exit any open programs.
2. Click **Start**  → **Control Panel**.
3. Click **Network and Sharing Center** → **Set up a new connection or network** → **Connect to the Internet**.

The **Connect to the Internet** window appears.

-  **NOTE:** If you do not know which type of connection to select, click **Help me choose** or contact your ISP.
4. Follow the instructions on the screen and use the setup information provided by your ISP to complete the setup.



## Set Up the TV Tuner

 **NOTE:** Availability of the TV tuner may vary by region.

To set up the TV tuner for the first time:

1. Click **Start** → **All Programs**.
2. Click **Dell Digital TV**  → **Dell Digital TV**  and follow the instructions on the screen.

To re-configure your TV tuner settings:

1. Click **Start** → **All Programs**.
2. Click **Dell Digital TV**  → **Dell Digital TV**.
3. Click **Scan** .

The scan wizard will scan for the channels available in your region.

# Using Your Inspiron Laptop

This section provides information about the features available on your Inspiron™ laptop.

## Right Side Features

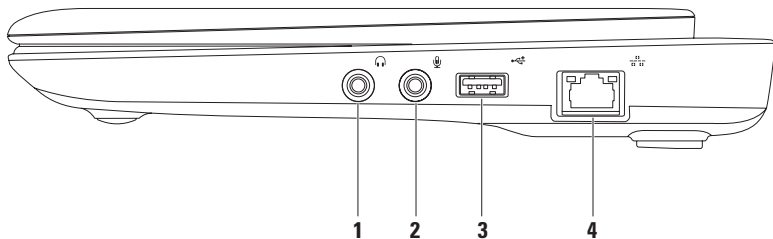

---

1  **Audio out/Headphone connector** — Connects to a pair of headphones or to a powered speaker or sound system.

---

2  **Audio in/Microphone connector** — Connects to a microphone or inputs signal for use with audio programs.

---

3  **USB 2.0 connector** — Connects to USB devices, such as a mouse, keyboard, printer, external drive, or MP3 player.

---

4  **Network connector** — Connects your computer to a network or a broadband device if you are using a wired network.

---

## Left Side Features

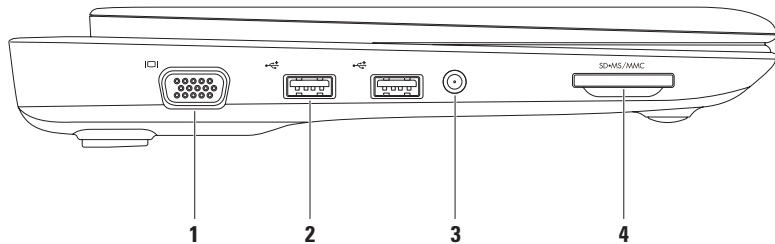

- 
- 1  **VGA connector** — Connects to a monitor or projector.

---

  - 2  **USB 2.0 connectors (2)** — Connect to USB devices, such as a mouse, keyboard, printer, external drive, or MP3 player.

---

  - 3 **Antenna in connector (on supported models)** — Connects to an external antenna, through a MCX connector, to view programs using the TV tuner card (optional). For more information on TV tuner card setup, see “Setting up the TV Tuner” on page XX.

---

  - 4  **3-in-1 Media Card Reader** — Provides a fast and convenient way to view and share digital photos, music, videos, and documents stored on the following digital memory cards:
    - Secure Digital (SD) memory card
    - Secure Digital High Capacity (SDHC) card
    - Multimedia Card (MMC)
    - Memory Stick
    - Memory Stick PRO
-

## Back Side Features





- 
- 1 Security cable slot** — Attaches a commercially available security cable to the computer.

**NOTE:** Before you buy a security cable, ensure that it works with the security cable slot on your computer.

---

- 2**  **AC adapter connector** — Connects to an AC adapter to power the computer and charge the battery.
-

## Computer Base Features

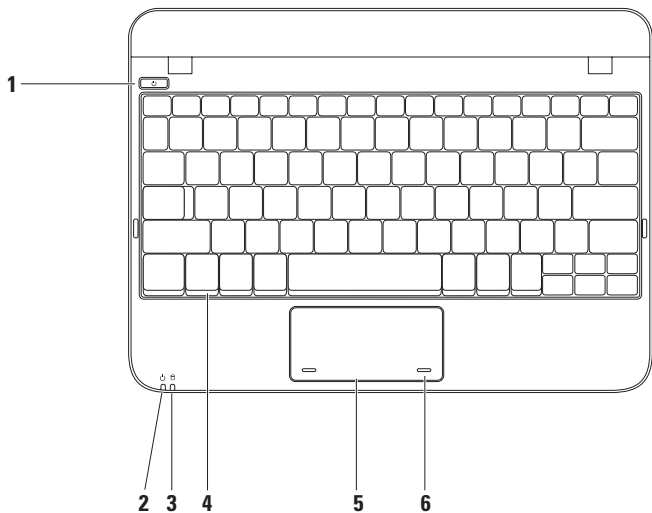

- 
- 1  **Power button** — Turns the computer on or off when pressed.
- 

- 2  **Power/Battery indicator light** — The light indicates the following states when the computer is powered using either the AC adapter or the battery.

	Indicator light status	Computer state(s)	Battery charge level
<b>AC Adapter</b>	Solid white	on off/hibernate	charging <90%
	Breathing white	standby	charging
	off	off/hibernate	>90%
<b>Battery</b>	Solid white	on	>10%
	Breathing white	standby	>=10%
	Solid amber	on/standby	<10%
	off	off/hibernate	n/a

**NOTE:** The battery is charging when the computer is powered using an AC adapter.

---

- 3  **Hard drive activity light** — Turns on when the computer reads or writes data. A blinking light indicates hard drive activity.
-

**4 Keyboard** — For more information on keyboard, see the *Dell Technology Guide* available on your hard drive or at [support.dell.com/manuals](http://support.dell.com/manuals).

---

**5 Touch pad** — Provides the functionality of a mouse to move the cursor, drag or move selected items, and left-click by tapping the surface. It supports the Scroll feature. For more information, see “Touch Pad Gestures” on page xx.

---

**6 Touch pad buttons (2)** — Provide left- and right-click functions like those on a mouse.

---

## Touch Pad Gestures

### Scroll

Allows you to scroll through content. The scroll feature includes:

**Traditional Scroll** – Allows you to scroll up and down, or right and left.

*To scroll up and down:*

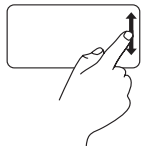

Move a finger up or down in the vertical scroll zone (extreme right of the touch pad).

*To scroll right and left:*

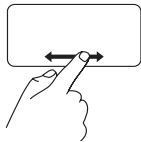

Move a finger right or left in the horizontal scroll zone (extreme bottom of the touch pad).

**Circular Scroll** – Allows you to scroll up and down, or right and left.

*To scroll up and down:*

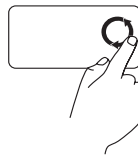

Move a finger in the vertical scroll zone (extreme right of the touch pad), in a clockwise circular motion to scroll up or counterclockwise circular motion to scroll down.

*To scroll right and left:*

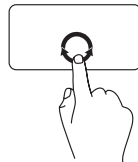

Move a finger in the horizontal scroll zone (extreme bottom of the touch pad), in a clockwise circular motion to scroll right or counterclockwise circular motion to scroll left.

## Display Features

The display panel holds a camera and accompanying dual digital microphones.

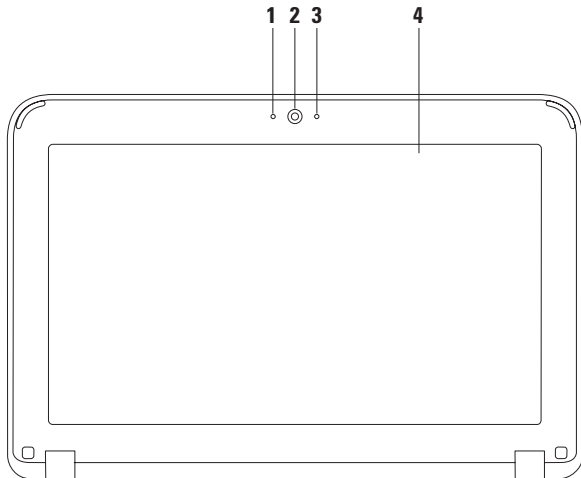

- 
- 1 Left digital array microphone** — Combines with the right digital array microphone to provide high quality sound for video conferencing and voice recording.

---

  - 2 Camera** — Built-in camera for video capture, conferencing, and chat.



---

  - 3 Right digital array microphone** — Combines with the left digital array microphone to provide high quality sound for video conferencing and voice recording.

---

  - 4 Display** — Your display can vary based on selections you made when purchasing your computer. For more information about displays, see the *Dell Technology Guide* available on your hard drive or at [support.dell.com/manuals](http://support.dell.com/manuals).
-

## Removing and Replacing the Battery

-  **WARNING:** Before you begin any of the procedures in this section, follow the safety instructions that shipped with your computer.
-  **WARNING:** Using an incompatible battery may increase the risk of fire or explosion. This computer should only use a battery purchased from Dell. Do not use batteries from other computers.
-  **WARNING:** Before removing the battery, shut down the computer, and remove external cables (including the AC adapter).

To remove the battery:

1. Slide the battery release latches to unlock position.
2. Rotate and lift the battery out of the battery bay.

To replace the battery:

1. Align the tabs on the battery with the slots in the battery bay and gently press the battery until it clicks into place.



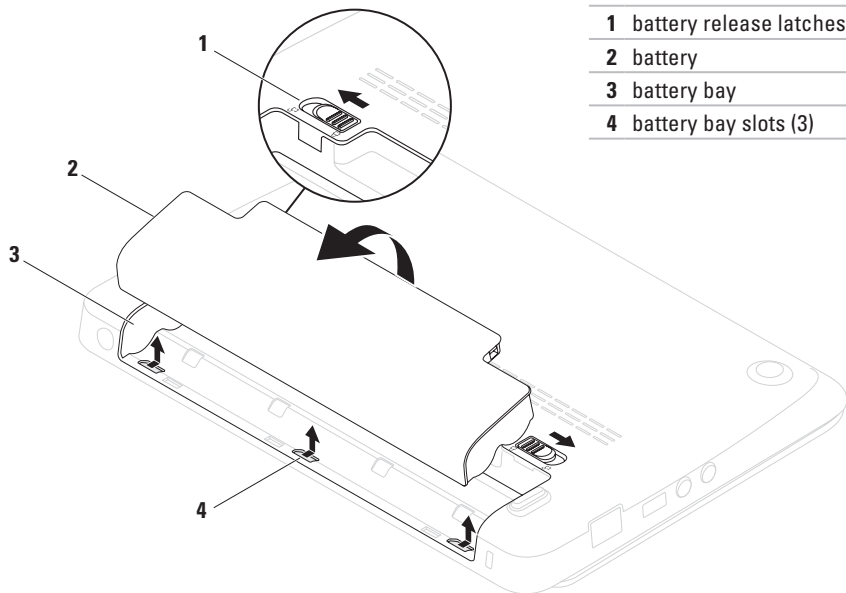

## Software Features

 **NOTE:** For more information about the features described in this section, see the *Dell Technology Guide* available on your hard drive or at [support.dell.com/manuals](http://support.dell.com/manuals).

### Productivity and Communication

You can use your computer to create presentations, brochures, greeting cards, fliers, and spreadsheets. You can also edit and view digital photographs and images. Check your purchase order for software installed on your computer.

After connecting to the Internet, you can access websites, setup an e-mail account, upload and download files.

### Entertainment and Multimedia

You can use your computer to watch videos, play games, create your own CDs/DVDs, and listen to music and Internet radio stations.

You can download or copy pictures and video files from portable devices, such as digital cameras and cell phones. Optional software applications enable you to organize and create music and video files that can be recorded to disc, saved on portable products such as MP3 players and handheld entertainment devices, or played and viewed directly on connected TVs, projectors, and home theater equipment.

### Customizing the Desktop

You can customize your desktop to change the appearance, resolution, wallpaper, screensaver, or other features of your desktop.

### *Windows XP*

1. Right-click an open area of the desktop.
2. Click **Properties**, to open the **Display Properties** window and learn more about your customization options.

### *Windows 7*

1. Right-click an open area of the desktop.
2. Click **Personalize**, to open the **Change the visuals and sounds on your computer** window and learn more about your customization options.

## **Customizing Your Energy Settings**

You can use the power options in your operating system to configure the power settings on your computer. The Microsoft® Windows® operating system installed on your Dell computer provides the following options:

- **Balanced** — Automatically balances the performance of your computer by consuming energy on capable hardware.

- **Power saver** — Saves power on your computer by reducing system performance to maximize the life of the computer and by reducing the amount of energy consumed by your computer over its lifetime.
- **High Performance** — Provides the highest level of system performance on your computer by adapting processor speed to your activity and by maximizing system performance.

### Transferring Information to a New Computer

To transfer information to a new computer:

*Windows XP*

 **NOTE:** The following instructions are applicable for the Windows default view, and may not apply if you set your computer to the Windows Classic view.

1. Click **Start** → **All Programs** → **Accessories** → **System Tools** → **Files and Settings Transfer Wizard**.
2. Follow the instructions in the **Files and Settings Transfer Wizard** wizard.

*Windows 7*

1. Click **Start**  → **Control Panel**.
2. In the search box, type `Transfer` and then click **Transfer files from another computer**.
3. Follow the instructions in the **Windows Easy Transfer** wizard.

### Backing Up Your Data

It is recommended that you periodically back up files and folders on your computer.

To back up files:

*Windows XP*

1. Click **Start** → **All Programs** → **Accessories** → **System Tools** → **Backup**.
2. Follow the instructions in the **Backup or Restore** wizard.

*Windows 7*

1. Click **Start**  → **Control Panel** → **System and Security** → **Backup and Restore**.
2. Click **Set up backup....**
3. Follow the instructions on the **Configure Backup** wizard.

## Dell DataSafe Online Backup

 **NOTE:** Dell DataSafe Online Backup may not be available in all regions.

 **NOTE:** A broadband connection is recommended for fast upload/download speeds.

Dell DataSafe Online is an automated backup and recovery service that helps protect your photos, music, and other important files.

DataSafe Online safely backs up your important files to online storage, and protects your files from catastrophic incidents like theft, fire, or natural disasters. The user name and password setup on your DataSafe Online account protects your data from unauthorized access. For more information, go to **[delldatasafe.com](http://delldatasafe.com)**.

To schedule backups:

1. Double click the Dell DataSafe Online icon  on the taskbar
2. Follow the instructions that appear on the screen.

# Dell Dock

The Dell Dock is a group of icons that provides easy access to frequently-used applications, files, and folders. You can personalize the Dock by:

- Adding or removing icons
- Changing the color and location of the Dock
- Grouping related icons into categories
- Changing the behavior of the icons



## Add a Category

1. Right-click the Dock, click **Add**→ **Category**. The **Add/Edit Category** window is displayed.
2. Enter a title for the category in the **Title** field.
3. Select an icon for the category from the **Select an image:** box.
4. Click **Save**.

## Add an Icon

Drag and drop the icon to the Dock or a category.

## Remove a Category or Icon

1. Right-click the category or icon on the Dock and click **Delete shortcut** or **Delete category**.
2. Follow the instructions on the screen.

## Personalize the Dock

1. Right-click the Dock and click **Advanced Setting....**
2. Choose the desired option to personalize the Dock.

# Solving Problems

This section provides troubleshooting information for your computer. If you cannot solve your problem using the following guidelines, see “Using Support Tools” on page XX or “Contacting Dell” on page XX.

## Beep Codes

Your computer might emit a series of beeps during start-up if there are errors or problems. This series of beeps, called a beep code, identifies a problem. Write down the beep code and contact Dell (see “Contacting Dell” on page XX).

 **NOTE:** To replace parts, see the *Service Manual* at [support.dell.com/manuals](http://support.dell.com/manuals).

Beep Code	Possible Problem
One	Possible motherboard failure - BIOS ROM checksum failure
Two	No RAM detected
Three	Possible motherboard failure - Chipset error
Four	RAM read/write failure
Five	Real Time Clock failure
Six	Video card or chip failure
Seven	Processor failure
Eight	Display failure

# Network Problems

## Wireless Connections

### **If the wireless network connection is lost** —

The wireless router is offline or wireless has been disabled on the computer.

- Check your wireless router to ensure it is powered on and connected to your data source (cable modem or network hub).
- Interference may be blocking or interrupting your wireless connection. Try moving the computer closer to your wireless router.
- Re-establish your connection to the wireless router (see “Setting Up a Wireless Connection” on page XX).

## Wired Connections

**If the network connection is lost** — The cable is loose or damaged.

- Check the cable to ensure it is plugged in and not damaged.
- The link integrity light on the integrated network connector lets you verify that your connection is working and provides information on the status:
  - Green — A good connection exists between a 10-Mbps network and the computer.
  - Amber — A good connection exists between a 100-Mbps network and the computer.
  - Off — The computer is not detecting a physical connection to the network. For assistance, contact your network administrator or ISP.



 **NOTE:** The link integrity light on the network connector is only for the wired cable connection. The link integrity light does not provide status for wireless connections.

## Power Problems

**If the power light is off** — The computer is either turned off, in hibernate state or is not receiving power.

- Press the power button. The computer resumes normal operation if it is off or in hibernate mode.
- Reseat the AC adapter cable into the power connector on the computer and the electrical outlet.
- If the computer is plugged into a power strip, ensure that the power strip is plugged into an electrical outlet and that the power strip is turned on.
- Temporarily bypass power protection devices, power strips, and power extension

cables to verify that the computer turns on properly.

- Ensure that the electrical outlet is working by testing it with another device, such as a lamp.
- Check the AC adapter cable connections. If the AC adapter has a light, ensure that the light on the AC adapter is on.

**If the power light is solid white and the computer is not responding** — The display may not be responding.

- Press the power button until the computer turns off and then turn it back on.
- If the problem persists, contact Dell (see “Contacting Dell” on page xx.)

## Solving Problems

**If the power light is blinking white** — The computer is in standby state or the display may not be responding.

- Press a key on the keyboard, move the connected mouse or a finger on the touch pad, or press the power button to resume normal operation.
- If the display is not responding, press the power button until the computer turns off and then turn it back on.
- If the problem persists, contact Dell (see “Contacting Dell” on page xx).

**If you encounter interference that hinders reception on your computer** — An unwanted signal is creating interference by interrupting or blocking other signals. Some possible causes of interference are:

- Power, keyboard, and mouse extension cables.
- Too many devices connected to a power strip.

- Multiple power strips connected to the same electrical outlet.

## Memory Problems

**If you receive an insufficient memory message** —

- Save and close any open files and exit any open programs you are not using to see if that resolves the problem.
- See the software documentation for minimum memory requirements.
- Reseat the memory module(s) into the connector(s) (see the *Service Manual* at [support.dell.com/manuals](http://support.dell.com/manuals) for instructions.)
- If the problem persists, contact Dell (see “Contacting Dell” on page xx.)

**If you experience other memory problems** —

- Run the Dell Diagnostics (see “Dell Diagnostics” on page XX).
- If the problem persists, contact Dell (see “Contacting Dell” on page XX).



## Lockups and Software Problems

**If the computer does not start up** — Ensure that the power cable is firmly connected to the computer and to the electrical outlet.

**If a program stops responding** — End the program:

1. Press <Ctrl><Shift><Esc> simultaneously.
2. Click **Applications**.
3. Click the program that is no longer responding
4. Click **End Task**.

**If a program crashes repeatedly** — Check the software documentation. If necessary, uninstall and then reinstall the program.

-  **NOTE:** Software usually includes installation instructions in its documentation or on the disc (CD or DVD).
-  **NOTE:** Your computer does not have an internal optical drive. Use an external

optical drive or any external storage device for the procedures that involve discs.

**If the computer stops responding or a solid blue screen appears** —

 **CAUTION:** You might lose data if you are unable to perform an operating system shutdown.

If you are unable to get a response by pressing a key on your keyboard or moving your mouse, press the power button until the computer turns off and then restart your computer.

**If a program is designed for an earlier Microsoft® Windows® operating system** —

Run the **Program Compatibility Wizard**. The **Program Compatibility Wizard** configures a program so that it runs in an environment similar to an earlier version of Microsoft Windows operating system environments.

## Solving Problems

### Windows® XP

1. Click **Start** → **Help and Support** → **Fixing a Problem** → **Application and Software Problems**
2. Under **Fix a Problem** click **Getting older programs to run on Windows XP**.
3. Read the instructions and then click the **Program Compatibility Wizard**.
4. Follow the instructions on the screen.

### Windows® 7

1. Click **Start** .
2. In the search box, type Use an older program with this version of Windows and press <Enter>.
3. Follow the instructions on the **Program Compatibility wizard**.

### If you have other software problems —

- Back up your files immediately.
- Use a virus-scanning program to check the hard drive or CDs.

- Save and close any open files or programs and shut down your computer through the **Start**  menu.
- Check the software documentation or contact the software manufacturer for troubleshooting information:
  - Ensure that the program is compatible with the operating system installed on your computer.
  - Ensure that your computer meets the minimum hardware requirements needed to run the software. See the software documentation for information.
  - Ensure that the program is installed and configured properly.
  - Verify that the device drivers do not conflict with the program.
  - If necessary, uninstall and then reinstall the program.
  - Write down any error message that is displayed to help in troubleshooting when Contacting Dell.

# Using Support Tools

## Dell Support Center

The **Dell Support Center** is an easy-to-use application that provides information about your computer, personalized service and support resources.

To launch the application, click the  icon in the taskbar.

The **Dell Support Center** home page displays your computer's model number, service tag, express service code, and service contact information.

The home page also provides links to access:

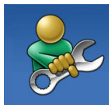

**Self Help** (Troubleshooting, Security, System Performance, Network/Internet, Backup/Recovery, and Windows operating system)



**Alerts** (technical support alerts relevant to your computer)



**Assistance from Dell** (Technical Support with DellConnect™, Customer Service, Training and Tutorials, How-To Help with Dell on Call™, and Online Scan with PC CheckUp)



**About Your System** (System Documentation, Warranty Information, System Information, Upgrades & Accessories)

For more information about **Dell Support Center** and available support tools, click the **Services** tab at [support.dell.com](http://support.dell.com).

# System Messages

If your computer has an issue or an error, it may display a System Message that will help you identify the cause and action needed to resolve the issue.

 **NOTE:** If the message you received is not listed in the following examples, see the documentation for either the operating system or the program that was running when the message appeared. Alternatively you could see the *Dell Technology Guide* available on your hard drive or at [support.dell.com/manuals](http://support.dell.com/manuals) or contact Dell (see “Contacting Dell” on page XX for assistance).

**Alert! Previous attempts at booting this system have failed at checkpoint [nnnn]. For help in resolving this problem, please note this checkpoint and contact Dell Technical Support** — The computer failed to complete the boot routine three consecutive times for the

same error (see “Contacting Dell” on page XX for assistance).

**CMOS checksum error** — Possible motherboard failure or RTC battery low. Replace the battery (see the *Service Manual* at [support.dell.com/manuals](http://support.dell.com/manuals) or see “Contacting Dell” on page XX for assistance).

**Hard-disk drive failure** — Possible hard disk drive failure during POST (see “Contacting Dell” on page XX for assistance).

**Hard-disk drive read failure** — Possible hard disk drive failure during HDD boot test (see “Contacting Dell” on page XX for assistance).

**Keyboard failure** — Keyboard failure or loose cable. Replace the keyboard, (see the *Service Manual* at [support.dell.com/manuals](http://support.dell.com/manuals)).

**No boot device available** — No bootable partition on hard drive, the hard disk drive cable is loose, or no bootable device exists.

- If the hard drive is your boot device, ensure that the cables are connected and that the

drive is installed properly and partitioned as a boot device.

- Enter system setup and ensure that the boot sequence information is correct (see the *Dell Technology Guide* available on your hard drive or at [support.dell.com/manuals](http://support.dell.com/manuals)).

**No timer tick interrupt** — A chip on the system board might be malfunctioning or motherboard failure (see “Contacting Dell” on page XX for assistance).

## Hardware Troubleshooter

If a device is either not detected during the operating system setup or is detected but incorrectly configured, you can use the **Hardware Troubleshooter** to resolve the incompatibility.

To start the Hardware Troubleshooter:

1. Click **Start** → **Help and Support**.
2. Type `hardware troubleshooter` in the search field and press <Enter> to start the search.
3. In the search results, select the option that best describes the problem and follow the remaining troubleshooting steps.

### Dell Diagnostics

If you experience a problem with your computer, perform the checks in “Lockups and Software Problems” on page XX and run the Dell Diagnostics before you contact Dell for technical assistance.

 **NOTE:** Dell Diagnostics works only on Dell computers.

 **NOTE:** The *Drivers and Utilities* disc is optional and may not ship with your computer.

See the System Setup section in the *Service Manual* at [support.dell.com/manuals](http://support.dell.com/manuals) to review your computer’s configuration information, and ensure that the device that you want to test displays in the system setup program and is active.

Start the Dell Diagnostics from your hard drive or from the *Drivers and Utilities* disc.

### Starting Dell Diagnostics From Your Hard Drive

The Dell Diagnostics is located on a hidden diagnostic utility partition on your hard drive.

 **NOTE:** If your computer cannot display a screen image, contact Dell (see “Contacting Dell” on page XX).

1. Ensure that the computer is connected to an electrical outlet that is known to be working properly.
2. Turn on (or restart) your computer.
3. When the DELL™ logo appears, press <F12> immediately. Select **Diagnostics** from the boot menu and press <Enter>. This will invoke the Pre-Boot System Assessment (PSA) in some computers.

 **NOTE:** If you wait too long and the operating system logo appears, continue to wait until you see the Microsoft® Windows® desktop; then, shut down your computer and try again.



 **NOTE:** If you see a message stating that no diagnostics utility partition has been found, run the Dell Diagnostics from the *Drivers and Utilities* disc.

*If PSA is invoked:*

- a. The PSA will start running the tests.
- b. If the PSA completes successfully, you will receive the following message:  
"No problems have been found with this system so far. Do you want to run the remaining memory tests? This will take about 30 minutes or more. Do you want to continue? (Recommended)."
- c. If you are experiencing memory issues, press <y>, otherwise press <n>.

The following message is displayed  
"Booting Dell Diagnostic Utility Partition. Press any key to continue."

- d. Press any key to continue. The **Choose An Option** window appears.

*If PSA is not invoked:*



Press any key to start the Dell Diagnostics from the diagnostics utility partition on your hard drive and to go to the **Choose An Option** window.

4. Select the test you want to run.
5. If you encounter a problem during a test, a message with the error code and a description of the problem will appear on your screen. Write down the error code and problem description and contact Dell (see "Contacting Dell" on page XX).

## Using Support Tools

-  **NOTE:** The Service Tag for your computer is displayed at the top of each test screen. The Service Tag helps you identify your computer when you contact Dell.
- When the tests complete, close the test screen to return to the **Choose An Option** window.
  - To exit the Dell Diagnostics and to restart the computer, click **Exit**.

## Starting Dell Diagnostics From the Drivers and Utilities Disc

-  **NOTE:** Your computer does not have an internal optical drive. Use an external optical drive or any external storage device for the procedures that involve discs.
- Insert the *Drivers and Utilities* disc.
  - Shut down and restart the computer. When the DELL logo appears, press <F12> immediately.
-  **NOTE:** If you wait too long and the

operating system logo appears, continue to wait until you see the Microsoft® Windows® desktop; then, shut down your computer and try again.

-  **NOTE:** The next steps change the boot sequence for one time only. On the next start-up, the computer boots according to the devices specified in the system setup program.
- When the boot device list appears, highlight **CD/DVD/CD-RW** and press <Enter>.
  - Select the **Boot from CD-ROM** option from the menu that appears and press <Enter>.
  - Type **1** to start the CD menu and press <Enter> to proceed.
  - Select the test you want to run.
  - If you encounter a problem during a test, a message with the error code and a description of the problem will appear on your screen. Write down the error code and

problem description and contact Dell (see “Contacting Dell” on page XX).

-  **NOTE:** The Service Tag for your computer is displayed at the top of each test screen. The Service Tag helps you identify your computer when you contact Dell.
8. When the tests complete, close the test screen to return to the **Choose An Option** window.
  9. To exit the Dell Diagnostics and to restart the computer, click **Exit**.
  10. Remove the *Drivers and Utilities* disc.

# Restoring Your Operating System

You can restore your operating system in the following ways:

- System Restore returns your computer to an earlier operating state without affecting data files. Use System Restore as the first solution for restoring your operating system and preserving data files.
- Dell DataSafe Local Backup restores your hard drive to the operating state it was in when you purchased your computer, without erasing the data files. Use this option if System Restore did not resolve your problem.
- Dell Factory Image Restore returns your hard drive to the operating state it was in when you purchased the computer. This procedure permanently deletes all data on the hard drive and removes any programs installed after you received the computer. Use Dell Factory Image Restore only if System

Restore did not resolve your operating system problem.

- If you received an *Operating System* disc with your computer, you can use it to restore your operating system. However, using the *Operating System* disc also deletes all data on the hard drive. Use the disc only if System Restore did not resolve your operating system problem.

## System Restore

The Windows operating systems provide a System Restore option which allows you to return your computer to an earlier operating state (without affecting data files) if changes to the hardware, software, or other system settings have left the computer in an undesirable operating state. Any changes that System Restore makes to your computer are completely reversible.

 **CAUTION:** Make regular backups of your data files. System Restore does not monitor your data files or recover them.

 **NOTE:** The procedures in this document were written for the Windows default view, so they may not apply if you set your Dell™ computer to the Windows Classic view.

## Starting System Restore

To restore your computer:

*Windows XP*

1. Click **Start** → **All Programs** → **Accessories** → **System Tools** → **System Restore**.

 **NOTE:** The **User Account Control** window may appear. If you are an administrator on the computer, click **Continue**; otherwise, contact your administrator to continue the desired action.

2. Click **Next** and follow the instructions on the screen.

*Windows 7*

1. Click **Start**.
2. In the **Start Search** box, type `System Restore` and press <Enter>.

 **NOTE:** The **User Account Control** window may appear. If you are an administrator on the computer, click **Continue**; otherwise, contact your administrator to continue the

desired action.

3. Click **Next** and follow the instructions on the screen.

In the event that System Restore did not resolve the issue, you may undo the last system restore.

### Undoing the Last System Restore

 **NOTE:** Before you undo the last system restore, save and close all open files and exit any open programs. Do not alter, open, or delete any files or programs until the system restoration is complete.

1. Click **Start**.
2. In the **Start Search** box, type `System Restore` and press <Enter>.
3. Click **Undo my last restoration** and click **Next**.

## Dell Factory Image Restore



**CAUTION:** Using Dell Factory Image Restore permanently deletes all data on the hard drive and removes any programs or drivers installed after you received your computer. If possible, back up the data before using this option. Use Dell Factory Image Restore only if System Restore did not resolve your operating system problem.



**NOTE:** Dell Factory Image Restore may not be available in certain countries or on certain computers.

Use Dell Factory Image Restore only as the last method to restore your operating system. This option restores your hard drive to the operating state it was in when you purchased the computer. Any programs or files added since you received your computer—including data files—are permanently deleted from the hard drive. Data files include documents, spreadsheets, e-mail messages, digital photos,

music files, and so on. If possible, back up all data before using Dell Factory Image Restore.

## Performing Dell Factory Image Restore

1. Turn on the computer. When the Dell logo appears, press <F8> several times to access the **Advanced Boot Options** window.

 **NOTE:** If you wait too long and the operating system logo appears, continue to wait until you see the Microsoft® Windows® desktop; then, restart your computer and try again.

2. Select **Repair Your Computer**.
3. The **System Recovery Options** window appears.
4. Select a keyboard layout and click **Next**.
5. To access the recovery options, log on as a local user. To access the command prompt, type `administrator` in the **User name** field, then click **OK**.

6. Click **Dell Factory Image Restore**. The **Dell Factory Image Restore** welcome screen appears.

 **NOTE:** Depending upon your configuration, you may need to select **Dell Factory Tools**, then **Dell Factory Image Restore**.

7. Click **Next**. The **Confirm Data Deletion** screen appears.

 **NOTE:** If you do not want to proceed with Factory Image Restore, click **Cancel**.

8. Select the check box to confirm that you want to continue reformatting the hard drive and restoring the system software to the factory condition, then click **Next**.

The restore process begins and may take five or more minutes to complete. A message appears when the operating system and factory-installed applications have been restored to factory condition.

9. Click **Finish** to reboot the system.

## Operating System Reinstallation

### Before You Begin

If you are considering reinstalling the Microsoft® Windows® operating system to correct a problem with a newly installed driver, first try using Windows Device Driver Rollback.

To roll back a device driver:

#### *Windows XP*

1. Click **Start**→ **Control Panel**.
2. Double-click **System**.
3. On the **Hardware** tab, click **Device Manager**.
4. Right-click the device for which the new driver is installed and click **Properties**.
5. Click the **Drivers** tab→ **Roll Back Driver**.

#### *Windows 7*

1. Click **Start** .
2. Right-click **Computer**.
3. Click **Properties**→ **Device Manager**.
4. Right-click the device for which the new driver is installed, and click **Properties**.
5. Click the **Drivers** tab→ **Roll Back Driver**.

If Device Driver Rollback does not resolve the problem, then use System Restore to return your operating system to the operating state it was in before you installed the new device driver. See “System Restore” on page XX.

 **CAUTION: Before performing the installation, back up all data files on your primary hard drive. For conventional hard drive configurations, the primary hard drive is the first drive detected by the computer.**



To reinstall Windows, you need the following:

 **NOTE:** Your computer does not have an internal optical drive. Use an external optical drive or any external storage device for the procedures that involve discs.

- Dell *Operating System* disc
- Dell *Drivers and Utilities* disc

 **NOTE:** The *Drivers and Utilities* disc contains drivers that were installed during the assembly of the computer. Use the Dell *Drivers and Utilities* disc to load any required drivers. Depending on the region from which you ordered your computer, or whether you requested the disc, the Dell *Drivers and Utilities* disc and *Operating System* disc may not ship with your computer.

## Reinstalling Microsoft Windows

The reinstallation process can take 1 to 2 hours to complete. After you reinstall the operating system, you must also reinstall the device drivers, virus protection program, and other software.

1. Save and close any open files and exit any open programs.
2. Insert the *Operating System* disc.
3. Click **Exit** if the `Install Windows` message appears.
4. Restart the computer.
5. When the DELL logo appears, press <F12> immediately.

 **NOTE:** If you wait too long and the operating system logo appears, continue to wait until you see the Microsoft® Windows® desktop; then, shut down your computer and try again.

## Restoring Your Operating System

 **NOTE:** The next steps change the boot sequence for one time only. On the next start-up, the computer boots according to the devices specified in the system setup program.

6. When the boot device list appears, highlight **CD/DVD/CD-RW Drive** and press <Enter>.
7. Press any key to **Boot from CD-ROM**. Follow the instructions on the screen to complete the installation.

# Getting Help

If you experience a problem with your computer, you can complete the following steps to diagnose and troubleshoot the problem:

1. See “Solving Problems” on page XX for information and procedures that pertain to the problem your computer is experiencing.
2. See the *Dell Technology Guide* available on your hard drive or at **support.dell.com/manuals** for more troubleshooting information.
3. See “Dell Diagnostics” on page XX for procedures on how to run Dell Diagnostics.
4. Fill out the “Diagnostic Checklist” on page XX.
5. Use Dell’s extensive suite of online services available at Dell Support (**support.dell.com**) for help with installation and troubleshooting procedures. See “Online Services” on page XX for a more extensive list of Dell Support online.
6. If the preceding steps have not resolved the problem, see “Before You Call” on page XX.



**NOTE:** Call Dell Support from a telephone near or at the computer so that the support staff can assist you with any necessary procedures.



**NOTE:** Dell’s Express Service Code system may not be available in all countries.

## Getting Help

When prompted by Dell's automated telephone system, enter your Express Service Code to route the call directly to the proper support personnel. If you do not have an Express Service Code, open the **Dell Accessories** folder, double-click the **Express Service Code** icon, and follow the directions.

 **NOTE:** Some of the services are not always available in all locations outside the continental U.S. Call your local Dell representative for information on availability.

## Technical Support and Customer Service

Dell's support service is available to answer your questions about Dell hardware. Our support staff use computer-based diagnostics to provide fast, accurate answers.

To contact Dell's support service, see "Before You Call" on page XX and then see the contact information for your region or go to **support.dell.com**.

## DellConnect™

DellConnect is a simple online access tool that allows a Dell service and support associate to access your computer through a broadband connection, diagnose your problem and repair it all under your supervision. For more information, go to **www.dell.com/dellconnect**.

## Online Services

You can learn about Dell products and services on the following websites:

- **www.dell.com**
- **www.dell.com/ap** (Asian/Pacific countries only)
- **www.dell.com/jp** (Japan only)
- **www.euro.dell.com** (Europe only)
- **www.dell.com/la** (Latin American and Caribbean countries)
- **www.dell.ca** (Canada only)

You can access Dell Support through the following websites and e-mail addresses:

### Dell Support websites

- **support.dell.com**
- **support.jp.dell.com** (Japan only)
- **support.euro.dell.com** (Europe only)

### Dell Support e-mail addresses

- **mobile\_support@us.dell.com**
- **support@us.dell.com**
- **la-techsupport@dell.com** (Latin America and Caribbean countries only)
- **apsupport@dell.com** (Asian/Pacific countries only)

### Dell Marketing and Sales e-mail addresses

- **apmarketing@dell.com** (Asian/Pacific countries only)
- **sales\_canada@dell.com** (Canada only)

### Anonymous file transfer protocol (FTP)

- **ftp.dell.com**

Log in as user: `anonymous`, and use your e-mail address as your password.

## Automated Order-Status Service

To check on the status of any Dell products that you have ordered, you can go to **support.dell.com**, or you can call the automated order-status service. A recording prompts you for the information needed to locate and report on your order. For the telephone number to call your region, see “Contacting Dell” on page XX.

If you have a problem with your order, such as missing parts, wrong parts, or incorrect billing, contact Dell for customer assistance. Have your invoice or packing slip handy when you call. For the telephone number to call your region, see “Contacting Dell” on page XX.

## Product Information

If you need information about additional products available from Dell, or if you would like to place an order, visit **www.dell.com**. For the telephone number to call your region or to speak to a sales specialist, see “Contacting Dell” on page XX.

## Returning Items for Repair Under Warranty or for Credit

 **NOTE:** Before you return the product to Dell, make sure to back up any data on the hard drive(s) and on any other storage device in the product. Remove any and all confidential, proprietary and personal information, as well as removable media, such as CDs and PC Cards. Dell is not responsible for any of your confidential, proprietary or personal information; lost or corrupted data; or damaged or lost removable media that may be included with your return.

Prepare all items being returned, whether for repair or credit, as follows:

1. Call Dell to obtain a Return Material Authorization Number, and write it clearly and prominently on the outside of the box.  
For the telephone number to call your region, see “Contacting Dell” on page XX.
2. Include a copy of the invoice and a letter describing the reason for the return.
3. Include a copy of the Diagnostics Checklist (see “Diagnostic Checklist” on page XX), indicating the tests that you have run and any error messages reported by the Dell Diagnostics (see “Dell Diagnostics” on page XX).
4. Include any accessories that belong with the item(s) being returned (power cables, software, guides, and so on) if the return is for credit.

## Getting Help

5. Pack the equipment to be returned in the original (or equivalent) packing materials.

 **NOTE:** You are responsible for paying shipping expenses. You are also responsible for insuring any product returned, and you assume the risk of loss during shipment to Dell. Collect On Delivery (C.O.D.) packages are not accepted.

 **NOTE:** Returns that are missing any of the preceding requirements will be refused at Dell's receiving dock and returned to you.



## Before You Call

**NOTE:** Have your Express Service Code ready when you call. The code helps Dell's automated-support telephone system direct your call more efficiently. You may also be asked for your Service Tag.

### Locating Your Service Tag

The Service Tag is located at the bottom of your computer.

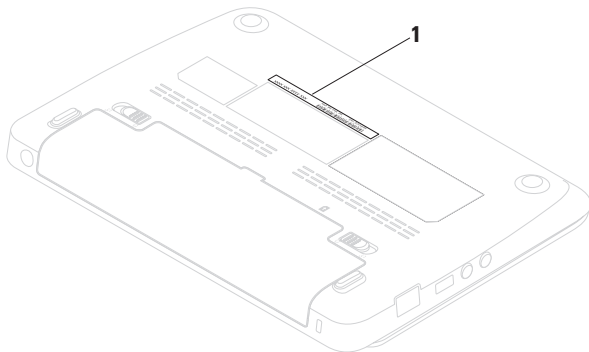

---

**1** Service Tag

---

## Getting Help

Remember to fill out the following Diagnostic Checklist. If possible, turn on your computer before you call Dell for assistance and call from a telephone at or near the computer. You may be asked to type some commands at the keyboard, relay detailed information during operations, or try other troubleshooting steps possible only at the computer itself. Ensure that the computer documentation is available.

### Diagnostic Checklist

- Name:
- Date:
- Address:
- Phone number:
- Service Tag (bar code on the back or bottom of the computer):
- Express Service Code:
- Return Material Authorization Number (if provided by Dell support technician):
- Operating system and version:

- Devices:
- Expansion cards:
- Are you connected to a network? Yes/No
- Network, version, and network adapter:
- Programs and versions:

See your operating system documentation to determine the contents of the computer's start-up files. If the computer is connected to a printer, print each file. Otherwise, record the contents of each file before calling Dell.

- Error message, beep code, or diagnostic code:
- Description of problem and troubleshooting procedures you performed:

## Contacting Dell

For customers in the United States, call 800-WWW-DELL (800-999-3355).

 **NOTE:** If you do not have an active Internet connection, you can find contact information on your purchase invoice, packing slip, bill, or Dell product catalog.

Dell provides several online and telephone-based support and service options. Availability varies by country and product, and some services may not be available in your area.

To contact Dell for sales, technical support, or customer service issues:

1. Visit **[www.dell.com/contactdell](http://www.dell.com/contactdell)**.
2. Select your country or region.
3. Select the appropriate service or support link based on your requirement.
4. Choose the method of contacting Dell that is convenient for you.

# Finding More Information and Resources

**If you need to:**

---

reinstall your operating system.

---

run a diagnostic program for your computer, reinstall notebook system software, or update drivers for your computer, and readme files

---

learn more about your operating system, maintaining peripherals, Internet, Bluetooth<sup>®</sup>, networking, and e-mail

---

upgrade your computer with new or additional memory, or a new hard drive

---

reinstall or replace a worn or defective part

**See:**

---

the *Operating System* disc

---

the *Drivers and Utilities* disc



**NOTE:** Drivers and documentation updates can be found at **support.dell.com**

---

the *Dell Technology Guide* available on your hard drive or at **support.dell.com/manuals**

---

the *Service Manual* at **support.dell.com/manuals**



**NOTE:** In some countries, opening and replacing parts of your computer may void your warranty. Check your warranty and return policies before working inside your computer.

---

### If you need to:

find safety best practices information for your computer review Warranty information, Terms and Conditions (U.S. only), Safety instructions, Regulatory information, Ergonomics information, and End User License Agreement

find your Service tag/Express Service Code— You must use the service tag to identify your computer on **support.dell.com** or to contact technical support

find drivers and downloads  
access technical support and product help  
check on your order status for new purchases  
find solutions and answers to common questions  
locate information for last-minute updates about technical changes to your computer or advanced technical-reference material for technicians or experienced users

### See:

the safety and regulatory documents that shipped with your computer and also see the Regulatory Compliance Homepage at **www.dell.com/regulatory\_compliance**

the bottom of your computer the **Dell Support Center**. To launch the **Dell Support Center**, click the  icon in the task bar

**support.dell.com**

# Basic Specifications

This section provides information that you may need when setting up, updating drivers for, and upgrading your computer. For more detailed specifications, see the *Comprehensive Specifications* at [support.dell.com/manuals](http://support.dell.com/manuals).

 **NOTE:** Offerings may vary by region. For more information regarding the configuration of your computer, click **Start** → **Help and Support** and select the option to view information about your computer.

## Computer Model

---

Dell™ Inspiron™ 1012

## Computer Information

---

Processor types    Intel® Atom™ Single Core

System chipset    Intel NM10 Express

## Memory

---

Memory module connector    one user accessible SODIMM connector

## Memory

---

Memory module capacities    1 GB and 2 GB

Memory configurations possible    1 GB and 2 GB

Memory type    667/800 MHz DDR2 SODIMM

## Connectors

---

Audio	one microphone-in connector, one stereo headphone/speaker connector
Mini-Card	one full Mini-Card slot and two half Mini-Card slots
Network adapter	RJ45 connector
USB	three 4-pin USB 2.0-compliant connectors
VGA	15-hole connector

## Communications

---

Network adapter	10/100 Ethernet LAN on system board
-----------------	-------------------------------------

## Communications

---

Wireless	Bluetooth® wireless technology, WLAN, WWAN/GPS, TV/CMMB (in china only)
----------	---

## Camera

---

Camera resolution	1.3 megapixel
Video resolution	640 x 480 at 30 fps (maximum)

## Display

---

Type	10.1" WSVGA Truelife 1024 x 600 WLED 10.1" HD Truelife 1366 x 768 WLED
------	---

## Basic Specifications

### Display

---

*Dimensions:*

Height 222.72 mm (8.77 inches)

Width 125.28 mm (4.93 inches)

Diagonal 255.52 mm (10.1 inches)

### Battery

---

*Types and dimensions:*

6-cell "smart" lithium ion

Depth 58.23 mm (2.30 inches)

Height 21.5 mm (0.8 inches)

Width 140.6 mm (5.54 inches)

Weight 0.41 kg (0.90 lbs)

3-cell "smart" lithium ion

Depth 23.1 mm (0.91 inches)

Height 39.04 mm (1.54 inches)

### Battery

---

Width 204.14 mm (8.04 inches)

Weight 0.165 kg (0.36 lbs)

Voltage 11.1 VDC (3/6-cell)

Charge time (approximate): 3.0 hours (3-cell)/4.0 hours (6-cell)

(when the computer is turned off)

Operating time varies depending on operating conditions

Coin-cell battery CR-2032

### AC Adapter

---



**NOTE:** Use only AC adapters specified for use with your computer. See the safety information that shipped with your computer.



**AC Adapter**

---

Input voltage	100–240 VAC
Input current	0.8 A or 1.0 A
Input frequency	50–60 Hz
Output power	30 W
Output current	1.58 A
Rated output voltage	19.0 VDC

*Temperature range:*

Operating	0° to 40°C (32° to 104°F)
Storage	–40° to 70°C (–40° to 158°F)

**Physical**

---

Height	35.75 mm to 29.25 mm (1.41 inches to 1.15 inches)
Width	268 mm (10.6 inches)
Depth	196.6 mm (7.74 inches)
Weight (with 6-cell battery):	Configurable to less than 1.35 kg (2.98 lbs)

**Computer Environment**

---

*Temperature range:*

Operating	0° to 35°C (32° to 95°F)
Storage	–40° to 65°C (–40° to 149°F)

### Computer Environment

---

*Relative humidity (maximum):*

Operating                    10% to 90%  
  (noncondensing)

Storage                        5% to 95%  
  (noncondensing)

*Maximum vibration (using a random vibration spectrum that simulates user environment):*

Operating                    0.66 GRMS

Non-Operating              1.30 GRMS

*Maximum shock (for operating — measured with Dell Diagnostics running on the hard drive and a 2-ms half-sine pulse; for non-operating — measured with hard drive in head-parked position and a 2-ms half-sine pulse):*

Operating                    110 G

Non-Operating              160 G

# Appendix

## Macrovision Product Notice

This product incorporates copyright protection technology that is protected by method claims of certain U.S. patents and other intellectual property rights owned by Macrovision Corporation and other rights owners. Use of this copyright protection technology must be authorized by Macrovision Corporation, and is intended for home and other limited viewing uses only unless otherwise authorized by Macrovision Corporation. Reverse engineering or disassembly is prohibited.

## Information for NOM, or Official Mexican Standard (Only for Mexico)

The following information is provided in the device(s) described in this document in accordance with the requirements of the Official Mexican Standard (NOM):

### Importer:

Dell México S.A. de C.V.

Paseo de la Reforma 2620 – Flat 11°

Col. Lomas Altas

11950 México, D.F.

<b>Regulatory model number</b>	<b>Voltage</b>	<b>Frequency</b>	<b>Electricity consumption</b>	<b>Output voltage</b>	<b>Output intensity</b>
P04T	100-240 VAC	50-60 Hz	0.8 A or 1.0 A	19.0 VDC	1.58 A

For details, read the safety information that shipped with your computer.

For additional safety best practices information, see the Regulatory Compliance Homepage at [www.dell.com/regulatory\\_compliance](http://www.dell.com/regulatory_compliance).

# Index

## A

airflow, allowing **5**

## B

backups

    creating **34**

Basic specifications **68**

before you call **63**

## C

calling Dell **63**

CDs, playing and creating **32**

computer capabilities **32**

computer, setting up **5**

conserving energy **33**

customer service **58**

customizing

    your desktop **32**

    your energy settings **33**

## D

damage, avoiding **5**

DataSafe Online Backup **35**

DellConnect **58**

Dell Diagnostics **46**

dell dock **36**

Dell Factory Image Restore **52**

Dell Support Center **43**

Dell Technology Guide

    for further information **66**

Diagnostic Checklist **64**

drivers and downloads **67**

## Index

DVDs, playing and creating **32**

## E

email addresses

for technical support **59**

energy

conserving **33**

## F

finding more information **66**

FTP login, anonymous **59**

## H

hardware problems

diagnosing **45**

Hardware Troubleshooter **45**

help

getting assistance and support **57**

## I

Internet connection **14**

ISP

Internet Service Provider **14**

## M

memory problems

solving **40**

## N

network connection

fixing **38**

## P

power problems, solving **39**

power strips, using **6**

products

information and purchasing **60**

**R**

- reinstalling Windows **54**
- resources, finding more **66**
- restoring factory image **52**

**S**

- setting up internet connection
  - internet connection **15**
- shipping products
  - for return or repair **61**
- software features **32**
- software problems **41**
- support email addresses **59**
- support sites
  - worldwide **59**
- System Messages **44**
- System Reinstallation **54**
- System Restore **50**

**V**

- ventilation, ensuring **5**

**W**

- warranty returns **61**
- Windows
  - program compatibility wizard **41**
  - reinstallation **54**
- wired network connection **7**
- wireless network connection **38**







Printed in the U.S.A.

[www.dell.com](http://www.dell.com) | [support.dell.com](http://support.dell.com)



OCMH9RA00