

Wonderful Communication, Mobile Life.

Welcome to HUAWEI ETS2028/2228/2528 Fixed Wireless Terminal.

HUAWEI ETS2028/2228/2528 Fixed Wireless Terminal
User Guide

Copyright © 2006 Huawei Technologies Co., Ltd.

All Rights Reserved

No part of this manual may be reproduced or transmitted in any form or by any means without prior written consent of Huawei Technologies Co., Ltd.

Trademarks



and HUAWEI are trademarks of Huawei Technologies Co., Ltd. All other trademarks and trade names mentioned in this manual are the property of their respective holders.

Notice

The information in this manual is subject to change without notice. Every effort has been made in the preparation of this manual to ensure accuracy of the contents, but all statements, information, and recommendations in this manual do not constitute the warranty of any kind, expressed or implied.

Table of Contents

1 Warnings and Precautions	1
2 Introduction	7
Packing List	7
Appearance of the FWT	8
Icons	12
3 Installation	14
Installing the UIM Card (Optional).....	14
Installing the Power Adapter or the Spare Battery	14
Installing the Antenna.....	16
Placing the FWT	17
Validating	18
4 Basic Operations	19
Powering the FWT On or Off.....	19
Making a Call	19
Answering a Call	20
Operations During a Call.....	20
Locking the Keypad	21
5 Text Entry	22
Text Input Mode	22
Entering Letters	22
6 Messages	25
Writing and Sending a Message	25
Viewing a Message	25
Deleting a Message.....	26
Voice Mail.....	26
Message Settings	27
7 Phone Book	30
Adding a Contact	30
Searching for a Contact	30
Editing a Contact	31

Deleting a Contact	31
Copying a Contact	31
Groups.....	32
Memory Status.....	32
Saving My FWT Number	33
8 Settings	34
Call Settings.....	34
Profile Settings	35
Security Settings	37
Supplementary Services Settings	38
9 FM Radio(Optional).....	40
Switching the Radio On/Off.....	40
Searching for a Channel	40
Setting a Frequency	41
Adding a Channel	42
Deleting a Channel	42
10 Fun & Utility	43
11 Menu Commands	45
12 Maintenance and Troubleshooting.....	48
Maintenance.....	48
Troubleshooting	48
13 Specifications	51

1

Warnings and Precautions

Before using HUAWEI Fixed Wireless Terminal (hereinafter referred to as FWT), read the following cautions and let your children know these, so that you can use your FWT correctly and safely.

Basic Cautions

According to the packing list, check items in the package box to make sure that they are complete and undamaged.

Before installing and using FWT, read the user manual carefully.

Electronic Device

Switch off your FWT near high-precision electronic devices such as hearing aids, pacemakers, fire alarm systems, automatic gates, and other automatic-control devices. The FWT may affect the performance of these devices.

Such devices include hearing aids, pacemakers, fire alarm systems, automatic gates, and other automatic-control devices. If you are using an electronic medical device, consult the device manufacturer and confirm whether the radio waves affect the operation of the electronic device.

Hospital

Pay attention to the following points in hospitals or health care facilities:

- Do not take your FWT into the operating room (OR), intensive care unit (ICU), or coronary care unit (CCU).

- Switch off your FWT near medial devices.
- Observe any instructions wherever the use of wireless device is prohibited.

Traffic Safety

- Do not use your FWT while driving. Secure the FWT on its holder. Do not place the FWT on the seat or other places where it can get loose in a sudden stop or collision.
- Observe the rules and regulations of airline companies. Switch off your FWT before boarding an aircraft.

Operating Environment

- Do not place magnetic storage media such as magnetic cards and floppy disks near the FWT. Radiation from the FWT may erase the information stored on them.
- Do not put your FWT, battery, or other accessories in containers with strong magnetic field, such as the induction cooker and microwave oven. Otherwise, circuit failure, fire, or explosion may result.
- Do not place or use the FWT, the battery or the power adapter near any heat sources such as fire or a heater; or places with flammable gases; or areas with electrical appliances that give out heat. Otherwise, it will cause fire, explosion and breakdown of the FWT
- Because FWT needs to eliminate heat during working, put the FWT and the power supply in a ventilated and shadowy place. Never airproof the FWT or put something on it or place it near water, fire as well as inflammable and explosive materials.
- Place the FWT in a dry place. Do not put a towel over the FWT, or put it in a box or a suitcase while using.
- Because FWT contains precision devices, you should put it in a dry place and away from moist materials.

- Before cleaning FWT, please turn off the FWT, and then disconnect the power supply and take out the battery. Before moving FWT, please disconnect the external power supply.
- Do not subject your FWT, battery, and power adapter to serious collision or shock. Otherwise, battery leakage, FWT malfunction, overheats, fire, or explosion may result.
- Do not place sharp metal objects such as pins near the earpiece. The earpiece may attract these objects and hurt you when you are using the FWT.
- Do not place the FWT in the area over the air bag or in the air bag deployment area. Otherwise, the FWT may hurt you owing to the strong force when the air bag inflates.
- Put your FWT, battery, and power adapter in places beyond the reach of children. Do not allow children to use the FWT, battery, or power adapter without guidance.
- Do not touch the antenna when a call is going on. Touching the antenna may affect call quality and cause the FWT to operate at a power level higher than needed.
- The network signal condition will directly affect the quality and stability of the call. Consequently, you should place FWT in a place where it can receive network signal well. Do not put FWT in a building with an iron or metal roof. The distance between FWT and other metal materials (such as metal brackets or metal doors and windows) should be greater than 25cm and the distance between FWTs should be greater than 30cm.
- Do not open the chassis in any case and the device should be maintained by a qualified maintenance department.
- Without permission, you are not allowed to modify the architecture and security design of FWT. You must bear any consequence resulted from the operation without permission
- Your FWT is designed to conform to the authoritative international radio frequency (RF) specifications. Use FWT accessories approved by Huawei only.

- The antenna(s) used for this transmitter must be installed to provide a separation distance of at least 20cm from all persons.

Emergency Call

You can use your FWT for emergency calls. However, connections in all conditions cannot be guaranteed. You should never rely solely on the FWT for essential communications.

Battery

- If the battery fluid gets into eyes, do not rub them. Wash with clean water and seek medical assistance immediately.
- If the battery fluid contacts skin or cloth, wash with clean water immediately to avoid irritation to the skin.
- Do not dispose of the battery in fire. Otherwise, the battery may ignite or explode.
- When installing the battery on your FWT, do not push the battery by force lest battery fluid leak out or the battery crack.
- Do not connect two poles of the battery with metallic materials such as cables.
- Do not disassemble the battery or solder the battery poles. Otherwise fluid leakage, overheat, fire, or explosion may result.
- If there is battery leakage, smoke, or strange smell, stop using the battery and keep it away from open flame to avoid fire or explosion.
- Disconnect the power adapter and take out the spare battery when FWT is not used for a long time.
- Do not select its self-contained complete battery and power adapter, otherwise, FWT may be spoiled. Dispose of used batteries according to the instructions
- Dispose of the battery according to local laws or regulations.

Power Adapter

- Use AC power as specified for the power adapter. Any violation of this rule may result in fire or malfunction of the power adapter.
- Do not short-circuit the power adapter. Short-circuiting the power adapter may cause fire or malfunction of the power adapter.
- Remove the dust on the power plug regularly.
- Do not use worn-out power cords. Otherwise, electric shock, short-circuiting of the power adapter, or fire may result.
- Do not put the power adapter near the container filled with liquid such as water. If the liquid comes into the power adapter, electrical leakage or other faults may result.
- If the liquid such as water comes into the power adapter accidentally, remove the plug of the power adapter from the socket immediately.
- Disconnect the power adapter from the socket before cleaning or maintaining it. Otherwise, electric shock or short-circuiting of the battery or power adapter may result.
- Ensure the plug of the power adapter is properly inserted into the power socket when charging the battery. Improper insertion may result in electric shock, fire, or explosion.
- Do not place any heavy object on the power cord of the power adapter. Do not damage, change, or pluck the power cord.

Environmental Protection

Please abide by the local laws in disposing of the package materials of your FWT, consumed batteries and used FWT, and try to recycle them.

Please observe the national local regulations in the location where product is to be used. This product may be restricted for use in some or all countries of European Union.

Statement

This device complies with part 15 of the FCC Rules. Operation is subject to the following two conditions: (1) This device may not cause harmful interference, and (2) this device must accept any interference received, including interference that may cause undesired operation.

The antenna(s) used for this transmitter must be installed to provide a separation distance of at least 20cm from all persons.

Changes or modifications not expressly approved by the party responsible for compliance could void the user's authority to operate the equipment. In cases where the manual is provided only in a form other than paper, such as on a computer disk or over the internet, the information required by this section may be included in the manual in that alternative form, provided the user can reasonably be expected to have the capability to access information in that form.

Note: This equipment has been tested and found to comply with the limits for a Class B digital device, pursuant to part 15 of the FCC Rules. These limits are designed to provide reasonable protection against harmful interference in a residential installation. This equipment generate, uses and can radiate radio frequency energy and, if not installed and used in accordance with the instruction, may cause harmful interference to radio communications. However, there is no guarantee that interference will not occur in a particular installation. If this equipment does cause harmful interference to radio or television reception, which can be determined by turning off and on the user is encouraged to try to correct the interference by one or more of the following measures.

2 Introduction

Packing List

The FWT package box contains the following items. If any of the items is lost or damaged, contact your local dealer.





Item	Quantity	Item	Quantity
Main unit, handset, and coiled cord	1	Certificate of Quality	1
Power adapter	1	Spare battery	1
Fixed Wireless Terminal User manual	1	Antenna (optional)	1



Appearance of the FWT

Front View



No.	Item	Description
1	antenna	To receive signals.
2	Display screen	To display information.
3	Left soft key 	<ul style="list-style-type: none"> In the standby mode, press it to access the main menu. In the non-standby mode, press it to perform the operation displayed on the lower left corner of the screen. Press this key to answer a call.

No.	Item	Description
4	Scroll key 	<ul style="list-style-type: none"> • Up key: In the standby mode, press it to access the Calendar screen; during a call, press it to increase the volume. • Down key: In the standby mode, press it to enable the radio (or alarm clock); during a call, press it to decrease the volume. • Left key: In the standby mode, press it to view the call records. • Right key: In the standby mode, press it to access the Write message screen.
5	Right soft key 	<ul style="list-style-type: none"> • In the standby mode, press it to access the Phone Book screen. • In the non-standby mode, press it to perform the operation displayed on the lower right corner of the display screen.
6	OK key 	<ul style="list-style-type: none"> • In the standby mode, press it to access the home screen. • In the non-standby mode, press it to perform the operation displayed on the lower left corner of the display screen.
7	End key 	<ul style="list-style-type: none"> • Press it to end a call or cancel the dialing. • Press and hold it for two seconds to power your FWT on or off. • In the non-standby mode, press it to return to the standby mode.

No.	Item	Description
8	HANDFRE E key 	<ul style="list-style-type: none"> In the standby mode, press it to make or answer a call without lifting the handset. When dialing a number, press it to cancel the dialing. During a call, press it to end the current call.
9	Call/Redial key 	<ul style="list-style-type: none"> Press it to make or answer a call. In the standby mode, press it to view the call history.
10	# key	<ul style="list-style-type: none"> In the standby mode, press and hold it to lock the FWT. Press it to switch between input methods and so on.
11	* key	<ul style="list-style-type: none"> In the standby mode, press and hold it repeatedly to activate/cancel the quiet profile. Press it repeatedly to enter a symbol and so on.
12	Number keys	Press 0–9 keys to enter numbers/characters or speed dial a phone number.
13	Handset retaining clip	When the FWT is wall-mounted, it is used it to fix the handset.
14	Heaver	End the current call or other operations.



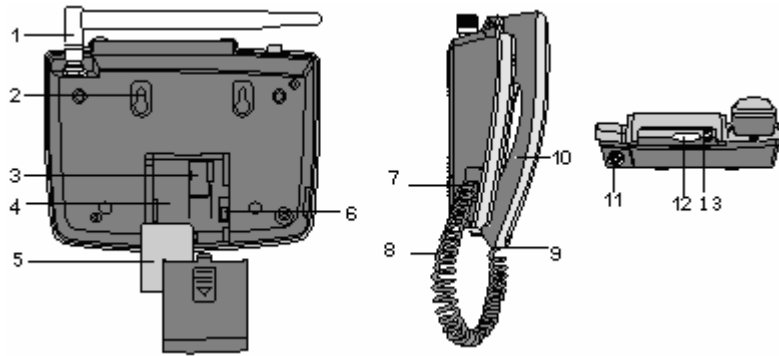





Back View



No	Item	Description
1	Antenna	To receive signals.
2	Hook	To fix the FWT when installed vertically.
3	UIM case slot	To house the UIM card
4	Battery case	To house the spare battery.
5	Spare battery	To supply the FWT with power.
6	Battery cord jack	To connect to the battery cord.
7	Coiled cord jack on the Main unit	To connect to the handset coiled cord.
8	Coiled cord	To connect to the handset to the Main unit.
9	Coiled cord jack on handset	To connect to the handset coiled cord.

No	Item	Description
.		
10	Handset	To make a call or answer a call by lifting it.
11	Antenna jack	To connect to the antenna
12	DB9 serial port	To maintain the FWT through it.
13	Power jack	To connect to the power adapter for power supply.

Icons

Icon	Description
	Indicates the signal strength. The more the bars, the stronger the signal strength.
	Indicates there is a new message.
	Indicates there is a new voice message.
	Indicates there is an outgoing call or an ongoing call.
	Indicates the alarm clock is activated.
	Indicates the battery power level. The more the bars, the higher the power level.
	Indicates the FWT is powered by the power adapter.
	Indicates the FWT is in hands-free mode.
	Indicates the network not available.

3

Installation

Installing the UIM Card (Optional)



Caution:

- Consult your service provider to decide whether to use a user identity module (UIM) card.
- The UIM card and its golden contact can be easily damaged by a scratch or bend. Be careful when installing or removing the UIM card.

Press and hold  to power your FWT off and then disconnect it from the power socket. Install the UIM card according to the following figure. Make sure that the golden contact of the UIM card is facing downwards.

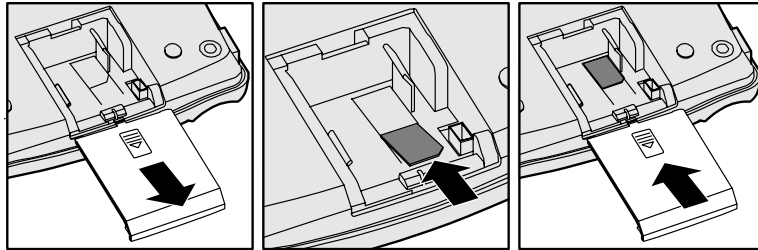

Installing the Power Adapter or the Spare Battery



Note:

- The FWT can be powered by the power adapter or the spare battery.

- If the FWT is connected to the power adapter and the spare battery is inserted, the FWT is powered by the power adapter, and meanwhile, the spare battery is charged.
- Charge the spare battery for at least eight hours for the first time. If a fully-charged spare battery is left unused for a long time, charge it for at least five minutes before using it again.
- If the FWT is powered solely by the spare battery, the talk time is three hours to five hours or the standby time is 40 hours to 120 hours (the talk time and the standby time are network dependent).

Installing the Power Adapter

Press and hold  to power off your FWT. Connect the power adapter to the FWT, and plug it to the power socket.

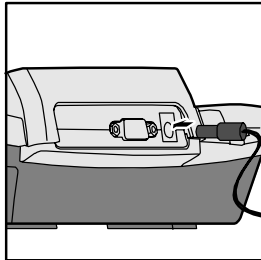

Installing the Spare Battery

Press and hold  to power off your FWT and then disconnect the FWT from the power socket. Then install the spare battery as shown in the following figure. When installing the spare battery, make sure that the battery cord plug matches the battery jack. Do not insert reversely.

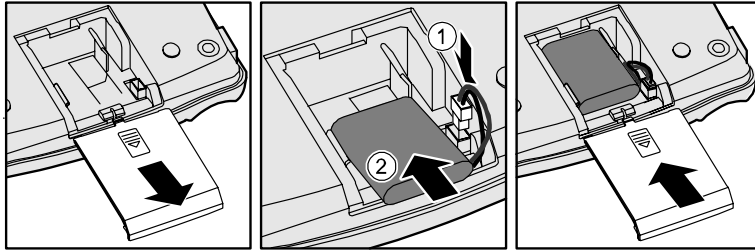

Removing the Spare Battery

Press and hold  to power off your FWT and then disconnect the FWT from the power socket. Then remove the battery house cover. Disconnect the battery cord and take out the spare battery.

Installing the Antenna

Power off your FWT and disconnect the FWT from the power socket. Then connect the antenna to the antenna jack on the Main unit. Make sure that the antenna is stably connected to the antenna jack.

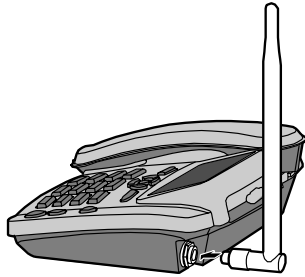

Checking the Signal Strength

1. After installing the antenna, press and hold  to power on your FWT. Wait until the signal strength icon appears or you can hear the dialing tone when you lift the handset.
2. If the signal strength icon does not appear after five minutes or you hear the failure tone when you lift the handset, it indicates that the FWT is not receiving signals. In this case, you need to adjust the direction of the antenna until you can hear the dialing tone on lifting the handset.
3. If there is no signals even after you adjust the antenna in 360 degrees angle, it indicates that the signal is weak in the particular site. Either change the site or consult your service provider.

Placing the FWT

You can place the FWT horizontally or vertically.

Horizontally

Place the FWT on a flat surface. Select a cool and ventilated site for the FWT to dissipate the heat.

Vertically

1. Pull out the Handset retaining clip from the slot and turn it around. Then push it back so that the handset will not fall down when FWT is placed vertically.

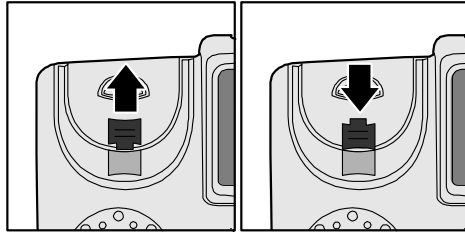

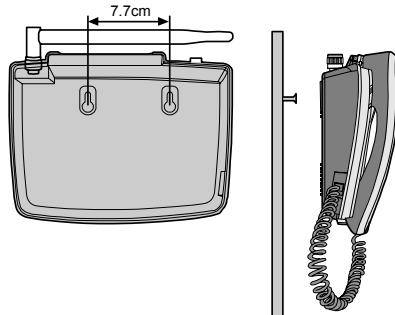

2. According to the distance between the two hooks (7.7 cm), hammer two nails into the wall with 3 mm end left out.



3. Snap the hooks to the nails.

Validating

After installing the FWT, you can make a call to check whether it is correctly installed.

1. Press and hold  to power on your FWT. After connecting the FWT to the power socket, the  icon appears, indicating that the FWT is powered normally.
2. Lift the handset. In the standby mode, the signal strength icon  appears normally.
3. If you are able to make a call, it indicates that the FWT is installed correctly.

4

Basic Operations



Powering the FWT On or Off

When the FWT is powered off, press and hold  to power it on.



In the standby mode, press and hold  to power it off.

Making a Call

Making a Call Through the Keypad

1. In the standby mode, press number keys to enter a phone number. If the entered phone number is wrong, press .
2. Press  to dial the phone number.
3. Press  to end the call or cancel the dialing.

Making a Call from the Dialed Calls List

1. In the standby mode, press  to access the **Dialed Calls** screen.
2. Press the Up/Down key to scroll up or down the dialed calls.
3. Press  to dial.



Making a Call from the Phone Book

1. In the phone book, search for the contact to dial.
2. Press  to dial.



Speed Dialing a Call

The speed dial function allows you to dial a phone number by pressing one number key. You can only set the speed dial

function for contacts saved in the FWT.



1. Select **Menu > Phone Book > Speed Dial**.
2. Press the Up/Down key to scroll up or down the items.
3. If a number key is not assigned to a contact, press  to select a contact from the phone book.
4. If a number key is assigned to a contact, press  for the following options:
 - **Change**: Change a contact.
 - **Delete**: Delete the contact.

Answering a Call

In the standby mode, you can lift the handset, press ,  or  to answer a call.

Activating the Any Key Answer Function

In the standby mode, select **Menu > Settings > Call Settings > Any-key Answer** to set the any-key answer function.

If the any-key answer function is activated, you can press any key to answer an incoming call (except  and .

Rejecting a Call

If you want to reject an incoming call, press  or .

Adjusting the Volume

During a call, you can press the up/right key to increase the volume or press the down/left key to decrease the volume.



Operations During a Call

During a call, press  to select the following options:

- **Save Number**: Enter a phone number and save it to the phone book.

- **Phone Book:** Access the **Phone Book** screen.
- **Messages:** Access the **Messages** screen.
- **Third Party Call:** The function is network dependent. For details, consult your service provider.
- **Voice Privacy:** The function is network dependent. For details, see "**Voice Privacy**" on page 34.

Locking the Keypad

Even when the keypad is locked, you can lift the handset, press  or press  to answer a call.

Locking the Keypad Manually

Press and hold the # key for two seconds to lock the keypad.

Locking the Keypad Automatically

With the keyguard function activated, if there is no operation within the preset time when the FWT is in the standby mode, the keypad is automatically locked.

1. Select **Menu > Settings > Phone Settings > Keyguard**.
2. Press the Up/Down key to select:
 - **Off:** Deactivate the keyguard function.
 - **30 Seconds, 2 Minutes or 5 Minutes:** Set the FWT to lock automatically if there is no operation in 30 seconds, 2 minutes or 5 minutes.

Unlocking the Keypad

Press . Then press the * key to unlock the keypad.

5



Text Entry

Text Input Mode

While entering text, you can press the # key to change the input mode. The following table lists the input modes and their indicators.

Indicator	Text Input Mode
eZiEn	Smart English
ABC	English upper case
abc	English lower case
123	Numbers

Note:

In the edit mode, press  once to delete the letter on the left of the cursor. Press and hold  for over two seconds to delete all letters.

Entering Letters

Smart English Input

In the "eZiEn" input mode, follow the steps described below to enter English.

1. According to the word to enter, press the corresponding number keys once, and the FWT makes out candidate words.

2. Press the Up/Down key or the * key to select the word.
3. Press the right key to confirm your selection. The word is displayed in the input area.
Alternatively, press the 0 key to confirm your selection and enter a space behind the word.

 **Note:**

- After you enter several letters, the FWT can give other letters to make out the candidate words. Press the Up/Down key or the * key to scroll the words and press the right key to confirm; or press number keys to enter letters.
- Press repeatedly the 1 key to enter punctuation.
- Press the 0 key to enter a space.
- Press the * key to display the symbol list.
- Press the # key to change the case of letters.

Alphabetical Text Input

Alphabetical text input allows you to enter uppercase ("ABC") or lowercase ("abc") English letters. You can press the number key labeled with desired letters once to enter the first letter on the key, twice to enter the second letter on the key, and by analogy.

If the letter you want to enter is on the same key as the previous one, you can enter the letter only after the cursor appears again or after you move the cursor to the next space.

Press the 1 key to enter a full stop or other symbols. Press the 0 key to enter a space. Press the * key to display the symbol list.

Entering Numbers

Do the following to enter numbers:

- In the "123" input mode, press number keys labeled with desired digits.

- In the "ABC" or "abc" input mode, press the number key repeatedly until the desired digit appears on the screen.
- In the "eZiEn" input mode, press the number key and then press the Up/Down key until the desired digit appears on the display screen.



Entering Symbols

1. In any input mode, press the * key to display the symbol list.
2. Press the Up/Down key to scroll up or down the symbol list.
3. Press the corresponding number key to enter a symbol.

6

Messages

Writing and Sending a Message

1. Select **Menu > Messages > Write Message**.
2. Write the message. You can enter up to 160 English letters. When writing the message, you can press  for the following operations:
 - **Insert Template**: Insert a commonly used phrase.
 - **Insert Phone Number**: Insert a contact number from the phone book.
3. After writing the message, press  for the following operations:
 - **Send**: Send the message.
 - **Send&Save**: Send the message and save it to the outbox.
 - **Save**: Save the message to the draft.
4. You can insert up to 10 recipients. Do the following:
 - Enter the phone number directly.
 - Select **Search > Search Phone Book** to insert a contact from the phone book.
 - Select **Search > Search Groups** to insert a contact from the message group.
5. Press the  to send a message.



Viewing a Message

Viewing the Inbox

The inbox stores received messages.

When there is a new message, the FWT alerts and the  icon

appears on the display screen. If the  icon blinks, it indicates that the message memory is full. Do the following to view the inbox:



1. Select **Menu > Messages > Inbox**.
2. Press the Up/Down key to scroll up or down the messages.
3. Press  (**View**) to view the message.
4. Press  (**Options**) to select **Reply, Delete, Forward, Call** or **Save Number**.

Viewing the Outbox and the Draft

The outbox stores messages that are sent successfully. You can delete, forward or re-send a message in the outbox.

The draft stores drafts and messages that are not sent successfully. You can edit, send or delete messages in the draft.

Deleting a Message

1. Select **Menu > Messages > Delete All**.
2. Select the messages to delete:
 - **Inbox**: Delete messages in the inbox.
 - **Outbox**: Delete messages in the outbox.
 - **Draft**: Delete messages in the draft.
 - **UIM Card**: Delete messages saved in the UIM card. Applicable only if a UIM card is available.
 - **Phone**: Delete messages saved in the FWT.
 - **All**: Delete messages saved in both the FWT and the UIM card.
3. Press  (**Yes**) to delete and press  (**No**) to cancel.

Voice Mail

Calling the Voice Mail Center

1. Select **Menu > Messages > Voice Mail > Options**.

2. Select **Call Voice Mail Center** and press  (**Select**) to call the voice mail center.

Setting or Viewing the Voice Mail Number

1. Select **Menu > Messages > Voice Mail > Voice Mail Number**.
2. If the voice mail number is already set, you can view and edit it; if not, enter the voice mail number and press  (**OK**).

Note:

The voice mail function is network dependent. You must subscribe for the service. For the voice mail number and other information, consult your service provider.



Clearing the Voice Mail Notification

1. Select **Menu > Messages > Voice Mail**.
2. Select **Clear Voice Mail Notification** and press  (**Select**).

Message Settings

Setting a Template

Your FWT provides 10 commonly used phrases. You can insert these phrases when you edit a message. You can also customize the phrases.

1. Select **Menu > Message > Message Settings > Templates**.
2. Press the Up/Down key to scroll up or down the phrases.
3. Press  (**Select**) to select the phrase to edit.
4. Press  (**OK**) to save the edited phrase.

Setting a Message Group

You can send a message to a message group directly instead of group members one by one. It is different from the phone book group. You can set up to 10 message groups. You can only add

contacts saved in the FWT to a message group.

1. Select **Menu > Messages > Message Settings > Group Settings**.
2. Press the Up/Down key to scroll up or down the message groups.
3. Press  (**Options**) to select **View, Add, Rename** or **Delete All**.

Setting the Auto Save Function

Select **Menu > Messages > Message Settings > Auto Save** to set the auto save function. You can select:

- **Send And Save:** Activate the auto save function. Messages are automatically saved after being sent. Messages sent successfully are saved to the outbox. Messages not sent are saved to the draft.
- **Send Only:** Deactivate the auto save function.

Setting the Auto Delete Function

Select **Menu > Messages > Message Settings > Auto Delete**.

- **On:** Activate the auto delete function. If the memory in use is full and there is a new message, the FWT automatically deletes the earliest message.
- **Off:** Deactivate the auto delete function. If the memory in use is full, the FWT cannot receive messages. You need to delete some messages manually. Then the FWT can receive new messages.

Setting the Priority

Select **Menu > Messages > Message Settings > Priority**. You can set the sending sequence of messages from the short message service center (SMSC). The priority level from low to high is normal, urgent, and emergency.

The priority function is network dependent. For details, consult your service provider.

Setting the Delivery Ack

Select **Menu > Messages > Message Settings > Delivery Ack**. You can set whether to receive a delivery report after a message is sent.

Setting the Memory Status





Select **Menu > Messages > Message Settings > Memory Status** to view the memory status.

7



Phone Book

Adding a Contact

A contact is saved to the memory in use.

1. Select **Menu > Phone Book > Add New**.
2. Enter the name and press  (**OK**).
3. Set other options:
 - If the memory in use is the FWT, you can set: **Name**, **General Number**, **Home Number**, **Office Number**, and **Memo** (you need to set at least one phone number).
 - If the memory in use is the UIM card, you can set **General Number** only.
4. Press  (**OK**) to save the settings and press the Up/Down key to set other items.
5. Press  (**Save**) to save the contact or press  (**Back**) to cancel.



Searching for a Contact

1. Select **Menu > Phone Book > Search**.
2. Enter the name and press  (**OK**).
3. Press the Up/Down key to scroll up or down the contacts.
 - Press  (**View**) to view the details of the contact.

Note:



Press  (**OK**) to display the contacts. Press the number key labeled with the initial letter of the contact. The contacts names beginning with the letter (or the adjacent letter) are displayed.

Editing a Contact

1. Select **Menu > Phone Book > Search** to search for the contact to edit.
2. Press  (**Options**) and select **Edit**.
3. Press  (**Save**) to save the contact or press  (**Back**) to cancel.

Deleting a Contact

Delete a Contact

1. Select **Menu > Phone Book > Search** to search for a contact to delete.
2. Press  (**Options**) and select **Delete**.
3. Press  (**Yes**) to delete the contact or press  (**No**) to cancel.

Delete All Contacts



1. Select **Menu > Phone Book > Delete All**.
2. Enter the correct FWT lock code and press  (**OK**).
3. Select **Phone** to delete all the contacts saved in the FWT. If the UIM card is available, select **UIM Card** to delete all the contacts saved in the UIM card.

Copying a Contact



If the UIM card is available, you can copy one or all contacts from the FWT to the UIM card and from the UIM card to the FWT.

Copying a Contact

1. Search for a contact to copy.

2. Press  (**Options**) and select **Copy To UIM** or **Copy To Phone**. If the contact is saved in UIM card, select **Copy To Phone** to copy it to the FWT. If the contact is saved in FWT, select **Copy To UIM** to copy it to the UIM card.
3. Press  (**Yes**) to copy the contact or press  (**No**) to cancel.

Copying All Contacts

1. Select **Menu > Phone Book > Copy All**.
2. Select UIM To Phone or Phone To UIM.
 - If you select **UIM To Phone**, all contacts are copied to the FWT.
 - If you select **Phone To UIM**, all contacts are copied to the UIM card.
3. Press  (**Yes**) to copy the contacts or press  (**No**) to cancel.

Groups

You can sort contacts into different groups for easy management. You can set up to 10 groups.

1. Select **Menu > Phone Book > Groups**.
2. Press the Up/Down key to scroll up or down the groups.
3. Press  (**Options**) for the following options:
 - **View**: View the contacts of a group.
 - **Add**: Add a contact to the group.
 - **Group Ring**: Set a ring tone for the incoming calls of the group members.
 - **Rename**: Rename the group.
 - **Delete All**: Delete all contacts of a group.



Memory Status

Your FWT can save up to 500 contacts. The number of contacts that can be saved in the UIM card is determined by its capacity.

Viewing the Memory Status

Select **Menu > Phone Book > Memory Status** to view the memory status.

Saving My FWT Number

1. Select **Menu > Phone Book > My Phone Num.**
2. Press  (**Edit**) to edit the FWT number.
3. Press  (**OK**) to save the FWT number.

Call Settings

Minute Alert

If the minute alert function is activated, your FWT notifies you of the call duration by giving an alert 10 seconds before the end of each minute.

1. Select **Menu > Settings > Call Settings > Minute Alert**.
2. Select one of the following options:
 - **On**: Activate the minute alert function.
 - **Off**: Deactivate the minute alert function.

Voice Privacy

The voice privacy function can protect your conversation from interception. The voice privacy function is network dependent. For details, consult your service provider.

Select **Menu > Settings > Call Settings > Voice Privacy**:

- **Standard**: Deactivate the voice privacy function.
- **Enhanced**: Activate the voice privacy function.

Auto Dial

If the auto dial function is activated, it means that the phone number you keyed in is dialed automatically at the time you set without pressing the  key. If the time you set for auto dialing is too short, an incomplete number may be dialed before you key in the whole number.

1. Select **Menu > Settings > Call Settings >Auto Dial**.
2. Select one of the following options: “Off”, “After 3 Seconds”, “After 4 Seconds”, “After 5 Seconds”, “After 6 Seconds”, “After 7 Seconds”, “After 8 Seconds” and “After 9 Seconds”.





Shortcut Key Settings

The FWT provides shortcut keys for your convenience.

Note:

In the standby mode, the default shortcut key settings are shown as follows:

- Up key: press it to access the Calendar screen; during a call, press it to increase the volume.
- Down key: press it to enable the radio (or alarm clock); during a call, press it to decrease the volume.
- Left key: press it to view the call records.
- Right key: press it to access the Write message screen.

1. In the standby mode, Select **Menu> Settings> Phone Settings> Shortcut** to set the shortcut keys.
2. Press  /  /  /  to set the corresponding shortcut keys.
 - Press [**Select**] to select one of the following shortcut key options: **Disable, Message Edit, Message Inbox, Radio, Lunar Date, Calculator, Volume Setting, Message Menu, Alarm, Schedule, Stopwatch, World Clock, Gallery, Line Game, Smash Game, Profile, Voice Message, Phone Book, and Call History.**

Profile Settings

Your FWT provides three profiles. You can activate or

customize a profile.

Selecting a Profile

1. In the standby mode, select **Menu > Profiles**.
2. Press the Up/Down key to scroll up or down the profiles: **General, Outdoor, and Quiet**.
3. Press  (**Select**) and select **Set** to activate the profile.

Note:

In the standby mode, press and hold the * key to activate the quiet mode. Press and hold the * key again to restore the FWT to the previous mode.

Editing a Profile

1. In the standby mode, select **Menu > Profiles**.
2. Press the Up/Down key to scroll up or down the profiles: **General, Outdoor and Quiet**.
3. Press  (**Select**) and select **Edit** to edit a profile. You can set the following items:
 - **Volume:** Adjust the volume of **Ring** and **Key**.
 - **Incoming Call:** Select a ring tone for incoming calls. 10 ring tones are available.
 - **Alarm Clock:** Select an alert tone for the alarm clock. 10 alert tones are available.
 - **SMS Alert:** Select a message tone. 5 message tones are available.
 - **Key Tone:** Select a keypad tone. Select **Off** to deactivate the keypad tone.
 - **Power On/Off Tone:** Activate or deactivate the power-on and power-off tone.

Security Settings

Note:



The emergency call function of the FWT is not affected by the operation of FWT lock function.

Setting the FWT Lock

The FWT lock protects your FWT from unauthorized usage. If necessary, you can activate the FWT lock. You can change the default FWT lock code (000000) into a numeric string of 4 to 8 digits.

Remember the FWT code. In case you forget it, contact your service provider.

If the FWT lock activated, you have to enter the FWT code every time you power on the FWT. Enter the correct FWT lock code and press  (**OK**).

1. Select **Menu > Settings > Security > Phone Lock**.
2. Enter the correct FWT lock code and press  (**OK**).
3. Select **On/Off** to activate or deactivate the FWT lock.
4. Select **Change Code**. Then enter the new FWT lock code and press  (**OK**).
5. Re-enter the new FWT lock code and press  (**OK**).

Setting the PIN Lock

The personal identification number (PIN) code protects the UIM card from unauthorized usage. The PIN unblocking key (PUK) code can unblock the PIN code. PIN and PUK are delivered with the UIM card. For details, consult your service provider.

 **Note:**

- If you enter wrong PIN codes three times consecutively, the FWT prompts you to enter the correct PUK code. If you enter wrong PUK code several times, consult your service provider for the correct PUK code.
- If you enter wrong PUK codes 10 times consecutively, the UIM card is invalidated. Contact your service provider to retrieve a new card.

If the PIN code is activated, you have to enter the PIN code every time you power on the FWT. Enter the correct PIN code and press  (OK).



Do the following to set the PIN code:

1. Select **Menu > Settings > Security > PIN Lock**.
2. Enter the correct PIN code and press  (OK).
3. Select **On/Off** to activate or deactivate PIN code.
4. Select **Change Code** to change the PIN code.

Changing the PIN Lock

When the FWT is working well, you can change the PIN code by referring to the process of setting the PIN lock.

When the PIN code is locked, you can enter correct PUK code to unlock the PIN Code. If you enter wrong PUK codes 10 times consecutively, the UIM card is invalidated. Contact your service provider to retrieve a new card.

1. Enter correct PUK code and press  (OK).
2. Enter new PIN code and press  (OK).
3. Re-enter the new PIN code and press  (OK).

Supplementary Services Settings

For the specific supplementary services of the FWT, consult the

carrier. The supplementary services need special commission. This section only introduces some typical supplementary services.

- Caller ID display: When there is an incoming call, the FWT displays the phone number of the caller on the screen.
- Three way calling: Three parties can hold a conversation at the same time.
- Call forwarding: The incoming calls are forwarded to the specified phone accordingly to facilitate you to answer.

Supplementary services are network dependent. For details, consult your service provider.

9



FM Radio(Optional)

Switching the Radio On/Off

Switching the Radio On

1. In the standby mode, select **Menu > FM Radio**.
The FWT displays "Radio On!". The radio is switched on and the broadcasting screen is displayed.
2. Select a channel to listen to the radio broadcast.

Switching the Radio Off

1. In the standby mode, select **Menu > FM Radio**.
2. Press  (**Options**) and select **Switch Off**.
3. Press  (**Select**) to switch the radio off and return to the home screen.

Searching for a Channel

Auto Tuning



1. In the standby mode, select **Menu > FM Radio**.
2. Press  (**Options**) and select **Auto Tuning**.
3. The FWT searches the available channels and saves them.

Note:



The FWT can save up to 20 channels.

Manual Tuning



1. In the standby mode, select **Menu > FM Radio**.

2. Press  (**Options**) and select **Manual Tuning**. You can tune the radio channel manually.
3. The FWT searches for an available channel.
4. Press the Up/Down key to switch a channel.
5. Press  (**Set**) to add the channel to the channel list or press  (**Back**) to stop tuning and return to the broadcasting screen.





Inching Tuning

1. In the standby mode, select **Menu > FM Radio**.
2. Press  (**Options**) and select **Inching Tuning**.
3. Press the Up/Down key and the FWT searches for all available channels between 87.5 MHz and 108.0 MHz. The tuning increases or decreases 0.1 MHz each time.
4. Press  (**Set**) to add a channel to the channel list and return to the broadcasting screen or press  (**Back**) to stop tuning and return to the broadcasting screen.





Setting a Frequency

1. In the standby mode, select **Menu > FM Radio**.
2. Press  (**Options**) and select **Set Frequency**.
3. Enter a frequency ranges from 87.5 MHz to 108.0 MHz. If you enter 3 digits before the decimal, the cursor moves to the right of the decimal automatically; if you enter 2 digits before the decimal, press the right key to move the cursor to the right of the decimal.
4. Press  (**OK**) to save the settings and return to the broadcasting screen; press  (**Clear**) to clear the settings and return to the broadcasting screen; press the left/right key to move the cursor to clear all the settings.

Adding a Channel



1. After searching for or set a frequency, press  (**Options**) and select **Save Channel**.
2. Press the Up/Down key to scroll up or down the channel list.
3. Press  (**OK**) to complete the settings.
If you set the frequency of the selected channel, the FWT prompts "Replace existing channel?" Press  (**Yes**) to replace. Press  (**No**) to re-select.

Deleting a Channel



1. In the standby mode, select **Menu > FM Radio**.
2. Press  (**Options**) and select **Delete Channel**.
3. Press the Up/Down key to scroll up or down the channel list.
4. Press  (**Delete**) to delete a non-empty channel.
5. Press  (**Yes**) to delete; press  (**No**) to cancel.

Alarm Clock

After the alarm clock is activated, it rings at the specified time when your FWT is powered on. You can set up to five alarm clocks.

1. Select **Menu > Fun&Utility > Alarm**.
2. Press the Up/Down key to scroll up or down the alarm clocks.
3. Press  (**Select**) to select an alarm clock.
4. Select **Alarm On** to startup the alarm clock.
5. Enter the time and press  (**OK**).
6. Select:
 - **Once**: The alarm clock rings only once.
 - **Everyday**: The alarm clock rings once every day.
 - **Custom**: The alarm clock rings on the specified days.

Note:

- When the alarm clock rings, press  (**Stop**) to turn off the alarm clock. Alternatively, press  (**Snooze**) to snooze the alarm clock for five minutes.
- If you do not turn off the alarm clock in 45 seconds, the alarm clock automatically snoozes. After five minutes, the alarm clock rings again. It alerts automatically for 6 times before it stops.

Schedule

1. Select **Menu > Fun&Utility > Schedule**.

2. Press  (**Options**) to select: **Add Schedule, View Current Month, View All, Delete All, Delete Passed, Memory Status** and **Go To Date**.

11

Menu Commands

Phone Book

See "Phone Book" on page 30.

Messages

See "Messages" on page 25.

Call History

Missed Calls	<ul style="list-style-type: none">• Press the Up/Down key to scroll up or down the records (up to 20).• Press  to dial a record.• You can save, delete or send a message to a record.
Received Calls	
Dialed Calls	
Call Duration	<ul style="list-style-type: none">• The FWT records the duration of the last call, dialed calls, received calls, and all calls. You can view or reset the duration.• The call duration recorded by the FWT may differ from that in the call detail record (CDR) of your service provider. The difference is determined by factors such as the network functioning and the round-up settings.
Delete All	You can delete all the missed calls, received calls or dialed calls.

Fun & Utility	
Alarm	See "Alarm Clock" on page 43.
Schedule	See "Schedule" on page 43.
Calculator	You can use the calculator for basic calculations. Press the # key to enter the decimal point. Press the * key to select operators such as add, subtract, multiply and divide. Press  to display the results.
Stopwatch	The FWT provides the stopwatch function, which can record up to 9 hours 59 minutes 59 seconds and 990 milliseconds.
World Clock	You can view the Greenwich Mean Time (GMT), current time of other 31 major time zones around the world, and local time.
Line Game	For details, see Help in your FWT.
Smash Game	For details, see Help in your FWT.
Profiles	
See "Profile Settings" on page 33.	

Settings	
Display	<p>You can set backlight, contrast, date format, time format, and banner.</p> <p>You can set the backlight to off, always on, or off if there is no operation on the FWT for 10 seconds, 20 seconds or 30 seconds.</p> <p>You can press the left/right key to increase or decrease the contrast.</p> <p>You can set the date format to yyyy-mm-dd, dd-mm-yyyy or mm-dd-yyyy.</p> <p>You can set the time format to 12-hour or 24-hour.</p> <p>You can activate or deactivate the banner.</p>
Call Settings	See "Call Settings" on page 34.
Phone Settings	<p>You can select a language, set the keyguard function and shortcut keys.</p> <p>You can select English or Chinese as the FWT language.</p> <p>For details of the keyguard settings, see "Locking the Keypad" on page 20.</p>
Security	See "Security Settings" on page 37.

12

Maintenance and Troubleshooting

Maintenance

1. Place the FWT in a clean and dry environment. The temperature of the place should be no higher than 55°C or lower than -10°C.
2. If the FWT is covered with dust, please clean it with fine clean cloth. Do not clean it with cleanser or other chemical solvents.
3. If the FWT does not operate normally due to a failed spare battery, please replace the spare battery in time or use the power adapter to supply the FWT with power.
4. If the FWT does not work normally, contact your service provider.

Troubleshooting

The display screen does not turn on after the FWT is powered on (the FWT is not connected to the power adapter).

1. Make sure that the spare battery is installed.
2. The battery level is low. Connect the FWT to the power adapter.

The display screen does not turn on after the FWT is powered on (the FWT is connected to the power adapter).

1. The voltage output of the power adapter does not meet the requirement of the FWT. Check whether the AC input is normal and the power adapter is the approved one.

2. The external voltage of the power adapter is low or unstable; disrupting the normal functioning of the FWT. Check whether the external voltage of the power adapter is normal. You can also install the spare battery in the FWT.

There is no signal icon on the display screen.

1. Make sure that the antenna is installed properly.
2. If still there is no signal, contact your service provider to check whether the FWT is in the signal coverage area.

Time is not displayed.

1. Make sure that idle time is set "On" Status through pressing **Setting>Display>Idle Time**
2. if the problem persists ,Make sure that the antenna is installed properly.
3. Adjust the antenna direction or move the FWT to a place covered where the signal is better.
4. If the problem persists, contact your service provider to check whether the FWT is within the signal coverage area.

After the FWT is powered off, there is no display sometimes while sometimes there is power supply icon and blinking battery icon.

No information on the display screen is a normal status of FWT after power-off. The power supply icon and a blinking battery icon indicate that the battery is being charged.

There is the ring tone after the busy tone.

The ring tone indicates that there is an incoming call. If you are not in a call, you can answer the call.

After lifting the handset, there is a ring tone when you are ready to dial or are dialing a phone number.

It indicates that there is an incoming call. If you are not in a conversation, you can answer the call.

There is only the battery icon on the display screen.

It indicates that the FWT is powered by the spare battery. If the FWT is powered solely by the spare battery and the battery icon is blinking without any bar inside, it indicates that the battery level is low. Use the power adapter to charge the battery or replace the spare battery.

13

Specifications

Item	Description
Dimensions (W × D × H)	214 mm × 156 mm × 77 mm
Weight	Less than 700 g
Placement mode	Horizontal or wall mounting
Input voltage	Switch power supply AC: 90 V–264 V DC: 12 V
Spare battery	Type: NiMH Capacity: 3.6 V 1000 mAh 3.6 V 1500 mAh (Optional)
Maximum transmitter power	≥23 dBm
Typical conversation power consumption	1.2 W
Typical stand-by power consumption	40 mW
Ambient temperature	-10°C to 55°C
Storage temperature	-20°C to 70°C
Relative humidity	5% to 95%