

Sprint Phone Connect

User Guide



Table of Contents

Table of Contents	i
Introduction	1
Package Contents	1
Top View	3
Bottom View	4
Installation and Operation	5
Installing the Battery	5
Installing the Antenna	6
Installing the Power Adapter	7
Connecting your Telephone to Sprint Phone Connect	8
Powering on the Device	9
Understanding the Indicators	10
Making Calls	10
Receiving Calls	11
Adjusting the In-Call Volume	11
Adjusting the In-Call Volume in Standby Mode	11
Adjusting the In-Call Volume During a Call	11
General Functions	13
Mounting the Device	13

Horizontal Mounting	13
Wall Mounting	13
Using Call Waiting.....	14
Making a 3-Way Call	14
Using Voice Mail.....	15
Using Call Forwarding.....	15
Assistive Communication Devices	16
Troubleshooting	17
Why am I not getting a dial tone on my handset?.....	17
Can I create a shortcut to access my voice mail?.....	17
Can I use my telephone answering device instead of voice mail?	17
Does 911 work on this device?	18
Does this product work during a power outage?.....	18
How long is the battery life of Sprint Phone Connect?.....	18
How does Caller ID (CID) work?.....	18
Can I adjust the volume on my telephone?.....	19
How to set the TTY mode?	19
Why do I get the recording, "Call cannot be completed as dialed?"	19
Warnings and Precautions.....	20

Introduction

This section introduces you the features of your new device.

Package Contents

Top View

Bottom View

Package Contents

After opening the package, check to make sure that you have all the parts shown below. If any item is missing or broken, please contact service provider.



Sprint Phone Connect



Antenna

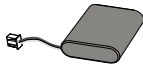

Battery



Power Adapter



Getting Started Poster

Note:

- The figures in this document are provided only for your reference. The actual shape and color of the product may differ slightly.
- Customer must provide their own home telephone. Home telephone can be either traditional corded phone or cordless phone.

Top View

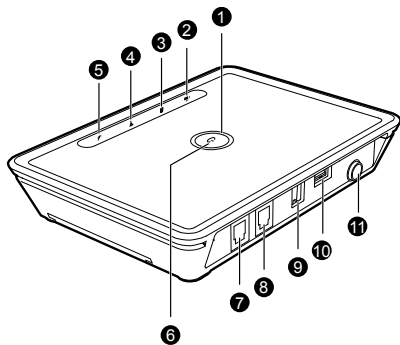

- 1 Power indicator
- 2 Voice mail indicator
- 3 Battery indicator
- 4 Signal indicator
- 5 Signal strength indicator
- 6 Power on/off switch

- 7 Telephone port 1
- 8 Telephone port 2
- 9 DC 12V power port
- 10 USB port*
- 11 Antenna port

* **Note:** Never place a USB-based device into the USB port of the Sprint Phone. Connect under any circumstances. Doing so may damage the device and negate its warranty. The port was designed for diagnostic purposes only; it is not intended for customer use.

Bottom View

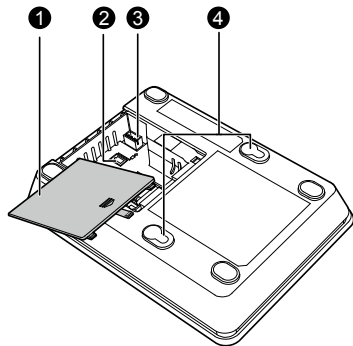

1 Battery cover

2 Battery slot

3 Battery port

4 Wall-mounting brackets

Installation and Operation

Installing the Battery

Installing the Antenna

Installing the Power Adapter

Connecting your Telephone to Sprint Phone Connect

Powering on the Device

Understanding the Indicators

Making Calls

Receiving Calls

Adjusting the In-Call Volume

Installing the Battery

Remove the battery cover. Carefully insert the battery connection cable into the battery port, ensure that the battery terminals are not reversed. Place the battery in the battery slot and return the battery cover.

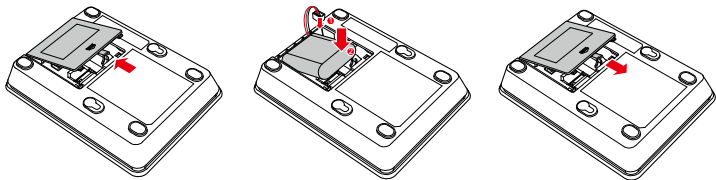

Note:

- If the ambient temperature exceeds the temperature allowed for charging (-10°C to $+50^{\circ}\text{C}$), the device stops charging the battery.
- Talk time is approximately 2.5 hours and standby time is approximately 30 hours. Actual values will vary with the network environment.
- The battery is intended for backup purposes only (in the event of a power failure).
- When the power adapter is connected the battery will automatically charge.
- When fully charged the battery will automatically stop charging.
- Remove the battery if the device is not use for a long time.

Installing the Antenna

Make sure the device is turned off. Align the antenna with the antenna port on the device as illustrated below. Screw the antenna into the port, ensuring that the connection is secure.

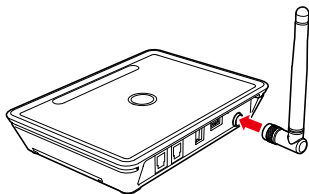

Installing the Power Adapter

Under normal usage, the device relies on the external power adapter for its power supply. Insert the power adapter into the DC input port, and plug the unit into an AC wall outlet.

Note: Backup battery power will only be used during power failure or if the external power adapter is not in use.

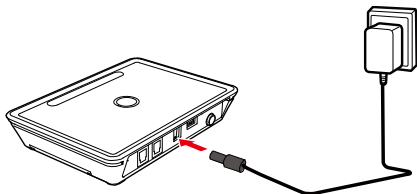

Connecting your Telephone to Sprint Phone Connect

The Sprint Phone Connect device provides ports for up to two telephones. The ports use the same telephone number.

1. Unplug your telephone from your wall's telephone jack.

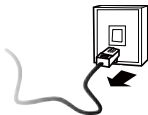

2. Plug the end of your telephone's cord into one of the telephone ports (the other end of the cord must remain plugged into the back of your home telephone base unit).

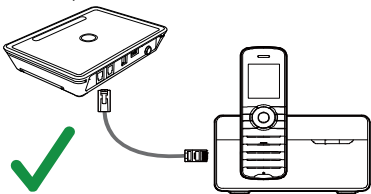

Warning: Do not plug Sprint Phone Connect into your telephone wall jack.

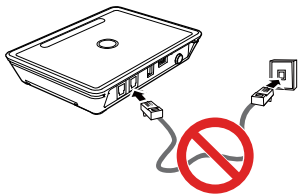

Note:

- The telephone and telephone cord are not included. Customer must provide own telephone and telephone cord.
- The device and telephone cord are for indoor use only.
- Only telephones connected directly to the Sprint Phone Connect will receive service.
- If the Sprint Phone Connect is connected to a cordless phone base station, any extension phones compatible with that base station will also receive service.





Powering on the Device

To power the device on, press and hold the  button until power indicator turns on.

Note: To power the device off, press and hold the  button until all indicators turn off.

Understanding the Indicators

The table below describes a possible status for each of the device indicators.

Icon	Indicator	Status
Voice mail 	Blinking Green	New Message
Battery 	Green	Full Charge
	Blinking Green	Partial Charge
	Blinking Red	Low Charge
	Solid Red	No Battery Charge
Signal 	Green	With signal
	Off	Without signal
Signal Strength 	Green	Good or Ok
	Red	Poor or None
Power	White	The device is on
Software update 	Blinking Green from Left to Right	The software is being updated

Making Calls

1. Before making a call, make sure signal and signal strength indicators are lit up.
2. Place a call by entering the desired telephone number.
3. When your call is complete, hang up or return the phone to the receiver to ensure that you can receive calls.

Receiving Calls

For customers with a new telephone number, simply share your new number with friends & family. When they call, answer the phone connected to your Sprint Phone Connect device.

Adjusting the In-Call Volume

You can adjust the in-call volume in standby mode or during a call. Four volume levels are available, with level 1 being the lowest and level 4 the highest.

Adjusting the In-Call Volume in Standby Mode

1. Pick up the handset.
If you hear the dial tone, the telephone service is available.
2. Enter **##1** to adjust the in-call volume.
3. Press the **1–4** keys to select the desired volume level.
4. Press the * key to save the volume level.
If you hear the confirm tone "toot", you have successfully set the volume level.
If you hear the dial tone again, the device has returned to the off-hook state, and you can proceed to configure other settings.

Note: If you hear the reject tone "toot, toot", you have pressed an incorrect key and failed to adjust the in-call volume. Wait until the device returns to the off-hook state and you hear the dial tone again. Then repeat steps **2** to **4** to adjust the in-call volume again.

Adjusting the In-Call Volume During a Call

1. While engaged in a call, enter **##1** to adjust the in-call volume.
2. Press the **1–4** keys to select the desired volume level.

3. Press the * key to save the volume level.
If you hear the confirm tone "toot", you have successfully set the volume level.
 4. Continue with your call.
- Note:** If you hear the reject tone "toot, toot", you have pressed an incorrect key and failed to adjust the in-call volume. Continue with your call, and repeat steps 1 to 4.

General Functions

Mounting the Device

Using Call Waiting

Making a 3-Way Call

Using Voice Mail

Using Call Forwarding

Assistive Communication Devices

Mounting the Device

Horizontal Mounting

Place the device on a smooth surface with good ventilation. Place it at least 4 inches away from other objects.

Note: Avoid placing Sprint Phone Connect near other electrical equipment, such as Refrigerator, Television, and Microwave.

Wall Mounting

Fix two wall screws (not included) into the wall with the screw heads extending approximately 0.1 inches from the surface of the wall. The distance between two

screws should be 4 inches. Align the mounting brackets with the screws, push the device towards the wall, and connect the brackets with the screws ensuring that the device is stable.

Using Call Waiting

When you are on a call, Call Waiting alerts you to incoming calls.

To use call waiting:

1. When you hear a beep from the receiver on any connected phone during a call, it means a second caller is trying to connect.
2. Press the **FLASH** key to answer to the second call.
3. Press the **FLASH** key again to return to the first call.

Making a 3-Way Call

You can talk with two parties at the same time by using the 3-way call feature on your Sprint Phone Connect. Airtime and other charges, which may include toll or long distance charges will apply for all simultaneous calls. Not available in some areas.

1. While on the first call, dial the number of the second party.
2. Press the **FLASH** key, the first party is automatically put on hold while the call is made.
3. When the 2nd party answers, press the **FLASH** key to initiate the 3-way call.
4. If the second party does not answer, press the **FLASH** key to end the connection and return to the first party.
5. To end both conversations, press the **END** key.

Note: FLASH key will vary by telephone type.

Using Voice Mail

1. The voice mail indicator (📧) will blink green to indicate that you have one or more unheard voice mail messages.
2. Dial *86 to access your voice mail.
3. Follow the system prompts to listen to and manage your voice mails.

Note:

- Dial *86 and follow the system prompts to create your password and record your message.
- Please refer to the Troubleshooting section for additional details on accessing voice mail, or if you would like to use a home telephone answering machine as your preferred method to manage your voice mail messages.

Using Call Forwarding

Sprint Phone Connect allows customers to forward calls to another phone number, including your mobile phone or office number. Your home phone will not ring until you deactivate the service. Airtime applies to forwarded calls even if you send the call to landline telephones.

To Activate Call Forwarding:

1. Dial *72.
2. Immediately enter the phone number where you want calls to be forwarded (e.g. *72-212-123-4567).
3. You will hear a confirmation tone.
4. Hang up your home phone or return the phone receiver to its base.

To Deactivate Call Forwarding:

1. Dial *73.
2. You will hear a confirmation tone.
3. Hang up your home phone or return the phone receiver to its base.

Assistive Communication Devices

TTY (Text Telephony) and TDD (Telecommunications Device for the Deaf) allow individuals who are deaf, hard of hearing, or have speech or language disabilities to communicate by telephone.

When a user types his or her conversation on a TTY keyboard, it is transmitted as tones through the telephone. Tones are received by the other person's TTY, translated into text and displayed on the screen. In order to use the TTY network, you must have a TTY-compatible phone and be in the TTY mode to place or receive calls. Note that most digital wireless devices are TTY-compatible.

Troubleshooting

Why am I not getting a dial tone on my handset?

1. Ensure that the power adaptor is properly connected and that the power indicator is illuminated.
2. Check to make sure the telephone cable is securely plugged in.

Can I create a shortcut to access my voice mail?

The availability of a shortcut feature to access voice mail messages depends solely on the capabilities of the corded or cordless phone that you use with Sprint Phone Connect. Please refer to the user material that came with your phone. If your home phone does not support a shortcut feature to access voice messages, you may have the option to save your voice mail number into the address book on the handset and assign that number to the #1 speed dial position on your phone's keypad. Remember, you can always dial ***86** to access your voice mail.

Can I use my telephone answering device instead of voice mail?

Yes. Set the answering device to fewer rings in order to pick up the call before voice mail. Alternatively, turn off your home answering machine or increase the number of rings if you would like to use the voice mail service. Please refer to the user material provided by the Home Answering Machine manufacturer for instructions.

Does 911 work on this device?

Yes, but since the Sprint Phone Connect is designed for an indoor environment, please be prepared to provide your location inside the premises to public service personnel. The GPS chipset embedded in this device will work best if the device is located near a window or other opening.

Does this product work during a power outage?

While the Sprint Phone Connect has a backup battery, if the landline device requires external power to operate, service (including the ability to make and receive 911 calls) will not be available during a power outage.

Service will only be available during a power outage if the home telephone connected to the device does not rely on external power to operate (as is the case with many corded phones).

How long is the battery life of Sprint Phone Connect?

Talk time is approximately 2.5 hours and standby time is approximately 30 hours. Actual values can vary with environmental conditions.

How does Caller ID (CID) work?

CID allows you to see the caller's name and/or phone number before you take the call. Monthly subscription charges may apply. Please consult your service provider for further information.

Can I adjust the volume on my telephone?

You can adjust the volume using your telephone connected to the Sprint Phone Connect. Four volume levels are available, with level 1 being the softest and level 4 the loudest. The default setting is level 2.

How to set the TTY mode?

Enter the keys **##56*n#** to set the TTY mode.

- n=0: TTY off mode. The standard voice speaking mode and the listening mode. This is the default setting.
- n=1: TTY full mode. Transmit and receive the TTY characters.
- n=2: VCO mode. Receive TTY characters but transmit by speaking into the speaker.
- n=3: HCO mode. Transmit TTY characters but receive by listening to the receiver.

Why do I get the recording, "Call cannot be completed as dialed?"

Check the number to ensure you're dialing correctly, without pauses longer than two seconds between dialed digits.

Warnings and Precautions

This section contains important information pertaining to the operating instructions of your device. It also contains information about how to use the device safely. Read this information carefully before using your device.

Electronic Device

Power off your device if using the device is prohibited. Do not use the device when using the device causes danger or interference with electronic devices.

Medical Device

- Follow rules and regulations set forth by hospitals and health care facilities. Do not use your device when using the device is prohibited.
- Pacemaker manufacturers recommend that a minimum distance of 15 cm be maintained between a device and a pacemaker to prevent potential interference with the pacemaker. If you are using a pacemaker, use the device on the opposite side of the pacemaker and do not carry the device in your front pocket.
- Some wireless devices may affect the performance of hearing aids. For any such problems, consult your service provider.

Potentially Explosive Atmosphere

Power off your device in any area with a potentially explosive atmosphere, and comply with all signs and instructions. Areas that may have potentially explosive atmospheres include the areas where you would normally be advised to turn off your vehicle engine. Triggering of sparks in such areas could cause an explosion or a fire, resulting in bodily injuries or even deaths. Do not power on your device at refueling points such as service stations. Comply with restrictions on the use of radio equipment in fuel depots, storage, and distribution areas, and chemical plants. In addition, adhere to restrictions in areas where blasting operations are in progress. Before using the device, watch out for areas that have potentially explosive

atmospheres that are often, but not always, clearly marked. Such locations include areas below the deck on boats, chemical transfer or storage facilities, and areas where the air contains chemicals or particles such as grain, dust, or metal powders. Ask the manufacturers of vehicles using liquefied petroleum gas (such as propane or butane) whether this device can be safely used in their vicinity.

Traffic Security

- Do not use your device while driving, and observe the local laws and regulations.
- Do not use your device while flying in an aircraft. Power off your device before boarding an aircraft. Using wireless devices in an aircraft may cause danger to the operation of the aircraft and disrupt the wireless telephone network. It may also be considered illegal.

Operating Environment

- Do not use or charge the device in dusty, damp, and dirty places or places with magnetic fields. Otherwise, it may result in a malfunction of the circuit.
- On a stormy day with thunder, do not use your device, to prevent any danger caused by lightning.
- Do not install outdoor antenna, because it may damage your device.
- When you are on a call, do not touch the antenna. Touching the antenna affects the call quality and results in increase in power consumption. As a result, the talk time and the standby time are reduced.
- Use accessories authorized by the manufacturer. Using unauthorized accessories will render the warranty null and void.
- Because the device needs to disperse heat during working, place the device and the power supply in a ventilated and shady place. Never cover the device, put objects on it, or place it near water, fire as well as inflammable and explosive materials.
- This device should be installed and operated with a minimum distance of 20 cm between the antenna and all persons.

- Keep the ambient temperature between -10°C and 50°C while the device is being charged. Keep the ambient temperature between -10°C to 50°C for using the device powered by a battery.

Safety of Children

Comply with all precautions with regard to children's safety. Letting the child play with your device or its accessories, which may include parts that can be detached from the device, may be dangerous, as it may present a choking hazard. Ensure that small children are kept away from the device and accessories.

Accessories

Use the accessories delivered only by the manufacturer. Using accessories of other manufacturers or vendors with this device model may invalidate any approval or warranty applicable to the device, result in the non-operation of the device, and cause danger.

Battery and Charger

- Unplug the charger from the electrical plug and the device when not in use.
- Do not connect two poles of the battery with conductors, such as metal materials, keys, or jewelries. Otherwise, the battery may be short-circuited and may cause injuries and burns on your body.
- Do not disassemble the battery or solder the battery poles. Otherwise, it may lead to electrolyte leakage, overheating, fire, or explosion.
- If battery electrolyte leaks out, ensure that the electrolyte does not touch your skin and eyes. When the electrolyte touches your skin or splashes into your eyes, wash your eyes with clean water immediately and consult a doctor.
- If there is a case of battery deformation, color change, or abnormal heating while you charge or store the battery, remove the battery immediately and stop using it. Otherwise, it may lead to battery leakage, overheating, explosion, or fire.

- If the power cable is damaged (for example, the cord is exposed or broken), or the plug loosens, stop using the cable at once. Otherwise, it may lead to an electric shock, a short circuit of the charger, or a fire.
- Do not dispose of batteries in fire as they may explode. Batteries may also explode if damaged.
- Danger of explosion if battery is incorrectly replaced. Recycle or dispose of used batteries according to the local regulations or reference instruction supplied with your device.

Cleaning and Maintenance

- The device, battery, and charger are not water-resistant. Keep them dry. Protect the device, battery, and charger from water or vapor. Do not touch the device or the charger with a wet hand. Otherwise, it may lead to a short circuit, a malfunction of the device, and an electric shock to the user.
- Do not place your device, battery, and charger in places where they can get damaged because of collision. Otherwise, it may lead to battery leakage, device malfunction, overheating, fire, or explosion.
- Do not place magnetic storage media such as magnetic cards and floppy disks near the device. Radiation from the device may erase the information stored on them.
- Do not leave your device, battery, and charger in a place with an extreme high or low temperature. Otherwise, they may not function properly and may lead to a fire or an explosion.
- Do not place sharp metal objects such as pins near the earpiece. The earpiece may attract these objects and hurt you when you are using the device.
- Before you clean or maintain the device, power off the device and disconnect it from the charger.
- Do not use any chemical detergent, powder, or other chemical agents (such as alcohol and benzene) to clean the device and the charger. Otherwise, parts of the device may be damaged or a fire can be caused. You can clean the device and the charger with a piece of damp and soft antistatic cloth.

- Do not dismantle the device or accessories. Otherwise, the warranty on the device and accessories is invalid and the manufacturer is not liable to pay for the damage.

Emergency Call

You can use your device for emergency calls in the service area. The connection, however, cannot be guaranteed in all conditions. You should not rely solely on the device for essential communications.

FCC Statement

This equipment has been tested and found to comply with the limits for a Class B digital device, pursuant to Part 15 of the FCC Rules. These limits are designed to provide reasonable protection against harmful interference in a residential installation. This equipment generates, uses and can radiate radio frequency energy and, if not installed and used in accordance with the instructions, may cause harmful interference to radio communications. However, there is no guarantee that interference will not occur in a particular installation. If this equipment does cause harmful interference to radio or television reception, which can be determined by turning the equipment off and on, the user is encouraged to try to correct the interference by one or more of the following measures:

- Reorient or relocate the receiving antenna.
- Increase the separation between the equipment and receiver.
- Connect the equipment into an outlet on a circuit different from that to which the receiver is connected.
- Consult the dealer or an experienced radio/TV technician for help.

This device complies with Part 15 of the FCC Rules. Operation is subject to the following two conditions: (1) this device may not cause harmful interference, and (2) this device must accept any interference received, including interference that may cause undesired operation.

Warning: Changes or modifications made to this device not expressly approved by Huawei Technologies Co., Ltd. may void the FCC authorization to operate this device.

Copyright © Huawei Technologies Co., Ltd. 2012. All rights reserved.

No part of this document may be reproduced or transmitted in any form or by any means without prior written consent of Huawei Technologies Co., Ltd.

The product described in this manual may include copyrighted software of Huawei Technologies Co., Ltd. and possible licensors. Customers shall not in any manner reproduce, distribute, modify, decompile, disassemble, decrypt, extract, reverse engineer, lease, assign, or sublicense the said software, unless such restrictions are prohibited by applicable laws or such actions are approved by respective copyright holders under licenses.

Trademarks and Permissions



HUAWEI, HUAWEI, and



are trademarks or registered trademarks of Huawei Technologies Co., Ltd.

Other trademarks, product, service and company names mentioned are the property of their respective owners.

Notice

Some features of the product and its accessories described herein rely on the software installed, capacities and settings of local network, and may not be activated or may be limited by local network operators or network service providers. Thus the descriptions herein may not exactly match the product or its accessories you purchase.

Huawei Technologies Co., Ltd. reserves the right to change or modify any information or specifications contained in this manual without prior notice or obligation.

NO WARRANTY

THE CONTENTS OF THIS MANUAL ARE PROVIDED "AS IS". EXCEPT AS

REQUIRED BY APPLICABLE LAWS, NO WARRANTIES OF ANY KIND, EITHER EXPRESS OR IMPLIED, INCLUDING BUT NOT LIMITED TO, THE IMPLIED WARRANTIES OF MERCHANTABILITY AND FITNESS FOR A PARTICULAR PURPOSE, ARE MADE IN RELATION TO THE ACCURACY, RELIABILITY OR CONTENTS OF THIS MANUAL.

TO THE MAXIMUM EXTENT PERMITTED BY APPLICABLE LAW, IN NO CASE SHALL HUAWEI TECHNOLOGIES CO., LTD. BE LIABLE FOR ANY SPECIAL, INCIDENTAL, INDIRECT, OR CONSEQUENTIAL DAMAGES, OR LOST PROFITS, BUSINESS, REVENUE, DATA, GOODWILL OR ANTICIPATED SAVINGS.

Import and Export Regulations

Customers shall comply with all applicable export or import laws and regulations and will obtain all necessary governmental permits and licenses in order to export, re-export or import the product mentioned in this manual including the software and technical data therein.