

F317

User Guide



1 Getting to know your F317

Front view

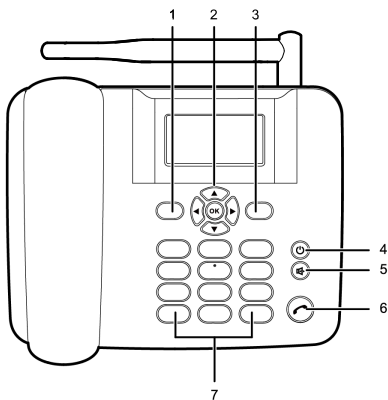

 The figures in this guide are provided for your reference only.

1 Left function key







- Access the main menu in standby mode.
- Select the option displayed in the lower left corner of the screen.

2 Navigation keys



- Access the main menu by pressing the OK key in standby mode.
- Access a shortcut menu by pressing the corresponding navigation key in standby mode.
- Adjust the volume by pressing the navigation keys during a call.





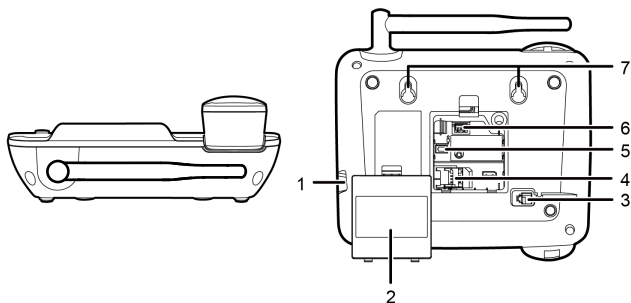



3	Right function key 	Select the option displayed in the lower right corner of the screen.
4	Call key 	<ul style="list-style-type: none"> ● Make or answer a call. ● View the call log in standby mode.
5	End key 	<ul style="list-style-type: none"> ● End or reject a call. ● Press and hold this key to power the phone on or off. ● Return to the standby mode.
6	Hands-free key 	<ul style="list-style-type: none"> ● Make or answer a call without lifting the handset in standby mode. ● In the hands-free mode, cancel the dialing when dialing a number or end the current call.
7	Number and symbol keys	<ul style="list-style-type: none"> ● Enter numbers, letters, and symbols. ● Access voicemail by pressing and holding 1 key in standby mode. ● Speed-dial a user-assigned phone number by pressing and holding 2~9 key in standby mode. ● Press # key to switch between text input methods in editing mode. ● Press * key to display the symbol list in editing mode.

Back and side view



1	Power jack	2	Battery cover
3	Coiled cord jack on main unit	4	SIM card slot
5	Battery container	6	Battery cord jack
7	Wall-mounting brackets		

2 Screen icons

	Full reception		Full battery
	Calling		No service
	Alarm clock		Hands-free mode
	Unread message		Unopened voicemail message
	Powered by the power adapter		

3 Installation

Ensure that F317 is powered off and disconnected from the power adapter.

Installing the SIM card

Ensure that the golden contacts of the SIM card are facing downward and that the beveled edge of the SIM card is properly aligned with that of the SIM card slot. Then check that the SIM card is fully inserted.

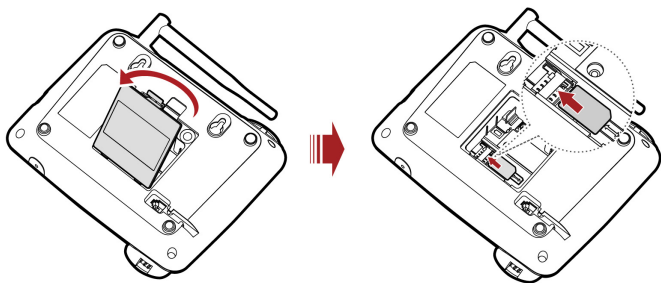

i Do not frequently remove the SIM card when using F317.

Installing the battery

Ensure that the battery is correctly installed.

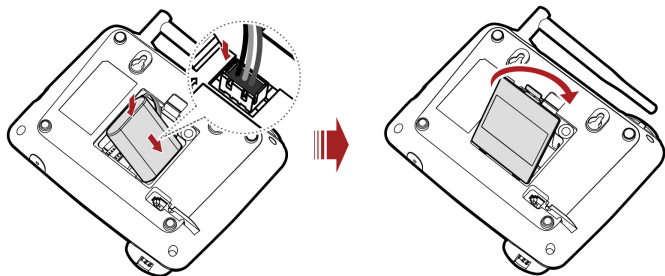

- i** ● When new phones are delivered, the battery power is low. Therefore, charge the phone for a while and then power on the phone the first time you use it.
- If the phone will not be used for a long time, remove the battery from the phone.

Connecting the power adapter

When you use F317, it is recommended that you connect the power adapter to F317.

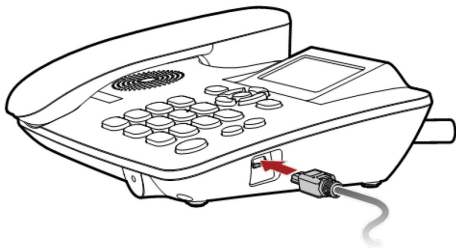

- i** ● If the battery has not been used for a long time or the battery is exhausted, the screen of F317 may not function when you charge the battery again. This is normal. After the battery is being charged for a while, you can power on the phone for use.
- The battery supplies power for only a limited period. Ensure that the battery has been fully charged before putting it in use.

4 Powering on



Press and hold  until the screen lights up to power on the phone.

- i** Press and hold  to power off the phone.

5 calling



Making a call

1. In standby mode, press the number keys to enter a phone number.

2. Press  to dial the number.
3. Press  to end the call or cancel the dialing.



You can also use the following methods to dial the number:



- In standby mode, press  to view the call log. Find the desired number in the call log, and then press  to dial the number.
- Find the desired number in the contacts, and then press  to dial the number.

Answering or rejecting a call



When there is an incoming call, press  to answer the call; press  to reject the call.

6 Messages

Sending a message

1. Select **Messages > Write message**.
2. Write the message.
3. Press  and then add a recipient using the following methods:
 - Enter the recipient's phone number.
 - Add the recipient from the contacts.
4. Press  to send the message.

Reading a message

1. Select **Messages > Inbox**.
2. Press  /  to scroll to a message in the list.
3. Press  to open and read the message.





Press the left function key  to manage the message.

7 Text input methods

Input methods functions





The input methods have following basic functions:

- In editing mode, press the # key to switch between input methods.
- In editing mode, you can press the right function key  to delete the character to the left of the cursor or press and hold the right function key  to delete all characters.
- In predictive and traditional input mode, press the 0 key to enter a space.
- In any input method, press the * key to display the symbol list.

Traditional input

In traditional input mode, press the number keys to enter letters. Press a number key repeatedly until the desired character appears. If the next letter you want to enter is on the same key as the current one, wait until the current letter is entered, and then enter the next one.

Predictive input

1. Press the keys labeled with the letters required to spell the desired word once according to the spelling sequence of the word. As you enter letters, the phone attempts to predict the desired word and displays candidate words.
2. Press  /  to scroll to the desired word.
3. Press  /  to enter the word, or press the 0 key to enter the word followed by a space.

Number input

- In 123 input mode, enter a desired number by pressing the number key.
- In traditional input mode, press and hold corresponding number key to enter numbers.

8 FM

FM Radio helps you conveniently listen to the FM radio programs. Select **Menu > FM**

radio, and then press  /  to switch the channel. Press  /  to adjust the volume.

You can select **Options** for more operations.

9 Security

Setting the phone lock

The phone lock protects your phone from unauthorized use. If you enable phone lock, you will be prompted to enter a phone lock code before you use the phone.

Select **Settings > Security settings > Phone lock** to set the phone lock. You can change the default phone lock code (000000) to a personal password. It is recommended that you periodically change this phone lock code for enhanced security.

Setting the keypad lock

In standby mode, press and hold # key to lock the keypad. In this case, you can only dial emergency numbers and answer incoming calls.

In standby mode, press the left function key  and then  key to unlock the keypad.

Select **Settings > Phone settings > Keypad lock period** to set the keypad lock. If automatic keypad lock function is enabled, the keypad will be automatically locked when the standby time exceeds the preset period in standby mode.

PIN and PUK

Personal identification number (PIN) code helps effectively prevent unauthorized use of your SIM card. Personal unblocking key (PUK) code helps change the locked PIN code. If you enter the wrong PIN code for three times, your SIM card will be locked. In this case, you need to enter the PUK code to unblock the locked PIN code. Please note that if you enter the wrong PUK code for ten times, your SIM card will be permanently locked, you need to consult your service provider to replace your SIM

card. PIN code and PUK code are provided together with the SIM card. For details, consult your service provider.

10 FAQs

If problems occur during the use of the phone, refer to the following sections for a proper solution. If a problem persists, contact your phone vendor.

What can I do if F317 cannot be powered on?

1. Remove the battery cover and check whether the battery is installed properly.
2. If the battery is properly installed, a possible cause for the problem is that the battery power is low. Charge the battery, and then try to power on the phone.

What can I do if no information is displayed on the screen?

If the phone is not used for a long time and the battery runs out of power, the phone may not display any information when it is being charged. This is a normal phenomenon. The phone can be powered on after the battery is charged for a while.

What can I do if battery cannot be charged?

1. Check that the power adapter and the power socket are connected properly.
2. Replace the power adapter or the battery with a new one of the same model.

What can I do if the signal reception is poor?

1. Check that the SIM card is installed properly.
2. Place the phone at a location where strong signals can be received.

What can I do if the in-call volume is too high or too low?

During a call, press navigation keys to adjust the volume.

11 For more help

Please visit <http://consumer.huawei.com/en/support/hotline> for recently updated hotline and email address in your country or region.

12 Safety information

This section contains important information about the operation of your device. It also contains information about how to use the device safely. Read this information carefully before using your device.

Electronic device

Do not use your device if using the device is prohibited. Do not use the device if doing so causes danger or interference with other electronic devices.

Interference with medical equipment

- Follow rules and regulations set forth by hospitals and health care facilities. Do not use your device where prohibited.
- Some wireless devices may affect the performance of hearing aids or pacemakers. Consult your service provider for more information.
- Pacemaker manufacturers recommend that a minimum distance of 15 cm be maintained between a device and a pacemaker to prevent potential interference with the pacemaker. If using a pacemaker, hold the device on the side opposite the pacemaker and do not carry the device in your front pocket.

Areas with flammables and explosives

- Do not use the device where flammables or explosives are stored (in a gas station, oil depot, or chemical plant, for example). Using your device in these environments increases the risk of explosion or fire. In addition, follow the instructions indicated in text or symbols.
- Do not store or transport the device in containers with flammable liquids, gases, or explosives.

Traffic security

- Observe local laws and regulations while using the device. To reduce the risk of accidents, do not use your wireless device while driving.
- Concentrate on driving. Your first responsibility is to drive safely.
- Do not hold the device while driving. Use hands-free accessories.

- When you must make or answer a call, pull off the road safely and park the vehicle first.
- RF signals may affect the electronic systems of motor vehicles. For more information, consult the vehicle manufacturer.
- Do not place the device over the air bag or in the air bag deployment area in a motor vehicle. Doing so may hurt you because of the strong force when the air bag inflates.
- Do not use your device while flying in an aircraft or immediately before boarding. Using wireless devices in an aircraft may disrupt wireless networks, present a hazard to aircraft operation, or be illegal.

Operating environment

- Avoid dusty, damp, or dirty environments. Avoid magnetic fields. Using the device in these environments may result in circuit malfunctions.
- Before connecting and disconnecting cables, stop using the device and disconnect it from the power supply. Ensure that your hands are dry during operation.
- Place the device on a stable surface.
- Keep the device away from electronic appliances that generate strong magnetic or electric fields, such as a microwave oven or refrigerator.
- During thunderstorms, power off your device and remove all cables connected to it to protect against lightning strikes.
- Do not use your device during thunderstorms to protect your device against any danger caused by lightning.
- Ideal operating temperatures are 0 ° C to +45 ° C. Ideal storage temperatures are - 20 ° C to +70 ° C. Extreme heat or cold may damage your device or accessories.
- Keep the device and accessories in a well-ventilated and cool area away from direct sunlight. Do not enclose or cover your device with towels or other objects. Do not place the device in a container with poor heat dissipation, such as a box or bag.
- Do not expose your device to direct sunlight (such as on a car dashboard) for prolonged periods.
- To protect your device or accessories from fire or electrical shock hazards, avoid rain and moisture.
- Keep the device away from sources of heat and fire, such as a heater, microwave oven, stove, water heater, radiator, or candle.
- Do not place any object, such as a candle or a water container, on the device. If any foreign object or liquid enters the device, immediately stop using it, power it off, and remove all cables connected to it. Then, contact an authorized service center.

- Do not block device openings. Reserve a minimum of 10 cm around the device to dissipate heat.
- Do not place sharp metal objects, such as pins, near the earpiece or speaker. The earpiece may attract these objects and result in injury.
- Stop using your device or applications for a while if the device is overheated. If skin is exposed to an overheated device for an extended period, low temperature burn symptoms, such as red spots and darker pigmentation, may occur.
- Do not touch the device's antenna. Otherwise, communication quality may be reduced.
- Do not allow children or pets to bite or suck the device or accessories. Doing so may result in damage or explosion.
- Observe local laws and regulations, and respect the privacy and legal rights of others.
- Keep the device in a place with good reception. The distance between the device and other metal materials (such as metal brackets or metal doors and windows) should be greater than 25 cm and the distance between the device should be greater than 30 cm.

Child's safety

- Comply with all precautions with regard to child's safety. Letting children play with the device or its accessories may be dangerous. The device includes detachable parts that may present a choking hazard. Keep away from children.
- The device and its accessories are not intended for use by children. Children should only use the device with adult supervision.

Accessories

- Using an unapproved or incompatible power adapter, charger or battery may cause fire, explosion or other hazards.
- Choose only accessories approved for use with this model by the device manufacturer. The use of any other types of accessories may void the warranty, may violate local regulations and laws, and may be dangerous. Please contact your retailer for information about the availability of approved accessories in your area.

Charger safety

- For pluggable devices, the socket-outlet shall be installed near the devices and shall be easily accessible.
- Unplug the charger from electrical outlets and the device when not in use.
- Do not drop or cause an impact to the charger.
- If the power cable is damaged (for example, the cord is exposed or broken), or the plug loosens, stop using it at once. Continued use may lead to electric shocks, short circuits, or fire.

- Do not touch the power cord with wet hands or pull the power cord to disconnect the charger.
- Do not touch the device or the charger with wet hands. Doing so may lead to short circuits, malfunctions, or electric shocks.
- If your charger has been exposed to water, other liquids, or excessive moisture, take it to an authorized service center for inspection.
- Ensure that the charger meets the requirements of Clause 2.5 in IEC60950-1/EN60950-1/UL60950-1 and has been tested and approved according to national or local standards.
- Connect the device only to products with the USB-IF logo or with USB-IF compliance program completion.

Battery safety

- Do not connect battery poles with conductors, such as keys, jewelry, or other metal materials. Doing so may short-circuit the battery and cause injuries or burns.
- Keep the battery away from excessive heat and direct sunlight. Do not place it on or in heating devices, such as microwave ovens, stoves, or radiators. Batteries may explode if overheated.
- Do not attempt to modify or remanufacture the battery, insert foreign objects into it, or immerse or expose it to water or other liquids. Doing so may lead to fire, explosion, or other hazards.
- If the battery leaks, ensure that the electrolyte does not make direct contact with your skins or eyes. If the electrolyte touches your skins or splashes into your eyes, immediately flush with clean water and consult a doctor.
- In case of battery deformation, color change, or overheating while charging or storing, immediately stop using the device and remove the battery. Continued use may lead to battery leakage, fire, or explosion.
- Do not put batteries in fire as they may explode. Damaged batteries may also explode.
- Dispose of used batteries in accordance with local regulations. Improper battery use may lead to fire, explosion, or other hazards.
- Do not allow children or pets to bite or suck the battery. Doing so may result in damage or explosion.
- Do not smash or pierce the battery, or expose it to high external pressure. Doing so may lead to a short circuit or overheating.
- Do not drop the device or battery. If the device or battery is dropped, especially on a hard surface, it may be damaged.
- If the device standby time shortens significantly, replace the battery.

Cleaning and maintenance

- During storage, transportation, and operation of the device, keep it dry and

protect it from collision.

- Keep the device and accessories dry. Do not attempt to dry it with an external heat source, such as a microwave oven or hair dryer.
- Do not expose your device or accessories to extreme heat or cold. These environments may interfere with proper function and may lead to fire or explosion.
- Avoid collision, which may lead to device malfunctions, overheating, fire, or explosion.
- If the device is not going to be used for an extended period of time, power it off, and remove all cables connected to it.
- If anything unusual occurs (for example, if the device emits smoke or any unusual sound or smell), immediately stop using it, power it off, remove all cables connected to it, and contact an authorized service center.
- Do not trample, pull, or excessively bend any cable. Doing so may damage the cable, causing the device to malfunction.
- Before you clean or maintain the device, stop using it, stop all applications, and disconnect all cables connected to it.
- Do not use any chemical detergent, powder, or other chemical agents (such as alcohol and benzene) to clean the device or accessories. These substances may cause damage to parts or present a fire hazard. Use a clean, soft, and dry cloth to clean the device and accessories.
- Do not place magnetic stripe cards, such as credit cards and phone cards, near the device for extended periods of time. Otherwise the magnetic stripe cards may be damaged.
- Do not dismantle or remanufacture the device and its accessories. This voids the warranty and releases the manufacturer from liability for damage. In case of damage, contact an authorized service center for assistance or repair.
- If the device screen is broken in a collision, immediately stop using the device. Do not touch or attempt to remove the broken parts. Promptly contact an authorized service center.

Emergency calls

The availability of emergency calls is subject to your cellular network quality, service provider policy, and local laws and regulations. Never rely solely on your device for critical communications like medical emergencies.

Environmental protection

- The device and its accessories (if included), such as the power adapter, headset, and battery should not be disposed of with household garbage.
- Disposal of the device and its accessories is subject to local regulations. Support proper collection and recycling.

FCC Regulatory Compliance

Body worn operation

The device complies with RF specifications when used at a distance of 2.5 cm from your body. Ensure that the device accessories, such as a device case and device holster, are not composed of metal components. Keep the device away from your body to meet the distance requirement.

Certification information (SAR)

This device is also designed to meet the requirements for exposure to radio waves established by the Federal Communications Commission (USA).

The SAR limit adopted by the USA is 1.6 W/kg averaged over one gram of tissue. The highest SAR value reported to the FCC for this device type complies with this limit.

The highest SAR value reported to the FCC for this device type when using in portable exposure conditions is 0.867 W/kg.

FCC statement

This equipment has been tested and found to comply with the limits for a Class B digital device, pursuant to Part 15 of the FCC Rules. These limits are designed to provide reasonable protection against harmful interference in a residential installation. This equipment generates, uses and can radiate radio frequency energy and, if not installed and used in accordance with the instructions, may cause harmful interference to radio communications. However, there is no guarantee that interference will not occur in a particular installation. If this equipment does cause harmful interference to radio or television reception, which can be determined by turning the equipment off and on, the user is encouraged to try to correct the interference by one or more of the following measures:

- Reorient or relocate the receiving antenna.
- Increase the separation between the equipment and receiver.
- Connect the equipment into an outlet on a circuit different from that to which the receiver is connected.
- Consult the dealer or an experienced radio/TV technician for help.

This device complies with Part 15 of the FCC Rules. Operation is subject to the following two conditions: (1) this device may not cause harmful interference, and (2) this device must accept any interference received, including interference that may cause undesired operation.

Caution: Any changes or modifications to this device not expressly approved by Huawei Technologies Co., Ltd. for compliance could void the user's authority to operate the equipment.

This device is intended to be attached to a receiver that is not used to receive over-the-air broadcast signals. Connection of this device in any other fashion may cause harmful interference to radio communications and is in violation of the FCC Rules, part 15.

13 Legal Notice

Copyright © Huawei Technologies Co., Ltd. 2014. All rights reserved.

No part of this manual may be reproduced or transmitted in any form or by any means without prior written consent of Huawei Technologies Co., Ltd. and its affiliates ("Huawei").

The product described in this manual may include copyrighted software of Huawei and possible licensors. Customers shall not in any manner reproduce, distribute, modify, decompile, disassemble, decrypt, extract, reverse engineer, lease, assign, or sublicense the said software, unless such restrictions are prohibited by applicable laws or such actions are approved by respective copyright holders.

Trademarks and Permissions



HUAWEI, **HUAWEI**, and



are trademarks or registered trademarks of Huawei Technologies Co., Ltd.

Other trademarks, product, service and company names mentioned may be the property of their respective owners.

Notice

Some features of the product and its accessories described herein rely on the software installed, capacities and settings of local network, and therefore may not be activated or may be limited by local network operators or network service providers.

Thus, the descriptions herein may not exactly match the product or its accessories which you purchase.

Huawei reserves the right to change or modify any information or specifications contained in this manual without prior notice and without any liability.

DISCLAIMER

ALL CONTENTS OF THIS MANUAL ARE PROVIDED "AS IS". EXCEPT AS REQUIRED BY APPLICABLE LAWS, NO WARRANTIES OF ANY KIND, EITHER EXPRESS OR IMPLIED, INCLUDING BUT NOT LIMITED TO, THE IMPLIED WARRANTIES OF MERCHANTABILITY AND FITNESS FOR A PARTICULAR PURPOSE, ARE MADE IN RELATION TO THE ACCURACY, RELIABILITY OR CONTENTS OF THIS MANUAL.

TO THE MAXIMUM EXTENT PERMITTED BY APPLICABLE LAW, IN NO EVENT SHALL HUAWEI BE LIABLE FOR ANY SPECIAL, INCIDENTAL, INDIRECT, OR CONSEQUENTIAL DAMAGES, OR LOSS OF PROFITS, BUSINESS, REVENUE, DATA, GOODWILL SAVINGS OR ANTICIPATED SAVINGS REGARDLESS OF WHETHER SUCH LOSSES ARE FORSEEABLE OR NOT.

THE MAXIMUM LIABILITY (THIS LIMITATION SHALL NOT APPLY TO LIABILITY FOR PERSONAL INJURY TO THE EXTENT APPLICABLE LAW PROHIBITS SUCH A LIMITATION) OF HUAWEI ARISING FROM THE USE OF THE PRODUCT DESCRIBED IN THIS MANUAL SHALL BE LIMITED TO THE AMOUNT PAID BY CUSTOMERS FOR THE PURCHASE OF THIS PRODUCT.

Import and Export Regulations

Customers shall comply with all applicable export or import laws and regulations and be responsible to obtain all necessary governmental permits and licenses in order to export, re-export or import the product mentioned in this manual including the software and technical data therein.

Privacy Policy

To better understand how we protect your personal information, please see the privacy policy at <http://consumer.huawei.com/privacy-policy>.