

## **Copyright © Huawei Technologies Co., Ltd. 2014.**

### **All rights reserved.**

No part of this document may be reproduced or transmitted in any form or by any means without prior written consent of Huawei Technologies Co., Ltd.

The product described in this manual may include copyrighted software of Huawei Technologies Co., Ltd and possible licensors. Customers shall not in any manner reproduce, distribute, modify, decompile, disassemble, decrypt, extract, reverse engineer, lease, assign, or sublicense the said software, unless such restrictions are prohibited by applicable laws or such actions are approved by respective copyright holders under licenses.

### **Trademarks and Permissions**



HUAWEI,

HUAWEI, and



are trademarks or registered trademarks of Huawei Technologies Co., Ltd.

Other trademarks, product, service and company names mentioned are the property of their respective owners.

### **Notice**

Some features of the product and its accessories described herein rely on the software installed, capacities and settings of local network, and may not be activated or may be limited by local network operators or network service providers, thus the descriptions herein may not exactly match the product or its accessories you purchase.

Huawei Technologies Co., Ltd reserves the right to change or modify any information or specifications contained in this manual without prior notice or obligation.

### **NO WARRANTY**

THE CONTENTS OF THIS MANUAL ARE PROVIDED "AS IS". EXCEPT AS REQUIRED BY APPLICABLE LAWS, NO WARRANTIES OF ANY KIND, EITHER EXPRESS OR IMPLIED, INCLUDING BUT NOT LIMITED TO, THE IMPLIED WARRANTIES OF MERCHANTABILITY AND FITNESS FOR A PARTICULAR PURPOSE, ARE MADE IN RELATION TO THE ACCURACY, RELIABILITY OR CONTENTS OF THIS

MANUAL.

TO THE MAXIMUM EXTENT PERMITTED BY APPLICABLE LAW, IN NO CASE SHALL HUAWEI TECHNOLOGIES CO., LTD BE LIABLE FOR ANY SPECIAL, INCIDENTAL, INDIRECT, OR CONSEQUENTIAL DAMAGES, OR LOST PROFITS, BUSINESS, REVENUE, DATA, GOODWILL OR ANTICIPATED SAVINGS.

### **Import and Export Regulations**

Customers shall comply with all applicable export or import laws and regulations and will obtain all necessary governmental permits and licenses in order to export, re-export or import the product mentioned in this manual including the software and technical data therein.

# Contents

Getting to Know the ME909u-523 .....	1
PCB Design .....	3
Assembly .....	4

## Thank you for purchasing HUAWEI ME909u-523 LTE LGA Module (hereinafter referred to as the ME909u-521)

### Note:

- This manual briefly describes the preparation, the process for PCB Design, Assembly and safety precautions.
- You are recommended to read the manual before using the ME909u-521.

## Getting to Know the ME909u-523

- The package of the LGA module is 145 pin LGA with a dimension of 30 mm × 30 mm × 2.35 mm. It is applied to the user interface board, and can be used as a wireless terminal in a network environment.

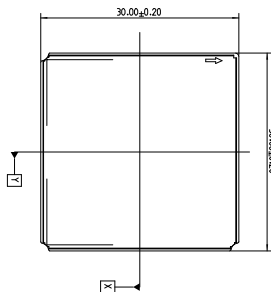

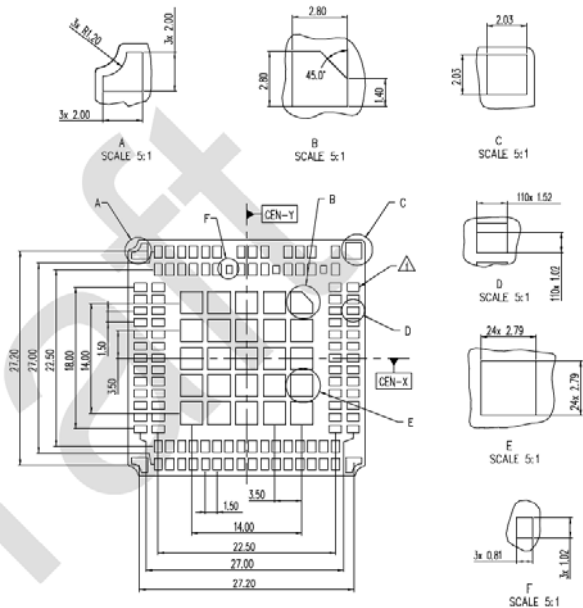

# PCB Design

## PCB Pad Design

To achieve assembly yields and solder joints of high reliability, it is recommended that the PCB pad size be designed as follows: the sizes of the solder pads on customers' PCBs are the same as those of the module's solder pads for the high production efficiency and high reliability of solder joints. For details, see the following figure:

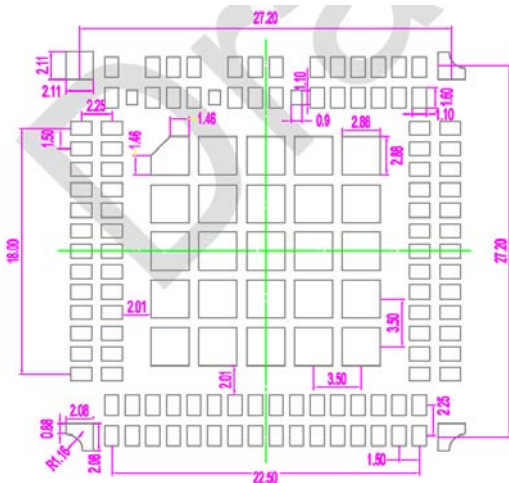

## Requirements on PCB Layout

- The thickness of PCB is more than 1.0 mm (1.2 mm recommended) to reduce the deformation caused by high temperature welding.
- The minimum distance between the LGA module and the PCB edge is 1.5 mm. Other devices must be located more than 1 mm away from the LGA module (more than 3 mm recommended if rework is considered).
- When the PCB layout is double sided, it is recommended that the LGA module be placed on the second side for assembly.

## Design of Solder Mask



- The PCB pad design can be solder mask defined (SMD), or non-solder mask defined (NSMD). NSMD is recommended. In addition, the solder mask of the NSMD pad design is larger than the pad so the reliability of the solder joint can be improved.
- The solder mask must be 100  $\mu\text{m}$  to 150  $\mu\text{m}$  larger than the pad, that is, the single side of the solder mask must be 50  $\mu\text{m}$  to 75  $\mu\text{m}$  larger than the pad. The specific size depends on the processing capability of the PCB manufacturer.

## Assembly

### Stencil Design

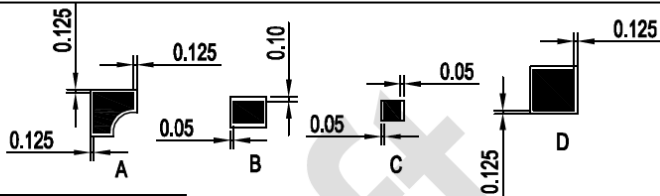
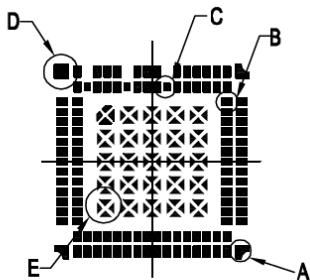
It is recommended that the stencil for the LGA module be 0.15 mm in thickness. For the stencil design, see the following figure:



 PCB PADS  
 Stencil design  
 Unit:mm

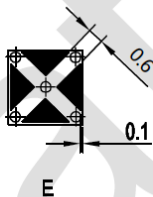



## Reflow Profile

For the soldering temperature of the LGA module, see the following figure.

Reflow profile

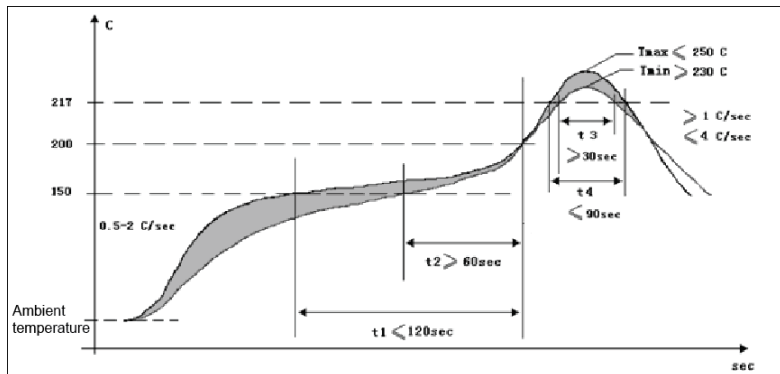

## Reflow parameters

Temperature Zone	Time	Key Parameter
Preheat zone (40°C–150°C)	60s–120s	Heating rate: 0.5°C/s–2°C/s
Soak zone (150°C–200°C)	(t1–t2): 60s–120s	Heating rate: < 1.0°C/s
Reflow zone (> 217°C)	(t3–t4): 30s–90s	Peak reflow temperature: 230°C–250°C
Cooling zone	Cooling rate: 1°C/s ≤ Slope ≤ 4°C/s	