

Contents

1 Safety Information	2
1.1 General Safety Precautions	2
1.2 Installation Environment	5
1.2.1 Indoor Installation	6
1.2.2 Outdoor Installation	7
1.3 Electrical Safety.....	8
1.4 Battery Safety.....	9
1.4.1 Basic Requirements.....	10
1.4.2 Requirements for Rechargeable Batteries	10
1.4.3 Requirements for Non-Rechargeable Batteries	11
1.5 Radiation Safety.....	12
1.5.1 Electromagnetic Field Exposure	12
1.5.2 Laser Radiation.....	13
1.6 Mechanical Safety	14
1.7 Maintenance Safety	17
1.8 Safety Signs.....	18

1 Safety Information



1.1 General Safety Precautions













- Read all safety information before installing, operating, and maintaining Huawei equipment.
- To minimize risk of personal injury and equipment damage, always follow all safety precautions marked on equipment and described in manuals.
- The **Caution**, **Warning** and **Danger** sections in the manual are only a supplement and do not represent all safety instructions.
- Use the equipment only where all design specifications are met. Otherwise, any resulting equipment failure and its negative consequences to equipment, parts, personnel, and property will not be covered by the warranty.

Definitions

- **Skilled personnel:**
Possesses experience or has been trained in the technology and methodology used in the equipment. Such personnel must know about the sources and magnitude of safety risks involved.
- **Trained personnel:**
Has been taught or supervised by skilled personnel and can identify the sources of safety risks involved and take precautions to avoid unintentional exposure. Such personnel should avoid risky areas under all operating conditions, be aware of operational risks, and minimize these risks.
- **User or operator:**
All other personnel, including those with access to the equipment or who may be in the vicinity of the equipment.

Symbol Conventions

-  **Caution** prompts users to be careful. Such sections provide helpful suggestions or links to external references.
-  **Warning** prompts users to be careful. In such situations, certain user actions may result in equipment damage or loss of data.

- 
Danger indicates critical safety instructions. Users are at risk of bodily injury and must be familiar with standard accident prevention before performing any operation on the equipment, especially actions involving electric circuits.
- 
 indicates a part exposed to high voltage. This symbol warns operators that both direct and indirect contact with the power grid is fatal. Such areas include hazardous voltage points or protective power supply covers that may be removed during maintenance.
- 
 indicates overheating. This symbol is found on hot equipment surfaces that can cause burns. Do not touch the equipment during operation or maintenance, and wear heat insulation gloves when working in the area.
- 
 indicates that microwave emission. The symbol is attached near the output socket of the transmitter power amplifier or antenna socket of the transmitter combiner to indicate RF radiation. Do not tamper with the transmitter output feeder or antenna feeder connector when the transmitter is on. Turn off the transmitter before disconnecting the feeder connector or working near the transmit antenna.
- 
 or 
 indicates protection earthing. This symbol is attached next to a protection ground terminal next to grounded equipment and an external ground system. An equipment ground cable is connected to an external ground bar through the protection ground terminal.
- 
 indicates equipotential bonding. This symbol is found with equipotential terminals inside equipment.
- 
 indicates electrostatic discharge. This symbol is used in all electrostatic sensitive areas. Before operating equipment in these areas, wear ESD gloves or an ESD wrist strap.
- 
 indicates that the equipment is safe to use in altitudes below 2000 m (6561.6 ft.).
- 
 indicates that the equipment is not safe to use in tropical climates.
- 
 prompts operators not to touch the blades when the fan is rotating. It is silkscreened on or attached to a fan box panel.
- 
 or 
 prompts users to read the instruction manual. This symbol is used for additional instructions that are absent on the parts label. Such scenarios include but are not limited to:
 - For equipment with multiple power supplies, this symbol replaces the multi-power symbol next to the power supplies. It reminds users that the equipment has multiple power supplies that must all be disconnected when powering off the equipment.

- For equipment with multiple output ports, this symbol is found at the output ports. Read the manual before connection for the rating and configuration information.
- For equipment with multiple slots, this symbol reminds the user to read the manual for slot information, board restrictions, and usage conditions.

Basic Precautions

- Trained personnel must be certified, understand all required safety regulations, and master correct operational methods before installing, operating and maintaining Huawei equipment.
- All work with equipment must comply with local laws and regulations. Safety information in the manual only serves as a supplement. In addition:
 - Only skilled and trained personnel can install, operate, and maintain equipment.
 - Only skilled and trained personnel can remove safety infrastructure and maintenance equipment.
 - Operators must report faults or errors that may cause safety issues promptly.
 - All personnel working with equipment should have high-voltage operation, climbing, special equipment operation, and other operational qualifications required by the local country.
- If personal injury or equipment damage occurs during installation, stop operations immediately, report the situation to the project owner, and take effective protective measures.
- All work on outdoor equipment is strictly forbidden in lightning, rain, snow, wind and other adverse weather conditions. Such work includes but is not limited to outdoor equipment transportation, cabinet installation, power cable installation, and outdoor cable connection.
- Do not wear watches, jewelry, or other conductive objects when working with equipment.
- Dedicated insulation safety tools such as gloves, clothing, helmet, and shoes must be worn at all times, as shown in Figure 1-1.

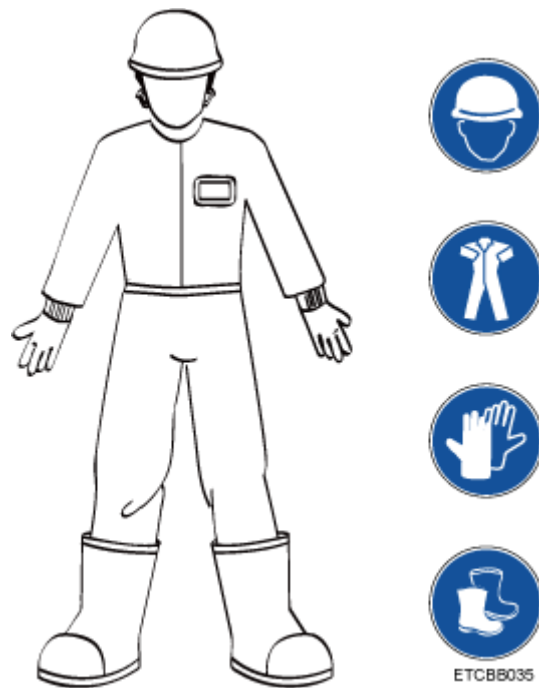
Figure 1-1 Safety personal protective equipment (PPE)

- Always follow the procedures in the *Hardware Installation and Maintenance Guide*, *Configuration Guide*, and *Operation and Maintenance Guide* while working.
- Use a voltmeter to measure the voltage at the contact point before touching any metal surface or terminal to prevent electric shocks.
- Ensure that all slots are filled with boards or filler panels. Avoid exposure to board hazardous voltage and heat by ensuring that ventilation channels are working normally, that electromagnetic interference is controlled, and that the backplane, motherboard, and boards are free from dust or foreign matter.
- After equipment installation, conduct routine checks and maintenance. Promptly replace faulty parts as required by the *Hardware Installation and Maintenance Guide* and *Operation and Maintenance Guide*.
- After equipment installation, clear the area of packaging materials such as the box, styrofoam, plastic, and cable ties.
- In case of fire, evacuate from the building or equipment area and activate the fire alarm or call the fire emergency number. Do not reenter the burning building under any circumstances.
- The device must be fixed securely on the floor or other reliable objects, such as the walls and the mounting racks before operation.
- The equipment operating temperature range between -40°C to 55°C .
- The equipment operating voltage range between -36Vdc to -57Vdc .

1.2 Installation Environment

- Ensure that the installation environment complies with equipment specifications, including voltage, temperature, humidity, altitude, degree of pollution, overvoltage category, and waterproofing and dustproofing classification.

- Avoid flammable, explosive gas or smog environments.
- Keep the installation site free of acidic, alkaline or other corrosive gases.
- Keep the equipment away from sources of heat or fire, such as the electric heater, microwave oven, oven, water heater, fireplace, candle or other heat generators. Heat may cause the equipment to catch fire or its housing to melt.
- Do not obscure or cover running equipment with flammable materials such as paper or fabric. This hampers heat dissipation and can cause the equipment to catch fire or its housing to melt.
- Install and use the equipment and its system in a location with restricted access location.
- Do not block air vents when the equipment is running. Maintain air vents away from the wall or other objects as required in the *Hardware Installation and Maintenance Guide*. The minimum distance is 5 cm (1.97 in.) unless specified.
- Do not use equipment that does not meet IP54 waterproof and dustproof standards in outdoor environments.

1.2.1 Indoor Installation

- Ensure that there is no water leakage or condensation from air conditioning failure in the equipment room on the top of the equipment. Introducing water into the equipment will cause it to fail.
- Install fixed equipment with a large hole at the bottom on concrete, tile or other non-combustible surfaces.
- Prevent rodent and pest infestations at the installation site.

Wall Installation

- Before drilling holes on the wall, ensure that there is no circuitry, water pipe, or gas pipeline in the wall area to be drilled to avoid bodily injury.
- Do not place any flammable or explosive objects above or under the equipment, and do not obstruct the equipment with foreign objects within a 1-meter (3.28 ft.) radius.
- Ensure that no hole are drilled that face upwards to prevent water ingress and equipment damage.
- Ensure that screws are securely installed. Otherwise, the equipment may fall due to tension after cable connection, causing equipment damage or even bodily injury.

Desktop Installation

- Ensure that the desk or workbench is in stable contact with the ground.
- Do not put other items on the equipment.
- Do not place cups with liquid on or next to the equipment. Spillage may enter the equipment and pose safety risks. If this happens, immediately stop the equipment, cut off the power supply, disconnect all cables, and contact after-sales personnel.

Cabinet Installation

- Before installing equipment in a cabinet, ensure that the cabinet is securely fastened with a balanced center of gravity. Otherwise, tipping or falling cabinets may cause bodily injury and equipment damage.
- Leave proper clearance around the equipment.
- Make sure an enclosed cabinet is adequately ventilated.

1.2.2 Outdoor Installation

Outdoor Installation Requirements

- Do not work on outdoor equipment and cables in lightning, rainy, snowy, windy (wind force > 6) and other adverse weather conditions.
- Ensure that the enclosure is class IP54 or higher.
- Comply with all related local regulations.
- Set up signs at the site to indicate a dangerous restricted area inaccessible to unauthorized personnel.
- The scaffolding, platforms, and workbench must pass safety checks to ensure structural integrity. Do not overload the scaffolding.
- Avoid simultaneous work at heights and on the ground. If such situations cannot be avoided, erect a special protective shed or other protective measures between the height and ground, and clear piles of tools and property from the area.
- Do not loiter in the work area.
- Any violations must be promptly pointed out by the site manager or safety supervisor and prompted for correction. If the problem persists, the personnel involved risks suspension that is regarded as absenteeism.

Operators are responsible for accidents resulting from violation of safety regulations or failure to make timely correction. Supervisors also bear responsibility.

Installation at Heights

- Work performed 2 m (6.56 ft.) above the ground is regarded as work at heights.
- Work at heights, comply with related local regulations.
- Only skilled and trained personnel are allowed to work at heights.
- Stop such work in any of the following conditions: adverse weather, wet steel tubes, and other risky situations. Resume work only after a Huawei safety director and related technical personnel have checked all the equipment.
- The ladder used in work at heights must be intact and skid-resistant to ensure safe climbing. The recommended angle between the ladder and the ground is 75 °. When using a step ladder, the rope must be strong and the ladder must be supported.
- Place guardrails and warning signs around protrusions and holes to avoid accidents.



Warning

- Before proceeding, carefully check climbing and safety tools, such as the safety helmet, safety belt, ladder, springboard, scaffolding, and hoisting equipment. If any tool does not meet requirements, fix or replace it immediately, or postpone the work.
 - Wear proper safety PPE and a helmet as well as a belt or waist rope secured to a robust support. Do not tie the belt or waist rope to an unstable object or metal with sharp edges. A fastener that detaches may cause a falling accident.
 - Avoid dropping machinery and tools that may cause injury.
 - Transport all objects from or to the ground level by a strong rope, basket, elevated vehicle, or crane instead of throwing them.
 - Do not pile up scaffolding, materials, and other debris on the ground under the work area at heights that cause traffic obstructions.
 - After completion, disassemble the scaffolding layer by layer from top to bottom. Do not disassemble top and bottom layers at the same time. When disassembling a part, prevent the collapse of other parts.
-

1.3 Electrical Safety

Grounding

- Ensure that the protection ground is reliably grounded in accordance with local building distribution specifications.
- For equipment requiring grounding, always connect the protection ground first and disconnect it last when installing the equipment.
- For the equipment using a socket with an earthing terminal, ensure that the earthing terminal is correctly grounded.
- The device must be connected permanently to the protection ground before an operation. The cross-sectional area of the protective ground conductor must be at least 1mm².

AC/DC Operation



Danger

- Do not contact the power system supply directly or indirectly through damp material. The hazardous voltage may cause electric shock.
 - Improper operation may cause accidents such as fire and electric shock.
 - This device relies on the building's installed overcurrent protection from short circuits. Ensure that a fuse or circuit breaker no larger than 80 V, 30 A is used on the phase conductors that include all current-carrying conductors. Check that all specifications are compatible before equipment installation.
 - If the power input of the equipment is permanent, ensure that an easy-to access disconnection device is installed on the exterior of the equipment.
-

- Use AC-supplied models for TN, TT power systems.
- For DC-supplied models, use reinforced insulation or double insulation to isolate the DC source from the AC mains supply.
- Before connecting equipment, disconnect the corresponding external-equipment circuit breaker.
- Before connecting the load (electrical equipment) or battery cable, verify that the input voltage is within the rated voltage range of the equipment.
- Before connecting the load (electrical equipment) or battery cable, check the cable and terminal polarities to avoid reverse connection.
- Before powering on, verify that equipment electrical connections are correct.
- If the device has more than one power supply, disconnect all of them when powering off the device.

Cabling Requirements

- Only cut the insulation layer at the wiring part when preparing the power cable at the site. Doing so prevents accidents and fire from short circuit.
- High-temperature environments may cause wear and tear on the insulation layer. Leave sufficient clearance between the cable and power busbar, current shunt, fuse, heat sink and other heating devices.
- Bind the signal cable and the strong current or high-voltage cable separately.
- Cables provided by the customer must comply with local cable regulations.
- Do not route any cable through the air exhaust vent in the cabinet.
- If cables have been stored in an ambient temperature below 0 °C (32 °F), move the cables to a room-temperature environment at least 24 hours before installation

TNV Circuits

- To avoid electric shocks, do not connect the safety extra-low voltage (SELV) circuit to the telecommunication network voltage (TNV) circuit.
- Do not tamper the cable connected to the outdoor signal port in adverse weather conditions.
- To reduce the risk of fire, use only a No. 26 AWG or larger telecommunication line cord.

ESD Requirements

- To avoid component damage caused by electrostatic buildup, wear ESD gloves or an ESD wrist strap and properly ground the other end of the ESD wrist strap before touching a circuit board.
- Hold the board by its component-free edge and do not touch chips with your hands.
- Place removed boards in ESD packaging for storage or transportation.

1.4 Battery Safety

The safety information in this document is a reminder and for reference only. Read the detailed safety information in the manufacturer instructions before battery installation, operation, and maintenance.

**Danger**

Before installing batteries, ensure that you understand the safety requirements and correct connection procedures.

1.4.1 Basic Requirements

- Do not expose batteries to high temperatures or heat sources such as sunlight, heaters, microwave ovens, ovens and water heaters. Overheating batteries may explode.
- Do not disassemble or refit batteries, insert foreign objects, or submerge into water or other liquid. Leakage, overheating, fire, or explosion may occur.
- Wear goggles, rubber gloves, and protective clothing during installation and maintenance to avoid injury caused by electrolyte spillage. Avoid contact with eyes and skin in case of battery leakage. Rinse any accidentally exposed area with water and seek immediate medical treatment.
- Transport batteries in their specified positions. Do not tilt or turn them upside down.
- Disconnect the circuit before battery installation and maintenance.
- Use the same or equivalent type of battery to replace faulty ones. Incorrectly replaced batteries may explode.
- Do not connect metallic conductors to battery terminals or contact battery endpoints. Battery short circuit or overheating may occur and cause injury.
- Follow local regulations for battery disposal. Do not dispose of batteries as domestic waste. Incorrectly disposed batteries may explode.
- Do not drop, squeeze or puncture batteries. Avoid strong external pressure that may cause internal short circuit and overheating.
- Do not use damaged batteries.
- Keep children and pets away from batteries to avoid injury or battery explosion.

1.4.2 Requirements for Rechargeable Batteries

- If discoloration, deformation, overheating, or any other abnormality occurs, replace the batteries before continuing with usage, charging or storage.
- Tighten battery cables or copper bars using the torque specified in the battery documentation. Insecure connection of battery bolts may cause excessive voltage drop or even overcurrent leading to battery overheating.

Short Circuit Protection

**Danger**

Battery short circuit will produce a strong spike in current and release a large amount of heat energy that may cause bodily injury and property damage.

Disconnect running batteries before other operations whenever possible.

Flammable Gas Protection



- Do not use unsealed lead-acid batteries.
 - Lead-acid batteries should be positioned and secured horizontally for normal hydrogen discharge to avoid combustion or equipment corrosion.
-

Improper usage of lead-acid batteries will cause the release of flammable gas. Ensure that batteries are kept in a well-ventilated area and take preventive measures against fire.

Leakage Protection



Battery overheating causes deformation, damage, and electrolyte spillage.

- If the battery temperature exceeds 60 °C (140 °F), check for and promptly handle any leakage.
-



Use a neutralizing liquid to absorb any electrolyte spillage. Exercise caution when handling the leaking battery because the electrolyte can cause injury.

- When removing or moving the battery with spilled electrolyte, be careful with the electrolyte that can bring potential injury. If any electrolyte spills, use NaHCO_3 or Na_2CO_3 to neutralize and absorb it.
-

Battery Discharge Protection

After batteries are installed, ensure that the fuse or circuit breaker is disconnected before powering on the system. This avoids battery damage caused by power discharge in case of long-term power-off.

1.4.3 Requirements for Non-Rechargeable Batteries

- If discoloration, deformation, overheating, or any other abnormality occurs, replace the batteries before continuing with usage, charging or storage.
- Do not attempt to replace non-removable, built-in batteries. Doing so may damage the batteries or the equipment. Batteries must be replaced by an authorized service center.
- Do not throw batteries into fire.

1.5 Radiation Safety

1.5.1 Electromagnetic Field Exposure



Warning

Strong electromagnetic signals harm human health.

- Equipment like radio transmitter or associated products must be handled with consideration of exposure to radio electromagnetic fields (electromagnetic radiation).
- Working with high-voltage equipment or facilities risks exposure to high-frequency electromagnetic fields.
- Radio service carriers and other users must comply with local laws and regulations when deploying wireless base station transceivers, or other equipment or facilities.
- Re-evaluate the risk of electromagnetic field exposure prior to equipment structure or antenna modification.
- Re-evaluate the risk of electromagnetic field exposure prior to modification of radio frequency (RF) output specifications or parameters.
- Re-evaluate the risk of electromagnetic field exposure prior to modification of the site environment where equipment or facilities are located.
- In order to avoid the possibility of exceeding the Europe radio frequency exposure limits, human proximity to the equipment shall not be less than 10.76 m
- This equipment complies with FCC/IC radiation exposure limits set forth for an uncontrolled environment. This equipment should be installed and operated with minimum distance 7.09m between the radiator and your body.

Restricted Areas

An area with excessive electromagnetic field exposure is considered hazardous and must be at a specified distance away from the equipment or facility as stipulated by related exposure control limits. This distance controls exposure to the electromagnetic field by personnel or the public. Maintain this distance with measures including but not limited to:

- Plan to situate the equipment or facility in an area inaccessible and undisclosed to the public.
- Allow only authorized and trained personnel to access the site.
- Before entering the restricted area, personnel should be aware that it is restricted and shut down the transmitter.
- Set clear signs at the site to remind personnel that the area is restricted.
- Conduct regular post-installation monitoring and checks.
- Set effective physical shields and warning signs in all areas with excessive electromagnetic field exposure.
- Install an isolating device around the equipment structure.
- Comply with local regulations during operation.

Installation and Usage of a Wireless Base Station Transceiver

A base transceiver station (BTS) is designed to emit less RF electromagnetic radiation than the maximum standard hazardous limit. A normal working BTS is therefore not harmful to the public and operating personnel. Defective antenna cables or other defects may however result in the emission of excessive RF electromagnetic radiation.

Personnel must abide by the following rules during BTS installation and operation:

- Read through all safety recommendations and comply with local regulations before proceeding.
- Before installing or maintaining an antenna close to the tower or mast with a BTS and its antenna, contact related personnel to switch off the antenna transmitter.
- Personnel at the site should carry a radiation monitoring and alarm instrument.

To shield the public from electromagnetic field exposure, abide by the following guiding principles during BTS antenna site installation:

- Install rooftop antennas out of reach of human activity.
- Install rooftop transmission antennas away from areas with high traffic, such as the rooftop access point, telephony service point, and HVAC equipment.
- Install rooftop directional antennas on the periphery and facing away from buildings.
- Choose the most suitable antenna size by balancing better signal coverage with less visual impact.
- Install antennas as far away as possible without compromising local area requirements.
- Exercise caution when constructing a common installation site for antennas from different manufacturers, especially high-power broadcasting (FM/TV) antennas. Installing antennas in one site increases safety risks.
- Take special preventive measures at antenna sites next to hospitals or schools.

Usage of Other Wireless Equipment

- Apply the safe distance from electromagnetic field exposure specified by any related equipment manual.
- Such distance is not specified for equipment with low RF transmit power that meets electromagnetic field exposure requirements.
- Such distance is not specified for specially-designed equipment that meets electromagnetic field exposure requirements for working in close proximity.

Usage of High-voltage Equipment or Facilities

- Since only high voltages (such as over 100 kV) generate harmful electromagnetic fields, the usage of such equipment or facilities must be evaluated according to requirements.

1.5.2 Laser Radiation



Warning

When handling optical fibers, do not stand close to or look into the optical fiber outlet directly without eye protection.



Caution

Use of controls or adjustment or performance of procedures other than those specified herein may result in hazardous radiation exposure.

- A laser transceiver is used in optical transmission system and related test tools. The laser transmitted through unterminated optical fibers or connectors has very high power density and is invisible to human eyes. A beam of light can cause damage to the retina.
- Looking into the end of an exposed optical fiber or broken optical fiber without eye protection from a distance of more than 150 mm (5.91 in.) will not cause eye injury. However, eyes may be damaged if an optical tool such as a microscope, magnifying glass, or eye loupe is used to view a bare optical fiber end.
- Observe the following precautions to avoid laser radiation hazards:
 - Only trained personnel are authorized to operate the laser.
 - Wear protective goggles during laser or optical fiber operation.
 - Disconnect the light source before disconnecting optical fiber connectors.
 - Use optical fiber caps to protect the disconnected optical fiber connectors.
 - Use an optical power meter to measure optical power and verify that the light source is disconnected.
 - Do not look into an exposed optical fiber or connector terminal until the light source is off. Immediately install dust-proof caps onto exposed optical fiber connectors.
 - Ensure that the optical fibers and light source are disconnected before fiber cutting or splicing.
 - Ensure that there is no laser radiation before opening the front door of the optical transmission system.
 - Do not view optical fiber terminals or connectors with a microscope, magnifying glass, or eye loupe.

1.6 Mechanical Safety

Hoisting Heavy Objects



Danger

Avoid walking areas under heavy objects being hoisted.

- Hoisting operators must be trained and qualified.
- Hoisting tools must be checked and complete.
- Before hoisting, fasten all tools to fixed load-bearing objects or walls.
- During hoisting, ensure that angles between lifting straps are under 90 °, as shown in Figure 1-2.

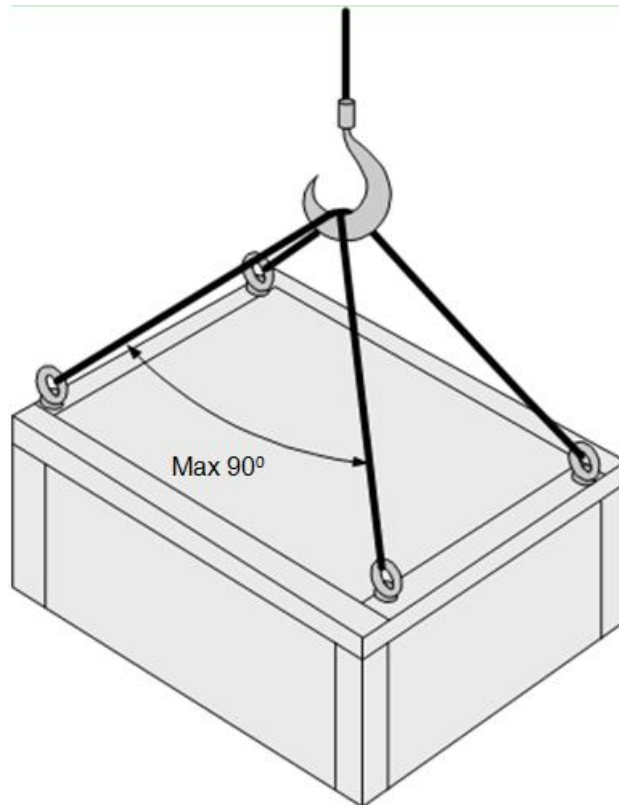
Figure 1-2 Hoisting heavy objects

Ladder Usage

- Before using a ladder,
 - Check that it is intact and confirm its load bearing capacity. Do not overload it.
 - A gradient of 75 ° is recommended between the ladder and the ground as measured with an angle square shown in Figure 1-3. Place the wider feet at the bottom or take protective measures to avoid skidding. Place the ladder on a stable surface.

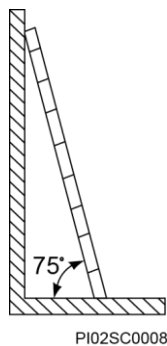
Figure 1-3 Ladder tilt angle

- When climbing a ladder:
 - Maintain your center of gravity within the ladder edges.

- Keep your body balanced when climbing.
- Do not climb higher than the fourth rung from the top.

To climb to a rooftop, ensure that the ladder has at least 1 m (3.28 ft.) extra height above the rooftop, as shown in Figure 1-4.

Figure 1-4 1 m (3.28 ft.) excess height of the ladder above the rooftop

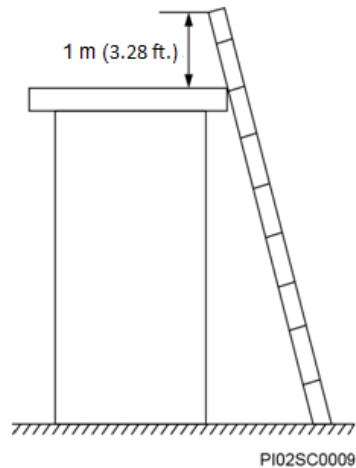

Drilling Holes

Pay attention to the following safety precautions when drilling holes on the wall or ground.



Caution

Do not drill unauthorized holes on cabinets. Incorrectly drilled holes will damage cabinet electromagnetic shielding and internal cables. Metal scraps generated in drilling may also short circuit the cabinet boards.

- Wear protective goggles and gloves when drilling.
- Cover equipment before drilling to prevent metal scraps from entering the equipment interior. Remove these scraps immediately after drilling.

Transporting Heavy Objects

- Adopt a load bearing posture before moving heavy objects to avoid sprains or other injuries. When transporting a cabinet, keep your back straight and avoid sudden movement.
- When transporting equipment by hand, wear gloves to protect against sharp edges.
- When moving or lifting a shelf, hold it by its handles or bottom edge instead of the handles of installed cabinet modules such as power modules, fan modules and boards.

1.7 Maintenance Safety

- Wear an ESD wrist strap when replacing accessories or parts. Ensure that one end is grounded and the other end properly contacts the skin.
- When replacing parts, account for all parts, bolts, and tools and prevent them from dropping into fans and causing damage to equipment.
- When replacing cabinet shelves or parts, exercise caution when pulling them out to prevent injury resulting from falling objects.

Fuse Replacement



Warning

- Replace fuses with the same type and rating.
 - Disconnect the equipment power supply before replacement to prevent electric shock and injury.
-
- Install replaceable fuses on the panel next to the AC/DC power input or output ports.
 - Refer to the specifications of backup or panel fuses to select the fuse type for replacement. Using fuses of different specifications may cause equipment damage, bodily injury, and financial loss.

Fuse Welding

- If the fuse rating is silkscreened on the board, Huawei authorized personnel will replace fuses with the specified rating.
- If the fuse rating is not silkscreened on the board, do not maintain board fuses on site. Return them to the depot for repair. Huawei authorized personnel replace fuses using the supplier model and rating in the bill of materials (BOM).

Power Distribution Box and Board Replacement

- Wear insulation gloves and ensure that the external-equipment circuit breaker is disconnected before proceeding.
- When replacing a board, do not touch its components to avoid damage.
- Install filler panels in all vacant slots.

Fan Replacement

Pull out a part of the fan module by its handles, wait until the fan completely stops rotating, and then remove the fan module from the subrack. Keep fingers away from fan blades.

Battery Replacement

For details, see section 1.4 "Battery Safety."

1.8 Safety Signs

Laser Class

Laser class sign: Class 1



Laser class sign: Class 1M



- These signs warn you not to approach optical fibers without eye protection or look directly into optical fiber connectors.
- For other precautions, see the laser part in 1.5.2 "Laser Radiation."

Equipment Weight



The replaceable/pluggable part or equipment is over 18 kg (40 lbs) and requires two people to transport it.



The replaceable/pluggable part or equipment is over 32 kg (70 lbs) and requires three people to transport it.



The part or equipment is over 55 kg (121 lbs) and requires a pallet truck or four people to transport it.

Dust Filter Maintenance



replace dust filters.

This sign reminds you to regularly clean and

Interlocking Kit Warning



keep it open with a secure metal rod to prevent accidental closing. Remove the rod to close the door.

After the door to outdoor equipment is opened,

This sign prompts you to lift the rod before closing the door.

High-voltage Cover Removal

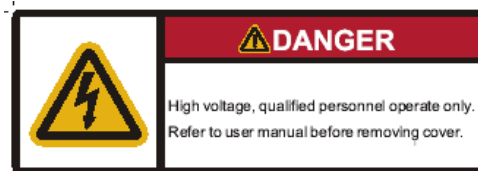

to understand all precautions before removing the cover.

This sign reminds you to read the safety manual