

**Airbridge RRU3606(DC Type) Remote RF Unit
V400R007C00**

User Guide

Issue 02
Date 2010-12-08

Copyright © Huawei Technologies Co., Ltd. 2010. All rights reserved.

No part of this document may be reproduced or transmitted in any form or by any means without prior written consent of Huawei Technologies Co., Ltd.

Trademarks and Permissions



HUAWEI and other Huawei trademarks are trademarks of Huawei Technologies Co., Ltd.

All other trademarks and trade names mentioned in this document are the property of their respective holders.

Notice

The purchased products, services and features are stipulated by the contract made between Huawei and the customer. All or part of the products, services and features described in this document may not be within the purchase scope or the usage scope. Unless otherwise specified in the contract, all statements, information, and recommendations in this document are provided "AS IS" without warranties, guarantees or representations of any kind, either express or implied.

The information in this document is subject to change without notice. Every effort has been made in the preparation of this document to ensure accuracy of the contents, but all statements, information, and recommendations in this document do not constitute the warranty of any kind, express or implied.

Huawei Technologies Co., Ltd.

Address: Huawei Industrial Base
Bantian, Longgang
Shenzhen 518129
People's Republic of China

Website: <http://www.huawei.com>

Email: support@huawei.com

About This Document

Overview

This document describes the hardware configuration and routine maintenance of the RRU3606.

Product Version

The following table lists the product version related to this document.

Product Name	Product Version
RRU3606	V400R007C00

Intended Audience

This document is intended for:

- Field engineers
- System engineers

Change History

Version	Change History
02 (2010-12-08)	This is the second commercial release.
01 (2010-07-12)	This is the first commercial release.
Draft (2010-03-05)	This is the initial draft of the V400R007C00.

Organization

1 Hardware of the RRU3606

This chapter describes the configuration of equipment and cables of the RRU3606.





2 Maintaining the RRU3606

This chapter describes how to maintain the RRU3606.

Conventions

Symbol Conventions

The symbols that may be found in this document are defined as follows.

Symbol	Description
 DANGER	Indicates a hazard with a high level of risk, which if not avoided, will result in death or serious injury.
 WARNING	Indicates a hazard with a medium or low level of risk, which if not avoided, could result in minor or moderate injury.
 CAUTION	Indicates a potentially hazardous situation, which if not avoided, could result in equipment damage, data loss, performance degradation, or unexpected results.
 TIP	Indicates a tip that may help you solve a problem or save time.
 NOTE	Provides additional information to emphasize or supplement important points of the main text.

General Conventions

The general conventions that may be found in this document are defined as follows.

Convention	Description
Times New Roman	Normal paragraphs are in Times New Roman.
Boldface	Names of files, directories, folders, and users are in boldface . For example, log in as user root .
<i>Italic</i>	Book titles are in <i>italics</i> .
Courier New	Examples of information displayed on the screen are in Courier New.

Command Conventions

The command conventions that may be found in this document are defined as follows.

Convention	Description
Boldface	The keywords of a command line are in boldface .
<i>Italic</i>	Command arguments are in <i>italics</i> .
[]	Items (keywords or arguments) in brackets [] are optional.
{ x y ... }	Optional items are grouped in braces and separated by vertical bars. One item is selected.
[x y ...]	Optional items are grouped in brackets and separated by vertical bars. One item is selected or no item is selected.
{ x y ... }*	Optional items are grouped in braces and separated by vertical bars. A minimum of one item or a maximum of all items can be selected.
[x y ...]*	Optional items are grouped in brackets and separated by vertical bars. Several items or no item can be selected.

GUI Conventions

The GUI conventions that may be found in this document are defined as follows.

Convention	Description
Boldface	Buttons, menus, parameters, tabs, window, and dialog titles are in boldface . For example, click OK .
>	Multi-level menus are in boldface and separated by the ">" signs. For example, choose File > Create > Folder .

Keyboard Operations

The keyboard operations that may be found in this document are defined as follows.

Format	Description
Key	Press the key. For example, press Enter and press Tab .
Key 1+Key 2	Press the keys concurrently. For example, pressing Ctrl+Alt+A means the three keys should be pressed concurrently.
Key 1, Key 2	Press the keys in turn. For example, pressing Alt, A means the two keys should be pressed in turn.

Mouse Operations

The mouse operations that may be found in this document are defined as follows.

Action	Description
Click	Select and release the primary mouse button without moving the pointer.
Double-click	Press the primary mouse button twice continuously and quickly without moving the pointer.
Drag	Press and hold the primary mouse button and move the pointer to a certain position.

Contents

About This Document.....	iii
1 Hardware of the RRU3606.....	1-1
1.1 Equipment of the RRU3606.....	1-2
1.1.1 Exterior of the RRU3606	1-2
1.1.2 RRU3606 Panels	1-3
1.1.3 Ports on the RRU3606	1-9
1.1.4 Technical Specifications of the RRU3606	1-10
1.2 Cables of the RRU3606.....	1-11
1.2.1 RRU3606 PGND Cable	1-12
1.2.2 Power Cable of the RRU3606.....	1-12
1.2.3 RRU3606 CPRI Cables	1-14
1.2.4 AISG Multi-Wire Cable of the RRU3606	1-16
1.2.5 AISG Extension Cable of the RRU3606.....	1-17
1.2.6 RF Jumper of the RRU3606.....	1-19
1.2.7 RRU3606 Alarm Cable	1-20
2 Maintaining the RRU3606.....	2-1
2.1 Items of Routine RRU3606 Maintenance.....	2-2
2.2 Powering On and Powering Off the RRU3606.....	2-2
2.2.1 Powering On the RRU3606	2-2
2.2.2 Powering Off the RRU3606.....	2-3
2.3 Replacing an RRU3606	2-3
2.4 Replacing the Cables of the RRU3606.....	2-7
2.4.1 Replacing a Power Cable of the RRU3606.....	2-8
2.4.2 Replacing the RRU3606 RF Jumper	2-9
2.4.3 Replacing the RRU3606 CPRI Cable.....	2-10
2.4.4 Replacing an AISG Multicore Cable of the RRU3606.....	2-11
2.4.5 Replacing an AISG Extension Cable of the RRU3606.....	2-12
2.4.6 Replacing the Alarm Cables of the RRU3606.....	2-13

Figures

Figure 1-1 RRU3606 (without the shell)	1-3
Figure 1-2 RRU3606 (with the shell)	1-3
Figure 1-3 Position of the RRU3606 panel (model 1)	1-4
Figure 1-4 Position of the RRU3606 panel (model 2).....	1-5
Figure 1-5 RRU3606 panels (model 1)	1-6
Figure 1-6 RRU3606 panels (model 2).....	1-7
Figure 1-7 Structure of the PGND cable.....	1-12
Figure 1-8 Structure of the -48 V DC power cable.....	1-13
Figure 1-9 Optical fiber	1-14
Figure 1-10 Structure of the SFP cable	1-14
Figure 1-11 AISG multi-wire cable	1-16
Figure 1-12 AISG extension cable.....	1-18
Figure 1-13 Antenna-Feeder jumper.....	1-19
Figure 1-14 RF Interconnect jumper of the RRU3606	1-20
Figure 1-15 RRU3606 alarm cable	1-20
Figure 2-1 Connections of the RRU3606 cables	2-4
Figure 2-2 Loosening the screws on the main pole fixture	2-5
Figure 2-3 Tightening the screws on the attachment plate	2-5
Figure 2-4 Knocking the RRU3606	2-6

Tables

Table 1-1 Indicators on the RRU3606 panels	1-7
Table 1-2 Ports on the RRU3606 panels	1-8
Table 1-3 Ports on the RRU3606 (DC type).....	1-9
Table 1-4 Technical specifications of the RRU3606 (DC type)	1-10
Table 1-5 Connections of the PGND cable.....	1-12
Table 1-6 Pin assignment for the two -48 V DC wires (North American standard).....	1-13
Table 1-7 Pin assignment for the two -48 V DC wires (European standard).....	1-13
Table 1-8 Installation positions of the power cable of the RRU3606.....	1-13
Table 1-9 Fiber description (The CPRI optical fiber connects the RRU3606 and BBU3900.).....	1-15
Table 1-10 Fiber description (The CPRI optical fiber connects the RRU3606s.).....	1-15
Table 1-11 Connections of the CPRI cable	1-15
Table 1-12 Pin assignment for the wires of the AISG multi-wire cable.....	1-16
Table 1-13 Connections of the AISG multi-wire cable	1-17
Table 1-14 Pin assignment for the wires of the AISG extension cable.....	1-18
Table 1-15 Installation positions of the AISG extension cable.....	1-19
Table 1-16 Installation positions of the antenna-feeder jumper.....	1-19
Table 1-17 Connections of the RF interconnect jumper of the RRU3606	1-20
Table 1-18 RRU3606 alarm cable.....	1-21
Table 1-19 Connections of the RRU3606 alarm cable	1-21
Table 2-1 Indicator Description.....	2-3
Table 2-2 Running and alarm indicators on the RRU3606	2-6
Table 2-3 RUN and ALM indicators of the RRU3606.....	2-9

1 Hardware of the RRU3606

About This Chapter

This chapter describes the configuration of equipment and cables of the RRU3606.

[1.1 Equipment of the RRU3606](#)

The RRU3606 transmits and receives radio signals to realize the communication between the wireless network and the MSs.

[1.2 Cables of the RRU3606](#)

This section describes the PGND cable, power cable, CPRI optical cable, and alarm cable of the RRU3606.

1.1 Equipment of the RRU3606

The RRU3606 transmits and receives radio signals to realize the communication between the wireless network and the MSs.

The functions of the RRU3606 are described as follows:

- The RRU3606 receives RF signals from the antenna system, down-converts the signals to IF signals, and then transmits them to the BBU3900 or the macro BTS after amplification, analog-to-digital conversion, digital down-conversion, and matched filtering.
- The RRU3606 receives downlink baseband signals from the BBU3900 or the macro BTS, forwards data from its cascaded RRU3606, performs filtering and data conversion, and up-converts RF signals to meet the transmitting frequency requirements.
- The RRU3606 multiplexes RX and TX signals over RF channels, enabling the RX signals and TX signals to share the same antenna path. In addition, the RRU3606 filters the RX signals and TX signals.

1.1.1 Exterior of the RRU3606

This section describes the dimensions and exterior of the RRU3606.

1.1.2 RRU3606 Panels

This section describes the position, ports, and indicators of the RRU3606 panels.

1.1.3 Ports on the RRU3606

The ports on the RRU3606 include power ports, transmission ports, alarm ports, ground ports, and RF ports.

1.1.4 Technical Specifications of the RRU3606

This section describes the technical specifications of the RRU3606, including the operating voltage, power consumption, equipment weight, dimensions, and ambient temperature and humidity for operation.

1.1.1 Exterior of the RRU3606

This section describes the dimensions and exterior of the RRU3606.

The RRU3606 has two sets of dimensions:

- Physical dimensions of the RRU3606 on 800 MHz AB and 450 MHz band classes
 - Height x width x depth (without the shell) = 480 mm (18.90 in.) x 270 mm (10.63 in.) x 170 mm (6.69 in.)
 - Height x width x depth (with a shell) = 485 mm (19.09 in.) x 285 mm (11.22 in.) x 170 mm (6.69 in.)
- Physical dimensions of the RRU3606 on other bands
 - Height x width x depth (without a shell) = 480 mm (18.90 in.) x 270 mm (10.63 in.) x 140 mm (5.51 in.)
 - Height x width x depth (with a shell) = 485 mm (19.09 in.) x 285 mm (11.22 in.) x 170 mm (6.69 in.)

The RRU3606 features a modular structure, and the external ports are located at the bottom and in the cabling cavity of the module, as shown in [Figure 1-1](#) and [Figure 1-2](#).

Figure 1-1 RRU3606 (without the shell)



Figure 1-2 RRU3606 (with the shell)



1.1.2 RRU3606 Panels

This section describes the position, ports, and indicators of the RRU3606 panels.

Positions of Panels

There are two models of RRU3606. [Figure 1-3](#) and [Figure 1-4](#) show the panel positions.

Figure 1-3 Position of the RRU3606 panel (model 1)

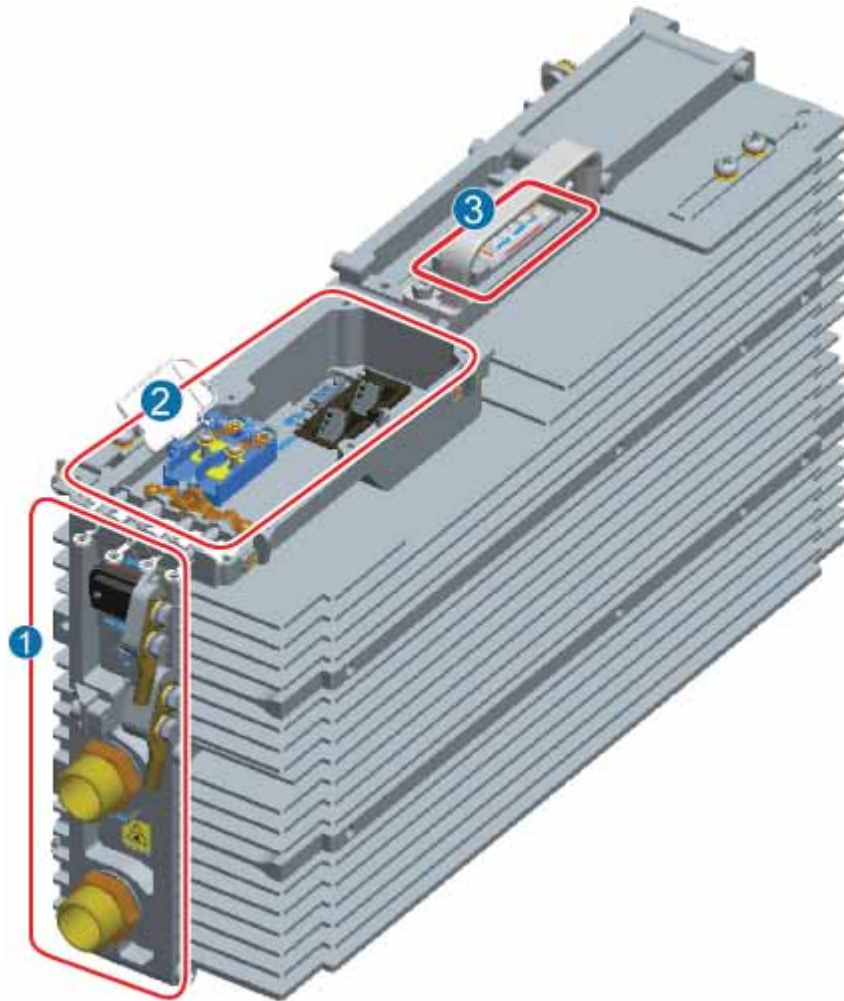

(1) Panel at the bottom

(2) Panel for the cable cavity

(3) Indicators

Figure 1-4 Position of the RRU3606 panel (model 2)

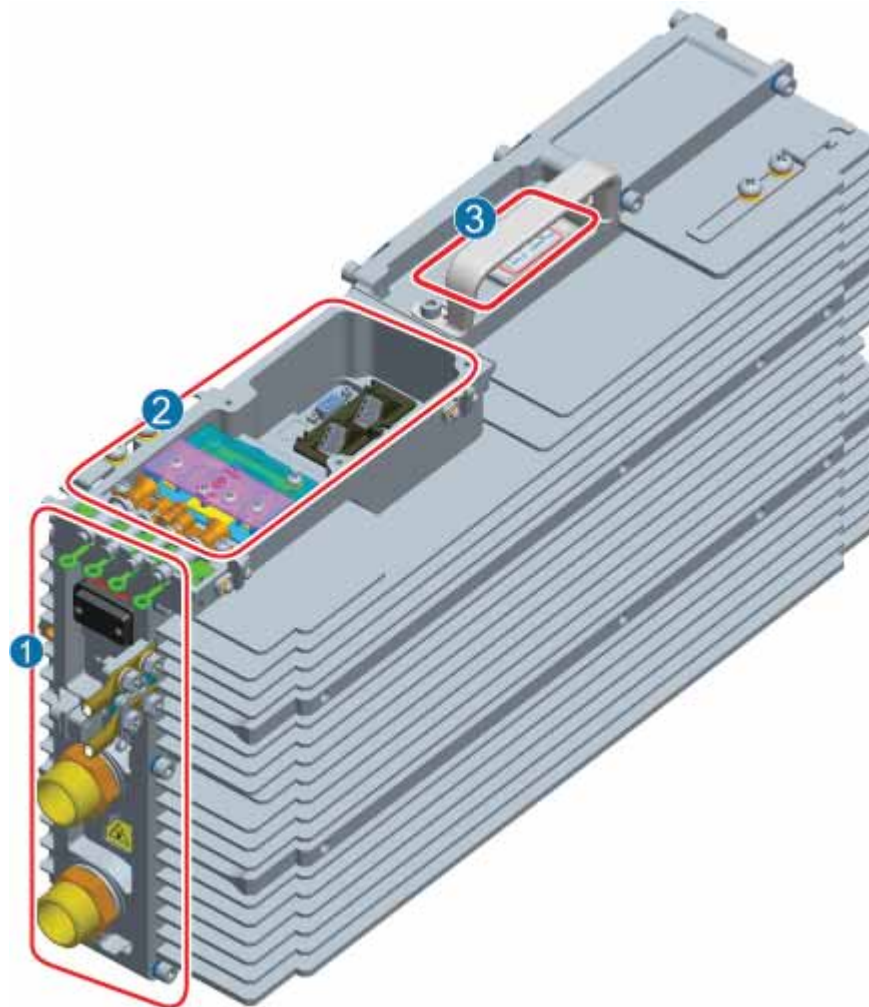

(1) Panel at the bottom

(2) Panel for the cable cavity

(3) Indicators

Figure 1-5 shows the RRU3606 panels of model 1, and **Figure 1-6** shows the RRU3606 panels of model 2.

Figure 1-5 RRU3606 panels (model 1)

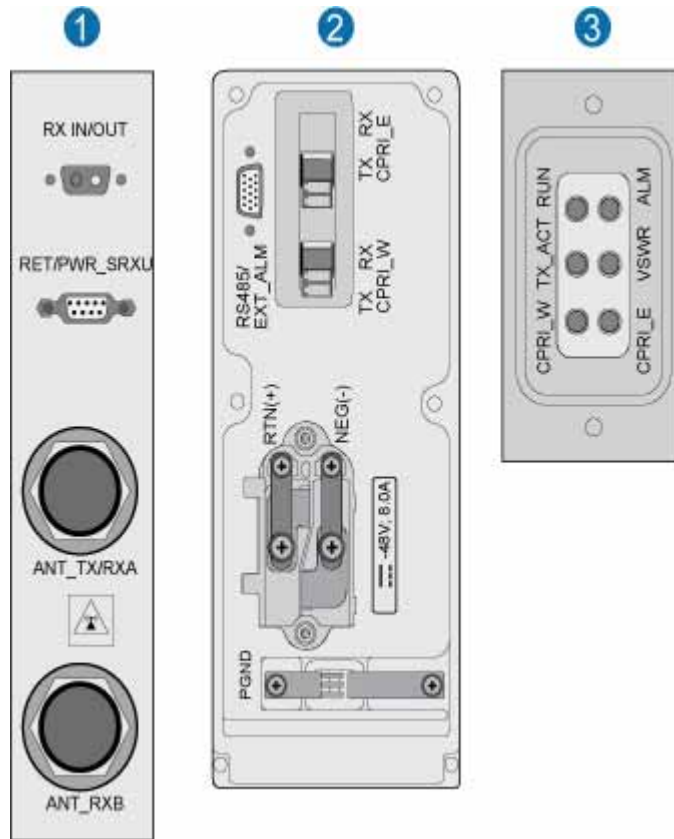
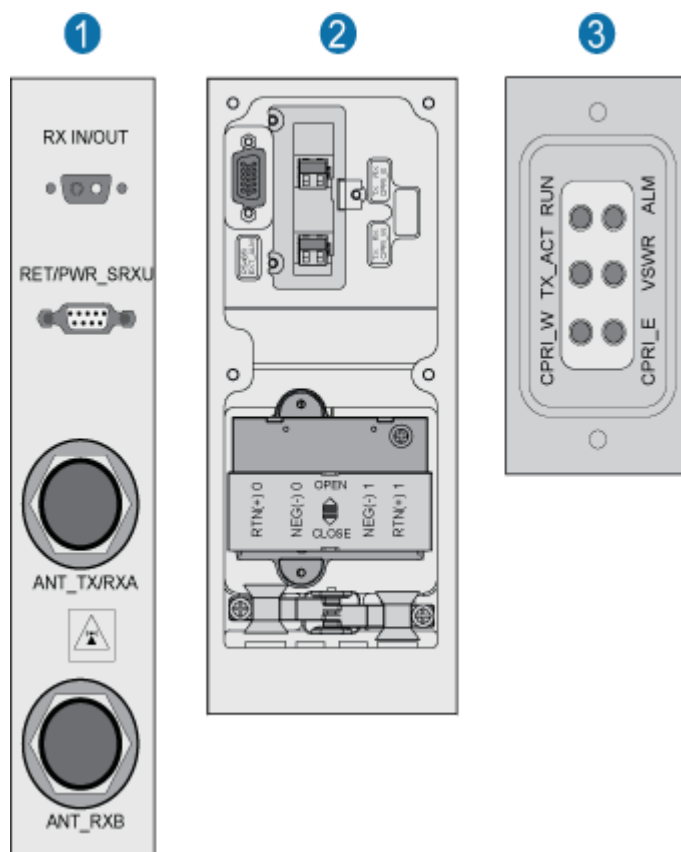

Figure 1-6 RRU3606 panels (model 2)



Indicators

Table 1-1 describes the indicators on the RRU3606 panels.

Table 1-1 Indicators on the RRU3606 panels

Indicator	Color	Status	Description
RUN	Green	Operating indicator	<ul style="list-style-type: none"> ● ON: There is power input and the module is faulty. ● OFF: There is no power input or the module is faulty. ● Blinking at 0.5 Hz: The module is operating properly. ● Blinking at 4 Hz: The module is being loaded or is not operating.

Indicator	Color	Status	Description
ALM	Red	Alarm indicator	<ul style="list-style-type: none"> ● ON: The module is in alarm status and needs to be replaced. ● Blinking at 0.5 Hz: Alarms are generated. ● OFF: No alarm is generated.
TX_ACT	Green	Operating indicator	<ul style="list-style-type: none"> ● ON: The module is operating properly and the transmit channel is active. ● Blinking at 0.5 Hz: The module is operating properly and the transmit channel is inactive.
VSWR	Red	VSWR alarm indicator	<ul style="list-style-type: none"> ● ON: A VSWR alarm is generated. ● OFF: No VSWR alarm is generated.
CPRI_W	Red/Green	Port indicator	<ul style="list-style-type: none"> ● ON (green): The CPRI link is functional. ● ON (red): An optical module receiving exception alarm is generated. ● Blinking at 0.5 Hz (red): The CPRI link is out of lock. ● OFF: The SFP module is not in position or is powered off.
CPRI_E	Red/Green	Port indicator	<ul style="list-style-type: none"> ● ON (green): The CPRI link is functional. ● ON (red): An optical module receiving exception alarm is generated. ● Blinking at 0.5 Hz (red): The CPRI link is out of lock. ● OFF: The SFP module is not in position or is powered off.

Ports on the panels

Table 1-2 describes the ports on the RRU3606 panels.

Table 1-2 Ports on the RRU3606 panels

Item	Port	Description
Panel at the bottom	RX_IN/OUT	Sharing main RX signals with other RRU3606s
	RET/PWR_SRXU	Communication port for the RET antenna

Item	Port	Description
	ANT_TX/RXA	Port for TX/main RX signals
	ANT_RXB	Port for diversity RX signals
Panel for the cabling cavity	RS485/EXT_ALM	Alarm port
	CPRI_E	Connecting the CPRI port on the lower-level RRU3606
	CPRI_W	Connecting the CPRI port on the BBU, the CPRI port on the upper-level RRU3606, or the CPRI1 port on the upper-level CRFU
	RTN (+) or RTN (+) 0	Power port
	NEG (-) or NEG (-) 0	
	PGND	Crimping piece of the ground cable

1.1.3 Ports on the RRU3606

The ports on the RRU3606 include power ports, transmission ports, alarm ports, ground ports, and RF ports.

Table 1-3 describes the ports on the RRU3606.

Table 1-3 Ports on the RRU3606 (DC type)

Port Type	Port	Description	Quantity	Connector
Power port	RTN (+) or RTN (+) 0	Port for -48 V DC power supply	1	Screw
	NEG (-) or NEG (-) 0			
Transmission port	CPRI_E	Connecting the lower-level CPRI port	1	SFP port
	CPRI_W	Connecting the BBU or the upper-level CPRI port	1	SFP port
Alarm port	RS485/EXT_ALM	Port for receiving one link of RS485 signals	1	DB15 connector
Ground port	-	Ground screw	4	Screw

Port Type	Port	Description	Quantity	Connector
RF port	ANT_TX/ RXA	Port for TX/main RX signals	1	Cylindrical waterproof DIN connector
	ANT_RXB	Port for diversity RX signals	1	Cylindrical waterproof DIN connector
	RX_IN/ OUT	Sharing main RX signals with other RRU3606s	1	2W2 connector
Communication port for the RET antenna	RET/ PWR_SRX U	Communication port for the RET antenna	1	DB9 connector

**NOTE**

Parameters of the RRU3606 alarm port: close-circuit impedance < 0.2 k ohm; open-circuit impedance > 51 k ohm

1.1.4 Technical Specifications of the RRU3606

This section describes the technical specifications of the RRU3606, including the operating voltage, power consumption, equipment weight, dimensions, and ambient temperature and humidity for operation.

Table 1-4 lists the technical specifications of the RRU3606.

Table 1-4 Technical specifications of the RRU3606 (DC type)

Item	Specification
Voltage	-48 V DC (-57 V DC to -36 V DC)
Power consumption	<p>≤ 295 W</p> <p>NOTE The power consumption is measured when the RRU3606 works at the 800 MHz band.</p> <p>≤ 272 W</p> <p>NOTE The power consumption is measured when the RRU3606 works at the AWS band.</p>
Weight	<ul style="list-style-type: none"> ● Weights of the RRU that works in the 800 MHz AB and 450 MHz band classes: ≤ 19 kg (41.90 lb) (module + shell) ● Weights of the RRU that works in other band classes: ≤ 17 kg (37.49 lb) (with the shell)

Item	Specification
Cabinet dimensions (height x width x depth)	Dimensions of the RRU that works in the 800 MHz AB and 450 MHz band classes: <ul style="list-style-type: none">● 485 mm (19.09 in.) x 285 mm (11.22 in.) x 170 mm (6.69 in.) (with the shell)● 480 mm (18.90 in.) x 270 mm (10.63 in.) x 140 mm (5.51 in.) (without the shell) Dimensions of the RRU that works in other band classes: <ul style="list-style-type: none">● 485 mm (19.09 in.) x 285 mm (11.22 in.) x 170 mm (6.69 in.) (with the shell)● 480 mm (18.90 in.) x 270 mm (10.63 in.) x 140 mm (5.51 in.) (without the shell)
Ambient temperature for operation	-40°C (-40°F) to +52°C (125.6°F) (solar radiation not considered)
Relative humidity for operation	5% RH to 100% RH

1.2 Cables of the RRU3606

This section describes the PGND cable, power cable, CPRI optical cable, and alarm cable of the RRU3606.

1.2.1 RRU3606 PGND Cable

The PGND cable ensures the grounding of the RRU3606.

1.2.2 Power Cable of the RRU3606

This section describes the power cable of the RRU3606. The -48 V DC power cable feeds external -48 V DC power to the RRU3606.

1.2.3 RRU3606 CPRI Cables

The CPRI cables connect the BBU3900 and RRU3606 and transmit the CPRI signals. The CPRI cables are categorized into two types: optical fiber and SFP cable. When the BBU3900 and RRU3606 are installed indoors, use SFP cables. In other cases, use optical fibers.

1.2.4 AISG Multi-Wire Cable of the RRU3606

The AISG multi-wire cable is used to connect the RRU3606 and the RCU. When direct connection is impossible, the AISG extension cable is used to extend the length. The AISG multi-wire cable is 5 m (196.85 in.). It is optional.

1.2.5 AISG Extension Cable of the RRU3606

When the distance between the RRU3606 and the RCU is longer than 5 m (16.40 ft), you need to connect an AISG extension cable to the AISG multicore cable to extend the length. An AISG extension cable is 15 m (49.21 ft) long.

1.2.6 RF Jumper of the RRU3606

The RRU3606 uses two types of RF jumpers: antenna-feeder jumper and interconnection jumper. The interconnection jumper is optional.

1.2.7 RRU3606 Alarm Cable

The RRU3606 alarm cable is used for leading one link of RS485 signals, thus monitoring the external device.

1.2.1 RRU3606 PGND Cable

The PGND cable ensures the grounding of the RRU3606.

Cable Exterior

The green-yellow(green) PGND cable is a single cable with a cross-sectional area of 16 mm^2 (0.02 in.^2) (6AWG). Both ends of the cable are double-hole OT terminals. If there is special requirements, single-hole OT terminal should be made on site. If the PGND cable is provided by the customer, a copper-wire cable with a minimum cross-sectional area of 16 mm^2 (0.02 in.^2) (6AWG) is recommended.

Figure 1-7 shows the PGND cable.

Figure 1-7 Structure of the PGND cable

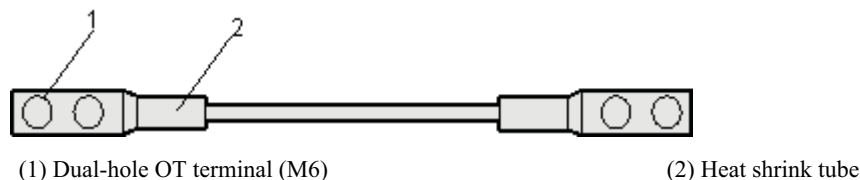

NOTE

- The OT terminals of the grounding cable are added on site.
- The color of the PGND cable is selected according to the local standards.

Installation Position

Table 1-5 lists the connections of the PGND cable.

Table 1-5 Connections of the PGND cable

One End of the Cable Is Connected to	The Other End of the Cable Is Connected to
Grounding bolt on the RRU3606	Local earth ground

1.2.2 Power Cable of the RRU3606

This section describes the power cable of the RRU3606. The -48 V DC power cable feeds external -48 V DC power to the RRU3606.

Cable Exterior

The power cable of the RRU3606 is a -48 V DC shielded cable. One end of this cable is two OT terminals, and the other end is bare wires. **Figure 1-8** shows the cable.

Figure 1-8 Structure of the -48 V DC power cable

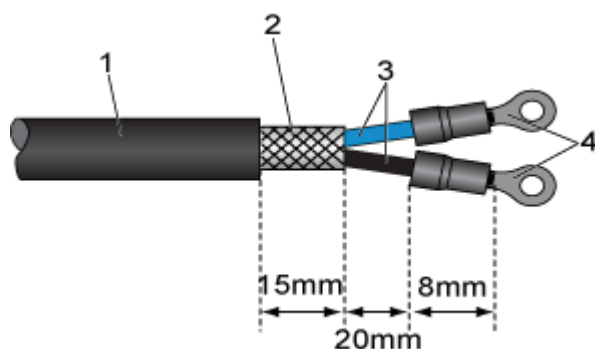

(1) -48 V DC power cable (2) Shielding layer (3) Wire (4) OT terminal

Cable Description

The -48 V DC power cable is a 2-wire cable. [Table 1-6](#) and [Table 1-7](#) list the details of the cable.

Table 1-6 Pin assignment for the two -48 V DC wires (North American standard)

Name	Color
NEG wire	Blue
RTN wire	Black

Table 1-7 Pin assignment for the two -48 V DC wires (European standard)

Name	Color
NEG wire	Blue
RTN wire	Brown

Installation Position

[Table 1-8](#) lists the installation positions of the power cable of the RRU3606.

Table 1-8 Installation positions of the power cable of the RRU3606

OT Terminals Connected to	Bare Wires Connected to
<ul style="list-style-type: none"> Blue: NEG(-) or NEG(-)0 port in the RRU3606 cabling cavity Black/brown: RTN(+) or RTN(+)0 port in the RRU3606 cabling cavity 	Power supply system

1.2.3 RRU3606 CPRI Cables

The CPRI cables connect the BBU3900 and RRU3606 and transmit the CPRI signals. The CPRI cables are categorized into two types: optical fiber and SFP cable. When the BBU3900 and RRU3606 are installed indoors, use SFP cables. In other cases, use optical fibers.

Optical Fiber

The CPRI optical fiber is categorized into two kinds: single-mode and multi-mode. **Figure 1-9** shows the exterior of the optical fiber.

Figure 1-9 Optical fiber

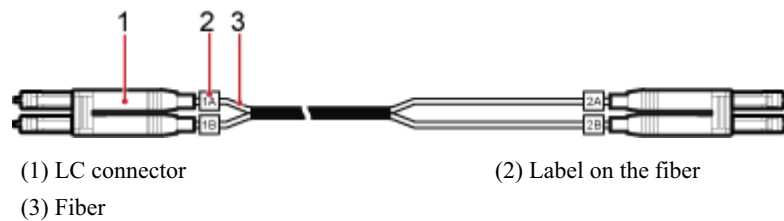

The CPRI optical fiber connects the BBU3900 and RRU3606. The fiber on the BBU3900 side is 0.35 m (13.78 in.). The fiber on the RRU3606 side is 0.05 m (1.97 in.). The CPRI optical fiber also connects different RRU3606s, and the length of the fiber at each end is 0.05 m (1.97 in.).

SFP Cable

In the scenario of indoors integrated installation, the SFP cable connects the BBU3900 and RRU3606.

Figure 1-10 shows the structure of the SFP cable.

Figure 1-10 Structure of the SFP cable

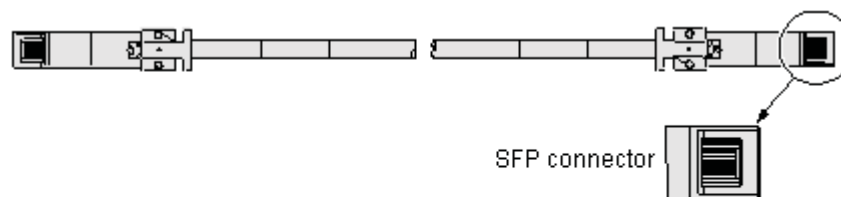

Cable Description

Table 1-9 and **Table 1-10** describes the mapping between the RRU3606 fibers.

Table 1-9 Fiber description (The CPRI optical fiber connects the RRU3606 and BBU3900.)

Label	Color	Connected to...
1A	Orange	CPRI_W RX port on the RRU3606
1B	Gray	CPRI_W TX port on the RRU3606
2A	Orange	TX port on the BBU3900
2B	Gray	RX port on the BBU3900

Table 1-10 Fiber description (The CPRI optical fiber connects the RRU3606s.)

Label	Color	Connected to...
1A	Orange	CPRI_W RX port on the RRU3606 1
1B	Gray	CPRI_W TX port on the RRU3606 1
2A	Orange	CPRI_E TX port on the RRU3606 0
2B	Gray	CPRI_E RX port on the RRU3606 0

Installation Position

Table 1-11 describes the connections of the CPRI cable.

Table 1-11 Connections of the CPRI cable

One End Is Connected to...		The Other End Is Connected to...
The BBU3900 is configured with the UBRI.	CPRI port on the UBRI in the BBU3900	CPRI_W port on the RRU3606
The BBU3900 is not configured with the UBRI.	SFP port on the HCPM/HECM in the BBU3900	CPRI_W port on the RRU3606
CPRI_E port on the RRU3606 or CPRI1 port on the CRFU		CPRI_W port on the lower-level RRU3606

NOTE

1. When the BBU3900 is configured with the UBRI, RRU3606s are connected to CPRI0 to CPRI2 ports on the UBRI, and a maximum of 18 RRU3606s can be connected to one BBU3900.
2. The CPRI_E port on the RRU3606 is used for connecting the lower-level RRU3606. The CPRI_W port is used for connecting the BBU3900, the upper-level RRU3606, or the upper-level CRFU.
3. Before connecting optical fibers to the ports, you need to connect removable optical modules to the previously mentioned ports.
4. Optical fibers and optical modules are both classified into single-mode and multi-mode. The single-mode optical fibers must be used with the single-mode optical modules, and the multi-mode optical fibers with the multi-mode optical modules. The single-mode and multi-mode optical cables and modules cannot be mixed up.

1.2.4 AISG Multi-Wire Cable of the RRU3606

The AISG multi-wire cable is used to connect the RRU3606 and the RCU. When direct connection is impossible, the AISG extension cable is used to extend the length. The AISG multi-wire cable is 5 m (196.85 in.). It is optional.

Cable Exterior

One end of the AISG multi-wire cable is terminated with the DB9 waterproof connector, and the other end is terminated with the standard AISG female connector. **Figure 1-11** shows the AISG multi-wire cable.

Figure 1-11 AISG multi-wire cable

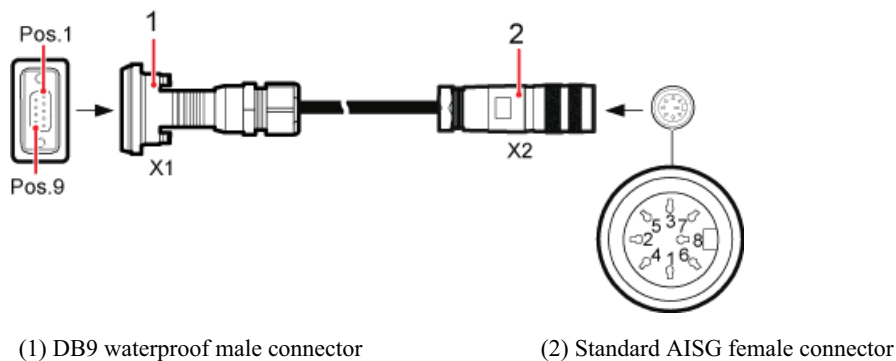

Cable Description

Table 1-12 lists the pin assignment for the AISG multi-wire cable.

Table 1-12 Pin assignment for the wires of the AISG multi-wire cable

Pins of the DB9 waterproof connector	Pins of the standard AISG female connector	Color	Wire Relation	Wire Description
X1.1	X2.1	White/Blue	Twisted pair cable	+12 V
		Blue		

Pins of the DB9 waterproof connector	Pins of the standard AISG female connector	Color	Wire Relation	Wire Description
X1.3	X2.3	White/Orange	Twisted pair cable	RS485 B
X1.5	X2.5	Orange		RS485 A
X1.4	X2.4	White/Green	-	RS485 GND
X1.9 and X1.4 are connected.	-	-	-	RS485 GND
-	X2.1 and X2.6 are connected.	-	-	+12V
-	X2.4 and X2.7 are connected.	-	-	RS485 GND

Installation Position

Table 1-13 lists the connections of the AISG multi-wire cable.

Table 1-13 Connections of the AISG multi-wire cable

DB9 Waterproof Connector Is Connected to...	Standard AISG Female Connector Is Connected to...
RET/PWR_SR XU port at the bottom of the RRU3606	RCU or standard AISG male connector of the AISG extension cable.

1.2.5 AISG Extension Cable of the RRU3606

When the distance between the RRU3606 and the RCU is longer than 5 m (16.40 ft), you need to connect an AISG extension cable to the AISG multicore cable to extend the length. An AISG extension cable is 15 m (49.21 ft) long.

Cable Exterior

One end of the AISG extension cable is a standard AISG male connector, and the other end is a standard AISG female connector, as shown in **Figure 1-12**.

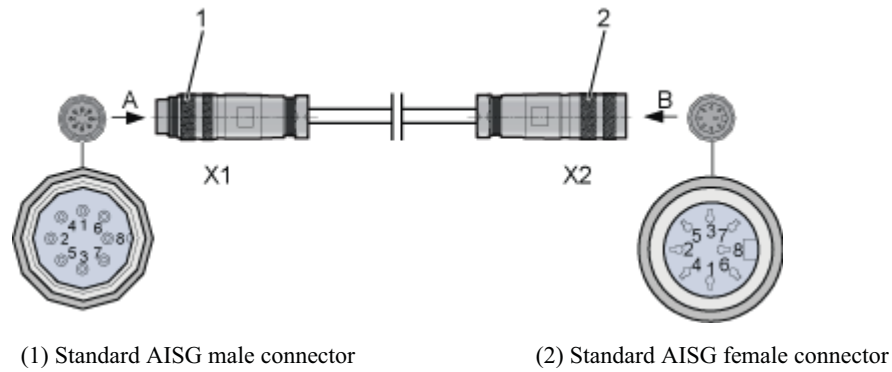
Figure 1-12 AISG extension cable

Cable Description

Table 1-14 lists the pin assignment for the wires of the AISG extension cable.

Table 1-14 Pin assignment for the wires of the AISG extension cable

Pins of the Standard AISG Male Connector	Pins of the Standard AISG Female Connector	Color	Wire Relation	Cores
X1.1	X2.1	White/Blue	Twisted pair cable	+12 V
		Blue		
X1.7	X2.7	White/Orange	Twisted pair cable	DC Return A
		Orange		
X1.3	X2.3	White/Green	Twisted pair cable	RS485 B
X1.5	X2.5	Green		RS485 A
X1.6	X2.6	White/Brown	Twisted pair cable	+24 V
		Brown		

Installation Position

Table 1-15 lists the installation positions of the AISG extension cable.

Table 1-15 Installation positions of the AISG extension cable

One End (Standard AISG Male Connector) of the Cable Is Connected to	The Other End (Standard AISG Female Connector) of the Cable Is Connected to
Standard AISG female connector of the AISG multicore cable	Standard AISG male connector
Standard AISG female connector on the SBT	Standard AISG male connector

1.2.6 RF Jumper of the RRU3606

The RRU3606 uses two types of RF jumpers: antenna-feeder jumper and interconnection jumper. The interconnection jumper is optional.

Antenna-Feeder Jumper of the RRU3606

The antenna-feeder jumper is used to carry RF signals.

Cable Exterior

Both ends of the antenna-feeder jumper have DIN male connectors, as shown in [Figure 1-13](#).

Figure 1-13 Antenna-Feeder jumper

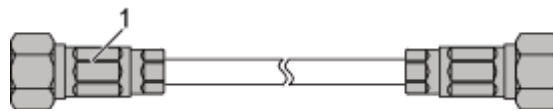

(1) DIN connector

Installation Position

[Table 1-16](#) lists the connections of the antenna-feeder jumper of the RRU3606.

Table 1-16 Installation positions of the antenna-feeder jumper

One End (DIN Male Connector) of the Cable Is Connected to	The Other End (DIN Male Connector) of the Cable Is Connected to
ANT_TX/RXA or ANT_RXB port at the bottom of the RRU3606	Feeder or antenna

RF Interconnect Jumper of the RRU3606

The interconnect jumper carries RF signals between two RRU3606s. The interconnect jumper is used when the two RRU3606s work in main/diversity mode.

Cable Exterior

The RF interconnect jumper of the RRU3606 is 2 m (6.56 ft). Both ends of the interconnect jumper are 2W2 connectors.

Figure 1-14 shows the RF interconnect jumper of the RRU3606.

Figure 1-14 RF Interconnect jumper of the RRU3606

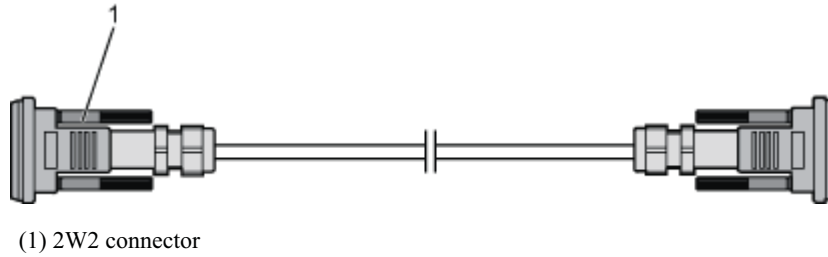

Installation Position

Table 1-17 lists the connections of the RF interconnect jumper of the RRU3606.

Table 1-17 Connections of the RF interconnect jumper of the RRU3606

One End of the 2W2 Connector Is Connected to...	The Other End of the 2W2 Connector Is Connected to...
RX_IN/OUT port at the bottom of the RRU3606	RX_IN/OUT port at the bottom of the RRU3606

1.2.7 RRU3606 Alarm Cable

The RRU3606 alarm cable is used for leading one link of RS485 signals, thus monitoring the external device.

Cable Exterior

One end of the RRU3606 alarm cable has a DB15 male connector, and the other end has eight cord end terminals, as shown in **Figure 1-15**.

Figure 1-15 RRU3606 alarm cable



 **NOTE**

If the connector of the RRU3606 alarm cable does not match the connector of the alarm device, you can cut off the cord end terminal, and make a connector that matches the alarm device.

Cable Description

The RRU3606 alarm cable supports one link of the RS485 signals. [Table 1-18](#) lists the pin assignment for the wires of the cable.

Table 1-18 RRU3606 alarm cable

Pin of the DB15 Connector	Signal of the DB15 connector	Wire Color	Wire Type	Cord End Terminal	Cable Label
X1.2	SWITCH_I NPUT0+	White/Blue	Twisted pair cable	X2	SWITCH_I NPUT0+
X1.3	GND	Blue		X3	GND
X1.6	SWITCH_I NPUT1+	White/Orange	Twisted pair cable	X4	SWITCH_I NPUT1+
X1.7	GND	Orange		X5	GND
X1.10	RS485_TX-	White/Green	Twisted pair cable	X6	APM_RX-
X1.11	RS485_TX+	Green		X7	APM_RX+
X1.13	RS485_RX-	White/Brown	Twisted pair cable	X8	APM_TX-
X1.14	RS485_RX+	Brown		X9	APM_TX+

Installation Position

[Table 1-19](#) describes the connections of the RRU3606 alarm cable.

Table 1-19 Connections of the RRU3606 alarm cable

One End with DB15 Male Connector Is Connected to...	The Other End with Eight Cord End Terminal Is Connected to...
RS485/EXT_ALM port on the RRU3606 cabling cavity	Boolean signal port on the external equipment

2 Maintaining the RRU3606

About This Chapter

This chapter describes how to maintain the RRU3606.

[2.1 Items of Routine RRU3606 Maintenance](#)

The routine RRU3606 maintenance involves checking the equipment exterior, equipment cleanliness, and indicators.

[2.2 Powering On and Powering Off the RRU3606](#)

This section describes how to power on and power off the RRU3606.

[2.3 Replacing an RRU3606](#)

This section describes how to replace a faulty RRU3606.

[2.4 Replacing the Cables of the RRU3606](#)

This section describes how to replace the cables of the RRU3606. The power cable, RF cable, optical fiber, and alarm cable of the RRU3606 can be replaced on site.

2.1 Items of Routine RRU3606 Maintenance

The routine RRU3606 maintenance involves checking the equipment exterior, equipment cleanliness, and indicators.

After the equipment starts regular operation, you must perform routine maintenance for the equipment regularly (such as monthly or quarterly). The items of routine maintenance are as follows:

- Check whether the equipment exterior has any trace of damage such as indent, crack, hole, and corrosion and check whether the labels are clear.
- Check whether the equipment exterior is clean and ensure that not much dust accumulates inside the cabinet.
- Observe the indicators on the equipment to check whether the equipment runs normally.

2.2 Powering On and Powering Off the RRU3606

This section describes how to power on and power off the RRU3606.

2.2.1 Powering On the RRU3606

This section describes the process of powering on the RRU3606.

2.2.2 Powering Off the RRU3606

This section describes how to power off the RRU3606.

2.2.1 Powering On the RRU3606

This section describes the process of powering on the RRU3606.

Prerequisites

Check the following items before powering on the RRU3606:

- The pole fixture is securely installed. The backplane is fixed tightly without twisting.
- The power cable, ground cable, optical cable, alarm cable, and RF feeder are intact.
- The power cable and ground cable are correctly connected.
- The optical cable, alarm cable, and RF feeder are correctly and tightly connected.
- When the RRU3606 uses -48 V DC power input, ensure that the voltage range of the external power input is within -57 V DC to -36 V DC.

Background Information

The RRU3606 must be powered on within 24 hours after the RRU3606 is unpacked. The power-off time of the RRU3606 must be less than 24 hours.

Procedure

- Step 1** Set the switch of the external power that provides power for the RRU3606 to ON.



DANGER

After the RRU3606 is powered on, do not look straight at the optical module.

Step 2 Check the indicators on the RRU3606. **Table 2-1** describes the meaning of the indicators.

Table 2-1 Indicator Description

Indicator	Color	Status	Description
RUN	Green	ON	There is power input but the RRU3606 is faulty.
		OFF	There is no power input or the RRU3606 is faulty.
		Blinking at 0.5 Hz	The module is working normally.
		Blinking at 1 Hz	The RRU3606 software is being loaded or the RRU3606 is not configured.
ALM	Red	ON	A critical alarm is generated.
		Blinking at 0.5 Hz	A minor alarm is generated.
		OFF	There is no alarm.

---End

2.2.2 Powering Off the RRU3606

This section describes how to power off the RRU3606.

Background

You need to power off the RRU3606 on special occasions, for example, when the equipment is to be transferred to another site, the RRU3606 and cables need to be replaced, or the equipment is subject to damage resulting from fires, smoke, and water.

Procedure

Step 1 Switch off the external power supply equipment of the RRU3606.

---End

2.3 Replacing an RRU3606

This section describes how to replace a faulty RRU3606.

Prerequisites

- Confirm the quantity of RRU3606s that need to be replaced and prepare for new RRU3606s.
- Record the installation position of the RRU3606.
- Record the positions of the screws used to fix the RRU3606.
- Record the positions of the ports of all the cables connected to the RRU3606. **Figure 2-1** shows all the cables connected to the RRU3606.

Figure 2-1 Connections of the RRU3606 cables

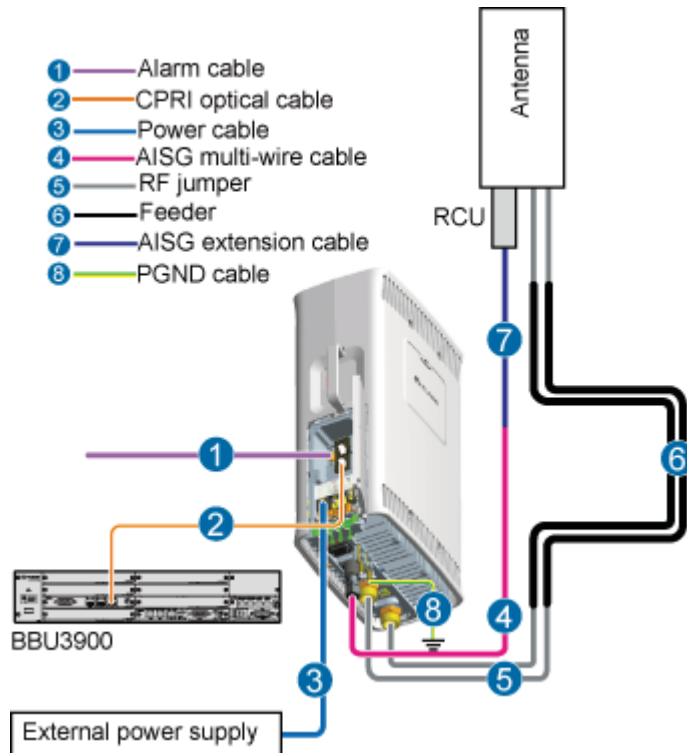

- Prepare for a cable cutter, a cable strap, an ESD wrist strap or ESD gloves, a Phillips screwdriver, a flat-head screwdriver, and a wrench.

Procedure

Step 1 Record the information of the carriers.

Run the **DSP CBTSSSECTORCARRIERINFO** command to query the cell IDs, sector IDs, and carrier IDs.

Step 2 Block the carriers.

1. Run the **BLK RES** command to block all the carriers of the RRU3606. It is recommended that you set the value of the **priority** to *low*.
2. Run the **DSP RES** command to query whether the carriers are blocked. If so, go to the next step.

Step 3 Power off the RRU3606.

Step 4 Remove the RRU3606 to be replaced.

- Take appropriate insulating measures and remove all cables connected to the RRU3606.

- Loosen the captive screws on the two spring plates on the main pole fixture, as shown in **Figure 2-2**.

Figure 2-2 Loosening the screws on the main pole fixture

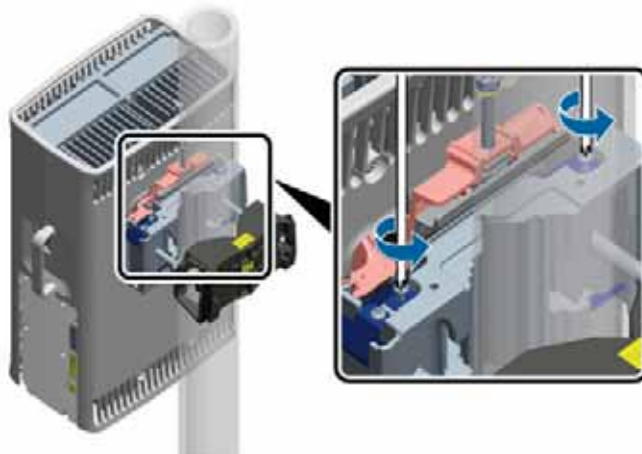

- Tighten the two screws on the RRU3606 attachment plate, as shown in **Figure 2-3**. Loosen the transitional piece and installation piece together with the help of the jacking screws. Then, lift up the RRU3606 to remove it.

Figure 2-3 Tightening the screws on the attachment plate

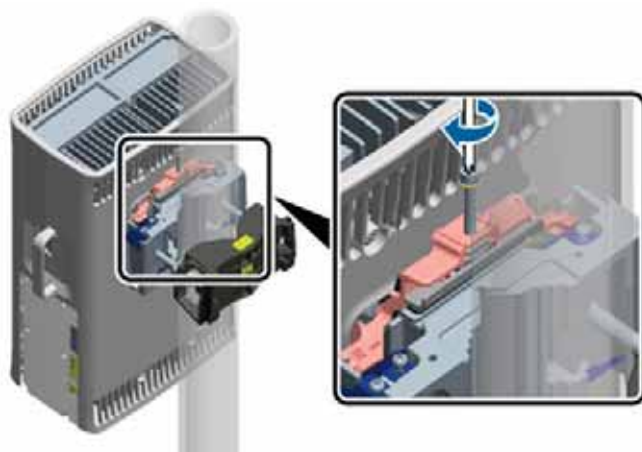

CAUTION

Do not loosen the jacking screws forcibly. Use a rubber mallet to knock the bottom of the RRU3606 to loosen the transitional piece and installation piece, as shown in **Figure 2-4**.

Figure 2-4 Knocking the RRU3606

Step 5 Install the new RRU3606.

Step 6 Connect the cables to the RRU3606.

Step 7 Load the software.

If the automatic loading is enabled to the RRU3606, the RRU3606 software is automatically loaded from the BAM after the RRU3606 is powered on. If the automatic loading is disabled, run the **DLD CBTSSW** command to load the RRU3606 software.

Step 8 Unblock the carriers.

Run the **UBL RES** command to unblock the carriers.

Step 9 Ensure that the RRU3606 works normally.

Observe the running/alarm indicators on the RRU3606 to ensure the normal running. [Table 2-2](#) lists the running/alarm indicators on the RRU3606.

Table 2-2 Running and alarm indicators on the RRU3606

Indicator	Color	Status	Description
RUN	Green	ON	There is power input, but the board is faulty.
		OFF	There is no power input, or an alarm is generated.
		Blinking at 0.5 Hz	The board is working normally.

Indicator	Color	Status	Description
		Blinking at 1 Hz	The board software is being loaded.
ALM	Red	ON	A critical alarm is generated.
		Blinking at 0.5 Hz	A minor alarm is generated.
		OFF	There is no alarm.

----End

Follow-up Procedure

After the RRU3606 is replaced, check the following items:

- The RRU3606 is correctly installed.
- All cables of the RRU3606 are connected to the correct ports.
- Each screw on the RRU3606 is installed in the correct position, and all screws are tightened.
- The RRU3606 works normally after the RRU is powered on.

If any fault is present during operation, contact the local Huawei office for assistance.

2.4 Replacing the Cables of the RRU3606

This section describes how to replace the cables of the RRU3606. The power cable, RF cable, optical fiber, and alarm cable of the RRU3606 can be replaced on site.

2.4.1 Replacing a Power Cable of the RRU3606

This section describes how to replace a power cable of the RRU3606.

2.4.2 Replacing the RRU3606 RF Jumper

The RRU3606 RF jumper is classified into two types: feeder jumper and interconnect jumper. According to the actual conditions, the feeder jumper can be connected to the feeder or antenna. The interconnect jumper is used for connecting two RRU3606s and RX_IN/OUT port to implement the interconnection of the RF signals. Before replacing the RF jumper, power off the RRU3606. The RRU3606 stops working and leads to a service interruption in the lower-level RRU3606 in cascaded. When replacing the interconnect jumper, do not power off the RRU3606 and the service is not interrupted.

2.4.3 Replacing the RRU3606 CPRI Cable

This section describes how to replace a faulty CPRI Cable of the RRU3606.

2.4.4 Replacing an AISG Multicore Cable of the RRU3606

The AISG multicore cable is used to connect the RRU3606 and the RCU or the AISG extension cable to carry control signals from the BTS to the RET antenna. When the AISG multicore cable is replaced, the services are not affected.

2.4.5 Replacing an AISG Extension Cable of the RRU3606

The AISG extension is used when the AISG is not long enough to connect the RRU3606 and the RCU. When the AISG extension cable is replaced, the services are not affected.

2.4.6 Replacing the Alarm Cables of the RRU3606

This section describes how to replace faulty alarm cables of the RRU3606.

2.4.1 Replacing a Power Cable of the RRU3606

This section describes how to replace a power cable of the RRU3606.

Prerequisite

- Get ready a new power cable.
- Record the installation position of the power cable.
- Get ready wire nippers, bundling tape, an ESD wrist strap or a pair of ESD gloves, a Phillips screwdriver, a flathead screwdriver, and a wrench.

Procedure

- Step 1** Route the new power cable along the original path.
- Step 2** Run the **DSP CBTSECTORCARRIERINFO** command to query the cell IDs, sector IDs, and carrier IDs.
- Step 3** Block the carriers.
1. Run the **BLK RES** command to block all carriers related to the cable to be replaced. It is recommended that you set the value of the priority parameter to "low".
 2. Run the **DSP RES** command to query whether the carriers are blocked. If so, go to the next step.
- Step 4** Remove the faulty power cable.
1. Switch off the external power supply equipment of the RRU3606.
 2. Open the cover of the cabling cavity and the cover above the power cable input terminal.
 3. Loosen the screw on the cable clip (marked PGND) of the power cable.
 4. In the cabling cavity, remove the OT terminal of the faulty power cable, and then remove the faulty power cable.
- Step 5** Install the new power cable.
- Install the OT terminal of the new power cable.
 - Use the cable clip to fix the exposed part of the shielding layer, and then tighten the screw.
 - Close the cover above the power cable input terminal and the cover of the cabling cavity.
- Step 6** Switch on the external power supply equipment of the RRU3606.
- Step 7** Block the carriers.
- Run the **UBL RES** command to unblock all carriers related to the power cable.
- Step 8** Ensure that the RRU3606 work properly.
- Observe the RUN and ALM indicators of the RRU3606. [Table 2-3](#) lists the RUN and ALM indicators of the RRU3606.

Table 2-3 RUN and ALM indicators of the RRU3606

Identification	Color	Status	Description
RUN	Green	ON	There is power input, but the board is faulty.
		OFF	There is no power input, or the board is faulty.
		Blinking at 0.5 Hz	The board is working properly.
		Blinking at 1 Hz	The board software is being loaded.
ALM	Red	ON	Critical alarm
		Blinking at 0.5 Hz	Minor alarm
		OFF	No alarm

---End

Follow-up Procedure

Dispose of the faulty power cable properly, and then clean the site.

2.4.2 Replacing the RRU3606 RF Jumper

The RRU3606 RF jumper is classified into two types: feeder jumper and interconnect jumper. According to the actual conditions, the feeder jumper can be connected to the feeder or antenna. The interconnect jumper is used for connecting two RRU3606s and RX_IN/OUT port to implement the interconnection of the RF signals. Before replacing the RF jumper, power off the RRU3606. The RRU3606 stops working and leads to a service interruption in the lower-level RRU3606 in cascaded. When replacing the interconnect jumper, do not power off the RRU3606 and the service is not interrupted.

Prerequisite

- Confirm the type and quantity of the faulty cables and prepare for new cables.
- Ensure that the new cables are intact. Do not use the cables with damage.
- Record the installation positions and connections of the faulty cables.
- Prepare for the tools: wrench, handsaw, wire clippers (match with the feeder), ESD wrist wrap/ESD gloves, screwdriver, PVC insulation tape, and waterproof tape.

Context

- Replacing the feeder jumper
 1. Run the **DSP CBTSSECTORCARRIERINFO** command to query and record the cell ID, sector ID, and carrier ID of the BTS.
 2. Block the carriers.

- (1) Run the **BLK RES** command to block all the carriers of the sector where the faulty cable is located. Set the **priority** to *low*.
- (2) Run the **DSP RES** command to query whether the carriers are blocked. If so, go to the next step.
3. Remove the faulty RF jumper.
 - (1) Power off the RRU3606.
 - (2) Remove the RF jumper from the RF jumper port on the RRU3606.
 - (3) Remove the RF jumper from the feeder/antenna port.
4. Install a new RF jumper.
 - (1) Connect the DIN connector of the new jumper to the RF ANT_TX/RXA and ANT_RXB ports on the RRU3606.
 - (2) Connect the RF jumper to the feeder/antenna.
 - (3) Wrap the port joints at the two ends of the RF jumper with waterproof tapes.

 **NOTE**

- When winding the tape, ensure that the joints are wrapped with three layers of continuous tape, and that each layer of tape covers more than 50% of the previous layer.
 - When winding the waterproof tape, stretch each layer of the waterproof tape and wrap each layer around the jumpers tightly.
- (4) Wrap the PVC insulation tapes on the waterproof tapes according to the previous steps.
 - (5) Power on the RRU3606.
5. Unblock the carriers.
Run the **UBL RES** command to unblock all the sector carriers related to the RF jumper.
 6. Ensure that the new RF jumper is functional.
Perform the service verification and a calibration test on the carriers of the new RF jumper. If the results are normal and no alarm is generated, the replacement is successful. If the replacement fails, locate the faults.
- Replacing the interconnect jumper
 1. Loosen the screws with a screwdriver, and then remove the 2W2 connector of the interconnect jumper from the RX_IN/OUT ports on two RRU3606s.
 2. Connect the 2W2 connector of the new interconnect jumper to the RX_IN/OUT ports on two RRU3606s, and then tighten the screws on the connector with a screwdriver.

Follow-up Procedure

Store the faulty cable properly, and then clean the site.

2.4.3 Replacing the RRU3606 CPRI Cable

This section describes how to replace a faulty CPRI Cable of the RRU3606.

Prerequisite

- The quantity and models of the faulty cables are confirmed, and the new cables and labels are ready.

- Required tools: ESD wrist strap and ESD gloves, Phillips screwdriver, and ESD box/bag.



CAUTION

- When the cable connected to the CPRI port is removed, all services carried by the cable are disrupted.
-

Procedure

Step 1 Run the **DSP CBTSSSECTORCARRIERINFO** command to query the cell IDs, sector IDs, and carrier IDs of the RRU3606 connected by the cable to be replaced.

Step 2 Block the carriers.

1. Run the **BLK RES** command to block all carriers of the RRU3606 connected through the cable. The recommended priority level is "Low".
2. Run the **DSP RES** command to check whether the status of all carriers of the RRU3606 connected through the cable is "Blocked". If so, go to next step.

Step 3 Remove the faulty cables.

1. Wear ESD gloves.
2. Route the new cables to the peer equipment along the original path.

Step 4 Install new cables.

1. According to the labels on the new cables, insert the new cables into the ports.
2. Bind the cables.

Step 5 Unblock the carriers.

Run the **UBL RES** command to unblock all carriers of the RRU3606 connected through the cables.

Step 6 Check that the new optical cable works properly.

Observe the indicators of ports and ensure that the new cable works properly.

---End

Follow-up Procedure

Dispose of the faulty cable properly and clean the site.

2.4.4 Replacing an AISG Multicore Cable of the RRU3606

The AISG multicore cable is used to connect the RRU3606 and the RCU or the AISG extension cable to carry control signals from the BTS to the RET antenna. When the AISG multicore cable is replaced, the services are not affected.

Prerequisite

- The quantity and models of the faulty cables are confirmed, and the new cables are ready.
- The new optical cables are intact. Damaged cables cannot be used.

- Record the installation positions and correspondence of the faulty cables.
- The required tools and materials are ready. The tools and materials are the ESD wrist strap or ESD gloves, and ESD box or bag.

Procedure

- Step 1** Remove the faulty AISG multicore cable from the RRU3606.
- Step 2** Connect the DB9 waterproof connector of the AISG multicore cable to the RRU3606.
- Step 3** Route the new AISG multicore cable along the original path to the RCU or the standard AISG male connector of the AISG extension cable.
- Step 4** Remove the faulty AISG multicore cable from the RCU or the AISG extension cable.
- Step 5** Connect the new AISG multicore cable to the RCU or the standard AISG male connector of the AISG extension cable.

----End

Follow-up Procedure

Dispose of the faulty power cable properly, and then clean up the site.

2.4.5 Replacing an AISG Extension Cable of the RRU3606

The AISG extension is used when the AISG is not long enough to connect the RRU3606 and the RCU. When the AISG extension cable is replaced, the services are not affected.

Prerequisite

- The quantity and models of the faulty cables are confirmed, and the new cables are ready.
- The new optical cables are intact. Damaged cables cannot be used.
- Record the installation positions and correspondence of the faulty cables.
- The required tools and materials are ready. The tools and materials are the ESD wrist strap or ESD gloves, and ESD box or bag.

Procedure

- Step 1** Remove the faulty AISG extension cable from the AISG multicore cable.
- Step 2** Connect the standard AISG male connector of the new AISG extension cable to the standard AISG female connector of the AISG multicore cable.
- Step 3** Route the new AISG extension cable along the original path.
- Step 4** Remove the faulty AISG extension cable from the RCU.
- Step 5** Connect the standard AISG female connector of the new AISG extension cable to the standard AISG male connector of the RCU.

----End

Follow-up Procedure

Dispose of the faulty power cable properly, and then clean the site.

2.4.6 Replacing the Alarm Cables of the RRU3606

This section describes how to replace faulty alarm cables of the RRU3606.

Prerequisite

- Get ready new alarm cables.
- Record the installation positions of the alarm cables.
- Get ready wire nippers, an ESD wrist strap or a pair of ESD gloves, a Phillips screwdriver, a flathead screwdriver, a wrench, and bundling tape.

Procedure

Step 1 Remove the faulty alarm cables.

1. Route the new alarm cables as the faulty alarm cables are routed.
2. Open the cover of the cabling cavity.
3. Remove the alarm cable connectors connected to the RS485 and EXT_ALM ports in the cabling cavity, and then remove the faulty alarm cables.

Step 2 Route the new alarm cables along the cable trough in the cabling cavity, and then connect the alarm cables to the RS485 and EXT_ALM ports.

Step 3 Take waterproofing and sealing measures.

----End

Follow-up Procedure

Dispose of the faulty power cable properly, and then clean the site.