

Wonderful Communication, Mobile Life.

User Guide

Notice



Copyright © Huawei Technologies Co., Ltd. 2010. All rights reserved.

No part of this document may be reproduced or transmitted in any form or by any means without prior written consent of Huawei Technologies Co., Ltd.

The product described in this manual may include copyrighted software of Huawei Technologies Co., Ltd and possible licensors. Customers shall not in any manner reproduce, distribute, modify, decompile, disassemble, decrypt, extract, reverse engineer, lease, assign, or sublicense the said software, unless such restrictions are prohibited by applicable laws or such actions are approved by respective copyright holders under licenses.

Trademarks and Permissions



 HUAWEI and  are trademarks or registered trademarks of Huawei Technologies Co., Ltd.

Other trademarks, product, service and company names mentioned are the property of their respective owners.

Notice

Some features of the product and its accessories described herein rely on the software installed, capacities and settings of local network, and may not be activated or may be limited by local network operators or network service providers. Thus the descriptions herein may not exactly match the product or its accessories you purchase.

Huawei Technologies Co., Ltd reserves the right to change or modify any information or specifications contained in this manual without prior notice or obligation.

Huawei Technologies Co., Ltd. is not responsible for the legitimacy and quality of any products that you upload or download through this mobile phone, including but not limited to the text, pictures, music, movies, and non-built-in software with copyright protection. Any consequences arising from the installation or usage of the preceding products on this mobile phone shall be borne by yourself.

NO WARRANTY

THE CONTENTS OF THIS MANUAL ARE PROVIDED “AS IS”. EXCEPT AS REQUIRED BY APPLICABLE LAWS, NO WARRANTIES OF ANY KIND, EITHER EXPRESS OR IMPLIED, INCLUDING BUT NOT LIMITED TO, THE IMPLIED WARRANTIES OF MERCHANTABILITY AND FITNESS FOR A PARTICULAR PURPOSE, ARE MADE IN RELATION TO THE ACCURACY, RELIABILITY OR CONTENTS OF THIS MANUAL.

TO THE MAXIMUM EXTENT PERMITTED BY APPLICABLE LAW, IN NO CASE SHALL HUAWEI TECHNOLOGIES CO., LTD BE LIABLE FOR ANY SPECIAL, INCIDENTAL, INDIRECT, OR CONSEQUENTIAL DAMAGES, OR LOST PROFITS, BUSINESS, REVENUE, DATA, GOOD-WILL OR ANTICIPATED SAVINGS.

Import and Export Regulations

Customers shall comply with all applicable export or import laws and regulations and will obtain all necessary governmental permits and licenses in order to export, re-export or import the product mentioned in this manual including the software and technical data therein.

Safety Precautions

Please read the safety precautions carefully to ensure the correct and safe use of your wireless device. For detailed information, refer to the section “Warnings and Precautions”.



Do not switch on your phone when it is prohibited to use mobile phones or when the phone may cause interference or danger.



Do not use your phone while driving.



Follow any rules or regulations in hospitals and health care facilities. Switch off your phone near medical apparatus.



Switch off your phone in aircraft. The phone may cause interference to control signals of the aircraft.



Switch off your phone near high-precision electronic devices. The phone may affect the performance of these devices.



Do not attempt to disassemble your phone or its accessories. Only qualified personnel are allowed to service or repair the phone.



Do not place your phone or its accessories in containers with strong electromagnetic field.



Do not place magnetic storage media near your phone. Radiation from the phone may erase the information stored on them.



Do not put your phone in a high- temperature place or use it in a place with flammable gas such as a gas station.



Keep your phone and its accessories away from children. Do not allow children to use your phone without guidance.



Use only approved batteries and chargers to avoid the risk of explosions.



Observe any laws or regulations on the use of wireless device. Respect others' privacy and legal rights when using your wireless device.



Strictly follow the relevant instructions in this manual while using the USB cable. Otherwise your phone or PC may be damaged.

Contents

Getting Started

About This Guide	1
Packing List	1
Installing SIM Card and Memory Card	2
Charging the Battery	3
Getting to Know Your Phone	6
Security Settings	9

Text Input

Using Zi [®] Input Method	11
Using Traditional Input Method	12
Using Other Input Method	12
Using Symbol Input Method	12

Customized Settings

Profiles	13
Phone Settings	13
Display Settings	13
Network Settings	14

Call Service

Contacts	15
Making a Call	16
Answering or Rejecting a Call	18
Call Settings	18

Messaging

Sending a Message	20
Viewing a Message	20
Message Settings	21

Entertainment

Accessing the Internet	22
Playing Music or Video	22
Using Camera or Video Camera	23
Using FM Radio	23
Games and Applications	24

Connection Function

microSD Card Reader	25
Bluetooth-Based Data Transfer	26
Using Bluetooth Headset	26

Organizer

Manging Files	28
Using the Torch	28
Viewing the Calendar	28
Creating a Note	29
Creating an Alarm	29
Using Other Tools	29

Warnings and Precautions

Electronic Device	30
Medical Device	30
Potentially Explosive Atmosphere	30
Traffic Security	31
Operating Environment	32
Prevention of Hearing Damage	32
Safety of Children	33
Accessories	33

Battery and Charger	33
Cleaning and Maintenance . . .	34
Emergency Call	36
Certification Information (SAR)	36
FCC Statement	37
Industry Canada Compliance .	38

1 Getting Started

About This Guide

This guide describes how to find and use the functions of menus of your phone.

All the pictures in this guide are for your reference only. The actual appearance and display depend on the mobile phone you purchase.

Packing List

Your phone package box contains the following:

- One mobile phone
- One Li-ion battery
- One travel charger
- One USB data cable
- One Quick Start Guide
- One Headset (Optional)

Installing SIM Card and Memory Card

Insert your SIM card before using your phone. Remove the SIM card and the battery only after powering off your phone. To use the SIM card properly, please read the following instructions carefully.

NOTE:

- *Keep the SIM card out of the reach of children.*
- *The SIM card and its metal contacts can be easily damaged by scratching or bending. Be careful when you carry , insert or remove the SIM card.*
- *Always disconnect the charger from the phone before loading or removing the SIM card.*

Your phone supports a memory card (microSD) with a capacity of up to 8 GB.

To load or remove the memory card, remove the battery cover.

»» Getting Started

The following figures show the installation of the SIM card and memory card.

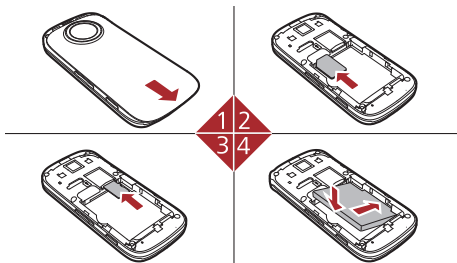

1	Remove the battery cover.
2	Insert the SIM card.
3	(Optional) Insert the memory card.
4	Insert the battery.

Charging the Battery

NOTE:

- *The battery discharges even while not being used. If you have not used it for a long time, please recharge it first.*

- *The charging time depends on the environmental temperature and the age of the battery.*
- *Do not strike, throw or cause any kind of violent shock to the battery, otherwise liquid leakage, body damage, overheating, fire or explosion may occur.*
- *The battery can be recharged but eventually wears out. If the battery lasts for a shorter time period than usual after being charged normally, replace it with a battery of the same type.*
- *Charge the battery by using the charger connector and the USB cable supplied with your phone.*

Before charging the battery, ensure that the battery has been properly loaded into your phone.

1. Connect the USB interface of the USB cable to the travel charger.
2. Plug in the travel charger to a power socket.
3. Connect the mini USB interface of the USB cable to the charger connector of your phone. When the battery is being charged, the charging indicator blinks continuously.
4. When the charging indicator stops blinking, it indicates that the battery is full. Disconnect the charger connector from the power socket.

»» Getting Started

5. Disconnect the USB cable from the phone.

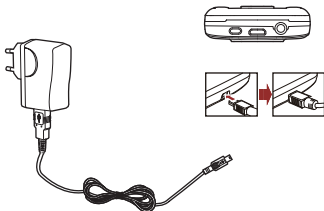

NOTE: *The plug of the cable is in trapezium shape. Reversely inserting the plug may damage the mobile phone and the charger.*

Getting to Know Your Phone

Appearance of Your Phone

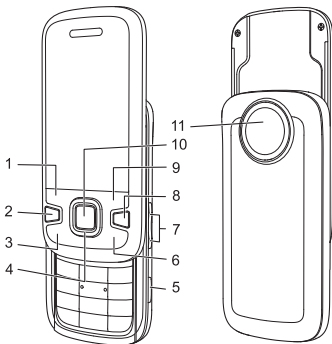

1	Left function key	2	Send key	3	Swaper key
4	Scroll key	5	Camera key	6	Clear key
7	Volume key	8	Power/End key	9	Right function key
10	OK key	11	Camera		

»» Getting Started

Left function key/Right function key	Perform the corresponding functions displayed above these keys.
Send key	Answer a call or view call records in standby mode.
Swaper key	Quick access to Menu.
Scroll key	Scroll through a menu.
Camera key	<ul style="list-style-type: none">• Short press to activate the camera.• Long press to activate the torch.
Clear key	Delete characters to the left of the cursor in input mode.
Power/End key	<ul style="list-style-type: none">• Switch on and off your phone by holding down this key.• Return to the standby mode and reject or end a call.
OK key	Perform the corresponding functions displayed above OK key.

Home Screen

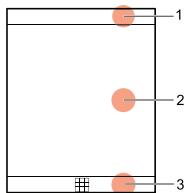

1	Icon bar
2	Desktop
3	Prompt bar



Indicates signal strength.



Alarm clock is enabled.













Indicates power level of the battery.



The normal profile is activated.

»» Getting Started

 The phone is currently in a GSM network.	 The headset is plugged in.
 The phone is currently in a WCDMA network.	 You have new text messages.
 You are using the roaming service.	 You have new multimedia messages.
 Bluetooth is enabled.	 You have new Emails.
 Your phone connects with your PC.	 You have new PUSH messages.
 Call in progress.	

Security Settings

Select **Settings** > **Advanced settings** > **Security** > **Phone and SIM card** > Desired item.

- Reset your phone to the factory settings.

- Enable or disable the "Phone lock" and "PIN lock".
- Modify the screen password, phone password, and PIN 2 code.
- If your SIM card supports the Fixed Dialer Number (FDN) function, you can set the limit for phone numbers.

NOTE:

- *For certain SIM cards, you need to enter the PIN2 code to use certain special functions.*
- *If you enter a wrong PIN code or wrong PIN2 code for three consecutive attempts, the SIM card is locked. To unlock the SIM card, enter the PIN Unlocking Key (PUK) code or PUK2 code.*
- *The PIN code, PIN2 code, PUK code, or PUK2 code is provided together with the SIM card. For details, consult your service provider.*
- *The initial phone password of the phone is 0000.*

Select **Settings > Advanced settings > Security > DRM settings**. Enter the correct phone password and press OK key to confirm, and you can select roaming network or delete all licenses.

Digital Rights Management (DRM) can protect the digital content from piracy and protect the provider's interests. The digital content includes Java applications and multimedia content such as images, audio and video. If the protected content cannot be accessed, it indicates that the corresponding license is overdue or used up.

2 Text Input

NOTE:

- *Press the * key to switch between input methods. Press and hold the * key to enable or disable the Zi input mode.*
- *Press repeatedly the * key and you will see "Abc", "abc", "ABC" or "123" on the upper right corner of the screen successively. It indicates the words to be entered will be in lower case, first letter capitalized or in upper case.*
- *Press the # key to display the symbols list. Press and hold the # key to set the input language.*
- *Press the clear key to delete the letter before the cursor.*

Using Zi[®] Input Method

With the Zi input method, you can easily and quickly enter words. Zi is a predictive text entry mode. Press the relevant key that corresponds to the required letter and Zi will offer you candidate words.

Press each key carrying the desired letter once, and then the predictive text scheme will present the word suggestions composed by the letters you have entered.

Using Traditional Input Method

When Zi input method is off, you can use the traditional input method for entering alphabetic characters. Repeatedly press the key that carries the letter to be entered when it appears on the screen.

Using Other Input Method

In a text editing screen, press and hold the character/number keys to enter corresponding numeric characters.

You can also press successively the * key to switch to the "123" numeric input method, and enter corresponding numeric characters by pressing the character/number keys.

Using Symbol Input Method

You can press the # key to display the symbols list and then select symbols to input.

You can also press the key with number 1 to input the commonly-used symbols in a text editing screen (except numeric input method).

3 Customized Settings

Profiles

You can set different profiles according to different scenarios.

Select **Settings** > **Profiles** > Desired item. Select a profile. And then, press the OK key to enable the profile or select **Edit** to modify the profile.

Phone Settings

Select **Settings** > Desired item, or **Settings** > **Advanced settings** > Desired item. You can set the following:

- Time of your phone
- Language of your phone
- Keypad tones
- Set time to automatically switch phone on and off

Display Settings

Select **Settings** > **Display** > Desired item, you can set the following:

- Wallpaper in standby mode
- Screensaver mode

- Brightness of the screen
- Backlight time
- Enable automatic keypad lock

Network Settings

Select **Settings** > **Network** > Desired item. You can set the following:

- Network mode
- Manual or automatic network selection
- Preferred operators

4 Call Service

NOTE: *In the 3G network, you can make video calls, provided that the called party has a device supporting the video call function.*

Contacts

You can save or manage the information about contacts in **Contacts**. You can also set a contact number as a speed dialing number.

Adding a Contact

1. Select **Contacts**.
2. Select **Options** > **Create contact** to create a new contact in the phone or in the SIM card.
3. Enter the information about the contact.
4. Select **Save** to save the contact.

Searching for a Contact

1. Select **Contacts**.
2. Enter the contact name you are searching for.

3. The contacts corresponding to your input are listed.

You can also use quick search in the contacts list screen. You can find a contact by entering the initials of the first name or the last name of the contact. For example, to find a contact named "Alice Green", enter the letter "a" or "g". The contact is displayed in the candidate list.

Making a Call

- **NOTE:** *During a call, you can select **Options** to perform operations in the option lists.*

Making a Call from Keyboard

1. In standby mode, press number key to enter phone number.
2. To make a call, perform one of the following operations:
 - Press the send key to make a voice call.
 - Select **Options** > **Voice call** to make a voice call.
3. Press the end key to terminate a call.

Making a Call from Contacts

1. Access **Contacts**.
2. Select the desired contact.
3. To make a call, perform one of the following operations:
 - Press the send key to make a voice call.
 - Select **Options > Call > Voice call** to make a voice call.

Making a Call from Call History

You can view all the missed calls, received calls, or dialed numbers in **Calls**.

1. Access **Calls**.
2. Select the desired call history.
3. To make a call, perform either of the following operations:
 - Press the send key to make a voice call.
 - Select **Options > Call > Voice call** to make a voice call.

Answering or Rejecting a Call

When there is an incoming call, press the send key to answer the call, or press the end key to reject the call. You can set the any key answer mode or auto answer mode.

1. Select **Settings > Call settings > General > Answer mode** to set the answer mode.
2. You can answer a call according to your settings.

Call Settings

To enable call forwarding, call waiting and call barring, consult your service provider.

By selecting **Settings > Call settings**, you can set the following:

- Call forwarding type.
- Call barring mode.
- Enable call waiting.
- Prompt to save unknown numbers.
- Automatic redialing after a call fails.
- Answering mode of incoming calls.
- Automatic answering mode.
- Display of your number to the called party. If you set it to automatic, the displaying is subject to your network.

»» Call Service

- Calling line of your mobile phone.
- Set my number. You can create, edit or delete your records.

5 Messaging

Sending a Message

1. Select **Messages** > **Create message** to create a message.
2. During editing a message:
 - You can press down scroll key to add attachment files.
 - You can select **Options** to perform operations in the option list.
3. After editing the message, press OK key to add a recipient's number.
4. Press OK key to send the message.

Viewing a Message

Your phone provides four folders for messages. Received messages are stored in **Inbox**. Messages that are created but not yet sent saved in **Drafts**. Messages that are failed to be delivered are stored in **Outbox**. Messages that are successfully delivered are stored in **Sent**.

»» Messaging

1. Select a mailbox from **Messages**. And then switch between four mailboxes and broadcast inbox through the scroll key.
2. Select a message, and then select **Options** to perform the operations of the option list.

NOTE: If your phone is enabled with the broadcast function, select **Messages > Broadcast inbox** to view broadcast messages.

Message Settings

1. Select **Messages > Settings > Text and picture messaging**, or select **Settings > Advanced settings > Applications > Message settings > Text and picture messaging**.
2. Set the parameters related to messages.

NOTE: Select **Messages > Settings**. You can also change the settings of **Push message, Broadcast** or **Common phrases**.

6 Entertainment

Accessing the Internet

You can perform the following when browsing:

- Select **Browser** to access the internet.
- Entering a website to access and connect to it
- Saving or editing frequently visited websites
- Browsing saved web pages offline
- Browsing history web pages
- Connecting to the website accessed recently
- Setting the Browser

Playing Music or Video

1. Enter **Media** to select music files, video files, or playlists.
2. Press the OK key to play music or video.
3. During the playing of a file, you can perform the following operations:
 - Press the OK key to pause or resume the playing.

»» Entertainment

- Follow the displayed prompts and use the scroll key to perform corresponding operations.
- Select **Options** to perform the operations of the option list.

Using Camera or Video Camera

1. In standby mode, press the camera key or select **Camera** to launch the camera.
2. In the viewfinder screen, you can:
 - Select **Options** to perform the operations of the option list.
 - Press the left and right scroll key to adjust the focus.
 - Press the up and down scroll key to adjust the brightness.
3. After taking a picture or recording a video clip, you can press left and right scroll keys to select icons on the screen to perform the operations of the option list.

Using FM Radio

1. Connect the headset to your phone.
2. Select **Media > FM Radio**.

3. If the channel list is empty, select **Options** > **Automatic tuning** or **Manual tuning** to set channels.

Games and Applications

You can install and run Java applications on your phone. For details, please refer to the help of the applications.

7 Connection Function

NOTE:

- *Your phone supports USB 2.0.*
- *Your phone supports plug and play function.*
- *The USB driver is embedded in the mobile phone.*

microSD Card Reader

NOTE: *The function of microSD card reader and the other functions using the USB cable are incompatible. If you enable the microSD card reader, other functions using the USB cable are unavailable.*

1. Insert the microSD card to your phone.
2. Connect your phone to the PC by using the USB cable.
3. *Found New Hardware* and a device icon are displayed at the notification area of your PC.
4. The *PC Options* software supplied on your phone will run automatically. And then select *File Transfer*.

5. An icon for the mobile memory drive appears on your PC. Then you can read the files saved in the microSD card directly.
6. After reading the files, right-click on the device icon at the notification area of your PC to delete the device on your PC.

Bluetooth-Based Data Transfer

You can exchange data between your Bluetooth phone and other Bluetooth devices. If you want to exchange data between your phone and another device, that device must support Bluetooth and the Bluetooth function must be enabled.

1. Select **Settings > Bluetooth > Switch on** to enable the Bluetooth function.
2. Select **Settings > Bluetooth > Search devices** to search a Bluetooth device. When the Bluetooth device is found for the first time, authentication is required.

Now you can exchange data between your phone and the other Bluetooth device.

Using Bluetooth Headset

You can answer a call by a Bluetooth headset or Bluetooth loudspeaker. For details, refer to the corresponding user manual of a Bluetooth headset or loudspeaker.

»» Connection Function

1. Set the Bluetooth headset to the status for detecting.
2. Select **Settings > Bluetooth > Switch on** to enable the Bluetooth function.
3. Select **Settings > Bluetooth > Search devices** to search a Bluetooth device. When a Bluetooth device is found for the first time, authentication is required.
4. If a Bluetooth headset is detected and recognized for the first time, it should be authenticated by a PIN code.

Now you can use the Bluetooth headset as the connection has been established between your phone and the Bluetooth headset.

The Bluetooth headset should be set to the status for detecting only when authentication is needed. Once the headset has been authenticated, you just need to turn on your Bluetooth headset. For more information, refer to the user manual of your Bluetooth headset.

NOTE: *The procedure for using a Bluetooth loudspeaker is similar to that for a Bluetooth headset. For details, refer to the user manual supplied with your Bluetooth loudspeaker.*

8 Organizer

Manging Files

1. Select **Tools** > **File manager** > Desired item.
2. Select **Options** to perform the operations of the list.

When your phone finds the memory card, the memory card tab is automatically displayed on the folder screen. Select the required files in the memory card and perform operations as required. In addition, you can also format the memory card.

Using the Torch

You can long press the camera key to switch on the torch. And then, long press the camera key to switch off the torch.

Viewing the Calendar

1. Select **Calendar**, and then select the desired date.
2. Press the OK key to view the reminder.
3. Select **Options** to create a reminder, set the view mode, set the calendar and check the memory status.

Creating a Note

1. Select **Tools > Memo**.
2. You can select **Create memo** to edit a new memo.
3. Select **Options >** Desired item to perform the operations of the option list.

Creating an Alarm

1. Access **Clock > Alarms** to set an alarm.
2. Select an alarm from the alarm list, press the OK key to enter edit mode.
3. You can select the corresponding option to activate or deactivate the alarm.
4. When it is time for an alarm clock to ring, the selected alarm tone is played and a prompt is displayed. You can stop the ringing or snooze the alarm.

NOTE: *If your phone is powered off, the alarm clock will still ring. When the alarm rings, you can choose to power on the phone.*

Using Other Tools

Your phone also provides **Calculator**, **Converter**, **Voice recorder**, and **Service dial number**.

9 Warnings and Precautions

This section contains important information pertaining to the operating instructions of your device. It also contains information about how to use the device safely. Read this information carefully before using your device.

Electronic Device

Power off your device if using the device is prohibited. Do not use the device when using the device causes danger or interference with electronic devices.

Medical Device

- Follow rules and regulations set forth by hospitals and health care facilities. Do not use your device when using the device is prohibited.
- Pacemaker manufacturers recommend that a minimum distance of 15 cm be maintained between a device and a pacemaker to prevent potential interference with the pacemaker. If you are using a pacemaker, use the device on the opposite side of the pacemaker and do not carry the device in your front pocket.

Potentially Explosive Atmosphere

Power off your device in any area with a potentially explosive atmosphere, and comply with all signs and instructions. Areas that may have potentially explosive atmospheres include the areas where you would normally be advised to turn off your vehicle engine. Triggering of sparks in such areas could cause an explosion or a fire, resulting in bodily injuries or even deaths. Do not power on your device at refueling points such as service stations. Comply with restrictions on the use of radio equipment in fuel

»» Warnings and Precautions

depots, storage, and distribution areas, and chemical plants. In addition, adhere to restrictions in areas where blasting operations are in progress. Before using the device, watch out for areas that have potentially explosive atmospheres that are often, but not always, clearly marked. Such locations include areas below the deck on boats, chemical transfer or storage facilities, and areas where the air contains chemicals or particles such as grain, dust, or metal powders. Ask the manufacturers of vehicles using liquefied petroleum gas (such as propane or butane) whether this device can be safely used in their vicinity.

Traffic Security

Observe local laws and regulations while using the device. In addition, if using the device while driving a vehicle, comply with the following guidelines:

- Concentrate on driving. Your first responsibility is to drive safely.
- Do not talk on the device while driving. Use hands-free accessories.
- When you have to make or answer a call, park the vehicle at the road side before using your device.
- RF signals may affect electronic systems of motor vehicles. For more information, consult the vehicle manufacturer.
- In a motor vehicle, do not place the device over the air bag or in the air bag deployment area. Otherwise, the device may hurt you owing to the strong force when the air bag inflates.
- Do not use your device while flying in an aircraft. Power off your device before boarding an aircraft. Using wireless devices in an aircraft may cause danger to the operation of the aircraft and disrupt the wireless telephone network. It may also be considered illegal.

Operating Environment

- Do not use or charge the device in dusty, damp, and dirty places or places with magnetic fields. Otherwise, it may result in a malfunction of the circuit.
- The device complies with the RF specifications when the device is used near your ear or at a distance of 1.5 cm from your body. Ensure that the device accessories such as a device case and a device holster are not composed of metal components. Keep your device 1.5 cm away from your body to meet the requirement earlier mentioned.
- On a stormy day with thunder, do not use your device when it is being charged, to prevent any danger caused by lightning.
- When you are on a call, do not touch the antenna. Touching the antenna affects the call quality and results in increase in power consumption. As a result, the talk time and the standby time are reduced.
- While using the device, observe the local laws and regulations, and respect others' privacy and legal rights.
- Keep the ambient temperature between -10°C and 35°C while the device is being charged. Keep the ambient temperature between -10°C to 35°C for using the device powered by a battery.

Prevention of Hearing Damage

Using a headset at high volume can damage your hearing. To reduce the risk of damage to hearing, lower the headset volume to a safe and comfortable level.

Safety of Children

Comply with all precautions with regard to children's safety. Letting the child play with your device or its accessories, which may include parts that can be detached from the device, may be dangerous, as it may present a choking hazard. Ensure that small children are kept away from the device and accessories.

Accessories

Use the accessories delivered only by the manufacturer. Using accessories of other manufacturers or vendors with this device model may invalidate any approval or warranty applicable to the device, result in the non-operation of the device, and cause danger.

Battery and Charger

- Unplug the charger from the electrical plug and the device when not in use.
- The battery can be charged and discharged hundreds of times before it eventually wears out. When the standby time and the talk time are shorter than the normal time, replace the battery.
- Use the AC power supply defined in the specifications of the charger. An improper power voltage may cause a fire or a malfunction of the charger.
- Do not connect two poles of the battery with conductors, such as metal materials, keys, or jewelries. Otherwise, the battery may be short-circuited and may cause injuries and burns on your body.

- Do not disassemble the battery or solder the battery poles. Otherwise, it may lead to electrolyte leakage, overheating, fire, or explosion.
- If battery electrolyte leaks out, ensure that the electrolyte does not touch your skin and eyes. When the electrolyte touches your skin or splashes into your eyes, wash your eyes with clean water immediately and consult a doctor.
- If there is a case of battery deformation, color change, or abnormal heating while you charge or store the battery, remove the battery immediately and stop using it. Otherwise, it may lead to battery leakage, overheating, explosion, or fire.
- If the power cable is damaged (for example, the cord is exposed or broken), or the plug loosens, stop using the cable at once. Otherwise, it may lead to an electric shock, a short circuit of the charger, or a fire.
- Do not dispose of batteries in fire as they may explode. Batteries may also explode if damaged.
- Danger of explosion if battery is incorrectly replaced. Recycle or dispose of used batteries according to the local regulations or reference instruction supplied with your device.

Cleaning and Maintenance

- The device, battery, and charger are not water-resistant. Keep them dry. Protect the device, battery, and charger from water or vapor. Do not touch the device or the charger with a wet hand. Otherwise, it may lead to a short circuit, a malfunction of the device, and an electric shock to the user.

»» Warnings and Precautions

- Do not place your device, battery, and charger in places where they can get damaged because of collision. Otherwise, it may lead to battery leakage, device malfunction, overheating, fire, or explosion.
- Do not place magnetic storage media such as magnetic cards and floppy disks near the device. Radiation from the device may erase the information stored on them.
- Do not leave your device, battery, and charger in a place with an extreme high or low temperature. Otherwise, they may not function properly and may lead to a fire or an explosion. When the temperature is lower than 0°C, performance of the battery is affected.
- Do not place sharp metal objects such as pins near the earpiece. The earpiece may attract these objects and hurt you when you are using the device.
- Before you clean or maintain the device, power off the device and disconnect it from the charger.
- Do not use any chemical detergent, powder, or other chemical agents (such as alcohol and benzene) to clean the device and the charger. Otherwise, parts of the device may be damaged or a fire can be caused. You can clean the device and the charger with a piece of damp and soft antistatic cloth.
- Do not dismantle the device or accessories. Otherwise, the warranty on the device and accessories is invalid and the manufacturer is not liable to pay for the damage.

Emergency Call

You can use your device for emergency calls in the service area. The connection, however, cannot be guaranteed in all conditions. You should not rely solely on the device for essential communications.

Certification Information (SAR)

This device meets guidelines for exposure to radio waves.

Your device is a low-power radio transmitter and receiver. As recommended by international guidelines, the device is designed not to exceed the limits for exposure to radio waves. These guidelines were developed by the independent scientific organization International Commission on Non-Ionizing Radiation Protection (ICNIRP) and include safety measures designed to ensure safety for all users, regardless of age and health.

The Specific Absorption Rate (SAR) is the unit of measurement for the amount of radio frequency energy absorbed by the body when using a device. The SAR value is determined at the highest certified power level in laboratory conditions, but the actual SAR level of the device when being operated can be well below the value. This is because the device is designed to use the minimum power required to reach the network.

The SAR limit adopted by the USA and Canada is 1.6 watts/kilogram (W/kg) averaged over one gram of tissue. The highest SAR value reported to the FCC and IC for this device type when tested for use at the ear is 0.807 W/kg, and when properly worn on the body is 0.978 W/kg.

FCC Statement

This equipment has been tested and found to comply with the limits for a Class B digital device, pursuant to Part 15 of the FCC Rules. These limits are designed to provide reasonable protection against harmful interference in a residential installation. This equipment generates, uses and can radiate radio frequency energy and, if not installed and used in accordance with the instructions, may cause harmful interference to radio communications. However, there is no guarantee that interference will not occur in a particular installation. If this equipment does cause harmful interference to radio or television reception, which can be determined by turning the equipment off and on, the user is encouraged to try to correct the interference by one or more of the following measures:

- Reorient or relocate the receiving antenna.
- Increase the separation between the equipment and receiver.
- Connect the equipment into an outlet on a circuit different from that to which the receiver is connected.
- Consult the dealer or an experienced radio/TV technician for help.

This device complies with Part 15 of the FCC Rules. Operation is subject to the following two conditions: (1) this device may not cause harmful interference, and (2) this device must accept any interference received, including interference that may cause undesired operation.

Warning: Changes or modifications made to this device not expressly approved by Huawei Technologies Co., Ltd. may void the FCC authorization to operate this device.

Industry Canada Compliance

This phone complies with Industry Canada RSS 133/RSS 132/RSS 102/RSS 139/RSS 210. This phone complies with the Class B limits for radio-noise emissions as set out in the Industry Canada Interference-Causing Equipment Standard standard entitled "Digital Apparatus" (ICES-003).

V100R001 31010XXX