

STB User Guide



1 Precautions

Safety Instructions

- This product should be operated only from the type of power source indicated on the marking label.
- Confirm appropriate power and cable connection before powering on the STB.
- If the STB has been operating for a long time, STB temperature increases. Take measures for heat dissipation.
- Upon cleaning or long-time unused, disconnect the power cable. Do not pull on the power cable.
- When disconnecting the power cable, turn off the STB, and then grasp it by the plug.
- During a lightning storm, disconnect the power cable or network cable to avoid damage to the STB or other accidents caused by lightning strikes.

Maintenance Instructions

- Shield the STB from direct sunlight and keep it away from sources of intense heat.
- Install the STB in a well-ventilated position, and avoid humid and dusty places.
- Use a soft cloth to clean STB surface. Never use alcohol, gasoline, or other organic solvent.
- Do not place the STB in any location that is subject to strong pressure, striking, or vibration.

Tips on Making Repairs

- Do not damage the warranty tag when removing the STB cover.
- Do not allow unqualified personnel to remove the STB cover. This is to avoid damage to the internal circuit.
- If repair is required, contact the local service center.
- If parts replacement is required, ensure that service technicians use the parts that are specified by the manufacturer and have the same characteristics as the original parts.

2 Install the STB

Step 1 Connect Cables

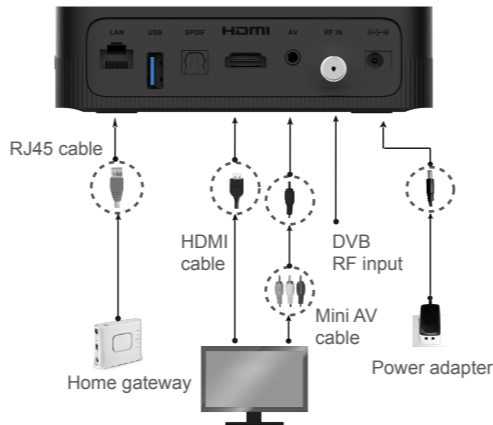



Notice:

- Do not connect the unit through a VCR. Video signals fed through VCRs may be affected by copyright protection systems and the picture will be distorted on the television.
- Connecting your TV directly to the Audio/Video output of your STB will assure a more vivid picture and enhance your viewing enjoyment.
- This product incorporates copy protection technology that is protected by U.S. patents and other Intellectual property rights of Rovi Corporation. Reverse engineering and disassembly are Prohibited.

Step 2 Start the STB













1. Verify that the power cable of the STB is properly connected.
2. Turn on the power switch of the TV and select the correct video input mode.



- Connect the , choose the TV or AV.
- Connect the , choose the HDMI.

3 Remote Control



No.	Item	Description
1		Switch the status of TV Set between working and standby.
		Study the function of the TV set's Remote control.
		Change audio volume of TV set.
		Shift video output of TV set.
2		Switch the status of STB between working and standby.
		Change audio tracks.
		Mute/resume the audio.
		Display the STB setting page.
3		Quickly switch to the previous channel.
		Shortcut to Live TV channel list.
		Shortcut to TVOD menu.
		Shortcut to VOD menu.

No.	Item	Description
3		Display information of current program.
4		Numerals 0 to 9 and associated letters.
		Enter an asterisk (*).
		<ul style="list-style-type: none"> Enter a number sign (#). Switch between input methods.
5		Shortcut to homepage.
		Return to previous menu.
		Move the cursor upward, downward, leftward or rightward in EPG.
		Confirm an operation.
		Reserved key (defined by EPG).
6		Show more options menu.
		Change audio volume of STB.
		Seek forward by an interval while watching a VOD/TSTV program.

No.	Item	Description
6		Seek backward by an interval while watching a VOD/TSTV program.
		<ul style="list-style-type: none"> During playback: Change to the next or previous channel. Out of playback: Turn to the next or previous page.
7		Fast rewind a VOD or TSTV program.
		Fast forward a VOD or TSTV program.
		<ul style="list-style-type: none"> Pause or resume program playback. Adjust program playback progress.
8		Stop program playback.
		Reserved Key (Defined by EPG).

Control Remote Study Function

Procedure

Assume that you want your STB remote control to study the function of the Power key on your TV remote control. The procedure is as follows:

Step 1 Hold down on the TV study keypad for 3 seconds.

The indicator on your STB remote control is steady on, which indicates that the STB has entered the study mode.

Step 2 Hold down (red) on the TV study keypad for 1 second.

The indicator on your STB remote control blinks, which indicates that your STB

remote control is ready for receiving a signal.

Step 3 Aim the emission port of your TV remote control at the emission port of your STB remote control (the distance between the two ports must be less than 3 cm), and hold down the Power key on your TV remote control for 3 seconds to send a signal.

- If the indicator on your STB remote control quickly blinks three times and then is steady on, your STB remote control has received the signal and the study of the Power key function is complete. Release the Power key on your TV remote control.
- If the indicator on your STB remote control does not respond in the preceding way, your STB remote control has failed to receive the signal. Repeat steps 2 and 3.



You can repeat steps 2 and 3 to enable your STB remote control to

study the functions of the and keys on your TV remote control.

Step 4 Press to save the settings and to exit the study mode.

After that, you can control your TV by using the (red) key on the TV study keypad.

Precautions

- If no signal is received within 10 seconds after your STB remote control enters the study mode, the study mode exits automatically.
- The keys on the TV study keypad can be used for studying the functions of keys on your TV remote controls of various brands. Only key functions that are last studied are saved.
- If you have trouble using your STB remote control to control your TV after performing steps 1 to 4, verify that your STB remote control is working properly.

4 Items in the Packaging Box

No.	Item	Quantity
1	Set Top Box (STB)	1
2	Infrared remote control	1
3	Battery	2
4	Power adapter	1
5	Mini AV cable (optional)	1
6	RJ45 cable	1
7	High Definition Multimedia Interface (HDMI) cable	1
8	User Guide	1
9	Safety Information & Legal Notice	1

5 FAQs

1. Black-and-white images are displayed after STB startup.

Possible Cause:

The video cable is of poor quality or is not properly connected.

Solution:

Replace and reconnect the video cable.

2. No video is displayed on the TV screen.

Possible Cause:

- The video cable or network cable is not properly connected.
- The power cable is not properly connected.
- The TV is in an incorrect mode.

Solution:

- Verify that the video cable and network cable are properly connected.
- Verify that the power cable is properly connected.
- Verify that the TV is in the correct mode.

3. No audio is heard.

Possible Cause:

- The audio cable is not properly connected.
- The TV or the STB is in mute mode or the volume is extremely low.

Solution:

- Verify that the audio cable is properly connected. For details, see Connect Cables.
- Switch the TV and STB to the audible mode, and increase the volume.

4. The remote control is working abnormally.

Possible Cause:

- The remote control is far away from the STB.
- The batteries in the remote control are low.

Solution:

- Move the remote control to a workable distance.
- Replace the batteries.