



# HUAWEI *Ascend* G525

## User Guide



Welcome to HUAWEI

# Contents

Foreword .....	1
Safety precautions.....	2
Preparations .....	4
Your phone at a glance .....	4
Inserting a USIM/SIM card .....	5
Installing the microSD card.....	6
Installing the battery .....	7
Charging the battery .....	7
Powering your phone on and off.....	8
Dual-Card Management .....	9
Setting up your phone for the first time.....	9
Getting started.....	10
Gestures .....	10
Locking and unlocking the screen .....	11
Getting to know your home screen.....	12
Using the notification panel .....	15
Accessing applications .....	16
Texting.....	16
Personalizing your phone.....	19
Setting the theme .....	19
Changing the wallpaper.....	19
Setting the home screen transition effect .....	20
Organizing home screen widgets and application icons.....	20
Organizing home screen items using folders .....	21
Me Widget .....	21
Customizing your home screens .....	23
Customizing switch shortcuts on the notification panel .....	23
Managing profiles .....	24
Setting tones.....	25
Changing the font size.....	25
Setting the screen unlock method .....	26
Adjusting the screen brightness .....	27

<b>Calls</b> .....	<b>28</b>
Smart dialing.....	28
Answering or rejecting a call.....	28
What you can do during a call .....	29
Making a conference call.....	30
Answering a third-party call .....	30
Making emergency calls .....	30
Other call services .....	31
<b>People</b> .....	<b>33</b>
Creating a contact .....	33
Searching for a contact.....	33
Copying contacts .....	33
Importing or exporting contacts .....	34
Adding a contact to your favorites .....	35
Deleting a contact.....	35
Joining or splitting contacts .....	35
Sharing contacts.....	36
Contact groups .....	37
<b>Messaging</b> .....	<b>39</b>
Sending a text message .....	39
Sending a multimedia message .....	39
Replying to a message .....	40
Searching for a message.....	40
Managing messages .....	40
Modifying message settings .....	42
<b>Browser</b> .....	<b>43</b>
Browsing web pages .....	43
Managing bookmarks .....	43
Setting the home page .....	44
Clearing your browsing history .....	44
<b>Email</b> .....	<b>45</b>
Adding a POP3 or IMAP email account.....	45
Adding an Exchange account.....	45
Switching between email accounts.....	46
Sending emails .....	46
Checking your emails .....	46
Removing an email account .....	47

<b>Multimedia</b> .....	<b>48</b>
Camera .....	48
Gallery .....	50
Music .....	52
<b>Internet connection</b> .....	<b>55</b>
Mobile data connection .....	55
Wi-Fi network .....	55
Sharing your phone's mobile data connection .....	57
Controlling your data usage .....	58
<b>Sharing data</b> .....	<b>60</b>
Bluetooth .....	60
DLNA .....	61
Connecting your phone to a computer .....	62
<b>File Manager</b> .....	<b>63</b>
Creating a folder .....	63
Searching for a file .....	63
Copying or moving a file .....	64
Compressing or decompressing files .....	64
Renaming a file .....	64
Deleting a file .....	65
Creating a shortcut for a file or folder .....	65
Checking the memory status .....	65
<b>Managing applications</b> .....	<b>66</b>
Obtaining applications .....	66
Installing an application .....	66
Viewing applications .....	66
Uninstalling an application .....	67
Clearing the application cache .....	67
<b>Huawei applications</b> .....	<b>68</b>
Backup .....	68
<b>Google services</b> .....	<b>69</b>
Gmail .....	69
Google Talk .....	70
Maps .....	70
YouTube .....	71
Play Store .....	72

<b>Basic utilities</b> .....	<b>73</b>
Calendar .....	73
Clock.....	74
Calculator .....	75
Notes .....	75
Weather .....	76
FM radio .....	77
<b>Accounts and synchronization</b> .....	<b>79</b>
Adding an account.....	79
Deleting an account.....	79
Turning on data synchronization .....	80
Modifying account synchronization settings .....	80
<b>Settings</b> .....	<b>81</b>
Turning on or off airplane mode .....	81
Tone settings .....	81
Display settings .....	82
Setting the PIN of your SIM card .....	82
Setting the date and time.....	83
Changing the system language .....	83
Modifying location service settings .....	84
Turning on or off fast boot .....	84
Restoring to factory settings .....	84
Online update .....	85
Accessibility .....	85
<b>FAQs</b> .....	<b>86</b>
<b>Legal notice</b> .....	<b>88</b>

# Foreword

Thank you for choosing the Huawei Ascend G525 smartphone.



This guide introduces you to the features and functions of your new phone. Please read this guide carefully before you start using the phone.

All pictures and illustrations in this document are for your reference only. The actual product may vary.

## **Symbols and definitions**

The following symbols are used in this document to indicate useful and important information:

---

	Note	Provides additional information.
	Caution	Indicates important information that helps you accomplish a task or get a feature to work. Overlooking this information may result in your device becoming damaged or data being lost.

---

# Safety precautions

Please read the safety precautions carefully to ensure the correct use of your mobile phone.



Do not crash, throw, or puncture your mobile phone. Avoid the falling, squeezing, and bending of your mobile phone.



Do not use your mobile phone in a moist environment, such as the bathroom. Prevent your mobile phone from being soaked or washed in liquid.



Do not switch on your mobile phone when it is prohibited to use phones or when the phone may cause interference or danger.



Do not use your mobile phone while driving.



Follow any rules or regulations in hospitals and health care facilities. Switch off your mobile phone near medical apparatus.



Switch off your mobile phone in aircraft. The phone may cause interference to control equipment of the aircraft.



Switch off your mobile phone near high-precision electronic devices. The phone may affect the performance of these devices.



Do not attempt to disassemble your mobile phone or its accessories. Only qualified personnel are allowed to service or repair the phone.



Do not place your mobile phone or its accessories in containers with a strong electromagnetic field.



Do not place magnetic storage media near your mobile phone. Radiation from the phone may erase the information stored on them.



Do not put your mobile phone in a high-temperature place or use it in a place with flammable gas such as a gas station.



Keep your mobile phone and its accessories away from children. Do not allow children to use your mobile phone without guidance.



Use only approved batteries and chargers to avoid the risk of explosions.



Observe any laws or regulations on the use of wireless devices. Respect the privacy and legal rights of others when using your wireless device.



Strictly follow the relevant instructions of this manual while using the USB cable. Otherwise your mobile phone or computer may be damaged.



# Preparations

## Your phone at a glance

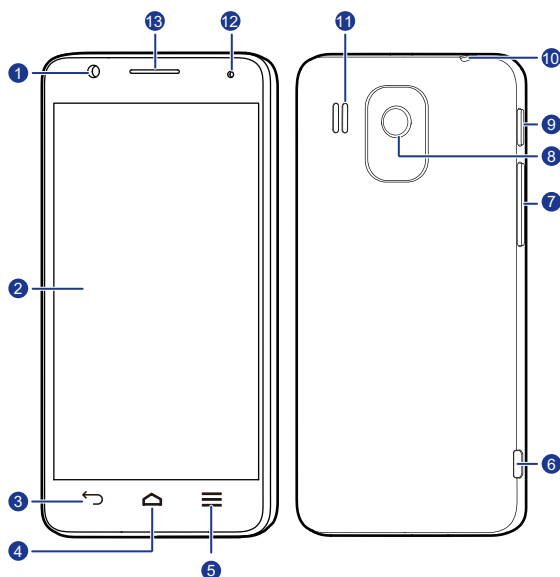

1 Front camera

2 Screen

3 Return

4 Home

5 Menu

6 Micro USB port (for charging and data exchange)

7 Volume button

8 Rear camera

9 Power button (⏻)

10 Headset jack

11 Speaker

12 Status indicator

13 Earpiece

## Buttons



- Press and hold to power on your phone.
- When your phone is powered on, press and hold to display an option menu.
- When your phone is powered on, press to turn off the screen.



- Touch to return to the previous screen or exit the current application.
- Touch to hide the onscreen keyboard.



- Touch to return to the home screen.
- Touch and hold then swipe up to open Google Search.



- Touch to display an option menu where available.
- Touch and hold to display the list of recently used applications.

## Inserting a USIM/SIM card

To install a USIM/SIM card, perform the operations shown in the following figures.

1. Remove the battery cover.

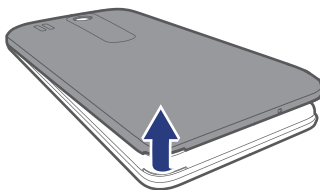

2. Insert the USIM/SIM card into the USIM/SIM card slot with its metal contacts facing down.

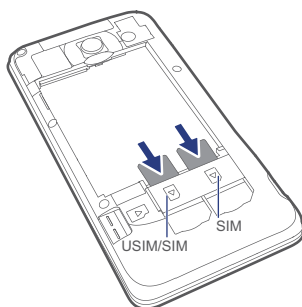

## Installing the microSD card

You can insert a microSD card to expand your phone's storage capacity. To do so, perform the operations shown in the following figure.

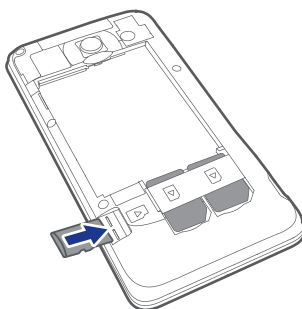

To remove the microSD card:

1. On the home screen, touch  and then the **All** tab.
2. Touch **Storage > Unmount SD card**.
3. Carefully remove the microSD card.

## Installing the battery

To install the battery, perform the operations shown in the following figures.

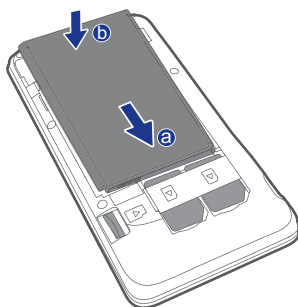

1. Remove the battery cover.
2. Align the battery's metal contacts with those at the bottom of the battery compartment (refer to position **a** in the preceding figure).
3. Press the other end of the battery (position **b** in the preceding figure) against your phone to fix it to the battery compartment.
4. Close the battery cover.

## Charging the battery

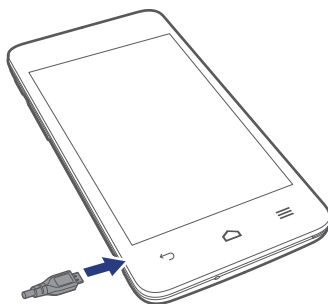

1. Connect your charger to the provided USB cable.
2. Connect the charger to a power outlet.
3. Connect your phone to the USB cable to start charging.

## Battery indicator light

The battery indicator shows your phone's battery level.



- Blinking red: The battery level is lower than 10%.
- Steady red (when charging): The battery level is lower than 10%.
- Steady yellow (when charging): The battery level is higher than 10%.
- Steady green (when charging): The battery level is almost or already full.

The charging is complete when the screen shows that the battery level is 100%.

## Important information about the battery

- If the battery power is depleted, you may not be able to power on your phone immediately after you begin charging the battery. This is normal. Allow the battery to charge for a few minutes before attempting to power on your phone.
- Rechargeable batteries have a limited number of charge cycles and may eventually need to be replaced. When the battery life becomes noticeably shorter, replace the battery.
- The time required to fully charge the battery depends on the ambient temperature and the age of the battery.
- If your phone is very low on power, it plays an alert tone and displays a message. If the battery level is extremely low, your phone automatically powers off.

## Powering your phone on and off

- To power on your phone, press and hold .
- To power off your phone, press and hold  to display an option menu, and then touch **Power off**.

## Dual-Card Management

Your mobile phone supports access to both WCDMA and GSM networks. Follow the onscreen instructions or the quick start guide to install USIM/SIM cards.

1. On the home screen, touch  and then the **All** tab.
2. Touch **Dual card** to activate the USIM/SIM cards or set the selected card for network connection or for calls/messages.

## Setting up your phone for the first time

When you use your phone for the first time, follow the onscreen instructions to set it up.

When you power on your phone or open some applications for the first time, your phone displays instructions to warm you up to basic operations. To read the instructions again, touch **Management**>  from the home screen.

# Getting started

## Gestures



**Touch:** Touch to select an item or open an application.

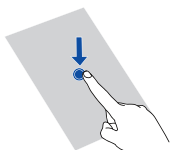

**Touch and hold:** Touch and leave your finger on the screen for 2 seconds or longer. You can touch and hold an application, a widget, or a blank area to display the related option menu.

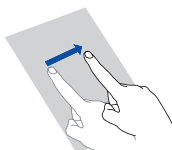

**Flick:** Where applicable, swipe your finger in the direction you want the screen to move. For example, you can flick left or right across the notification panel to dismiss a notification.

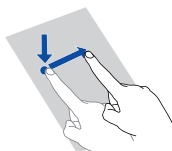

**Drag:** Touch and hold an item and then drag it to another position. You can re-arrange icons on the home screen this way.

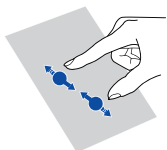



**Pinch:** Pinch two fingers together to zoom out or stretch them apart to zoom in on a map, web page, or picture.

## Locking and unlocking the screen



Locking the screen not only prevents your phone from carrying out undesirable operations when you are not using it, but also protects it from unauthorized use. You can lock and unlock your screen in a number of ways. The pre-installed screen unlock method is used as an example in this section.

### Locking the screen



- You can press  to lock the screen.
- After being idle for a specified period of time, your phone automatically locks its screen.

 To set the screen lock method, touch  on the home screen. On the displayed **General** tab, touch **Screen lock**.

### Unlocking the screen

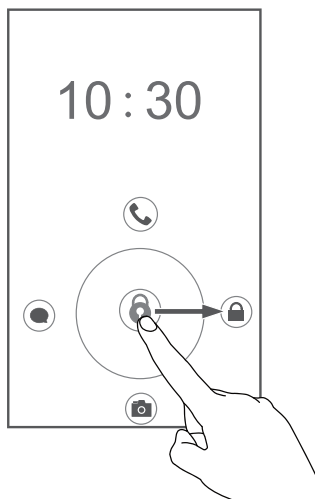
1. If the screen is off, press  to wake it.
2. Drag  right to unlock the screen.



 Drag  towards an application to open it.



## Getting to know your home screen

Your phone displays applications right on its home screen, giving you easy access to the applications. This section uses the default theme as an example to introduce the home screen.

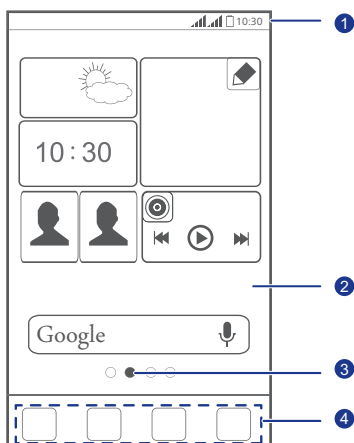

1

Status bar: displays notifications and icons. Flick down from the status bar to open the notification panel.

2

Display area: displays the application icons, folders, and widgets.

3

Screen position indicator: shows the current screen's position among the entire home screen.

4

Dock: touch to open the desired applications.































### Status icons









Signal strength



No signal

	GPRS network connected		Enhanced Data Rates for GSM Evolution (EDGE) network connected
	3G network connected		High Speed Downlink Packet Access (HSDPA) network connected
	Roaming		Airplane mode enabled
	Bluetooth on		Receiving location data from GPS
	Vibration mode enabled		Silence mode enabled
	Alarms enabled		Charging
	Battery full		Battery low
	Call in progress		Missed calls
	New messages		New emails
	New voicemail		Select input method
	Wi-Fi network available		Connected to a Wi-Fi network
	Uploading data		Downloading data
	Phone memory full		Upcoming events
	No SIM card found		Sign-in or synchronization problem
	Synchronizing data		Synchronization failed

---

	Portable Wi-Fi hotspot on		More notifications
	Connected to a VPN		Headset plugged in
	Connected to a computer		USB tethering on

---

## Switching between home screens

Running out of space on the home screen? No worries! Your phone lets you create more home screens for various application icons and widgets.

- Flick left and right across the screen to switch between the home screens.

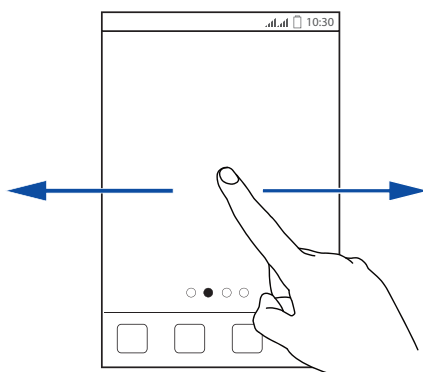

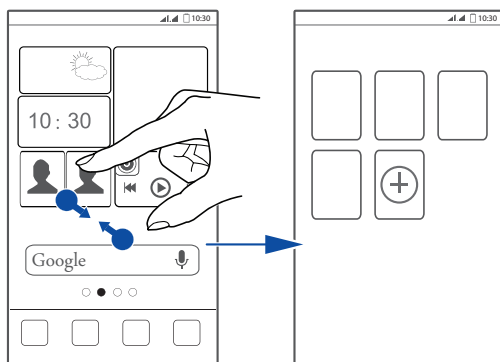

- Pinch two fingers together to display the home screen thumbnails. Touch a thumbnail to enter that particular home screen.



## Taking a screenshot

Want to share an interesting scene in a movie or show off your new high score in a game? Simply take a screenshot and share it.

Press and hold  and the volume down button simultaneously to take a screenshot. Then, open the notification panel and touch  to share the screenshot. Screenshots are saved to the **Screenshots** album in **Gallery**.

## Auto-rotate screen

Your phone features a tilt sensor. If you rotate your phone while browsing a web page or viewing a photo, the orientation of your screen will automatically change to landscape or portrait view. You can also enjoy tilt sensor-based games, such as car racing games.

To quickly turn the auto-rotate screen function on or off, flick down from the status bar to open the notification panel and touch .

## Using the notification panel

Flick down from the status bar to open the notification panel.

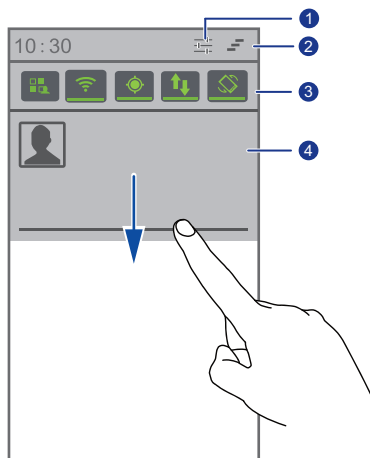

- 
- 1 Touch  to display the settings screen.
-

- 
- 2 Touch  to delete all notifications.
- 
- 3 Touch the switch shortcuts on the notification panel to turn the desired functions on or off.
- 
- 4 Touch an application to start it and flick left or right across a notification to close it.
- 

## Accessing applications

### Starting applications and switching between them

On the home screen, touch an application icon to open it.

To switch to another application, touch  to return to the home screen, and touch the icon of the desired application.

### Viewing recently used applications

To display the list of recently used applications, touch and hold . You can then:

- Touch an application to start it.
- Flick left or right across an application to close it.
- Touch  to clear the list.



## Texting

Your phone comes with multiple text input methods. You can quickly enter text using the onscreen keyboard.

- Touch a text field to bring up the onscreen keyboard.
- To hide the onscreen keyboard, touch .







## Selecting an input method

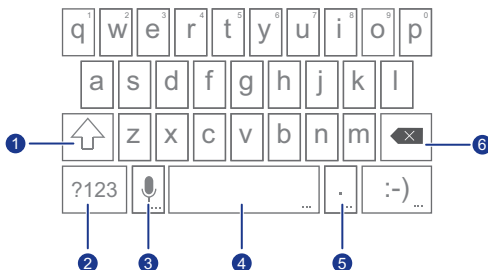



1. On the text input screen, flick down from the status bar to open the notification panel.
2. Touch  and select an input method.

 To change your phone's default input method, touch  on the home screen. Then touch the **All** tab. In the **PERSONAL** area, touch **Language & input > Default** and select an input method.

## Android Input Method













- 
- When you type in lower case, touch  to capitalize the next character to be entered.
- 1
- When you type in lower case, touch and hold or double-touch  to capitalize all characters to be entered.
- 
- 2
- Touch  to enter numbers.
- 
- 3
- Touch  to switch to voice input.
  - Touch and hold  to open the **Input options** menu.
- 
- 4
- Touch  to enter a space.
  - Touch and hold  to switch to another input method.
-



- 
- 5
    - Touch  to enter a period.
    - Touch and hold  to enter symbols.
- 
- 6
    - Touch  to delete the character to the left of the cursor.
    - Touch and hold  to delete all characters to the left of the cursor.
- 

## Editing text

You can easily select, cut, copy, paste, and replace text on your phone.

- **Select text:** Touch and hold the text to bring up . Then drag  and  to select more or less text, or touch  to select all text.
- **Cut text:** Select text and touch .
- **Copy text:** Select text and touch .
- **Paste text:** Touch where you wish to insert the text, drag  to move the insertion point, and touch  > **PASTE** to paste the text you copied or cut.
- **Replace text:** Touch and hold the text, drag  and  to select more or less text, and touch .

## Configuring an input method

1. On the home screen, touch  and then the **All** tab.
2. In the **PERSONAL** area, touch **Language & input**.
3. In the **Keyboard & input methods** area, touch the input method you wish to configure and then touch  to configure it.

# Personalizing your phone

## Setting the theme

Your phone comes with a variety of themes. You can download more themes from the web and mix and match theme elements to find a perfect fit.

### Changing the theme

1. On the home screen, touch .
2. Select a theme and touch **Apply** to apply it.

### Customizing a theme

1. From the theme list, touch **Customize current theme**.
2. From the element list, choose the elements you wish to modify.
3. When you are done, touch **Save as my theme** on the **Customize** screen.

The custom theme is then saved to the **Local** tab.

## Changing the wallpaper

1. On the home screen, touch and hold a blank area. In the displayed **Set home screen** dialog box, choose **Wallpapers**.
2. Select the image you wish to set as the wallpaper from one of the following:
  - **Gallery**
  - **Live wallpapers**
  - **Themes**
  - **Wallpapers**





## Setting the home screen transition effect

1. On the home screen, touch and hold a blank area to display the **Set home screen** dialog box.
2. Touch **Transitions**.
3. Select the desired home screen transition effect.



## Organizing home screen widgets and application icons

### Adding a widget to the home screen

1. On a home screen, touch and hold a blank area to display the **Set home screen** dialog box.
2. Touch **Widgets**.
3. Drag a widget to the desired screen thumbnail.
4. Touch  to return to the home screen.

 If the home screen doesn't have enough space, your phone will automatically create a new home screen to the original's right and place the widget on the new home screen.

### Deleting an application icon or widget

On the home screen, touch and hold the application icon or widget you wish to delete until  is displayed. Drag the unwanted application icon or widget to  to delete it.

 Deleting an application icon uninstalls the application. When you delete an application icon, your phone prompts you to confirm the action. Touch **OK** to uninstall the application.

### Moving an application icon or widget

You can re-arrange application icons and widgets to any fitting empty space on the home screen.

## Organizing home screen items using folders

### Managing folders on the home screen

1. On the home screen, drag an item onto another item to create a folder containing both of them.
2. You can then:
  - Touch the folder name to rename it.
  - Touch **+** and add more items to the folder.

### Removing an item from a folder

1. On the home screen, touch the desired folder.
2. Drag an item out from the folder to remove the item.



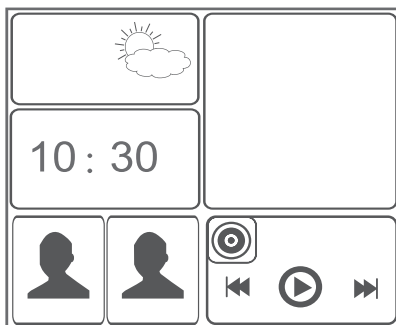

A folder must contain at least two items; otherwise the folder will automatically disappear.

## Me Widget





Me Widget groups widgets including People, Music, Clock, and Weather together.



## Removing a widget unit from Me Widget



1. Touch and hold Me Widget until your phone vibrates. Release your finger.  
The  icon is displayed in the upper right corner.
2. Touch  to enter editing mode.
3. Touch  in the upper right corner on the widget unit you wish to remove.
4. When you are done, touch .

## Adding a widget unit

1. Touch and hold Me Widget until  appears in the upper right corner on Me Widget.
  2. Touch  to enter editing mode.
  3. Flick left or right across the widget unit list, select a widget unit and drag it to a blank area on Me Widget.
-  Each widget unit takes up certain space on Me Widget. If a message is displayed indicating that there is no available space, delete some widget units to free up space first.
4. When you are done, touch .

## Moving a widget unit

Before you move a widget unit, make sure that Me Widget have a blank area the same size as the widget unit you wish to move.

1. Touch and hold Me Widget until  appears in the upper right corner on Me Widget.
2. Touch  to enter editing mode.
3. Touch and hold a widget unit on Me Widget until your phone vibrates.  
Then, drag the widget unit to the blank area.
4. When you are done, touch .

## Customizing your home screens

### Re-arranging home screens

1. On a home screen, touch and hold a blank area to display the **Set home screen** dialog box.
2. Touch **Thumbnails**.
3. Touch and hold a home screen thumbnail until your phone vibrates. Then, drag the home screen thumbnail to the new location.

### Adding a home screen

1. On a home screen, touch and hold a blank area to display the **Set home screen** dialog box.
2. Touch **Thumbnails**.
3. Touch  to add a home screen.

### Deleting a home screen

Only blank home screens are deletable.

1. On a home screen, touch and hold a blank area to display the **Set home screen** dialog box.
2. Touch **Thumbnails**.
3. Touch  on the unwanted home screen to delete the home screen.

## Customizing switch shortcuts on the notification panel

You can move the switch shortcuts to your most used functions to the top of the switch shortcut list so that these shortcuts can be displayed on the notification panel.

1. Flick down from the status bar to open the notification panel.
2. Flick left on the upper area. Touch  to display the switch shortcut list.
3. Drag a switch shortcut to move it to another place in the switch shortcut list.



## Managing profiles

### Changing the profile

1. On the home screen, touch .
2. From the profile list, select a profile and touch the button to its right to activate the profile.



 You can also flick down from the status bar to open the notification panel and change the profile using the switch shortcuts on the notification panel.

### Adding a profile

1. On the home screen, touch .
2. Touch .
3. Touch the text box and name the profile.
4. Touch **Next**.
5. Configure the profile settings.
6. When you are done, touch **Done**.

### Deleting a profile

To delete a custom profile, perform the following operations. Nevertheless, preset profiles cannot be deleted.



1. On the home screen, touch .
2. Touch  > **Delete**.
3. Select the profile you wish to delete.  
You can select more than one profile.
4. Touch .
5. Touch **OK**.

## Setting tones

### Setting the ringtone

1. On the home screen, touch  and then the **All** tab.
2. In the **DEVICE** area, touch **Sound**.
3. Touch **SIM 1 ringtone** or **SIM 2 ringtone** and select either of the following options from the displayed dialog box:
  - **Ringtone**: choose from the default tones.
  - **Local music**: choose from the audio files you have saved to your phone.
4. Touch **OK**.

### Changing the message tone and other tones

1. On the home screen, touch  and then the **All** tab.
  2. In the **DEVICE** area, touch **Sound**.
  3. Touch **Notification tone**.
  4. Select a tone type and select either of the following options from the displayed dialog box:
    - **Ringtone**: choose from the default tones.
    - **Local music**: choose from the audio files you have saved to your phone.
-  You can configure the email notification tone only after you have set up an email account.
5. Touch **OK**.

## Changing the font size

1. On the home screen, touch  and then the **All** tab.
2. In the **DEVICE** area, touch **Display**.
3. Touch **Font size** and select a font size.

## Setting the screen unlock method

Once a screen unlock method is set, you will have to use it every time you want to unlock your screen.

### Face unlock

1. On the home screen, touch  and then the **All** tab.
2. In the **PERSONAL** area, touch **Security**.
3. Touch **Screen lock > Face Unlock**.
4. Follow the onscreen instructions to take a photo of your face.  
Your phone will use face unlock as the primary unlock method.
5. Set a secondary unlock method.

If face unlock cannot recognize you (because of dim light, for example), follow the onscreen instructions to unlock your phone using the secondary unlock method.

To turn off face unlock, use the secondary unlock method to enter the **Screen lock** screen, and select another unlock method.

### Unlocking the screen with a pattern

1. On the home screen, touch  and then the **All** tab.
2. In the **PERSONAL** area, touch **Security**.
3. Touch **Screen lock > Pattern**.
4. Follow the onscreen instructions to set a screen unlock pattern.

 If you draw incorrect patterns five consecutive times, the screen stops responding to your operations for 30 seconds. Nevertheless, you will still be able to make emergency calls during this time.

## Unlocking the screen with a PIN

1. On the home screen, touch  and then the **All** tab.
2. In the **PERSONAL** area, touch **Security**.
3. Touch **Screen lock > PIN**.
4. Follow the onscreen instructions to set a screen unlock PIN.

## Unlocking the screen with a password

1. On the home screen, touch  and then the **All** tab.
2. In the **PERSONAL** area, touch **Security**.
3. Touch **Screen lock > Password**.
4. Follow the onscreen instructions to set a screen unlock password.
5. Repeat the password and touch **OK**.

 If you enter incorrect passwords five consecutive times, the screen will stop responding to your operations for 30 seconds. However, you will still be able to make emergency calls during this time.

## Adjusting the screen brightness

1. On the home screen, touch  and then the **All** tab.
2. In the **DEVICE** area, touch **Display**.
3. Touch **Brightness**.
4. In the displayed dialog box, perform either of the following operations:
  - Select the **Automatic brightness** check box to have your phone automatically adjust its screen brightness based on the ambient light.
  - Drag the slider left to reduce the screen brightness or drag it right to increase the screen brightness.

You can also flick down from the status bar to open the notification panel and adjust the screen brightness.



# 📞 Calls

## Smart dialing

Smart dialing lets you quickly find contacts by entering their numbers.

1. On the home screen, touch .

2. Enter a phone number.

Matching contacts in your phone and phone numbers in your call log are then displayed in a list.



3. From the list, select the contact you wish to call.



4. To end the call, touch .

## Answering or rejecting a call

When a call comes in, you can perform the following operations.

 To silence an incoming call, press the volume down button.





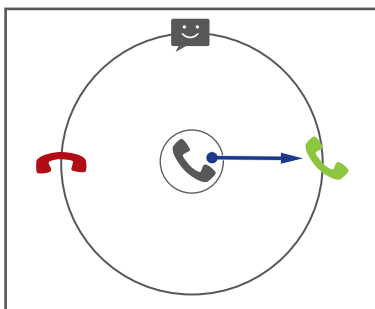

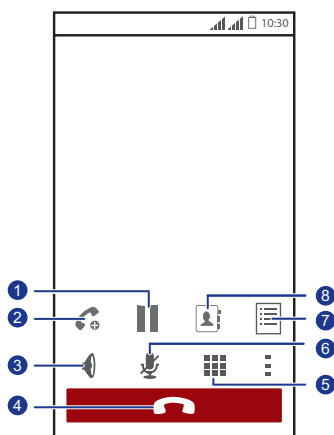

- Drag  right to answer the call.
- Drag  left to reject the call.
- Drag  up to reject the call and send the caller a message.

 On the dialer screen, touch  > **Settings** > **Quick responses** to edit the message that will be sent.



## What you can do during a call







- 
- 1 Touch  to place the current call on hold, and touch  to resume the call.
- 
- 2 Touch  to start a three-way call. Before you use three-way calling, make sure that you have subscribed to this service. For details, contact your service provider.
- 
- 3 Touch  to use the speakerphone.
- 
- 4 Touch  to end the call.
- 
- 5 Touch  to display the dialer.
- 
- 6 Touch  to mute or unmute the microphone.
- 
- 7 Touch  to display a note.
- 
- 8 Touch  to display the contact list.
-

To return to the call screen, flick down from the status bar to open the notification panel, and touch **Current call**.

## Making a conference call



Making conference calls with your friends, family, and co-workers is easy with your phone.

 Before you make a conference call, make sure that you have subscribed to this service. For details, contact your service provider.

1. Call the first participant.
2. When the call is connected, touch  >  to call the second participant.  
The first participant will be placed on hold.
3. When the second call is connected, touch  to start a conference call.
4. To add more people to the call, repeat steps 2 and 3.
5. Touch  to end the call.



## Answering a third-party call

Before you answer a third-party call, make sure that you have turned on call waiting.

1. If a call comes in when you are already busy on the phone, drag  right to answer the new call and place the first call on hold.
2. To switch between the two calls, touch .

## Making emergency calls

In the event of an emergency, you can make emergency calls as long as your phone is powered on and you have reception. No SIM card is necessary.

1. On the home screen, touch .
2. Enter your local emergency number, and touch .

 Whether you can make emergency calls depends on your cellular network quality, use environment, service provider policies, and local laws and regulations. Never rely solely on your phone for critical communications when emergencies occur.

## Other call services

Your phone also supports other call functions, such as call forwarding, call waiting, and voicemail. Before you use these functions, make sure that you have subscribed to these services. For details, contact your service provider.

### Enabling call forwarding

Too busy to answer all your calls with one phone? Forward them to another number and never miss an important call again!

1. On the home screen, touch  and then the **All** tab.
2. In the **APPS** section, touch **Call**.
3. Touch **Call forwarding**.
4. Select a forwarding mode and enter the phone number to which you wish to forward calls.
5. Touch **Enable** to turn on call forwarding.

### Call waiting

The call waiting function lets you answer another incoming call when you are already busy in a call and switch between the two calls.

1. On the home screen, touch  and then the **All** tab.
2. In the **APPS** area, touch **Call**.
3. Touch **Additional settings**.
4. Select the **Call waiting** check box to enable call waiting.

### Setting up your voicemail

Apart from forwarding calls to another phone number, you can forward calls (including the calls missed when you are on the phone or when your phone is powered off) to your voicemail.

 Before you use voicemail, make sure that you have subscribed to this service and have obtained your voicemail number. For details, contact your service provider. In addition, you must enable the call forwarding function and set all incoming calls to be forwarded to your voicemail.

1. On the home screen, touch  and then the **All** tab.

2. In the **APPS** area, touch **Call**.

3. Touch **Voicemail settings > Voicemail number**.



4. Enter your voicemail number and touch **OK**.

To listen to your voicemail messages, touch and hold the **1** key on the dialer.

# People

Forget about lugging around business card holders. With your phone, you can easily store and manage contacts and add important contacts to favorites.



## Creating a contact

1. On the home screen, touch .
2. On the **People** screen, touch .
3. Enter the contact name, phone number, and other information. Touch **Add another field** to enter more contact details.
4. When you are done, touch **DONE**.

## Searching for a contact

1. On the home screen, touch .
2. On the **People** screen, touch the search box.
3. Enter the contact name or initials.  
Matching results are displayed as you type.  
For example, to search for John Doe, enter **John Doe** or **J D**.

## Copying contacts



1. On the home screen, touch .
2. On the **People** screen, touch .
3. Touch **Manage contacts** > **Copy contacts**.
4. From the displayed option menu, select where the contacts you wish to copy are from.
5. Touch the contact you wish to copy or touch **SELECT ALL** to select all contacts.
6. Touch **COPY** and select the account to which you wish to copy the contacts.

## Importing or exporting contacts

Your phone supports contact files in standard .vcf format only.

### Importing contacts from a storage device



You can import contacts from a storage device to your phone.

1. On the home screen, touch .
2. On the **People** screen, touch .
3. Touch **Manage contacts > Import from storage**.
4. Select one or more .vcf files and touch **OK** to import the contacts.

### Importing contacts from a Bluetooth device



You can import contacts from another Bluetooth device.

Before you import contacts, enable the Bluetooth function on your phone.

1. On the home screen, touch .
2. On the **People** screen, touch .
3. Touch **Manage contacts > Import via Bluetooth**.  
Your phone then searches for available Bluetooth devices.
4. Touch the Bluetooth device with which you wish to pair your phone.  
When the two devices are paired, your phone automatically imports contacts from the .vcf file in the other device.



### Export contacts

Back up your contacts to a storage device in case the contacts get lost during a system upgrade or by mistake.



1. On the home screen, touch .
2. On the **People** screen, touch .
3. Touch **Manage contacts > Export to storage**.  
A dialog box is then displayed, indicating the exported .vcf file name and its save location.
4. Touch **OK**.

To view the .vcf file you just exported, start the **File Manager** application and open your phone's root directory.

## Adding a contact to your favorites

1. On the home screen, touch  and then the **Favorites** tab.
2. On the **Favorites** screen, touch .
3. Touch the contact you wish to add to favorites.
4. Touch **ADD**.

## Deleting a contact

1. On the home screen, touch .
2. On the **People** screen, touch .
3. Touch **Delete contacts**.
4. Touch the contact you wish to delete or touch **SELECT ALL** to select all contacts.
5. Touch **DELETE**.
6. Touch **OK**.

## Joining or splitting contacts

Do not want to have multiple entries for the same contact from different accounts? Join these entries to better manage your contacts.

 Contacts stored in the SIM card cannot be joined.





## Joining contacts

1. On the home screen, touch .
2. On the **People** screen, select the main contact you want the other contacts to be joined to.
3. Touch **Manage joined contacts** > **Add contact** to select contacts to be joined.

After you join the contacts, they are all saved to the main contact.



## Splitting contacts

Joined the wrong contacts by mistake? No worries, you can simply split the joined contact.

1. On the home screen, touch .
2. On the **People** screen, select the contact you want to split.
3. Touch **Manage joined contacts** to display the **Joined contacts** screen.
4. Touch  to the right of the contact to split it.

## Sharing contacts



You can share contacts in .vcf format in many ways.

1. On the home screen, touch .
2. On the **People** screen, touch .
3. Touch **Share contacts**.
4. Touch the contact you wish to share or touch **SELECT ALL** to select all contacts.
5. Touch **SHARE** and choose a sharing method from the displayed option menu.

## Contact groups

You can create a contact group and send a message or email to all group members simultaneously.

### Creating a contact group



1. On the home screen, touch  and then the **Groups** tab.
2. On the **Groups** screen, touch .
3. Name the contact group.
4. Touch **Add members** to select one or more contacts.
5. Touch **ADD MEMBERS**.
6. When you are done, touch **DONE**.

### Editing a contact group

1. On the home screen, touch  and then the **Groups** tab.
2. On the **Groups** screen, touch and hold the contact group you wish to edit.
3. From the displayed option menu, choose **Edit**.
4. Rename the group or manage group members.
5. When you are done, touch **DONE**.

### Sending messages or emails to a contact group

1. On the home screen, touch  and then the **Groups** tab.
2. On the **Groups** screen, touch and hold the contact group to which you wish to send the message or email.
3. From the displayed option menu, choose **Send message** or **Send Mail**.

 You can also open the contact group and touch  to send a message or  to send an email.

## Deleting a contact group







1. On the home screen, touch  and then the **Groups** tab.
2. On the **Groups** screen, touch and hold the contact group you wish to delete.
3. From the displayed option menu, choose **Delete**.



Deleting a contact group will not remove the contacts in this group from your phone.











# Messaging

## Sending a text message



1. On the home screen, touch .
2. In the list of message threads, touch .
3. Touch the recipient text box and enter the contact name or phone number.
  -  Touch  to select more contacts and send the message to them simultaneously.
4. Write your message.
5. When you are done, touch  or .

## Sending a multimedia message



Before you send a multimedia message, turn on your phone's mobile data.

1. On the home screen, touch .
2. In the list of message threads, touch .
3. Touch  > **Add subject** to enter the message subject.
4. Touch the recipient text box and enter the contact name or phone number.
  -  Touch  to select more contacts and send the message to them simultaneously.
5. Write your message.
6. Touch , select the attachment type, and attach a file.
  -  To attach more than one files to the message, touch **Slideshow**.
7. When you are done, touch  or .
-  Your phone can send a multimedia message up to 300 KB. A file larger than that cannot be sent using the Multimedia Messaging Service (MMS).

## Replying to a message



1. On the home screen, touch .
2. In the list of message threads, touch a contact name or phone number to view the conversation thread.
3. Touch the text field and write your reply.
4. When you are done, touch  or .

## Searching for a message

1. On the home screen, touch .
2. In the list of message threads, touch .
3. Enter the message keyword.  
Your phone then displays matching messages.



## Managing messages

### Copying a message

1. On the home screen, touch .
2. In the list of message threads, touch a contact name or phone number to view the conversation thread.
3. Touch and hold the message you wish to copy.
4. From the displayed option menu, choose **Copy text**.
5. Touch and hold the area you wish to paste the message. Drag  to move the insertion point. Then, touch  > **PASTE** to paste the message.

## Forwarding a message

1. On the home screen, touch .
2. In the list of message threads, touch a contact name or phone number to view the conversation thread.
3. Touch and hold the message you wish to forward.
4. From the displayed option menu, choose **Forward**.
5. Touch the recipient text box and enter the contact name or phone number.

 Touch  to select more contacts and forward the message to them simultaneously.



6. When you are done, touch 1 or 2.

## Locking a message



You can lock important messages to avoid deleting them by mistake. Deleting a thread does not remove the locked messages in it.

1. On the home screen, touch .
2. In the list of message threads, touch a contact name or phone number to view the conversation thread.
3. Touch and hold the message you wish to lock.
4. From the displayed option menu, choose **Lock**.



## Deleting a message

1. On the home screen, touch .
2. In the list of message threads, touch a contact name or phone number to view the conversation thread.
3. Touch  > **Delete messages**.
4. Select the message you wish to delete.
5. Touch .
6. Touch **Delete** to delete the messages.

## Deleting a thread

1. On the home screen, touch .
2. In the list of message threads, touch and hold the thread you wish to delete until  appears.
3. Touch .
4. Touch **Delete** to delete the thread.

## Modifying message settings

1. On the home screen, touch .
2. In the list of message threads, touch .
3. Touch **Settings**.
4. Change the message tone, add a message signature, and more.

# Browser

Your phone's browser lets you surf the web and stay on the ball with up-to-date news and information. Staying connected has never been easier.



## Browsing web pages

1. On the home screen, touch .
2. Enter a website address in the address box.  
Your phone displays matching websites as you type.
3. Touch the website you wish to visit to open it.



## Managing bookmarks

Bookmarks let you keep track of your favorite websites.

### Adding a bookmark



1. On the home screen, touch .
2. On the **Browser** screen, open the web page you wish to add as a bookmark.
3. Touch  > **Save to bookmarks**.
4. Name the bookmark or use the default name. Then, touch **OK**.

### Accessing a bookmark

1. On the home screen, touch .
2. On the **Browser** screen, touch  > **Bookmarks**.
3. In the **Local** area, touch a bookmark.





## Editing a bookmark

1. On the home screen, touch .
2. On the **Browser** screen, touch  > **Bookmarks**.
3. Touch and hold the bookmark you wish to edit.
4. From the displayed option menu, choose **Edit bookmark**.
5. Edit the bookmark, such as renaming it.
6. When you are done, touch **OK**.



## Setting the home page

Would you like to access your most visited web page every time you open the browser? Set your favorite web page as your browser's home page to make life a little easier.

1. On the home screen, touch .
2. On the **Browser** screen, touch  > **Settings** > **General** > **Set homepage**.
3. From the displayed option menu, choose the web page you wish to set as the home page.

## Clearing your browsing history

To better protect your privacy, clear your browsing history from time to time.

1. On the home screen, touch .
2. On the **Browser** screen, touch .
3. Touch **Settings** > **Privacy & security** > **Clear history**.
4. Touch **OK**.

# Email

Don't want to miss important emails from your friends or clients during your business trip? Use your phone to read and reply to emails when you are on the go.

## Adding a POP3 or IMAP email account

Certain parameters must be set when you add a Post Office Protocol 3 (POP3) or Internet Mail Access Protocol (IMAP) email account. For details, contact your email service provider.

1. On the home screen, touch .
2. Select an email account type.
3. Enter your email address and password, and touch **Next**.
4. Follow the onscreen instructions to configure the email settings.

When the email account is added, the **Inbox** screen is displayed.

 To add more email accounts, touch  > **Settings** > **ADD ACCOUNT**.

## Adding an Exchange account

Exchange is an email system developed by Microsoft to implement communication inside an enterprise. Some email service providers also provide Exchange accounts for individuals and families.

Certain parameters must be set when you add an Exchange account. For details, contact your email service provider.



1. On the home screen, touch .
2. Touch **Exchange**.
3. Enter your **Email address**, **Domain**, **Username**, and **Password**. Then, touch **Next**.
4. Follow the onscreen instructions to configure the email settings.

When the Exchange account is added, the **Inbox** screen is displayed.

## Switching between email accounts







1. On the home screen, touch .
2. Touch the email address on the top to display your email account list.
3. Touch an email account.



## Sending emails

1. On the home screen, touch .
2. Open an email account.
3. On the **Inbox** screen, touch .
4. Enter the recipient and subject and write your message. Attach files to the message if any.
5. When you are done, touch  to send the email.

## Checking your emails



1. On the home screen, touch .
2. Open an email account.
3. On the **Inbox** screen, touch the email you wish to read.
4. When reading an email, you can:

- Touch  to reply to it.
- Touch  > **Forward** to forward the email.
- Touch  to delete the email.
- Touch  to mark the email as unread.
- Touch  to read the previous email.
- Touch  to read the next email.

 Mail retrieval may be slightly delayed depending on the network condition. Touch  in the lower right corner to refresh the inbox.

## Removing an email account

After you delete an email account, your phone will no longer send or receive emails using that account.

1. On the home screen, touch  .
2. On the **Inbox** screen, touch  .
3. Touch **Settings**.
4. Select the account you want to delete.
5. In the **REMOVE ACCOUNT** section, touch **Remove account**.
6. Touch **OK**.

# Multimedia

## Camera

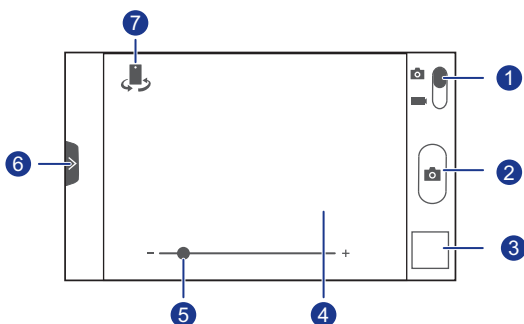

As time flies by, there must be some memories you wish to keep forever. Camera is a great tool for this. It supports a variety of shooting modes, such as single, panoramic, and quick shoot.

### Photo taking screen





---

1

- Drag the slider to  to switch to photo mode.
- Drag the slider to  to switch to video mode.

---

2

- Touch  to take a photo.
- Touch and hold  to focus the camera. Then release your finger to take a photo.

---

3

- Touch the thumbnail to view photos you just took.

---

4





- Touch an object on the viewfinder to focus the camera on it.

---

5



- Drag the slider to zoom in or out.
-

Drag  to display an option menu, from which you can:



- Touch  to select a shooting mode.
- 6 • Touch  to select a filter.
- Touch  to select a white balance.
- Touch  to set the scene type, ISO, and more.

- 
- 7 • Touch  to toggle between the rear and front cameras.
- 

## Taking a photo

1. On the home screen, touch .
2. Frame the scene you wish to capture.
3. You can take a photo in either of the following two ways:
  - Touch an area on the screen to focus there, then touch  to take the photo.
  - Touch and hold  until the viewfinder frame color changes, which indicates that the camera is focused, then release your finger to take the photo.



## Shooting a video

1. On the home screen, touch .
2. Frame the scene you wish to record.
3. Touch  to start recording.
4. Touch  to stop recording.

## Taking a panoramic photo

Are you still upset that your camera's view angle is not big enough to include the entire beautiful scene into one photo? Well, problem solved! Your phone's **Panorama** mode lets you take several photos and stitch them into a single photo.

1. On the home screen, touch .

2. Drag  to open the settings menu. Then touch  > **Panorama**.
3. Frame the scene you wish to capture.
4. Touch .
5. Move your phone slowly to capture the view along the direction indicated by the arrow.

Your phone will capture multiple photos.

-  If the viewfinder turns red, the view will not be captured. This may happen because you have moved your phone too fast or the viewfinder scope exceeds the limit of the panoramic view.

6. Your phone stops shooting when it has taken enough photos for a panoramic photo. You can also touch  to stop shooting.  
Your phone then automatically stitch the photos into a panoramic photo.

## Gallery

**Gallery** is your personal treasure box of sweet memories.



### Viewing photos or videos

In your **Gallery**, photos and videos are stored in separate albums.

1. On the home screen, touch .
2. Touch the album you wish to view.
3. Touch the photo or video to view it in full screen mode.





-  When viewing a photo, pinch two fingers together to zoom out or spread them apart to zoom in.

### Playing a slideshow



1. On the home screen, touch .
2. Touch the album that stores the photos you wish to play.
3. Touch  to play photos in the album as a slideshow.
4. Touch the screen to stop the slideshow.

## Editing a photo

You can remove red eye, crop a photo, and apply a number of effects to make your photos even more stunning.

1. On the home screen, touch .
2. Touch the photo you wish to edit.
3. Touch  > **Edit** and then you can:
  - Touch  to lighten or shadow the photo.
  - Touch **FX** to cross-process or posterize the photo.
  - Touch  to tint the photo, make it negative.
  - Touch  to rotate or crop the photo.
4. When you are done, touch **SAVE**.  
By default, edited photos are saved to **DCIM/Camera**.

## Rotating a photo

1. On the home screen, touch .
2. Touch the photo you wish to rotate.
3. Touch  > **Rotate Left** or **Rotate Right**.



 You can also enable the auto-rotate screen function to have your phone automatically adjust the display orientation when you rotate your phone.

## Cropping a photo

1. On the home screen, touch .
2. Touch the photo you wish to crop.
3. Touch  > **Crop**. You can then:
  - Drag the grid to reposition it.
  - Drag the frames of the grid to resize it.
4. When you are done, touch **SAVE**.  
By default, cropped photos are saved to **DCIM/Camera**.





## Deleting a photo



1. On the home screen, touch .
2. Touch the photo you wish to delete.
3. Touch .
4. Touch **OK** to delete the photo.

## Sharing a photo or video

Want to share your best shots or an amusing trick your dog just did? Simply share the photos and videos using email, Bluetooth, and more.

1. On the home screen, touch .
2. Touch the photo or video you wish to share.
3. Touch .
4. Select a sharing method and follow the onscreen instructions to share the photo or video.

## Setting the wallpaper

1. On the home screen, touch .
2. Choose the photo you wish to set as the wallpaper.
3. Touch  > **Set picture as** > **Wallpaper**.
4. Drag the frames of the grid to resize it.
5. When you are done, touch **SAVE**.

## Music

In the mood for music? Your phone provides you with a supreme audio experience.

## Copying songs to your phone

You can copy songs to your phone and immerse yourself with an extraordinary audio experience anytime. Add songs to your phone in the following ways:

- Copy songs from your computer using USB.
- Download songs from the web.
- Copy songs from other devices using Bluetooth.
- Copy songs from other devices using Wi-Fi.

## Listening to music

1. On the home screen, touch .
2. Choose a category.
3. Touch the song you want to play.

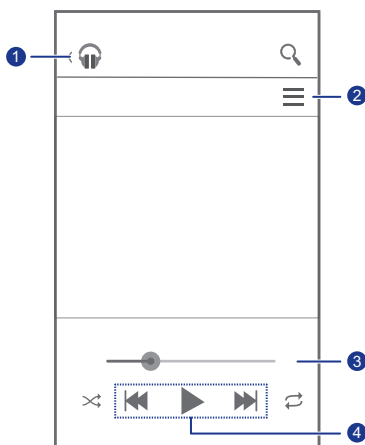

---

1 Touch  to enter the music library.





---



2 Touch  to display the option menu from which you can perform additional operations.

---

3 Drag the slider to control the playback.



---

- 
- Touch  to play and touch  to pause.
  - 4 • Touch  to play the previous song.
  - Touch  to play the next song.
- 

 When a song is playing, touch  to exit the playback screen and have the song still be played. To return to the music playback screen, open the notification panel and touch the playing song.

## Creating a playlist

Creating playlists and adding songs to them let you listen to songs that fit your mood most.

1. On the home screen, touch .
2. Touch **PLAYLISTS**.
3. Touch  > **New playlist**.
4. Touch the text field to name the playlist.
5. In the displayed dialog box, touch **OK**.

## Playing a playlist

1. On the home screen, touch .
2. Touch **PLAYLISTS**.
3. Touch the playlist you wish to play.
4. Touch the song you wish to play, and the playlist will be played from the selected song.

## Deleting a playlist

1. On the home screen, touch .
2. Touch **PLAYLISTS**.
3. Touch and hold the playlist you wish to delete.
4. From the displayed option menu, choose **Delete**.

# Internet connection

## Mobile data connection

After you insert a USIM/SIM card into your phone and power it on for the first time, your phone automatically registers with your service provider's data services.

### Enabling data services

1. On the home screen, flick down from the status bar to open the notification panel.
2. Touch  to enable your phone's data services.

 When you don't need to access the Internet, disable data services to save battery power and reduce data usage.

## Wi-Fi network

When you use your phone at home, you can connect to the Wi-Fi hotspot created from your router. Some public places, such as hotels and libraries, may also have available Wi-Fi networks. Though, please bear in mind that these may not be free to use.

### Connecting to a Wi-Fi network

1. On the home screen, touch  and then the **All** tab.
2. In the **WIRELESS & NETWORKS** area, touch the Wi-Fi switch to turn on Wi-Fi.
3. In the **WIRELESS & NETWORKS** area, touch **Wi-Fi**.  
Your phone then scans for available Wi-Fi networks and displays them if any.
4. Choose the Wi-Fi network you wish to access and connect to the network in the following two ways:
  - For an open network, the connection process will start immediately.
  - For an encrypted Wi-Fi network, enter the password when prompted, then touch **Connect**.



-  If Wi-Fi and mobile data are both enabled, your phone connects to the Wi-Fi network preferentially. When Wi-Fi becomes unavailable, your phone automatically switches to the mobile data connection.

## Connecting to a Wi-Fi network using the WPS



The Wi-Fi protected setup (WPS) lets you quickly connect to a Wi-Fi network. A safe connection is set up by pressing the WPS button or entering the PIN, instead of complex settings on the management software of Wi-Fi hotspots, such as wireless routers.

-  To use the WPS function and set up a Wi-Fi connection between your phone and a Wi-Fi hotspot, make sure that the Wi-Fi hotspot also supports the WPS.

### Using the WPS button

1. On the home screen, touch  then the **All** tab.
2. Under **WIRELESS & NETWORKS**, touch the Wi-Fi switch to turn on Wi-Fi.
3. On the Wi-Fi network list, touch .
4. On the Wi-Fi hotspot device, press the WPS button.

### Using the WPS PIN

1. On the home screen, touch  then the **All** tab.
2. Under **WIRELESS & NETWORKS**, touch the Wi-Fi switch to turn on Wi-Fi.
3. On the Wi-Fi network list, touch .
4. Touch **Input WPS PIN**.  
Your phone generates a PIN.
5. On the Wi-Fi hotspot device, enter the PIN.

## Sharing your phone's mobile data connection

Want to access the Internet from multiple devices when you are on the go? Use USB tethering or set your phone as a Wi-Fi hotspot to share its data connection with other devices.

### USB tethering

You can share your phone's data connection with a computer using USB. To use USB tethering, you may need to install your phone's driver on the computer, depending on your computer's operating system.

1. Use a USB cable to connect your phone to the computer.
2. On the home screen, touch  and then the **All** tab.
3. In the **WIRELESS & NETWORKS** area, touch **More...**
4. Touch **Tethering & portable hotspot**.
5. Select the **USB tethering** check box to share your phone's data connection.

 You cannot use your phone's USB tethering function while the phone is in USB storage mode.

### Using your phone as a Wi-Fi hotspot

Your phone can also function as a Wi-Fi hotspot for other devices, such as your computer.

1. On the home screen, touch  and then the **All** tab.
2. In the **WIRELESS & NETWORKS** area, touch **More...**
3. Touch **Tethering & portable hotspot > Configure Wi-Fi hotspot**.
4. Name the Wi-Fi hotspot.
5. Select an encryption mode.

 It is recommended that you set the encryption mode to WPA2 PSK to better secure the Wi-Fi network.

## 6. Set the key to the Wi-Fi hotspot.

When other devices want to access your phone's network, this key must be entered.

## 7. Select the **Portable Wi-Fi hotspot** check box.

8. You can now search for and access your phone's Wi-Fi network from other devices.

# Controlling your data usage

Your phone's data usage control function lets you check and control your data usage. Set a data usage cycle and the mobile data limit for a period of time and you will be notified when your data usage reaches this limit. You can also query the data usage within a certain period of time or data usage consumed by an application.

On the home screen, touch  > **All**. In the **WIRELESS & NETWORKS** area, touch **More...** > **Data usage** to configure your data usage settings.

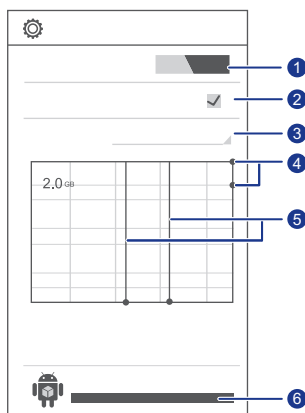

---

1

Turns the mobile data connection on or off. To configure data control and query data usage, the mobile data connection must be turned on.

---

2

Turns the mobile data usage limit on or off.

---

- 
- 3 Sets the data usage cycle.  
Touch **Data usage cycle** then **Change cycle...** to set the data usage cycle.
- 
- 4 Sets the data usage limits. The yellow line indicates the warning limit, and the red line indicates the data usage limit.  
Drag the red and yellow lines to adjust the values or touch the lines to set specific values. When your data usage reaches the yellow line, you will receive a warning notification. When your data usage reaches the red line, your phone's mobile data connection is disabled.
- 
- 5 Time axis.  
Drag the time axes to set a data usage cycle.
- 
- 6 Displays the data usage of each application.
- 

On the **Data usage** screen, touch  to open an option menu, from which you can:

- Turn data roaming on or off.
- Prevent background mobile data traffic.
- Turn automatic data synchronization on or off.
- Select the **Show Wi-Fi usage** check box. The **Wi-Fi** tab page will appear on the data usage screen. Touch the tab to view Wi-Fi data usage.
- Touch **Mobile hotspots** and select the Wi-Fi networks that are mobile hotspots to prevent applications from accessing these networks in the background. If an application is downloading a large file using these networks, you will be notified.



# Sharing data



## Bluetooth

Your phone is Bluetooth-capable, allowing you to connect to other Bluetooth-enabled devices for wireless data transmission. When you use Bluetooth, stay within 10 meters (33 feet) of other Bluetooth devices.

### Turning on Bluetooth

1. On the home screen, touch  and then the **All** tab.
2. In the **WIRELESS & NETWORKS** area, touch **Bluetooth**.

When Bluetooth is turned on, your phone's name is displayed at the top of the **Bluetooth** screen. Touch the name to set whether your phone is visible to other Bluetooth devices.

 To rename your phone, touch  > **Rename phone**. When you are done, touch **Rename** to save the changes.

### Searching for and pairing with other Bluetooth devices

To exchange data with another Bluetooth device, enable Bluetooth on both devices and pair them with each other.

1. On the home screen, touch  and then the **All** tab.
2. In the **WIRELESS & NETWORKS** area, touch **Bluetooth**.  
Your phone then scans for Bluetooth devices in range.
3. From the list of detected Bluetooth devices, touch a device and follow the onscreen instructions to pair with it.

To disconnect from other Bluetooth devices, in the **Paired devices** area, touch  > **Unpair**.

 Certain Bluetooth devices may not be compatible with each other.

## Transferring files using Bluetooth

Bluetooth enables you to conveniently send photos, videos, and other files to your family and friends. You can share files with Bluetooth-enabled devices directly without an Internet connection.

1. On the home screen, touch  .
2. Touch and hold the file you wish to send.
3. From the displayed option menu, choose **Share > Bluetooth**.
4. From the detected Bluetooth device list, select a device.

## Receiving files using Bluetooth

1. When your phone receives a file transmission request, open the notification panel.
2. Touch **Bluetooth share: Incoming file**.
3. Touch **Accept** to start receiving the file.

When the file is received, your phone displays a notification of the success. Open the notification panel to read the notification. By default, received files are saved to the **bluetooth** folder.

## DLNA

The Digital Living Network Alliance (DLNA) aims to implement intercommunication between computers and other electronic products through wired and wireless networks, providing users with seamless digital media services. DLNA enables users on the same Wi-Fi network to share multimedia files easily. Using DLNA, you can:

- Share multimedia files with your friends.
- Access multimedia files on other DLNA devices.
- Play multimedia files on other devices and control the playback.

 Before you use DLNA, ensure that your phone and other DLNA devices have connected to the same Wi-Fi network and DLNA is enabled on all devices.

On the home screen, touch **Tools** >  to display the DLNA screen. You can then share photos, videos, and songs with other DLNA devices, as well as view and download the multimedia files shared by other DLNA devices.

## Connecting your phone to a computer

When you connect your phone to a computer using a USB cable, select a USB connection type when prompted.

---

<b>Media device (MTP)</b>	Send multimedia files, such as photos, songs, and videos, between your phone and the computer.
<b>Camera (PTP)</b>	Export photos from your phone to the computer.
<b>USB storage device</b>	Use your phone as a mass storage device.



---

# File Manager

**File Manager** helps you manage files and applications in your phone's internal storage and microSD card. You can view, create, edit, delete, move, archive, compress, and decompress files.



## Creating a folder

You can create folders to better manage files stored in your phone's internal memory and microSD card.

1. On the home screen, touch .
2. Select where you wish to create the folder, namely, **Internal** or **SD card**.
3. Touch  > **New folder**.
4. In the displayed dialog box, name the new folder.
5. Touch **Save**.

## Searching for a file

Too many files stressing you out? The search function helps you find what you need in no time.

1. On the home screen, touch .
2. Select where you wish to search, namely, **Internal** or **SD card**.
3. Touch  > **Search** to enter part or all of the file name.
4. Touch  in the lower right corner of the keyboard.

## Copying or moving a file

1. On the home screen, touch .
2. Touch and hold the file you wish to copy or cut.
3. From the displayed option menu, choose **Copy** or **Cut**.
4. Select where you wish to paste the file.
5. Touch **Paste**.

## Compressing or decompressing files

You can compress files into .zip files to save space or decompress .zip and .rar files.

1. On the home screen, touch .
2. Touch and hold the file or folder you wish to compress.
3. From the displayed option menu, choose **Compress**.
4. Select the save path of the compressed file and name the file.
5. Touch **OK**.

To decompress a file, touch and hold it and choose **Extract** from the displayed option menu.

## Renaming a file

1. On the home screen, touch .
2. Touch and hold the file you wish to rename.
3. From the displayed option menu, choose **Rename**.
4. In the displayed dialog box, enter a new name for the file.
5. When you are done, touch **OK**.

## Deleting a file



1. On the home screen, touch .
2. Touch and hold the file you wish to delete.
3. From the displayed option menu, choose **Delete**.
4. Touch **OK**.

## Creating a shortcut for a file or folder

1. On the home screen, touch .
2. Touch and hold the file or folder you want to create a shortcut for.
3. From the displayed option menu, choose **Desktop shortcuts**.

## Checking the memory status

Before you put large files into your phone's internal storage or microSD card, make sure that there is enough memory.

1. On the home screen, touch .
2. Touch  > **Storage**.
3. On the **Storage settings** screen, view the total and available memory in your phone and microSD card.



# Managing applications



## Obtaining applications

Want to discover a rich collection of applications and try out the hottest games? You can either download applications from an application store, or connect your phone to a computer and copy downloaded applications from the computer.

## Installing an application

 It is recommended that you download applications from **Play Store**, because some third-party applications may not be compatible with your phone.

1. On the home screen, touch **Management** > .
2. Select the application you wish to install.
3. Touch  > **Install**.
4. Touch **Done**.

 During the installation, a **Install blocked** message may be displayed. Read the message carefully. If you want to continue with the installation, touch  then **All** > **Security**, and select the **Unknown sources** check box to allow installation of third-party applications. Then touch  to proceed.

## Viewing applications

You can view applications installed on your phone.

1. On the home screen, touch  and then the **All** tab.
2. In the **APPS** area, touch **Manage apps**.
3. Flick to **ALL**.
4. Select the application you wish to view.

## Uninstalling an application

You can uninstall unwanted applications to increase your phone's available memory.

1. On the home screen, touch  and then the **All** tab.
2. In the **APPS** area, touch **Manage apps**.
3. Flick to **ALL**.
4. Select the application you wish to uninstall.
5. Touch **Uninstall > OK**.

 Some pre-installed applications can't be uninstalled.

## Clearing the application cache

You can clear the application cache to free up some phone memory.

1. On the home screen, touch  and then the **All** tab.
2. In the **APPS** area, touch **Manage apps**.
3. Flick to **ALL**.
4. Touch **Clear cache**.



# Huawei applications

Huawei took the creative liberty to offer you a variety of useful applications, for your added convenience. A Huawei ID may be required to use these applications. If you do not have one, open one of these applications and follow the onscreen instructions to create your Huawei ID.

## Backup

**Backup** lets you back up your important data and restore them after a system upgrade or reset.

### Backing up data to local storage

1. On the home screen, touch **Management** >  .
2. Touch **Back up to SD card**.
3. Select the data you wish to back up.
4. Touch **Backup**.
5. Enter a password when prompted.
6. Touch **Backup**.

By default, backup files are saved to the **HuaweiBackup** folder in **File Manager**.

### Restoring data from local storage

1. On the home screen, touch **Management** >  .
2. Touch **Restore from SD card**.
3. From the backup file list, choose the file you wish to restore.
4. Enter the backup password.
5. Touch **OK**.
6. Touch **Restore**.

# Google services

To use Google services, you must sign in to a Google account. If you don't have one, open a Google application and follow the onscreen instructions to create your Google account.





Google applications, services, and functions vary by country and service provider. Please follow local laws and regulations when you use Google services.





## Gmail

Gmail is an email service provided by Google. When you first use Gmail, emails on your web account will be synchronized to your phone.

### Sending emails

1. On the home screen, touch **Google apps** >  to enter your mailbox.  
If you have more than one Gmail accounts, select the one you wish to use.
2. Touch .
3. Enter the recipients and subject. Compose your message.
4. When you are done, touch .



### Checking your emails

1. On the home screen, touch **Google apps** >  to enter your mailbox.  
If you have more than one Gmail accounts, select the one you wish to use.
2. From the email list, select the email you wish to read.
  - Touch  to reply to the sender.
  - Touch  > **Reply all** to reply to all.
  - Touch  > **Forward** to forward the email.

## Google Talk



Google Talk is an instant chat application provided by Google. With Google Talk, you can reach your friends using messages, or voice and video chats.

### Adding a friend

1. On the home screen, touch **Google apps** >  .
2. Touch  .
3. Enter the email address of the person you wish to add.
4. Touch  .

If the recipient accepts your invitation, he or she will appear in your friend list.

### Starting a conversation

1. On the home screen, touch **Google apps** >  .
2. From your friend list, touch the one you wish to talk to.
3. Type what you wish to say.
4. When you are done, touch  .

## Maps



Google Maps helps you find out where you are, shows you how to get to a destination, and displays real-time traffic. You can also have a satellite view of your current location or other places and check their traffic maps.

### Turning on location services

Before you use Maps to search for a location, turn on your location services.

1. On the home screen, touch  and then the **All** tab.
2. Touch **Location services**.
3. Select the **GPS satellites** check box.



## Searching for places of interest

1. On the home screen, touch  .
2. Touch  .
3. Enter the location you wish to search for.
4. Touch  .

The search results are marked on the map by letters.

5. Touch a mark to see how to get there and view more details



## Checking how to get to a place

1. When you browse a map, touch  .
  2. Touch the first text box to enter the start point. Then, touch the second text box to enter the destination.
  3. Select a transportation method: by car, public transportation, or foot.
  4. Touch **GET DIRECTIONS**.
- Available routes are then shown in a list.
5. Touch the route you prefer to display it on the map.
  6. To start a new search, touch  > **Clear Map** to clear the search results.

## YouTube

As a free online streaming media service provided by Google, YouTube lets you conveniently search for, watch, and upload videos.

### Searching for a video

1. On the home screen, touch **Google apps** >  .
2. Touch  .
3. Enter keywords.
4. Touch  in the lower right corner of the keyboard.
5. From the search results, touch a video.

## Sharing a video

From the video list, select the video you wish to share. Then, touch  to share it with your family and friends in a number of ways, for example, Bluetooth and email.



## Play Store

Play Store is application market provided by Google, where you can download applications, games, and view and update downloaded content.

### Installing an application

1. On the home screen, touch .
2. Find the desired application.
3. Follow the onscreen instructions to download and install it.

### Uninstalling an application

1. On the home screen, touch .
2. Touch  > **My apps**.
3. From the application list, touch the application you wish to uninstall.
4. Touch **Uninstall** > **OK** to uninstall the application.

# Basic utilities



Your phone comes with a variety of useful applications, such as Calendar, Clock, and Calculator, helping you keep yourself organized.

## Calendar

Always forgetting birthdays and other important events? Problem solved!

**Calendar** on your phone is a personal assistant that helps you keep track of all your important dates. You will never miss another anniversary, meeting, or appointment again.

### Creating an event

1. On the home screen, touch .
2. Touch  > **New event**.
3. Enter event details, such as the event name, time, and location.
4. Touch .

 You can also touch any date on the calendar to create an event.

### Viewing calendar events

Add calendar events to your phone and set reminders for them. You don't need to worry about forgetting important appointments any more.

1. On the home screen, touch .
2. Touch the time in the upper left corner to switch between day, week, month, agenda views.

Your calendar events are displayed in the agenda view, which lets you know your daily schedule at a glance.

## Synchronizing and viewing calendar events

Calendar events in your accounts (such as an email account) can be synchronized to and viewed on the **Calendar** application.

1. On the home screen, touch .

2. Touch  > **Calendars to display**.

 If you have an account to be synchronized to your phone, the account will be displayed in the **Calendars to display** list.

3. Touch  > **Calendars to sync**.

4. Select the accounts you want to synchronize to enable their calendar synchronization function.

## Configuring calendar settings

1. On the home screen, touch .

2. Touch  > **Settings**.

3. Follow the onscreen instructions to configure the calendar settings.

## Clock

**Clock** helps you keep track of time.

 Flick left or right on the top of the clock screen to switch between **ALARM**, **WORLD CLOCK**, **STOPWATCH**, and **TIMER**. Touch a tab to enter it.

## Adding an alarm

1. On the home screen, touch .

2. Touch .

3. Set the alarm time, sound, how often it repeats, and more.



4. Touch **OK**.

 Enabled alarms will go off even when your phone is powered off.

## Deleting an alarm

1. On the home screen, touch .
2. From the alarm list, touch and hold the unwanted alarm.
3. From the displayed option menu, choose **Delete alarm**.
4. Touch **OK**.

## Configuring alarm settings

1. On the home screen, touch .
2. From the alarm list, touch .
3. Change the alarm sound, volume, how often it repeats, and more.



## Calculator

Need to make a calculation on the go? Your phone can work as a calculator.

1. On the home screen, touch **Tools** > .
2. On the **Calculator** screen, flick left or right to switch between **Advanced panel** and **Basic panel**.

## Notes

**Notes** lets you record your thoughts anytime, anywhere.

1. On the home screen, touch **Tools** > .
2. Touch  to create a note.
3. Touch  to save the note.

 To delete one or more notes, touch  on the **Notes** screen, and touch **OK**. To delete all notes, touch **SELECT ALL** and then **OK**.





## Weather

**Weather** lets you check the date and time at cities around the world, get the latest weather information in any cities, and share the information with your family and friends.

 Before you use **Weather**, turn on your phone's GPS and data services.

### Adding a city



You can add cities where your family and friends live to **Weather Clock**.

1. On the home screen, touch **Tools** > .
2. Touch  > .



 Apart from your current city, you can add up to nine cities.

3. Enter a city name.  
Your phone displays matching cities as you type.
4. Touch a city to add it.

### Setting the default city

1. On the home screen, touch **Tools** > .
2. Touch  > .
3. Touch the city you wish to set as the default city.



### Deleting a city

1. On the home screen, touch **Tools** > .
2. Touch  > .
3. Select the unwanted city and touch **DELETE**.

### Updating weather





1. On the home screen, touch **Tools** > .
2. Flick left or right to find the city whose weather you wish to update.

3. Touch  to update the weather.

 You can also set **Weather** to automatic update mode. Touch  > , select **Auto update**, and set **Update interval**. Your phone will then update the weather at the interval you set.

## Sharing weather information

Your phone lets you send weather information as a text message to remind your family and friends of weather changes.



1. On the home screen, touch **Tools** > .
2. Flick left or right to find the city whose weather you wish to share.
3. Touch  to create a text message.
4. You can then:
  - Enter a phone number.
  - Touch  to select a contact.
5. Touch 1 or 2 to send weather information to the recipient.

## FM radio

Want to listen to your favorite broadcast programs? Use your phone as a radio.

 Connect a headset to the phone because the FM radio uses the headset as its antenna.

## Searching for stations

1. On the home screen, touch **Tools** > .
2. Perform either of the following operations:
  - If you use the FM radio on your phone for the first time, touch **Auto tuning** to have your phone search for and save available stations.
  - If you are not the first time to use the FM radio on your phone, touch  and then **Auto tuning** to have your phone search for and save available stations.

## Listening to FM radio

On the FM radio screen, you can:

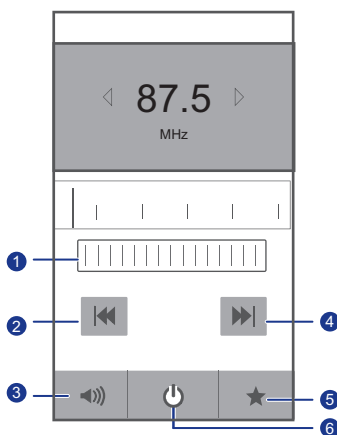

- 
- 1 Slide left or right to fine tune the radio.

---

  - 2 Touch  to return to the previous station.

---

  - 3 Touch  to enable or disable the speaker.

---

  - 4 Touch  to go to the next station.

---

  - 5 Touch  to display the station list.

---

  - 6 Touch  to turn the FM radio on or off.

---

# Accounts and synchronization

You can synchronize data on your phone, such as contacts, emails, and events, to and from the web.



## Adding an account

1. On the home screen, touch  and then the **All** tab.
2. In the **ACCOUNTS** area, touch **Add account**.
3. Select an account type.
4. Follow the onscreen instructions to enter your account information.
5. Configure the account and set the type of data you wish to synchronize.

When an account is set up, it appears in the **ACCOUNTS** area.



-  The types of data you can set to synchronize to your phone vary by account type.

## Deleting an account

1. On the home screen, touch  and then the **All** tab.
2. In the **ACCOUNTS** area, select an account type.
3. Select the account you wish to delete.
4. Touch  > **Remove account**.
5. In the displayed dialog box, touch **Remove account**.

## Turning on data synchronization

1. On the home screen, touch  and then the **All** tab.
2. In the **ACCOUNTS** area, select an account type.
3. Select the account you wish to synchronize.
4. Touch **Sync Email** to turn on data synchronization.

 You can touch  > **Sync now** to have the account synchronize data from the web in the background.

## Modifying account synchronization settings

1. On the home screen, touch  and then the **All** tab.
2. In the **ACCOUNTS** area, select an account type.
3. Select the account whose synchronization settings you wish to modify.  
The **Sync settings** area displays data you can synchronize.
4. Select the data you wish to synchronize.

# Settings

## Turning on or off airplane mode

Your phone's signal reception or transmission may interfere with an airplane's flight system. Power off your phone or switch to airplane mode as required when you are on a flight.

In airplane mode, your phone's wireless features are disabled, but you can still listen to music or play games using your phone.

Use either of the following methods to turn on or off **Airplane mode**:

- Press and hold the power button. From the displayed option menu, choose **Airplane mode**.
- On the home screen, touch  and then the **All** tab. In the **WIRELESS & NETWORKS** area, turn on or off airplane mode.

When airplane mode is on,  appears in the status bar.

## Tone settings

1. On the home screen, touch  and then the **All** tab.
2. In the **DEVICE** area, touch **Sound**. On the settings screen, you can:
  - Touch **Volume** and drag the sliders to set the volumes of music, ringtone, message notification tone, and more.
  - Touch **Vibration** to set whether your phone vibrates when you have an incoming call, new message, new email, upcoming event.
  - Touch **Silent mode** to turn silent mode on or off.
  - Touch **SIM 1 ringtone** or **SIM 2 ringtone** to select a ringtone.
  - Touch **Notification tone** to select a tone for a new message, new email, upcoming event, and more.
  - Touch **DTS mode** to turn the DTS sound effect on or off.
  - Touch **System** to turn the notification tone or vibration on or off when you touch or lock the screen, take a screenshot, dial a number, and more.

-  To adjust the volume, you can press the volume buttons from the home screen or most application screens (for example, the call, music, and video playback screens).

## Display settings

1. On the home screen, touch  and then the **All** tab.
2. In the **DEVICE** area, touch **Display**.
3. Perform any of the following operations:
  - Touch **Brightness** to set the screen brightness. To manually adjust the screen brightness, clear the **Automatic brightness** check box.
  - Touch **Auto-rotate screen** to turn the auto-rotate screen function on and off. With this function enabled, if you rotate your phone when browsing a web page, viewing an image, or writing a message, your screen orientation will automatically change to landscape or portrait view.
  - Touch **Sleep** to set a screen timeout period. If idle for the specified period of time, your phone automatically locks its screen to save battery power.
  - Touch **Font size** to change the display font size.

## Setting the PIN of your SIM card

The personal identification number (PIN) is delivered with your SIM card. If you enable the PIN protection function for your SIM card, you will need to enter the PIN each time you power your phone on.

Before you perform the following operations, make sure that you have obtained your SIM card's PIN from your service provider.

1. On the home screen, touch  then the **All** tab.
2. Under **PERSONAL**, touch **Security**.
3. Touch **Set Card 1/Card 2 lock**.
4. On the **CARD 1** or **CARD 2** tab, select the **Lock SIM card** check box.
5. Enter the PIN.
6. Touch **OK**.

-  If you incorrectly enter the PIN a specified number of consecutive times, the PIN is blocked and the phone prompts you to enter the PIN unblocking key (PUK). If you incorrectly enter the PUK a specified number of consecutive times, the SIM card will be disabled permanently. For details about the maximum retry attempts for the PIN and PUK, contact your service provider.

## Setting the date and time

By default, your phone uses the network date and time. You can also manually set the date and time.

1. On the home screen, touch  and then the **All** tab.
2. In the **SYSTEM** area, touch **Date & time**.
3. On the settings screen, perform any of the following operations:
  - Clear the **Automatic date & time** check box to stop your phone from automatically obtaining the network date and time.
  - Clear the **Automatic time zone** check box to stop your phone from automatically obtaining the time zone from the network.
  - Touch **Set date** and flick up and down to set your phone's date.
  - Touch **Set time** and flick up and down to set your phone's time.
  - Touch **Select time zone** and select the time zone you want from the list. Scroll up or down to view more time zones.
  - Select or clear the **Use 24-hour format** check box to switch between 12-hour and 24-hour formats.
  - Touch **Select date format** to select how you want the date to be displayed.

## Changing the system language

1. On the home screen, touch  and then the **All** tab.
2. In the **PERSONAL** area, touch **Language & input**.
3. Touch **Language**.
4. From the list, choose a language.





## Modifying location service settings

You can modify your phone's location service settings for more convenient positioning and navigation services.

1. On the home screen, touch  and then the **All** tab.
2. In the **PERSONAL** area, touch **Location services**.
3. Perform any of the following operations:
  - Touch **Access to my location** to let applications use your location information.
  - Touch **GPS satellites** to have your phone obtain your location information from GPS satellites.
  - Touch **Use Quick GPS** to let GPS use accessibility data for functionality improvement.

## Turning on or off fast boot

1. On the home screen, touch  and then the **All** tab.
2. In the **SYSTEM** area, turn on or off **Fast boot**.

 When fast boot is on, your phone does not power off. Instead, it enters deep sleep mode when you try to power it off. This may interfere with an airplane's flight system, so please turn off fast boot when you are on a flight.

## Restoring to factory settings

Restoring your phone to its factory settings erases all your personal data from the phone memory, including your email accounts, system and application settings, and installed applications. Back up important data before the restoration.

1. On the home screen, touch  and then the **All** tab.
2. In the **PERSONAL** area, touch **Backup & reset**.
3. Touch **Factory data reset > Reset phone > Reset phone**.  
The phone will be restored to its factory settings and restart.

 To back up important data on your phone before restoring factory settings, on the **Settings** screen, touch **Backup & reset**, and select the **Back up my data** check box.

## Online update

Once in a while, new updates for your phone will be available online. You will receive a notification when updates are available. Before performing the update, make sure that your microSD card has enough storage space for the update package.

To update manually, on the home screen, touch  > **About phone** > **System updates** > **Online update** to check for updates and follow the onscreen instructions to update your phone online.

## Accessibility

You can turn on or off preset or installed accessibility features.







1. On the home screen, touch  and then the **All** tab.
2. In the **SYSTEM** area, touch **Accessibility**.
3. Select the desired feature.

## FAQs

### How can I free up additional phone memory?

- Move files and email attachments from your phone memory to your microSD card.
- Open the **Browser** application, and delete locally cached content.
- Uninstall applications you no longer use.
- Restore your phone to its factory settings.

### How can I save battery power?

- When you do not need Internet access, open the notification panel and touch  to turn off your mobile data connection.
- When you do not need to use wireless data services, such as GPS, Bluetooth, or Wi-Fi, open the notification panel, and touch , , or  to turn off these services.
- Touch  > **All** > **Display** > **Brightness** to reduce the screen brightness and screen timeout period. Turn off the screen (press ) when your phone is not in use.
- Close applications that are not in use.
- Decrease tone volumes.

### How can I use a microSD card to import contacts from another phone?

Your phone supports contact files in .vcf format only.

1. Save the contacts you want to import as a .vcf file and save the file to a microSD card.
2. Insert the microSD card into your phone. Touch **File Manager** then **SD card** to find the .vcf file.
3. Touch the .vcf file. The phone displays a message asking whether you want to import the contacts.
4. Touch **OK** to import the contacts.

 Compatibility problems may occur with .vcf files created by other phones and certain contact information may be lost during the import.

### How can I disable the Auto-rotate screen function?

On the home screen, touch  then **All > Display**, and clear **Auto-rotate screen**.

### How can I set a screen unlock pattern?

On the home screen, touch , and then touch **General > Screen lock > Screen lock > Pattern**, and follow the onscreen instructions to set a screen unlock pattern.

### How can I switch the input method?

When you write text, open the notification panel and touch **Choose input method** to select the input method you want.

### How can I stop the song playing in the background?

Open the notification panel, touch the playing song to display the music playback screen, and touch .

### How can I return to the call screen?

To return from another screen, open the notification panel, and touch the ongoing call.

### How can I move an application icon on the home screen?

On the screen, touch and hold the application icon you want to move, and drag it to a new position.

### How can I hide the onscreen keyboard?

Touch  to hide the keyboard.

### How can I forward a message?

Touch and hold the message you want to forward, and choose **Forward** from the displayed option menu.

### How can I restart my phone?

Press and hold , and touch **Restart > OK** to restart your phone.



# Legal notice

Copyright © Huawei Technologies Co., Ltd. 2013. All rights reserved.

No part of this manual may be reproduced or transmitted in any form or by any means without prior written consent of Huawei Technologies Co., Ltd. and its affiliates (“Huawei”).

The product described in this manual may include copyrighted software of Huawei and possible licensors. Customers shall not in any manner reproduce, distribute, modify, decompile, disassemble, decrypt, extract, reverse engineer, lease, assign, or sublicense the said software, unless such restrictions are prohibited by applicable laws or such actions are approved by respective copyright holders.

## Trademarks and permissions

 , HUAWEI, and  are trademarks or registered trademarks of Huawei Technologies Co., Ltd.

Android™ is a trademark of Google Inc.

The *Bluetooth*® word mark and logos are registered trademarks owned by *Bluetooth SIG, Inc.* and any use of such marks by Huawei Technologies Co., Ltd. is under license.

Other trademarks, product, service and company names mentioned may be the property of their respective owners.

## Notice

Some features of the product and its accessories described herein rely on the software installed, capacities and settings of local network, and therefore may not be activated or may be limited by local network operators or network service providers. Thus, the descriptions herein may not exactly match the product or its accessories which you purchase.

Huawei reserves the right to change or modify any information or specifications contained in this manual without prior notice and without any liability.

## Third-Party software statement

Huawei does not own the intellectual property of the third-party software and applications that are delivered with this product. Therefore, Huawei will not provide any warranty of any kind for third party software and applications.

Neither will Huawei provide support to customers who use third-party software and applications, nor be responsible or liable for the functions or performance of third-party software and applications.

Third-party software and applications services may be interrupted or terminated at any time, and Huawei does not guarantee the availability of any content or service. Third-party service providers provide content and services through network or transmission tools outside of the control of Huawei. To the greatest extent permitted by applicable law, it is explicitly stated that Huawei shall not compensate or be liable for services provided by third-party service providers, or the interruption or termination of third-party contents or services.

Huawei shall not be responsible for the legality, quality, or any other aspects of any software installed on this product, or for any uploaded or downloaded third-party works in any form, including but not limited to texts, images, videos, or software etc. Customers shall bear the risk for any and all effects, including incompatibility between the software and this product, which result from installing software or uploading or downloading the third-party works.

This product is based on the open-source Android™ platform. Huawei has made necessary changes to the platform. Therefore, this product may not support all the functions that are supported by the standard Android platform or may be incompatible with third-party software. Huawei does not provide any warranty and representation in connect with any such compatibility and expressly excludes all liability in connection with such matters.

## DISCLAIMER

ALL CONTENTS OF THIS MANUAL ARE PROVIDED “AS IS”. EXCEPT AS REQUIRED BY APPLICABLE LAWS, NO WARRANTIES OF ANY KIND, EITHER EXPRESS OR IMPLIED, INCLUDING BUT NOT LIMITED TO, THE IMPLIED WARRANTIES OF MERCHANTABILITY AND FITNESS FOR A PARTICULAR PURPOSE, ARE MADE IN RELATION TO THE ACCURACY, RELIABILITY OR CONTENTS OF THIS MANUAL.

TO THE MAXIMUM EXTENT PERMITTED BY APPLICABLE LAW, IN NO EVENT SHALL HUAWEI BE LIABLE FOR ANY SPECIAL, INCIDENTAL, INDIRECT, OR CONSEQUENTIAL DAMAGES, OR LOSS OF PROFITS, BUSINESS, REVENUE, DATA, GOODWILL SAVINGS OR ANTICIPATED SAVINGS REGARDLESS OF WHETHER SUCH LOSSES ARE FORSEEABLE OR NOT.

THE MAXIMUM LIABILITY (THIS LIMITATION SHALL NOT APPLY TO LIABILITY FOR PERSONAL INJURY TO THE EXTENT APPLICABLE LAW PROHIBITS SUCH A LIMITATION) OF HUAWEI ARISING FROM THE USE OF THE PRODUCT DESCRIBED IN THIS MANUAL SHALL BE LIMITED TO THE AMOUNT PAID BY CUSTOMERS FOR THE PURCHASE OF THIS PRODUCT.

#### Import and export regulations

Customers shall comply with all applicable export or import laws and regulations and be responsible to obtain all necessary governmental permits and licenses in order to export, re-export or import the product mentioned in this manual including the software and technical data therein.

#### Privacy policy

To better understand how we protect your personal information, please see the privacy policy at <http://consumer.huawei.com/en/privacy-policy/index.htm>.



Manufactured under license from DTS Licensing Limited. DTS, the Symbol, & DTS and the Symbol together are registered trademarks & DTS Envelo | Headphone is a trade-mark of DTS, Inc. Product includes software. © DTS, Inc. All Rights Reserved.

This guide is for reference only. The actual product, including but not limited to the color, size, and screen layout, may vary. All statements, information, and recommendations in this guide do not constitute a warranty of any kind, express or implied.

Please visit [www.huaweidevice.com/worldwide/support/hotline](http://www.huaweidevice.com/worldwide/support/hotline) for recently updated hotline and email address in your country or region.

Model: HUAWEI G525-U00

V100R001\_01