













## Safety Precautions

Before using the phone, read safety precautions and inform your children about using the phone correctly and safely. For details, see "Warnings and Precautions" on page 44.

	Do not switch on your phone when using the phone is prohibited or when using the phone may cause interference or danger.
	Do not use your phone while driving.
	Follow the rules or regulations set forth by the hospitals and health care facilities. Switch off your phone near medical apparatus.
	Switch off your phone in an aircraft. The phone may cause interference to control signals of the aircraft.
	Switch off your phone near high-precision electronic devices. The phone may affect the performance of these devices.
	Do not attempt to disassemble your phone or its accessories. Only qualified personnel are allowed to service or repair the phone.
	Do not place your phone or the accessories in containers with strong electromagnetic field.
	Do not place magnetic storage media near your phone. Radiation emitted from the phone may erase the information stored on the magnetic storage media.
	Do not place your phone in a high-temperature place or where it can come in contact with flammable gas, such as a gas station.
	Keep your phone and its accessories away from children. Do not allow children to use your phone without guidance.
	Use only approved batteries and chargers to avoid explosion.
	Observe the laws or regulations on using the phone. Respect others' privacy and legal rights when using your phone.

## **Copyright © Huawei Technologies Co., Ltd. 2010. All rights reserved.**

No part of this document may be reproduced or transmitted in any form or by any means without prior written consent of Huawei Technologies Co., Ltd.

The product described in this manual may include copyrighted software of Huawei Technologies Co., Ltd and possible licensors. Customers shall not in any manner reproduce, distribute, modify, decompile, disassemble, decrypt, extract, reverse engineer, lease, assign, or sublicense the said software, unless such restrictions are prohibited by applicable laws or such actions are approved by respective copyright holders under licenses.

## **Trademarks and Permissions**



**HUAWEI**, HUAWEI, and



are trademarks or registered trademarks of Huawei Technologies Co., Ltd.

Other trademarks, product, service and company names mentioned are the property of their respective owners.

## **Notice**

Some features of the product and its accessories described herein rely on the software installed, capacities and settings of local network, and may not be activated or may be limited by local network operators or network service providers, thus the descriptions herein may not exactly match the product or its accessories you purchase.

Huawei Technologies Co., Ltd reserves the right to change or modify any information or specifications contained in this manual without prior notice or obligation.

## **NO WARRANTY**

THE CONTENTS OF THIS MANUAL ARE PROVIDED "AS IS". EXCEPT AS REQUIRED BY APPLICABLE LAWS, NO WARRANTIES OF ANY KIND, EITHER EXPRESS OR IMPLIED, INCLUDING BUT NOT LIMITED TO, THE IMPLIED WARRANTIES OF MERCHANTABILITY AND FITNESS FOR A PARTICULAR PURPOSE, ARE MADE IN RELATION TO THE ACCURACY, RELIABILITY OR CONTENTS OF THIS MANUAL.

TO THE MAXIMUM EXTENT PERMITTED BY APPLICABLE LAW, IN NO CASE SHALL HUAWEI TECHNOLOGIES CO., LTD BE LIABLE FOR ANY SPECIAL, INCIDENTAL, INDIRECT, OR CONSEQUENTIAL DAMAGES, OR LOST PROFITS, BUSINESS, REVENUE, DATA, GOODWILL OR ANTICIPATED SAVINGS.

## **Import and Export Regulations**

Customers shall comply with all applicable export or import laws and regulations and will obtain all necessary governmental permits and licenses in order to export, re-export or import the product mentioned in this manual including the software and technical data therein.

# Table of Contents

<b>1 Getting to Know Your Phone .....</b>	<b>1</b>
Your Phone.....	1
Keys and Functions.....	2
Screen Icons .....	4
<b>2 Getting Started .....</b>	<b>6</b>
Installing the Battery.....	6
Charging the Battery .....	6
Powering On/Off the Phone.....	7
Using the Stylus .....	7
Dragging and Flicking .....	8
Standby Screen.....	9
<b>3 Voice Services .....</b>	<b>11</b>
Making a Call.....	11
Answering a Call.....	11
Hearing Aid Mode.....	12
Operations During a Call .....	13
<b>4 Text Entry.....</b>	<b>15</b>
On-Screen Keyboard Mode .....	15
<b>5 SMS .....</b>	<b>16</b>
Writing and Sending a Message .....	16
Reading a Message .....	17

<b>6 MMS</b> .....	<b>18</b>
Writing and Sending a Multimedia Message.....	18
Receiving a Multimedia Message.....	18
Viewing a Multimedia Message .....	19
<b>7 Contacts</b> .....	<b>20</b>
Adding a Contact .....	20
Searching for a Contact.....	20
<b>8 @metro App Store<sup>SM</sup></b> .....	<b>22</b>
Accessing @metro App Store <sup>SM</sup> .....	22
Changing Your @metro App Store <sup>SM</sup> Settings .....	23
Using On-line Help .....	23
<b>9 Alarm Clock</b> .....	<b>26</b>
Enabling an Alarm Clock.....	26
Disabling an Alarm Clock.....	26
<b>10 Music Player</b> .....	<b>27</b>
Adding a Playlist.....	27
Playing Music .....	27
<b>11 Camera</b> .....	<b>31</b>
Taking a Picture .....	31
Viewing a Picture.....	32
Taking Pictures Sequentially .....	34
Taking a Picture in Self-Timer Mode .....	34
Setting a Picture Effect .....	34

<b>12 Security</b> .....	<b>35</b>
Enabling or Disabling the Phone Lock.....	35
Changing the Phone Lock Code .....	35
Locking the Keypad.....	36
<b>13 Bluetooth® Connection</b> .....	<b>37</b>
Sending Data Through a Bluetooth® Connection.....	37
Receiving Data Through a Bluetooth® Connection.....	38
Listening to Music Through a Bluetooth® Stereo Headset .....	39
Sending a Contact Through a Bluetooth® Connection .....	40
Other Bluetooth® Operations .....	40
<b>14 TTY Operation</b> .....	<b>41</b>
Using the TTY Device .....	41
Setting the TTY Mode .....	41
<b>15 Troubleshooting</b> .....	<b>42</b>
<b>16 Warnings and Precautions</b> .....	<b>44</b>
<b>17 Futurewei Technologies, Inc. Limited Warranty</b> .....	<b>53</b>

# 1 Getting to Know Your Phone

## Your Phone

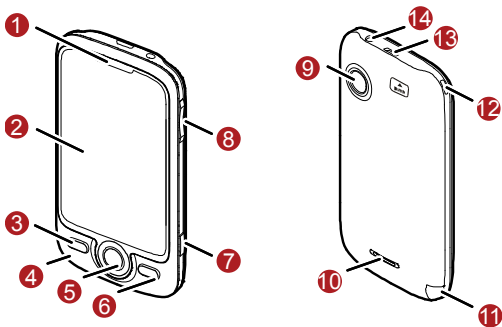





The preceding figure is provided for your reference only.





1	Earpiece	8	Volume Keys
2	Screen	9	Camera
3	Talk/Send Key	10	Speaker
4	Microphone	11	Stylus Pen

5	Navigation	12	Strap Hole
6	End/Power Key	13	Charger Interface/Data Cable Connector
7	Camera Key	14	Headset Jack













## Keys and Functions













Press ...	To ...
	<ul style="list-style-type: none"> <li>● Access the all calls menu in standby mode.</li> <li>● Dial a number or answer a call.</li> </ul>
	<ul style="list-style-type: none"> <li>● Power on or power off the phone by pressing and holding the key.</li> <li>● End a call or reject a call.</li> <li>● Return to the standby screen.</li> <li>● Turn on or turn off the screen backlight in standby mode.</li> </ul>
	<p>: Access <b>Contacts</b> in standby mode; increase the volume during a call.</p> <p>: Access the <b>Messages</b> menu in standby mode; access the screen for writing a message by pressing and holding the key; decrease the volume during a call.</p>



Press ...	To ...
	 : Press the left or right navigation key to switch between the screens.
	<ul style="list-style-type: none"> <li>● Access the main menu in standby mode.</li> <li>● Confirm a selection in menu mode.</li> <li>● Start playing music after the music player is launched.</li> </ul>
	Increase the volume in standby mode or during a call and music playing.
	Decrease the volume in standby mode or during a call and music playing.
	<ul style="list-style-type: none"> <li>● Launch the camera in standby mode by pressing the key.</li> <li>● Take a picture after the camera is launched.</li> </ul>

## Screen Icons

Icon	Description
	Indicates the signal strength. The more the bars are, the stronger the signal is.
	Incoming call; a call is being set up; or the phone is in conversation.
	Voice privacy function is enabled.
	Phone is in the roaming status.
	New message is received.
	Memory for messages is full.
	Urgent message is received.
	New voice mail is received.
	New PUSH message is received.
	PUSH message is full.
	New MMS is received.
	MMS is full.

Icon	Description
	microSD Card.
	AGPS indicator mode is <b>Location On</b> .
	Alert type is <b>Ring</b> .
	Alert type is <b>Ring and Vibrate</b> .
	Alert type is <b>Vibrate Only</b> .
	Alert type is <b>Silence</b> .
	An alarm clock is set.
	Indicates the battery power level.
	Battery power level is extremely low.
	Bluetooth <sup>®</sup> function is activated.
	Phone is receiving data through Bluetooth <sup>®</sup> .
	Phone is sending data through Bluetooth <sup>®</sup> .
	Bluetooth <sup>®</sup> headset is activated.

## 2 Getting Started

### Installing the Battery

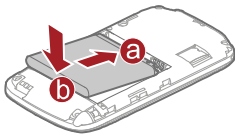

### Charging the Battery

To charge the battery, do as follows:

1. Connect the travel charger to the charger interface at the top of your phone.
2. Connect the charger to an AC power socket.  
During the charging process, the icon on the upper right corner of the screen is in an animated status.
3. Wait until the phone is completely charged.  
If the icon becomes static, the battery is completely charged.
4. Disconnect the charger from the AC power socket.
5. Disconnect the charger from the phone.



- Do not use a damaged battery or charger.
- Before using the travel charger, ensure that the battery is installed in your phone.

## Powering On/Off the Phone

To power on the phone, press and hold  until the screen backlight is on.

To power off the phone, press and hold  until the power-off prompt is displayed.

## Using the Stylus

You can use the stylus to select an item by tapping on the touchscreen of your phone.

### Stylus Operations

To perform an operation with the stylus, you can do as follows:

- Tap: Select an item or display a menu by touching the stylus to the screen.
- Drag: Select multiple characters in on-screen keyboard mode or move an object by moving the stylus on the screen.

### Screen Calibration

When operating the phone with the stylus, if the phone cannot respond to your operation correctly, you can calibrate the screen as follows:

- Tap **Settings > Display Settings > Screen Calibration** to access the screen for calibration.
- Calibrate the screen by tapping the center of + displayed on the screen according to the instructions.

- 📖 During the calibration, tap the center of + accurately, to ensure that the phone can respond to your tap and text entry on the screen correctly after the calibration.

## Dragging and Flicking

On following screens, you can perform some operations conveniently through dragging on the touchscreen:



- On the standby screen, tap and drag the title, clock, or date to change the position of the selected item.
- In the menu list, drag up or down to scroll. Then tap a submenu to select it.
- When viewing pictures, flick right or left to switch a picture to the next or previous one.

- 📖 The resolution of the phone screen is  $240 \times 320$ . Therefore, when viewing pictures, a picture with a resolution higher than  $240 \times 320$  may be displayed improperly.

# Standby Screen



## Description

- 1 The icons indicating the status, such as the signal strength, battery level, and current profile are displayed.
- 2
  - By default, the name of the network operator is displayed.
  - Tap **Settings** > **Display Settings** > **Banner** to change the title content.
- 3 Tap it to access the widget bar. You can drag a widget to the desktop or drag it back to the widget bar.
  - Tap  to access the dialer.
- 4
  - Tap  to access **Messages**.
  - Tap  to access the main menu.









## Description

- Tap  to lock the keypad.
-









## 3 Voice Services

### Making a Call

1. In standby mode, tap  to access the dialer.
2. Enter the phone number on the dialer.
  - For international calls, tap \* twice consecutively to enter the plus sign (+). Then enter the country or region code, area code, and phone number in sequence.
  - For extension numbers, enter the phone number, tap \* three or four times consecutively to enter **P** or **T**, and then enter the extension number.
3. Press  or tap  to dial the number.
4. Press  or tap  to end the call or cancel the dialing.
  -  In standby mode, you can press  to view call logs. Then select a number and press  to dial the number.

### Answering a Call

- When there is an incoming call, you can press  or , or tap  to answer the call; press  or tap  to reject the call.
- When the any-key answer function is enabled, you can press any key (except  and ) to answer the call.

- When the **Headset Auto Answer** function is enabled and the headset is properly connected to the phone, the phone answers the call automatically.

 You can set the any-key answer function in the **Settings > Call Settings > Answer Mode**, and set the headset auto-answer function in the **Settings > Call Settings > Headset Auto Answer**.

## Hearing Aid Mode

Your phone supports the T-Coil function. To enable the function, tap **Settings > Phone Settings > Hearing Aid Mode > On**. Then your phone can meet the requirements specified in T3 of Hearing Aid Compatibility (HAC).

-  ● The voice quality during a call may be affected when the T-Coil function is enabled.
- After the T-Coil function is enabled, ensure that Bluetooth<sup>®</sup> is turned off during a call.

# Operations During a Call

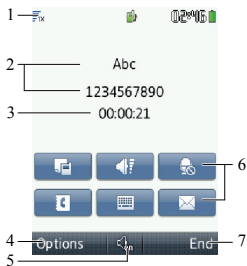

## Description

1 The icons indicating the status, such as the signal strength, battery level, and current profile, and the current time are displayed.

2 The contact name and the number of an ongoing call are displayed.

3 Call duration is displayed.







Select **Options** for the following options:

- **Mute:** Mute the microphone.
- **Save Number:** Save the number to contacts.
- **Contacts:** Search for or create a contact.
- **SMS:** Access the **SMS** menu.
- **Memo:** Write information during a call.

## Description

- **Voice Privacy:** Enable voice encryption.
- **TTY Setup:** Setting the TTY mode.

5 Tap this icon to switch between the hands-free mode and the hand-held mode.

- 6
- Tap  to access the **Memo** menu.
  - Tap  to access the screen for adjusting the volume.
  - Tap  to mute the microphone.
  - Tap  to access the **Contacts** menu.
  - Tap  to display the on-screen keyboard.
  - Tap  to access the **SMS** menu.

7 Select **End** to end the call.

## 4 Text Entry

### On-Screen Keyboard Mode

The phone supports two types of on-screen keyboards: QWERTY keyboard and numeric keypad.

You can tap  and  to switch between the QWERTY keyboard and the numeric keypad.

In on-screen keyboard mode, one of the following bar is displayed at the bottom of the screen.









- Tap keys on the on-screen keyboard to enter corresponding letters, numbers, or symbols.
- Tap  to enter numbers or symbols through the on-screen keyboard.

# 5 SMS

## Writing and Sending a Message

To write and send a text message, do as follows:

1. Select **Messages > SMS > Create Message**, or press and hold  in standby mode.
2. Write a message and then select **Options** for the following options:
  - **Send**: Send the message.
  - **Save**: Save the message to **Drafts**.
  - **Copy**: Select **Mark and Copy** or **Copy All** to copy the desired text.
  - **Insert Quick Text**: Insert a commonly used phrase into the message.
  - **Insert Contact**: Select a contact from the phonebook and insert the phone number into the message.
  - **Insert Shortcut**: Insert a preset website-related symbol into the message.
  - **Priority**: Set the message priority that can be **Normal**, **Urgent**, or **Emergency**.
  - **Callback Number**: Set the callback number. The callback number will be sent to the message recipient with the message. You can set it to either your phone number or another number. After receiving your message, the recipient can call you back through the callback number.
3. Select **Options > Send** or tap  to add the recipient(s) of the message. Up to 10 recipients can be added by using one of the following methods:

- Enter the phone number(s) of the recipient(s) directly.
  - Select **Options** > **Search Contacts** or tap  to select the recipients from the phonebook.
  - Select **Options** > **Search Groups** or tap  to select a group of recipients.
4. Press ,  or tap  to send the message.

## Reading a Message

**Inbox** stores the received text messages. To read a text message in the inbox, do as follows:

1. Select **Messages** > **SMS** > **Inbox**.
2. Select **Options** > **View** or tap  to select and read the desired message.
3. Select **Options** for the following options:
  - **Reply**: Write a new text message to reply to the message sender.
  - **Delete**: Delete the message.
  - **Forward**: Forward the message.
  - **Extract Number**: Extract the number(s) contained in the message.
  - **Extract URL**: Extract the URL address(es) contained in the message.
  - **Extract Email**: Extract the email address(es) contained in the message.
  - **Lock/Unlock**: When a text message is saved in the phone memory, you can lock the message to prevent it from being deleted. To unlock the message, you can select **Unlock**.

# 6 MMS

## Writing and Sending a Multimedia Message

To write and send a multimedia message, do as follows:

1. Select **Messages > MMS > Create Message**.
2. Edit the message by adding contents to the following fields:
  - **To:** Add the recipient(s) of the message. Up to 10 recipients can be added.
  - **Sub:** Enter the subject of the message.
  - **Text field & Media field:** Insert pictures, audio files, and text into a slide.
3. After you write the message, select **Options > Send** to send the message.

 The MMS function is network dependent. If you cannot send or receive multimedia messages, contact your service provider.

## Receiving a Multimedia Message

If you select **Messages > MMS > Settings > Receive Settings > Retrieval Mode > Manual**, a message notification will be received and saved in the inbox before you receive a multimedia message. In this case, access the inbox, select the message notification, and then download the multimedia message according to the on-screen instructions.

If you select **Messages > MMS > Settings > Receive Settings > Retrieval Mode > Automatic**, the phone will automatically download a multimedia message to the inbox.



## Viewing a Multimedia Message

**Inbox** stores the received multimedia messages. To view a multimedia message in the inbox, do as follows:

1. Select **Messages > MMS > Inbox**.

2. Press  to select a message.

3. Select **Options** for the following options:



- **Reply:** Write a new message to reply to the message sender.
- **Replay All:** Write a new multimedia message to reply to the message sender and all other message recipients.
- **Forward:** Forward the message.
- **Delete:** Delete the message.
- **Create Message:** Write a new message.
- **Call:** Call the recipient, or edit the recipient's number and then dial the number.
- **Delete Multiple:** Delete multiple multimedia messages at a time.
- **Sort By:** Sort the messages in the inbox according to date, sender, read/unread or message type.
- **Message Details:** View details of the message.

4. Press  to view the contents of the message.

# 7 Contacts

## Adding a Contact

To add a contact to the phonebook, do as follows:

1. Select **Contacts** > **Add New**.
2. Enter the information about the contact. Information can be entered in the following fields, including **Name**, **Mobile Number**, **Home Number**, **Office Number**, **Fax Number**, **E-mail**, **Group**, **Notes**, **Custom Tone**, **Custom Image**, and **URL**. (For each contact, at least one number needs to be entered.)
3. Press  to scroll to the desired field and then press , or directly tap the desired field to select it.
4. Enter the corresponding information with the stylus.
5. Save or cancel the edit of the contact.
  - Select **Save** or tap  to save the contact to the phonebook.
  - Select **Cancel**, and then select **Yes** or **No** to cancel or continue with the edit of the contact.

## Searching for a Contact

To search for a contact, do as follows:

1. Select **Contacts** > **Search**.
2. Enter the name of the contact. Then select **Search**.
3. After the contact is found, select **Options** for the following options:

- **View:** View details of the contact.
- **Edit:** Edit the contact, such as changing the name, number, or other fields of the contact.
- **Add New:** Add a new contact.
- **Send Message:** Edit and send a text or multimedia message to the contact.
- **Send Vcard:** Send the contact information through Bluetooth<sup>®</sup> or multimedia message.
- **Delete:** Delete the contact.
- **Call:** Call the contact.
- **Edit Before Call:** Edit the number before you call it.

## 8 @metro App Store<sup>SM</sup>

With @metro App Store<sup>SM</sup>, you can download full featured applications over the air including games, personalized ring tones, pictures, and more. You can send and receive instant messages and email, or browse the web to catch up on all the latest news.

This section outlines how to obtain games and other applications for your phone. For more information about this function, consult your service provider.

### Accessing @metro App Store<sup>SM</sup>

#### Applications Shopping and Downloading

Download games, ring tones, e-mail, and more using the @metro App Store<sup>SM</sup>. For information on airtime charges, consult your service provider.

1. In the standby mode, select **@metro App Store**.
2. Press  to select the @metro App Store<sup>SM</sup>, then press . Your phone takes a moment to connect, then the @metro App Store<sup>SM</sup> Catalog menu appears in the display.





 The first time you access the @metro App Store<sup>SM</sup>, an "airtime warning" message appears in the display along with instructions on how to remove this message.

3. Follow the instructions in your phone's display.

 Please check with your Wireless Carrier for availability of applications.

## Changing Your @metro App Store<sup>SM</sup> Settings



Use the **Settings** menu in @metro App Store<sup>SM</sup> to manage, move, order applications, and much more.

1. In the standby mode, select **@metro App Store**.
2. At the @metro App Store<sup>SM</sup> menu, Press  to select **Settings**, then press . The following options appear in the display:
  - **Order Apps**: Download applications over the network.
  - **Move Apps**: Move previously downloaded applications between available folders.
  - **Manage Apps**: View used and available memory.
  - **Main Menu View**: Select whether you wish to view the main @metro App Store<sup>SM</sup> menu in a list or icon format.
  - **View Log**: View the @metro App Store<sup>SM</sup> log, which displays information about recent activity using @metro App Store<sup>SM</sup>.
3. Press  to select the desired option.
4. Press  to enter the option's sub-menu and view or change settings.

## Using On-line Help

The Help sub-menu within @metro App Store<sup>SM</sup> is a short tutorial on several @metro App Store<sup>SM</sup> features. View information about charges, cancelling subscriptions, buying apps, disabling apps, and more.

1. Within in the @metro App Store<sup>SM</sup> menu, use  to select **Help**.

2. Press . The Help subjects described in the following subsections appear in the display.
3. Use  to select the desired Help subject.
4. Press  to view the selected Help information.

## Buying new apps

To buy new and exciting, visit the @metro App Store<sup>SM</sup>. It provides you with a variety of apps you can choose from.

## What do I pay

When you buy an app you will be charged for the purchase cost of the app.

## Demo Apps

A Demo app is free and is designed to demonstrate the app's main features. It usually expires after a certain period of time or a number of uses and often has limited functions. When you run a demo app, you will be presented with a purchase option so you won't have to look for the app in the @metro App Store<sup>SM</sup>.

## Removing Apps

You may remove apps that are no longer needed. When you remove an app, you cannot use the application unless you purchase it again. To remove an app, choose **Settings > Manage Apps**. Then, select the app you want to remove.

## Disabled Apps

You can install new apps even if the memory of your phone is full by partially removing (disabling) apps you haven't used recently. When you

need to use a disabled app, you can restore it at no additional purchase cost.

## **Restoring Apps**

Disabled apps can be quickly restored at no additional purchase cost. To restore an app, run the application you want to restore from the main menu. You will be guided through the restoration process.



## **Expired Apps**

Apps that were purchased based on the number of uses or time expired. You can purchase additional uses from the @metro App Store<sup>SM</sup>.

## 9 Alarm Clock

After an alarm clock is enabled, the phone notifies you at a preset time if the phone is powered on. You can set up to five alarm clocks.

### Enabling an Alarm Clock

1. Select **Tools** > **Alarms**.
2. Select an alarm clock, select **Edit**, and then press  or tap  to set the title, time, alert cycle (days), and alert tone of the alarm clock.
3. Select **On** to enable the alarm clock.
4. Select **Save** to save the settings of the alarm clock.



- When an alarm clock alerts, select **Stop** to stop it or select **Snooze** to snooze it for five minutes.
- If you perform no operation to an alarm clock that alerts, the alarm clock stops temporarily after 45-second ringing and alerts again five minutes later. The alarm clock alerts five times before it stops thoroughly.
- After selecting cycling **Custom**, you can select the days on which an alarm clock needs to repeat from the seven days in a week.







### Disabling an Alarm Clock

1. Select **Tools** > **Alarms**.
2. Select an alarm clock. Then select **Off** to disable the alarm clock, or select **Cancel All** to disable all alarm clocks.





# 10 Music Player









## Adding a Playlist

1. Select **Music Player > Options > Music Library** or tap  to access **Music Library**, and then press  to switch to the **Playlist** tab.
2. Select **Options > Add New Playlist**, enter the name of the playlist, and then tap **Save**.
3. Tap the playlist, and then select **Options > Add From My Files**.
4. Scroll through the music list. Press  or tap  to select the songs to be added to the playlist. (Press  or tap  to select the songs to be removed from the playlist.)
5. Tap **Options > Add** to add the selected songs to the playlist.

## Playing Music

On the main menu screen, tap **Music Player** to launch the media player.

- Press  to play or pause the song.
- Press  to play the next track; press  to play the previous track.

- During playback of a song, press and hold  to fast-forward the song; press and hold  to rewind the song.
- Press  to access the music library.
- Press  or  or tap  to increase or decrease the volume.
- Press  to stop playing a song.
- Tap **Minimize** or press  to return to a standby screen. In this case, the media player plays music in the background.



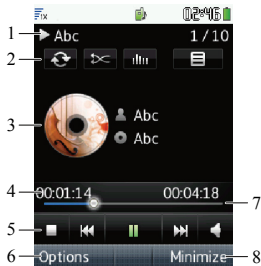

You can also control the music player through tapping the icons on the player screen.



## Description

- 1 Title bar, displaying the music playing status (play, pause, stop), name and number of the current song.







Shortcut icons. You can perform the following operations:

- Tap  to set the phone to repeat all songs in a playlist, to repeat the current song, or not to repeat songs.
- 2 ● Tap  to set the phone to play songs in order or to shuffle songs.
- Tap  to switch between the settings of the equalizer.
- Tap  to display the music library.

- 3 GUI style bar, you can drag the screen to select the GUI style: **Album Art Mode**, **Waveform Mode**, **Lyric Mode**.

- 4 Time bar, displaying the total time and the played duration of a song.

Playback control icons. You can perform the following operations:

- Tap  to stop playing a song.
- Tap  to play the previous track.
- 5 ● Tap  to pause the song; tap  to resume playback.
- Tap  to play the next track.
- Tap  to adjust the volume. You can drag the slider to adjust the volume.

- 6 **Options** menu.

## Description

7 Progress slider, displaying the playing progress of the current song. You can drag the progress slider to the point that you want the file to play.

---

- 8
- When the music player is playing a song, select **Minimize** to minimize the music player and return to the previous menu.
  - When the music player is stopped, select **Back** to close the music player and return to the previous menu.
-

# 11 Camera

## Taking a Picture

1. On the main menu screen, tap **Camera** or press  to launch the camera.

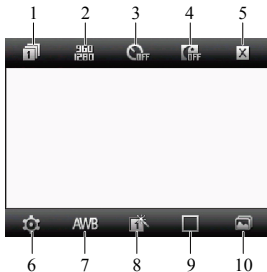







### Description

- 1 Capture modes: Tap the icon to set the number of pictures to be taken.
- 2 Resolutions: Tap the icon to switch between picture resolutions.
- 3 Self-timer mode: Tap the icon to set the time delay of taking a picture after the shutter release.
- 4 Night mode: Tap the icon to enable or disable the night mode.

## Description

- 5 Back: Tap the icon to return to the previous menu.
- 6 Settings: Tap the icon to access the setting menu.
- 7 White balance: Tap the icon to set the white balance.
- 8 Effects: Tap the icon to switch between the picture effects.
- 9 Frames: Tap the icon to switch between fun frames.
- 10 Album: Tap the icon to access the album.



2. Focus the camera on the scene and press  or  to take a picture. Then you can preview the picture and save it.

- Tap  to delete the picture.
- Tap  to set the picture as the wallpaper or a contact image.
- Tap  to send the picture through the MMS or Bluetooth®.
- Tap  to access the album.





In preview mode, you can drag up or down on the screen to zoom out or zoom in (for the resolutions of 1280, the camera can be neither zoomed in nor zoomed out). You can also flick left or right to decrease or increase the brightness.

## Viewing a Picture

1. On the main menu screen, tap **Camera**, or press  to launch the camera.
2. Tap  to access the album.

3. Press  or tap **Phone** (or **Card**) to select a storage location: phone or microSD card.

4. Press  to select a picture.

5. Tap  or directly tap the desired picture to view it.

● Press , or flick left or right to switch between the pictures.

● Tap  or tap the picture to view the picture in full screen mode.

Tap the picture again or press  to exit from the full screen mode.

6. Tap **Options** for the following options:

● **Full Screen:** View the picture in full screen mode.

● **Slide Show:** Play all pictures as a slide show.

● **Rotate:** Rotate the picture.

● **Set as:** Set the picture as the wallpaper or a contact image.

● **Send:** Send the picture through the MMS or Bluetooth<sup>®</sup>.

● **Delete:** Delete the picture.





● **File Info:** View the name, size, creation date, and resolution of the picture.

7. Select **Back** to return to the picture list.







You can also tap **Multimedia** > **My Images** to select a storage location (phone or microSD card), and then view the corresponding pictures.



## Taking Pictures Sequentially

1. On the main menu screen, tap **Camera** or press  to launch the camera.
2. Tap  to select to take a succession of four or nine pictures.
3. Focus the camera on the scene and press  or  to take pictures. The phone will take a preset number of pictures sequentially and then save them automatically.

## Taking a Picture in Self-Timer Mode

1. On the main menu screen, tap **Camera** or press  to launch the camera.
2. Tap  to switch between the 5-second and 10-second self-timer modes.
3. Focus the camera on the scene and press  or . Then the phone will take a picture after a preset countdown and then save it automatically.

## Setting a Picture Effect

1. On the main menu screen, tap **Camera** or press  to launch the camera.
2. Tap  to switch between the picture effects.



# 12 Security

## Enabling or Disabling the Phone Lock

The phone lock protects your phone from unauthorized use. By default, the phone lock is not enabled. The default phone lock code is the last four digits of the MDN. You can change the default phone lock code to any numeric string of 1 to 8 digits.



1. Select **Settings > Security Settings > Phone Lock**.
2. Select one of the following phone lock modes:
  - **5 Minutes, 10 Minutes, 15 Minutes, 30 Minutes** or **60 Minutes**: Set the keypad to be locked after the phone is in standby mode for 5 minutes, 10 minutes, 15 minutes, 30 minutes or 60 minutes.
  - **Immediate**: Enable the phone lock immediately.
  - **Power On**: Enable the phone lock when the phone is powered on next time.
  - **Off**: Disable the phone lock.

## Changing the Phone Lock Code

Do remember your phone lock code. If you forget it, contact your local dealer.

1. Select **Settings > Security Settings > Change Phone Code**.
2. Enter the correct phone lock code and select **OK**.
3. Enter the new phone lock code and select **OK**.
4. Enter the new phone lock code again and select **OK**.

## Locking the Keypad

When the keypad is locked, you can still answer incoming calls by pressing  or tapping .

### Manually Locking the Keypad

To avoid misoperations, you can tap  on the standby screen to lock the keypad.

### Automatically Locking the Keypad

If the auto keyguard function is enabled, after the phone is idle for a preset period of time in standby mode, the keypad is locked automatically.

1. Select **Settings > Phone Settings > Auto Keyguard**.
2. Select one of the following options:
  - **Off**: Disable the auto keyguard function.
  - **15 Seconds, 30 Seconds, or 1 Minute**: Set the keypad to be locked after the phone is idle for 15 seconds, 30 seconds, or one minute.

### Unlocking the Keypad

When the touchscreen is locked, drag the round button in the scroll bar at the bottom of the screen from left to right to unlock the keypad.

## 13 Bluetooth® Connection

Your phone supports Bluetooth® wireless connections. Through Bluetooth®, you can set up wireless connections between your phone and other Bluetooth®-compatible devices to exchange data.

Bluetooth® wireless connections can be set up between the devices within a maximum range of 10 meters, however, the connections can be disturbed by other electronic devices or blocked by obstacles such as walls.



- In certain areas, the use of Bluetooth® devices might be restricted or prohibited. Observe local laws and regulations.
- Do not accept the connection request of an unknown device. Thus you can prevent your mobile phone from the intrusion of harmful contents.

### Sending Data Through a Bluetooth® Connection

1. To enable the Bluetooth® function, Select **Connections** > **Bluetooth** > **Power On**.
2. Launch the application that saves the contents to be sent. For example, if you want to send a picture to another device, you need to launch the **Multimedia** application.
3. Select the contents you want to send. Then select **Options** > **Send** > **Send via Bluetooth**.  
 If the Bluetooth® function is not enabled yet, the phone will ask you whether to enable the function.
4. After accessing **Device List**, you need to select the device to be connected from the list.



- You can set up only one Bluetooth® connection each time.
  - If the device list contains the devices that are already paired with your phone, select the desired device to send data.
  - When the device list is empty or the device to be connected to is not in the list, select **Search** to search for other Bluetooth®-enabled devices in the effective range. The names of the found devices will be displayed on the screen. Select **Back** to stop searching.
5. Select **Options** > **Send** to send the contents through Bluetooth®. If the other Bluetooth® device requires verification before the connection, create a pairing password that is to be used together with the other party. After both parties enter the same password, the Bluetooth® connection can be set up.
  6. After the connection is set up, information about the data being transmitted is displayed on the screen.

## Receiving Data Through a Bluetooth® Connection

1. When another device sends data to your phone through Bluetooth®, the phone asks you whether to receive the data. Select **Yes** to receive the data. The filename and the receiving progress are displayed on the screen. Select **No** to reject the data.
-  When your phone sets up a Bluetooth® connection with another device for the first time, you need to enter the password for pairing your phone with the Bluetooth® device. After the other party enters the same password, your phone begins to receive data.

2. After the phone prompts you that the data is received, the data is automatically saved to **Multimedia**.



If a microSD card is installed on your phone, the phone saves the received data to the microSD card by default; otherwise, the phone saves the received data to the phone memory.

## Listening to Music Through a Bluetooth® Stereo Headset

You can listen to music on the phone through a Bluetooth® stereo headset.

1. On a main menu screen, tap **Music player** to launch the music player. Then power on your Bluetooth® headset for pairing.
  2. Select **Options > Play via Bluetooth**, the phone access **Device List**.
  3. Select **Search** to search for Bluetooth®-compatible devices. In the list of newly found devices, select the corresponding Bluetooth® headset. Then select **Options > Connect** to access the screen for pairing devices.
  4. Enter the password for pairing the Bluetooth® headset and select **OK**.
  5. After the phone sets up the Bluetooth® connection, you can listen to music through the Bluetooth® stereo headset.
-  • If the Bluetooth® function is not enabled yet, the phone will ask you whether to enable the function.
- After your phone is connected to a Bluetooth® headset, music, voice broadcast messages, and navigation voice messages are played through the headset.

## Sending a Contact Through a Bluetooth® Connection

Your phone can send a contact through Bluetooth®.

1. In standby mode, press  to access the contact list.
2. Select a contact to be sent, and then select **Options** > **Send Vcard** > **Bluetooth**.
3. Select **Search** to search for Bluetooth®-compatible devices. In the list of newly found devices, select the corresponding Bluetooth® headset. Then select **Options** > **Send** to access the screen for pairing devices.
4. Enter the pairing password, and then select **OK**.
5. After the Bluetooth® connection is set up, the phone begins to send the contact.

## Other Bluetooth® Operations

- **Power On/Off:** Enable or disable the Bluetooth® function.
- **Search New Devices:** Search for Bluetooth®-compatible devices.
- **Device List:** View all paired Bluetooth® devices.
- **My Device Properties:** View the name, visibility, hardware address, type, and supported mode of the phone.

# 14 TTY Operation

## Using the TTY Device

The Teletypewriter (TTY) is a typewriting device. By connecting the phone to the TTY device, you can use the TTY functions to send/receive messages.

When you use the TTY function, do as follows:

1. Set the phone to the TTY mode and connect the TTY device to the headset jack of the phone.
2. Make or answer calls as normal.
3. When the call is put through, use the TTY device to send or receive the letters.
4. Press  or select **End** to end the call.

## Setting the TTY Mode

1. On a main menu screen, Select **Settings > Phone Settings > TTY Setup**.
2. Select the **TTY** mode, and then press **Select** or  to confirm.
  - **Voice**: The standard voice speaking mode and the listening mode.
  - **TTY**: Transmit and receive the TTY characters.
  - **VCO**: Receive TTY characters but transmit by speaking into the microphone.
  - **HCO**: Transmit TTY characters but receive by listening to the earpiece.

# 15 Troubleshooting

If you encounter any problem when using your phone, try to rectify the problem according to the following table. If the problem persists, contact the service provider or the dealer.

Problem	Ensure that...
The battery cannot be charged.	The charger is properly connected to your phone and the power socket.
The phone cannot be powered on.	<ul style="list-style-type: none"><li>• The battery power is sufficient.</li><li>• The battery is properly installed.</li><li>• Press and hold .</li></ul>
You cannot make a call except an emergency call.	<ul style="list-style-type: none"><li>• The phone number is correct.</li><li>• You are in the network service area.</li><li>• You have not enabled the call restriction function.</li></ul>
Bad call quality.	<ul style="list-style-type: none"><li>• The signal strength is strong enough.</li><li>• If you are staying indoors, move close to a window.</li></ul>
During a call, the other side cannot hear your voice.	The microphone is not covered.
The signal strength is not strong enough or your phone is often off line.	<ul style="list-style-type: none"><li>• The antenna is in a good condition.</li><li>• Move close to a place with strong signal strength.</li></ul>



<b>Problem</b>	<b>Ensure that...</b>
Your phone displays "No service found", "Service unavailable" or "Network problem".	<ul style="list-style-type: none"><li data-bbox="477 131 967 262">● You are not in an area with weak magnetic field (in a tunnel or surrounded by buildings). If so, move to another area and try again.</li><li data-bbox="477 278 967 375">● Do not visit the service option without obtaining authorization from your service provider.</li></ul>

# 16 Warnings and Precautions

This section contains important information pertaining to the operating instructions of your device. It also contains information about how to use the device safely. Read this information carefully before using your device.

## Electronic Device

Power off your device if using the device is prohibited. Do not use the device when using the device causes danger or interference with electronic devices.

## Medical Device

- Follow rules and regulations set forth by hospitals and health care facilities. Do not use your device when using the device is prohibited.
- Pacemaker manufacturers recommend that a minimum distance of 15 cm be maintained between a device and a pacemaker to prevent potential interference with the pacemaker. If you are using a pacemaker, use the device on the opposite side of the pacemaker and do not carry the device in your front pocket.

## Potentially Explosive Atmosphere

Power off your device in any area with a potentially explosive atmosphere, and comply with all signs and instructions. Areas that may have potentially explosive atmospheres include the areas where you would normally be advised to turn off your vehicle engine. Triggering of sparks in such areas could cause an explosion or a fire, resulting in bodily injuries or even deaths. Do not power on your device at refueling points such as service stations. Comply with restrictions on the use of radio equipment in fuel depots, storage, and distribution areas, and chemical plants. In addition,

adhere to restrictions in areas where blasting operations are in progress. Before using the device, watch out for areas that have potentially explosive atmospheres that are often, but not always, clearly marked. Such locations include areas below the deck on boats, chemical transfer or storage facilities, and areas where the air contains chemicals or particles such as grain, dust, or metal powders. Ask the manufacturers of vehicles using liquefied petroleum gas (such as propane or butane) whether this device can be safely used in their vicinity.

## **Traffic Security**

Observe local laws and regulations while using the device. In addition, if using the device while driving a vehicle, comply with the following guidelines:

- Concentrate on driving. Your first responsibility is to drive safely.
- Do not talk on the device while driving. Use hands-free accessories.
- When you have to make or answer a call, park the vehicle at the road side before using your device.
- RF signals may affect electronic systems of motor vehicles. For more information, consult the vehicle manufacturer.
- In a motor vehicle, do not place the device over the air bag or in the air bag deployment area. Otherwise, the device may hurt you owing to the strong force when the air bag inflates.
- Do not use your device while flying in an aircraft. Power off your device before boarding an aircraft. Using wireless devices in an aircraft may cause danger to the operation of the aircraft and disrupt the wireless telephone network. It may also be considered illegal.

## **Operating Environment**

- Do not use or charge the device in dusty, damp, and dirty places or places with magnetic fields. Otherwise, it may result in a malfunction of the circuit.

- The device complies with the RF specifications when the device is used near your ear or at a distance of 1.5 cm from your body. Ensure that the device accessories such as a device case and a device holster are not composed of metal components. Keep your device 1.5 cm away from your body to meet the requirement earlier mentioned.
- On a stormy day with thunder, do not use your device when it is being charged, to prevent any danger caused by lightning.
- When you are on a call, do not touch the antenna. Touching the antenna affects the call quality and results in increase in power consumption. As a result, the talk time and the standby time are reduced.
- While using the device, observe the local laws and regulations, and respect others' privacy and legal rights.
- Keep the ambient temperature between 0 °C and 40 °C while the device is being charged. Keep the ambient temperature between 0 °C to 40 °C for using the device powered by a battery.

## **Prevention of Hearing Damage**

Using a headset at high volume can damage your hearing. To reduce the risk of damage to hearing, lower the headset volume to a safe and comfortable level.

## **Safety of Children**

Comply with all precautions with regard to children's safety. Letting the child play with your device or its accessories, which may include parts that can be detached from the device, may be dangerous, as it may present a choking hazard. Ensure that small children are kept away from the device and accessories.

## Accessories

Use the accessories delivered only by the manufacturer. Using accessories of other manufacturers or vendors with this device model may invalidate any approval or warranty applicable to the device, result in the non-operation of the device, and cause danger.

## Battery and Charger

- Unplug the charger from the electrical plug and the device when not in use.
- The battery can be charged and discharged hundreds of times before it eventually wears out. When the standby time and the talk time are shorter than the normal time, replace the battery.
- Use the AC power supply defined in the specifications of the charger. An improper power voltage may cause a fire or a malfunction of the charger.
- Do not connect two poles of the battery with conductors, such as metal materials, keys, or jewelries. Otherwise, the battery may be short-circuited and may cause injuries and burns on your body.
- Do not disassemble the battery or solder the battery poles. Otherwise, it may lead to electrolyte leakage, overheating, fire, or explosion.
- If battery electrolyte leaks out, ensure that the electrolyte does not touch your skin and eyes. When the electrolyte touches your skin or splashes into your eyes, wash your eyes with clean water immediately and consult a doctor.
- If there is a case of battery deformation, color change, or abnormal heating while you charge or store the battery, remove the battery immediately and stop using it. Otherwise, it may lead to battery leakage, overheating, explosion, or fire.
- If the power cable is damaged (for example, the cord is exposed or broken), or the plug loosens, stop using the cable at once. Otherwise, it may lead to an electric shock, a short circuit of the charger, or a fire.

- Do not dispose of batteries in fire as they may explode. Batteries may also explode if damaged.
- Danger of explosion if battery is incorrectly replaced. Recycle or dispose of used batteries according to the local regulations or reference instruction supplied with your device.

## **Cleaning and Maintenance**

- The device, battery, and charger are not water-resistant. Keep them dry. Protect the device, battery, and charger from water or vapor. Do not touch the device or the charger with a wet hand. Otherwise, it may lead to a short circuit, a malfunction of the device, and an electric shock to the user.
- Do not place your device, battery, and charger in places where they can get damaged because of collision. Otherwise, it may lead to battery leakage, device malfunction, overheating, fire, or explosion.
- Do not place magnetic storage media such as magnetic cards and floppy disks near the device. Radiation from the device may erase the information stored on them.
- Do not leave your device, battery, and charger in a place with an extreme high or low temperature. Otherwise, they may not function properly and may lead to a fire or an explosion. When the temperature is lower than 0°C, performance of the battery is affected.
- Do not place sharp metal objects such as pins near the earpiece. The earpiece may attract these objects and hurt you when you are using the device.
- Before you clean or maintain the device, power off the device and disconnect it from the charger.
- Do not use any chemical detergent, powder, or other chemical agents (such as alcohol and benzene) to clean the device and the charger. Otherwise, parts of the device may be damaged or a fire can be caused.

You can clean the device and the charger with a piece of damp and soft antistatic cloth.

- Do not dismantle the device or accessories. Otherwise, the warranty on the device and accessories is invalid and the manufacturer is not liable to pay for the damage.

## **Emergency Call**

You can use your device for emergency calls in the service area. The connection, however, cannot be guaranteed in all conditions. You should not rely solely on the device for essential communications.

## **Certification Information (SAR)**

This device meets guidelines for exposure to radio waves.

Your device is a low-power radio transmitter and receiver. As recommended by international guidelines, the device is designed not to exceed the limits for exposure to radio waves. These guidelines were developed by the independent scientific organization International Commission on Non-Ionizing Radiation Protection (ICNIRP) and include safety measures designed to ensure safety for all users, regardless of age and health.

The Specific Absorption Rate (SAR) is the unit of measurement for the amount of radio frequency energy absorbed by the body when using a device. The SAR value is determined at the highest certified power level in laboratory conditions, but the actual SAR level of the device when being operated can be well below the value. This is because the device is designed to use the minimum power required to reach the network.

The SAR limit adopted by USA and Canada is 1.6 watts/kilogram (W/kg) averaged over one gram of tissue. The highest SAR value reported to the FCC and IC for this device type when tested for use at the ear is 1.11 W/kg, and when properly worn on the body is 0.838 W/kg.

## **FCC Statement**

**This equipment has been tested and found to comply with the limits for a Class B digital device, pursuant to Part 15 of the FCC Rules. These limits are designed to provide reasonable protection against harmful interference in a residential installation. This equipment generates, uses and can radiate radio frequency energy and, if not installed and used in accordance with the instructions, may cause harmful interference to radio communications. However, there is no guarantee that interference will not occur in a particular installation. If this equipment does cause harmful interference to radio or television reception, which can be determined by turning the equipment off and on, the user is encouraged to try to correct the interference by one or more of the following measures:**

- Reorient or relocate the receiving antenna.**
- Increase the separation between the equipment and receiver.**
- Connect the equipment into an outlet on a circuit different from that to which the receiver is connected.**
- Consult the dealer or an experienced radio/TV technician for help.**

This device complies with Part 15 of the FCC Rules. Operation is subject to the following two conditions: (1) this device may not cause harmful interference, and (2) this device must accept any interference received, including interference that may cause undesired operation.



**Warning:** Changes or modifications made to this device not expressly approved by Huawei Technologies Co., Ltd. may void the FCC authorization to operate this device.

## **Hearing Aid Compatibility (HAC) regulations for Mobile phones**

In 2003, the FCC adopted rules to make digital wireless telephones compatible with hearing aids and cochlear implants. Although analog wireless phones do not usually cause interference with hearing aids or cochlear implants, digital wireless phones sometimes do because of electromagnetic energy emitted by the phone's antenna, backlight, or other components.

Your phone is compliant with FCC HAC regulations (ANSI C63.19).

While some wireless phones are used near some hearing devices (hearing aids and cochlear implants), users may detect a buzzing, humming, or whining noise.

Some hearing devices are more immune than others to this interference noise, and phones also vary in the amount of interference they generate.

The wireless telephone industry has developed a rating system for wireless phones, to assist hearing device users find phones that may be compatible with their hearing devices. Not all phones have been rated. Phones that are rated have the rating on their box or a label located on the box. The ratings are not guarantees. Results will vary depending on the user's hearing device and hearing loss. If your hearing device happens to be vulnerable to interference, you may not be able to use a rated phone successfully. Trying out the phone with your hearing device is the best way to evaluate it for your personal needs.

M-Ratings: Phones rated M3 or M4 meet FCC requirements and are likely to generate less interference to hearing devices than phones that are not labeled. M4 is the better/higher of the two ratings.

T-Ratings: Phones rated T3 or T4 meet FCC requirements and are likely to be more usable with a hearing device's telecoil ("T Switch" or "Telephone Switch") than unrated phones. T4 is the better/higher of the two ratings. (Note that not all hearing devices have telecoils in them.) Hearing devices may also be measured.

Your phone meets the M4/T3 level rating. Hearing devices may also be rated. Your hearing device manufacturer or hearing health professional may help you find this rating.

For more information about the FCC Hearing Aid Compatibility please go to <http://www.fcc.gov/cgb/dro>.

# 17 Futurewei Technologies, Inc. Limited Warranty

Futurewei Technologies, Inc. (“Huawei”) represents and warrants to the original purchaser (“Purchaser”) that Huawei’s phones and accessories (“Product”) are free from material defects, including improper or inferior workmanship, materials, and design, during the designated warranty period, and subject to the following terms and conditions, when used normally and in accordance with all operating instructions:

- 1. Warranty Period: Coverage under this warranty is limited to the following time periods:**
  - a) Phone: a period of 12 months from the date of purchase.
  - b) Battery and Charger: a period of 12 months from the date of purchase.
  - c) Other accessories (If included in the box set): a period of 3 months from the date of purchase.
- 2. This limited warranty only applies to products manufactured by or for Huawei and that can be identified by the “Huawei” trademark, trade name, or logo affixed to them. The limited warranty does not apply to any non-Huawei products or software.**
- 3. The Warranty extends only to Purchasers who purchased the Product in the United States of America and is not assignable or**

**transferable to any subsequent purchaser/customer.**

- 4. During the limited warranty period, Huawei will repair or replace at Huawei's sole option, any parts of the Product that are defective or malfunction during normal usage. Huawei reserves the right to use new or refurbished replacement parts in repair of the Product.**
- 5. This limited warranty covers only the costs of parts and labor. Other related costs such as shipping and delivery costs may be born by purchaser at Huawei's option.**
- 6. At Huawei's request, Purchaser must prove the date of the original purchase of the Product by a dated bill of sale or dated itemized receipt.**
- 7. This warranty does not cover damage resulting from:**
  - a) Abuse, accident, misuse, improper storage, exposure to liquid, moisture, or dampness;
  - b) External causes such as from collision, fire, flooding, sand, dirt, windstorm, lightning, or earthquake;
  - c) Exposure to extreme weather conditions, Acts of God, theft, blown fuse, or improper use of any electrical source;
  - d) Computer or internet viruses, bugs, worms, Trojan Horses, cancelbots;
  - e) Use with non-Huawei products or products not recommended for use with Huawei products;

- f) normal wear and tear of the equipment;
- g) Usage of equipment other than its normal and customary manner;
- h) Improper testing, operation, maintenance, installation, or any alteration or modification of Product;
- i) Consumable parts, such as batteries, unless damage has occurred due to a defect in Huawei materials and workmanship;
- j) Service performed by anyone who is not a Huawei representative or an authorized Huawei service provider;
- k) Other acts which are not the fault of Huawei, including damage caused by shipping;
- l) Cosmetic damages, including but not limited to dents or scratches in decorative, structural, or non-operative parts resulting from normal customer use;
- m) Spillage of food or liquid, corrosion, rust or incorrect voltage; and
- n) The defective function of the cellular system or inadequate signal reception by the external antenna, or viruses or other software problems introduced into the Product.

**8. Huawei does not warrant that the operation of this product will be uninterrupted or error-free.**

**9. This warranty will also be null and void in any of the following events:**

- a) The serial number or warranty seal on the equipment has been altered, defaced or removed;
- b) Any term contained in this warranty has been altered or

modified in any way without prior written consent of Huawei;

- c) Huawei has not been notified by Purchaser of the alleged defect or malfunction of the Product during the applicable warranty period.

**10. If Product is returned to Huawei after the expiration of the warranty period, Huawei's normal service policies shall apply and Purchaser will be charged accordingly.**

- a) Huawei assumes no obligation or liability beyond that which is expressly provided for in this limited warranty.
- b) All warranty information, pricing, product features and specifications are subject to change.

**11. This limited warranty provides Purchaser's sole and exclusive remedy to be provided by Huawei. The agents, employees, distributors, and dealers of Huawei products are not authorized to make modifications to this limited warranty, or make additional warranties binding on Huawei.**

## **LIMIT OF LIABILITY**

**12. HUAWEI'S LIMIT OF LIABILITY UNDER THIS LIMITED WARRANTY SHALL BE THE ACTUAL CASH VALUE OF THE PRODUCT AT THE TIME PURCHASER RETURNS THE PRODUCT FOR REPAIR, AS DETERMINED BY THE PRICE PAID BY THE PURCHASER FOR THE PRODUCT LESS A REASONABLE AMOUNT OF USAGE. HUAWEI SHALL NOT BE LIABLE FOR ANY OTHER LOSSES OR DAMAGES SUCH AS SPECIAL,**

INCIDENTAL, CONSEQUENTIAL, OR PUNITIVE DAMAGES (INCLUDING BUT NOT LIMITED TO LOSS OF ANTICIPATED BENEFITS OR PROFITS, LOSS OF SAVINGS OR REVENUE, LOSS OF DATA, LOSS OF USE OF THE PRODUCT OR ANY ASSOCIATED EQUIPMENT, COST OF CAPITAL, COST OF ANY SUBSTITUTE EQUIPMENT OR FACILITIES, DOWNTIME, ANY COSTS OF RECOVERING, REPROGRAMMING, OR REPRODUCING ANY PROGRAM OR DATA, ANY FAILURE TO MAINTAIN THE CONFIDENTIALITY OF DATA STORED ON THE PRODUCT, THE CLAIMS OF ANY THIRD PARTIES, INCLUDING SUBSEQUENT PURCHASERS, AND INJURY TO PROPERTY, RESULTING FROM THE PURCHASE OR USE OF THE PRODUCT OR ARISING FROM BREACH OF THIS WARRANTY, BREACH OF CONTRACT, NEGLIGENCE, STRICT LIABILITY, OR ANY OTHER LEGAL OR EQUITABLE THEORY, EVEN IF HUAWEI KNEW OF THE LIKELIHOOD OF SUCH DAMAGES). HUAWEI SHALL NOT BE LIABLE FOR DELAY IN RENDERING SERVICE UNDER THE LIMITED WARRANTY, OR LOSS OF USE DURING THE PERIOD THAT THE PRODUCT IS BEING REPAIRED.

## **DISCLAIMER OF WARRANTY**

13. HUAWEI'S LIABILITY UNDER EITHER THE IMPLIED WARRANTY OF MERCHANTABILITY OR FITNESS FOR A PARTICULAR PURPOSE, SHALL BE LIMITED TO THE DURATION OF THE FOREGOING LIMITED WRITTEN WARRANTY. OTHERWISE, THE FOREGOING LIMITED WARRANTY IS PURCHASER'S SOLE AND EXCLUSIVE REMEDY AND IS IN LIEU OF ALL OTHER

## **WARRANTIES, EXPRESS OR IMPLIED.**

- 14. Some states do not allow exclusion or limitation of incidental, consequential, or punitive damages, or permit limitations on the length of implied warranties, so certain of these warranty limitations may not apply to Purchaser. This limited warranty gives Purchaser specific legal rights; Purchaser may also have other rights which vary from state to state. If any term of this limited warranty is held to be illegal or unenforceable, the legality or enforceability of the remaining terms shall not be affected or impaired.**
- 15. This limited warranty allocates risk of Product failure between Purchaser and Huawei, and Huawei's Product pricing reflects this allocation of risk and the limitations of liability contained in this limited warranty.**

## **Contact Huawei**

**WEB SITE: [HTTP://WWW.HUAWEIDEVICE.COM](http://www.huaweidevice.com)**

**EMAIL: SUPPORTUSA@HUAWEI.COM**

**\* This contact information may change without notice.**

**Please contact your authorized Huawei retailer for updated contact information.**

**\* By selecting a rate plan and activating your phone, you agree to the MetroPCS Terms and Conditions of Service available at [metropcs.com](http://metropcs.com).**

Version: V100R001C45\_01      Part Number: 31010EJH