



DIRECTV Receiver

Owner's Manual

For DIRECTV Receiver Models:

SIR-S300W

SIR-S310W



CAUTION: TO REDUCE THE RISK OF ELECTRIC SHOCK, DO NOT REMOVE COVER (OR BACK). NO USER SERVICEABLE PARTS INSIDE. REFER SERVICING TO QUALIFIED SERVICE PERSONNEL.



This symbol indicates high voltage is present inside. It is dangerous to make any kind of contact with any part inside of this product.



This symbol alerts you that important literature concerning operation and maintenance has been included with this product.

Note to CATV system installer: This reminder is provided to call CATV system installer's attention to Article 820-40 of the National Electrical Code that provides guidelines for proper grounding and, in particular, specifies that the cable ground shall be connected to the grounding system of the building as close to the point of cable entry as practical.

Caution: FCC regulations state that any unauthorized changes or modifications to this equipment may void the user's authority to operate it.

Caution: To prevent electric shock, match the wide blade of plug to the wide slot, and fully insert the plug.

Important: One Federal Court has held that unauthorized recording of copyrighted TV programs is an infringement of U.S. copyright laws.

To prevent damage which may result in fire or electric shock hazard, do not expose this appliance to rain or moisture.



Always be careful when using this product. To reduce the risk of fire, electrical shock, and other injuries, keep these safety precautions in mind when installing, using, and maintaining your DIRECTV® Receiver.

- Read all safety and operating instructions before operating this product.
- Keep the safety and operating instructions for future reference.
- Heed all warnings on the product and in the operating instructions.
- Follow all operating and use instructions.
- Unplug the product from the wall outlet before cleaning. Use a damp cloth; do not use liquid or aerosol cleaners.
- Never add any attachments and/or equipment without approval of the manufacturer. Such additions can increase the risk of fire, electric shock, or other personal injury.
- Do not use the product where contact with or immersion in water is a possibility, such as near bath tubs, sinks, washing machines, swimming pools, etc.
- Do not place the product on an unstable cart, stand, tripod, bracket, or table where it can fall. A falling product can cause serious injury to a child or adult, and serious damage to the appliance. Use only with a cart, stand, tripod, bracket, or table recommended by the manufacturer or sold with the product. Follow the manufacturer's instructions when mounting the unit, and use a mounting accessory recommended by the manufacturer. Move the product and cart with care. Quick stops, excessive force, and uneven surfaces can make the unit and cart unsteady and likely to overturn.
- Provide ventilation for the product. The unit is designed with slots in the cabinet for ventilation to protect it from overheating. Do not block these openings with any object, and do not place the product on a bed, sofa, rug, or other similar surface. Do not place it near a radiator or heat register. If you place the product on a rack or bookcase, ensure that there is adequate ventilation and that you have followed the manufacturer's instructions for mounting.
- Operate your product only from the type of power source indicated on the marking label. If you are not sure of the type of power supplied to your home, consult your appliance dealer or local power company.
- Use only a grounded or polarized outlet. For your safety, this product is equipped with a polarized alternating current line plug having one blade wider than the other. This plug will fit into the power outlet only one way. If you are unable to insert the plug fully into the outlet, try reversing the plug. If the plug still does not fit, contact your electrician to replace your outlet.
- Protect the power cord. Power supply cords should be routed so that they will not be walked on or pinched by objects placed on or against them. Pay particular attention to cords at plugs, convenience receptacles, and the point where they exit from the unit.
- Unplug the product from the wall outlet and disconnect the antenna or cabling during a lightning storm or when left unattended and unused for long periods of time. This will prevent damage to the unit due to lightning and power-line surges.



Warning! Important Safety Instructions

SAMSUNG

- Avoid overhead power lines. An outside antenna system should not be placed in the vicinity of overhead power lines or other electric light or power circuits or where it can fall into such power lines or circuits. When installing an outside antenna system, be extremely careful to keep from touching the power lines or circuits. Contact with such lines can be fatal.
- Do not overload the wall outlet or extension cords. Overloading can result in fire or electric shock.
- Do not insert anything through the openings in the unit, where they can touch dangerous voltage points or damage parts. Never spill liquid of any kind on the product.
- Ground outdoor antennas. If an outside antenna is connected to the product, be sure the antenna is grounded so as to provide some protection against voltage surges and built-up static charges. Section 810 of the National Electrical Code, ANSI/NFPA No. 70-1984, provides information about proper grounding of the mast and supporting structure, grounding of the lead-in wire to an antenna discharge unit, size of grounding conductors, location of antenna discharge unit, connection to grounding electrodes, and requirements for the grounding electrode.
- Do not attempt to service the product yourself. Refer all servicing to qualified service personnel. Unplug the unit from the wall outlet and refer servicing to qualified service personnel under the following conditions:

- when the power-supply cord or plug is damaged
- if liquid has been spilled on the unit or if objects have fallen into the unit

- if the product has been exposed to rain or water
- if the product does not operate normally by following the operating instructions

- if the product has been dropped or the cabinet has been damaged
- when the product exhibits a distinct change in performance
- If you make adjustments yourself, adjust only those controls that are covered by the operating instructions. Adjusting other controls may result in damage and will often require extensive work by a qualified technician to restore the product to normal.
- When replacement parts are required, be sure the service technician uses replacement parts specified by the manufacturer or those that have the same characteristics as the original part. Unauthorized substitutions may result in additional damage to the unit.
- Upon completion of any service or repairs to this product, ask the service technician to perform safety checks to determine that the product is in a safe operating condition.

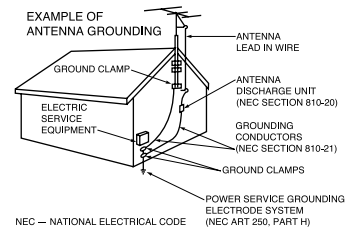

This device complies with part 15 of the FCC Rules. Operation is subject to the following two conditions:

- (1) This device may not cause harmful interference, and**
- (2) This device must accept any interference that may cause undesired operation.**

This satellite receiver provides display of television closed captioning in accordance with §15.119 of the FCC rules.

Attention

Telephone Line Interruption

A continuous land-based phone line connection is required for DIRECTV® Pay Per View functionality and sports subscriptions. Any calls generated by the DIRECTV Receiver are toll free. These calls are typically made in the middle of the night; your phone is in use for approximately 30 seconds.

Trademark and copyright statements

Samsung is a trademark of Samsung Electronics. ©2003 DIRECTV, Inc. DIRECTV, the Cyclone Design logo and DIRECTV INTERACTIVE are registered trademarks of DIRECTV, Inc., a unit of Hughes Electronics Corp, and are used with permission. All other trademarks and service marks are the property of their respective owners.

Manufactured under license from Dolby Laboratories. "Dolby" and the double-D symbol are trademarks of Dolby Laboratories. Confidential Unpublished Works. ©1992-1997 Dolby Laboratories Inc. All rights reserved.

Macrovision Information

This equipment incorporates copyright protection technology that is protected by U.S. patents and other intellectual property rights. Use of this copyright protection technology is granted by Macrovision for home and other limited DBS IRD pay per view uses only. Reverse engineering or disassembly is prohibited.

Program Recording Restrictions

Programming may be taped for home viewing only. All other taping is expressly prohibited. Some programming may not be taped. An additional taping fee may be applied. Call your program provider for details.

Owner's Record

The model and serial numbers are located on the bottom of the DIRECTV Receiver. The number for the Access Card is on the back of the card and on the carton label. The Receiver ID number is on the back of the Receiver. Record these numbers for reference when calling your sales or service representative regarding this product.

Model Number: _____

Serial Number: _____

Access Card Number: _____

Receiver ID Number: _____

Customer Support

For DIRECTV® Programming

For subscription information, or to resolve problems related to programming, call: DIRECTV at 1-800-DIRECTV (1-800-347-3288) or visit the DIRECTV Web site (DIRECTV.com).

For Installation

To arrange for the installation of your DIRECTV Receiver, call the dealer from whom you purchased your system.

For Hardware

To resolve problems related to this DIRECTV Receiver, call Samsung Customer Support at 1-800-522-2946.

SAMSUNG DIGITAL SATELLITE RECEIVER

LIMITED WARRANTY TO ORIGINAL PURCHASER

This SAMSUNG manufactured product, as supplied and distributed by Samsung Electronics America, Inc. (SAMSUNG) and delivered new, in the original carton to the original consumer purchaser, is warranted by SAMSUNG against manufacturing defects in materials and workmanship for a limited warranty period of:

One (1) Year Parts and Labor*
(*90 Days Parts and Labor for Commercial Use)

This limited warranty begins on the original date of purchase, and is valid only on products purchased and used in the United States. To receive warranty service, the purchaser must contact SAMSUNG for problem determination and service procedures. Warranty service can only be performed by a SAMSUNG authorized service center. The original dated bill of sale must be presented upon request as proof of purchase to SAMSUNG or SAMSUNG's authorized service center. Transportation of the product to and from the service center is the responsibility of the purchaser.

SAMSUNG will repair or replace this product, at our option and at no charge as stipulated herein, with new or reconditioned parts or products if found to be defective during the limited warranty period specified above. All replaced parts and products become the property of SAMSUNG and must be returned to SAMSUNG. Replacement parts and products assume the remaining original warranty, or ninety (90) days, whichever is longer.

SAMSUNG's obligations with respect to software products distributed by SAMSUNG under the SAMSUNG brand name are set forth in the applicable end user license agreement. Non-SAMSUNG hardware and software products are provided on an "AS IS" basis. However, non-SAMSUNG manufacturers, suppliers, publishers, and service providers may provide their own warranties.

This limited warranty covers manufacturing defects in materials and workmanship encountered in normal, and except to the extent otherwise expressly provided for in this statement, noncommercial use of this product, and shall not apply to the following, including, but not limited to: damage which occurs in shipment; delivery and installation; applications and uses for which this product was not intended; altered product or serial numbers; cosmetic damage or exterior finish; accidents, abuse, neglect, fire, water, lightning or other acts of nature; use of products, equipment, systems, utilities, services, parts, supplies, accessories, applications, installations, repairs, external wiring or connectors not supplied and authorized by SAMSUNG, or which damage this product or result in service problems; incorrect electrical line voltage, fluctuations and surges; customer

adjustments and failure to follow operating instructions, cleaning, maintenance and environmental instructions that are covered and prescribed in the instruction book; product removal or reinstallation; reception problems and distortion related to noise, echo, interference or other signal transmission and delivery problems. SAMSUNG does not warrant uninterrupted or error-free operation of the product.

THERE ARE NO EXPRESS WARRANTIES OTHER THAN THOSE LISTED AND DESCRIBED ABOVE, AND NO WARRANTIES WHETHER EXPRESS OR IMPLIED, INCLUDING, BUT NOT LIMITED TO, ANY IMPLIED WARRANTIES OF MERCHANTABILITY OR FITNESS FOR A PARTICULAR PURPOSE, SHALL APPLY AFTER THE EXPRESS WARRANTY PERIODS STATED ABOVE, AND NO OTHER EXPRESS WARRANTY OR GUARANTY GIVEN BY ANY PERSON, FIRM OR CORPORATION WITH RESPECT TO THIS PRODUCT SHALL BE BINDING ON SAMSUNG. SAMSUNG SHALL NOT BE LIABLE FOR LOSS OF REVENUE OR PROFITS, FAILURE TO REALIZE SAVINGS OR OTHER BENEFITS, OR ANY OTHER SPECIAL, INCIDENTAL OR CONSEQUENTIAL DAMAGES CAUSED BY THE USE, MISUSE OR INABILITY TO USE THIS PRODUCT, REGARDLESS OF THE LEGAL THEORY ON WHICH THE CLAIM IS BASED, AND EVEN IF SAMSUNG HAS BEEN ADVISED OF THE POSSIBILITY OF SUCH DAMAGES. NOR SHALL RECOVERY OF ANY KIND AGAINST SAMSUNG BE GREATER IN AMOUNT THAN THE PURCHASE PRICE OF THE PRODUCT SOLD BY SAMSUNG AND CAUSING THE ALLEGED DAMAGE. WITHOUT LIMITING THE FOREGOING, PURCHASER ASSUMES ALL RISK AND LIABILITY FOR LOSS, DAMAGE OR INJURY TO PURCHASER AND PURCHASER'S PROPERTY AND TO OTHERS AND THEIR PROPERTY ARISING OUT OF THE USE, MISUSE OR INABILITY TO USE THIS PRODUCT SOLD BY SAMSUNG NOT CAUSED DIRECTLY BY THE NEGLIGENCE OF SAMSUNG. THIS LIMITED WARRANTY SHALL NOT EXTEND TO ANYONE OTHER THAN THE ORIGINAL PURCHASER OF THIS PRODUCT, IS NONTRANSFERABLE AND STATES YOUR EXCLUSIVE REMEDY.

Some states do not allow limitations on how long an implied warranty lasts, or the exclusion or limitation of incidental or consequential damages, so the above limitations or exclusions may not apply to you. This warranty gives you specific legal rights, and you may also have other rights which vary from state to state.

To obtain warranty hardware service, please contact SAMSUNG at:

SAMSUNG CUSTOMER SERVICE

400 VALLEY ROAD, SUITE 201, MT ARLINGTON, NJ 07856, TEL: 973-601-6000, FAX: 973-601-6001
1-800-522-2946 and SAMSUNGUSA.COM

061501

Chapter 1: Getting Started	5
Box contents	5
Front panel controls and lights	7
Back of the DIRECTV Receiver	9
Installing the batteries in the remote control.....	11
Inserting the Access card	12
Chapter 2: Setting up and connecting	13
Jacks and cables	13
Before making connections	15
Choosing a connection	16
Connection option A:	17
DIRECTV Receiver to TV with RF cable only	
Connection option B:	19
DIRECTV Receiver to TV with A/V cables	
Connection option C:	21
DIRECTV Receiver to TV and VCR with RF cables only	
Connection option D:	23
DIRECTV Receiver to TV and VCR with A/V cables	
Connection option E:	25
DIRECTV Receiver to TV and A/V receiver	
Connection option F:	27
DIRECTV Receiver to TV with Component Video inputs and digital A/V receiver	
Connecting the VCR control cable (model SIR-S310W only)	29
Turning on the DIRECTV Receiver for the first time.....	29
Adjusting up the satellite dish.....	30
Testing your DIRECTV Receiver	36
Activating your DIRECTV account	38
Upgrades.....	38

Chapter 3: Watching TV	39
Remote control overview	39
Changing channels	41
Adjusting the volume	41
Getting help	41
Getting information on the TV program you are watching	41
Finding out what's on: the Guides	45
Searching for programs in the Guide	54
Choosing an alternate audio format for a program.....	57
Changing the User setting	57
Pay per view programs	58
Chapter 4: Program reminders and recording timers	63
Setting up the VCR control (model SIR-S310W only)	63
Scheduling program reminders and recording timers	65
Reviewing and modifying reminders and recording timers.....	66
Chapter 5: User profiles	69
User profiles basics	69
Editing user profile names.....	70
Editing channel lists	72
Setting ratings limits	74
Allowing or blocking pay per view purchases	80
Setting a pay per view spending limit	81
Setting the screen color and translucency	82
Setting the current user profile	83
Locking and unlocking your DIRECTV System	83

Chapter 6: Settings, preferences, upgrades, and extras	85
Reading your mail	85
Setting system preferences	86
Reviewing and controlling caller ID	92
Setting the <i>Local Time</i> options	94
Installing a new Access Card	96
Viewing important information and a list of features	97
supported by your DIRECTV Receiver	
Viewing information on automatic system upgrades	99
Viewing fun system extras	100
Chapter 7: Programming the remote control	101
Programming the remote control.....	101
Operating a device with your programmed remote control	102
Code lists.....	103

Chapter 8: Troubleshooting	109
Appendix: Specifications	111
Specifications for DIRECTV Receiver model SIR-S300W	111
Specifications for DIRECTV Receiver model SIR-S310W	112
Index	113

Chapter 1: Getting started

This chapter tells you everything you need to know before you start setting up and using your DIRECTV Receiver. It includes information on:

- Box contents
- Front panel controls and lights
- Back of the DIRECTV Receiver
- Installing the batteries in the remote control
- Inserting the Access Card

Box contents

Welcome! The first step in setting up your DIRECTV Receiver is to unpack the box and familiarize yourself with its contents. This manual covers two models of DIRECTV Receiver: the SIR-S300W and the SIR-S310W

Box contents for the SIR-S300W

If you are missing any items, contact your Samsung dealer.

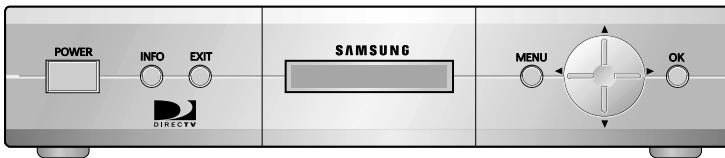

DIRECTV Receiver (SIR-S300W)

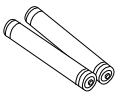

AAA size batteries

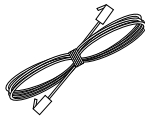

RJ-11
Telephone cord



Access Card

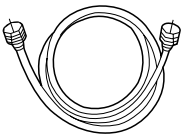

RF coaxial cable

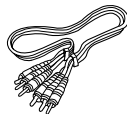

A/V cable



Remote control

Box contents for the SIR-S310W

If you are missing any items, contact your Samsung dealer.

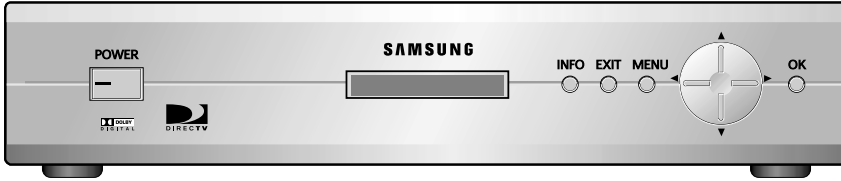

DIRECTV Receiver (SIR-S310W)

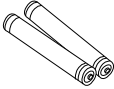

AAA size batteries

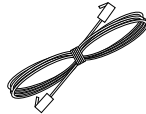

RJ-11
Telephone cord



Remote control

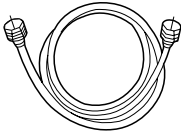

RF coaxial cable

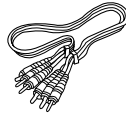

A/V cable

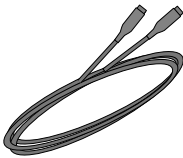

S-Video cable



Access Card



VCR control cable

Front panel controls and lights

Now that you've unpacked the box, take a moment to take a look at the buttons and lights on the front of your DIRECTV Receiver.

SIR-S300W

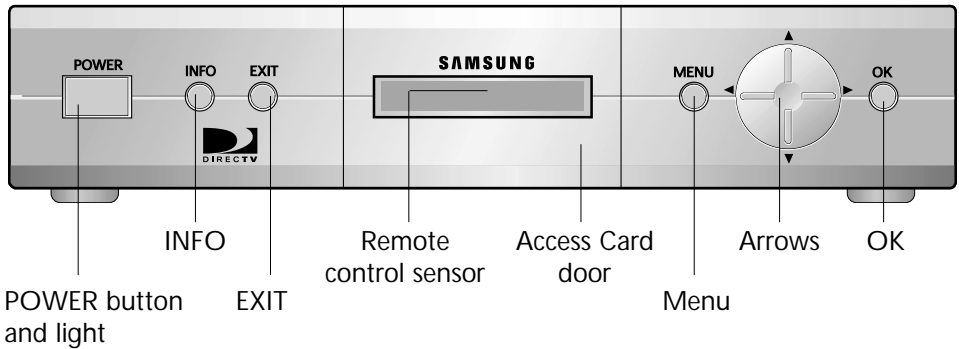

SIR-S310W

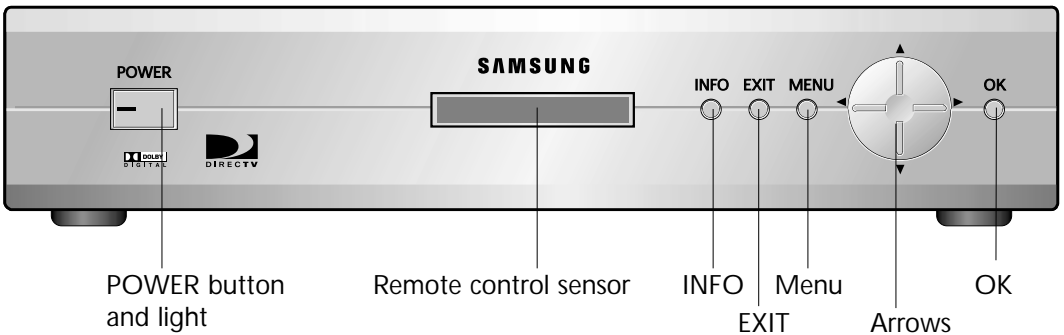

POWER Button and light

Push this button to turn your DIRECTV Receiver on or off. The light glows when power is on.

Remote control sensor

Point your remote control at this sensor when operating your receiver.

Access Card door (Model SIR-S300W only)

This door covers the Access Card slot. This slot holds the Access Card (which allows you to view DIRECTV® programming). The Access Card slot is on the rear panel on model SIR-S310W.

INFO

Push this button to display TV program information.

EXIT

Push this button to clear on-screen displays and return to TV program viewing.

MENU

Push this button to display the Main Menu.

Arrows

Push these buttons to navigate left, right, up, or down in the on-screen Guide and menu system.

OK

Push this button to select a highlighted item in the on-screen Guide and menu system.

Back of the DIRECTV Receiver

The diagram below illustrates the location of the input and output jacks on the back of the receiver. These illustrations may help you as you set up your DIRECTV Receiver. Step-by-step setup instructions appear in Chapter 2.

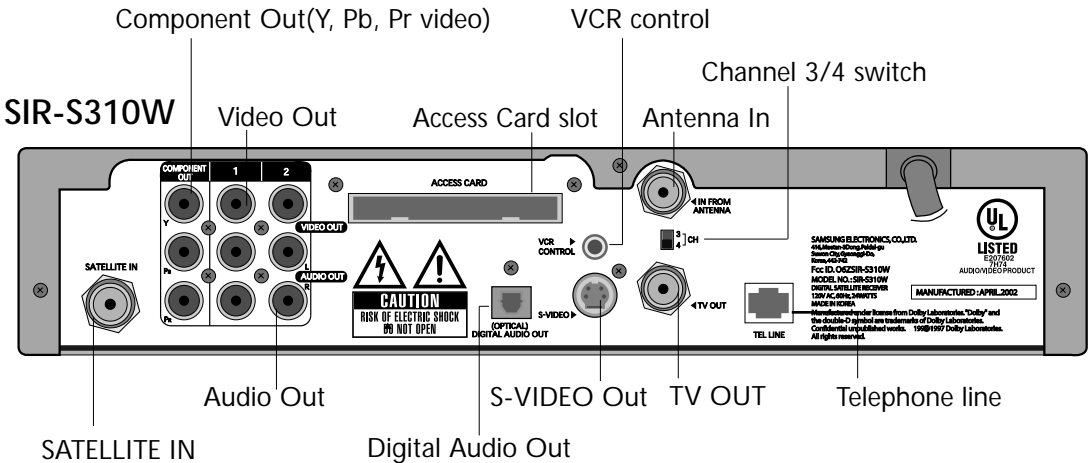
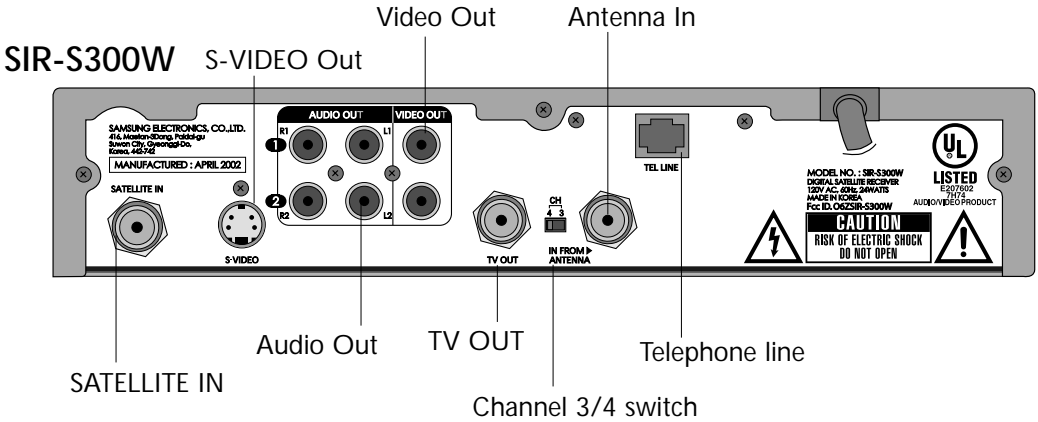

Satellite In

The RG-6 cable from the satellite dish connects to this jack.

Antenna In

The cable from an off-air TV antenna (*not* from the satellite dish) connects to this jack.

Video Out

Using a standard video cable, this jack connects your DIRECTV Receiver to your TV or VCR.

Audio Out

Using standard stereo audio cables, these jacks connect the DIRECTV Receiver to your TV or VCR.

S-Video Out

This jack connects your DIRECTV Receiver to a TV or VCR that accepts S-Video input.

Component Out (Y, Pb, Pr video) (SIR-S310W only)

Using standard A/V cables, these jacks connect your DIRECTV Receiver to a TV or VCR that accepts high-quality ("component") video input.

Digital audio out (SIR-S310W only)

Using an optical digital audio cable, this jack allows you to connect your DIRECTV Receiver to an audio receiver that accepts optical digital audio input.

TV Out

Using an RF coaxial cable, this jack connects the DIRECTV Receiver to your TV or VCR.

Channel 3/4 switch

This switch sets the channel for viewing the TV Out signal on your TV.

Telephone line

A telephone line connected to this jack allows you to order pay per view programming.

VCR control (SIR-S310W only)

The VCR control cable connects to this jack.

Access Card slot (model SIR-S310W only)

This slot holds the Access Card (which allows you to view DIRECTV® programming). The Access Card slot is behind the Access Card door on the front of model SIR-S300W.

Installing the batteries in the remote control

You've unpacked the receiver and reviewed its front and back panels. Now it's time to start setting up. The first step is to install the batteries in your remote control.

- 1 Unlatch the battery compartment cover on the back of remote control.

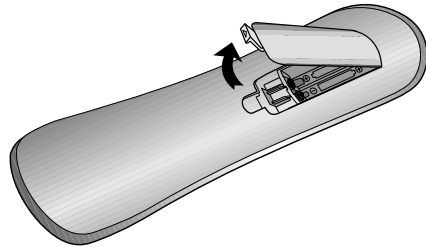

- 2 Insert 2 AAA batteries as shown, making sure the + and - ends of each battery line up with the corresponding marks in the battery compartment.

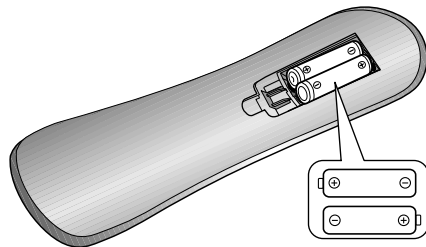

- 3 Snap the cover back onto the remote control.

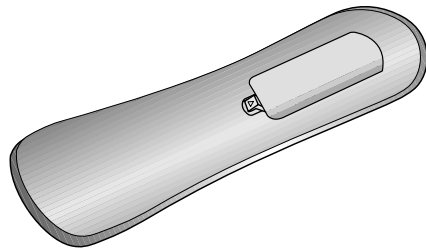

- 4 Test the remote control to make sure the batteries have been inserted correctly. Press the DIRECTV button and make sure the button lights up. If it does not light up, check the orientation of the batteries.

Note: Alkaline batteries are strongly recommended for this remote control.

Inserting the Access Card

The next step is to insert your Access Card into your receiver. (You will not be able to view DIRECTV® programming unless the Access Card is properly inserted into the DIRECTV Receiver.) For some receivers, the card may already be inserted when you unpack the box.

1 Locate the ACCESS CARD slot.

On model SIR-S300W the slot is located on the front of the DIRECTV Receiver, behind the Access Card door.

On model SIRS310W the slot is located on the back of the DIRECTV Receiver.

2 Insert the Access Card.

Make sure the side with the bar code is facing down, and the arrow is pointing away from you.

The Access Card should only be removed when replacing the card with a new one provided by DIRECTV or your program provider.

Model SIR-S300W



Model SIR-S310W

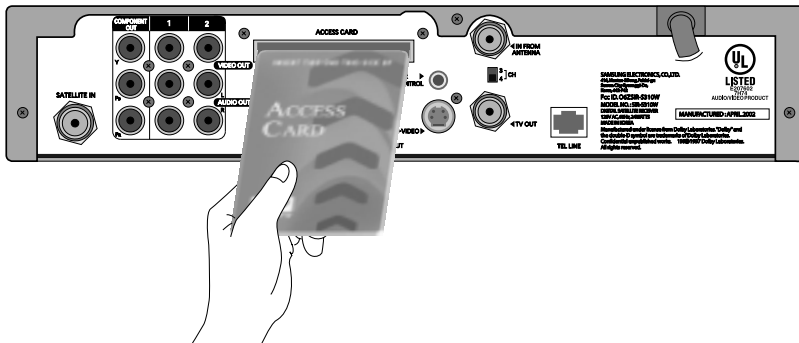

Access Card
(Top view)

Chapter 2: Setting up and connecting

This chapter explains how to setup and start using your DIRECTV Receiver. Contents include:

- Jacks and cables
- Before making connections
- Choosing a connection
- Connection option A: DIRECTV Receiver to TV with RF cable only
- Connection option B: DIRECTV Receiver to TV with A/V cables
- Connection option C: DIRECTV Receiver to TV and VCR with RF cables only
- Connection option D: DIRECTV Receiver to TV and VCR with A/V cables
- Connection option E: DIRECTV Receiver to TV and A/V receiver
- Connection option F (SIR-S310W only): DIRECTV Receiver to TV with Component Video inputs and digital A/V receiver
- Connecting the VCR control cable (model SIR-S310W only)
- Turning on the DIRECTV Receiver for the first time
- Adjusting the satellite dish
- Testing your DIRECTV Receiver
- Activating the DIRECTV account
- DIRECTV® service upgrades

Jacks and cables

The illustrations on these pages show the various types of jacks and cables used to connect your DIRECTV Receiver. If you are unfamiliar with these jacks and cables, take a moment to review them before starting the step-by-step connection process.

RF jacks and coaxial cable

The TV OUT RF jack on the DIRECTV Receiver uses a coaxial cable to connect to your TV or VCR. This jack provides monaural sound and a good TV picture. An RF jack is also used for TV antenna connection (IN FROM ANTENNA), and using an RG-6 coaxial cable, for the satellite dish (SATELLITE IN) input connection.

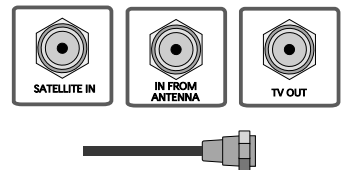

Audio/Video jacks and cables (RCA-type)

Audio/Video jacks and cables provide stereo sound and a better TV picture than RF jacks and cables. Use these jacks and cables to connect your receiver to a TV, VCR, or to other components such as a stereo receiver or amplifier. The audio/video jacks on the back of the receiver and the audio/video cable connectors are color coded (yellow for video, red for right audio, and white for left audio).

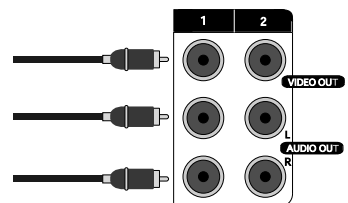

Telephone jack and cord

The TEL LINE jack and the included telephone cord connect your DIRECTV Receiver to a phone line. If your home does not have RJ-11 type phone jacks, please contact your phone company to get one installed.

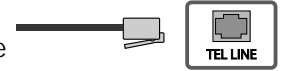

A continuous land-based phone line connection is required for DIRECTV® Pay Per View functionality and Sports subscriptions. Any calls generated by the DIRECTV Receiver are toll-free. These calls are typically made in the middle of the night; your phone is in use for approximately 30 seconds.

S-Video jack and cable (cable included with model SIR-S310W only)

S-Video cables and jacks are used to connect the DIRECTV Receiver to TVs, VCRs, and other video equipment equipped with S-Video input jacks. S-Video connections provide a high-quality TV picture (better than RCA-type A/V jacks and cables). Unlike the round RCA-type connectors, S-Video connectors must be correctly aligned before you can plug in the cable. (This cable carries the video signal only; use with A/V cables for the audio signal.)

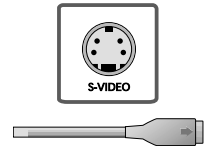

Component video jacks and cables (cable not included, jack on model SIR-S310W only)

The three-cable component video cables and jacks (also referred to as "Y, Pb, Pr") are used to connect the DIRECTV Receiver to TVs, VCRs, A/V receivers and other video equipment equipped with component video input jacks. Component video connections provide a TV picture superior to S-Video connections. (These cables carry the video signal only; use with A/V cables for the audio signal.)

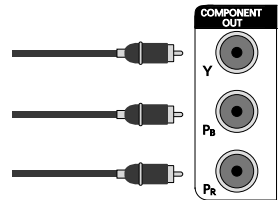

Optical digital audio jack and cable (cable not included, jack on model SIR-S310W only)

Optical digital jacks and cables use light to send digital audio data to A/V receivers equipped to receive and interpret this data. The uniquely shaped connectors on the jacks and cables must be aligned before you can plug in the cable. (Note that the jacks and cables may be covered by protective caps which you must remove before making the connection.)

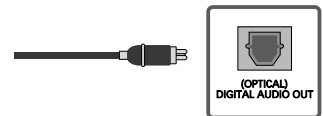

VCR control jack and cable (jack and cable included on SIR-S310W only)

The VCR control jack and cable allow your model SIR-S310W DIRECTV Receiver to send signals to your VCR's remote sensor, giving you the ability to program your VCR to tape programs for you using simple on-screen controls.

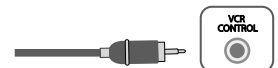

Before making connections

The next steps are to determine which connection option you should use and then to make the necessary connections. Before you begin, please note the following important safety and setup tips.

Protect your components from power surges

- Always turn off and unplug your DIRECTV Receiver, TV, and any other components before connecting or disconnecting any of the cables.

Position all cables correctly to avoid audio hum or interference

- After connecting the components, please run the audio/video cables along the side of the TV set, rather than straight down the back of the TV.
- Make sure that all cables are plugged or screwed tightly into their jacks.
- Please make sure that all antennas and cables are properly grounded.
- Whenever possible, route audio and video cables away from power cords.

Protect your components from overheating

- Do not block ventilation holes in the top of the DIRECTV Receiver, or any other components. Make sure to position the components so that air can circulate freely.
- If you are positioning the components in a stand or rack, make sure to allow for proper ventilation.
- Do not stack components.
- If you have a stereo amplifier or receiver as a system component, please place it on the top shelf or top rack so that hot air rising from it will not flow around other components.

Make strong connections

- Make sure you securely connect cables when making connections. When a tight fit makes a secure connection difficult, you can sometimes make it easier by gently twisting the cable-end while pushing it onto the jack. (Important: never twist S-Video or Optical Digital Audio cables — they have specially shaped ends that must be correctly oriented before connecting.)

Avoid cable damage

- Never kink, bend, or twist optical digital audio cables; doing so might break the fragile optical fibers they contain, rendering them unable to carry a signal.

Choosing a connection

Your DIRECTV Receiver supports a variety of connection possibilities to ensure that it is compatible with whatever type of TV, VCR, or A/V receiver you might have. This manual describes six different setup possibilities in detail. The one that is right for you depends on what type of A/V equipment you have in addition to your DIRECTV Receiver. To get the best audio and video possible with your particular set of A/V equipment, use these pages to choose the connection option that most closely matches your situation.

Option A: DIRECTV Receiver to TV with RF cable only

Option A is the most simple setup option. If you are *not* planning on using a VCR and your TV has *no* A/V connectors, use this option. (Turn to page 17 now.)

Option B: DIRECTV Receiver to TV with A/V cables

Option B is also for people not planning on using a VCR, but this option improves the sound and video quality by making the connections using A/V cables. If you are *not* planning to use a VCR, but your TV *does* have RCA-type A/V input jacks, use connection Option B. (Turn to page 19 now.)

Option C: DIRECTV Receiver to TV and VCR with RF cables only

Option C is the simplest connection option that includes a VCR. If you want to connect your DIRECTV Receiver to a TV and VCR, and your TV or VCR *does not* have A/V jacks, use connection Option C. (Turn to page 21 now.)

Option D: DIRECTV Receiver to TV and VCR with A/V cables

Option D also allows you to connect the DIRECTV Receiver to a TV and VCR, but Option D provides improved sound and video quality over Option C. If you are planning to connect your DIRECTV Receiver to a TV and VCR which *both* have A/V jacks, use connection Option D. (Turn to page 23 now.)

Option E: DIRECTV Receiver to TV and A/V receiver

Option E shows you how to connect the DIRECTV Receiver to an A/V system that includes an A/V receiver. If you plan to use an A/V receiver with your DIRECTV Receiver and TV, use connection Option E. (Turn to page 25 now.)

Option F: DIRECTV Receiver to TV with component video inputs and Digital A/V receiver (SIR-S310W only)

Option F also shows you how to connect the DIRECTV Receiver to an A/V setup that includes a TV and an A/V receiver. In Option F, however, the A/V receiver supports optical digital audio input, and the TV supports component (Y, Pb, Pr) video input. If this matches your situation, use connection Option F. (Turn to page 27 now.)

Connection option A: DIRECTV Receiver to TV with RF cable only

**If connection option A best matches your needs,
follow these steps:**

- 1** Make sure your TV and DIRECTV Receiver are turned off and unplugged.
- 2** Connect the RG-6 coaxial cable running from your satellite dish to the SATELLITE IN jack on the back of your DIRECTV Receiver.
- 3** Connect the coaxial cable running from your cable TV system or off-air TV antenna to the IN FROM ANTENNA jack on the back of the DIRECTV Receiver.
- 4** Connect the supplied phone cord to a telephone wall jack and to the TEL LINE jack on the back of the DIRECTV Receiver.
- 5** Connect the supplied coaxial cable to the Antenna In jack on your TV and to the TV OUT jack on the back of the DIRECTV Receiver.
- 6** Plug in the power cords for your DIRECTV Receiver and TV.

To watch DIRECTV® programming

To watch DIRECTV® programming, tune your TV to channel 3 or 4 (depending on the position of the CH 3/4 switch on the back of your DIRECTV Receiver). Channel 3 is the default setting.

Next Step

Now turn to page 29 to start using your DIRECTV Receiver.

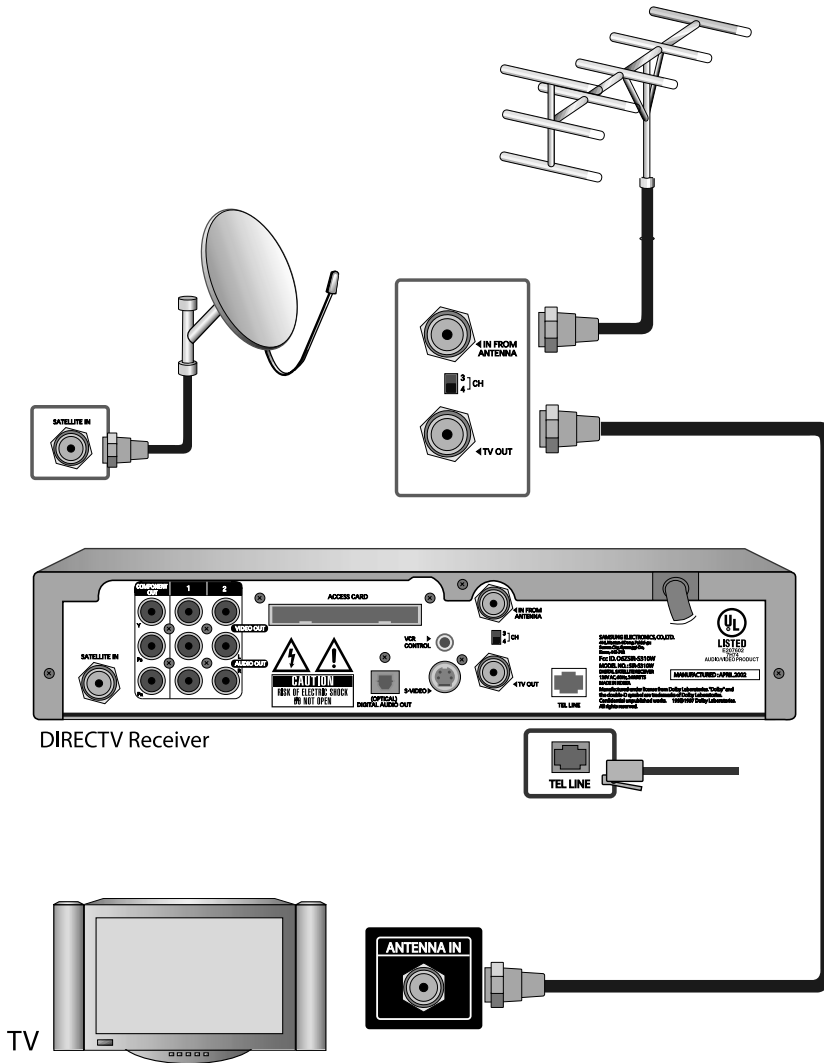

Note: DIRECTV Receiver model SIR-S310W shown; connections are the same for model SIR-S300W.

Connection option B: DIRECTV Receiver to TV with A/V cables

If connection option B best matches your needs, follow these steps:

- 1** Make sure your TV and DIRECTV Receiver are turned off and unplugged.
- 2** Connect the RG-6 coaxial cable running from your satellite dish to the SATELLITE IN jack on the back of your DIRECTV Receiver.
- 3** Connect the coaxial cable running from your cable TV system or off-air TV antenna to the IN FROM ANTENNA jack on the back of the DIRECTV Receiver.
- 4** Connect the supplied phone cord to a telephone wall jack and to the TEL LINE jack on the back of the DIRECTV Receiver.
- 5** Matching like colors, connect the supplied A/V cable to the AUDIO OUT and VIDEO OUT jacks on the back of the DIRECTV Receiver.
- 6** Connect the other ends of the A/V cables to the audio and video input jacks on your TV. Be sure to connect the outputs on the DIRECTV Receiver to corresponding inputs on your TV (video out to video in, left audio out to left audio in, right audio out to right audio in).
- 7** (Optional) if your TV has an S-Video input jack, connect one end of an S-Video cable to the S-VIDEO jack on the back of the DIRECTV Receiver. Connect the other end of this cable to the S-Video In jack on the back of your TV. This step is optional; it provides improved picture quality on some TVs.
- 8** Plug in the power cords for your DIRECTV Receiver and TV.

To watch DIRECTV® programming

Set your TV to the appropriate input mode. This is a setting on your TV usually controlled by a Video, Input, or Mode button. See the manual for your TV for instructions.

Next Step

Now turn to page 29 to start using your DIRECTV Receiver.

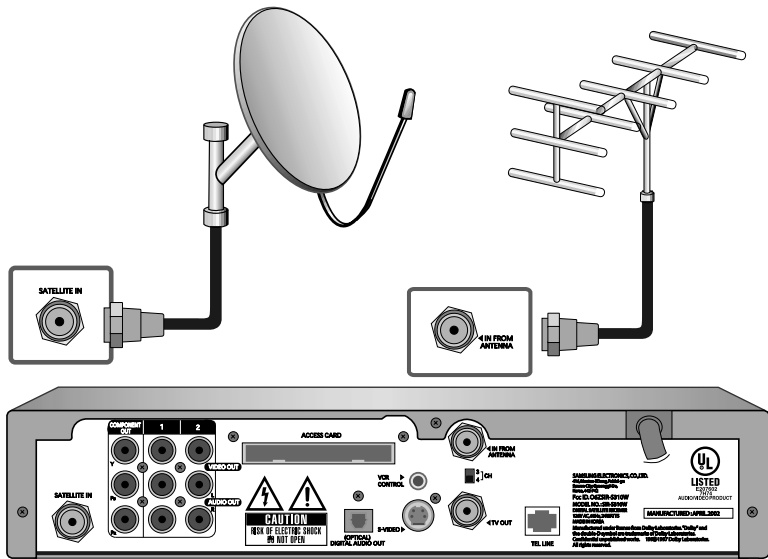

DIRECTV Receiver

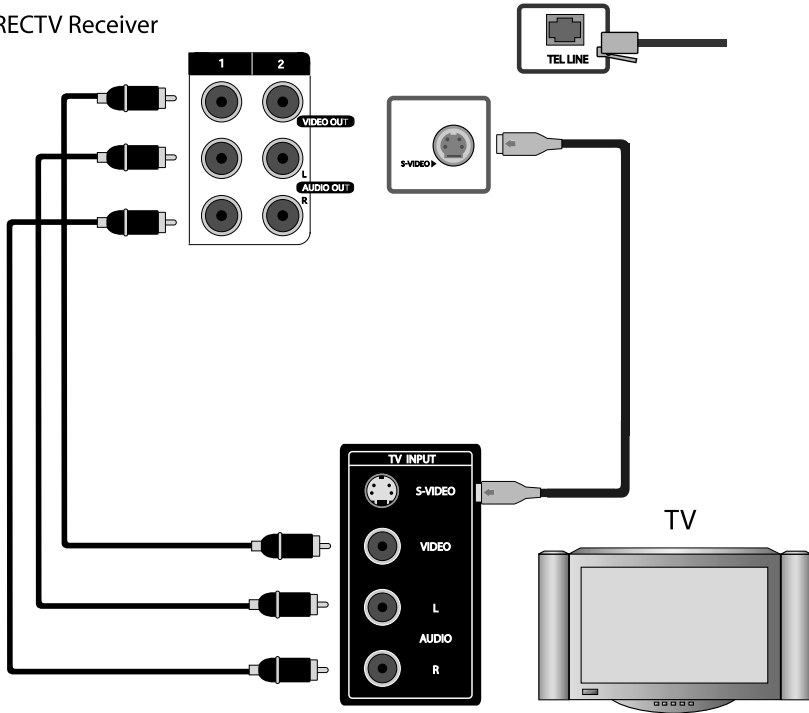

Note: DIRECTV Receiver model SIR-S310W shown; connections are the same for model SIR-S300W.

Connection option C: DIRECTV Receiver to TV and VCR with RF cables only

If connection option C best matches your needs, follow these steps:

- 1** Make sure your TV, VCR, and DIRECTV Receiver are turned off and unplugged.
- 2** Connect the RG-6 coaxial cable running from your satellite dish to the SATELLITE IN jack on the back of your DIRECTV Receiver.
- 3** Connect the coaxial cable running from your cable TV system or off-air TV antenna to the IN FROM ANTENNA jack on the back of the DIRECTV Receiver.
- 4** Connect the supplied phone cord to a telephone wall jack and to the TEL LINE jack on the back of the DIRECTV Receiver.
- 5** Connect one end of the supplied coaxial cable to the TV OUT connector on the back of the DIRECTV Receiver. Connect the other end of this cable to the Antenna In jack on your VCR.
- 6** Connect one end of another coaxial cable (not included) to the TV Out RF jack on the back of your VCR. Connect the other end of this cable to the Antenna In jack on the back of your TV.
- 7** (Optional, model SIR-S310W only) go to page 29 to hook up the VCR control.
- 8** Plug in the power cords for your TV, VCR, and DIRECTV Receiver.

To watch DIRECTV® programming

With your VCR in TV mode or powered off, tune your TV to channel 3 or 4 (depending on the position of the CH 3/4 switch on the back of your DIRECTV Receiver). Channel 3 is the default setting. The position of the CH 3/4 switch on your DIRECTV Receiver should match the setting of the similar CH 3/4 switch on your VCR.

Next Step

Now turn to page 29 to start using your DIRECTV Receiver.

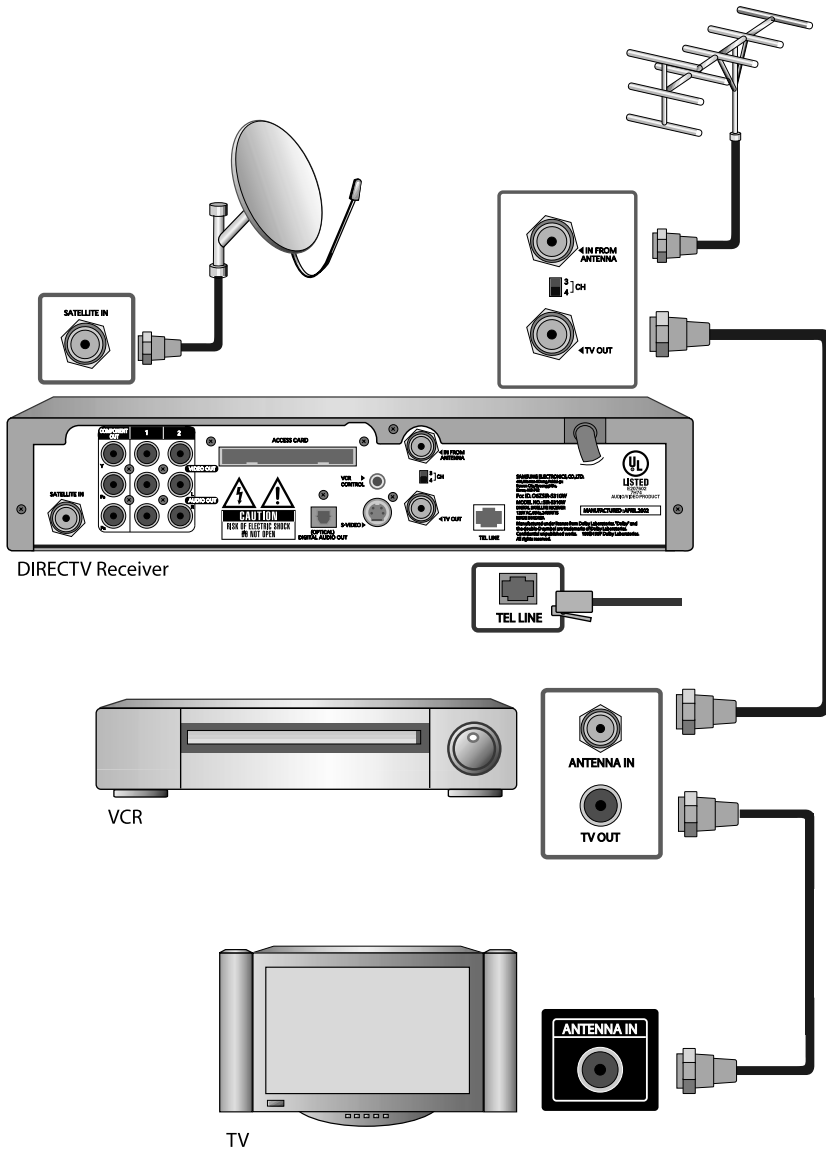

Note: DIRECTV Receiver model SIR-S310W shown; connections are the same for model SIR-S300W.

Connection option D: DIRECTV Receiver to TV and VCR with A/V cables

If connection option D best matches your needs, follow these steps:

- 1 Make sure your TV, VCR, and DIRECTV Receiver are turned off and unplugged.
- 2 Connect the RG-6 coaxial cable running from your satellite dish to the SATELLITE IN jack on the back of your DIRECTV Receiver.
- 3 Connect the coaxial cable running from your cable TV system or off-air TV antenna to the IN FROM ANTENNA jack on the back of the DIRECTV Receiver.
- 4 Connect the supplied phone cord to a telephone wall jack and to the TEL LINE jack on the back of the DIRECTV Receiver.
- 5 Matching like colors, connect the supplied A/V cables to the AUDIO OUT and VIDEO OUT jacks on the back of the DIRECTV Receiver.
- 6 Connect the other ends of these A/V cables to the audio and video input jacks on your VCR. Be sure to connect the A/V jacks on the DIRECTV Receiver to corresponding *inputs* on your VCR (video out to video in, left audio out to left audio in, right audio out to right audio in).
- 7 Matching like colors, connect another set of A/V cables (not included) to the other set of audio and video output jacks on the back of the DIRECTV Receiver. Connect the other ends of these cables to the audio and video input jacks on your TV. Be sure to connect the *outputs* on the DIRECTV Receiver to corresponding *inputs* on your TV.
- 8 (Optional) if your TV and VCR both have S-Video jacks, you can also make the S-Video connections shown in the illustration. This step is optional; it provides improved picture quality.
- 9 (Optional, model SIR-S310W only) go to page 29 to hook up the VCR control.
- 10 Plug in the power cords for your TV, VCR, and DIRECTV Receiver.

To watch DIRECTV® programming

Set your TV to the appropriate input mode. (This is a setting on your TV usually controlled by a Video, Input, or Mode button. See your TV manual for help.) Also make sure your VCR is turned on.

Next Step

Now turn to page 29 to start using your DIRECTV Receiver.

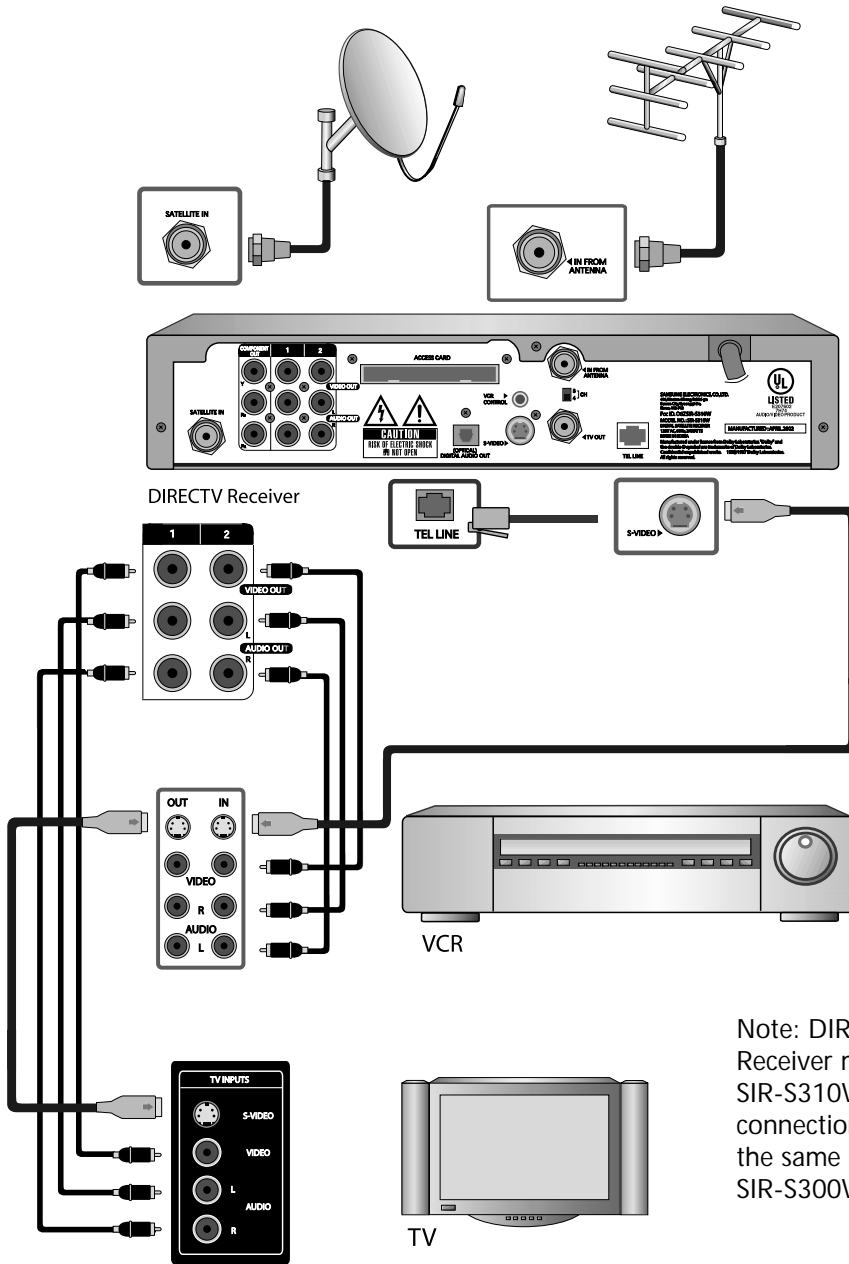

Note: DIRECTV Receiver model SIR-S310W shown; connections are the same for model SIR-S300W.

Connection option E: DIRECTV Receiver to TV and A/V receiver

If connection option E best matches your needs, follow these steps:

- 1** Make sure your TV, A/V receiver, and DIRECTV Receiver are turned off and unplugged.
- 2** Connect the RG-6 coaxial cable running from your satellite dish to the SATELLITE IN jack on the back of your DIRECTV Receiver.
- 3** Connect the coaxial cable running from your cable TV system or off-air TV antenna to the IN FROM ANTENNA jack on the back of the DIRECTV Receiver.
- 4** Connect the supplied phone cord to a telephone wall jack and to the TEL LINE jack on the back of the DIRECTV Receiver.
- 5** Matching like colors, connect the supplied A/V cable to the AUDIO OUT and VIDEO OUT jacks on the back of the DIRECTV Receiver.
- 6** Connect the other ends of the A/V cables to appropriate audio and video input jacks on your A/V receiver. Be sure to connect the outputs on the DIRECTV Receiver to corresponding inputs on your A/V receiver (video out to video in, left audio out to left audio in, right audio out to right audio in).
- 7** Connect another set of A/V cables (not included) to the second set of audio and video output jacks on the the back of the DIRECTV Receiver.
- 8** Connect the other ends of these A/V cables to the appropriate audio and video input jacks on your TV. Be sure to connect the outputs on the DIRECTV Receiver to corresponding inputs on your TV.
- 9** (Optional) if your TV and A/V receiver both have S-Video jacks, you can also make the S-Video connections shown in the illustration. This step is optional; it provides improved picture quality.
- 10** Plug in the power cords for your TV, A/V receiver, and DIRECTV Receiver.

To watch DIRECTV® programming

Set your A/V receiver and TV to the appropriate input mode. See the manuals for your A/V receiver and TV for instructions.)

Next Step

Now turn to page 29 to start using your DIRECTV Receiver.

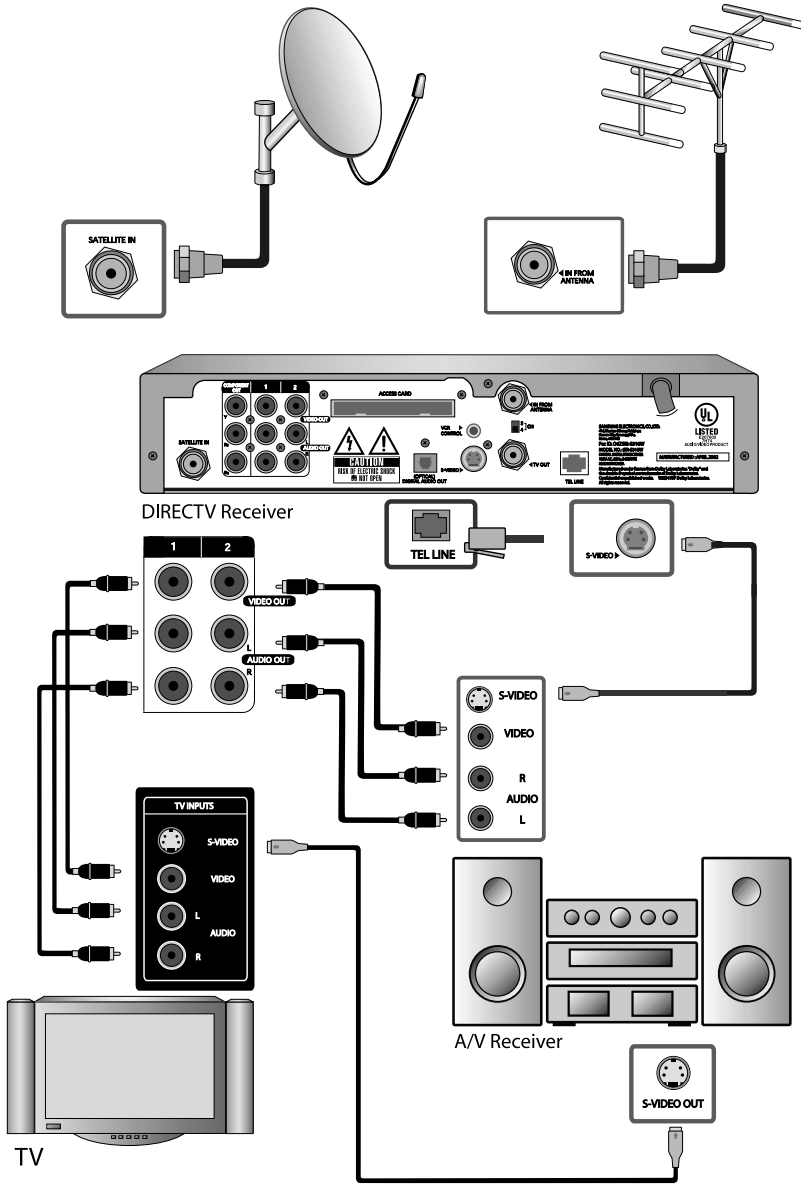

Note: DIRECTV Receiver model SIR-S310W shown; connections are the same for model SIR-S300W.

Connection option F (SIR-S310W only): DIRECTV Receiver to TV with Component Video inputs and digital A/V receiver

- 1 Make sure your TV, A/V receiver, and DIRECTV Receiver are turned off and unplugged.
- 2 Connect the RG-6 coaxial cable running from your satellite dish to the SATELLITE IN jack on the back of your DIRECTV Receiver.
- 3 Connect the coaxial cable running from your cable TV system or off-air TV antenna to the IN FROM ANTENNA jack on the back of the DIRECTV Receiver.
- 4 Connect the supplied phone cord to a telephone wall jack and to the TEL LINE jack on the back of the DIRECTV Receiver.
- 5 Connect one end of a set of three component video cables (not included) to the COMPONENT OUT jacks on the back of the DIRECTV Receiver.
- 6 Connect the other ends of these cables to the component video input jacks on your TV. Be sure to connect the outputs on the DIRECTV Receiver to corresponding inputs on your TV (Y out to Y in, Pb out to Pb in, Pr out to Pr in).
- 7 Connect one end of the supplied A/V cable's audio connectors (the red and white connectors) to the AUDIO OUT jacks on the back of the DIRECTV Receiver. (You can leave the yellow video connector on this cable disconnected.)
- 8 Connect the other ends of the audio cables to the audio *input* jacks on your TV (again leaving the yellow video connector disconnected).
- 9 Remove the protective plug from the OPTICAL DIGITAL AUDIO OUT jack. Then connect an optical digital audio cable (not included) to the OPTICAL DIGITAL AUDIO OUT jack on the back of the DIRECTV Receiver.
- 10 Connect the other end of this cable to an appropriate optical digital audio In jack on your A/V receiver.
- 11 Plug in the power cords for your TV, A/V receiver, and DIRECTV Receiver.

To watch DIRECTV® programming

Set your TV to the Component Video input mode. (This is a setting on your TV usually controlled by a Video, Input, or Mode button. See your TV manual for help.) Also set your A/V receiver to play the audio from the Digital Input jack you used to make the audio connection. See your A/V receiver manual for help.

Next Step

Now turn to page 29 to start using your DIRECTV Receiver.

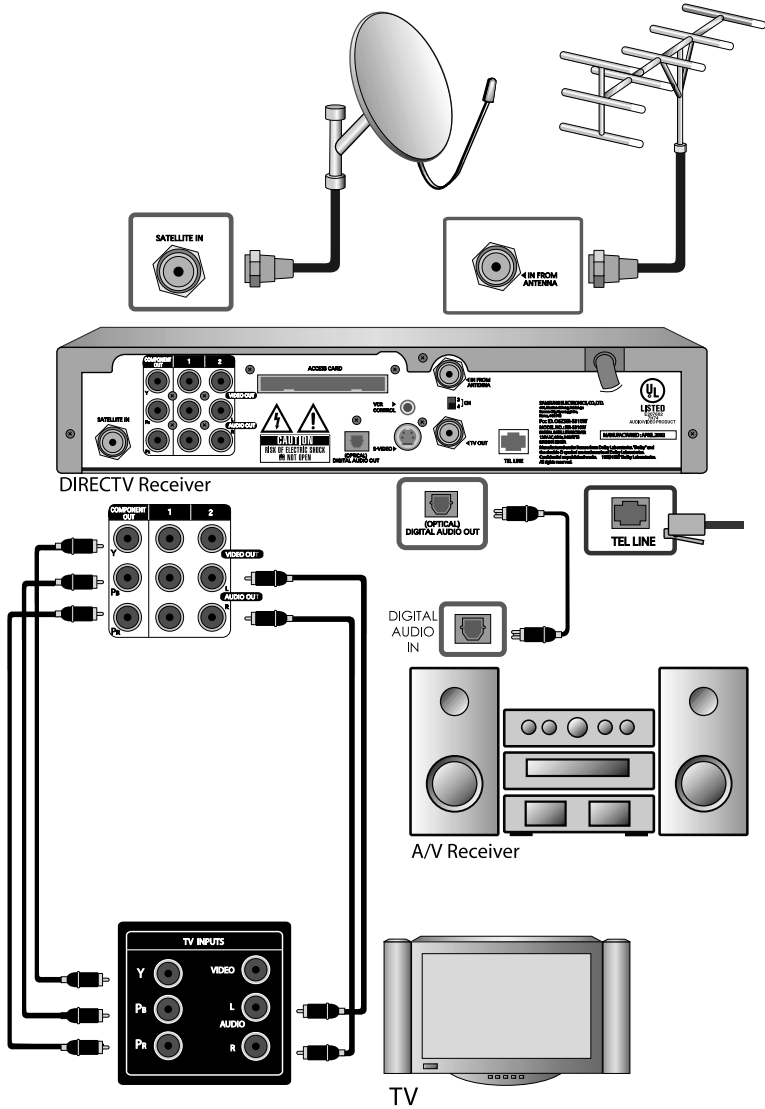

Connecting the VCR control cable (model SIR-S310W only)

The VCR control cable allows your model SIR-S310W DIRECTV Receiver to automatically program your VCR to record a TV program. By selecting a *Record* option from the on-screen Program Guide, you can direct the VCR control cable to flash signals to the VCR's remote control sensor programming the VCR to tape a TV program for you.

To connect the VCR control cable to your model SIR-S310W DIRECTV Receiver, follow these steps:

- 1 Plug the VCR control cable into the VCR CONTROL jack on the back of the DIRECTV Receiver.
- 2 Remove the backing tape from the adhesive on the other end of the VCR control cable. Stick the VCR control onto the remote control sensor on your VCR. (See the manual for your VCR if you are not sure where its remote sensor is located.).

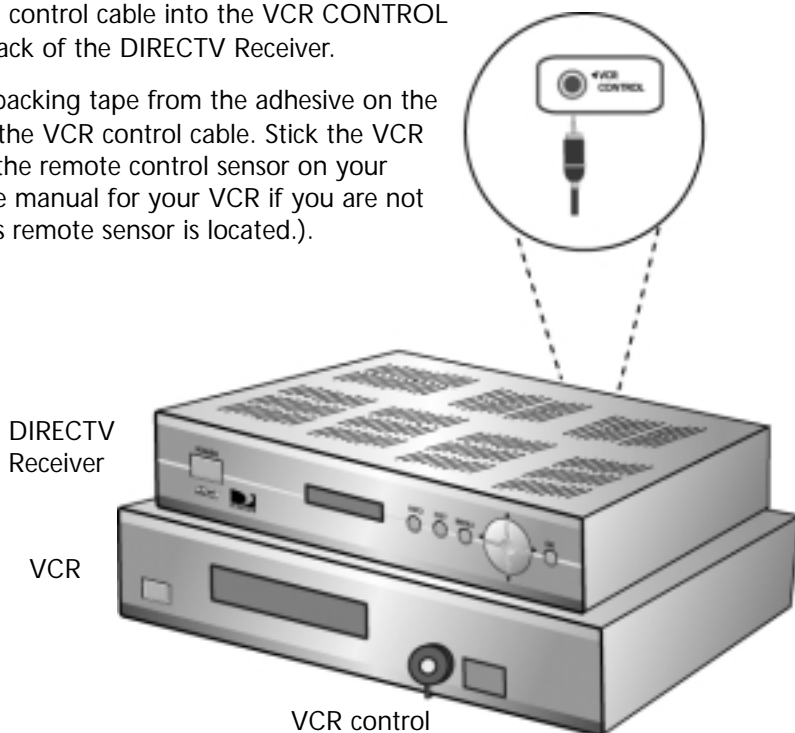

Note: Before you can use the VCR control cable to program your VCR, you must set up the VCR control. See *Setting up the VCR control* in Chapter 4 for details.

Turning on the DIRECTV Receiver for the first time

You have completed the setup steps and are ready to start using your DIRECTV Receiver. The first step is to turn on the DIRECTV Receiver.

- 1 Turn on your TV and set it to display the signal from your DIRECTV Receiver.

If you connected the DIRECTV Receiver to an RF-type input jack, you will need to tune your TV to channel 3 or 4 (depending on how the CH 3/4 switch on the back of the DIRECTV Receiver is set). If you have a VCR, the VCR must be in TV mode or turned off.

If you connected the DIRECTV Receiver to A/V input jacks on your TV, you will need to set your TV to display the input from these jacks. Usually this is done by pressing a Video, Input, or Mode button on your TV's remote control. (See the manual for your TV if you need help.)

- 2 Press the POWER button on the DIRECTV Receiver's remote control or on the front of the DIRECTV Receiver.

The light on the front panel will turn on.

If this is the first time you have turned on your DIRECTV Receiver, it will take a few moments to acquire the program guide from the satellite. During this process, the Progress screen appears.

When the program guide has been fully acquired, the Progress screen clears and the TV screen is displayed. You are ready to continue setting up your DIRECTV System.

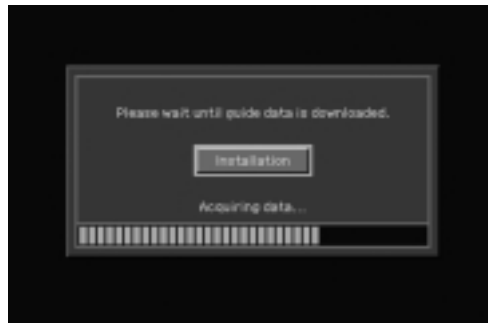

Adjusting the satellite dish

If your DIRECTV Receiver is able to acquire the program guide and display TV programs, your satellite dish is setup and working. You can skip ahead to the section on *Activating your DIRECTV account* at the end of this chapter.

If your DIRECTV Receiver cannot acquire the program guide, you may need to adjust the way your satellite dish is installed. To do this, first make sure your TV and DIRECTV Receiver are turned on and connected to each other properly. Then follow the instructions below to use your DIRECTV Receiver's Menu system to set up your satellite dish.



The *Installation* option in the *SETUP* menu provides access to a variety of important setup controls. The first of these is the *Set Dish* menu. The *Set Dish* menu allows you to:

- Acquire the exact azimuth, elevation, and tilt angles to help you point your dish accurately based on your ZIP code.
- Check the setup of your satellite dish using an on-screen signal meter.
- Set the dish type (to tell your DIRECTV Receiver what kind of satellite dish you are using).
- Set your dish type automatically.

The sections that follow detail each of these procedures.

Acquiring the correct dish pointing angles

The *Dish Pointing* menu item in the *Set Dish* menu allows you to find out exactly how to point your satellite dish by entering your ZIP code. If you have not yet successfully aligned your satellite dish, or if you need to realign it, follow these instructions to find the exact angles you should use to point your dish:

- 1 Press the MENU button on your remote control.
The Main menu appears.
- 2 Use the arrow buttons on your remote control to highlight the *SETUP* menu item, then press the  button on your remote control.
The *SETUP* menu appears.
- 3 Use the arrow buttons on your remote control to highlight the *Installation* menu item, then press the  button on your remote control.
The *Installation* menu appears.
- 4 Use the arrow buttons on your remote control to highlight the *Set Dish* menu item, then press the  button on your remote control.

The *Set Dish* menu appears.

- 5 Use the arrow buttons on your remote control to highlight the *Dish Pointing* menu item, then press the  button on your remote control.



The *Dish Pointing* screen appears.

- 6 Use the right-arrow button on your remote control to highlight the space for the first digit in the ZIP code.
- 7 Use the 0 - 9 buttons on your remote control to enter your five-digit ZIP code.

As you enter each number, the highlight advances to the next space.



When you have entered all five digits, the screen updates to display the correct azimuth, elevation, and (for oval dish types only) tilt.

Azimuth refers to the left-to-right angle to which you should point your dish.

Elevation refers to the up-and-down angle to which you should point your dish.

Tilt (for oval dishes only) refers to the amount off-horizontal you should twist the dish on its axis.



Write down these numbers and use them to accurately point your satellite dish.

- 8 To return to the *Set Dish* menu, press the BACK button on your remote control. To exit the Menu system, press the EXIT button on your remote control.

Checking the satellite signal strength

The *Signal Meter* allows you to check the strength of the signal from the satellite to your satellite dish. This is useful while setting up your satellite dish, and while troubleshooting any reception problems you may encounter. Satellite signal strength can be affected by how accurately you have pointed the satellite dish, and by any obstructions between the satellite and the satellite dish (tree limbs, for example).

To check your satellite signal strength, follow these steps:

- 1 Press the MENU button on your remote control.
The Main menu appears.
- 2 Use the arrow buttons on your remote control to highlight the *SETUP* menu item, then press the  button on your remote control.
The *SETUP* menu appears.
- 3 Use the arrow buttons on your remote control to highlight the *Installation* menu item, then press the  button on your remote control.
The *Installation* menu appears.
- 4 Use the arrow buttons on your remote control to highlight the *Set Dish* menu item, then press the  button on your remote control.
The *Set Dish* menu appears.



- 5 Use the arrow buttons on your remote control to highlight the *Signal Meter* menu item, then press the  button on your remote control.

The *Signal Meter* screen appears.

The signal meter starts checking the satellite signal strength immediately. The signal strength (from 0-to-100%) is indicated at the bottom of the screen.



The *Signal Meter* screen allows you to check signal strengths from different *Satellites*, and different *Transponders*. The *Satellites* option applies only to oval-shaped satellite dishes which receive signals from multiple satellites. On round dishes, the *Satellite* setting is fixed.

Transponders are the equipment on satellites that receive the signal from the earth-based program providers and relay it back to earth to your satellite dish. Different transponders handle the signals for different TV channels. When setting up your satellite dish, you should try to maximize the signal strength across all of the satellites and transponders.

- 6 To check the signal strength for different satellites (oval dishes only), or different transponders, use the left- and right-arrow buttons on your remote control to highlight the on-screen *Satellite* or *Transponder* option, then use the up- and down-arrow buttons to change the setting.

The signal meter updates to show you the signal strength for the new satellite or transponder.

Setting the dish type

To function properly, your DIRECTV Receiver needs to know what type of satellite dish you are using. You can specify the dish type using the instructions here, or you can follow the steps on page 35 to use the *Auto Detection* menu item to automatically set the dish type. To manually set the dish type:

- 1 If the Progress screen (shown here) is on your TV screen, select *Installation* by pressing the  button on your remote control.

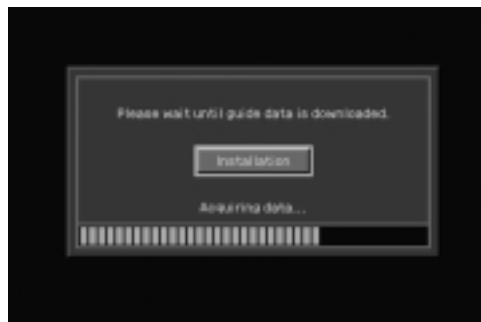

If this screen is not displayed, access the Main Menu by pressing the MENU

button on your remote control. Then use the arrow buttons on your remote control to highlight the *Setup* menu, and press the button. Then highlight the *Installation* menu, and press the button.

The *Installation* menu appears.

- 2 Use the arrow buttons on your remote control to highlight the *Set Dish* menu item, then press the button on your remote control.



The *Set Dish* menu appears.

- 3 Use the arrow buttons on your remote control to highlight the *Select Dish Type* menu item, then press the button on your remote control.



The *Select Dish Type* screen appears.

- 4 Use the right-arrow button on your remote control to highlight the *Dish Type* option on the *Select Dish Type* screen.
- 5 Use the up- and down-arrow buttons on your remote control to display the dish type you are using (*Round*, *Oval-2*, or *Oval-3*).

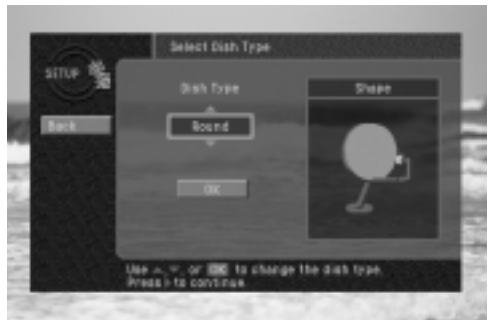

As you display each dish type, the on-screen pictures update showing you what each of these dish types look like.

- When you have displayed the correct dish type, use the right-arrow button on your remote control to highlight the on-screen *OK* button, then press the  button on your remote control.

A message appears warning you that your DIRECTV Receiver needs to reboot (turn itself off and on) for the *Dish Type* setting to take effect.

- To change the *Dish Type* to the new setting, use the arrow buttons on your remote control to highlight the on-screen *OK* button, then press the  button on your remote control.

To leave the *Dish Type* setting



unchanged, highlight the on-screen *Cancel* button, and press the  button on your remote control.



Using Auto Detection to set the dish type

To function properly, your DIRECTV Receiver needs to know what type of satellite dish you are using. You can specify the dish type using the instructions on page 33, or you can follow the steps below to use the *Auto Detection* menu item to automatically set the dish type.

Before you can use *Auto Detection* to set the dish-type, the dish must be correctly aligned and the DIRECTV Receiver must be receiving a strong signal from the satellite (that is, signal-lock must be established). To check the satellite signal, use the signal meter — see page 32 for details.)

- Press the *MENU* button on your remote control.
The *Main* menu appears.
- Use the arrow buttons on your remote control to highlight the *SETUP* menu item, then press the  button on your remote control.
The *SETUP* menu appears.
- Use the arrow buttons on your remote control to highlight the *Installation* menu item, then press the  button on your remote control.
The *Installation* menu appears.

- Use the arrow buttons on your remote control to highlight the *Set Dish* menu item, then press the button on your remote control.

The *Set Dish* menu appears.

- Use the arrow buttons on your remote control to highlight the *Auto Detection* menu item, then press the button on your remote control.



The *Auto Detection* screen appears. The DIRECTV Receiver starts attempting to identify the dish type.

You can stop the detection process by using the arrow buttons on your remote control to highlight the on-screen *Cancel* button, then press the button on your remote control.

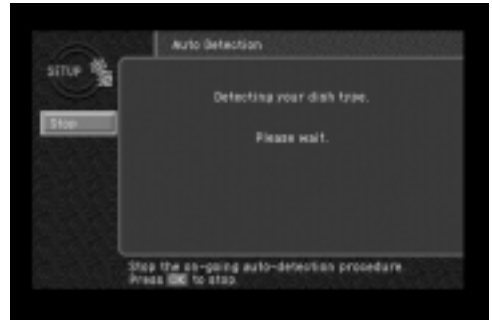

Once the dish type has been identified, a screen appears telling you what type of satellite dish you have.

- To accept the detected dish type setting, use the arrow buttons on your remote control to highlight the on-screen *Back* button, then press the button on your remote control.



Testing the DIRECTV Receiver

The *System Test* feature allows you to quickly check the status of the satellite signal, your Access Card, and your phone line connection. This is helpful in troubleshooting should you experience problems with your DIRECTV Receiver.

To start the System Test, follow these steps:

- Press the MENU button on your remote control.

The Main menu appears.

- Use the arrow buttons on your remote control to highlight the *SETUP* menu item, then press the button on your remote control.

The *SETUP* menu appears.

- 3 Use the arrow buttons on your remote control to highlight the *System* menu item, then press the button on your remote control.

The *System* menu appears.

- 4 Use the arrow buttons on your remote control to highlight the *System Test* menu item, then press the button on your remote control.

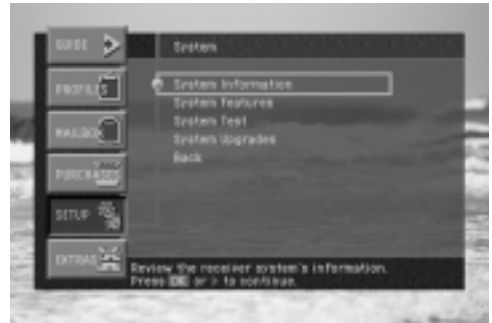

The *System Test* screen appears.

The test will begin as soon as the screen appears. Results are displayed in a moment.

If the test discovers a problem with the satellite tuning, check that the satellite dish is pointed properly, and that nothing is obstructing the direct view to the satellite (over time trees can grow enough to block a previously open view).

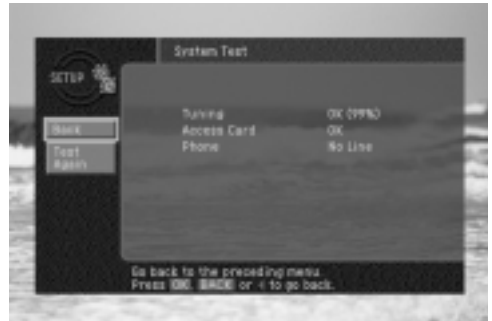

If the test discovers a problem with the Access Card, check that the card is properly inserted. (See *Inserting the Access Card* in Chapter 1 for details.)

For problems with the phone line connection, be sure that the DIRECTV Receiver is connected to a phone line, and that the phone line is working. (Try plugging a telephone into the line you are using for the DIRECTV Receiver; check to see if the phone gets a dial tone. If so, the line is working.)

- 5 When you have finished the system test, you can run the test again using the on-screen *Test Again* button, exit the Menu system by pressing the EXIT button on your remote control, or use the arrow keys to highlight on-screen *Back* button, then press the button to return to the *System* menu.

Activating your DIRECTV account

After you have installed and connected the the satellite dish and DIRECTV Receiver, you must contact your service provider to create an account. To order programming from DIRECTV, please call 1-800-DIRECTV (1-800-347-3288).

With this Digital Satellite Receiver and the proper Satellite Dish Antenna, you may be able to receive local channels from DIRECTV in certain markets. Additional equipment may be required in some areas. Check with your retailer or visit www.DIRECTV.com for information on availability of local channels from DIRECTV in your area.

ACTIVATION OF PROGRAMMING MAY BE SUBJECT TO CREDIT APPROVAL AND REQUIRES VALID SERVICE ADDRESS, SOCIAL SECURITY NUMBER AND/OR MAJOR CREDIT CARD. DEPOSIT OR PREPAYMENT MAYBE REQUIRED.

Programming subject to change. Rec of DIRECTV Programming is subject to terms of the DIRECTV customer agreement; a copy is provided at DIRECTV.com and in your first bill. You must be physically located in the U.S. to receive DIRECTV® service. DIRECTV® services not available outside the U.S. DIRECTV® programming is sold separately and independently of DIRECTV System hardware. A valid programming subscription is required to operate DIRECTV System hardware.

Upgrades

Your digital satellite receiver is able to receive upgrades or modifications to some of its features and functions. These modifications will occur automatically, usually at times when the receiver would likely be turned off.

If your receiver is on when an upgrade or modification is sent, you may experience a disruption in reception for a minute or two. Your reception should return to normal after the modification is complete. Your receiver must be plugged in to receive any upgrades. Do not unplug your receiver while an upgrade is in progress. Please consult the *System Upgrades* menu item (in the *System* section of the *Setup* menu) to find a schedule of upgrades or modifications planned by DIRECTV.

Chapter 3: Watching TV

This chapter covers all of the things you can do with the Program Guides and other features that let you control the way you watch TV. Specifically, it contains information on:

- Remote control overview
- Changing channels
- Adjusting the volume
- Getting help
- Getting information on the TV program you are watching
- Finding out what's on: the Guides
- Searching for programs in the Guide
- Choosing an alternate audio format for a program
- Changing the User setting
- Pay per view programs

Remote control overview

Here is a quick review of the buttons on your DIRECTV Receiver's remote control.

Before your DIRECTV Receiver's remote control can operate your TV, VCR, DVD player, or other device, you must first program the remote control to operate that device. See *Chapter 7: Programming the remote control*.

POWER

Press the POWER button to turn the device you are controlling on or off.

SET

Use this button when programming your remote control to operate your TV, VCR, DVD player, or an auxiliary device (AUX). See *Chapter 7, Programming the remote control*.

TV, VCR, DVD, AUX

This row of buttons tells your remote control which device you want to operate. For example, to start playing a DVD, you would press the DVD button, then press the Play button. These buttons work only after the remote control has been programmed — see *Chapter 7*.

DIRECTV

Press this button to make the remote control operate your DIRECTV Receiver (e.g. to change channels, access the Guide, or get information about a program). Your remote control does not need to be programmed to operate your DIRECTV Receiver.



VOL+/-

Press these buttons to adjust the volume level of your TV (once the remote control has been programmed — see *Chapter 7*). You can control the volume of your TV when in TV, DIRECTV, or VCR mode.

MUTE

Press this button to mute or unmute the TV audio (once the remote control has been programmed — see *Chapter 7*).

TV/VIDEO

Press this button to switch the TV between its video input modes (once the remote control has been programmed — see *Chapter 7*).

CH+/-

Press these buttons to change channels on your DIRECTV Receiver or on your TV (once the remote control has been programmed — see *Chapter 7*).

INFO

Press this button when you are watching DIRECTV® programming to display the Channel Banner and information about the current program.

HELP

Displays instructions about the screen or menu currently displayed.

WHO

Press to change the current user profile.

QUICK

Press this button to view the Quick Guide.

MENU

Press this button to display the on-screen Menu.

GUIDE

Press to view the on-screen Program Guide.



Press this button to select highlighted items in the on-screen Menu or Guide. This button also accesses DIRECTV INTERACTIVE™ program enhancements when you see the i icon appears on your TV screen.

Up/Down/Left/Right arrows

Use these buttons to move the highlight to any on-screen Guide or Menu selection.

BACK

Press this button to return to the previous channel you were watching, or to return to a previous Menu screen.

EXIT

Press this button to exit any Guide or Menu screen and return to the TV program you were watching.

CALLER ID (red button)

Displays the phone numbers of callers who phoned you on the telephone line connected to your DIRECTV Receiver (works only if you subscribe to your local telephone service's caller ID service). While in the Guide, this button lets you change the Guide style.

FREEZE (green button)

Press this button to take a still picture of the TV screen. Press it again to resume the program you were watching. While in the Guide, this button lets you see program listings for a different time.

AUDIO (yellow button)

While watching TV, press this button to select an alternate audio track. While in the Guide, this button lets you view programs in selected categories.

SEARCH (blue button)

Press this button to search for a program listing in the Guide.

Number and dash buttons (0-9, -)

Press the number buttons to tune directly to a particular channel or to enter numerical values in the Menu system. Press the dash button (-) to enter a separator between parts of a number.

GAME

Accesses games you can play.

VCR control buttons

Operate your VCR with the Play, Rewind, Fast-Forward, Record, Stop and Pause buttons at the bottom of the remote control (once the remote control has been programmed — see *Chapter 7*).

Changing channels

There are several ways to change the channel you are watching:

- 1 Press the CH + button on the remote control to tune to a higher channel number. Press the CH - button to tune to a lower channel number.
- 2 Enter a channel number directly with the 0 - 9 number buttons. After entering a number, press the  button or wait a few seconds for the system to tune to the new channel.
- 3 Use the Quick Guide or full-screen Program Guide to change channels.

Adjusting the volume

To adjust the volume while watching DIRECTV® programming, you simply press the VOL + button on the remote control to increase the volume or the VOL - button to decrease the volume. In order for the DIRECTV Receiver's remote control to adjust your TV's volume setting, you will have to program the remote control to operate your TV. (See Chapter 7: Programming the remote control.)

Getting help

While using the Guide or Menu systems, you will often see a line of text at the bottom of the screen explaining what you are seeing on-screen, or telling you what your next step is. When this brief explanation is not enough, you can view more detailed Help screens by pressing the HELP button on your remote control.

Getting information on the TV program you are watching

Your DIRECTV Receiver provides several layers of information about the TV programs you watch.

The Channel Banner

As you are changing channels on your DIRECTV Receiver, you will see a Channel Banner for the program on each channel you tune to. After a few seconds, the Channel Banner will disappear on its own. If you want to clear it right away, press the EXIT button on your remote control.

The Channel Banner provides the following information:

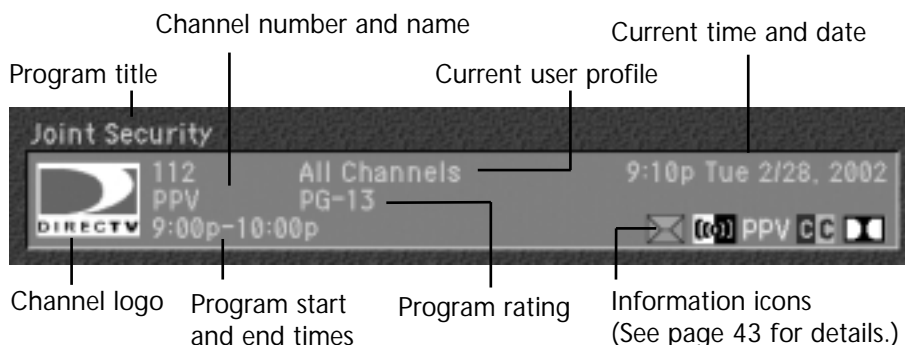

The Full Channel Banner

The Channel Banner provides quick information about TV programs as you switch channels on your DIRECTV Receiver. If you want to see information about the channel you are currently watching, simply press the INFO button on your DIRECTV Receiver's remote control. Pressing the INFO button displays the Full Channel Banner.

The Full Channel Banner displays all of the information presented in the smaller Channel Banner, plus a more detailed description of the program. For example, the Full Channel Banner for a movie might display information about the category for the movie (drama, comedy, action/adventure, etc.), the cast, the year it was released, and a short description of the plot.



Note: If you change channels while viewing a Full Channel Banner, you will continue to see Full Channel Banners (instead of the smaller Channel Banners) for each channel you tune to.

Like the smaller Channel Banner, you can clear the Full Channel Banner from your screen by pressing the EXIT button on your remote control.

Information icons

In addition to the basic channel and program information contained in the Channel Banners (program title, channel name, rating, etc.), there are a set of information icons. These icons tell you more about the program you are watching and about the status of your DIRECTV Receiver. Here are descriptions of each icon:

**Multi-language**

This icon appears when additional audio tracks are available. Press the yellow AUDIO button to choose an alternate audio track.

**Locked**

This icon appears when the system is locked.

**Unlocked**

This icon appears when the system is temporarily unlocked.

**Mail**

This icon appears when there are unread mail messages from DIRECTV in your system mailbox.

**Music channel**

This icon appears when the channel is a music-only channel.

**Pay per view program**

This icon appears when the program is a pay per view program.

**Closed caption**

This icon appears when closed captioning is available for a program.

**Dolby® Digital**

This icon indicates that the current program is being broadcast using a Dolby Digital audio track.

**Letterbox**

This icon indicates that the current program is being broadcast using the letterbox widescreen video format.

The Program Detail Screen

If you want to see more information than is presented in either the Channel Banner or the Full Channel Banner, you can press the INFO button twice to display the Program Detail Screen.

The Program Detail Screen displays all of the information provided in the Channel Banner and Full Channel Banner, plus complete details about the program and a list of actions you can take related to the program.

To view the Program Detail Screen:

- 1 While watching a TV program, press the INFO button on your remote control.

The Full Channel Banner appears.

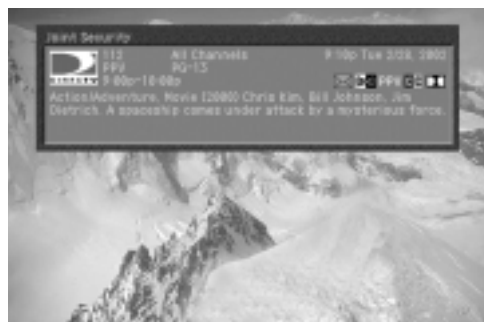

- 2 Press the INFO button again.
The Program Detail Screen appears.



Actions list

Select this arrow and press the button to scroll down.

Another way to view the Program Detail screen is to enter the program Guide, highlight the program listing you are interested in, then press the INFO button on your remote control.

Program Detail Screen actions

In addition to providing a description of the program you are watching, the Program Detail Screen provides a list of actions you can take related to that program. Here are descriptions of all of the actions that might be available for a program. (Note: not all actions are available for every program.)

- Back:** Displays the last screen you viewed before entering the Program Detail Screen.
- Exit:** Clears the Program Details Screen and displays the last channel you were viewing.
- Buy \$(Price):** For pay per view programs, allows you to purchase the program.
- Tape \$(Price):** For pay per view programs, allows you to purchase the program and tape it on your VCR (appears only when the price to tape is different from the purchase price).
- Cancel \$(Price):** For pay per view programs that you have previously purchased but that have not yet aired, lets you cancel your purchase.
- Tune:** Clears the Program Details Screen and displays the channel airing the program described.
- Schedule:** For future programs, allows you to set your DIRECTV Receiver to remind you when the program is about to start, or (model SIR-S310W only) to set your DIRECTV Receiver and VCR to record the program.
- Unschedule:** For programs you have previously scheduled for a reminder or recording, allows you to cancel the reminder or recording.
- Episodes:** For programs broadcast as episodes, allows you to view a list of other episodes in that program's series.
- Show Times:** Displays a list of times and channels for viewing the program.
- Similar:** Displays a list of programs that have aspects in common with the program.

Finding out what's on: the Guides

Your DIRECTV Receiver provides access to detailed information about TV schedules. If you want to know what's on, just use the Guide.

There are several types of Guides you can access, each suited to a particular set of needs and preferences.

Types of Guides

When you want to find out what's on, you can use the simple, fast Quick Guide; the detailed, informative Grid Guide; or the graphics-rich Logo Guide.

Quick Guide

The Quick Guide allows you to quickly scan to see what is on right now while still viewing the channel you are watching. Great for those times when you just want to quickly check out what's showing on that favorite channel.



Grid Guide

The Grid Guide is the most complete, detailed Guide type. It lets you see the programs for each channel in a scrollable schedule (sorted by channel *number*, or by channel *name*). If you don't know what you want to watch, and you want to browse a broad range of channels, the Grid Guide may be for you.



Logo Guide

The Logo Guide lets you find out what's on by browsing through the channels by highlighting the channels' logos — perfect for those of us who prefer pictures to text.



The pages that follow tell you how to access and use each of these Guide types.

Setting the default Guide style

The *Guide* menu item allows you to set which style of Guide is displayed when you press the GUIDE button on your remote control. Here's how:

- 1 Press the MENU button on your remote control.

The Main menu appears on your screen.

When you display the Main menu, the *Guide* item is highlighted.



- 2 Press the button on your remote control.

The Guide menu appears.

- 3 Use the up- and down-arrow buttons on your remote control to highlight the *Set Guide* menu item.

The page icon to the right of the *Set Guide* item indicates selecting this item will display a list of options.

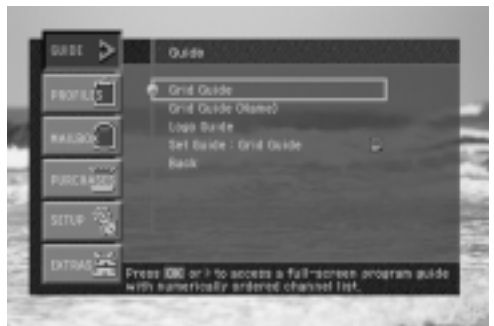

- 4 Press the button on your remote control.

A list of Guide Styles appears.

- 5 Use the arrow buttons on your remote control to select the Guide style you wish to have displayed anytime you press the GUIDE button, then press the button.

The list of Guide styles disappears, and the style you chose is displayed in the *Set Guide* menu item.

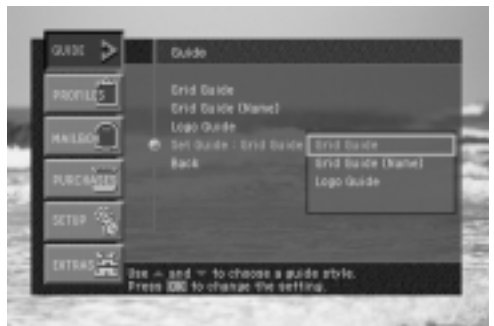

- 6 To exit the Menu, press the EXIT button on your remote control.

Pressing the GUIDE button will now display the Guide style you selected.

Using the Quick Guide

The Quick Guide is made up of a Channel Banner and a channel list. This Guide is small and transparent so that you can continue to watch a TV program while you are browsing the Guide. Follow these steps to use the Quick Guide.

- 1 To display the Quick Guide, press the QUICK button on your remote control.

The Quick Guide appears, displaying a small Channel Banner and a channel list showing the current half-hour time block.



- 2 Use the arrow buttons on your remote control to move up or down in the channel list, or forward (and then backward) in time. You can move up and down through the channel list a full page at a time by pressing the CH+ and CH- buttons on your remote control. You can also use the number buttons on your remote control to move the Quick Guide directly to a specific channel.

As you highlight each program listing, its information appears in the Channel Banner.

- 3 To see more information on a highlighted program, press the INFO button on your remote control.

The Full Channel Banner appears. As you browse the Quick Guide, the Full Channel Banner will continue to be displayed. To return to the smaller Channel Banner, press the INFO button again.



- 4 To get information on a channel (rather than a program), use the arrow keys on the remote control to highlight the channel number.

The Channel Banner displays information about the highlighted channel.

- 5 To expand the program listings to show more time, press the right-arrow button on your remote control.

Each time you press the right arrow, the Quick Guide expands by 30 minutes (up to a maximum 2-hour display). To reduce the Quick Guide in 30-minute blocks, press the left-arrow button on your remote control.

- 6 To watch a program you see listed in the Quick Guide, use the arrow buttons on your remote control to highlight that program, then press the  button.

The Quick Guide disappears, and the program you selected fills the screen.

Using the Grid Guide

The Grid Guide displays a Channel Banner and a channel list showing a 2-hour time block for five channels (starting with the channel you are watching). It provides access to the complete set of Guide features including the ability to search for programs, schedule reminders and (on model SIR-S310W) recordings, etc.

Displaying and clearing the Grid Guide

To display or clear the Grid Guide:

- 1 To display the Grid Guide, press the GUIDE button on your remote control.

The Grid Guide appears. (Pressing the GUIDE button displays the Guide style — *Grid Guide*, *Grid Guide (Name)*, or *Logo Guide* — established in the *Set Guide* option in the *Guide* menu. The default setting is Grid Guide).



- 2 You can also display the Grid Guide by pressing the MENU button on your remote control. Then highlight *Guide* and press the \odot button on your remote control. Then highlight *Grid Guide* and press the \odot button again.

- 3 To clear the Grid Guide from your screen, press the EXIT button on your remote control..

Grid Guide overview

This diamond marks the current time (so you can see how close you are to a program start or end time).

Title of the highlighted program or channel.

This Banner shows information about the channel or program highlighted in the Guide.

Picture-in-Guide shows you the program you are watching.



Current time and date

The program list; use the arrow buttons on your remote control to highlight different areas.

The program currently highlighted.

Icons to remind you about the Guide functions of the red, green, yellow, and blue buttons on your remote control.

Getting around in the Grid Guide

You can use the Grid Guide to get detailed information about the channels and programs it contains. Here's how:

- 1 To highlight different program listings in the Grid Guide, use the arrow buttons on your remote control to move up or down in the channel list, or forward and backward in time.

Use the right-arrow button to see future program listings for up to 3 days on model SIR-S300W, or up to 7 days on SIR-S310W.

- 2 To move up and down through the channel list a full page at a time, press the CH+ and CH- buttons on your remote control.
- 3 To move the Grid Guide directly to a specific channel, press the 0-9 number buttons on your remote control to enter the desired channel number.
- 4 As you highlight each program listing in the Grid Guide, information about the program appears in the Channel Banner. To see more information on a highlighted program, press the INFO button on your remote control.

The Program Detail screen appears, showing complete information about the highlighted program and a list of actions you might want to take related to that program. To return to the Grid Guide, highlight the *Back* item from the on-screen list and press the button on your remote control.



- 5 To get information on a channel (rather than a program), use the arrow keys on the remote control to highlight the channel entry in the Guide.

The Channel Banner displays information about the highlighted channel.



- 6 Press the INFO key on your remote control while a channel entry is highlighted to see a Channel Detail Screen containing more information about the highlighted channel.



Tuning to a channel with the Grid Guide

To tune to a program or channel listed in the Grid Guide:

- 1 Use the arrow keys to highlight the program or channel you want to watch.
- 2 Press the button on your remote control.

The Guide disappears, and the channel you selected fills the screen.

Switching to another Guide style

You can switch from the *Grid Guide* to the *Grid Guide (Name)* or *Logo Guide* while viewing the Grid Guide. Here's how:

- 1 With the Guide displayed on your screen, press the red R button on your remote control.

A list of Guide Styles appears on your screen.

- 2 Use the arrow buttons on your remote control to highlight the Guide style you wish to view, then press the button.

The Guide Style list disappears, and the Guide appears in the style you chose.



Viewing the Guide for a different time

You can view the TV programming for different times by using the Guide's time control bar. Here's how:

- 1 With the Guide displayed on your screen, press the green G button on your remote control.

The time control bar appears across the bottom of the Guide.

- 2 Use the arrow buttons on your remote control to highlight the time controls. Press the button to select the controls you wish to use.



Here is an explanation of each time control.



Exits the time control bar.



Moves the Guide view back 6 hours (unavailable when viewing the current time).



Moves the Guide view back 30 minutes (unavailable when viewing the current time).



Moves the Guide view ahead 30 minutes.



Moves the Guide view ahead 6 hours.



Moves the Guide view to the current time.



Moves the Guide view back 24 hours (unavailable when viewing the current time).



Moves the Guide view ahead 24 hours.

Viewing a category of programs in the Guide

You can set your Guide to show you all channels, or only channels showing programs in a specific category (for example, only channels showing sports, or only channels showing movies). Here's how:

- 1 With the Guide displayed on your screen, press the yellow Y button on your remote control.

A list of Guide *Categories* appears on your screen.

- 2 Use the arrow buttons on your remote control to highlight the Guide category you wish to view, then press the  button.

The Guide Category list disappears and the Guide appears, displaying channels showing programs that match the category you chose.



Using the Logo Guide

The Logo Guide displays 21 channel logos and a Channel Banner showing information about the program currently showing on the highlighted channel. Follow the steps in this section to use the Logo Guide.

Displaying and clearing the Logo Guide

To display or clear the Logo Guide:

- 1 Press the MENU button on your remote control. Then use the arrow buttons to highlight the *Guide* menu item, and press the button on your remote control. Then highlight the *Logo Guide* menu item, and press the button. The Logo Guide appears on your screen.
- 2 Or, press the GUIDE button on your remote control. Then press the red R button to display the list of Guide styles. Then use the arrow buttons to highlight the Logo Guide option, and press the button on your remote control. The Logo Guide appears.
- 3 Or, you can set the default Guide Style so that the Logo Guide always appears whenever you press the GUIDE button on your remote control. See *Setting the default Guide style* on page 46 for details on setting the default Guide Style.
- 4 To clear the Logo Guide from your screen, press the EXIT button on your remote control.

Logo Guide overview

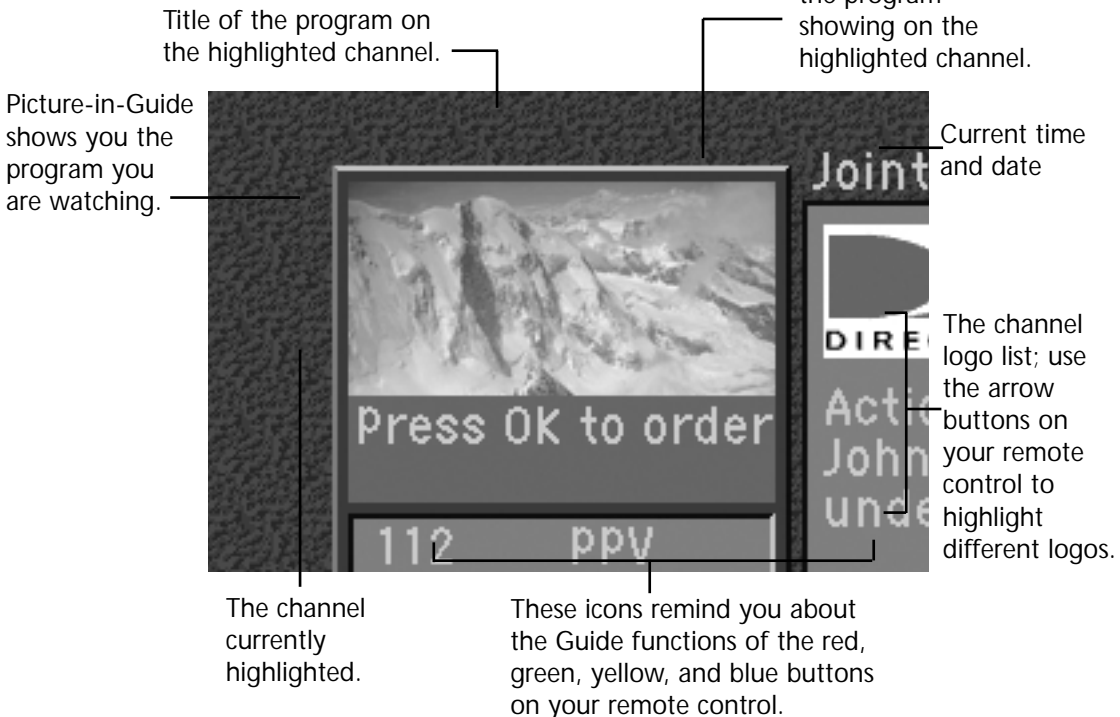

Getting around in the Logo Guide

You can use the Logo Guide to get information about the programs currently showing on your DIRECTV Receiver. Here's how:

- 1 To highlight different program listings in the Logo Guide, use the arrow buttons on your remote control to move up, down, left, or right in the logo list.

When you highlight a logo, it is replaced by the channel name and number in the Logo Guide.

- 2 To move up and down through the channel logos a full page at a time, press the CH+ and CH- buttons on your remote control.
- 3 To move the Logo Guide directly to a specific channel, press the 0-9 number buttons on your remote control to enter the desired channel number.

- 4 As you highlight each channel logo in the Logo Guide, information about the program currently showing on the highlighted channel appears in the Channel Banner. To see more information on a highlighted program, press the INFO button on your remote control.

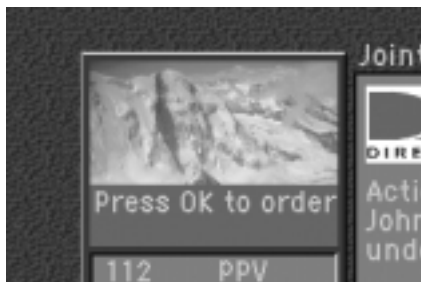

The Program Detail Screen appears, showing complete information about the program on the highlighted channel, and a list of actions you might want to take related to that program. To return to the Logo Guide, highlight the *Back* item from the on-screen list and press the  button on your remote control.



Tuning to a channel with the Logo Guide

To tune to a program or channel listed in the Logo Guide:

- 1 Use the arrow keys to highlight the channel you want to watch.
- 2 Press the  button on your remote control.

The Logo Guide disappears, and the channel you selected fills the screen.

Switching to another Guide style

You can switch from the *Logo Guide* to the *Grid Guide* or *Grid Guide (Name)* while viewing the Guide. Here's how:

- 1 With the Guide displayed on your screen, press the red R button on your remote control.

A list of *Guide Styles* appears on your screen.

- 2 Use the arrow buttons on your remote control to select the Guide style you wish to view, then press the  button.

The Guide Style list disappears, and the Guide appears in the style you chose.



Searching for programs in the Guide

You can search the entire list of programs stored in your DIRECTV Receiver's program guide to find exactly the program you wish to see. There are four ways to search the Guide:

- By Credits:** Lets you find programs that match the actor, director, role, award, or year you type using an on-screen keyboard.
- By Title:** Lets you find programs that match the program title you type using an on-screen keyboard.
- By Text:** Lets you find programs for which either the credits or the title match the search term you type using an on-screen keyboard.
- By Category:** Lets you find programs that match the program categories and sub-categories you select from an on-screen list.

These search techniques are described in the sections that follow.