

# **SIRIUS InV**

Satellite Radio Plug-n-Play Receiver



## **SV2 User Guide**



## **Congratulations on the Purchase of your new SIRIUS InV SV2 Plug-n-Play Receiver**

Your new SIRIUS InV SV2 Plug-n-Play Receiver lets you enjoy SIRIUS® Satellite Radio's digital entertainment in any vehicle.

Use this manual to familiarize yourself with all of the InV's' features and capabilities. For the latest information about this and other SIRIUS products and accessories, visit <http://www.sirius.com>.



# Table of Contents

<b>TABLE OF CONTENTS.</b>	<b>2</b>
<b>WARNING AND SAFETY INFORMATION.</b>	<b>4</b>
FCC Caution	4
Canadian Compliance	4
General Precautions	4
<b>COPYRIGHTS &amp; TRADEMARKS</b>	<b>7</b>
<b>PACKAGE CONTENTS.</b>	<b>8</b>
<b>INSTALLATION.</b>	<b>9</b>
Location	9
Mounting the Receiver	10
Installing the Antenna	11
Connecting the Cigarette Lighter Adapter	13
Maximizing Audio Quality From Your SIRIUS Receiver	14
Wireless Connection	14
Direct Connections	15
Subscribing to the SIRIUS Service	18
<b>CONTROLS</b>	<b>20</b>
SIRIUS InV SV2 Reference Guide	20
<b>OPERATION</b>	<b>22</b>
Display Screen Information	22
Changing Channels and Categories.	23
Selecting Channels Directly	24
FM Frequency	25
Jump Button	26
Channel Lock.	27
<b>MENU OPTIONS</b>	<b>28</b>
SIRIUS ID	28
FM Transmitter	29
Audio Level	31
Tones	31

Clock . . . . .	32
Jump Settings . . . . .	33
Channel Lock. . . . .	34
Signal . . . . .	37
Factory Default . . . . .	37
<b>TROUBLESHOOTING . . . . .</b>	<b>39</b>
<b>SPECIFICATIONS. . . . .</b>	<b>40</b>
<b>WARRANTY . . . . .</b>	<b>41</b>
<b>SIRIUS ID . . . . .</b>	<b>42</b>

# Warning and Safety Information

## FCC Caution

Any changes or modifications not expressly approved by the party responsible for compliance could void the user's authority to operate this equipment.

This device complies with part 15 of the FCC Rules.

Operation is subject to the following two conditions:

1. This device may not cause harmful interference, and
2. This device must not accept any interference received, including interference that may cause undesired operation.

This transmitter must not be co-located or operating in conjunction with any other antenna or transmitter.

## Canadian Compliance

This Class B digital apparatus complies with Canadian ICES-003.

Cet appareil numérique de la classe B est conforme à la norme NMB-003 du Canada.

## General Precautions

### **Liquid Crystal Precautions**

If the LCD screen on the receiver is damaged, do not touch the liquid crystal fluid. If any of the following situations happen, take the action indicated:

1. If the liquid crystal fluid comes in contact with your skin, wipe the skin area with a cloth and then wash the skin thoroughly with soap and running water.
2. If the liquid crystal fluid gets into your eye, flush the eye with clean water for at least 15 minutes. Seek medical care.
3. If the liquid crystal fluid is ingested, flush your mouth thoroughly with water. Drink large quantities of water and induce vomiting. Seek medical care.

### **Safety Precautions**

Be sure to observe the following warnings. Failure to follow these safety instructions and warnings may result in a serious accident.

- Do not operate the receiver in a way that might divert your attention from driving safely. As a driver, you alone are responsible for safely operating your vehicle in accordance with traffic safety laws at all times.
- Do not install the unit where it may obstruct your view through the windshield, or of your vehicle's indicator displays.
- Do not install the unit where it may hinder the function of safety devices such as an airbag. Doing so may prevent the airbag from functioning properly in the event of an accident.
- Be sure the unit is installed as described in the installation instructions which accompany each accessory kit. SIRIUS Satellite Radio is not responsible for issues arising from installations which were not installed according to the instructions.
- To avoid short circuits, do not open the unit, and never put or leave any metallic objects (coins, tools, etc.) inside the unit.
- If the unit emits smoke or unusual odors, turn the power off immediately, and disconnect the unit from any power source.
- Do not drop the unit or subject it to strong shocks.
- If the unit doesn't seem to be working properly, turn the unit off, remove the battery from the unit, wait 10 seconds, replace the battery and then turn it on again.
- The installation and use suggestions contained in this manual are subject to any restrictions or limitations that may be imposed by applicable law. The purchaser should check applicable law for any restrictions or limitations before installing and/or operating this unit.

**Operating Temperature**

The receiver is designed to operate between -20° to +85° C (-4° to +185° F). Avoid leaving the unit in a vehicle or elsewhere where the temperature may fall outside this range. Extreme temperatures or extreme temperature fluctuations can degrade the performance of the LCD display screen, and possibly damage it.

**Cleaning and Maintenance**

If the receiver becomes dirty, turn the power off and wipe it clean with a soft cloth. Do not use hard cloths, strong cleaning fluids, paint thinner, alcohol, or other volatile solvents to clean. These may cause damage to the unit.



# Copyrights & Trademarks

© 2006 SIRIUS Satellite Radio Inc. All Rights Reserved.

® "SIRIUS", the SIRIUS dog logo, channel names and logos are trademarks of SIRIUS Satellite Radio Inc. "NFL" and the NFL Shield logo, and the NFL Sunday Drive name and logo are registered trademarks of the National Football League. "NHL" and the NHL Shield are registered trademarks of the National Hockey League. "NBA" and the NBA silhouette logo are registered trademarks of NBA Properties Inc. All other trademarks, service marks, sports team names, album art, and logos are the property of their respective owners. All Rights Reserved.

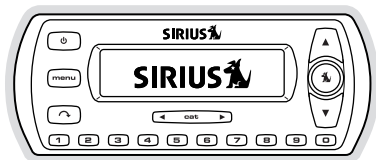
Portions of the software on this receiver are licensed under the eCos License. Distribution of eCos requires that the eCos source code be made available to Sirius Satellite Radio customers. The eCos License and eCos source code are available to the public at <http://www.sirius.com/ecoslicense>.

Sirius Satellite Radio reserves all rights to all receiver software not covered under the eCos license. This includes all portions of receiver software that were not distributed to Sirius as part of the eCos operating system.

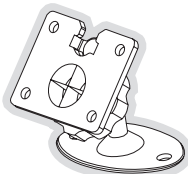
Hardware, subscription and activation fee required. For full Terms & Conditions, visit <http://sirius.com>. Prices and programming are subject to change. Not available in HI and AK. Equipment and subscription sold separately. Installation required with some equipment.

# Package Contents

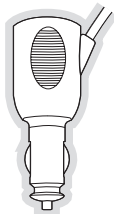
The following items are included with your purchase of the SIRIUS InV SV2 receiver:



**InV SV2 Receiver**



**Adhesive Dash Mount**



**Cigarette Lighter Adapter**



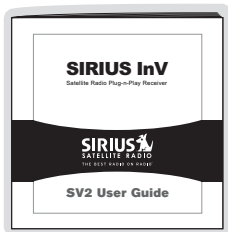
**Magnetic Antenna**



**Antenna Cover/Tail**



**Alcohol Swab**



**User Guide**

Unpack your SIRIUS InV SV2 receiver carefully and make sure that everything shown is present. If anything is missing or damaged, or if your the receiver fails to operate, notify your dealer immediately. It is recommended that you retain the original carton and packing materials in case you need to ship your receiver in the future.

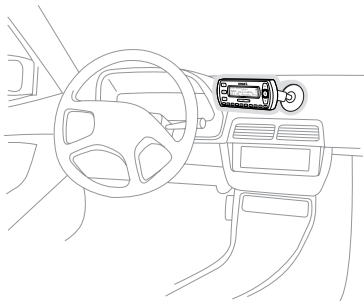
# Installation

Installation of your SIRIUS InV SV2 receiver is easy:

1. Choose a location in your vehicle where you will mount the receiver on the dash.
2. Mount the receiver on the on the dash using the adhesive mount.
3. Install the magnetic antenna on the roof of the vehicle, and route the antenna cable to the receiver.
4. Connect the power cord for the receiver to your vehicle's cigarette lighter.
5. Subscribe to the SIRIUS service and begin enjoying the SIRIUS entertainment!

## Location

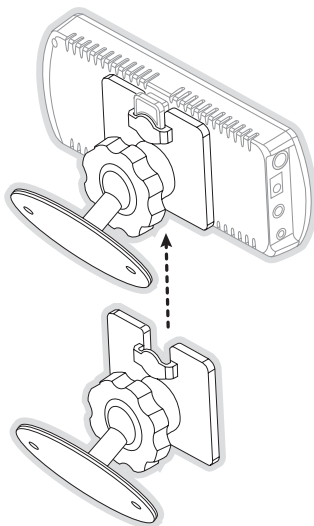
Choose a location in your vehicle where the receiver will not block your vision, interfere with the vehicle controls, or obstruct the air bag. If you are using the adhesive mount, the location should be suitable flat, smooth surface. The location should be easily reachable and provide good visibility of the receiver. Figure 1 illustrates a typical dash mount.



**Figure 1**

## Mounting the Receiver

Attach the adhesive mount to the receiver by sliding the flat portion of the mount into the u-shaped connector on the back top edge of the receiver, as shown in Figure 2. Gently slide the adhesive mount in until it snaps into place.



**Figure 2**

Be sure to select your mounting position carefully. Once the mount has been adhered to a surface, it will not be possible to remove it and adhere it again.

Clean the selected mounting surface area in the vehicle with the alcohol swab. Unscrew the adhesive foot from the mount. Peel the protective material off the adhesive on the foot and press the foot firmly against the vehicle surface.

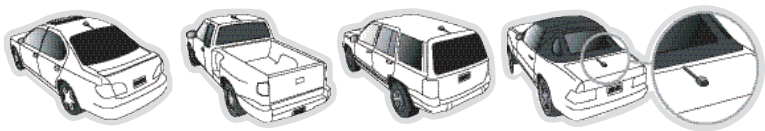
The adhesive mount should then be allowed to adhere for a minimum of 2-4 hours before use. Best adhesion occurs after 24 hours.

## Installing the Antenna

The optimum mounting location for the magnetic antenna is on the roof of the vehicle, with a minimum unobstructed area of 12 inches by 12 inches, and exactly 6½ inches from the rear roof edge of the vehicle (the length of the rubber antenna cable cover/tail). It is important to avoid any obstructions that will block the SIRIUS signal, obstructions such as a roof rack, a sunroof, roof mounted cargo containers, or other antennas. For convertible vehicles, the antenna should be installed on the trunk lid.

For best performance, it is recommended that the antenna be installed with the rubber antenna cable cover/tail. This rubber antenna cable cover/tail provides two benefits: first, it positions the antenna the recommended distance from the rear window, rear door/hatch, or trunk edge to give the antenna the best view of the sky. Secondly, it conceals and protects the exposed antenna cable. The rubber antenna cable cover/tail has adhesive strips that hold it securely in place.

The following illustrations show the recommended mounting locations of the antenna for several types of vehicles. (Figure 3) Follow these recommendations for best performance from the antenna.



**Figure 3**

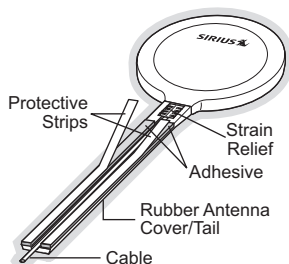
**Sedan/Coupe.** Mount the antenna along the rear center-line of the vehicle roof, located at the rear of the roof near the rear window.

**Pickup Truck.** Mount the antenna along the rear center-line of the cab roof, located at the rear of the roof near the rear window.

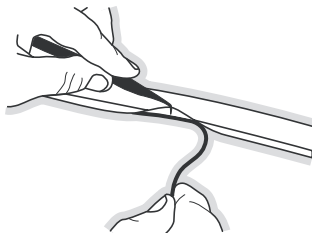
**SUV/Mini-Van.** Mount the antenna along the rear center-line of the vehicle roof, located at the rear of the roof near the rear door/hatch.

**Convertible.** Mount the antenna along the center-line of the trunk lid, with the rubber antenna cable cover/tail directed toward the rear window.

When you have selected a suitable mounting location, clean the area where the antenna and rubber antenna cable cover/tail will be mounted with the supplied alcohol swab.



**Figure 4**



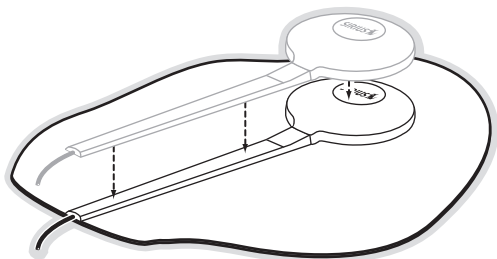
**Figure 5**

Connect the rubber antenna cable cover/tail to the antenna cable, making sure that the strain-relief on the antenna sits into the rubber antenna cable cover/tail groove. (Figure 4) Route the antenna cable through the wire channel in the rubber antenna cable cover/tail. Do not remove the protective strips yet.

Temporarily position the antenna and rubber antenna cable cover/tail in the selected mounting area and route the cable from the antenna to the vehicle's interior by tucking it underneath the rubber molding around rear window, as shown in Figure 5.

Route the cable from the lowest point of the rear window into the trunk. Take advantage of any existing cable channels or wiring conduits. For SUVs, mini-vans and 5-door vehicles, bring the cable into the vehicle under the rubber molding for the tailgate, and continue under the interior trim.

From the trunk, or rear of the vehicle, route the cable around the passenger compartment and to the front of the vehicle, to the receiver. Take care not pull the cable across sharp edges that could damage it, and keep it away from areas where it might entangle feet. Coil any excess antenna cable in a location where it can be hidden.



**Figure 6**

Once the antenna cable is routed through the vehicle, and you are satisfied with the cable routing, peel the protective material from the adhesive strips and press the rubber antenna cable cover/tail firmly into place on the vehicle. Double check that the location of the antenna and rubber antenna cable cover/tail are correct, and continue to press firmly down on rubber antenna cable cover/tail for another 30 seconds. (Figure 6) At room temperature (68 degrees), maximum adhesion usually occurs within 72 hours. During this period, avoid car washes and other contact with the antenna and rubber antenna cable cover/tail.

Connect the antenna cable to the **ANT** connection at the rear of the dock. (Refer to Figure 2 on page 21 for the location of this connector.)

## Connecting the Cigarette Lighter Adapter

Connect the cigarette lighter power adapter to the receiver, and plug it into your vehicle. (Refer to Figure 2 on page 21 for the location of this connector.)

# Maximizing Audio Quality From Your SIRIUS Receiver

There are two primary ways to connect your SIRIUS satellite radio. The following procedures will help you obtain the best performance.

## WIRELESS CONNECTION

Your SIRIUS radio contains an FM transmitter. The FM transmitter sends the audio from your SIRIUS radio to your vehicle radio. (Figure 7)

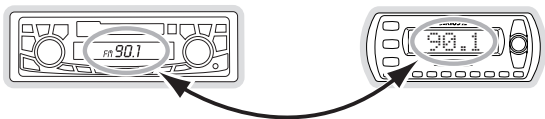


Figure 7

To tune your transmitter:

1. Turn off your SIRIUS radio and tune through the FM channels on your vehicle radio to locate an FM channel that is not broadcasting in your area. If you use an FM channel that is being used by a local broadcaster, it will interfere with the performance of your SIRIUS radio. Once you have located an FM channel that is not broadcasting in your area, save it as a preset on your vehicle radio. This will become your SIRIUS preset.
2. Turn on your SIRIUS radio. Press and hold the **MENU** Menu button to access the FM channel number list on your SIRIUS radio. Tune to the channel that matches the SIRIUS preset on your vehicle radio. Refer to the **Menu Options/FM Frequency** section of this manual for more detailed instructions on how to do this.

**Note:** The FM transmitter in your SIRIUS radio is automatically set to FM channel 88.1. This may not be the best channel in your area.

**Tip:** If you regularly travel between cities with different active FM channels, you may need to find channels that are not broadcasting in each city. Several SIRIUS receiver models can store multiple FM transmit channels, so you can easily switch to the best FM channel for each city. You will also want to set the FM channels that are not broadcasting in each city as presets on your vehicle radio.



If you're not sure which FM channels are not broadcasting in your home or travel cities, you can also go to <http://SIRIUS.com/fmchannel> and search for a suggested FM channel based on your zip code.

## DIRECT CONNECTIONS

Direct connection provides better audio performance than a wireless connection and removes the possibility of interference from local FM broadcasters.

### Direct Wired Audio Connection

If your vehicle radio offers an "AUX IN" or "LINE IN" connection, it is the best audio connection available. If the "AUX IN" or "LINE IN" connector is located on the front of your vehicle radio, this is also the easiest connection. (Figure 8)

1. Purchase an audio cable that matches the connection type of your vehicle radio and your SIRIUS radio at your local electronics retailer. Your SIRIUS radio requires a 1/8" stereo male connector. Your local electronics retailer can help you determine the proper connection for your car radio.
2. Plug one end of the cable into the **AUDIO** jack on your SIRIUS radio. (Refer to Figure 2 on page 21 for the location of this connector.) Plug the other end into your "AUX IN" or "LINE IN" jack on your vehicle radio.



**Figure 8**

**NOTE:** Refer to your vehicle radio manufacturer's guidelines for correct installation.

**NOTE:** If the "AUX IN" or "LINE IN" connection is on the back of your vehicle radio, you may want to consider professional installation. (Figure 9)

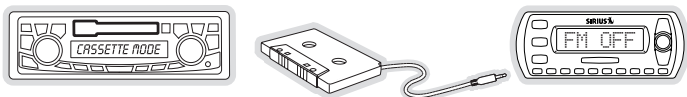


**Figure 9**

### **Cassette Adapter**

If your vehicle radio has a cassette player:

1. Purchase a Cassette Adapter at your local electronics retailer.
2. Connect the adapter between the **AUDIO** jack on your SIRIUS radio (refer to Figure 2 on page 21 for the location of this connector) and the vehicle radio's cassette slot. (Figure 10)

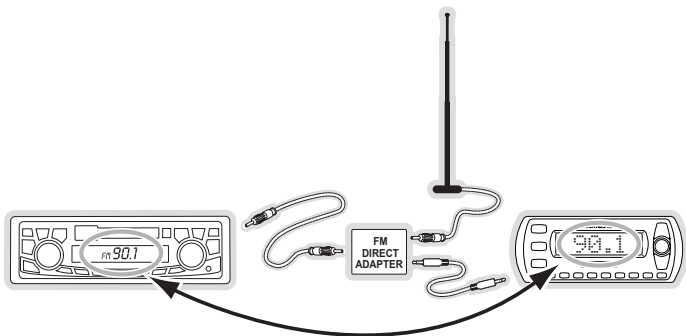


**Figure 10**

**NOTE:** Refer to the cassette adapter manufacturer's guidelines for correct use.

### **SIRIUS FM Direct Adapter**

If your vehicle radio does not have an "AUX IN" or "LINE IN" jack, the SIRIUS FM Direct Adapter provides a wired connection between your SIRIUS radio and your vehicle radio, eliminating the outside static and interference you sometimes experience when using a wireless FM connection. (Figure 11)



**Figure 11**

Professional installation may be required. See your local SIRIUS retailer. The SIRIUS FM Direct Adaptor is available at your local SIRIUS retailer or at <http://shop.sirius.com>. For the latest information refer to <http://www.SIRIUS.com/vehicleinstallation>.

## Subscribing to the SIRIUS Service

Before you can listen to the SIRIUS service, you need to subscribe to the SIRIUS Satellite Radio service. To subscribe, do the following:

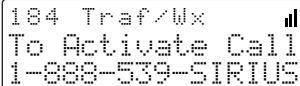
1. Be sure that the receiver is correctly installed, and that the antenna is oriented to receive the SIRIUS signal.
2. Turn on the receiver. After the startup sequence, it will update the SIRIUS channel lineup. Wait until the channel updates have completed before pressing any buttons. (Figure 12)



```
Channel Updates
20% Completed
```


**Figure 12**

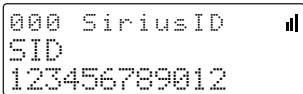
3. Once the channels have been updated, the display will change to *To Activate Call 1-888-539-SIRIUS* and will tune to channel 184. (Figure 13) You will not be able to listen to other channels until you activate your SIRIUS subscription.



```
184 Traf/Wx
To Activate Call
1-888-539-SIRIUS
```

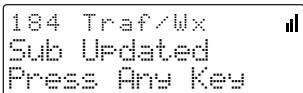
**Figure 13**

4. In order to subscribe, you will need your receiver's unique 12-digit SIRIUS ID number (SID). (Figure 14) You can display the SID by tuning to channel 000 by using the channel up/down buttons on receiver. You can also tune to channel 000 by momentarily pressing the  Select button, then entering **000** at the prompt. (The SID number is also available on the receiver's packaging.) Write the SID number down in the space provided near the end of this user guide.



**Figure 14**

5. Have your credit card handy and contact SIRIUS on the Internet at:  
<https://activate.siriusradio.com/>  
and follow the prompts to activate your subscription. You can also call SIRIUS toll-free at: **1-888-539-SIRIUS** (1-888-539-7474).
6. When you have successfully subscribed to the SIRIUS service, and the receiver has been updated with your subscription information, *Sub Updated, Press Any Key* will be displayed. (Figure 15) To continue, press any key on the receiver.



**Figure 15**

You are now ready to begin enjoying SIRIUS Satellite Radio's digital entertainment, and can tune to other channels!

# Controls

## SIRIUS InV SV2 Reference Guide

Figure 1 and the section following identify and describe the buttons of the SV2 receiver.

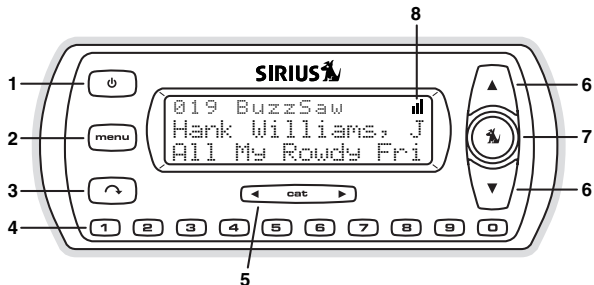
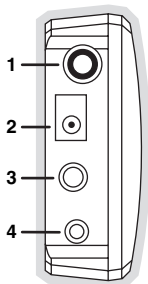


Figure 1

1. **Power Button:** Turns the receiver's power On and Off.
2. **Menu Button:** Used to access menu options to make setup and feature changes. Pressing and holding displays the FM Frequency menu option.
3. **Jump Button:** Jumps to a pre-selected traffic/weather channel.
4. **Preset/Direct Tune Buttons (0-9):** Sets and selects preset channels. Also used to directly tune channels by entering the channel number.
5. **Category Previous/Next Buttons:** Navigates through the category (genre) list screen which displays SIRIUS channel categories.
6. **Channel Up/Down Buttons:** Navigates through channels and display screens.
7. **Select Button:** Selects items highlighted on the display screen. When at the default display screen, a press and release will display a prompt to enter a channel number.
8. **Signal Strength Display:** Displays the signal strength of the satellite signal.

Figure 2 and the section following identify and describe the connectors of the SV2 receiver.



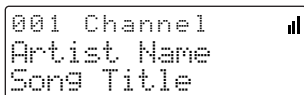
**Figure 2**

1. **ANT Antenna Connector:** Connection for the provided magnetic antenna.
2. **DC5V Power Connector:** Power connection for the cigarette lighter adapter.
3. **AUDIO OUT Connector:** Optional audio output connection for connecting to your vehicle's audio system if you are not using the FM transmitter.
4. **FM OUT Connector:** FM output for use with the optional FM Direct Adapter.

# Operation

## Display Screen Information

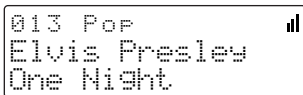
When you have successfully activated your SIRIUS subscription, and the receiver has received the subscription information from the SIRIUS signal, the default display screen will be displayed. (Figure 1)



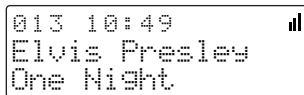
**Figure 1**

When the receiver is powered on, the previously selected channel will automatically begin playing.

You can select to have the channel name (Figure 1), category name (Figure 2), or time (Figure 3) displayed on the default display screen.



**Figure 2**




**Figure 3**

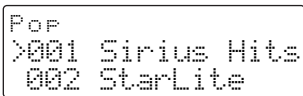
To change the display, press the **MENU** Menu button, then select *Display Options* → *Mode* and choose the desired display option.



## Changing Channels and Categories

Pressing the ▲▼ Channel Up/Down buttons will cause the receiver to immediately tune to the next or previous channel.

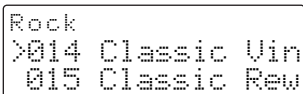
Pressing the ◀▶ Category Previous/Next buttons will cause the receiver to display a category and a list of channels in the category. (Figure 4) Use the ▲▼ Channel Up/Down buttons to navigate through the list, and press the  Select button to choose a selected channel.



```
Pop
>001 Sirius Hits
002 StarLite
```

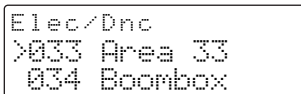
**Figure 4**

Use the ◀▶ Category Previous/Next buttons to scroll through the categories. (Figures 5 & 6)



```
Rock
>014 Classic Vin
015 Classic Rev
```

**Figure 5**




```
Elec/Dnc
>033 Area 33
034 Boonbox
```

**Figure 6**

## Selecting Channels Directly

A channel may be directly selected by entering the channel number using 0-9 buttons on the receiver.

To enter a channel number, momentarily press and release the  Select button. At the display prompt (Figure 7), enter the three digit channel number.

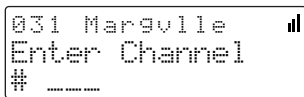


Figure 7

## Channel Presets

You can store up to 10 of your favorite channels as presets for quick recall access by pressing the 0–9 buttons.

### Storing Channel Presets

To store a favorite channel as a preset, do the following:

1. Tune the receiver to the channel you wish to store as a preset.
2. Press and hold for 1 second the numbered preset button (0–9) in which you wish to store your favorite channel. An audible beep will be heard and the preset number you selected will then be displayed to confirm that the channel has been stored. (Figure 8)

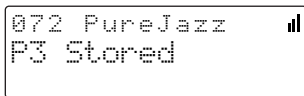


Figure 8

**Note:** If the preset button already has a channel stored in it, the preset will be replaced by the newly stored channel.

### Selecting Presets

Press and release one of the 0–9 buttons to select a preset channel. If no channel has been saved in the selected preset, the *PRESET EMPTY* message will be displayed. (Figure 9)

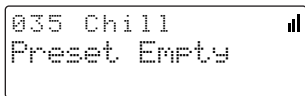


Figure 9

## FM Frequency

When the FM transmitter in your SIRIUS receiver is turned on, an FM radio tuned to the same FM frequency as your SIRIUS receiver will receive the SIRIUS audio.

To quickly access the FM frequency menu, press and hold the **MENU** Menu button. The current FM frequency is displayed. (Figure 10) To change the FM frequency, use the **▲▼** Channel Up/Down buttons and **◀▶** Category Previous/Next buttons to adjust the FM frequency. The **▲▼** Channel Up/Down buttons adjust in 0.1 MHz increments and the **◀▶** Category Previous/Next buttons adjust in 1 MHz increments. Press the **SELECT** button to set the new FM frequency.

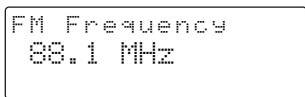



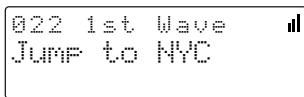
Figure 10

**Note:** The FM frequency is 88.1 MHz by default. This frequency may not be suitable for your area.

## Jump Button

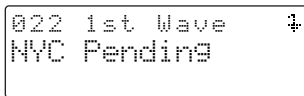
Pressing the  Jump button will jump to a traffic/weather channel which you have chosen for your area. This button allows you to quickly tune the traffic/weather for your area and then tune back to the original channel by pressing the button again. (Figure 11)

Refer to the **Jump Settings** section in the **Menu Options** section for information on configuring the  Jump button for traffic/weather in your area.






**Figure 11**

If your traffic/weather report is not immediately available, the display will indicate that a jump is pending. (Figure 12) Once your local traffic/weather report is ready, the receiver will automatically tune to the traffic/weather channel. You may have to wait a few minutes for your desired report.




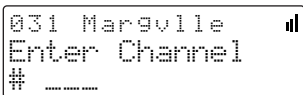
**Figure 12**

Pressing the  Jump button while a jump is pending will cancel the jump. Pressing the  Jump button after the receiver has tuned to the traffic/weather report will return to the channel to which you had been listening immediately prior to pressing the  Jump button.

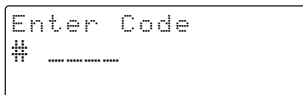
## Channel Lock

Channels may be locked so that they can only be accessed by entering a 4-digit code. Channels which have been locked will not appear in the channel lists, and cannot be selected using the ▲▼ Channel Up/Down buttons.

Locked channels can only be selected by using the direct entry method, by momentarily pressing the  Select button and entering the channel number at the prompt by using the 0–9 buttons. (Figure 13) You will then be prompted to enter the 4-digit channel lock code before you can access the channel. (Figure 14)



**Figure 13**

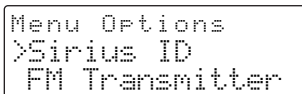


**Figure 14**

For more information on how to set the channel lock code, and how to lock or unlock channels, refer to the **Channel Lock** section on page 34.

# Menu Options

To enter the Menu Options page of the receiver, press the **MENU** Menu button. (Figure 1) To select a menu option, use the **▲▼** Channel Up/Down buttons to display the option you wish to adjust, and press the **↵** Select button. If a selection is not made within 10 seconds, the receiver will exit the menu options mode, and revert to the last active display mode.



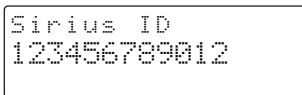
**Figure 1**

To exit menu options, or any of the other menu option screens, repeatedly press and release the **MENU** Menu button until you are returned to the default display screen.

The following sections explain each of the menu options in the order in which they are displayed on the *Menu Options* screen.

## SIRIUS ID

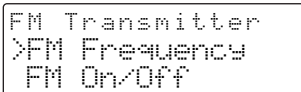
The *Sirius ID* menu option displays your 12 digit Sirius ID (SID) number. (Figure 2) The SID is unique to every receiver and is required to activate your service. It is recommended that you write this number in the space provided near the end of this user guide. No adjustments are allowed in this mode. To exit the *Sirius ID* menu, press the **MENU** Menu.



**Figure 2**

## FM Transmitter


The *FM Transmitter* menu option provides for turning the FM transmitter On and Off, and changing the FM frequency which the receiver will broadcast on. (Figure 3) By default, the FM transmitter is on and the FM frequency is set to 88.1 MHz. This frequency may not be suitable for your area.

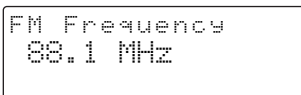


```
FM Transmitter
>FM Frequency
FM On/Off
```

**Figure 3**

### FM Frequency


To change the FM frequency, use the ▲▼ Channel Up/Down buttons and ◀▶ Category Previous/Next buttons to adjust the FM frequency. The ▲▼ Channel Up/Down buttons adjust in 0.1 MHz increments and the ◀▶ Category Previous/Next buttons adjust in 1 MHz increments. (Figure 4) Press the  Select button to set the new FM frequency.

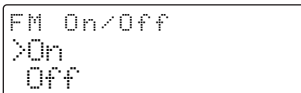


```
FM Frequency
88.1 MHz
```

**Figure 4**

### FM On/Off

To turn the receiver's FM transmitter On or Off, use the ▲▼ Channel Up/Down buttons to select your choice and press the  Select button. (Figure 5)



```
FM On/Off
>On
Off
```

**Figure 5**

## Settings

The Settings menu provides for changing the brightness and contrast of the display screen, and the display mode of the display screen. (Figure 6)

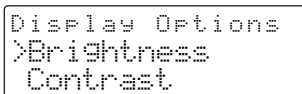



Figure 6

### Brightness

The *Brightness* menu option adjusts the overall intensity of the LCD display to help with viewing in different lighting conditions. Use the ▲▼ Channel Up/Down buttons to adjust the brightness and press the  Select button to set your choice. (Figure 7) The bar graph will move to indicate the change.

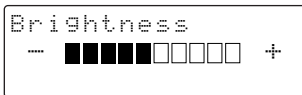



Figure 7

### Contrast

The *Contrast* menu option adjusts the relationship between the background and the text on the LCD display. Use the ▲▼ Channel Up/Down buttons to adjust the brightness and press the  Select button to set your choice. (Figure 8) The bar graph will move to indicate the change.

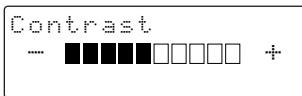



Figure 8



## Mode

The *Mode* menu option provides for changing the default display screen to display either the channel name, category name, or time. Refer to the **Display Screen Information** section on page 22 for examples.

Use the ▲▼ Channel Up/Down buttons to select the desired mode and press the  Select button to set your choice. (Figure 9)

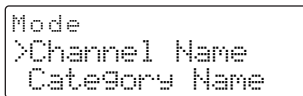



Figure 9

## Audio Level

The *Audio Level* menu option adjusts the level of the audio output of the receiver. To adjust the audio level, use the ▲▼ Channel Up/Down buttons to change the audio level and press the  Select button to set your choice. (Figure 10). The bar graph will move to indicate the change.

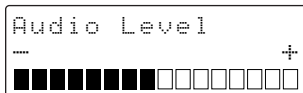



Figure 10

## Tones

The *Tones* menu option is for selecting whether an audio tone will be heard as you navigate menus and lists. To turn the tones on or off, use the ▲▼ Channel Up/Down buttons to select your choice and press the  Select button to set your choice. (Figure 11).

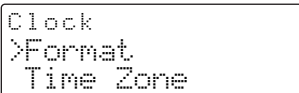


**Figure 11**

## Clock


The *Clock* menu option provides for adjustment of the clock format, the time zone, and day-light savings time function. (Figure 11)

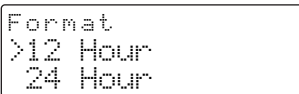
The time data for the receiver's clock is provided via the SIRIUS signal, and will update based on the data received from the signal.



**Figure 11**


### Format

The *Format* menu option is for changing the clock display format of the receiver to 12 hour or 24 hour format. Use the ▲▼ Channel Up/Down buttons to select the desired format and press the  Select button to set your choice. (Figure 12)



**Figure 12**

### Time Zone

The *Time Zone* menu option is for changing the time zone of the receiver. Use the ▲▼ Channel Up/Down buttons to select the desired time zone and press the  Select button to set your choice. (Figure 13)

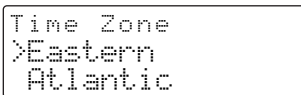



Figure 13

### Daylight Savings Time

The *Daylight Savings Time* menu option is for turning the Daylight Savings Time feature On or Off. Use the ▲▼ Channel Up/Down buttons to select on or off and press the  Select button to set your choice. (Figure 14)

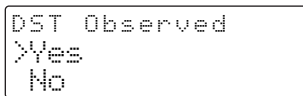




Figure 14

## Jump Settings

The *Jump* menu option is used to select a city for Traffic and Weather reports when the  Jump button is pressed. Use the ▲▼ Channel Up/Down buttons to select a city and press the  Select button to set your choice. (Figure 15)

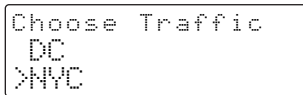


Figure 15

# Channel Lock

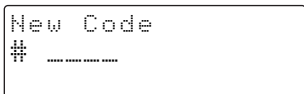
The *Channel Lock* menu option provides the ability to lock out with password protection any channels you do not want others to access without your permission. A locked channel will not appear in the channel list.

When access to a locked channel is attempted using the direct channel entry method, the *Enter Code* screen is displayed and the channel cannot be accessed until the correct code is entered.

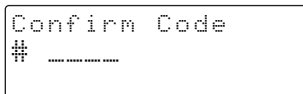
## Lock/Unlock

The *Lock/Unlock* menu option is used for selecting specific channels to either lock or unlock. To lock or unlock a channel:

1. If this is the first time that Channel Lock is being used, you will be prompted to create and enter a four digit numerical code. (Figure 16) This code can be any four digit number from 0000 to 9999. Then you will be prompted again to confirm the code you just entered. (Figure 17) If you should exit this prompt without entering a code, you will be prompted to set a code next time you enter the Lock/Unlock menu option.

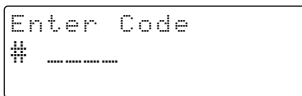


**Figure 16**




**Figure 17**

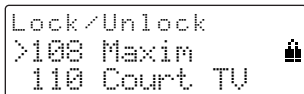
If a code has been previously set, the *Enter Code* prompt will be displayed. Enter your four digit code and press the Select button to continue. (Figure 18)




**Figure 18**

2. When the correct code has been entered, a you will enter a list of channels. Use the ▲▼ Channel Up/Down buttons to navigate to the channel you wish to lock or unlock,

and press the  Select button. A locked channel will have the lock icon displayed to the right of the channel number and name. (Figure 19)



**Figure 19**

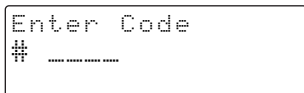
You can continue to select channels for locking or unlocking until you are finished. To exit the *Lock/Unlock* menu option press the  Menu button.

### **Edit Code**

The *Edit Code* menu option is used to change a previously selected channel lock code. (The first time the Edit Code menu option is selected you will be prompted to enter a four digit code as described in the previous section.) (Figures 16 & 17)

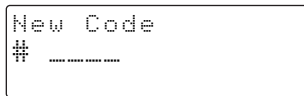
To edit the channel lock code:

1. At the prompt, enter the current four digit channel lock code. (Figure 20) If you do not enter the correct code, a message will be displayed alerting you that the wrong code was entered (Figure 24), and you will be prompted again to enter the code again. (If you have forgotten your Parental Control code, call SIRIUS Customer Service for help.)



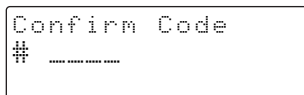
**Figure 20**

2. When the correct code is entered, you will be prompted to enter the new channel lock code. (Figure 21)



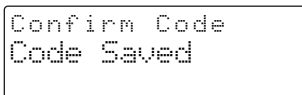
**Figure 21**

3. You will then be prompted to confirm the new channel lock code by entering it again. (Figure 22)

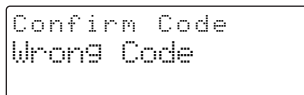


**Figure 22**

4. If you confirmed the correct channel lock code, a confirmation screen is displayed. (Figure 23) If you entered the wrong code, you will be alerted and you will have to repeat the process again. (Figure 24)



**Figure 23**

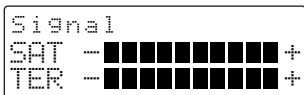


**Figure 24**

To exit the *Edit Code* menu option press the **MENU** Menu button.

# Signal

The *Signal* menu option provides a visual display of the strength of the SIRIUS signal from the satellite antenna and also from terrestrial (ground) transmitters. (Figure 25)



**Figure 25**

To exit the *Signal* menu option press the **MENU** Menu button.

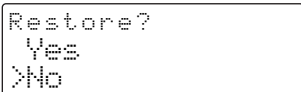
## Factory Default

The *Factory Default* menu option will restore most every feature of the receiver to the original factory settings. The following is a list of all features affected by the Factory Default option:

- All Presets are cleared
- Receiver set to Normal Tuning Mode
- Display brightness set to 50%
- Display Contrast set to 50%
- FM Transmitter set to On
- FM Frequency set to 88.1 MHz
- Jump setting is cleared
- Top line display mode set to Channel Name
- Audio level set to -3db
- Confirmation Tone set to On

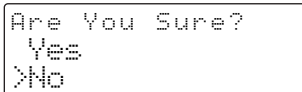
Note that the Channel Lock feature is not affected by the Factory Default option. If a code has been set for the channel lock, the code will not be reset by the Factory Default feature, preventing circumvention of the channel lock feature. Channels which have been locked will remain locked.

When you perform a Factory Default, you will be prompted twice to confirm that you really want to proceed. (Figures 26 & 27)



```
Restore?  
Yes  
>No
```

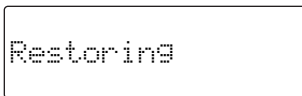
**Figure 26**



```
Are You Sure?  
Yes  
>No
```

**Figure 27**

If you choose to proceed, the receiver will confirm that the factory defaults are being restored. (Figure 28) When the Factory Default is complete, the receiver will display *Call 1-888-539-SIRIUS to Subscribe*, the preview channel. The receiver is still subscribed to the SIRIUS service.



```
Restoring
```

**Figure 28**



# Troubleshooting

<b>Symptom</b>	<b>Solution</b>
Receiver does not power on	Blown fuse, or the power cable is not properly connected. Check for a bad fuse and check power cable connection
Receiver displays: <i>No Antenna</i>	The satellite antenna is not connected to the receiver. Check the satellite antenna connection to the receiver.
Receiver displays: <i>Acquiring Signal</i>	No satellite signal is being received. Check for obstacles over or around the satellite antenna. Change the vehicle location to eliminate nearby obstacles (bridges, overpasses, tress, buildings, etc.).
Audio static or loss of clarity	The FM frequency contains static. Locate a quiet FM frequency on your vehicle radio and set the FM transmitter frequency of the receiver to match. If using the AUDIO OUT connector, check the cable connections.
No sound	The audio cables are not connected, or the FM radio is set to the wrong frequency. Check the audio cables at the receiver and the radio. Tune the FM radio to the same FM frequency the receiver is tuned.

# Specifications

Satellite Frequencies	2322.293/2330.207 MHz
Terrestrial Frequencies	2326.250MHz
Receiver Power Requirements	4.9–5.6 Volts, Negative Ground, DC
Cigarette Lighter Adapter Power Requirements	9–16 Volts, Negative Ground, DC
Audio Output	.550mVrms (+/- 50mVrms)
Total Harmonic Distortion (THD)	<0.2%
Signal-to-noise (S/N)	Greater than 73dB
Fuse Requirement	2A ATC
Receiver Dimensions (Length x Width x Depth)	122.0mm x 48.0mm x 18.2mm (4.8" x 1.9" x 0.7")
Receiver Weight	88.0g (3.1 oz.)
Antenna Type	Low Profile Magnetic
Antenna Cable Length	.21' (single micro-cable)
Connector Type	SMB (right-angle)
Audio Interface	1/8" / 3.5mm Stereo Jack
FM Out Interface	2.5mm Jack

Note: Features and Specifications are subject to change without notice.

# Warranty

## **12 Month Warranty**

SIRIUS Satellite Radio Inc. (the "Company") warrants to the original retail purchaser of this product that should this product or any part thereof, under normal use and conditions, be proven defective in material or workmanship within 12 months from the date of original purchase, such defect(s) will be repaired or replaced with new or reconditioned product (at the Company's option) without charge for parts and repair labor. To obtain repair or replacement within the terms of this Warranty, the product is to be delivered with proof of warranty coverage (e.g. dated bill of sale), specification of defect(s), transportation prepaid, to the location shown below under WARRANTY RETURN.

This Warranty does not extend to the elimination of externally generated static or noise, to correction of antenna problems, to costs incurred for installation, removal or reinstallation of the product, or to damage to tapes, compact discs, speakers, accessories, or vehicle electrical systems.

This Warranty does not apply to any product or part thereof which, in the opinion of the Company, has suffered or been damaged through alteration, improper installation, mishandling, misuse, neglect, accident, or by removal or defacement of the factory serial number/bar code label(s). THE EXTENT OF THE COMPANY'S LIABILITY UNDER THIS WARRANTY IS LIMITED TO THE REPAIR OR REPLACEMENT PROVIDED ABOVE AND, IN NO EVENT, SHALL THE COMPANY'S LIABILITY EXCEED THE PURCHASE PRICE PAID BY PURCHASER FOR THE PRODUCT.

This Warranty is in lieu of all other express warranties or liabilities. ANY IMPLIED WARRANTIES, INCLUDING ANY IMPLIED WARRANTY OF MERCHANTABILITY, SHALL BE LIMITED TO THE DURATION OF THIS WRITTEN WARRANTY. ANY ACTION FOR BREACH OF ANY WARRANTY HEREUNDER INCLUDING ANY IMPLIED WARRANTY OF MERCHANTABILITY MUST BE BROUGHT WITHIN A PERIOD OF 48 MONTHS FROM DATE OF ORIGINAL PURCHASE. IN NO CASE SHALL THE COMPANY BE LIABLE FOR ANY CONSEQUENTIAL OR INCIDENTAL DAMAGES FOR BREACH OF THIS OR ANY OTHER WARRANTY, EXPRESS OR IMPLIED, WHATSOEVER. No person or representative is authorized to assume for the Company any liability other than expressed herein in connection with the sale of this product. Some states do not allow limitations on how long an implied warranty lasts or the exclusion or limitation of incidental or consequential damage so the above limitations or exclusions may not apply to you. This Warranty gives you specific legal rights and you may also have other rights which vary from state to state.

**WARRANTY RETURN:** To obtain repair or replacement within the terms of this Warranty, please return product to an authorized retailer or call Customer Service at 1-800-869-5590; proof of purchase and description of defect are required. Products to be returned to an approved warranty station must be shipped freight prepaid.

# SIRIUS ID

Write down the SIRIUS ID (SID) of your SIRIUS InV SV2 in the space provided below.

SID: \_\_\_\_\_







**SIRIUS Customer Service: 1-888-539-7474**  
customer care@sirius-radio.com

**SIRIUS Satellite Radio Inc.**  
1221 Avenue of the Americas  
New York, NY 10020  
1-888-539-7474  
<http://www.sirius.com>

**SIRIUS Satellite Radio Inc.**

1221 Avenue of the Americas

New York, NY 10020

(800) 869-5590

<http://sirius.com>

**SIRIUS**   
**SATELLITE RADIO**

THE BEST RADIO ON RADIO™