

# 1. Product Overview

## 1.1 Product Layout

### Front Panel

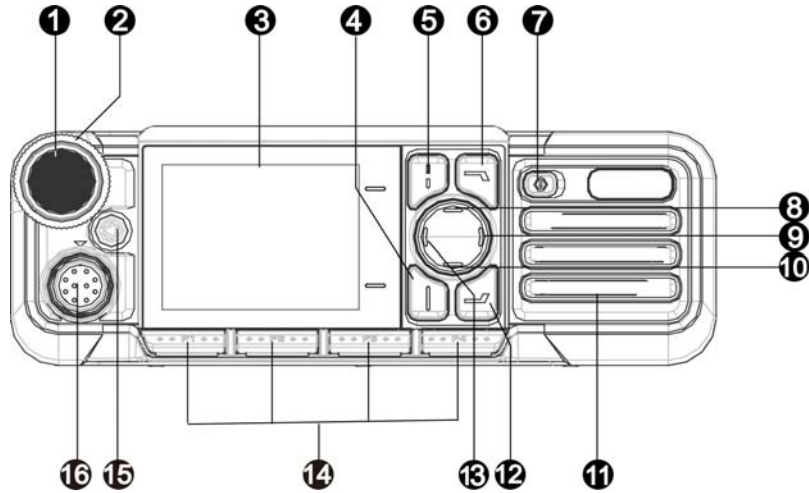

No.	Part Name	No.	Part Name
1	Volume Control & Channel/Group Selector Knob	9	Right Key
2	LED Indicator	10	Down Key
3	LCD Display	11	Speaker
4	OK/Menu Key	12	P5/Answer Key
5	Back/Subgroup Key	13	Left Key
6	P6/End Key	14	P1/P2/P3/P4 (Programmable Keys)
7	Power On/Off Key	15	Top Key (TK)
8	Up Key	16	Aviation Connector

## Rear Panel

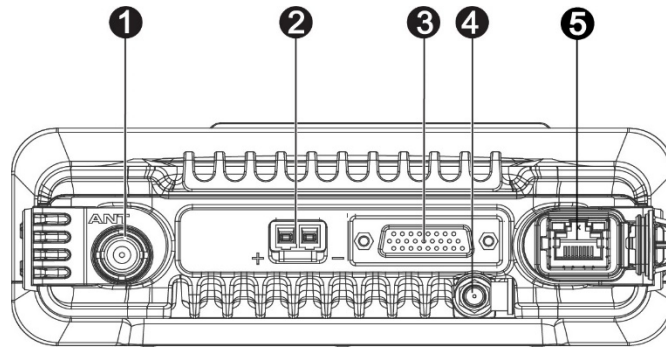

No.	Part Name	No.	Part Name
1	RF Antenna Connector	4	GPS Antenna Connector
2	Power Inlet	5	Network Port
3	Accessory connector	/	/



### Note

The GPS antenna connector is used only by radios with the GPS feature.

## Palm Microphone

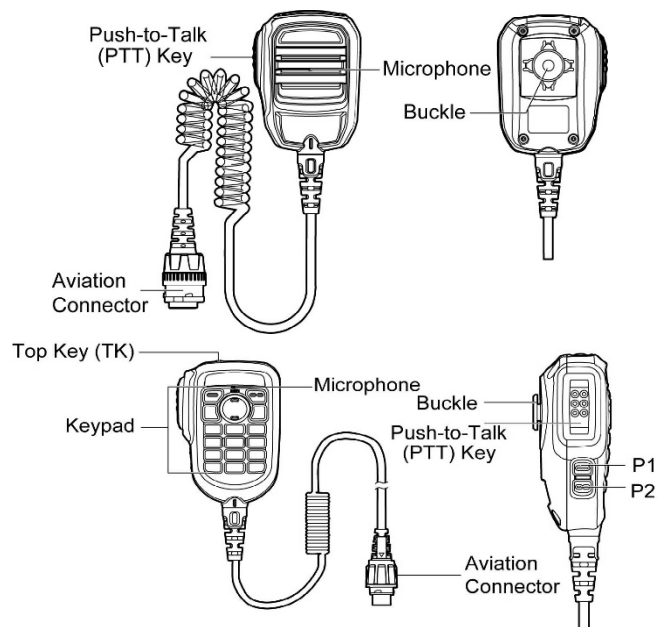

### Note

The palm microphone without keypad is available for the digital radio and the one with keypad is for the trunking radio.

## Handset

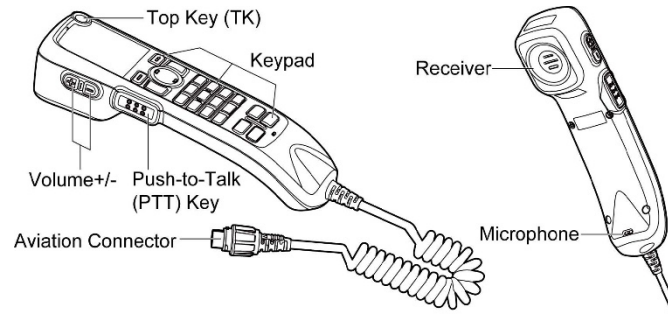

**Note**  
The handset is available only for the duplex radio.

---

## 1.2 Programmable Keys

You can request your dealer to program the following keys as shortcuts to assignable radio features:

- Mobile radio: **TK**, **P1** key, **P2** key, **P3** key, **P4** key, **P5/Answer** key, and **P6/End** key.
- Palm microphone with keypad: **TK**, **P1** key, and **P2** key.
- Handset: Same as the mobile radio.

## 2. Installation

### 2.1 Instructions

Before installing the radio in a vehicle, read the following instructions carefully:

- The radio must work with a 13.6V negative ground electrical system only. Ensure to check the ground polarity and voltage of the vehicle power supply prior to installation.
- Check how long the screws will extend from the bottom surface of the radio. Drill the mounting hole cautiously to avoid damage to the vehicle wiring and other parts.
- Connect the antenna and power cord to the radio before you install the radio in the bracket. Make sure the antenna and power cord are dedicated for digital radios of the Company.
- Install the radio with mounting bracket supplied by the Company, to avoid radio looseness in case of accidents. The loose radio may cause bodily injury.
- Install the radio in a location where you can reach the front panel conveniently.
- Keep sufficient clearance at the back of the radio for wiring.
- Be sure to use the fuse with the same specification for DC power cord upon replacement.
- If any other devices are in the vicinity of this radio, the antenna of this radio shall be no less than 10 meters away from that of such RF device.

### 2.2 Tools

- Electric drill
- Phillips screwdriver
- T6 torx screwdriver

## 2.3 Parts

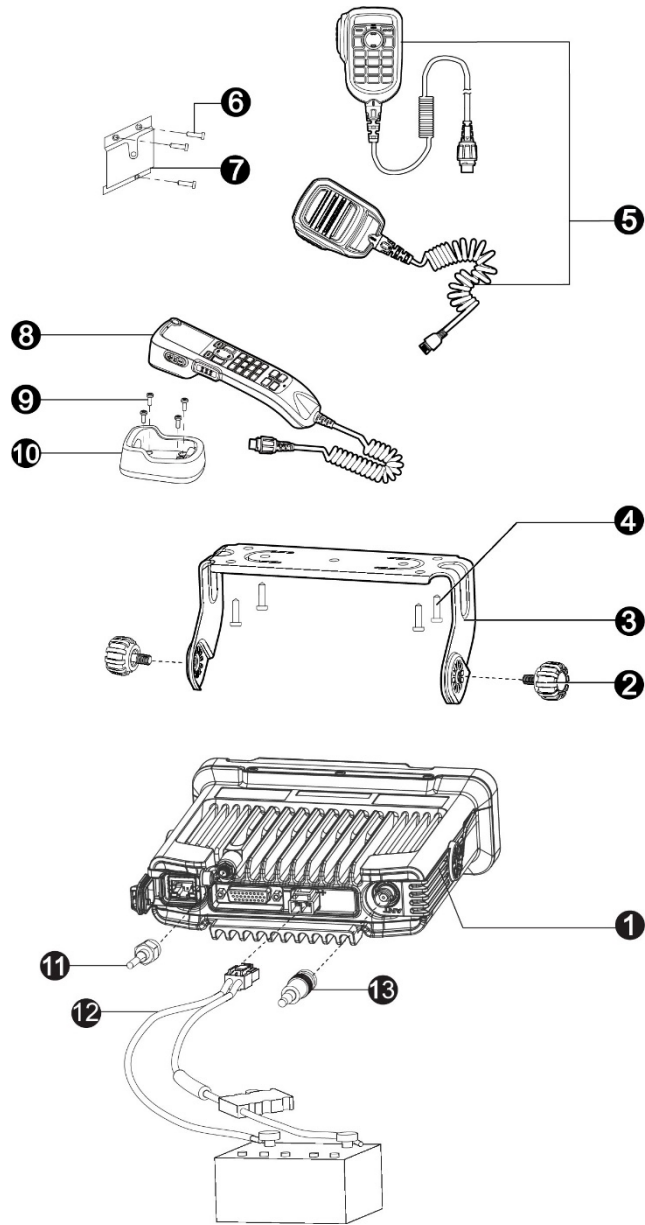

No.	Part Name	No.	Part Name
1	Mobile Radio	8	Handset
2	Locking Knobs	9	Screw (4 mm x 16 mm)
3	Mounting Bracket	10	Handset Hanger
4	Screw (4.8 mm x 20 mm)	11	GPS Antenna
5	Palm Microphone	12	Power Cord (with fuse)
6	Screw (4 mm x 16 mm)	13	RF Antenna
7	Microphone Hanger	/	/

---

 **Note**

- The RF antenna should be purchased separately.
  - The GPS antenna is available only for radios with the GPS feature.
  - The palm microphone without keypad (with ⑥ and ⑦) is available for the digital radio, and the one with keypad (with ⑥ and ⑦) is for the trunking radio. The handset (with ⑨ and ⑩) is for the duplex radio.
- 

## 2.4 Procedure

1. Select a location, drill holes based on the shape of the mounting bracket, and then use the screws (4.8 mm x 20 mm) to secure the bracket.
2. Connect the RF antenna, GPS antenna, and power cord to the radio.
3. Slide the radio into the mounted bracket, and then secure it using the locking knobs.
4. Install the microphone hanger in a location where you can reach it easily, and then use the screws (4 mm x 16 mm) to secure it.
5. Align the triangle index on the palm microphone or the handset with the installation index, plug the connector into the radio, and then rotate the connector clockwise to secure it.
6. Place the palm microphone or the handset on the hanger when you do not use it.

## 3. Basic Operations

### 3.1 Turning the Radio On or Off

To turn the radio on, long press the **On-Off** key.

To turn the radio off, press the **On-Off** key.

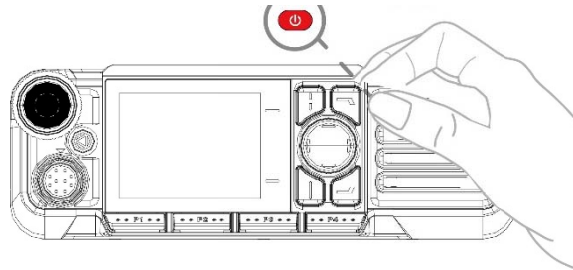

### 3.2 Adjusting the Volume

To increase or decrease the volume, rotate the **Smart** knob clockwise or counter-clockwise.

1. Press the **Volume Control** knob to switch to volume control mode.

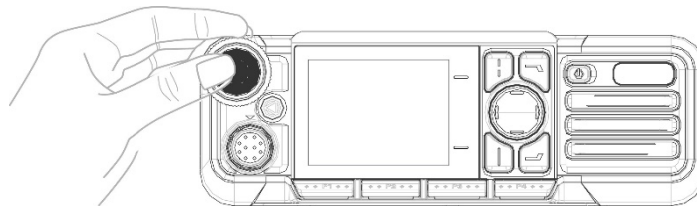

2. Rotate the **Volume Control** knob to adjust the volume.

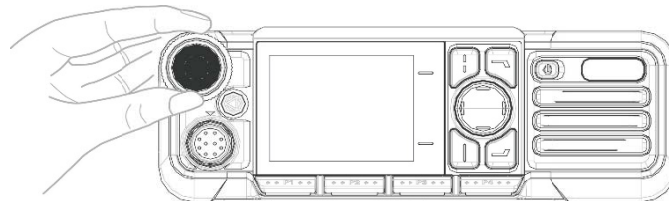

### 3.3 Using the Keypad

You can use the keypad on the palm microphone or the handset to edit user aliases or IDs and text messages.

- To switch the input method between alphabetic mode and numeric mode, press **# ↑**.
- To enter special characters, press **1 <** in alphabetic mode.
- To enter a space, press **\* ↵** in alphabetic mode.

---

#### Note

If not particularly specified, the keypad mentioned in this manual indicates that of the palm microphone with keypad or the handset.

---

## 3.4 Switching the Operation Mode

The radio can operate in conventional or trunking mode. In conventional mode, you can receive and transmit voice and data after selecting the required channel. In trunking mode, you can receive and transmit voice and data after the radio registers with the base station (BS) successfully.

- To manually switch the operation mode, go to **Mode>Manual Switch**, or press the preprogrammed **Operation Mode Switch** key.
- To allow the radio to automatically switch to conventional mode when the signal drops below the preset level in trunking mode, go to **Mode>Auto Switch**, or press the preprogrammed **Mode Automatic Switch** key.

### 3.4.1 Conventional Mode

In conventional mode, a channel is used to receive and transmit data and voice, and a zone is a group of channels within the same operational area. The radio receives and transmits data and voice on the selected channel.

#### 3.4.1.1 Selecting a Zone

- On the Zone menu, press the **Up** or **Down** key to select a zone, and then press the **OK/Menu** key.
- Press the preprogrammed **Zone Up** or **Zone Down** key.

#### 3.4.1.2 Selecting a Channel

- Press and rotate the **Smart** knob.
- Rotate the **Channel Selector** knob.
- Press the preprogrammed **Channel Up** or **Channel Down** key.
- Press the preprogrammed **Preset Channel** key.



If the Voice Notify feature is enabled by your dealer, the radio announces the channel number upon channel switching.

---

### 3.4.2 Trunking Mode

In trunking mode, the radio communicates with each other through base stations after successful registration. The radio can communicate with a group of radios or a single radio.

#### 3.4.2.1 Selecting Group or Private Contacts

- Rotate the **Group Selector** knob.
- Press the **Back/Subgroup** key, and then press the **Up** or **Down** key to select from the member list.
- Press the preprogrammed **Group/Private Up** or **Group/Private Down** key.



















### 3.4.2.2 **Selecting a Subgroup**

A subgroup consists of multiple groups or private contacts. To select a subgroup, do one of the following:

- Press the **Back/Subgroup** key, and then press the **Up** or **Down** key.
- Press the preprogrammed **Subgroup Up** or **Subgroup Down** key.

## 4. Status Indications

### 4.1 Checking LCD Icons

Icon	Radio Status
	The radio detects no signal.
	More bars indicate stronger signal strength.
	The radio operates in low power mode.
	The radio operates in high power mode.
	The keypad is locked.
	An accessory is connected.
	The Mode Automatic Switch feature is enabled.
	The radio is scanning.
	The Voice Operated Transmit (VOX) feature is enabled.
	The radio operates in silent mode.
	The radio operates in profile 1.
	The radio operates in profile 2.
	The radio is in emergency mode.
	There is/are missed call(s).
	There is/are new/unread message(s).
	The inbox is full.

For more status icons, refer to the relevant user manual.

### 4.2 Checking LED Indications

Status	Radio Status
Flashes green	The radio is being turned on.
Flashes green slowly	The radio is standby in trunking mode.
Glowes green	The radio is receiving.

Glows red	The radio is transmitting.
Flashes red	The radio is establishing a call in trunking mode. This indication is applicable only to the calling radio.
Flashes orange slowly	<ul style="list-style-type: none"> <li>● Conventional mode: The radio is scanning or roaming.</li> <li>● Trunking mode: The radio is hunting.</li> </ul>
Flashes orange rapidly	<ul style="list-style-type: none"> <li>● Conventional mode: The radio is operating in Emergency mode.</li> <li>● Trunking Mode: The radio is establishing a Full Off Air Call Set-up (FOACSU) private call. This indication is applicable only to the called radio.</li> </ul>
Glows orange	Call hang time: No voice is being transmitted or received during a call. Within such a period, you can press and hold the <b>PTT</b> key and speak.
Flashes blue every 3s	The BT feature is enabled, but no BT device is connected.
Flashes blue every 1.5s	A BT device is connected.
Flashes blue every 0.1s	The BT feature is being disabled.

## 5. Call Services

When you are speaking during a call, keep the microphone about 2.5 to 5 cm away from your mouth. This ensures optimal voice quality on the receiving radio.

---

### Note

The radio cannot make any call if it fails to register with the BS or you select an empty group.

---



## 5.1 Digital Calls

You can initiate or receive the following types of digital calls:

- Group call: A call from an individual user in a group to all the other members.
- Private call: A call from an individual user to another individual user.



### 5.1.1 Initiating Group Calls

#### 5.1.1.1 Through Preset Contact

1. Press and rotate the **Smart** knob to select the digital channel or group contact.
2. Do either of the followings:
  - Press  on the mobile radio.
  - Press  or press and hold the **PTT** key on the palm microphone or the handset.

#### 5.1.1.2 Through Contact List/Favorite Contact

##### Conventional Mode



1. Go to **Contact>ContactList/FavoriteContact**.
2. Select the required group contact.
3. Do either of the followings:
  - Press  on the mobile radio.
  - Press  or press and hold the **PTT** key on the palm microphone or the handset.

##### Trunking Mode



1. Go to **Subgroup>Members**.
2. Select the required group contact.
3. Do either of the followings:
  - Press  on the mobile radio.

- Press  or press and hold the **PTT** key on the palm microphone or the handset.

### 5.1.1.3 Through Manual Dial Conventional Mode

1. Go to **Contact>Manual Dial**.
2. Press on the palm microphone or the handset to switch the input mode to **GroupID**.
3. Enter the required group ID.
4. Do either of the followings:
  - Press  on the mobile radio.
  - Press  or press and hold the **PTT** key on the palm microphone or the handset.

### Trunking Mode

1. Go to **Settings>Radio Set>KeypadMode**, and then select **Enable**.
2. From the homescreen, enter the group number.
3. Do either of the followings:
  - Press  on the mobile radio.
  - Press  or press and hold the **PTT** key on the palm microphone or the handset.



#### Note

For dialing rules, contact your dealer.

---

## 5.1.2 Receiving Group Calls

You can receive a group call without any operation in conventional or trunking mode.

## 5.1.3 Ending a Group Call

### 5.1.3.1 Conventional Mode

In conventional mode, a group call ends when the call hang time expires.

### 5.1.3.2 Trunking Mode

In trunking mode, a group call ends in any of the following cases:

- The calling party ends the call.
- The call duration preset by your dealer expires.
- A preemptive or emergency call interrupts the call.
- The calling party switches to an empty group

- The base station signal is lost.

## 5.1.4 Initiating Private Calls

You can initiate simplex or duplex calls, which can be set by going to **Settings>Radio Set>Call Setup Mode** or pressing the preprogrammed **Call Setup Mode** key.

- Duplex call: Both parties can speak at the same time.
- Simplex call: Only one party can speak at one time.





### Note



The duplex call is only available for duplex radios.

---



### 5.1.4.1 Through Preset Contact

1. Press and rotate the **Smart** knob to select the digital channel or private contact.
2. Do either of the followings:
  - Press  on the mobile radio.
  - Press  or press and hold the **PTT** key on the palm microphone or the handset.



### 5.1.4.2 Through Contact List/Favorite Contact

1. Go to **Contact>ContactList/FavoriteContact**.
2. Select the required private contact.
3. Do either of the followings:
  - Press  on the mobile radio.
  - Press  or press and hold the **PTT** key on the palm microphone or the handset.

### 5.1.4.3 Through Manual Dialing Conventional Mode

1. Go to **Contact>Manual Dial**.
2. Press on the palm microphone or the handset to switch the input mode to **PrivateID**.
3. Enter the required private ID.
4. Do either of the followings:
  - Press  on the mobile radio.
  - Press  or press and hold the **PTT** key on the palm microphone or the handset.

## Trunking Mode

1. Go to **Settings>Radio Set>KeypadMode**, and then select **Enable**.
2. From the homescreen, enter the private call number.
3. Do either of the followings:
  - Press  on the mobile radio.
  - Press  or press and hold the PTT key on the palm microphone or handset.



### Note

For dialing rules, contact your dealer.

---

## 5.1.5 Receiving Private Calls



### 5.1.5.1 Conventional Mode

You can receive a private call without any operation.

### 5.1.5.2 Trunking Mode

You can listen to a call in different ways varying with the setup mode of the call:

- FOACSU

When receiving a FOACSU private call, the radio rings and vibrates. To answer the call, press  on the radio, or press  or press and hold the **PTT** key on the palm microphone or the handset within the preset time period.

- Off Air Call Set-Up (OACSU)

When receiving an OACSU private call, you can listen to it without any operation.

## 5.1.6 Ending Private Calls

### 5.1.6.1 Conventional Mode

In conventional mode, a private call ends when the call hang time expires.

### 5.1.6.2 Trunking Mode

In trunking mode, a private call ends in any of the following cases:

- The calling party ends the call.
- The call duration preset by your dealer expires.
- A preemptive or emergency call interrupts the call.
- The calling party switches to an empty group

- The base station signal is lost.

## 5.2 Analog Calls

In conventional mode, you can initiate or receive a call on an analog channel with or without signaling.

### 5.2.1 Call Without Signaling

On an analog channel without signaling, you can initiate a call to all the other users on the channel. Do as follows:

1. Select the required channel.
2. Press and hold the **PTT** key, and speak into the microphone.

### 5.2.2 Call With Signaling

On an analog channel with signaling, you can initiate a call to a specific contact on the channel. Do as follows:

1. Rotate the **Channel Selector** knob to select the required channel.
2. Press the **OK/Menu** key, and go to **Contact >Contact List**.
3. Select the required channel.
4. Press the **PTT** key or the preprogrammed **One TouchCall/Menu** key to send the code.

The call is established when the target radio receives and decodes the matched signaling.

## 5.3 Emergency Call

The Emergency feature allows you to ask for help from your companion or the control center in case of emergency.

With the highest priority, you can make an emergency call even when your radio is transmitting or receiving.

This feature needs to be configured and enabled by your dealer. For details, refer to the Emergency feature described in the relevant user manual.



## 4. Message Services

The radio can send and receive short messages, which are classified into the following types:

- Quick text message: a frequently used text message that can be created, edited, or deleted through the menu.
- Status message: a predefined code that transfers the message content. Status message: a predefined code that transfers the message content.

### 4.1 Sending a New Message

1. Go to **Menu>Message>Msg New>New Msg** to enter the new message interface.
2. In the recipient text box, enter the contact number, and then press  to switch the number type.  
Alternatively, press the **OK/Menu** key to enter the contact list, and then select the contact.
3. In the message text box, enter the message content.  
Alternatively, select **Insert**, and then press the **OK/Menu** key to add quick text message or status message (in trunking mode).
4. Select **Send**, and then press the **OK/Menu** key.

### 4.2 Editing a Message

1. Go to **Menu>Message** to enter the message interface.
2. Select the message, press the **OK/Menu** key, and then do one of the following:
  - Select **Reply** to reply to the message.
  - Press the **Up** key, select a message, press the **OK/Menu** key, and then do one of the following:
    - » Select **Forward** to forward the message.
    - » Select **Resend** to resend the message.
    - » Select **Delete** to delete the message.
    - » Select **Delete All** to delete all messages with the contact.

For details on more features and operations, please visit our website at <http://www.hytera.com> or scan the QR code to download the relevant user manual.

## FCC Statement

This equipment has been tested and found to comply with the limits for a Class B digital device, pursuant to part 15 of FCC Rules. These limits are designed to provide reasonable protection against harmful interference in a residential installation. This equipment generates and can radiate radio frequency energy. If not installed and used in accordance with the instructions, it may cause harmful interference to radio communications. However, there is no guarantee that interference will not occur in a particular installation. Verification of harmful interference by this equipment to radio or television reception can be determined by turning it off and then on. The user is encouraged to try to correct the interference by one or more of the following measures:

- Reorient or relocate the receiving antenna. Increase the separation between the equipment and receiver.
- Connect the equipment into an outlet on a different circuit to that of the receiver's outlet.
- Consult the dealer or an experienced radio/TV technician for help.

Operation is subject to the following two conditions:

- This device may not cause harmful interference.
- This device must accept any interference received, including interference that may cause undesired operation.

Note: Any changes or modifications to this unit not expressly approved by the party responsible for compliance could void the user's authority to operate the equipment.

### FCC Radiation Exposure Statement

This equipment complies with FCC radiation exposure limits set forth for a controlled environment.

This transmitter must not be co-located or operating in conjunction with any other antenna or transmitter. This equipment should be installed and operated with minimum distance 40cm between the radiator & your body.

### RF Energy Exposure Awareness and Control Information and Operational Instructions for Occupational Use

**NOTICE: This radio is intended for use in occupational/controlled conditions where users have full knowledge of their exposure and can exercise control over their exposure to meet the occupational limits in FCC and International standards. This radio device is NOT authorized for general population consumer use.**

## Compliance with RF Exposure Standards

Hytera's radio complies with the following RF energy exposure standards and guidelines:

- United States Federal Communications Commission, Code of Federal Regulations; 47 CFR § 1.1307, 1.1310 and 2.1093
- American National Standards Institute (ANSI) /Institute of Electrical and Electronic Engineers (IEEE) C95.1:2005; Canada RSS102 Issue 5 March 2015
- Institute of Electrical and Electronic Engineers (IEEE) C95.1:2005 Edition

## RF Exposure Compliance and Control Guidelines and Operating Instructions

To control your exposure and ensure compliance with the occupational/controlled environmental exposure limits, always adhere to the following procedures.

Guidelines:

- Do not remove the RF Exposure Label from the device.
- User awareness instructions should accompany device when transferred to other users.
- Do not use this device if the operational requirements described herein are not met.

Operating Instructions:

- Transmit no more than the rated duty factor of 50% of the time. To transmit (talk), push the Push-To-Talk (PTT) key. To receive calls, release the PTT key. Transmitting 50% of the time, or less, is important because the radio generates measurable RF energy only when transmitting (in terms of measuring for standards compliance).
- Use of non-approved antennas, batteries, and accessories causes the radio to exceed the FCC RF exposure guidelines.
- Contact your local dealer for the optional accessories of the product.

## ISED Statement

This device complies with Innovation, Science and Economic Development Canada Compliance

license-exempt RSS standard(s). Operation is subject to the following two conditions:

- This device may not cause harmful interference.
- This device must accept any interference received, including interference that may cause undesired operation.

Le présent appareil est conforme aux CNR d'Industrie Canada applicables aux appareils radio exempts de licence.

L'exploitation est autorisée aux deux conditions suivantes: (1) l'appareil ne doit pas produire de brouillage, et (2) l'utilisateur de l'appareil doit accepter tout brouillage radioélectrique subi, même si le brouillage est susceptible d'en compromettre le fonctionnement

## ISED Radiation Exposure Statement:

This device must be restricted to work related operations in an Occupational/Controlled RF exposure Environment.

This equipment should be installed and operated with minimum distance 40cm between the antenna & your body.

ISED exposition aux radiations:

Ce dispositif doit être limité aux opérations liées au travail dans un environnement d'exposition RF professionnel/contrôlé. Cet équipement doit être installé et utilisé avec un minimum de 40cm de distance entre le antenne et votre corps.

## EU Regulatory Conformance

As certified by the qualified laboratory, the product is in compliance with the essential requirements and other relevant provisions of the following directives: 2014/53/EU,

2006/66/EC, 2011/65/EU, and 2012/19/EU.

Please note that the above information is applicable to EU countries only.