

Preface

Thanks for your favor in our product. To derive optimum performance from the product, please read this manual, the corresponding TETRA Terminal Series Feature Book and the Safety Information Booklet carefully before use.

This manual is applicable to the following model:

MT680 Plus F4

Copyright Information

Hytera is the trademark or registered trademark of Hytera Communications Co., Ltd. (the Company) in PRC and/or other countries or areas. The Company retains the ownership of its trademarks and product names. All other trademarks and/or product names that may be used in this manual are properties of their respective owners.

Disclaimer

The Company endeavors to achieve the accuracy and completeness of this manual, but no warranty of accuracy or reliability is given. All the specifications and designs are subject to change without notice due to continuous technology development. No part of this manual may be copied, modified, translated, or distributed in any manner without the express written permission of us.

We do not guarantee, for any particular purpose, the accuracy, validity, timeliness, legitimacy or completeness of the Third Party products and contents involved in this manual.

If you have any suggestions or would like to learn more details, please visit our website at:

<http://www.hytera.com>.

RF Energy Exposure Compliance

- Your radio is designed and tested to comply with a number of national and international standards and guidelines (listed below) regarding human exposure to radio frequency electromagnetic energy. This radio complies with the FCC RF exposure limits for occupational or controlled RF exposure environment and is authorized by the FCC for occupational use only. In terms of measuring RF energy for compliance with the FCC exposure guidelines, your radio radiates measurable RF energy only while it is transmitting (during talking), not when it is receiving (listening) or in standby mode.
- The device complies with RF field strength limits of RSS requirement

Your radio complies with the following of RF energy exposure

standards and guidelines

- United States Federal Communications Commission, Code of Federal Regulations; 47CFR part 2 sub-part J
- American National Standards Institute (ANSI)/Institute of Electrical and Electronic Engineers (IEEE) C95. 1:2005; Canada RSS-119 Issue 12, MAY 2015; RSS-247 Issue 1 May 2015
- Institute of Electrical and Electronic Engineers (IEEE) C95. 1-2005 Edition
- International Commission on Non-Ionizing Radiation Protection (ICNIRP) 1998

FCC & IC Statement

- To ensure optimal performance and compliance with the occupational/controlled environment RF energy exposure limits in the above standards and guidelines, users should transmit no adhere to the following procedures:
- Transmit no more than the rated duty factor of 50% of the time. To transmit (talk), push the Push-To-Talk (PTT) button. To receive calls, release the PTT button. Transmitting 50 % of the time, or less, is important because this radio generates measurable RF energy exposure only when transmitting (in terms of measuring for standards compliance).
- Gain of antenna must not exceed 5.5dBi.
- Antenna Installation: Install the mobile antenna at least 35 cm away from your body, in accordance with the requirements of the antenna manufacturer/supplier.
- Pour assurer une performance optimale et le respect du travail / contrôlée limites d'exposition à l'environnement de l'énergie RF dans les normes et les lignes directrices ci-dessus, les utilisateurs respecter les procédures suivantes:
- Gain de l'antenne ne doit pas dépasser 5.5 dBi.
- Installation de l'antenne: Installez l'antenne portable au moins 35 cm de votre corps, conformément avec les prescriptions du fabricant de l'antenne / fournisseur.

FCC Statement

Operation is subject to the following two conditions: 1. This device may not cause harmful interference, and 2. This device must accept any interference received, including interference that may cause undesired operation.

Note:” Changes or modifications to this unit not expressly approved by the party responsible for compliance could void the user’s authority to operate the equipment.”

This device complies with Industry Canada licence-exempt RSS standard (s). Operation is subject to the following two conditions: (1) this device may not cause interference, and (2) this device must accept any interference, including interference that may cause undesired operation of the device.

Le présent appareil est conforme aux CNR d'Industrie Canada applicables aux appareils radio exempts de licence.

L'exploitation est autorisée aux deux conditions suivantes:

(1) l'appareil ne doit pas produire de brouillage, et

(2) l'utilisateur de l'appareil doit accepter tout brouillage radioélectrique subi, même si le brouillage est susceptible d'en compromettre le fonctionnement.

PROFESSION USE WARNING

NOTICE: This radio is intended for use in occupational/controlled conditions, where users have full knowledge of their exposure and can exercise control over their exposure to meet FCC limits. This radio device is NOT authorized for general population, consumer, or any other use.

Contents



| | |
|--|-----------|
| 1. Document Conventions | 1 |
| 1.1 Instructional Conventions..... | 1 |
| 1.2 Notational Conventions..... | 1 |
| 1.3 Key Operation..... | 1 |
| 1.4 Term Explanation..... | 1 |
| 2. Items in the Package | 3 |
| 3. Product Overview | 4 |
| 3.1 Front Panel | 5 |
| 3.2 Rear Panel..... | 6 |
| 3.3 Programmable Keys | 6 |
| 4. Before Use | 7 |
| 4.1 Installation..... | 7 |
| 4.1.1 Installation Instructions | 7 |
| 4.1.2 Installation Tools | 7 |
| 4.1.3 Installation Steps..... | 8 |
| 5. Status Indication | 12 |
| 5.1 Status Icon..... | 12 |
| 5.2 Operation Icon | 13 |
| 5.3 LED Indicator | 13 |
| 6. Menu Navigation..... | 14 |
| 6.1 TMO Menu..... | 15 |
| 6.2 DMO Menu | 15 |
| 7. Basic Operations..... | 16 |
| 7.1 Turning On/Off..... | 16 |
| 7.2 Switching Operation Mode..... | 16 |
| 7.3 Adjusting the Call Volume..... | 16 |
| 7.4 Inputting through Keypad..... | 16 |
| 7.5 Locking/Unlocking the Keypad..... | 16 |
| 7.6 PIN Code Security and Changing | 17 |
| 7.7 Managing the Contacts | 17 |
| 7.7.1 Contact List..... | 17 |
| 7.7.2 New Contact | 17 |
| 7.7.3 Viewing the Memory Capacity | 17 |
| 8. Call Services | 18 |
| 8.1 TMO..... | 18 |
| 8.1.1 Individual Call | 18 |
| 8.1.2 Group Call..... | 19 |

| | |
|---|-----------|
| 8.1.3 Telephone Call | 20 |
| 8.1.4 Emergency Call | 20 |
| 8.2 DMO | 21 |
| 8.2.1 Individual Call | 21 |
| 8.2.2 Group Call..... | 21 |
| 8.2.3 Emergency Call | 21 |
| 9. Message | 22 |
| 9.1 Status Message | 22 |
| 9.2 User Message..... | 22 |
| 9.2.1 TMO..... | 22 |
| 9.2.2 DMO | 23 |
| 10. Troubleshooting | 24 |
| 11. Care and Cleaning | 27 |
| 12. Optional Accessories..... | 27 |
| 13. Appendix | 28 |
| 13.1 SSI&TSI Dialing Rules | 28 |
| 13.2 Illustration for Fixing the Mounting Bracket | 28 |

1. Document Conventions

For your better understanding of this manual, please read the following conventions first.

1.1 Instructional Conventions

| Icon | Description |
|--|--|
|  Note | Indicates references that can further describe the related topics. |
|  Caution | Indicates situations that could cause data loss or equipment damage. |

1.2 Notational Conventions

| Convention | Description |
|-------------|--|
| “” | The quotation marks enclose the name of a software interface element. For example, click “OK”. |
| Bold | The text in boldface denotes the name of a hardware button. For example, press the PTT key. |
| -> | The symbol directs you to access a multi-level menu. For example, to select “New” from the “File” menu, we will describe it as follows: “File -> New”. |

1.3 Key Operation

| Operation | Definition |
|------------|--|
| Press | To press a key and release it quickly. |
| Long press | To press a key for the preset time (2s by default) and release it. |
| Hold down | To press a key and do not release it. |









1.4 Term Explanation

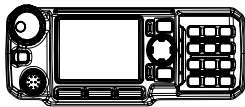

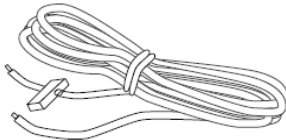
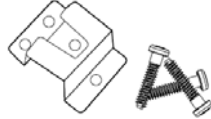

| Term | Description |
|-----------------|---|
| Individual Call | A half-duplex or full-duplex call initiated by an individual user to another individual user. |
| Group Call | A half-duplex call initiated by an individual user to a group. |

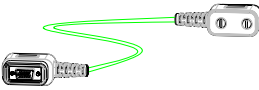
| Term | Description |
|------------------------------|---|
| Half-duplex | Half-duplex communication is also called “two-way alternate communication”. It indicates the communication is provided in both directions, but only one direction at a time, that is, only one party is allowed to transmit or receive at a time. |
| Full-duplex | Full-duplex communication is also called “full-duplex synchronous communication”. It indicates the communication is allowed in both directions simultaneously, that is, both parties can transmit and receive at the same time. |
| Direct Mode Operation (DMO) | DMO supports half-duplex operation and allows the terminals to communicate directly with each other, without using a TETRA network infrastructure. Thus functions that require network access, such as telephone call, will be unavailable. |
| Trunked Mode Operation (TMO) | TMO supports either half-duplex or full-duplex operation and allows the terminals to communicate with each other via the TETRA network. Thus functions that require network access are available. To operate in TMO mode, the terminal must be granted authorization by your service provider, and must stay within the network coverage. |

2. Items in the Package

Please unpack carefully and check that all items listed below are received. If any item is missing or damaged, please contact your dealer.

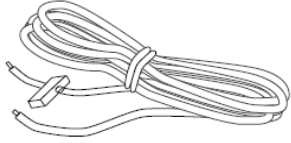
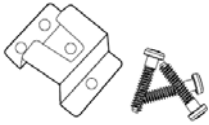
| For Mobile Terminal | | |
|---|---|---|
|  |  |  |
| Mobile Terminal | Mounting Bracket Kit (1set) | Palm Microphone |
|  |  |  |
| Fuse | Power Cord | Microphone Hanger and Screws |
|  | | |
| Documentation Kit | | |
| For Mobile Terminal (Remote Mounted) | | |
|  |  |  |
| Mobile Terminal (Remote Mounted) | Remote Mounting Cable | Mounting Bracket Kit (2 sets) |

| | | |
|---|---|---|
|  |  |  |
| <p>Palm Microphone</p> | <p>Fuse</p> | <p>Power Cord</p> |
|  |  | |
| <p>Palm Hanger and Screws</p> | <p>Documentation Kit</p> | |

 **Note:** The antenna frequency band is marked on the label of antenna; if not, refer to the label on the product for frequency band information.

3. Product Overview

3.1 Front Panel

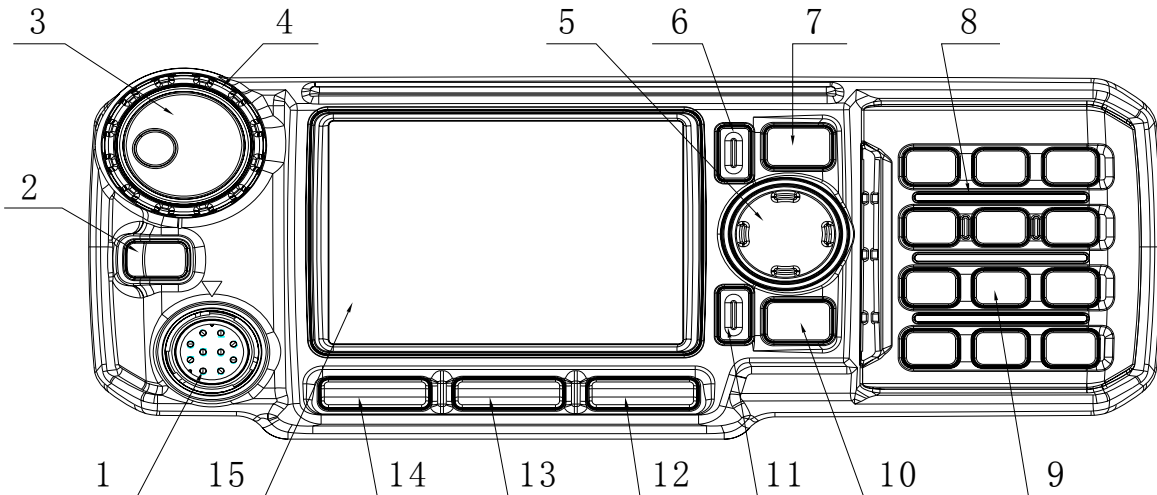

| No. | Part Name | No. | Part Name |
|-----|--|-----|-----------------|
| 1 | Microphone/Programming Cable Connector | 9 | Numeric Keypad |
| 2 | Emergency Key | 10 | Answer/Call Key |
| 3 | Volume Control/Group Selector Knob | 11 | OK Key |
| 4 | LED Indicator | 12 | Options/P3 Key |
| 5 | Navigation Key | 13 | GPS/P2 Key |
| 6 | Back Key | 14 | Function/P1 Key |
| 7 | Power On-Off/End Key | 15 | LCD Display |
| 8 | Speaker | / | / |

3.2 Rear Panel

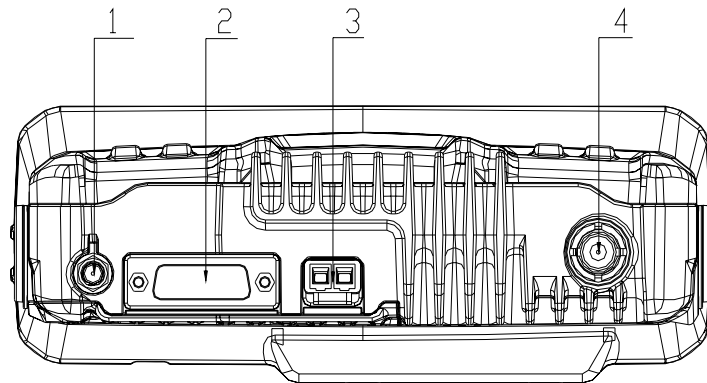

| No. | Part Name | No. | Part Name |
|-----|-----------------------|-----|-----------------------|
| 1 | GPS Antenna Connector | 2 | Accessory Connector |
| 3 | Power Inlet | 4 | BNC Antenna Connector |

3.3 Programmable Keys

For enhanced convenience, you can request your dealer to program the keys (navigation keys, numeric keys 1–9, * key, # key and  key) as the shortcuts to needed menus and functions. For the detailed introduction, please read the corresponding TETRA Terminal Series Feature Book.

4. Before Use

4.1 Installation

4.1.1 Installation Instructions

- This terminal is designed for a 10.8–15.6V (typical: 13.2V) negative ground electrical system. Please check the ground polarity and voltage of the vehicle power supply before you install this terminal.
- Plan a proper position to ensure sufficient space for heat dissipation, thus avoiding unexpected damage to other equipments in the vehicle due to overheating of the terminal that operates under high current.
- It is suggested to route the antennas and power cords in a concealed way, so that the driver can access the controls and operate easily.

4.1.2 Installation Tools

| Item | Qty. |
|--------------------------------------|---------|
| Digital multimeter | 1 |
| Slotted screwdriver | 1 |
| Philips screwdriver | 1 |
| Torx screwdriver | 1 |
| Adjustable wrench | 1 |
| Hex socket sleeve kit | 1 |
| Electric iron (40W) | 1 |
| Electric drill (better with battery) | 1 |
| Needle nose pliers | 1 |
| Diagonal pliers | 1 |
| Cable tie | several |
| Insulation tape | several |

4.1.3 Installation Steps

For Mobile Terminal

Step 1 Install the SIM card.

⚠ Caution: If a SIM card is required to realize the End-to-End Encryption (E2EE) feature which should be purchased separately, please install the SIM card first. Otherwise, you can start from Step 2.

1. Loosen the four screws on the bottom chassis, and remove the cover.

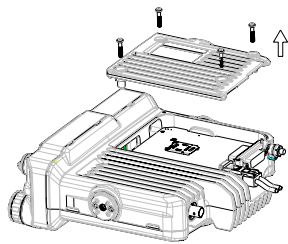

2. Insert the SIM card properly into the holder.

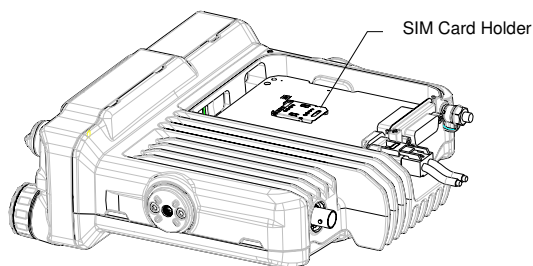

Note: Ensure that the waterproof ring is attached into the groove properly.

3. Return the cover and fasten the screws back on the chassis.

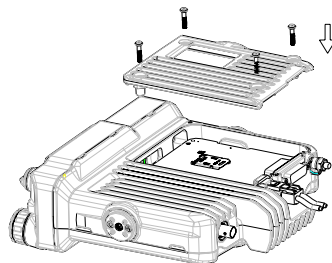

Step 2 Choose the installation site.

Taking into consideration the sizes of the terminal and the mounting bracket, survey the installation site and choose an appropriate location in vehicle, so as to ensure driving safety and communication quality.

Step 3 Secure the terminal.

Drill the holes at the place for installation according to the holes on the mounting bracket template, and secure the terminal with screws. (See “Illustration for Fixing the Mounting Bracket ” in “Appendix”).

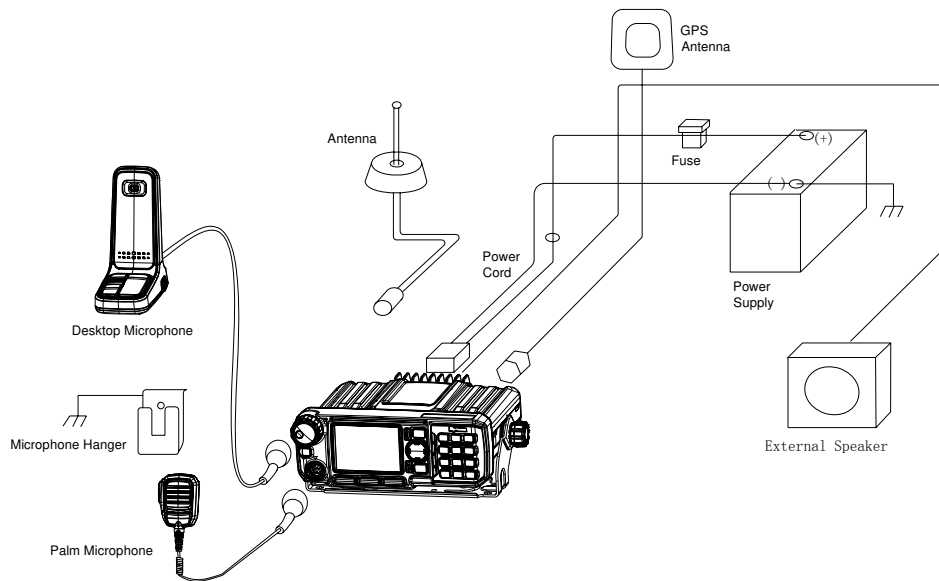
Step 4 Connect all the needed accessories to the terminal as shown below:

1. Connect the power cord.

⚠ Caution: Before the connection, ensure that the fuse is inserted into the fuse holder on the power cord.

- a. Connect the power cord to the power supply, with its black lead connected to the NEGATIVE pole and its red lead to the POSITIVE pole.
 - b. Plug the other end of the power cord into the power inlet of the terminal.
2. Connect the antenna: align the opening of antenna connector with the stud inside the BNC antenna jack and insert it into the jack, and then rotate the antenna connector clockwise until a click is heard. (The antenna needs to be purchased separately.)
 3. Connect the GPS antenna: align the GPS antenna connector with the GPS antenna jack on the terminal, and rotate the connector clock-wise to fasten it. (The GPS antenna needs to be purchased separately.)
 4. Connect the palm microphone.

- a. Install the microphone hanger: mount the hanger at a convenient position near the terminal. Align the screw holes on the hanger with the installation holes on the chosen position, and fasten the screws. See the figure below.

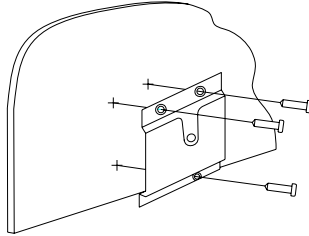

- b. Place the palm microphone onto the hanger.

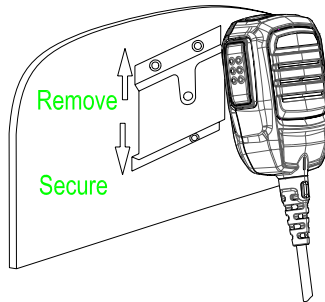

- c. Connect the palm microphone to the terminal: align the triangle mark on the microphone port with that above the microphone connector on the terminal. Plug the microphone port into the connector with force. Then rotate the cover of the microphone port clockwise to secure the microphone.

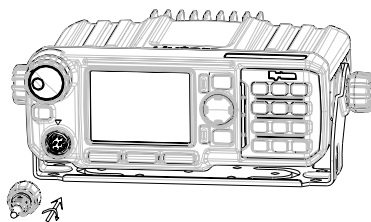

For Mobile Terminal (Remote Mounted)

Step 1 Choose the place for installation.

Take into consideration the size of the terminal and the mounting bracket, as well as the actual requirements on the vehicle, so as to ensure driving safety and communication quality.

Step 2 Install the remote control head (i.e. the front panel) and the terminal.

Drill holes at the place for installation and secure both the remote control head and the terminal (See "Illustration for Fixing the Mounting Bracket" in "Appendix").

Step 3 Connect the remote control head to the terminal with the remote mounting cable.

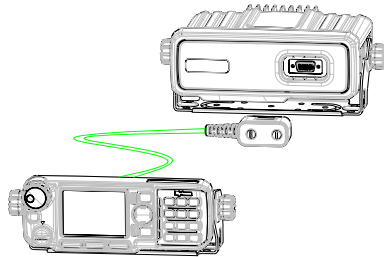

Step 4 Connect the accessories following Step 4 for installation of mobile terminal.

After the installation, the terminal is ready for use.





















5. Status Indication

5.1 Status Icon

| Name | Icon | Indication |
|----------------------|------|---|
| RSSI Icon | | The terminal has not registered with the network (applicable for TMO only). |
| | | More bars indicate better signal strength. |
| Message Icon | | Unread message(s). |
| | | The Inbox is full. |
| Operation Mode Icon | | The terminal is operating in TMO. |
| | | The terminal is operating in DMO. |
| | | The terminal is operating in fall-back mode. |
| Profile Icons | | Silent |
| | | Normal |
| Accessory Icon | | The audio accessory is connected. |
| GPS Icon | | A GPS module is connected and the valid GPS data is received. |
| | | A GPS module is connected but no valid GPS data is received. |
| Call Icon | | A call is in progress. |
| Record Icon | | Recording is in progress. |
| Group Selection Icon | | The terminal is selecting a talkgroup. |
| Gateway Icon | | A gateway device is available and connected in DMO. |
| | | A gateway device is available but not connected in DMO. |
| Repeater Icon | | A repeater is available and connected in DMO. |

| Name | Icon | Indication |
|------|---|---|
| |  | A repeater is available but not connected in DMO. |

5.2 Operation Icon

| Icon | Indication | Icon | Indication |
|---|---------------|---|--------------|
|  | Function Menu |  | Options Menu |
|  | OK |  | Operate |
|  | View |  | Search |
|  | Back |  | Save |
|  | Restore |  | Stop |
|  | Play |  | Pause |
|  | Delete |  | Cancel |
|  | Answer |  | End |
|  | Send |  | Call Type |
|  | Modify |  | Unlock |
|  | GPS | | |

5.3 LED Indicator

| LED Indication | Terminal Status |
|----------------------|-----------------------|
| Glows red. | Transmitting |
| Glows green. | Receiving |
| Flashes green slowly | Channel free in DMO |
| Glows orange. | Channel busy in DMO . |

6. Menu Navigation

The following menu lists show the full menus of the terminal in TMO and DMO. You can select your needed menus to be displayed via your dealer. To select and confirm the options in the menu, operate as follows: in the home screen, you can press the **OK** key or **Function/P1** key to enter the "Function" menu, or press the **Back** key or **Options/P3** key to enter the "Options" menu; then press the **Up/Down** key on the **Navigation** key to select the needed menu, finally press the **OK** key. In sections introducing operations, a menu path is provided for your convenience, e.g. Message -> Create Msg.

6.1 TMO Menu

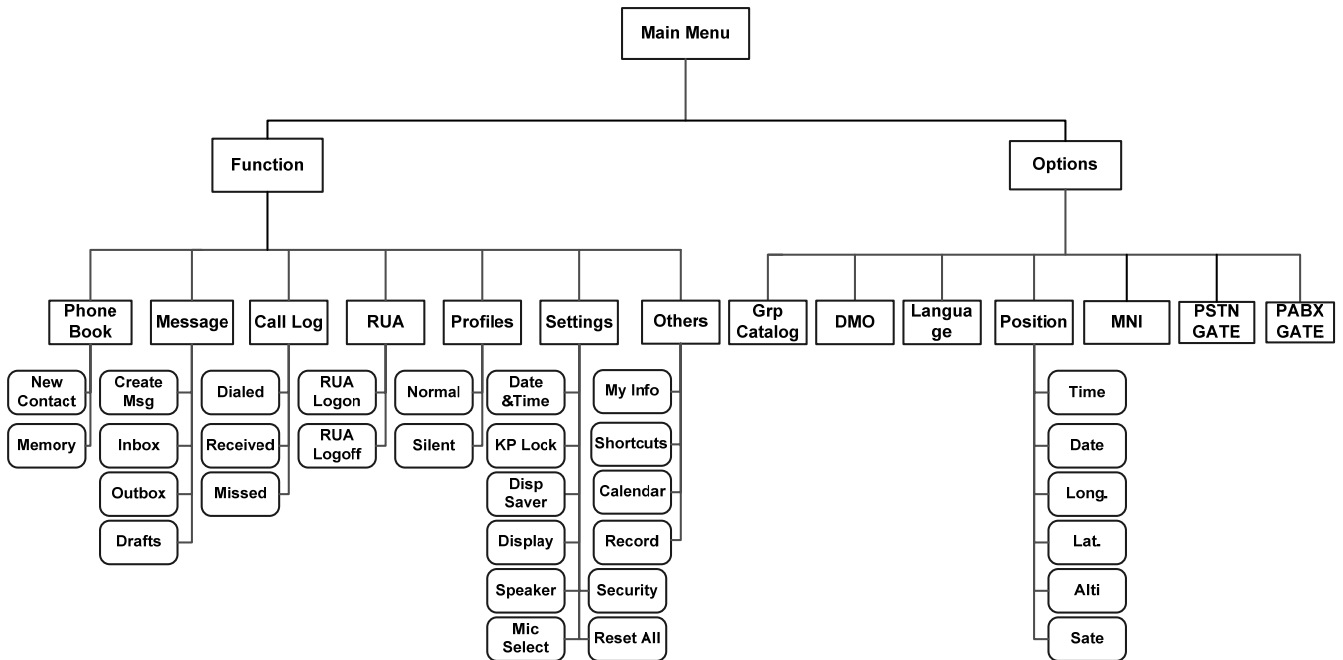

6.2 DMO Menu

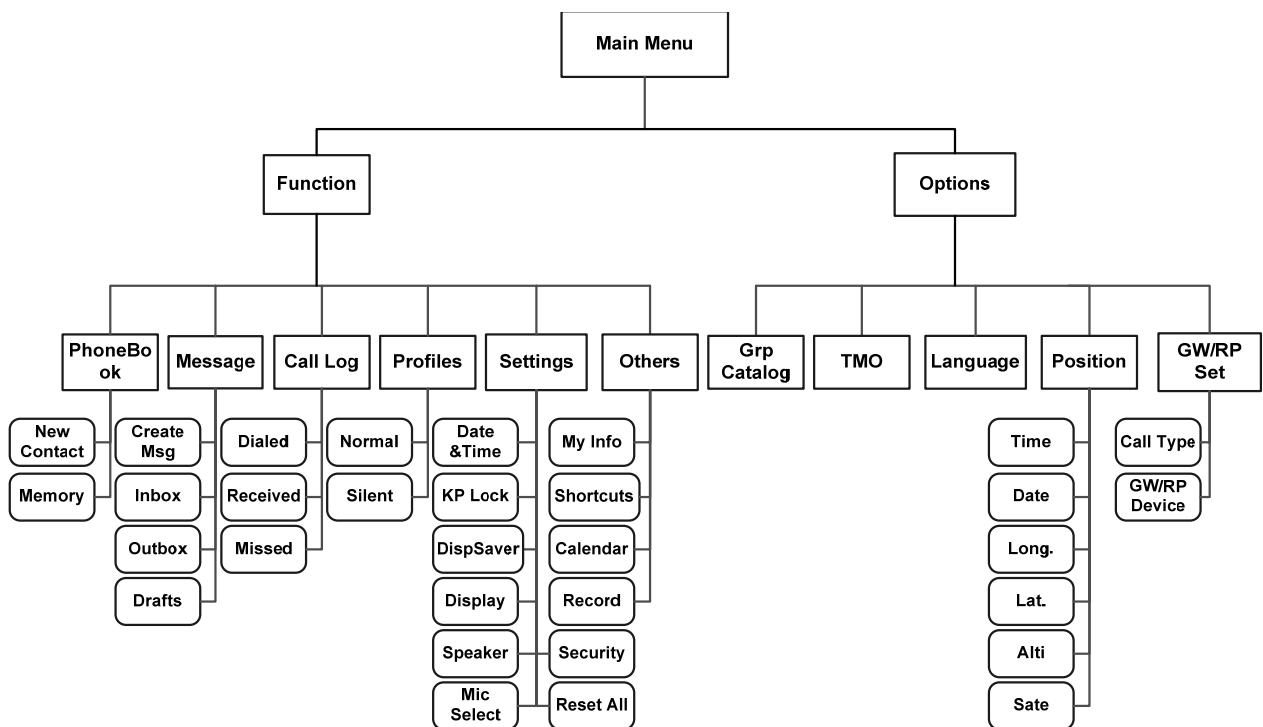

7. Basic Operations

7.1 Turning On/Off

To turn on the terminal, long press the **Power On-Off/End** key. Then the LED indicator will glow red and the power-up greeting appears on the LCD. In TMO, after being turned on, the terminal will logon to the network. In DMO, the terminal will be ready for use after being turned on.

To turn off the terminal, long press the **Power On-Off/End** key until the power-off screen appears.



7.2 Switching Operation Mode

This terminal can operate in either TMO or DMO. To switch the operation mode, press the **Options/P3** key in the home screen to enter the "Options" menu, and then select "TMO" or "DMO".

7.3 Adjusting the Call Volume

Rotate the **Volume Control/Group Selector** knob clockwise to increase the call volume, or counter-clockwise to decrease the volume. After the adjustment, the terminal will save the settings and return to the former screen automatically.

7.4 Inputting through Keypad

You can use the numeric keypad to enter user alias and number, edit messages, etc. The terminal supports these input methods: English and Number. To switch the input method, press the  key on the numeric keypad. In either input method, you can enter special characters and common punctuations by pressing , enter "*" by pressing  and enter a space by long pressing this key. As for other language input methods (depending on your customization), operate accordingly.

7.5 Locking/Unlocking the Keypad

To enable the keypad lock, enter the Function menu by pressing the **Function/P1** key or the **OK** key in the home screen, and then go to "Settings -> KP Lock -> On". After this feature is enabled, keypad will get locked automatically when the preset time (preset by the dealer) expires. To unlock the keypad, you can press the **OK** key and then .

Apart from locking the keypad via menu, you can lock the keypad quickly and temporarily by pressing the **OK** key and then  directly in the home screen.

7.6 PIN Code Security and Changing

PIN code can prevent unidentified users from using your terminal. To enable or disable the PIN Code feature, enter the Function menu from the home screen by pressing the **Function/P1** key or **OK** key, and then go to "Settings -> Security -> PIN Code". Every time you need to change the settings, it is required to input the PIN code first (default PIN code: 1234, preset by the dealer).

With this feature enabled, you will need to enter the correct PIN code prior to operating the terminal after turning it on. If you input the wrong code for continuous 3 times (predefined by the dealer), the terminal will be locked. In this case, you will need to enter the correct PUK code (default PUK code: 12345678) to reset the PIN code. To change the PIN code, go to "Settings -> Security -> ChangePIN" from the home screen, and input the correct current PIN code prior to changing the code.

7.7 Managing the Contacts

7.7.1 Contact List

The contact list saves the information of individual call contacts. To view the list, press the **Function/P1** key or **OK** key to enter the Function menu and then go to the "PhoneBook" menu.

7.7.2 New Contact

To add a new contact, you can enter the Function menu by pressing the **Function/P1** key or **OK** key and go to "PhoneBook". Then press the **OK** key to enter "Options -> New Contact" to add a new contact: enter the contact's alias in the editing screen, and press the **OK** key to enter the "Input No." screen to input the contact number. And, press the **OK** key again to select the call type ("Private No.", "PABX" or "PSTN"). Finally, press **OK** key to confirm.

7.7.3 Viewing the Memory

To view the phonebook memory, you can enter the Function menu by pressing the **Function/P1** key or **OK** key, and go to "PhoneBook" menu; then press **OK** with the screen-icon  to enter "Options -> Memory".

8. Call Services

8.1 TMO

8.1.1 Individual Call



In TMO , an individual call can be initiated either as a half-duplex call or full-duplex call, which can be received without pressing any key (Direct Signaling) or by pressing the **Call** key or **PTT** (Hook Signaling). Contact your dealer for such programming as well as more details.

Initiating an Individual Call

- Via Menu

In the home screen, press **Function/P1** key or **OK** key to enter the “PhoneBook” or “Call Log” submenu, and select a contact. Then press **PTT** to initiate a half-duplex call, or press  to initiate a full-duplex call.

- Via Manual Dial

In the home screen, input the number you want to call through the keypad, and select “Private No.” through the **OK** key with the screen-icon . Then press **PTT** to initiate a half-duplex call, or press  to initiate a full-duplex call.



Note:

- Entry of individual numbers must comply with the SSI&TSI dialing rules. See “SSI&TSI Dialing Rules” in “Appendix” for more details.
- Calls will end automatically if the predefined call timer expires.

Answering an Individual Call

- Half-duplex Individual Call

- If it is an incoming call with Direct Signaling, there will be an alert tone to inform the called party that a call is received..
- If it is an incoming call with Hook Signaling, the terminal sounds alert to inform the called party that there is an incoming call. And to receive the call, the **PTT** key should be pressed .

To take the talk rights during the call, there are two situations: 1) if you have no pre-emptive priority, hold down **PTT** to talk after the talking party stops talking and releases its **PTT**; 2) if you have already been programmed with pre-emptive priority, hold down **PTT** to talk at any time.

- Full-duplex Individual Call

- If it is an incoming call with Direct Signaling, there will be an alert tone to inform the called party that a call is received..
- If it is an incoming call with Hook Signaling, the terminal sounds alert tone to inform the called party that there is an incoming call. And to receive the call, the **PTT** key or  should be pressed.

After the call is established, both parties can talk at any time, with no need to use any key.

Note:

There may be an exception, that is, if your terminal has been programmed to transmit using **PTT** in a full-duplex call, you have to hold down **PTT** to talk. In this case, you may miss voices from the other party when both parties are talking.

Hang up/ Rejecting an Individual Call

When initiating the individual call, press the **Back** key or  to terminate it.

In the presence of an incoming individual call, press the **Back** key or  to reject it.

In the process of an individual call, any party can press  to terminate it.

8.1.2 Group Call

Initiating a Group Call

In the home screen, you can initiate a group call to the default group by pressing **PTT**. To call other groups, please do as follows:

Step 1 In the home screen, press the **Volume Control/Group Selector** knob and the icon  appears on the upper right corner of the screen.

Step 2 Rotate the knob to select a group.

Please perform this step as soon as the icon  appears; otherwise, you may fail to select.

Step 3 Press the knob or **OK** key to confirm your selection.

Step 4 Press **PTT** to initiate a group call to this group.

Answering a Group Call

You can receive a group call without any operation. To take the talk rights during the call, there are two situations: 1) if you have no pre-emptive priority, hold down **PTT** to talk after the talking party stops talking and releases its **PTT**; 2) if you have already been programmed with pre-emptive priority, hold down **PTT** to talk at any time.

Hang up a Group Call

The calling party can press  to exit a group call. And for the called parties in a group call, only those enabled with “Hang Up” feature (programmable by the dealer) can exit a group call.

8.1.3 Telephone Call

The telephone call is a full-duplex individual call with Hook signaling. To initiate the call, follow the steps below.

Initiating a Telephone Call

Step 1 Select a gateway.

In the home screen, press the **Back** key or **Options/P3** key to enter the “PSTN GATE” or “PABX GATE” submenu. Select an appropriate gateway, and press **Function/P1** key or **OK** key to confirm.

Step 2 Input a telephone number.

Return to the home screen by pressing . Input a PABX or PSTN number, which is composed of a prefix (specified by the gateway, please contact the system administrator) and the telephone number of the target contact.

Step 3 Select a call type.

Select “PABX” or “PSTN” through the **OK** key with the screen-icon .

Step 4 Press  to initiate the call.

To answer or hang up/reject the call; see the “Individual Call” in “TMO”.

8.1.4 Emergency Call

Initiating an Emergency Call

Press the **Emergency** key and you can initiate an emergency call to the predefined contact. Any individual contact, group contact, default group, PSTN or PABX contact can be predefined as the emergency contact.

There are two levels for emergency call: emergency priority and pre-emptive priority 3, which can be programmed by your dealer. The emergency priority is endowed with the higher privilege; thus a call with such priority can break any other call with pre-emptive priority 3, as well as calls with lower priorities.

Answering an Emergency Call

The emergency call is always received automatically. During an emergency call, the initiating party can talk with no need to use any key. If another member needs to talk, he/she should hold down **PTT** only after the talking party stops talking and releases its **PTT**.

Hanging up an Emergency Call

See the corresponding part of “Individual call” or “Group call” in accordance with the call type of the

predefined contact.

8.2 DMO

8.2.1 Individual Call

In DMO, an individual call can be initiated only as a half-duplex call.

Initiating an Individual Call

In the home screen, directly input the number you want to call through the keypad, or press **Function/P1** key or **OK** key to enter the "PhoneBook" or "Call Log" submenu, and select a contact. Then press **PTT** to initiate the call.





Note:

Entry of individual numbers must comply with the SSI&TSI dialing rules. See "SSI&TSI Dialing Rules" in "Appendix" for more details.

Answering an Individual Call

You can receive an individual call in DMO automatically. During the call, you can hold down **PTT** to talk after the initiating party stops talking and releases its **PTT**.

Hanging up an Individual Call

The calling party can press  to terminate an individualthe call. And the called party can press  to exit the call.

8.2.2 Group Call

Group calls in DMO is the same as that in TMO. Please refer to operation method described in "**Group Call**" in the above "TMO" section.

8.2.3 Emergency Call

In DMO, emergency calls are endowed with emergency priority only. Please refer to operation method described in "Emergency Call" in the above "TMO" section.

9. Message

9.1 Status Message

Status message, which should be programmed by your dealer only, can facilitate instant messaging of the frequently-used messages. You can only send or view rather than editing the status messages.

When the message is sent successfully, the target terminal will receive either the status ID of the status message (if the message text has not been predefined via CPS) or the predefined text (if the message text has been predefined via CPS).

Sending a Status Message

- Press the **Function/P1** key or **OK** key and navigate to "Message -> Create Msg -> StatusMsg -> Sel Msg". Select a desired status message, and press the **OK** key to proceed. Choose either an individual or a group as the target contact, input the appropriate number and press **OK** to complete.

Long press the programmed **Send StatusMsg** key to send the preset status message directly.

View the Status Message

When the icon  appears in the status bar, it indicates there is/are unread message(s). Do as follows to view it:

- In the prompt screen for an unread message, press the **OK** key to enter the Inbox, and press **OK** key again to read.
- In the home screen, press the **Function/P1** key or **OK** key and navigate to "Message -> Inbox". Then you can view the unread message.

9.2 User Message

9.2.1 TMO

Editing a User Message

Press the **Function/P1** key or **OK** key and navigate to "Message -> Create Msg -> User Msg". Press **OK** again to edit a user message.

Sending a User Message

After editing, press **OK** to confirm. Then select the target contact and decide whether to send it as a flash message.



Note:

If the message is sent as a flash message, the receiving party can preview all the content in a predefined time period without any operation. Once the time period expires, the home screen will get restored, with the icon  displaying on the status bar.

Viewing the User Message

When the icon  appears in the status bar, it indicates there is/are unread message(s). Do as follows to view it:

- In the prompt screen for unread message(s), press the **OK** key to enter the Inbox, and press **OK** again to read.
- In the home screen, press the **Function/P1** key or **OK** key and navigate to "Message -> Inbox -> Inbox". Then you can view the unread message.

9.2.2 DMO

Editing a User Message

Press the **Function/P1** key or **OK** key and navigate to "Message -> Create Msg -> User Msg". Press **OK** key again to edit a user message.

Sending a User Message

After editing, press **OK** to confirm. Then choose either an individual or a group as the target contact, input the appropriate number and press **OK** to complete.

Viewing the User Message

Operate in the same way as that described in "Viewing the User Message" in the above "TMO" section.

10. Troubleshooting

| Phenomenon | Analysis | Solution |
|---|---|--|
| Terminals cannot be powered on. | The power cord is connected improperly. | Connect the power cord correctly. |
| | An abnormal voltage is output from the vehicle battery. | Check the battery strength. |
| | The power cord is damaged. | Replace the power cord with a new one. |
| | The terminal and the remote control head are connected improperly (for mobile terminal (remote mounted)only). | Replace the remote mounting cable with a new one and connect the terminal to the remote control head correctly. |
| Network registration fails or network can not be found. | The terminal is operating in DMO . | Switch to TMO mode. |
| | The terminal is out of the network coverage in TMO. | Check the signal strength. Make sure the terminal is within the network coverage. |
| | The terminal is not granted network access. | Contact the network operator for the terminal authorization. |
| Calls cannot be initiated. | The terminal is out of the network coverage. | Check the signal strength. Make sure the terminal is within the network coverage. |
| | The terminal operates in an improper mode. | Check the operation mode. Make sure the terminal works in the right mode. |
| A group call can not be sent or received. | The terminal is not a member of the target group. | Check whether the terminal is a member of the group. If not, contact your dealer to add the terminal to the group. |

| Phenomenon | Analysis | Solution |
|--|--|---|
| | The terminal is not authorized to access the target group. | Contact the network operator for the terminal authorization. |
| Calls are always interrupted. | The current channel is assigned to emergency calls or other calls with higher priority. | Wait until the channel becomes available and try again. |
| A half-duplex can not be established. | The predefined time period for establishing a call expires. | Make sure the call is established within the predefined time period. |
| | The channel is occupied by another terminal with higher call priority. | Wait until the channel becomes available and try again. |
| | The channel resources are allocated to other services due to overloaded network. | Wait until the channel becomes available and try again. |
| Abnormal disconnection occurs during a call. | The terminal gets out of the network coverage (in TMO). | Check the signal strength. Make sure the terminal is within the network coverage. |
| | The terminal operates at an unfavorable position where communication may be blocked by high buildings or frustrated in the underground areas (in DMO). | Move to an open and flat area, and restart the terminal. |
| As for the same status message ID, the content displayed at the receiving party is different from that of the sending party. | The parties have associated the same status message ID with different contents. | Make sure the status message ID is associated with the same content. |
| The called party cannot hear clearly. | The calling party's palm microphone and the terminal are connected improperly. | Connect the microphone to the terminal correctly. |

| Phenomenon | Analysis | Solution |
|------------|---------------------------------|---|
| | The palm microphone is damaged. | Replace the microphone and connect the new one to the terminal correctly. |

If the above solutions can not fix your problems, or you may have some other queries, please contact us or your local dealer for more technical support.

11. Care and Cleaning

To guarantee optimal performance as well as a long service life of the product, please follow the tips below.

Product Care

- Do not pierce or scrape the product.
- Keep the product far away from substances that can corrode the circuit.
- Do not hold the product by its antenna or earpiece cable directly.
- Attach the accessory jack cover when the product is not in use.

Product Cleaning

 **Caution:** Power off the product and disconnect the power supply before cleaning.

- Clean up the dust and fine particles on the product surface and charging piece with a clean and dry lint-free cloth or a brush regularly.
- Use neutral cleanser and a non-woven fabric to clean the keys, control knobs and front case after long-time use. Do not use chemical preparations such as stain removers, alcohol, sprays or oil preparations, so as to avoid surface case damage.
- Make sure the product is completely dry before use.

12. Appendix

12.1 SSI&TSI Dialing Rules

In the TETRA system, subscribers are distinguished by different identities. Each subscriber is assigned with a unique short subscriber identity (SSI), which serves a part of the TETRA subscriber identity (TSI). And TSI is generally composed in this way: Mobile Country Code (MCC) + Mobile Network Code (MNC) + SSI. To initiate an individual call, please dial the SSI or TSI in compliance with the rules below.

- SSI Dialing

Make sure there are not more than 8 digits.

- TSI Dialing

- MNC+SSI:

- 1) Input the MNC as it is;

- 2) SSI must be 8 digits long. Add 0 before the first digit of SSI which is shorter than 8 digits.

For example, when MNC is 20 and SSI is 504, you need to input 2000000504.

- MCC+MNC+SSI:

- 1) MCC must contain 3 digits. Add 0 before the first digit of MCC which is shorter than 3 digits;

- 2) MNC must contain 4 or 5 digits. When the MNC is shorter than 4 digits, add 0 before its first digit; when it is 5 digits long, use it directly;

- 3) SSI must be 8 digits long. Add 0 before the first digit of SSI which is shorter than 8 digits.

For example, when MCC is 460, MNC is 20 and SSI is 504, you need to input 460002000000504.

12.2 Illustration for Fixing the Mounting Bracket

