

Preface

Thank you for purchasing Hytera DMR Digital Portable Radio. As a product built to the DMR standard, it is endowed with ergonomic design, all-round digital functions and remarkable quality to refresh your experience and enable you to be responsive to emergent situations.

To derive optimum performance from your product, please read this manual and the supplied Safety Information Booklet carefully before use.

This manual is applicable to the following model:

PD502 U(1) Digital Portable Radio

Instructional Icons

The following icons are available through this manual:

Alert Icons



Caution: indicates situations that could cause damage to your product.



Note: indicates tips that can help you make better use of your product.

Function Icons



: indicates functions that are available on digital channel only.



: indicates functions that are available on analog channel only.

Functions marked with no function icons are available on both analog and digital channels.

Term Explanation

Key Operation

Short press: to press a key and release it quickly.

Long press: to press a key and remain holding it down for a predefined period (2 seconds by default).

Hold down: to press a key and remain holding it down.

Private Call

Private Call is a call initiated by a single user to another user.

Group Call

Group Call is a call initiated by a single user to a group.

All Call

All Call is a call initiated by a single user to all the other users on a channel.

Squelch

This technology can remove excessive background noises, improving your communication quality.

Copyright Information

Hytera is the trademark or registered trademark of Hytera Communications Co., Ltd. ("Hytera") in PRC

and/or other countries or areas. Hytera retains the ownership of its trademarks and product names. All other trademarks and/or product names that may be used in this manual are properties of their respective owners.

The Hytera product described in this manual may include Hytera computer programs stored in memory or other media. Laws in PRC and/or other countries or areas protect the exclusive rights of Hytera with respect to its computer programs. The purchase of this product shall not be deemed to grant, either directly or by implication, any rights to the purchaser with respect to Hytera computer programs. Any Hytera computer programs may not be copied, modified, distributed, decompiled, or reverse-engineered in any manner without the prior written consent of Hytera.

The AMBE+2™ voice coding technology embodied in this product is protected by intellectual property rights including patent rights, copyrights and trade secrets of Digital Voice Systems, Inc.

This voice coding technology is licensed solely for use within this product. The user of this technology is explicitly prohibited from attempting to decompile, reverse engineer, or disassemble the Object Code or in any other way convert the Object Code into a human readable form.

U.S. Patent Nos. #6,912,495 B2, #6,199,037 B1, #5,870,405, #5,826,222, #5,754,974, #5,701,390, #5,715,365, #5,649,050, #5,630,011, #5,581,656, #5,517,511, #5,491,772, #5,247,579, #5,226,084 and #5,195,166.

Disclaimer

Hytera endeavors to achieve the accuracy and completeness of this manual, but no warranty of accuracy or reliability is given. All the specifications and designs are subject to change without prior notice due to continuous technology development. No part of this manual may be copied, modified, translated, or distributed in any manner without the express written permission of Hytera.

If you have any suggestions or would like to learn more details, please visit our website at:

<http://www.hytera.cn>.

RF Radiation Information

RF Radiation Profile

Radio Frequency (RF) is a frequency of electromagnetic radiation in the range at which radio signals are

transmitted. RF technology is widely used in communication, medicine, food processing and other fields. It may generate radiation during use.

RF Radiation Safety

In order to ensure user health, experts from relevant industries including science, engineering, medicine and health work with international organizations to develop standards for safe exposure to RF radiation.

These standards consist of:

- United States Federal Communications Commission, Code of Federal Regulations; 47CFR part 2 sub-part J;
- American National Standards Institute (ANSI)/Institute of Electrical and Electronic Engineers (IEEE) C95. 1-1992;
- Institute of Electrical and Electronic Engineers (IEEE) C95. 1 – 1999;
- International Commission on Non-Ionizing Radiation Protection (ICNIRP) 1998;

Operational Instructions and Training Guidelines

To ensure optimal performance and compliance with the occupational/controlled environment RF energy exposure limits in the above standards and guidelines, users should transmit no more than 50% of the time and always adhere to the following procedures:

Your radio radiates measurable RF energy only while it is transmitting (during talking), not when it is receiving (listening) or in standby mode.

FCC Regulations

Federal Communication Commission (FCC) requires that all radio communication products should meet the requirements set forth in the above standards before they can be marketed in the U.S, and the manufacturer shall post a RF label on the product to inform users of operational instructions, so as to enhance their occupational health against exposure to RF energy.

FCC Statement

This equipment has been tested and found to comply with the limits for a Class B digital device, pursuant to part 15 of FCC Rules. These limits are designed to provide reasonable protection against harmful interference in a residential installation. This equipment generates and can radiate radio frequency energy and, if not installed and used in accordance with the instructions, may cause harmful interference to radio communications. However, there is no guarantee that interference will not occur in a particular

installation. If this equipment does cause harmful interference to radio or television reception, which can be determined by turning the equipment off and on, the user is encouraged to try to correct.

The interference by one or more of the following measures:

- Reorient or relocate the receiving antenna. Increase the separation between the equipment and receiver.
- Connect the equipment into an outlet on a circuit different from that to which the receiver is connected.
- Consult the dealer or an experienced radio/TV technician for help

Operation is subject to the following two conditions: 1. This device may not cause harmful interference, and 2. This device must accept any interference received, including interference that may cause undesired operation.

Note:” Changes or modifications to this unit not expressly approved by the party responsible for compliance could void the user’s authority to operate the equipment.”

Compliance with RF Exposure Standards

Hytera’s 2-way radio complies with the following RF energy exposure standards and guidelines:

- United States Federal Communications Commission, Code of Federal Regulations; 47 CFR §§ 1.1307, 1.1310 and 2.1093
- American National Standards Institute (ANSI) / Institute of Electrical and Electronic Engineers (IEEE) C95. 1-1992
- Institute of Electrical and Electronic Engineers (IEEE) C95.1-1999 Edition

RF Exposure Compliance and Control Guidelines and Operating

Instructions

To control your exposure and ensure compliance with the occupational/controlled environment exposure limits always adhere to the following procedures.

Guidelines:

- Do not remove the RF Exposure Label from the device.
- User awareness instructions should accompany device when transferred to other users.
- Do not use this device if the operational requirements described herein are not met.

Operating Instructions:

- Transmit no more than the rated duty factor of 50% of the time. To transmit (talk), push the Push-To-Talk (PTT) button. To receive calls, release the PTT button. Transmitting 50 % of the time, or less, is important because this radio generates measurable RF energy exposure only when transmitting (in terms of measuring for standards compliance).
- Hold the radio in a vertical position in front of face with the microphone (and the other parts of the radio, including the antenna) at least one inch (2.5 cm) away from the nose. Keeping the radio at the proper distance is important because RF exposures decrease with distance from the antenna. Antenna should

be kept away from eyes.

- When worn on the body, always place the radio in a Hytera's approved clip, holder, holster, case, or body harness for this product. Using approved body-worn accessories is important because the use of Hytera's or other manufacturer's non-approved accessories may result in exposure levels, which exceed the FCC's occupational/controlled environment RF exposure limits.
- If you are not using a body-worn accessory and are not using the radio in the intended use position in front of the face, then ensure the antenna and the radio are kept at least 2.5 cm (one inch) from the body when transmitting. Keeping the radio at the proper distance is important because RF exposures decrease with increasing distance from the antenna.
- Use only manufacturer's name approved supplied or replacement antennas, batteries, and accessories. Use of non-manufacturer-name approved antennas, batteries, and accessories may exceed the FCC RF exposure guidelines.
- For a list of Hytera's approved accessories (see the user manual), or (visit the following website which lists approved accessories: [http: add website address](http://add website address)), or (The manufacturer should include the appropriate bracketed item{s) in the manual.)
- For a list of Hytera's approved accessories (see the user manual), or (visit the following website which lists approved accessories: www.hytera.cn)

IC statement

This device complies with Industry Canada licence-exempt RSS standard(s). Operation is subject to the following two conditions:

- (1) This device may not cause interference, and
- (2) This device must accept any interference, including interference that may cause undesired operation of the Device.

The device has been tested and compliance with SAR limits, users can obtain Canadian information on RF exposure and compliance

Le présent appareil est conforme aux CNR d'Industrie Canada applicables aux appareils radio exempts de licence. L'exploitation est autorisée aux deux conditions suivantes :

- (1) l'appareil n' doit pas produire de brouillage, et
- (2) l'utilisateur de l'appareil doit accepter tout brouillage radioélectrique subi, même si le brouillage est susceptible d'en compromettre le fonctionnement.









Après examen de ce matériel aux conformité aux limites DAS et/ou aux limites d'intensité de champ RF, les utilisateurs peuvent sur l'exposition aux radiofréquences et la conformité and compliance d'acquérir les informations correspondantes

EU Regulatory Conformance

As certified by the qualified laboratory, the product is in compliance with the essential requirements and other relevant provisions of the Directive 1999/5/EC. Please note that the above information is applicable to EU countries only.



Contents

Checking Items in the Package	8
Product Overview	9
Product Controls	9
Programmable Keys.....	10
Before Use.....	11
Charging the Battery	11
Assembling the Accessories.....	12
Status Indication	15
LED Indicator	15
Basic Operations	16
Turning the Radio On/Off.....	16
Adjusting the Volume.....	16
Selecting a Zone.....	16
Selecting a Channel.....	16
Switching the Channel Mode.....	16
Call.....	17
Private Call 	17
Group Call 	17
All Call 	17
Calls on Analog Channels.....	18
Functions and Operations.....	19
Adjust Power Level.....	19
Scan.....	19
Talk Around	20
Monitor 	20
Squelch Off 	20
Adjust Squelch Level 	20
Battery Power Indicator.....	21
Scrambler  /Encrypt 	21
Busy Channel Lockout.....	21
Time-out Timer (TOT).....	22
Pseudo Trunking 	22

MIC AGC.....	22
Radio Registration Service 	22
Troubleshooting.....	23
Care and Cleaning.....	25
Optional Accessories.....	26

Checking Items in the Package

Please unpack carefully and check that all items listed below are received. If any item is missing or damaged, please contact your dealer.



Battery

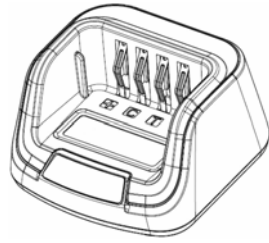

Charger



Power Adapter

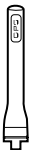

Antenna

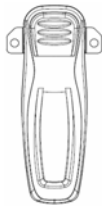

Belt Clip



Strap

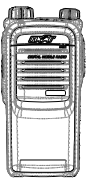

Radio Unit

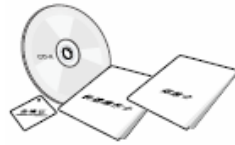

CD

Owner's Manual/ Safety Information Booklet/ [Quick Reference Guide](#)



Note: The antenna may vary with different frequency bands. And the frequency band is marked on the label of antenna; if not, please refer to the label on the radio unit for frequency band information.

Product Overview



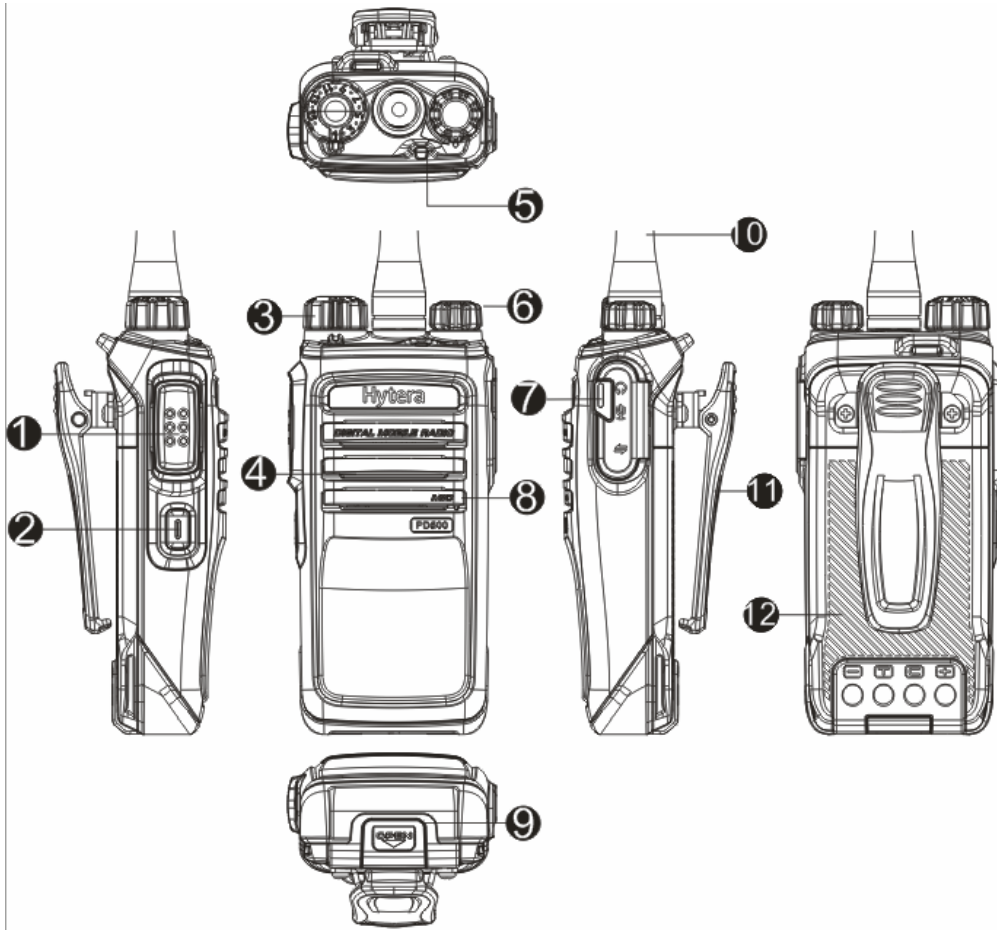





PD502 U(1) Product Controls



NO.	PART NAME	NO.	PART NAME
①	PTT KEY	⑦	Accessory Jack
②	SK1(Side KEY)	⑧	Microphone
③	Channel Selector Knob	⑨	Battery Latch
④	Speaker	⑩	Antenna
⑤	LED Indicator	⑪	Belt Clip
⑥	Radio On-Off/ Volume Control Knob	⑫	Battery

Programmable Keys

For enhanced convenience, you may request your dealer to program the keys **SK1** as shortcuts to the functions listed below:

No.	Shortcut Keys	Description
1	Zone Up	To select a desired zone quickly
2	Zone Down	
3	Adjust Power Level	To adjust power level quickly
4	Talk Around	To directly communicate with other radios
5	Monitor 	To adjust the condition for incoming signal match
6	Monitor Momentary 	
7	Squelch Off 	To always unmute speaker no matter whether carrier is present or not
8	Squelch Off Momentary 	
9	Scan	To receive signals on other channels
10	Nuisance Temporary Delete	To temporarily ignore unwanted channel activity
11	Adjust Squelch Level 	To temporarily adjust the squelch threshold required for the radio to unmute
12	Battery Power Indicator	To indicate the battery strength
13	Scrambler  /Encrypt 	To encrypt your voice so as to guarantee privacy of your communication
14	Smart Call 1-5 	To send voice-free signaling (dedicated for 5-Tone)



Note:

- (1) Long and short press of a key can be assigned with different functions by your dealer.
- (2) The **SK1** is programmed as the **Battery Power Indicator** key by default, and is programmable by your dealer.

Before Use

Charging the Battery

Use only the charger and battery specified by Hytera. Charger LED can indicate the charging process.

Charge Diagram

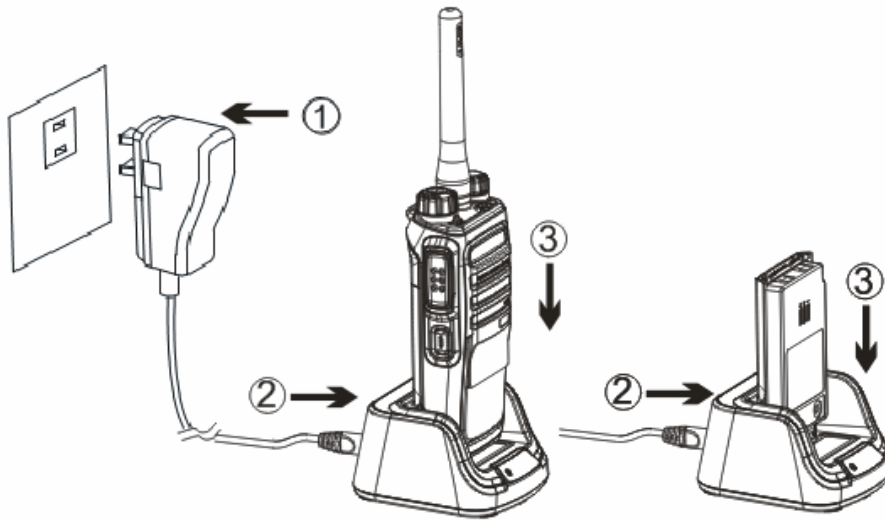

Procedures

1. Connect the power adapter to AC source. See arrow ①.
2. Plug the power adapter into the rear socket of the charger. See arrow ②.
3. Place the radio with the battery attached, or the battery alone, into the charger.
4. The charging process initiates when LED glows red, and is completed when LED glows green.



Note: To achieve optimal battery performance, please charge the battery for 5 hours before initial use.

Charge Indicator

LED Indicator	Charge Status
Red LED flashes slowly.	Standby (no load)
Red LED glows.	Charging
Orange LED glows.	90% charged
Green LED glows.	Fully charged
Red LED flashes rapidly.	Failure



Caution: Be sure to read the Safety Information Booklet, to get necessary safety information.

Assembling the Accessories

Attaching the Antenna

Turn the antenna clockwise to fasten it.

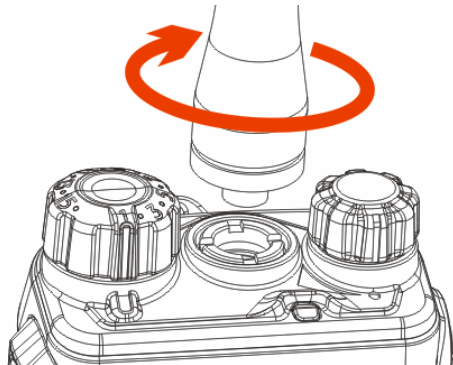

To remove the antenna, rotate it counter-clockwise.

Attaching the Battery

1. Insert the battery into top of the radio. See arrow ①.
2. Slightly press the bottom of the battery until a click is heard. See arrow ②.

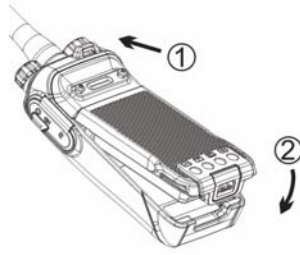

To remove the battery, turn off the radio first. Then slide the battery latch upwards to unlock the battery.

Attaching the Audio Accessory/Programming Cable

1. Open the accessory jack cover as the arrow shown.

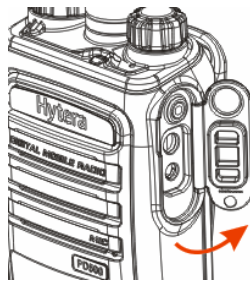

2. Align the plug with the accessory jack.

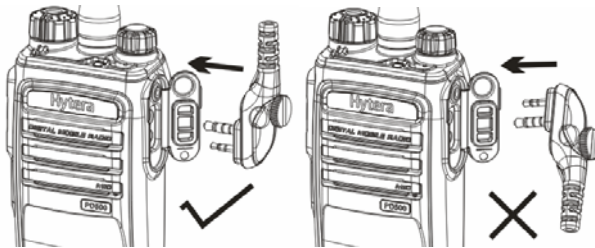

3. Tighten the screw on the plug.

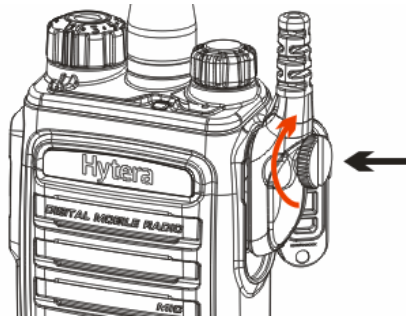

To remove accessories, loosen the screw.



Caution: When you are using an external accessory, waterproof performance of the radio may get affected.

Status Indication

LED Indicator

The top LED indicator will help you easily identify the current radio status.

LED Indicator	Radio Status
LED flashes green.	Powering on
LED flashes red	Powering off
LED glows red.	Transmitting
LED glows green.	Receiving
LED flashes green slowly.	Scanning
LED glows orange.	Call ended (within the preset time period)

Basic Operations

Turning the Radio On/Off

PD502 U(1): Rotate the **Radio On-Off/Volume Control** knob clockwise/counter-clockwise until a click is heard to turn the radio on/off.

Adjusting the Volume

PD502 U(1): After turning the radio on, rotate the **Radio On-Off/Volume Control** knob clockwise to increase the call volume, or counter-clockwise to decrease it.

Selecting a Zone

A zone is a group of channels exhibiting the same property, and is programmed by your dealer. The radio supports 3 zones: Zone 1, Zone 2 and Zone 3. Each zone contains 16 channels at most.

You may quickly toggle to your desired zone by pressing the programmed **Zone Up** or **Zone Down** key. In the process, you will hear one alert tone for Zone 1, two alert tones for Zone 2 and three alert tones for Zone 3.

Selecting a Channel

After turning the radio on, rotate the **Channel Selector** knob to select a desired channel.

Switching the Channel Mode

Each channel can be programmed as either analog channel or digital channel. If the current zone includes both analog and digital channels, you may quickly switch between digital and analog through the **Channel Selector** knob.

Call

To ensure optimal volume of the receiving radio, hold the radio approximately 2.5 to 5 centimeters away from your mouth.

Private Call

Transmitting a Private Call

In standby mode, hold down the **PTT** key to transmit a Private Call to the Private Call contact preset for the current channel.



Note: Your dealer may preset a contact for each digital channel. The preset contact could be a Private Call contact, a Group Call contact or an All Call contact.

Receiving and Responding to a Private Call

When a Private Call is received, you can listen to it without any operation, and you may hold down the **PTT** key within the preset time period to call back.

Group Call

Transmitting a Group Call

In standby mode, hold down the **PTT** key to transmit a Group Call to the Group Call contact preset for the current channel.

Receiving and Responding to a Group Call

When a Group Call is received, you can listen to it without any operation, and you may hold down the **PTT** key within the preset time period to call back.

All Call

Transmitting an All Call

In standby mode, hold down the **PTT** key to transmit an All Call to the All Call contact preset for the current channel.



Note: You can transmit an All Call only when it is enabled by your dealer.

Receiving an All Call

When an All Call is received, you can listen to it without any operation.



Note: You cannot respond to an All Call.

Calls on Analog Channels



To transmit on an analog channel, hold down the **PTT** and speak into the microphone. To receive, release the **PTT** key.

Functions and Operations

Adjust Power Level

With this feature, you may switch power levels quickly. Generally, we recommend you to adopt low power for battery saving. However, if you cannot communicate with radios located at a distant place with low power, please select high power.

Operation:

Press the programmed **Adjust Power Level** key to switch between high power and low power (from low power to high power: a high-pitched tone sounds; from high power to low power: a low-pitched tone sounds).

Scan

This feature allows you to listen to communication activities on other channels so that you can keep a close track of your team members.

Operation:

1. To enable the feature, press the programmed **Scan** key in standby mode (a high-pitched tone sounds); or
Switch to a channel on which the feature “Auto Scan” is enabled via the programming software.
2. After the feature is enabled, your radio will scan according to the scan list set for the channel on which scanning starts. The scanning process is as follows:
 - During scanning, the LED flashes orange.
 - When activities are detected on a channel, the radio will stay on the channel to receive current activities, and the LED glows green.
 - If you don't want to hear activities on the channel, press the programmed **Nuisance Temporary Delete** key to remove the channel from the scan list temporarily.
 - If you want to continue staying on the channel, press the programmed **Monitor** or **Squelch Off** key during scan stay. 
3. To exit the scanning process, press the programmed **Scan** key again (a low-pitched tone sounds).

Talk Around

This feature allows you to continue communication even when the repeater malfunctions, or when your radio is out of the repeater's range but within the coverage range of other radios.

Operation:

Press the programmed **Talk Around** key to enable the feature (a high-pitched tone sounds). To disable the feature, press this key again (a low-pitched tone sounds).

Monitor

To adjust match conditions for signal receiving, you can enable the feature "Monitor".

Operation:

- ✧ Press the programmed **Monitor** key to enable the feature (a high-pitched tone sounds). To disable the feature, press this key again (a low-pitched tone sounds).
- ✧ Hold down the programmed **Monitor Momentary** key to enable the feature (a high-pitched tone sounds). To disable the feature, release this key (a low-pitched tone sounds).

Squelch Off

If the feature "Squelch Off" is enabled, the speaker will keep unmuted no matter whether carrier is present.

Operation:

- ✧ Press the programmed **Squelch Off** key to enable the feature, and the radio sounds background noise (a high-pitched tone sounds). To disable the feature, press this key again (a low-pitched tone sounds).
- ✧ Hold down the programmed **Squelch Off Momentary** key to enable the feature, and the radio sounds background noise (a high-pitched tone sounds). To disable the feature, release this key (a low-pitched tone sounds).

Adjust Squelch Level

This feature allows you to adjust the squelch threshold required for the radio to unmute.

Generally, "Tight" is used in high noise environment. It requires stronger signal for the radio to unmute.

If the squelch level is set to Open, the speaker will keep unmuted irrespective of the satisfaction of decoding conditions.

Operation:

Press the programmed **Adjust Squelch Level** key to switch among Tight, Open and Normal (from Tight to Open, a low-pitched tone and background sound are heard; from Open to Normal, a high-pitched tone is heard and the background sound disappears; from Normal to Tight, a high-pitched tone is heard).

Battery Power Indicator

This feature allows you to know the current battery strength.

Operation:

Hold down the programmed **Battery Strength Indicator** key, and the radio will give a specific indication to represent the current battery strength. Release the key to exit.

Indication	Battery Strength
Green LED glows.	High
Orange LED glows.	Medium
Red LED glows.	Low
Red LED glows and the low battery alert sounds.	Insufficient

Scrambler /Encrypt

The Scrambler/Encrypt feature can encrypt your audio signals to prevent eavesdropping. Thus privacy of your communication is guaranteed.

Operation:

- Press the programmed **Scrambler/Encrypt** key to enable Scrambler or Encrypt on the current channel (a high-pitched tone sounds); press the key again to disable the feature (a low-pitched tone sounds).
- If the Scrambler/Encrypt feature is enabled for a channel via the programming software, switch to the channel to enable the feature, or exit the channel to disable the feature.

Busy Channel Lockout

If enabled via the programming software, this feature can prevent your radio interfering with other transmitting radios on the same channel. If you hold down the **PTT** key while the channel is in use, your radio will keep beeping, alerting you to transmission prohibition. To stop beeping, please release the **PTT**

key. When the channel is free, you can press and hold down the **PTT** key to transmit.

Time-out Timer (TOT)

The purpose of TOT is to prevent any user from occupying a channel for an extended period. If the preset time expires, the radio will automatically terminate transmission and keep beeping. To stop beeping, please release the **PTT** key. You must wait for a certain time period (preset by your dealer) to initiate another transmission.

If the pre-alert function is set by your dealer, your radio will alert you to the TOT expiration in advance.

Pseudo Trunking

This feature can be enabled via the programming software. If your radio operates on a channel with this feature enabled and one time slot is already occupied, it can transmit and receive on the other free time slot, allowing you to communicate timely under emergent situations.

MIC AGC

If enabled via the programming software, your radio will process the audio signals during transmission, providing improved audio for the receiving radio.

Radio Registration Service

If enabled via the programming software, your radio will automatically register in the system within a certain period after power-on. Then it can acquire online information of other radios via accessing specific servers within the valid registration period.

Troubleshooting

Phenomena	Analysis	Solution
The radio can not be powered on.	The battery may be improperly installed.	Remove the battery and attach it again.
	The battery may run out.	Recharge or replace the battery.
	The battery may suffer from poor contact caused by dirtied or damaged battery contacts.	Clean the battery contacts. If the problem can not be solved, contact your dealer or authorized service center for inspection and repair.
During receiving signals, the voice is weak, discontinuous or totally inactive.	The battery strength may be too low.	Recharge or replace the battery.
	The volume may be set to a low level.	Increase the volume.
	The antenna may get loose or may be improperly installed.	Power off the radio, and re-install the antenna.
	The speaker may be blocked or damaged.	Clean surface of the speaker. If the problem can not be solved, contact your dealer or authorized service center for inspection and repair.
You can not communicate with other members.	The frequency or signaling may be inconsistent with that of other members.	Set your TX/RX frequency and signaling to the same as that of other members.
	The channel type (digital/analog) may be set inconsistently.	Make sure all members are on the same digital/analog channel.
	You may be too far away from the group members.	Move towards other members.

Irrelevant communication or noise is heard on the channel.	You may be interrupted by radios using the same frequency.	Change the frequency, or adjust the squelch level.
	The radio may be set with no signaling.	Set signaling for all member radios to avoid interference at the same frequency.
The noise is too loud.	You may be too far away from other members.	Move towards other members.
	You may be at an unfavorable position. For example, your communication may be blocked by high buildings or frustrated in the underground areas.	Move to an open and flat area, and restart the radio.
	You may suffer from external disturbance (such as electromagnetic interference).	Stay away from equipment that may cause interference.

If the above solutions can not fix your problems, or you may have some other queries, please contact us or your local dealer for more technical support.

Care and Cleaning

To guarantee optimal performance as well as a long service life of the product, please follow the tips below.

Product Care

- Do not pierce or scrape the product with any edged instruments or hard objects.
- Keep the product far away from substances that can corrode the circuit.
- Do not hold the product by its antenna or earpiece cable directly.
- Attach the accessory jack cover when the product is not in use.

Product Cleaning

















- Clean up the dust and fine particles on the product surface and charging piece with a clean and dry lint-free cloth or a brush regularly.
- Use neutral cleanser and a non-woven fabric to clean the keys, control knobs and front case long-time use. Do not use chemical preparations such as stain removers, alcohol, sprays or oil preparations, so as to avoid surface case damage. Make sure the product is completely dry before use.



Caution: Power off and remove the battery before cleaning.

Optional Accessories

The following items are the main optional accessories for the product, and please consult your local dealer for more other accessories.

			
Remote Swivel Earset EHM20	Remote C-Earset EHM19	PTT&MIC cable(for use with Receive-Only Earpiece) ACM-01	Earbud with remote on-mic PTT ESM14
			
Earpiece with Transparent Acoustic Tube EAM17	Receive-Only Earbud ES-01	Receive-Only Earpiece with Transparent Acoustic Tube ES-02	Receive-Only C Style Earloop EH-01
			
Receive-Only Adjustable Earhook with Swivel Speaker EH-02	Earbud with on-mic PTT EAM12	Earset with in-line PTT EHM18	Earbud with on-mic PTT ESM12
			
D-Earset with in-line PTT EHM15	2-wire Surveillance Earpiece with Transparent Acoustic Tube (black) EAM13	3-wire Surveillance Earpiece with Transparent Acoustic Tube (beige) EAM15	Remote speaker microphone SM08M3

			
MCU Multi-unit Rapid-rate Charger (for Li-Ion/Ni-MH batteries) MCA08	Battery Analyzer MCA05	PS7501 AC/DC Adapter	Remote speaker microphor (IP55) SM13M1



Caution: Use the accessories specified by Hytera only. If not, Hytera shall not be liable for any losses or damages arising out of use of unauthorized accessories.